



2024

LX600

OWNER'S MANUAL QUICK GUIDE

Contents

The Quick Guide is not intended as a substitute for your *OWNER'S MANUAL*. We strongly encourage you to review the *OWNER'S MANUAL* and supplementary manuals so you will have a better understanding of your vehicle's capabilities and limitations.

Pictorial Index	3
For safe use	
Floor Mat Installation.....	14
Entering and Exiting	
Keys.....	15
Smart Access System with Push-button Start.....	17
When Driving	
Engine (Ignition) Switch.....	18
Automatic Transmission.....	21
Turn Signal Lever.....	24
Parking Brake.....	25
Brake Hold.....	27
Multi-information Display.....	28
Head-up Display.....	31
Headlight Switch.....	34
AHB (Automatic High Beam).....	35
Fog Light Switch.....	37
Windshield Wipers and Washer.....	38
Rear Window Wiper and Washer.....	39
Driving Mode Select Switch.....	40
AHC (Active Height Control Suspension).....	43
Four-wheel Drive System.....	45
Crawl Control (with Turn Assist function).....	46
Multi-terrain Select.....	48
Multi-terrain Monitor.....	50

Driving Comfort

Basic Operation of Multimedia System	51
Navigation *	52
Connecting a Smartphone or Communication Device *	56
Basic Operation of Audio System *	61
Lexus Climate Concierge	66
Front Automatic Air Conditioning System *	67
Rear Air Conditioning System *	70

Interior features

Starting Voice Control *	73
Connecting to the USB Port	77
Garage Door Opener	78

Safety Connect

Safety Connect	84
Remote Connect	86
Service Connect	87

Opening and Closing

Door Locks	88
Power Windows	89
Moon Roof	90
Fuel Tank Cap	91
Back Door	92

What to do if...

List of Warning/Indicator Lights	95
If the electronic key does not operate properly	99
If the engine will not start	101

*: These features may be operated by Starting Voice Control (See P.73)

Depending on specifications, the vehicle shown in the illustration may differ from your vehicle in terms of equipment.

Pictorial Index

Instrument panel

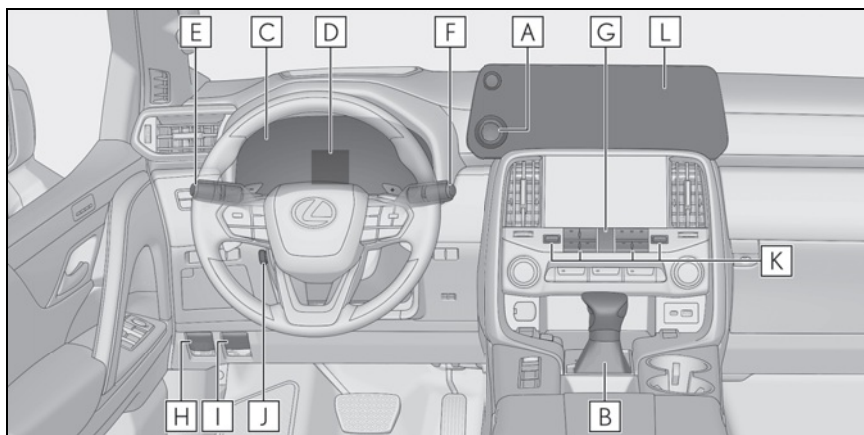

- A Engine switch**..... P.18
 - Starting the engine/changing the modes.....P.18, 19
 - Emergency stop of the engine P.20
 - When the engine will not start P.100
 - Warning messages*

- B Shift lever** P.21
 - Changing the shift position..... P.21
 - Precautions against towing*
 - When the shift lever does not move*

- C Meters***
 - Reading the meters/adjusting the instrument cluster light*
 - Warning lights/indicator lights P.95
 - When the warning lights come on*

- D Multi-information display** P.28
 - Display..... P.28
 - When the warning messages are displayed*

E	Turn signal lever	P.24
	Headlight switch	P.34
	Headlights/parking lights/tail lights/daytime running lights	P.34
	AHB (Automatic High Beam)	P.35
	Fog lights.....	P.37
F	Windshield wiper and washer switch	P.38
	Rear window wiper and washer switch	P.39
	Usage	P.38, 39
	Adding washer fluid*	
	Headlight cleaners *	
	Warning messages *	
G	Emergency flasher switch *	
H	Fuel filler door opener	P.91
I	Hood lock release lever *	
J	Tilt and telescopic steering control switch *	
	Adjustment *	
	Driving position memory *	
K	Air conditioning system	P.67
	Usage	P.67
	Rear window defogger	P.67
L	Audio system	P.61

*: Refer to "OWNER'S MANUAL".

■ Switches

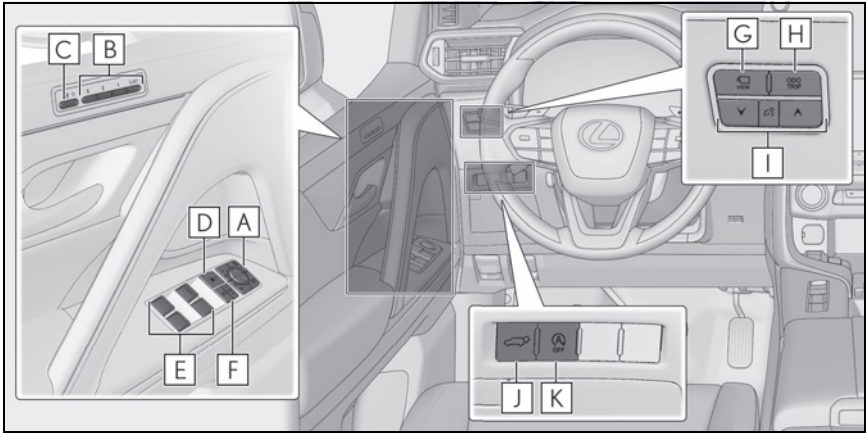

- A** Outside rear view mirror switches *1
- B** Driving position memory buttons *1
- C** Mode change button *1,2
- D** Window lock switch *1
- E** Power window switches P.89
- F** Door lock switches P.88
- G** VIEW switch *1
- H** “ODO TRIP” switch *1
- I** Instrument panel light control switches *1
- J** Power back door switch P.92
- K** Stop & Start cancel switch *1

*1: Refer to “OWNER’S MANUAL”.

*2: If equipped

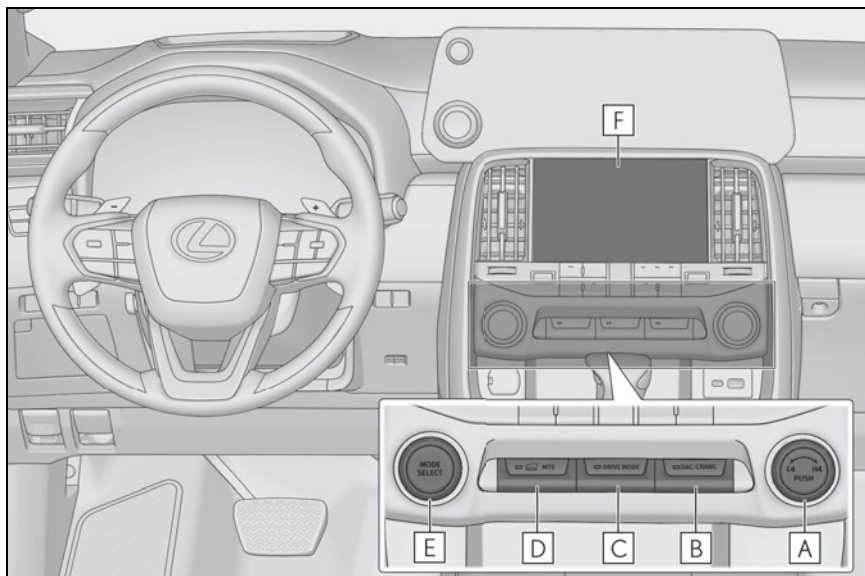

- A** Four-wheel drive control switch P.45
- B** DAC/CRAWL switch..... P.46
- C** DRIVE MODE switch..... P.40
- D** MTS switch P.48
- E** MODE SELECT switch..... P.40, 46, 48
- F** Front Multi Operation Panel*

*: Refer to "OWNER'S MANUAL".

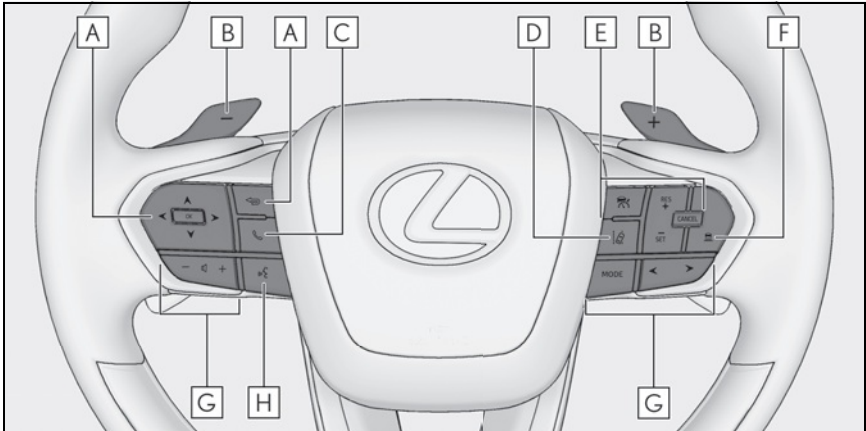

- A** Meter control switches P.30
- B** Paddle shift switches P.22, 23
- C** Telephone switch..... P.58
- D** LTA (Lane Tracing Assist) switch *
- E** Cruise control switches
 Dynamic radar cruise control with full-speed range*
- F** Vehicle-to-vehicle distance switch*
- G** Audio remote control switches..... P.61
- H** Talk switch P.58

*: Refer to "OWNER'S MANUAL".

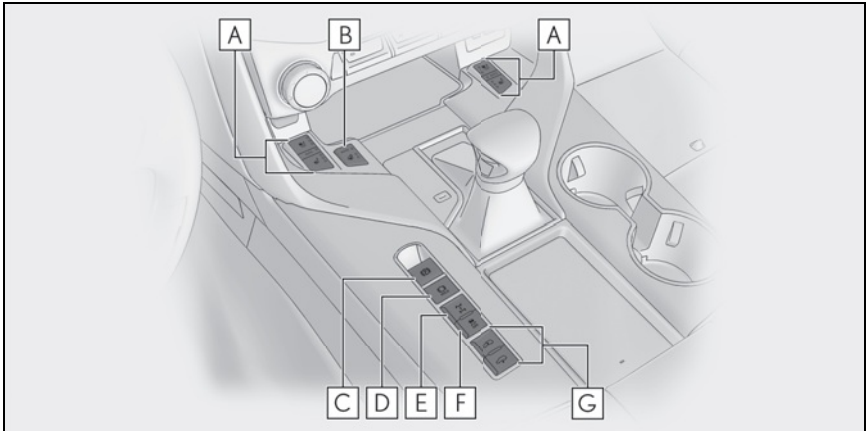

- A** Front seat heater switches ^{*1}
 Front seat ventilator switches ^{*1,2}
- B** Heated steering wheel switch ^{*1,2}
- C** Parking brake switch P.25
 Applying/releasing.....P.25
 Precautions against winter season ^{*1}
 Warning buzzer/message ^{*1}
- D** Brake hold switch P.27
- E** Center differential lock switch..... P.45
- F** VSC OFF switch ^{*1}
- G** Height select switches ^{*1,2}

^{*1}: Refer to "OWNER'S MANUAL".

^{*2}: If equipped

■ Interior

► 4-passenger models

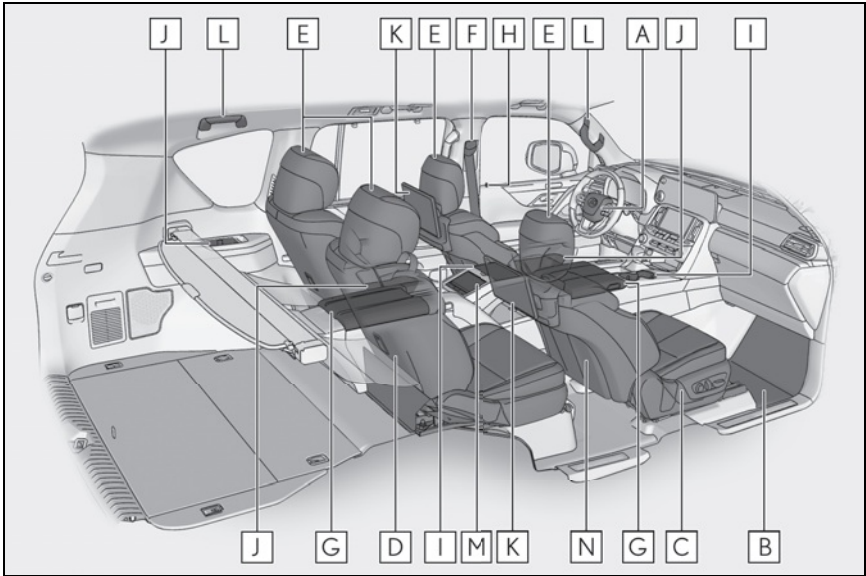

- A** SRS airbags *1
- B** Floor mats P.14
- C** Front seats *1
- D** Rear seats *1
- E** Head restraints *1
- F** Seat belts *1
- G** Console box *1,2
Cool box *1,2
- H** Inside lock buttons P.88
- I** Cup holders *1

J Bottle holders*¹

K Rear seat entertainment system*³

L Assist grips*¹

M Rear Multi Operation Panel*^{1,3}

N Ottoman*¹

*¹: Refer to "OWNER'S MANUAL".

*²: If equipped

*³: Refer to "MULTIMEDIA OWNER'S MANUAL".

► 5-passenger models

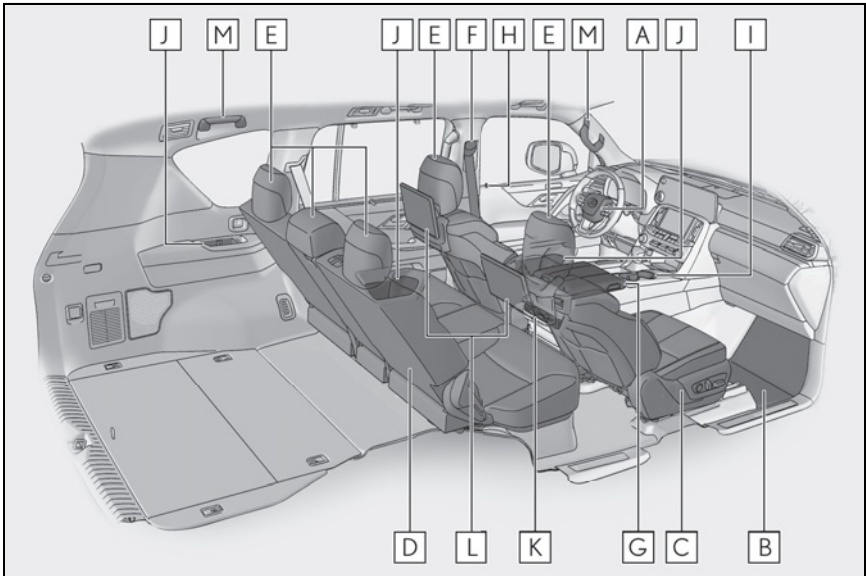

- A** SRS airbags*¹
- B** Floor mats P.14
- C** Front seats*¹
- D** Rear seats*¹
- E** Head restraints*¹
- F** Seat belts*¹
- G** Console box*^{1,2}
Cool box*^{1,2}
- H** Inside lock buttons P.88
- I** Cup holders*¹
- J** Bottle holders*¹
- K** Rear air conditioning system P.70
- L** Rear seat entertainment system*^{2,3}
- M** Assist grips*¹

*¹: Refer to "OWNER'S MANUAL".

*²: If equipped

*³: Refer to "MULTIMEDIA OWNER'S MANUAL".

► 7-passenger models

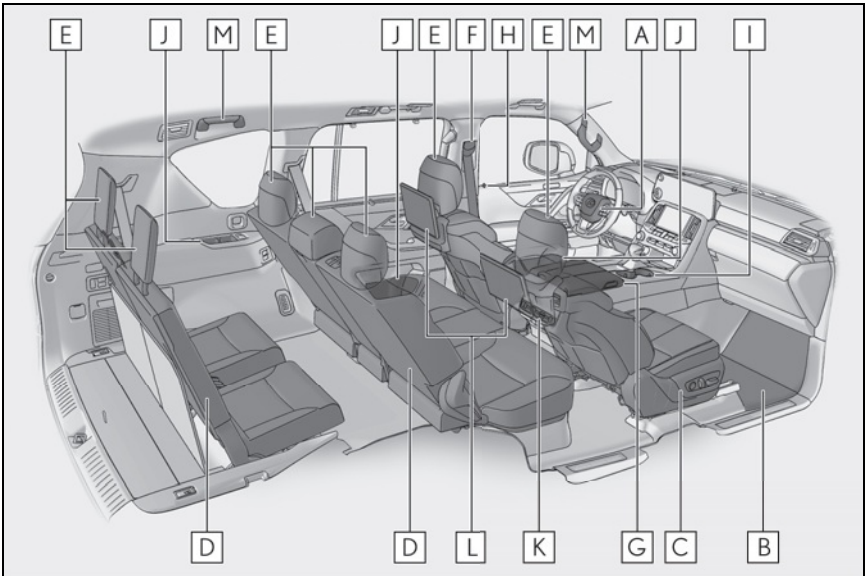

- A** SRS airbags*¹
- B** Floor mats P.14
- C** Front seats*¹
- D** Rear seats*¹
- E** Head restraints*¹
- F** Seat belts*¹
- G** Console box*^{1,2}
Cool box*^{1,2}
- H** Inside lock buttons..... P.88
- I** Cup holders*¹
- J** Bottle holders*¹
- K** Rear air conditioning system P.70
- L** Rear seat entertainment system*^{2,3}
- M** Assist grips*¹

*¹: Refer to "OWNER'S MANUAL".

*²: If equipped

*³: Refer to "MULTIMEDIA OWNER'S MANUAL".

■ Ceiling

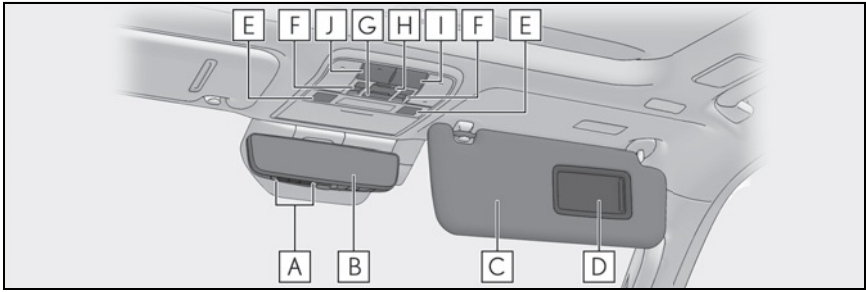

- A** Garage door opener buttons ^{*1} P.78
- B** Inside rear view mirror ^{*1,2}
Digital Rear-view Mirror ^{*1,2}
- C** Sun visors ^{*1}
- D** Vanity mirrors ^{*1}
- E** Interior lights ^{*1}
Personal lights ^{*1,3}
- F** Moon roof switches P.90
- G** Intrusion sensor and tilt sensor cancel switch ^{*1}
- H** "SOS" button ^{*2} P.84
- I** Interior light switch ^{*1}
- J** Door-linked interior light switch ^{*1}

*1: Refer to "OWNER'S MANUAL".

*2: If equipped

*3: The illustration shows the front, but they are also equipped in the rear.

Floor Mat Installation

Use only floor mats designed specifically for vehicles of the same model and model year as your vehicle. Fix them securely in place onto the carpet.

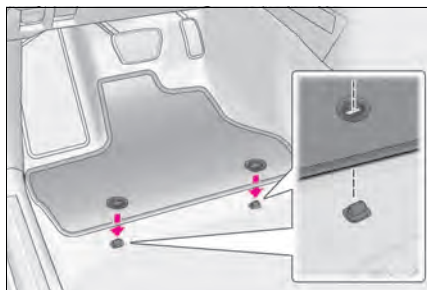

- 1 Insert the retaining hooks (clips) into the floor mat eyelets.

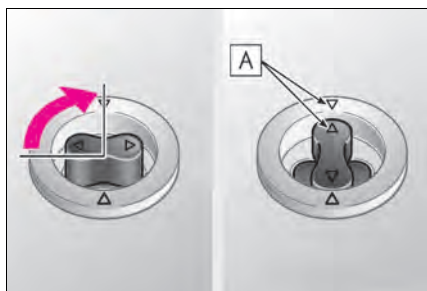

- 2 Turn the upper knob of each retaining hook (clip) to secure the floor mats in place.

Always align the \triangle marks **A**.

The shape of the retaining hooks (clips) may differ from that shown in the illustration.

Keys

Electronic key

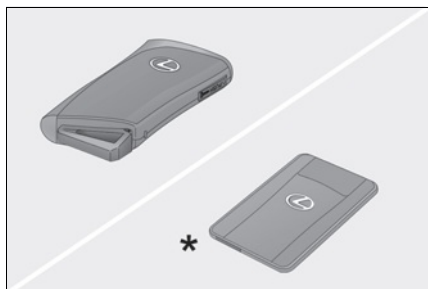

- Smart access system with push-button start (→P.17)
- Wireless remote control
- *: If equipped

Mechanical key

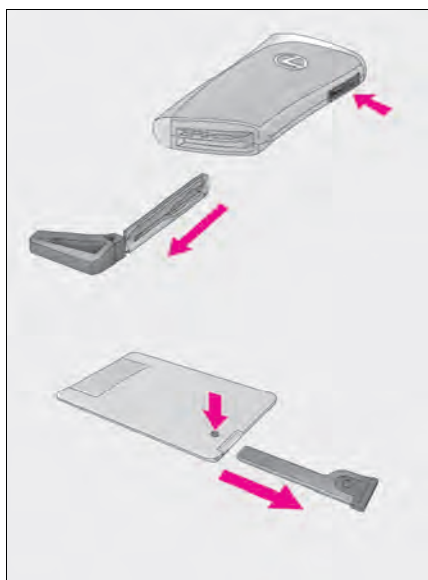

To take out the mechanical key, push the release button and take the key out.

The mechanical key can only be inserted in one direction, as the key only has grooves on one side. If the key cannot be inserted in a lock cylinder, turn it over and re-attempt to insert it.

After using the mechanical key, store it in the electronic key. Carry the mechanical key together with the electronic key. If the electronic key battery is depleted or the entry function does not operate properly, you will need the mechanical key.

Wireless remote control

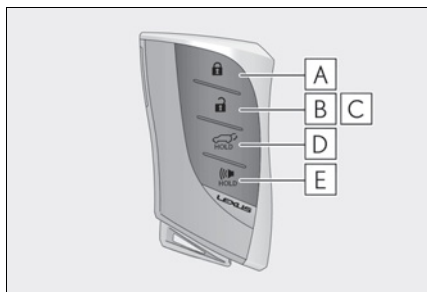

- A** Locks all the doors
- B** Unlocks all the doors
- C** Opens the windows and the moon roof*
- D** Opens and closes the power back door*
- E** Sounds the alarm

*: These settings must be customized at your Lexus dealer.

Smart Access System with Push-button Start

The following operations can be performed simply by carrying the electronic (including the card key) key on your person, for example in your pocket. The driver should always carry the electronic key.

For details on starting the engine, see page 18.

Unlocking and locking the doors from the outside

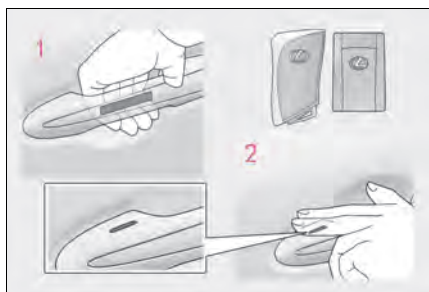

- 1** Grip the driver's door handle to unlock the door. Holding the driver's door handle for approximately 2 seconds unlocks all the doors. Grip the passenger's door handle to unlock all the doors.*

Make sure to touch the sensor on the back of the handle.

The doors cannot be unlocked for 3 seconds after the doors are locked.

*: The door unlock settings can be changed.

- 2** Touch the lock sensor (the indentation on the upper part or lower part of the handle) to lock the doors.

Check that the door is securely locked.

Unlocking and locking the back door from the outside

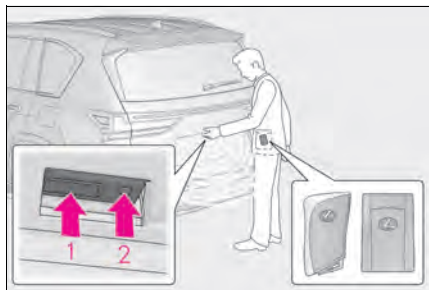

- 1** Unlocks all the doors
The doors cannot be unlocked for 3 seconds after the doors are locked.
- 2** Locks all the doors
Check that the door is securely locked.

For details on what to do when the electronic key does not operate properly, see page 99.

Engine (Ignition) Switch

Performing the following operations when carrying the electronic key on your person starts the engine or changes engine switch modes.

Starting the engine

- 1 Pull the parking brake switch to check that the parking brake is set. (→P.25)
The parking brake indicator will come on.
- 2 Check that the shift lever is set in P.
- 3 Firmly depress the brake pedal.



and a message will be displayed on the multi-information display.

If it is not displayed, the engine cannot be started.

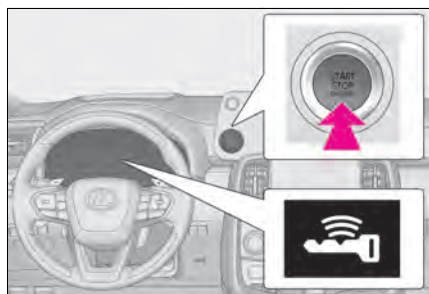

- 4 Press the engine switch quickly but fully.

When operating the engine switch, one short, firm press is enough. It is not necessary to press and hold the switch.

The engine will crank until it starts or for up to 30 seconds, whichever is less.

Continue depressing the brake pedal until the engine is completely started.

The engine can be started from any engine switch mode.

Stopping the engine

- 1 Stop the vehicle completely.
- 2 If the parking brake is in manual mode, set the parking brake. (→P.25)
Check the parking brake indicator is illuminated.
- 3 Shift the shift lever to P. (→P.21)
- 4 Press the engine switch shortly and firmly.
The engine will stop, and the meter display will be extinguished.
Release the shift lever when pressing the engine switch.
- 5 Release the brake pedal and check that “ACCESSORY” or “IGNITION ON” is not shown on the multi-information display.

Changing engine switch modes

Modes can be changed by pressing the engine switch with the brake pedal released. (The mode changes each time the switch is pressed.)

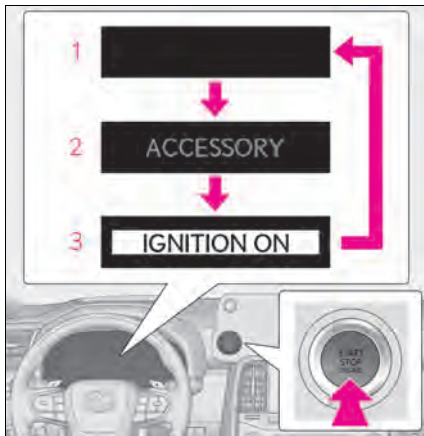

- 1 OFF*
The emergency flashers can be used.
The multi-information display will not be displayed.
- 2 ACC
Some electrical components such as the audio system can be used.
“ACCESSORY” will be displayed on the multi-information display.
- 3 ON
All electrical components can be used.
“IGNITION ON” will be displayed on the multi-information display.

*: If the shift lever is in a position other than P when turning off the engine, the engine switch will remain ON, will not turn to OFF.

If your vehicle has to be stopped in an emergency

Only in an emergency, such as if it becomes impossible to stop the vehicle in the normal way, stop the vehicle using the following procedure:

- 1** Steadily step on the brake pedal with both feet and firmly depress it.
Do not pump the brake pedal repeatedly as this will increase the effort required to slow the vehicle.
- 2** Shift the shift lever to N.
- ▶ If the shift lever is shifted to N**
- 3** After slowing down, stop the vehicle in a safe place by the road.
- 4** Stop the engine.
- ▶ If the shift lever cannot be shifted to N**
- 3** Keep depressing the brake pedal with both feet to reduce vehicle speed as much as possible.

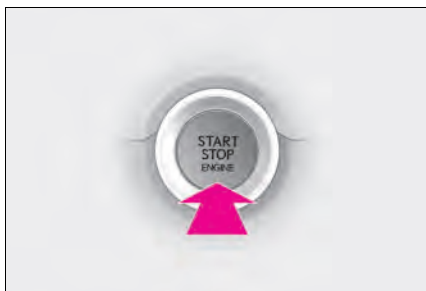

- 4** To stop the engine, press and hold the engine switch for 2 consecutive seconds or more, or press it briefly 3 times or more in succession.

- 5** Stop the vehicle in a safe place by the road.

Automatic Transmission

Shifting the shift lever

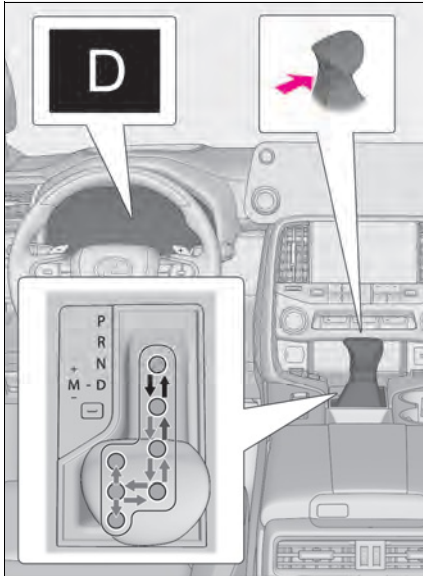

← While the engine switch is in ON and the brake pedal depressed*, shift the shift lever while pushing the shift release button on the shift knob.

← Shift the shift lever while pushing the shift release button on the shift knob.

← Shift the shift lever normally.

When shifting the shift lever between P and D, make sure that the vehicle is completely stopped.

*: For the vehicle to be able to be shifted from P, the brake pedal must be depressed before the shift release button is pushed. If the shift release button is pushed first, the shift lock will not be released.

Shift position purpose and functions

Shift position	Objective or function
P	Parking the vehicle/starting the engine
R	Reversing
N	Neutral (Condition in which the power is not transmitted)
D	Normal driving ^{*1}
M	M mode driving ^{*2} (→P.23)

*1: Shifting to the D position allows the system to select a gear suitable for the driving conditions. Setting the shift lever to the D position is recommended for normal driving.

*2: Selecting gear steps using the M position achieves suitable engine braking forces by operating the shift lever or paddle shift switches.

Selecting gear steps in the D position

To drive using temporary gear step selection, operate the “-” or “+” paddle shift switch when driving with the shift lever in D.

Changing the gear step allows restriction of the highest gear, preventing unnecessary upshifting and enabling the level of engine braking force to be selected.

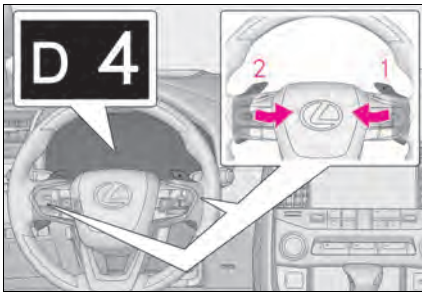

1 Upshifting

2 Downshifting

The selected gear step, from D1 to D10, will be displayed in the meter.

To return to normal D position driving, the “+” paddle shift switch must be held down for a period of time.

Selecting gears in M mode

To enter M mode, shift the shift lever to M. Gears can be selected by operating the shift lever or paddle shift switches or paddle shift switches, allowing you to drive in the gear of your choosing.

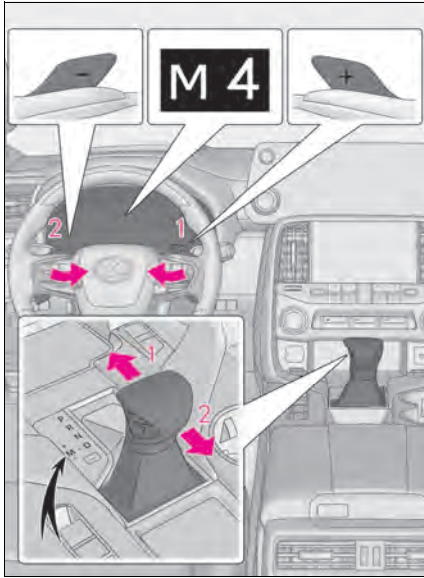

1 Upshifting

2 Downshifting

The gear changes once every time the shift lever or paddle shift switch is operated. The selected gear, from M1 to M10, will be fixed and displayed on the meter.

When in the M position, the gear will not change unless the shift lever or paddle shift switch is operated.

However, even when in the M position, the gears will be automatically changed in the following situations:

- When vehicle speed drops (downshift only).
 - When it is necessary to protect the engine or automatic transmission when the engine coolant temperature is low, the automatic transmission fluid temperature is high or low, or other reasons.
- Also, the gear will not shift when the vehicle speed is low, even if an upshift operation is performed.

Turn Signal Lever

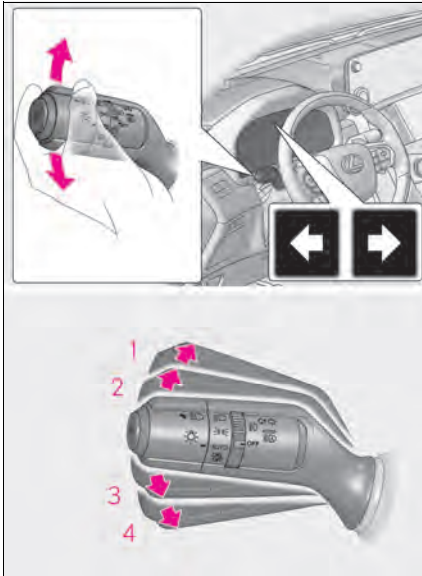

- 1** Right turn
- 2** Lane change to the right (move the lever partway and release it)
The right hand signals will flash 3 times.
- 3** Lane change to the left (move the lever partway and release it)
The left hand signals will flash 3 times.
- 4** Left turn

Parking Brake

The parking brake can be set or released automatically or manually.

Using the manual mode

The parking brake can be set and released manually.

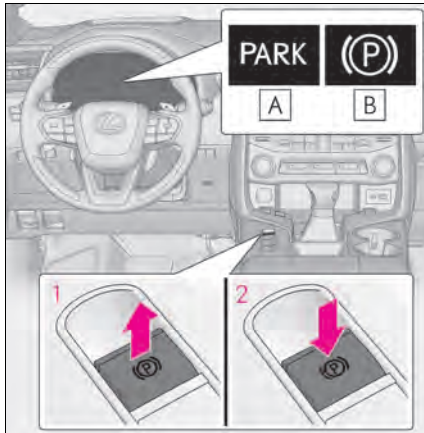

A U.S.A.

B Canada

1 Pull the switch to set the parking brake.

The parking brake indicator light will turn on.

Pull and hold the parking brake switch if an emergency occurs and it is necessary to operate the parking brake while driving.

2 Push the switch to release the parking brake.

- Operate the parking brake switch while depressing the brake pedal or the accelerator pedal. When using this function, slowly depress the accelerator pedal.

- Parking brake automatic release function

Make sure that the parking brake indicator light turns off.

Turning the automatic mode on

While the vehicle is stopped, pull and hold the parking brake switch until a buzzer sounds and “EPB Shift Interlock Function Activated” is displayed on the multi-information display.

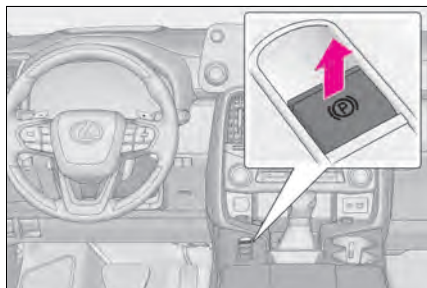

When the automatic mode is turned on, the parking brake operates as follows.

- When the shift lever is shifted from P, the parking brake will be released, and the parking brake indicator light will turn off.
- When the shift lever is shifted to P, the parking brake will be set, and the parking brake indicator light will turn on.

Operate the shift lever with the vehicle stopped and the brake pedal depressed.

Turning the automatic mode off

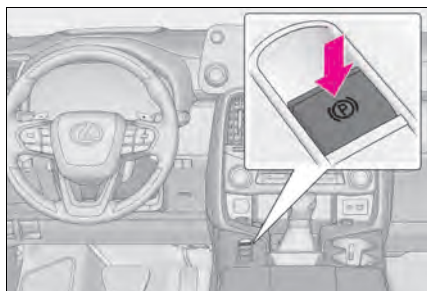

While the vehicle is stopped and depressing the brake pedal, press and hold the parking brake switch until a buzzer sounds and “EPB Shift Interlock Function Deactivated” is displayed on the multi-information display.

Brake Hold

The brake hold system keeps the brake applied when the shift lever is in D, M or N with the system on and the brake pedal has been depressed to stop the vehicle. The system releases the brake when the accelerator pedal is depressed with the shift lever in D or M to allow smooth start off.

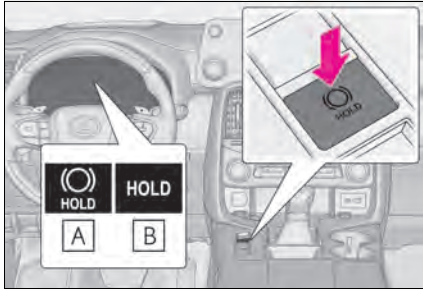

Turns the brake hold system on

The brake hold standby indicator (green)

A comes on. While the system is holding the brake, the brake hold operated indicator (yellow) **B** comes on.

Multi-information Display

The multi-information display presents the driver with a variety of vehicle data.

Display and menu icons

■ Display





By selecting menu icons on the multi-information display, a variety of driving-related information can be displayed.

The multi-information display can also be used to change display settings and other vehicle settings.

Warning or suggestion/advice pop-up displays are also displayed in certain situations.

■ Menu icons

The menu icons will be displayed by pressing  or  of the meter control switch.



Driving information display

Select to display various drive data.



Navigation system-linked display

Select to display the following navigation system-linked information.

- Route guidance to destination
- Compass display



Audio system-linked display

Select to enable selection of an audio source or track on the meter using the meter control switches.



Driving support system information display

Select to display the operational status of the following systems:

- LTA (Lane Tracing Assist)
- Dynamic radar cruise control with full-speed range
- RSA (Road Sign Assist) (if equipped)



Warning message display

Select to display warning messages and measures to be taken if a malfunction is detected.



Settings display

Select to change the meter display settings

Changing the meter display

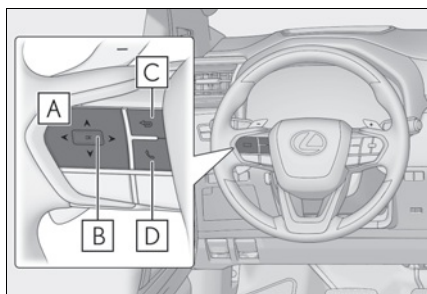

- A** < / > : Select menu icons
↑ / ↓ : Change displayed content, scroll up/down the screen and move the cursor up/down
- B** Press: Enter/Set
Press and hold: Reset
- C** Return to the previous screen
- D** Call sending/receiving and history display

Linked with the hands-free system, sending or receiving call is displayed. For details regarding the hands-free system, refer to the "MULTIMEDIA OWNER'S MANUAL".

Head-up Display (if equipped)

The head-up display projects a variety of driving-related information and the operating state of the driving support systems on the windshield.

System components

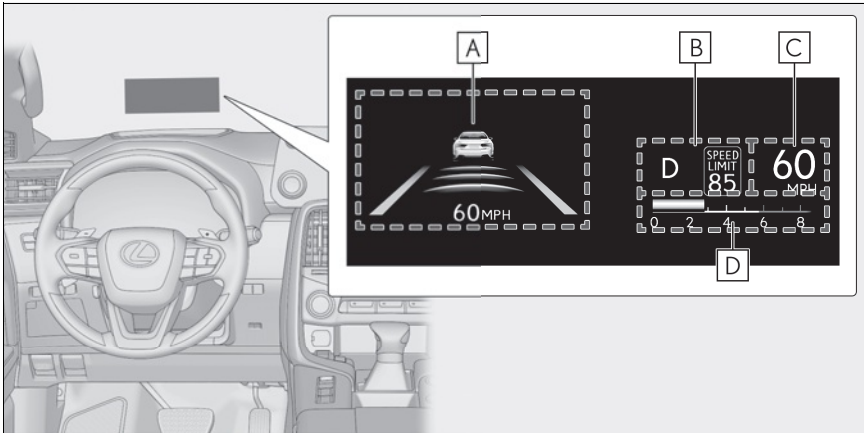

Illustrations used in this text are intended as examples, and may differ from the image that is actually displayed by the head-up display.

- A** Driving support system display area/Navigation system-linked display area
- B** Shift position/speed limit/RSA (Road Sign Assist) display area
- C** Speedometer
- D** Eco Driving Indicator/Tachometer display area

Using the head-up display

The following settings can be changed on  of the multi-information display. For details, refer to the "OWNER'S MANUAL".

- Enabling/disabling the head-up display
Select to enable/disable the head-up display.
 - Brightness and vertical position of the head-up display
Select to adjust the brightness or vertical position of the head-up display.
 - Tachometer Settings
Select to display the following items:
 - Blank
 - Eco Driving Indicator
 - Tachometer
 - Display content
Select to enable/disable the following items:
 - Navigation display
 - Driving Assist display*
 - Compass
 - Audio system operation status
- *: Make sure to enable this display when using the driving support systems
- Display angle
Select to adjust the angle of the head-up display.

Eco Driving Indicator/Tachometer display area

Eco Driving Indicator

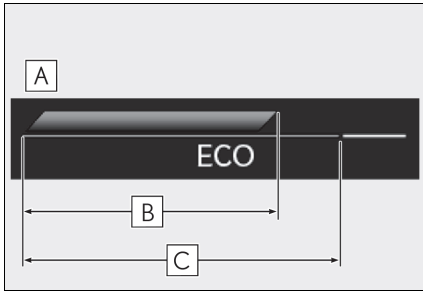

- A** Eco Driving Indicator Zone Display
- B** Eco driving ratio based on acceleration
- C** Zone of Eco driving
Displayed content is the same as that displayed on the multi-information display (Eco Driving Indicator).

Tachometer

Displays the engine speed in revolutions per minute.

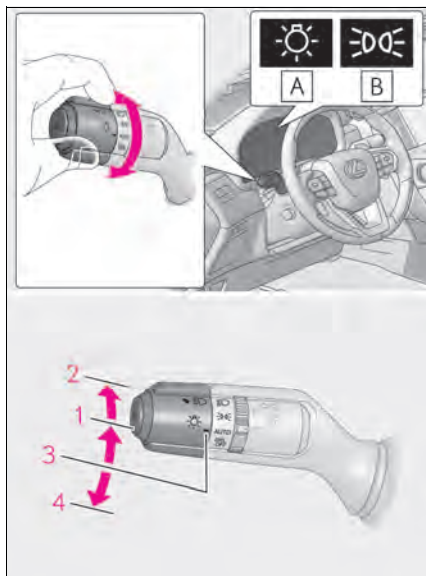

The head-up display may seem dark or hard to see when viewed through sunglasses, especially polarized sunglasses. Adjust the brightness of the head-up display or remove your sunglasses.

Headlight Switch



A For the U.S.A.

B For Canada

- 1**  The side marker, parking, tail, license plate, instrument panel lights, and daytime running lights turn on.
- 2**  The headlights and all lights listed above (except daytime running lights) turn on.
- 3** **AUTO** The headlights, daytime running lights and all lights listed above turn on and off automatically.
- 4**  (U.S.A.) Off

Turning on the high beam headlights

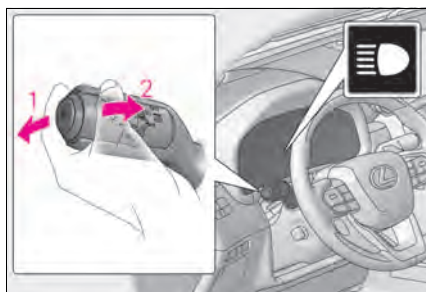

- 1** With the headlights on, push the lever forward to turn on the high beams. Pull the lever back to the center position to turn the high beams off.
- 2** Pull the lever toward you and release it to flash the high beams once. You can flash the high beams with the headlights on or off.

AHB (Automatic High Beam)

The Automatic High Beam uses an in-vehicle front camera to assess the brightness of streetlights, the lights of vehicles ahead etc., and automatically turns the high beams on or off as necessary.

Activating the Automatic High Beam system

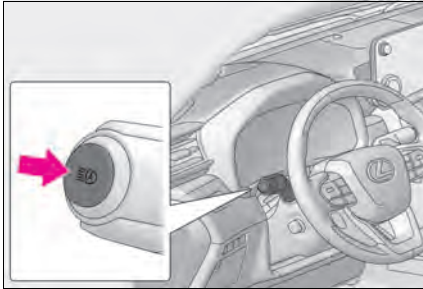

- 1 Press the Automatic High Beam switch.

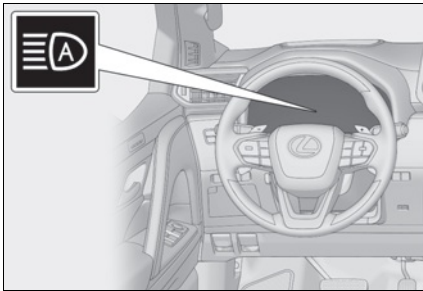

- 2 Turn the headlight switch to the **AUTO** or  position.

The Automatic High Beam indicator will come on when the system is operating.

Turning the high beams on/off manually

Switching to the high beams

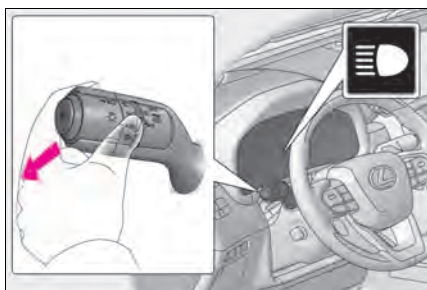

Push the lever away from you.

The Automatic High Beam indicator will turn off and the headlight high beam indicator will turn on.

Pull the lever to its original position to activate the Automatic High Beam system again.

Switching to the low beams

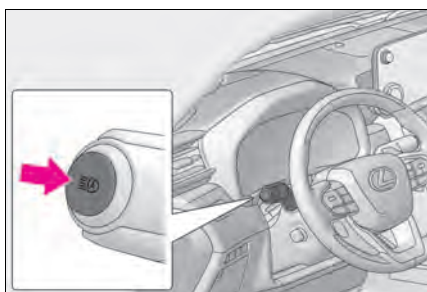

Press the Automatic High Beam switch.

The Automatic High Beam indicator will turn off.

Press the switch to activate the Automatic High Beam system again.

Temporarily switching to the low beams

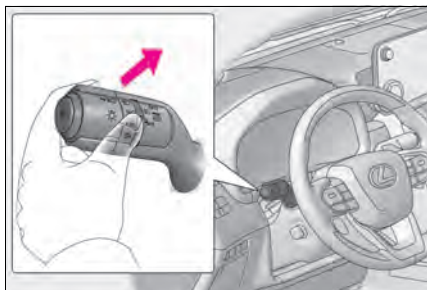

Pull the lever toward you and then return it to its original position.

The high beams are on while the lever is pulled toward you, however, after the lever is returned to its original position, the low beams remain on for a certain amount of time. Afterwards, the Automatic High Beam will be activated again.

Fog Light Switch

The fog lights offer improved visibility in difficult driving conditions, such as in rain and fog.

Operating procedure

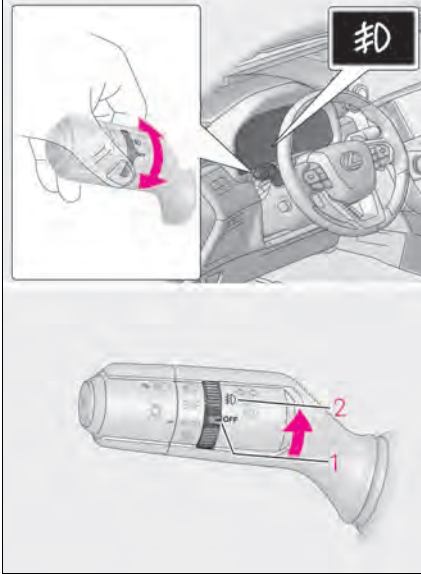

1 OFF *1 or ○ *2 Off

2 ☞ Fog lights on

*1: For the U.S.A.

*2: For Canada

Windshield Wipers and Washer

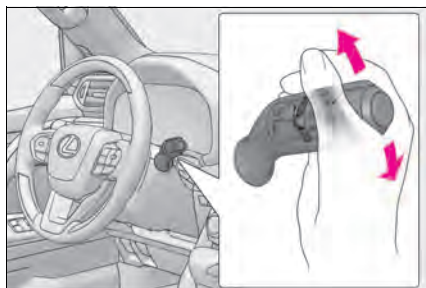

- 1 OFF** *1 or ○ *2 Off
- 2 AUTO** Rain-sensing operation
- 3 LO** *1 or ▼ *2 Low speed operation
- 4 HI** *1 or ▼ *2 High speed operation
- 5 MIST** *1 or ▲ *2 Temporary operation

*1: For the U.S.A.

*2: For Canada

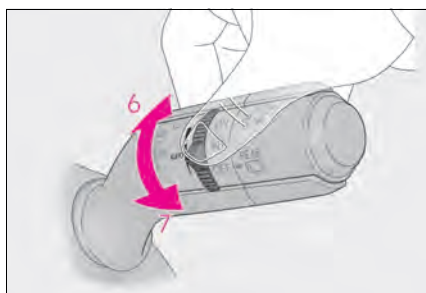

When **AUTO** is selected, the sensor sensitivity can be adjusted by turning the switch ring.

- 6** Increases the sensitivity
- 7** Decreases the sensitivity



- 8**  Washer/wiper dual operation

Pulling the lever operates the wipers and washer.

After operating several times, the wipers operate one more time after a short delay to prevent dripping.

When the engine switch is in **ON** and the headlights are on, if the lever is pulled, the headlight cleaners will operate once. After this, the headlight cleaners will operate every 5th time the lever is pulled.

Rear Window Wiper and Washer

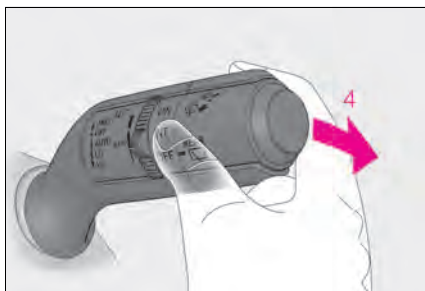
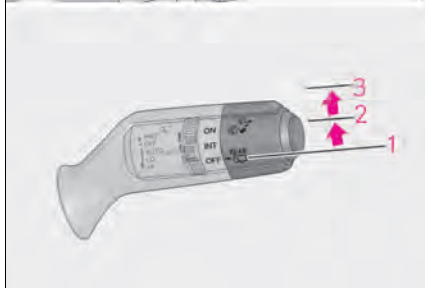
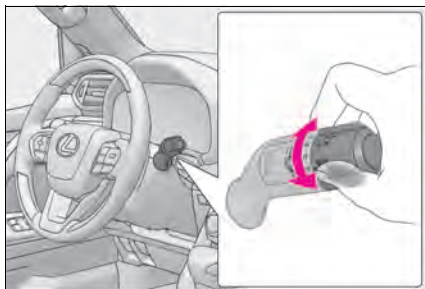

- 1 OFF** *¹ or ○ *² Off
- 2 INT** *¹ or --- *² Intermittent operation
- 3 ON** *¹ or — *² Normal operation

*¹: For the U.S.A.

*²: For Canada

- 4**  Washer/wiper dual operation

Pushing the lever operates the wiper and washer.

The washer will automatically operate and clean the camera for the Multi-terrain Monitor.

Driving Mode Select Switch

The driving modes can be selected to suit driving condition.

System components

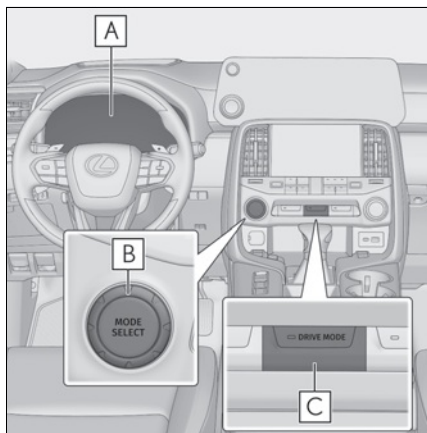

- A** Multi-information display (→P.28)
- B** MODE SELECT switch
- C** DRIVE MODE switch

Selecting the driving mode

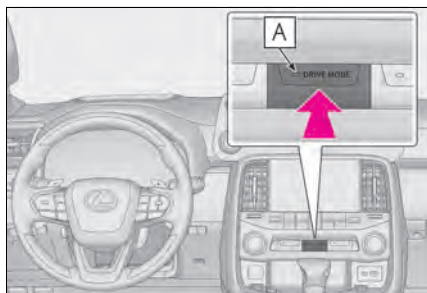

- 1** Press the DRIVE MODE switch.
The indicator **A** on the switch will turn on.
- 2** Select the driving modes on the multi-information display while turning the MODE SELECT switch left and right.

► Vehicles without Adaptive Variable Suspension system



- Normal mode
Provides an optimal balance of fuel economy, quietness, and dynamic performance. Suitable for city driving.
- Eco drive mode
Helps the driver accelerate in an eco-friendly manner and improve fuel economy through moderate throttle characteristics and by controlling the operation of the air conditioning system (heating/cooling). The Eco drive mode indicator comes on.
- Sport mode
Assists acceleration response by controlling the transmission, engine and steering. Suitable for when precise handling is desirable, for example when driving on mountain roads. The sport mode indicator comes on.

► Vehicles with Adaptive Variable Suspension system

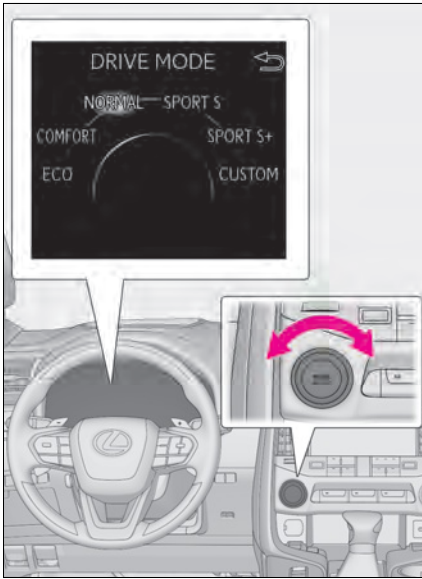

- Normal mode
Provides an optimal balance of fuel economy, quietness, and dynamic performance.
Suitable for city driving.

- Comfort mode
By controlling the suspension, riding comfort is further enhanced. Suitable for city driving. The comfort mode indicator comes on.

- Eco drive mode
Helps the driver accelerate in an eco-friendly manner and improve fuel economy through moderate throttle characteristics and by controlling the operation of the air conditioning system (heating/cooling). The Eco drive mode indicator comes on.

- SPORT S mode

Assists acceleration response by controlling the transmission. This mode is suitable for when powerful acceleration is desired. The SPORT S mode indicator comes on.

- SPORT S+ mode

Helps to ensure the controllability and stability of the vehicle by integrally controlling the steering wheel and suspensions as well as the transmission and engine, making it suitable for sporty driving. The SPORT S+ mode indicator comes on.

- Custom mode

Allows you to drive with the power train, steering wheel, suspensions and air conditioning system functions set to your preferred settings. Custom mode settings can only be changed on the drive mode customization display of Multimedia Display.

The custom mode indicator comes on.

AHC (Active Height Control Suspension) (if equipped)

The vehicle height modes can be selected to suit driving condition.

System components

■ Height select switches

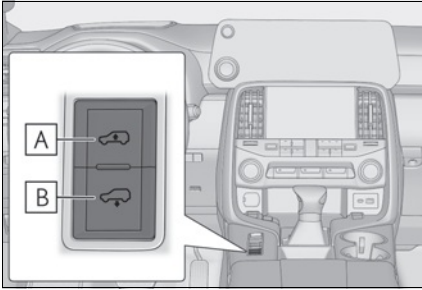

A Higher

B Lower

■ Meter display

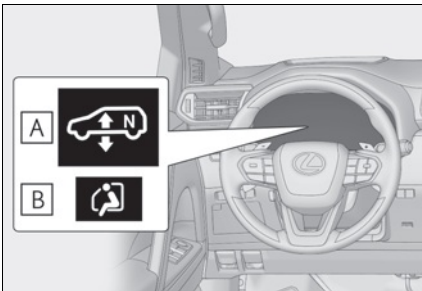

A AHC display

B Easy access mode indicator

■ Front Multi Operation Panel

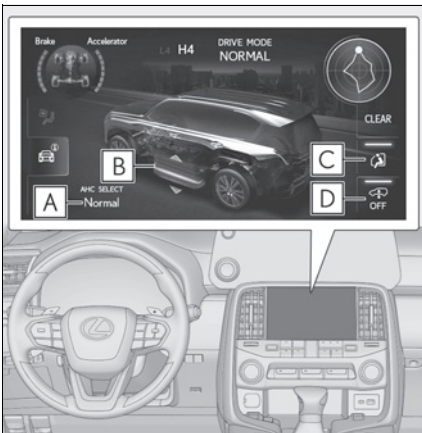

A Vehicle height mode

B AHC display

C Easy access mode switch

D Height control OFF switch

Easy access mode

You can select this mode for easy access and easy loading of the vehicle.

To turn easy access mode on, turn the four-wheel drive control switch to H4 and press the easy access mode switch on the Front Multi Operation Panel.

When the easy access mode is in on, the indicator **A** on the switch and the easy access mode indicator on the meter comes on.

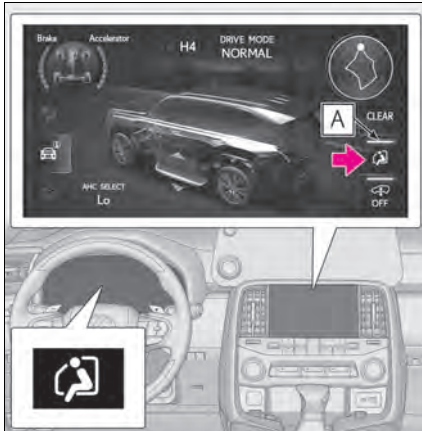

If the engine switch is turned off within approximately 30 seconds after the vehicle is stopped while easy access mode is on, the vehicle height is lowered automatically.

When the vehicle begins to lower, a buzzer will sound twice. The easy access mode indicator display will come on while the vehicle is lowering to indicate that the vehicle is lowering.

When the operation is complete, the easy access mode indicator will turn off.

Four-wheel Drive System

Use the four-wheel drive control switch and center differential lock switch to select the following transfer and center differential modes.

Four-wheel drive control switch

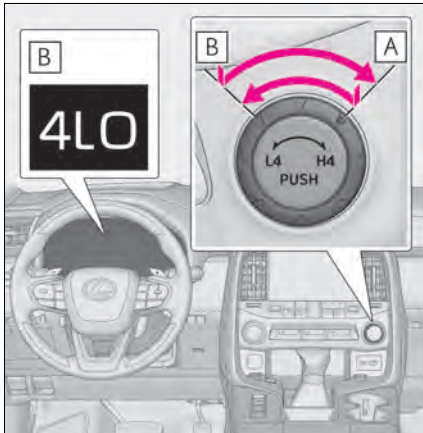

A H4 (high speed position)
Normal driving on all types of roads.

B L4 (low speed position)
Driving requiring maximum power and traction such as climbing or descending steep hills, off-road driving, and hard pulling in sand or mud, etc.

The low speed four-wheel drive indicator will come on.

Center differential lock switch

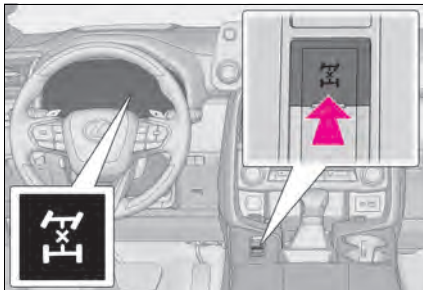

Lock the center differential when your vehicle's wheels get stuck in a ditch or when driving on a slippery or bumpy surface.

The center differential lock indicator will come on.

To unlock the center differential, push the switch again.

Unlock the center differential after the wheels have been freed, or after moving to a flat, non-slippery surface.

Crawl Control (with Turn Assist function)

Allows travel on extremely rough off-road surfaces at a fixed low speed without pressing the accelerator or brake pedal. Minimizes loss of traction or vehicle slip when driving on slippery road surfaces, allowing for stable driving.

System components

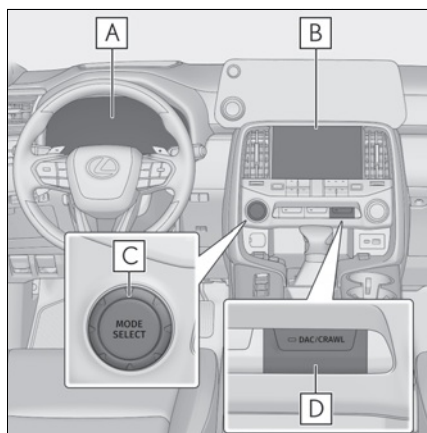

- A** Meter (→P.28)
- B** Front Multi Operation Panel
- C** MODE SELECT switch
- D** DAC/CRAWL switch

Selectable modes

A mode which matches the road conditions can be selected from among the following 5 modes.



- 1** Lo
Suitable for driving on rocky roads or decline
- 2** Lo-Mid
Suitable for driving on rocky roads, decline or bumpy incline
- 3** Mid
Suitable for driving on bumpy inclines

- 4** Mid-Hi

Suitable for driving on bumpy inclines, debris roads, snow-covered roads, muddy roads, gravel roads and grass roads

- 5** Hi

Suitable for driving on bumpy inclines, debris roads, snow-covered roads, muddy roads, gravel roads and grass roads

Turn Assist function

This function assists cornering performance in accordance with steering operation when driving through a tight corner. It maintains vehicle speed while driving and implements control that improves turning performance according to the driver's steering wheel operation, to reduce the number of turns.

- 1** While Crawl Control is operating, press the  on Front Multi Operation Panel to display the off-road driving information display screen.

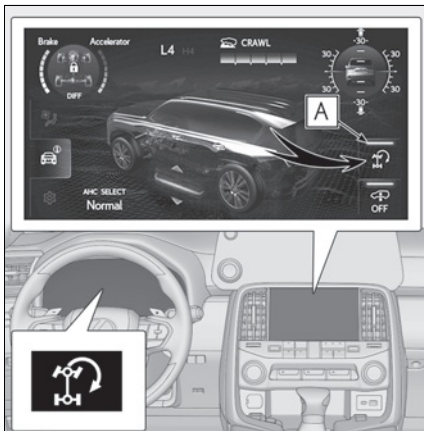

- 2** Press the Turn Assist switch
The indicator light **A** and Turn Assist indicator on the meter will come on.
To turn the system off, press the switch again.

Multi-terrain Select

Multi-terrain Select is a system that improves drivability in off-road situations.

Select a mode that most closely matches the type of terrain on which you are driving from several modes.

Brake control, drive force control and suspension control can be optimized in accordance with the selected mode.

When AUTO mode is selected, brake control, drive force control and suspension control are optimized automatically according to the road conditions.

System components

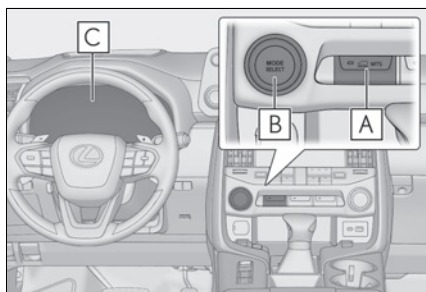

- A** MTS switch
 - B** MODE SELECT switch
 - C** Multi-information display
- Selected mode is displayed.

Switching modes

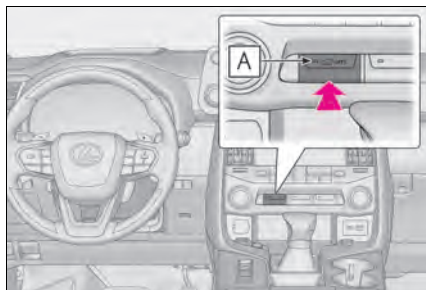



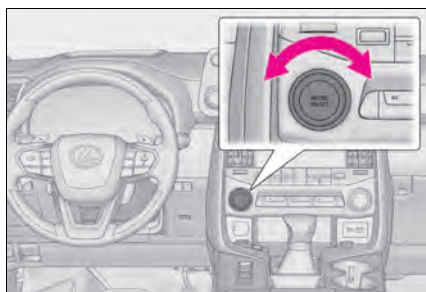

- 1** Press the MTS switch.
The indicator **A** on the switch will turn on.







- 2** Select the driving modes on the multi-information display while turning the MODE SELECT switch left and right.
Depending on the positions of the four-wheel drive control switch, a mode can be selected from among the following modes.

► Four-wheel drive control switch is in L4

Mode		Road Conditions
	AUTO	Suitable for the road conditions
	SAND	Suitable for sandy roads
	MUD	Suitable for muddy roads
	ROCK	Suitable for rocky terrain

If the brake control has activated, the slip indicator light will flash.

► Four-wheel drive control switch is in H4

Mode		Road Conditions
	AUTO	Suitable for the road conditions
	DIRT	Suitable for dirt roads
	SAND	Suitable for sandy roads
	MUD	Suitable for muddy roads
	DEEP SNO W	Suitable for deep snow roads

If the brake control has activated, the slip indicator light will flash.

When the vehicle is in SAND, MUD or DEEP SNOW mode, VSC is automatically turned off. (VSC OFF indicator light come on.)

Multi-terrain Monitor

The Multi-terrain Monitor helps the driver to check the vehicle surroundings. It assists in determining the conditions around the driver in a variety of situations, such as when judging conditions during off-road driving or checking for obstacles when parking.

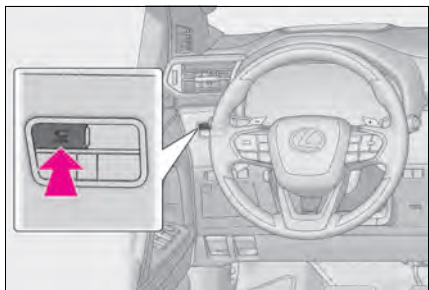

The VIEW switch is located as shown in the illustration.

Basic Operation of Multimedia System

Map scrolling operation

The map can be moved and a touched point can be set as the center of the map screen.

■ Flick/drag operation



The map screen can be moved by touching, dragging or flicking it.

Touch [Recenter] to return to the center of the map to the current position.

■ Touch and hold operation

If a desired point on the map screen is touched and held, the full route map screen to the selected point will be displayed.



1 Touch and hold the desired point.

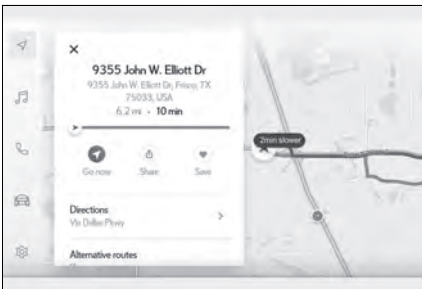

2 Full route map screen will be displayed for the selected point.

Navigation (if equipped)

The navigation system indicates your present position and assists in locating a desired destination.

Destination search screen

■ Searching for a destination using the keyboard

A destination can be searched for by entering keywords.

1 Touch [] or [] on the map screen.

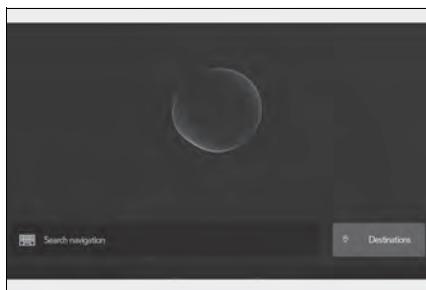

2 Touch [].



3 Enter characters using the keyboard.

4 Touch [Go].

5 Touch the desired item from the list.

■ Searching for a destination by category

A destination can be searched for from a list of categories.

1 Touch [📍] or [🔍] on the map screen.



2 Touch [Destinations].

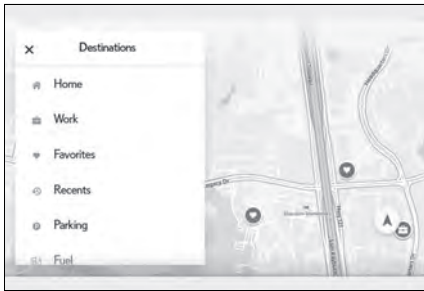

3 Touch the desired search method.

[Home]: Touch to set the registered home as the destination. A point must be registered as home before using this function.*

[Work]: Touch to set the registered workplace as the destination. A point must be registered as a workplace before using this function.*

[Favorites]: Touch to set a registered favorite as the destination. A point must be registered as a favorite before using this function.

[Recents]: Touch to set a destination from the destination history as the destination.

[Sent to car]: Sent to car enables customer to send a destination or POI to the vehicle from Lexus app.

[Parking]: Touch to search for a nearby parking lot to set as a destination.

[Fuel]: Touch to search for a fuel station to set as a destination.

[Food]: Touch to search for a restaurant to set as a destination.

[Hospitals]: Touch to search for a hospital to set as a destination.

When setting a business as a destination, if your estimated time of arrival is outside of business hours or near closing time, a notification asking to confirm the destination will be displayed.

*: Home and Work must be added via Lexus app.

4 Touch the desired destination from the list.

► Editing the favorites list

The favorites list can be edited.

1 Touch [📍] or [🔍] on the map screen.

2 Touch [Destinations].

3 Touch [Favorites].

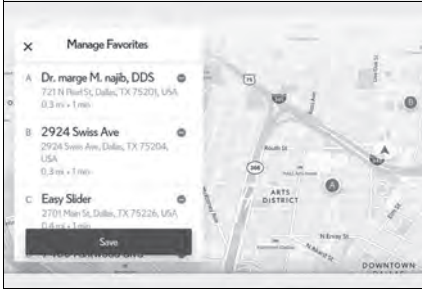

5 Touch [Save].

► Editing the destination history

The destination history can be edited.

1 Touch [📍] or [🔍] on the map screen.

2 Touch [Destinations].

3 Touch [Recents].

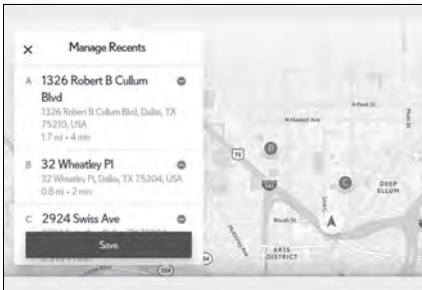

5 Touch [Save].

4 Touch [✎].

Touch [⊖] to delete a favorite.

The favorites list editing screen will be displayed.

4 Touch [✎].

The destination history editing screen will be displayed.

Touch [⊖] to delete a destination history item.

■ Searching for a destination using voice controls

1 Touch [] or [] on the map screen.



2 Say the keyword you wish to use for the search.

3 Touch or Use Voice Command for Desired result from List.

Connecting a Smartphone or Communication Device

Registering a Bluetooth® device from the multimedia system

A cellular phone or portable device must be registered in order to use hands-free calling or Bluetooth® audio. Once registration is complete, Bluetooth® will automatically be connected each time the multimedia system is started.

When Apple CarPlay or Android Auto is connected via USB, the device will be automatically registered.

If no Bluetooth® device is connected, the registration screen can also be displayed by pressing and holding the [] switch on the steering.

1 Touch [] from the main menu.

2 Touch [Bluetooth & Devices].

If no device is registered, Procedure **4**.

3 Touch [Add another device].

While a device is connected to the multimedia system, the confirmation screen for disconnecting the device may be displayed. Disconnect the device to perform registration.

4 Touch [Search for devices].

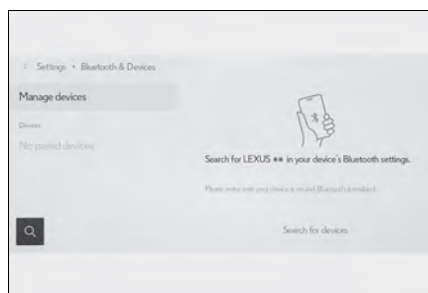

5 Touch the device to register from the main area.

- The Bluetooth® address may be displayed instead of the device name.
- Certain models of Bluetooth® devices may not be displayed in the device list, unless a certain screen is displayed on the Bluetooth® device. Refer to the Bluetooth® device's instruction manual for details.

- 6 Check that the displayed PIN code matches the PIN code displayed on the Bluetooth® device, and then touch [OK].
 - Some Bluetooth® devices may need to be operated to complete registration.
 - You may be prompted to install the Lexus Application on your phone. Please follow the displayed instruction.
 - Primary device settings may be displayed. Perform the operation according to the screen guidance.
 - The Apple CarPlay or Android Auto settings may be displayed. The Apple CarPlay or Android Auto screen will be displayed if the use of either is enabled.
 - A message indicating that connection is complete is displayed, and the name of the registered Bluetooth® device is displayed in the sub menu.
 - If an operation failed screen is displayed, follow the operation instructions on the screen.

■ Registering from a Bluetooth® device

If the Bluetooth® device cannot be found by searching with the multimedia system, register by searching for the multimedia system from the Bluetooth® device.

- 1 Touch [⚙️] from the main menu.
- 2 Touch [Bluetooth & Devices].
If no device is registered, Procedure 4.
- 3 Touch [Add another device].

While a device is connected to the multimedia system, the confirmation screen for disconnecting the device may be displayed. Disconnect the device to perform registration.

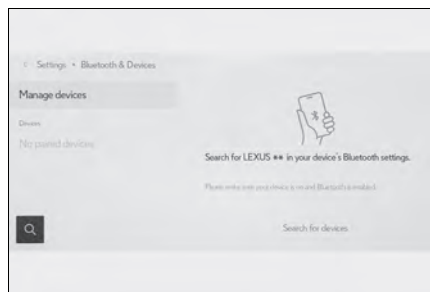

- 4 Register the multimedia system from the Bluetooth® device to be used.
 - Perform the operation according to the operating procedure of the Bluetooth® device.
 - Be sure to display this Bluetooth® connection screen before performing registration on the Bluetooth® device.

- 5** Check that the displayed PIN code matches the PIN code displayed on the Bluetooth® device, and then touch [OK].
- Some Bluetooth® devices may need to be operated to complete registration.
 - You may be prompted to install the Lexus Application on your phone. Please follow the displayed instruction.
 - Primary device settings may be displayed. Perform the operation according to the screen guidance.
 - The Apple CarPlay or Android Auto settings may be displayed. The Apple CarPlay or Android Auto screen will be displayed if the use of either is enabled.
 - A message indicating that connection is complete is displayed, and the name of the registered Bluetooth® device is displayed in the sub menu.
 - If an operation failed screen is displayed, follow the operation instructions on the screen.

■ Operating with the steering switches

Some hands-free call functions can be operated from the steering switches, such as receiving or making calls. The steering switch functions change depending on the status of the multimedia system.

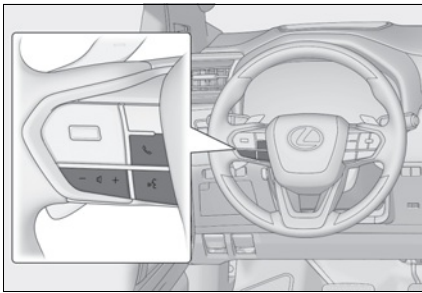

- Operate the switches as necessary.
[+] switch
Increases the ringtone volume or receiver volume.
Press and hold to adjust continuously.
- [-] switch
Decreases the ringtone volume or receiver volume.
Press and hold to adjust continuously.

[] switch

Calls can be made using voice command.

To end Intelligent Assistant, press and hold the talk switch.

[] switch

- While a call cannot be made, displays call history screen or phone menu.
- Phone calls can be made when [] is displayed on the phone screen.
- While making a call or during a call, ends the call.
- While receiving a call or during call waiting, answers the call.

Making calls from call history

Calls can be made to phone numbers that have been recorded in the call history as outgoing or incoming calls.

- 1 Touch [] from the main menu.
- 2 Touch [Recents].

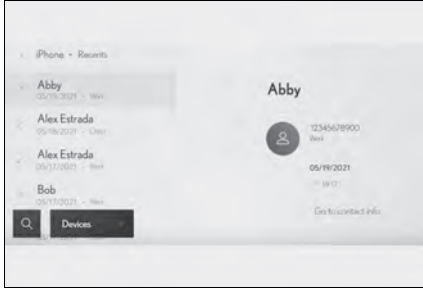

- 3 Select the contact.
For phone numbers that are not registered in the contact, the phone number will be displayed as it is.
- 4 Touch the desired phone number.

Making calls from the favorites list

Make a call from your favorites list.

- 1 Touch [] from the main menu.
- 2 Touch [Favorites].

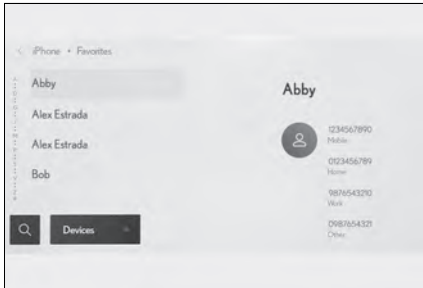

- 3 Select the person you want to call from your favorites list.
- 4 Touch the desired phone number.

Making calls from contacts

Make a call from the contacts registered on the multimedia system.

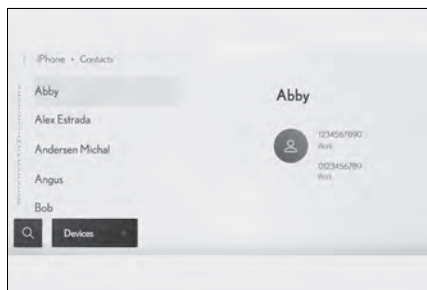

- 1 Touch [] from the main menu.
- 2 Touch [Contacts].
- 3 Select a contact.
- 4 Touch the desired phone number.

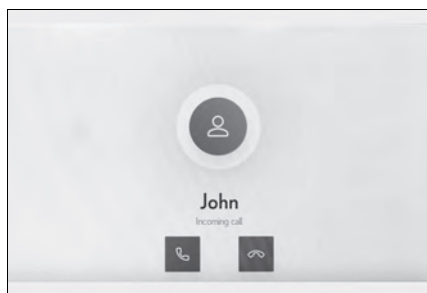

Answering calls

When there is an incoming call, the incoming call sounds and the incoming call screen or incoming call notification is displayed.



- Answer the call by doing one of the following.
 - Touch [].
 - Press the [] switch on the steering.

Basic Operation of Audio System

Changing the audio source

Source can be changed to radio, USB, etc.

- 1 Touch [] from the main menu.
- 2 Touch [Sources].



- 3 Touch the source you wish to select.

Listening to the radio

Switch to your preferred frequency or service and listen to the radio.

- 1 Touch [] from the main menu.
- 2 Touch [Sources].
- 3 Touch [Radio].
- 4 Select the station selection method or service as necessary.

[Favorites]: Select a broadcasting station from those registered as favorites.

[Tune]: Select the broadcasting station by entering a frequency with the numeric keypad.

[FM Radio]: Switches to FM mode. The FM station list, the 3 most recently listened stations, and the receivable FM broadcasting stations are displayed.

[AM Radio]: Switches to AM mode. The AM station list, the 3 most recently listened stations, and the receivable AM broadcasting stations are displayed.

[SiriusXM]: Switches to SiriusXM Radio mode. Displays [For You] and contents/Super Categories/[All channels]/[Listening History]. (This function is not made available in some countries or areas)

- 5 Select the broadcasting station from the station list or genre.

- 6 Operate the radio that is being received as necessary.
- Operating AM/FM from the screen



[Ch]: Touch [-] or [+] to search for the receivable broadcasting stations. Touch and hold to jump to the next frequency with available radio signal. When released, the broadcasting station closest to that position with the best reception sensitivity is selected automatically.

[Scan]: SEEK UP and output the audio of the detected station for 10 sec. This is repeated.

[HD 1 2]: Displayed when Multicast CH is supported in FM mode. Touch to display the SPS channel list. The mode can be changed to the displayed SPS channel list.

[♥]: Registers the currently received broadcasting station in favorites. When registered, touch to cancel.

Preset buttons of sub menu: Receive the registered broadcasting stations.

- Operating SiriusXM Radio from the screen
(This function is not made available in some countries or areas)



[Ch]: Touch [-] or [+] to search for the receivable channels. Touch and hold to jump to the next frequency with available radio signal. When released, the current channel is received.

[⏮]/[⏭]: Fast rewind or fast forward the radio cache. Touch and hold to jump to the start or end of the buffer.

[⏸]: Pause the radio cache.

[▶]: Play the radio cache.

[Related]: Displays content related to the received channel.

[Notify me]: Select an artist or song, or both an artist and song, to receive a notification when the corresponding broadcast starts. (When receiving a regular channel) Select a sports team to receive a notification when the corresponding broadcast starts. (When receiving a sport channel)

[♥]: Registers the currently received channel in favorites. When registered, touch to cancel.

Preset buttons of sub menu: Receives the registered channels.

- Operating with the steering switches
[<]/[>]switches

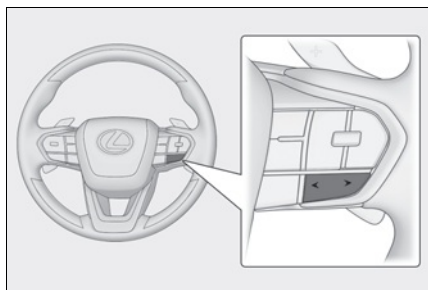

- AM/FM

Switch the frequencies or broadcasting stations registered in the preset buttons in order.

Press and hold to switch frequencies. When released, the broadcasting station closest to that position with the best reception sensitivity is selected automatically.

- SiriusXM Radio

Switch the channels registered in the preset buttons in order.

Press and hold to switch channels. When released, the channel closest to that position with the best reception sensitivity is selected automatically.

Playing iPod/iPhone

Play back music files on an iPod or iPhone connected to the USB port. When an iPod or iPhone is connected, a button with the device's name is displayed on the source selection screen. This may not be displayed for some devices.

Connect an iPod or iPhone.

- 1 Touch [] from the main menu.
 - 2 Touch [Sources].
 - 3 Touch the device name or [USB].
 - 4 Operate the iPod or iPhone that is playing as necessary.
- Perform operations from the screen

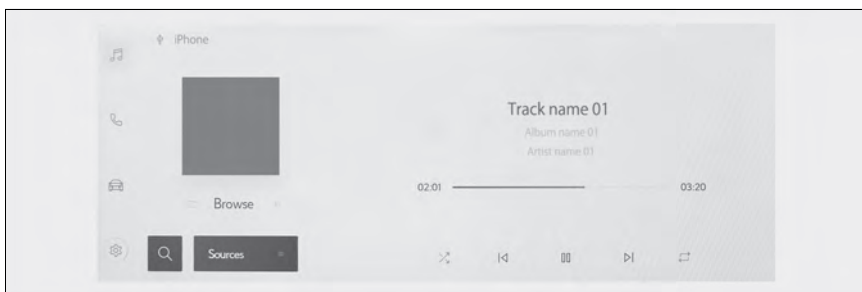

[]: Performs shuffle playback. Each touch switches the shuffle setting.*

[]: Plays the currently playing track from the beginning. When at the start of the track, the previous track will play from the beginning.

Touch and hold to fast rewind. Release to start playback from that position.

[]: Pauses playback.

[]: Plays.

[]: Switches the tracks. Touch and hold to fast forward. Release to start playback from that position.

[]: Performs repeat playback. Each touch switches the repeat setting.*

[Browse]: Displays the playback mode in the sub menu.

Tracks can be selected from a list sorted by artist, album, song, playlist, genre, Podcast, composer, audiobook, or radio.

[Shuffle play] is displayed when playing a track selected from the list. Touch this to return to the playback screen and perform shuffle playback.

*: The order in which shuffle or repeat settings switch depends on the connected device.

● Operating with the steering switches

[<]/[>]switches

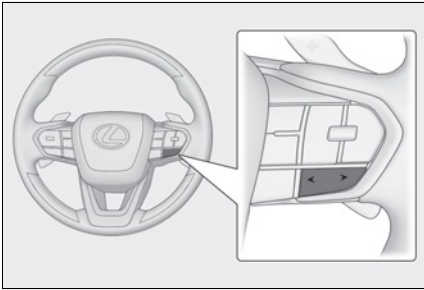

Switches the tracks.

Press and hold to fast forward or fast rewind. Release to start playback from that position.

Lexus Climate Concierge

The seat heaters, seat ventilators (if equipped) and heated steering wheel (if equipped) are each automatically controlled according to the set temperature of the air conditioning system, the outside and cabin temperature, etc. Lexus Climate Concierge allows a comfortable condition to be maintained without adjusting each system.

Turning on Lexus Climate Concierge

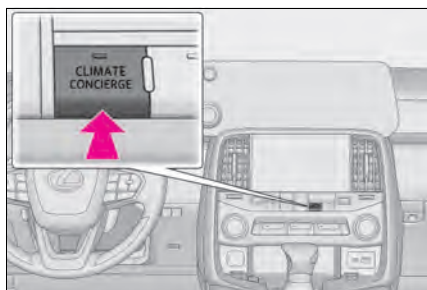

Press the "CLIMATE CONCIERGE" switch

The indicator above the switch illuminates, and the automatic air conditioning system, seat heaters and ventilators, and heated steering wheel operate in automatic mode.

If any of the system is operated manually, the indicator turns off. However, all other functions continue to operate in automatic mode.

Front Automatic Air Conditioning System

Air outlets and fan speed are automatically adjusted according to the temperature setting.

The air conditioning system can be operated using the air conditioning control panel and air conditioning control screen on the Front Multi Operation Panel.

Air conditioning controls

► Air conditioning control panel

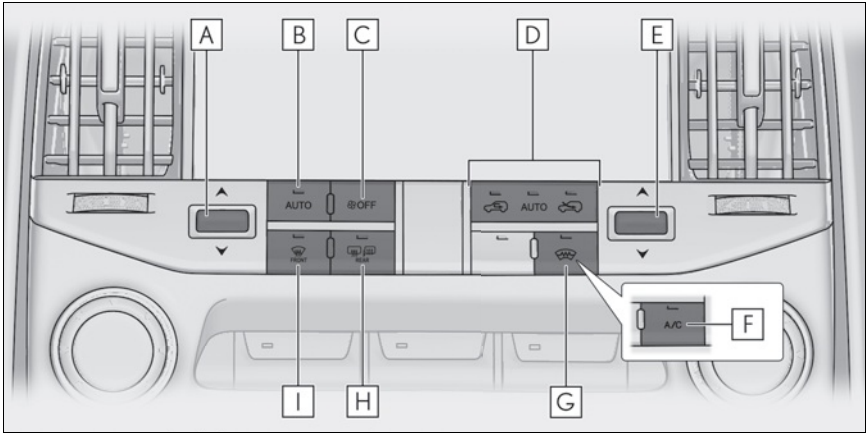

- A** Left-hand side temperature control switches
- B** Automatic mode switch
- C** "OFF" switch
- D** Outside/recirculated air mode switch
- E** Right-hand side temperature control switches
- F** "A/C" switch (if equipped)
- G** Windshield wiper de-icer switch (if equipped)
- H** Rear window and outside rear view mirror defoggers switch
- I** Windshield defogger switch

► Front Multi Operation Panel

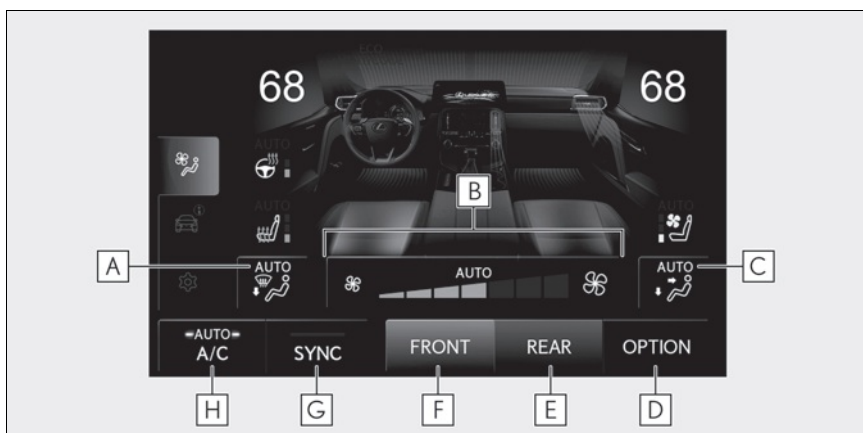

- A** Left-hand side airflow mode control switch
- B** Fan speed control switches
- C** Right-hand side airflow mode control switch
- D** "OPTION" switch
- E** "REAR" switch (→P.70)
- F** "FRONT" switch
- G** "SYNC" switch
- H** "A/C" switch

■ Option control screen

Select the "OPTION" switch to display the option control screen.

The functions can be switched (ON) and (OFF).

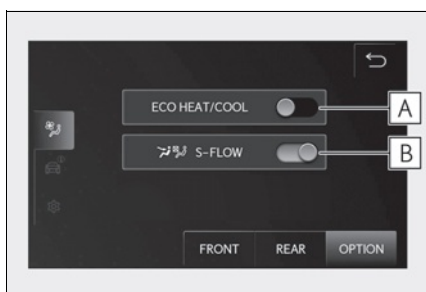

- A** Eco air conditioning mode
- B** Front seat concentrated airflow mode (S-FLOW)

Using automatic mode

- 1** Press the automatic mode switch on the air conditioning control panel.
- 2** Press the outside/recirculated air mode switch to switch to automatic mode.
- 3** Adjust the temperature setting.
- 4** To stop the operation, press the “OFF” switch on the air conditioning control panel.

Rear Air Conditioning System

Air outlets and fan speed are automatically adjusted according to the temperature setting.

Rear air conditioning controls

► Air conditioning control panel (5-passenger and 7-passenger models)

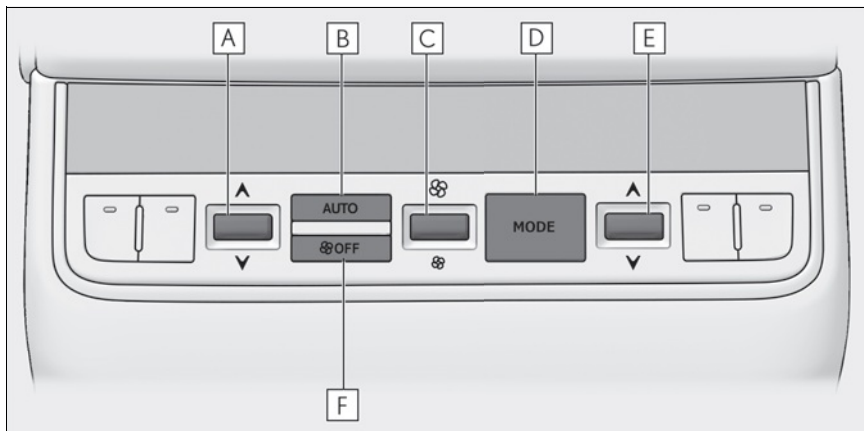

- A** Left-hand side temperature control switch
- B** Automatic mode switch
- C** Fan speed control switch
- D** Airflow mode control switch
- E** Right-hand side temperature control switch
- F** "OFF" switch

► Rear Multi Operation Panel (4-passenger models)

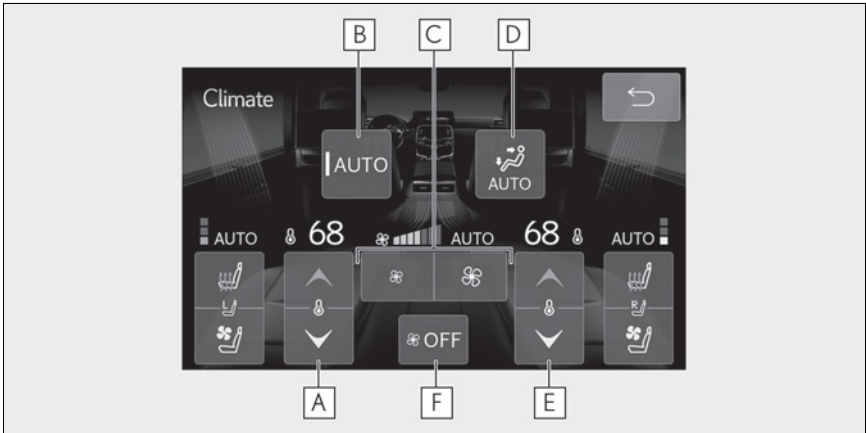

- A** Left-hand side temperature control switch
- B** Automatic mode switch
- C** Fan speed control switches
- D** Airflow mode control switch
- E** Right-hand side temperature control switch
- F** "OFF" switch

► Front Multi Operation Panel

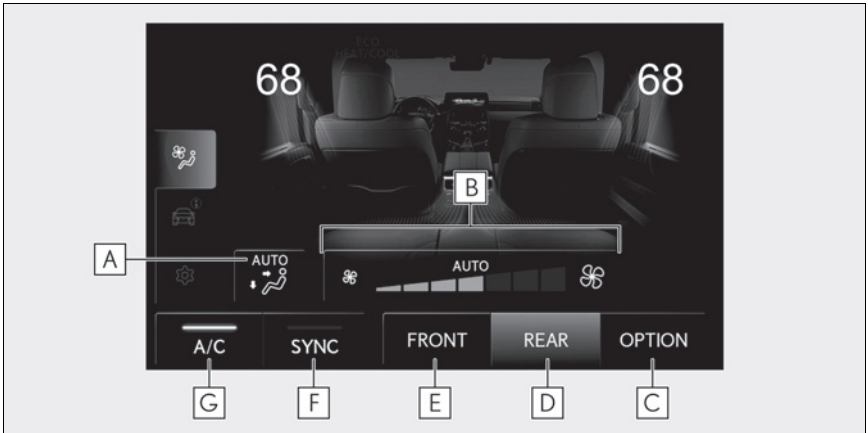

- A** Airflow mode control switch
- B** Fan speed control switches
- C** "OPTION" switch (→P.68)
- D** "REAR" switch
- E** "FRONT" switch (→P.67)
- F** "SYNC" switch
- G** "A/C" switch

Starting Voice Control

Voice control can be started by any of the following operations:

■ Press the talk switch

Press the [] switch (talk switch) on the steering.

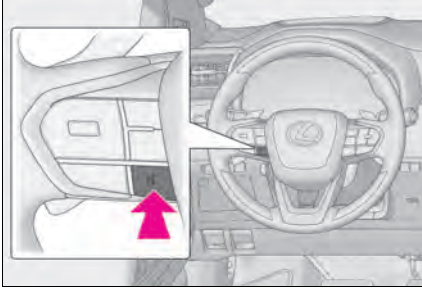

■ Say the wake word

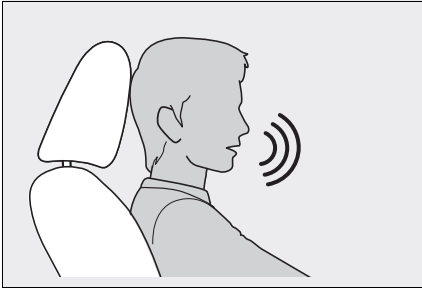

Say any of the following wake-word: "Hey Lexus"

- The wake word can be turned on or off.
- The wake word can be used and then immediately issue a voice command.

Example: "Hey Lexus" "Take me to an Italian restaurant."

■ Touch the microphone button



Touch [] or [] on the screen.

Function list

The following tables list frequently used commands for each function category.

- The functions available may vary according to the system installed.
- Items with subscription will require Intelligent Assistant functionality.

■ Common

Action	Example voice command	Subscription
Shows list of general commands	"Help"	No
Stops the current conversation and re-starts at the beginning	"Start over"	No
Cancels the voice control system	"Cancel"	No

■ Navigation

Intelligent Assistant system enables navigation voice search. This allows you with variety of features such as searching a point of interest (POI), navigate to an address as well as discovering new POIs.

Function	Example voice command	Subscription
Destination search	"Take me to <location category/business name>" "Take me to <an Italian restaurant>" "Take me to <address>" "Take me to <6565 Headquarters drive Plano TX>" "Take me home" "Take me to work"	Yes
Map control	"Map zoom in" "Map zoom out"	Yes
Route information	"Cancel trip"	Yes
Telematics	"Call destination assist"	No

■ Multimedia control

Allows you to engage in a dialog with the Intelligent Assistant to complete various multimedia tasks via voice input.

Function	Example voice command	Subscription
Radio	"Tune to 99.5 FM" "Tune to Rock on FM" "Tune to channel 2 on SiriusXM"	No
Media	"Mute audio" "Next" "Previous"	No
Media Streaming	"Play <artist/album/song/genre/playlist>" "Play <Frank Sinatra>"	Yes

■ Hands-free phone operation

Allows you to engage in a dialog with the Intelligent Assistant to complete various tasks via voice input, such as making a phone call to a contact, or calling Destination Assist.

Function	Example voice command	Subscription
Phone call	"Call <John Smith>" Dial <555 212 1212> "Call back" "Redial"	No
Message	"Send message to <John Smith>" "Read message"	No

■ Screen display switching

Allows you to easily change to various function screen by voice.

Function	Example voice command	Subscription
Navigation	"Show map"	Yes
Phone	"Show recent calls"	No
Multimedia	"Show the FM station list"	No
Settings	"Show display settings"	No

■ Vehicle device control

Allows you to easily change a vehicle setting or activate a function by voice.

Function	Example voice command	Subscription
Climate	"Turn on the air conditioner" "Set the temperature to <70> degrees" "Turn the fan speed up"	No
Illumination*	"Set the illumination to red"	No

*: This function is not available in some countries or areas.

■ Notifications

Offers notifications based on user preferences, vehicle geolocation and learned behavior. Each service can be set to On/Off from the Lexus app.

Function	Detail	Subscription
POI suggestion (Navigation)	Parking suggestions near destination	Yes
Low fuel reminder (Navigation)	Automatically notifies user of low fuel level. If applicable, provides POI list nearby (ahead) or along route and allows user to select and navigate by touch.	Yes

Connecting to the USB Port

Connect a device such as smartphone or portable player.

- Connect the USB cable to the port.

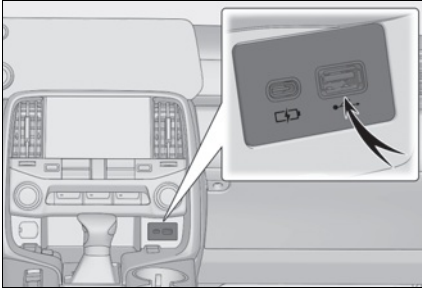

When connecting a USB flash drive, connect it directly to the USB port.

Garage Door Opener

The garage door opener can be programmed using the HomeLink[®] to operate garage doors, gates, entry doors, door locks, home lighting systems, security systems, and other devices.

■ HomeLink[®] programming procedure

The programming procedures can also be found at the following URL.

Website: www.homelink.com/lexus



The word “QR Code” is registered trademark of DENSO WAVE INCORPORATED in Japan and other countries.

For support, contact customer support at the following.

Help Line: 1-800-355-3515

System components

The HomeLink[®] wireless control system in your vehicle has 3 buttons which can be programmed to operate 3 different devices. Refer to the programming methods on the following pages to determine the method which is appropriate for the device.

► Vehicles with inside rear view mirror

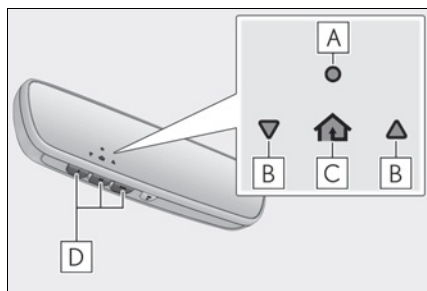

A HomeLink[®] indicator light

B Garage door operation indicators

C HomeLink[®] icon

Illuminates while HomeLink[®] is operating.

D Buttons

► Vehicles with Digital Rear-view Mirror

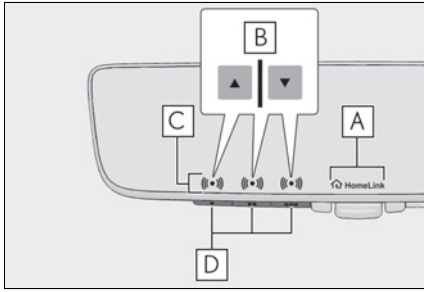

- A** HomeLink® logo
Appears while HomeLink® is operating.
When the menu button is pressed, the logo disappears even while the HomeLink® is operating.
- B** Garage door operation indicators
- C** HomeLink® indicator light
Illuminates above each button selected.
- D** Buttons

Programming the HomeLink®

■ Before programming HomeLink®

- During programming, it is possible that garage doors, gates, or other devices may operate. For this reason, make sure that people and objects are clear of the garage door or other devices to prevent injury or other potential harm.
- It is recommended that a new battery be placed in the remote control transmitter for more accurate programming.
- Garage door opener motors manufactured after 1995 may be equipped with rolling code protection. If this is the case, you may need a stepladder or other sturdy, safe device to reach the “Learn” or “Smart” button on the garage door opener motor.

■ Programming HomeLink®

Steps **1** through **3** must be performed within 60 seconds, otherwise the HomeLink® indicator light will stop flashing and programming will not be successfully completed.

- 1** Press and release the HomeLink® button you want to program and check that the HomeLink® indicator light flashes (orange).
- 2** Point the remote control transmitter for the device at the rear view mirror, 1 to 3 in. (25 to 75 mm) from the HomeLink® buttons.
Keep the HomeLink® indicator light in view while programming.

▶ Vehicles with inside rear view mirror

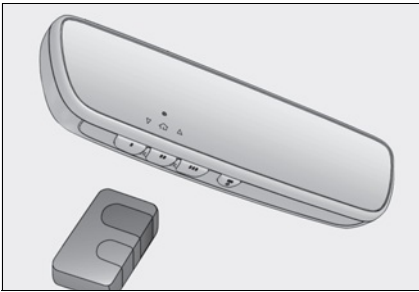

▶ Vehicles with Digital Rear-view Mirror

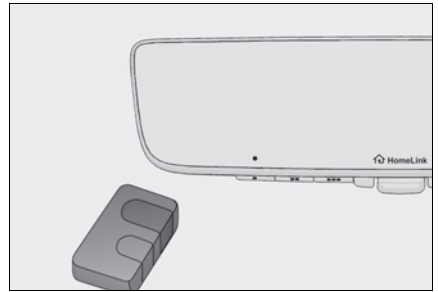

3 Program a device.

▶ Vehicles with inside rear view mirror

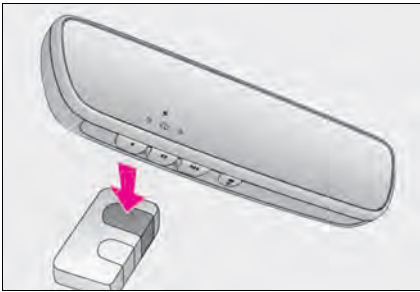

▶ Vehicles with Digital Rear-view Mirror

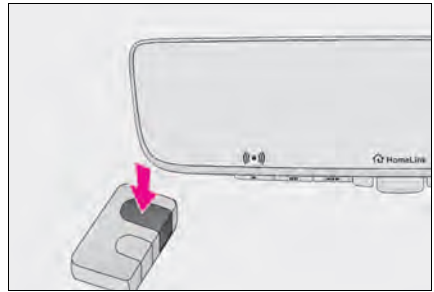

▶ Programming a device other than an entry gate (for U.S.A. owners)

Press and hold the remote control transmitter button until the HomeLink[®] indicator light changes from slowly flashing orange to rapidly flashing green (rolling code) or continuously lit green (fixed code), then release the button.

▶ Programming an entry gate (for U.S.A. owners)/Programming a device in the Canadian market

Press and release the remote control transmitter button at 2 second intervals, repeatedly, until the HomeLink[®] indicator light changes from slowly flashing (orange) to rapidly flashing (green) (rolling code) or continuously lit (green) (fixed code).

4 Test the HomeLink[®] operation by pressing the newly programmed button and observing the indicator light:

- HomeLink[®] indicator light illuminates: Programming of a fixed code device has completed. The garage door or other device should operate when a HomeLink[®] button is pressed and released.
- HomeLink[®] indicator light flashes rapidly: The garage door opener motor or other device is equipped with a rolling code. To complete programming, firmly press and hold the HomeLink[®] button for 2 seconds then release it.
- If the garage door or other device does not operate, proceed to "Programming a rolling code system".

5 Repeat the steps above to program another device for any of the remaining HomeLink[®] buttons.

■ Programming a rolling code system

Two or more people may be necessary to complete rolling code programming.

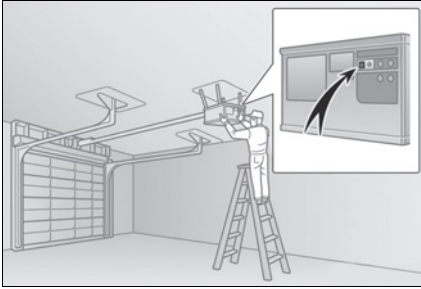

- 1 Locate the “Learn” or “Smart” button on the garage door opener motor in the garage.

This button can usually be found where the hanging antenna wire is attached to the unit. The name and color of the button may vary by manufacturer. Refer to the owner’s manual supplied with the garage door opener motor for details.

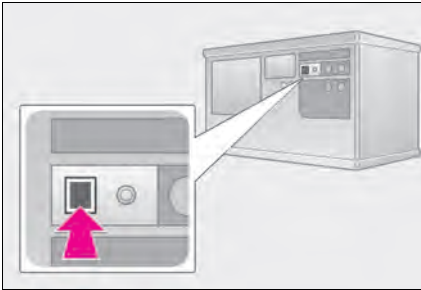

- 2 Press and release the “Learn” or “Smart” button. Perform **3** within 30 seconds after performing **2**.

- 3 Press and hold the desired HomeLink[®] button (inside the vehicle) for 2 seconds and release it. Repeat this sequence (press/hold/release) up to 3 times to complete programming. If the garage door opener motor operates when the HomeLink[®] button is pressed, the garage door opener motor recognizes the HomeLink[®] signal.

▶ Vehicles with inside rear view mirror



▶ Vehicles with Digital Rear-view Mirror



■ Enabling 2-way communication with a garage door (only available for compatible devices)

When enabled, 2-way communication allows you to check the status of the opening and closing of a garage door through indicators in your vehicle.

2-way communication is only available if the garage door opener motor used is a compatible device. (To check device compatibility, refer to www.homelink.com.)

- 1 Within 5 seconds after programming the garage door opener has been completed, if the garage door opener motor is trained to HomeLink[®], both garage door operation indicators will flash rapidly (green) and the light on the garage door opener motor will blink twice, indicating that 2-way communication is enabled.

If the indicators do not flash, perform **2** and **3** within the first 10 presses of the HomeLink[®] button after programming has been completed.

- 2 Press a programmed HomeLink[®] button to operate a garage door.
- 3 Within 1 minute of pressing the HomeLink[®] button, after the garage door operation has stopped, press the “Learn” or “Smart” button on the garage door opener motor. Within 5 seconds of the establishment of 2-way communication with the garage door opener, both garage door operation indicators in the vehicle will flash rapidly (green) and the light on the garage door opener motor will blink twice, indicating that 2-way communication is enabled.

■ Reprogramming a single HomeLink[®] button

When the following procedure is performed, buttons which already have devices registered to them can be overwritten:

- 1 Press and hold the desired HomeLink[®] button.
- 2 When the HomeLink[®] indicator starts flashing orange, release the HomeLink[®] button and perform “Programming HomeLink[®]” **1** (it takes 20 seconds for the HomeLink[®] indicator to start flashing).

Operating HomeLink[®]

Press the appropriate HomeLink[®] button. The HomeLink[®] indicator light should turn on.

Safety Connect (if equipped)

Safety Connect is a subscription-based telematics service that uses Global Positioning System (GPS) data and embedded cellular technology to provide safety and security features to subscribers. Safety Connect is supported by Lexus' designated response center, which operates 24 hours per day, 7 days per week.

Safety Connect service is available by subscription on select, telematics hardware-equipped vehicles.

System components

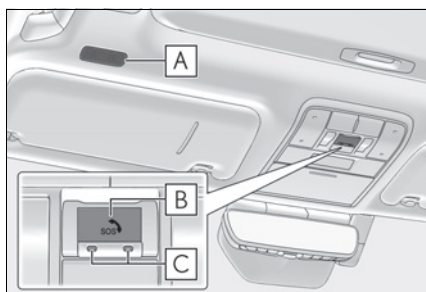

- A** Microphone
- B** "SOS" button
- C** LED light indicators

Services

Subscribers have the following Safety Connect services available:

- **Automatic Collision Notification**

In case of either airbag deployment or severe rear-end collision, the system is designed to automatically call the response center. The responding agent receives the vehicle's location and attempts to speak with the vehicle occupants to assess the level of emergency. If the occupants are unable to communicate, the agent automatically treats the call as an emergency, contacts the nearest emergency services provider to describe the situation, and requests that assistance be sent to the location.

- **Stolen Vehicle Location**

If your vehicle is stolen, Safety Connect can work with local authorities to assist them in locating and recovering the vehicle. After filing a police report, call the Safety Connect response center at 1-800-25-LEXUS (1-800-255-3987) in the United States, 1-877-539-8777 in Puerto Rico or 1-800-265-3987 in Canada, and follow the prompts for Safety Connect to initiate this service.

In addition to assisting law enforcement with recovery of a stolen vehicle, Safety-Connect-equipped vehicle location data may, under certain circumstances, be shared with third parties to locate your vehicle. Further information is available at Lexus.com.

- **Emergency Assistance Button (“SOS”)**

In the event of an emergency on the road, push the “SOS” button to reach the Safety Connect response center. The answering agent will determine your vehicle’s location, assess the emergency, and dispatch the necessary assistance required.

If you accidentally press the “SOS” button, tell the response-center agent that you are not experiencing an emergency.

- **Enhanced Roadside Assistance**

Enhanced Roadside Assistance adds GPS data to the already included warranty-based Lexus roadside service.

Subscribers can press the “SOS” button to reach a Safety Connect response-center agent, who can help with a wide range of needs, such as: towing, flat tire, fuel delivery, etc. For a description of the Roadside Assistance services and their limitations, please see the Safety Connect Terms and Conditions, which are available at Lexus.com.

Subscription

After you have signed the Telematics Subscription Service Agreement and are enrolled, you can begin receiving services.

A variety of subscription terms is available for purchase. Contact your Lexus dealer, call the following or push the “SOS” button in your vehicle for further subscription details.

- **The United States**

1-800-25-LEXUS (1-800-255-3987)

- **Canada**

1-800-26-LEXUS (1-800-265-3987)

- **Puerto Rico**

1-877-539-8777

Remote Connect (if equipped)

The functionality of Remote Connect and Service Connect are made possible by the use of a DCM and a smartphone.

For details about these services, refer to <https://www.lexus.com> (U.S.A.), <https://www.lexus.ca> (Canada) or <https://www.lexus.mx> (Mexico).

Remote Connect

Remote Connect is a smartphone application that lets you view and remotely control certain aspects of your vehicle.

Service Connect (if equipped)

Service Connect uses DCM to collect and transmit vehicle data that allows Lexus to provide:

- Vehicle Health Report (VHR) (Safety Recalls, Service Campaigns, Current Vehicle Alerts, Required Maintenance, and Vehicle Condition Status)
- Maintenance Notifications
- Vehicle Alert Notifications

Door Locks

The vehicle can be locked and unlocked using the entry function, wireless remote control or door lock switches.

For details about the entry function or wireless remote control, refer to P.16, 17.

Unlocking and locking the doors from the inside

■ Using the door lock switches

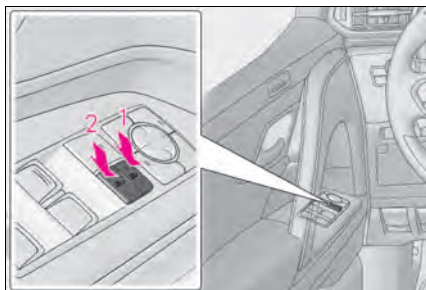

- 1 Locks all the doors
- 2 Unlocks all the doors

■ Inside lock buttons (to lock)

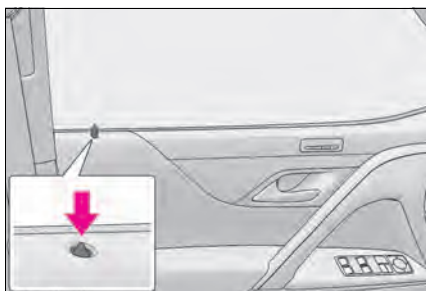

Push down the inside lock button to lock the door.

■ Inside door handles (to unlock)

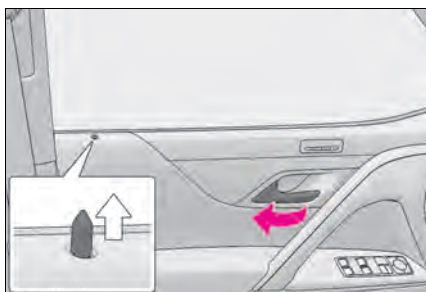

For the front doors:

Pull the handle to unlock and open the door.

When the door is unlocked, the inside lock button will pop up.

For the rear doors:

Pull the handle to unlock the door. Pull the handle a second time to open the door.

When the door is unlocked, the inside lock button will pop up.

Power Windows

Opening and closing the power windows

The power windows can be opened and closed using the switches.

Operating the switch moves the windows as follows:

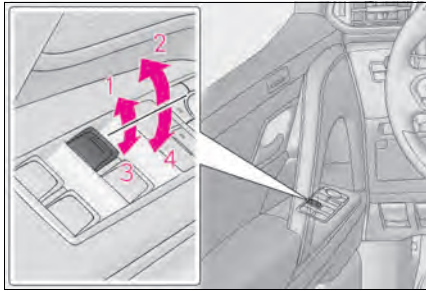

- 1 Closing
- 2 One-touch closing*
- 3 Opening
- 4 One-touch opening*

*: To stop the window partway, operate the switch in the opposite direction.

Preventing accidental operation (window lock switch)

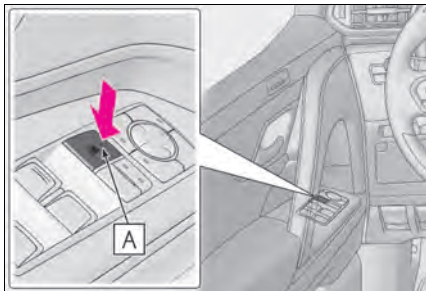

This function can be used to prevent children from accidentally opening or closing a passenger window.

Press the switch.

The indicator **A** will come on and the passenger windows will be locked.

The passenger windows can still be opened and closed using the driver's switch even if the lock switch is on.

Moon Roof

Use the overhead switches to open and close the moon roof and tilt it up and down.

Operating the moon roof

■ Opening and closing

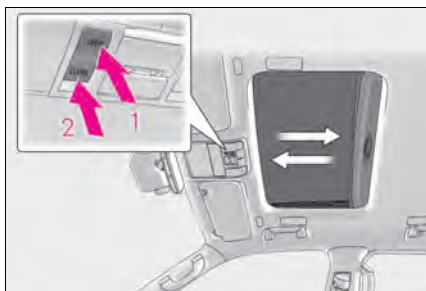

1 Opens the moon roof*

The moon roof stops slightly before the fully open position to reduce wind noise.

Press the switch again to fully open the moon roof.

2 Closes the moon roof*

*: Lightly press either end of the moon roof switch to stop the moon roof partway.

■ Tilting up and down

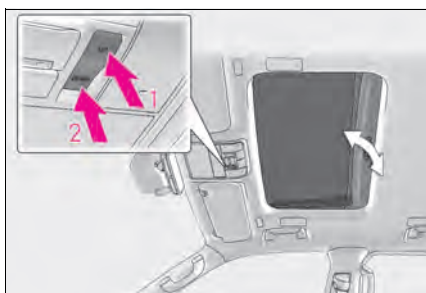

1 Tilts the moon roof up*

2 Tilts the moon roof down*

*: Lightly press either end of the moon roof switch to stop the moon roof partway.

Fuel Tank Cap

Before refueling the vehicle

- Turn the engine switch off and ensure that all the doors and windows are closed.
- Confirm the type of fuel.

Opening the fuel tank cap

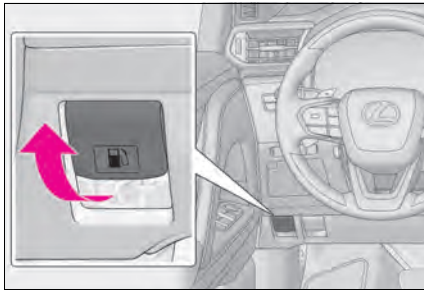

1 Pull the lever.

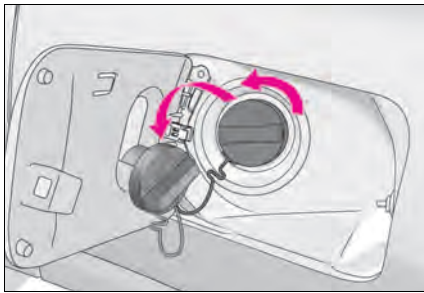

2 Turn the fuel tank cap slowly to open it and put it into the holder on the fuel filler door.

Closing the fuel tank cap

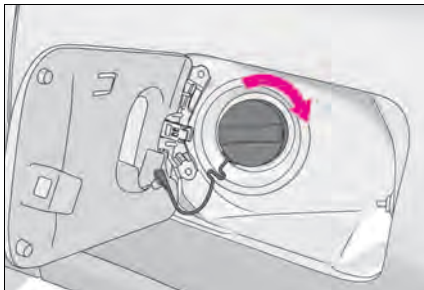

After refueling, turn the fuel tank cap until you hear a click. Once the cap is released, it will turn slightly in the opposite direction.

Back Door

Opening/closing the back door

■ From the inside

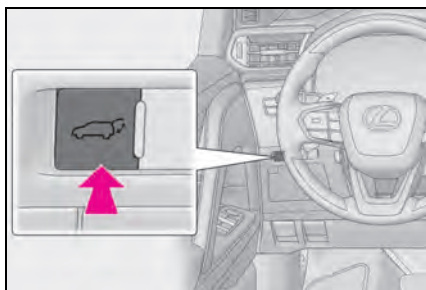

Press and hold the switch.

The power back door automatically opens/closes.

Pressing the switch while the power back door is opening/closing stops the operation.

When the switch is pressed and held again during the halted operation, the back door will perform the reverse operation.

■ From the outside

▶ Wireless remote control

→ P.16

▶ Using the switches on the back door

● Open

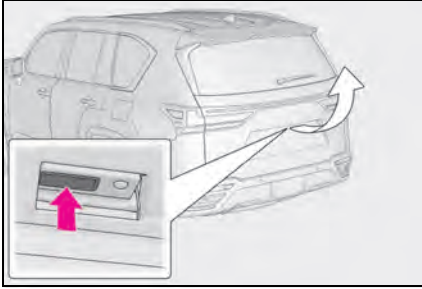

When the back door is unlocked: Press the back door opener switch.

When the back door is locked: While carrying the electronic key on your person, press and hold the back door opener switch.

The power back door automatically opens.

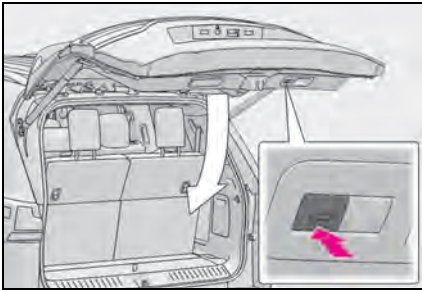

Pressing the switch while the power back door is opening/closing stops the operation.

● Close





Press the  switch on the lower part of the back door.

The power back door automatically closes.

Pressing the  switch while the power back door is operating will stop the operation. When the  switch is pressed again during the halted operation, the back door will perform the reverse operation.

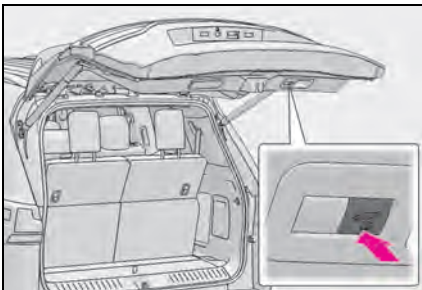
● Close the back door and lock all doors after moving away from the back door (close & lock [Walk-Away] function)



1 Close all of the doors except the back door, carrying an electronic key and press the  switch on the lower part of the back door.

2 While the buzzer is sounding, move away from the back door.

■ Opening/closing the back door using the kick sensor (vehicles with Hands Free Power Back Door)

The Hands Free Power Back Door enables automatic opening and closing of the power back door by putting your foot near the right lower part of the rear bumper and moving it away from the rear bumper. When operating the Hands Free Power Back Door, make sure that all of the following conditions are met.

- The engine switch is in OFF, or ON with the shift lever in P.
- The kick sensor operation is enabled.
- You are carrying an electronic key.

1 While carrying an electronic key, stand within the smart access system with push-button start operation range, approximately 11.8 to 19.7 in. (30 to 50 cm) from the rear bumper.

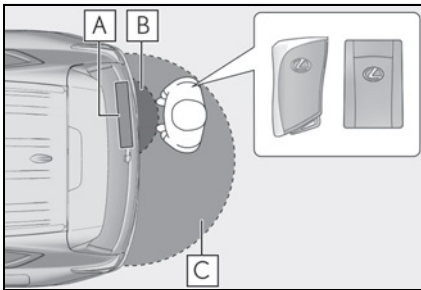

- A** Kick sensor
- B** Hands Free Power Back Door operation detection area
- C** Smart access system with pushbutton start operation detection area

2 Perform a kick operation by moving your foot to within approximately 3.9 in. (10 cm) of the rear bumper, and then pulling your foot back after the buzzer sounds.

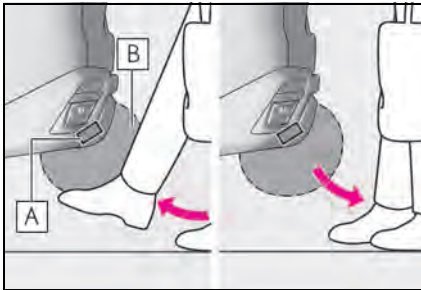

- A** Kick sensor
- B** Hands Free Power Back Door operation detection area

3 When the kick sensor detects that your foot is pulled back, a buzzer will sound and the back door will automatically fully open/close.

What to do if...

List of Warning/Indicator Lights

Immediately stop the vehicle in a safe place and contact your Lexus dealer. Continuing to drive the vehicle may be dangerous.

BRAKE

(U.S.A.)

Brake system warning light



(Canada)

(Red)

Immediately stop the vehicle in a safe place and contact your Lexus dealer.



Charging system warning light



Low engine oil pressure warning light

Have the vehicle inspected by your Lexus dealer immediately.



(Yellow)

Brake system warning light



OFF

BSM OFF indicator



(U.S.A.)

Malfunction indicator lamp



RCTA OFF

RCTA OFF indicator



(Canada)



RCD OFF

RCD OFF indicator



SRS warning light



OFF

Intuitive parking assist OFF indicator

ABS

(U.S.A.)

ABS warning light



OFF

PKSB OFF indicator



(Canada)



Inappropriate pedal operation warning light



(Red)

Power steering system warning light



OFF

Stop & Start cancel indicator



(Yellow)

Power steering system warning light



Slip indicator light



(Flashes or illuminates)

PCS warning light



4LO

Low speed four-wheel drive indicator

(Flashes rapidly)

For further information, refer to the "OWNER'S MANUAL".

What to do if...

Have the vehicle inspected by your Lexus dealer immediately.



(Flashes rapidly)

Center differential lock indicator



(Blinking and then continuously on)

Tire pressure warning light



(Flashes)

Brake hold operated indicator

Follow the correction procedures.



(Orange)

LTA indicator



(Illuminates without blinking)

Tire pressure warning light*



Low fuel level warning light



Driver's and front passenger's seat belt reminder light



(Flashes)

(U.S.A.)

Parking brake indicator



Rear passengers' seat belt reminder light



(Flashes)

(Canada)

Stop and check.

































High coolant temperature warning light

For further information, refer to the "OWNER'S MANUAL".

What to do if...

See the "OWNER'S MANUAL"

	Turn signal indicator		RCD OFF indicator
	(U.S.A.) Headlight indicator		Intuitive parking assist OFF indicator
	(Canada) Tail light indicator		PKSB OFF indicator
	Headlight high beam indicator		Eco Driving Indicator Light
	Automatic High Beam indicator		Stop & Start indicator
	Fog light indicator		Stop & Start cancel indicator
	PCS warning light		Slip indicator light
	LTA indicator		(Flashes)
	(White or green)		VSC OFF indicator
	(Orange)		Downhill assist control system indicator
	Dynamic radar cruise control indicator		Turn Assist indicator
	Cruise control indicator		Crawl Control indicator
	Cruise control "SET" indicator		CRAWL Crawl Control mode display
	BSM outside rear view mirror indicators		Easy access mode indicator
	BSM OFF indicator		4LO Low speed four-wheel drive indicator
	RCTA OFF indicator		

For further information, refer to the "OWNER'S MANUAL".

What to do if...

See the "OWNER'S MANUAL"



Center differential lock indicator



SPORT S mode indicator



(U.S.A.) Parking brake indicator



Sport mode indicator



(Canada)



SPORT S+ mode indicator



Brake hold standby indicator



Custom mode indicator



Brake hold operated indicator



AUTO mode indicator



(U.S.A.) "AIR BAG ON/OFF" indicator lights



DIRT mode indicator



(Canada)



SAND mode indicator



Smart access system with push-button start indicator



MUD mode indicator



Low outside temperature indicator



DEEP SNOW mode indicator



Eco drive mode indicator



ROCK mode indicator



Comfort mode indicator

For further information, refer to the "OWNER'S MANUAL".

- *: It also comes on due to natural causes such as natural air leaks and tire inflation pressure changes caused by temperature. Adjust the tire inflation pressure to the specified level. The light will turn off after a few minutes. In case the light does not turn off even if the tire inflation pressure is adjusted, have the system checked by your Lexus dealer.

What to do if...

If the electronic key does not operate properly

Locking and unlocking the doors

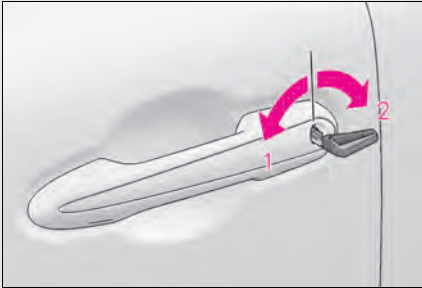

1 Locks all the doors

2 Unlocks the door

Turning the key rearward unlocks the driver's door. Turning the key once again within 5 seconds unlocks the other doors.

What to do if...

Starting the engine

- 1 Ensure that the shift lever is in P and depress the brake pedal.



- 2 Touch the electronic key or card key (if equipped) to the engine switch as shown in the illustration.

When the electronic key is detected, a buzzer sounds and the engine switch will turn to ON.

When the smart access system with pushbutton start is deactivated in customization setting, the engine switch will turn to ACC.

- 3 Firmly depress the brake pedal and check that  is displayed on the multi-information display.
- 4 Press the engine switch shortly and firmly.

In the event that the engine still cannot be started, contact your Lexus dealer.

Replace the battery with a new one. For instructions on replacing the battery, refer to the "OWNER'S MANUAL".

If you need further assistance, contact your Lexus dealer.

What to do if...

If the engine will not start

Make sure that the correct operating procedures have been followed.

Brake pedal

Make sure that the brake pedal is firmly depressed when attempting to start the engine. (→P.18)

If the engine still does not start, see the "OWNER'S MANUAL" for more information or contact your Lexus dealer.



Your Lexus dealer

Your Lexus dealer will provide quality maintenance and any other assistance you may require.

If there is not a Lexus dealer near you, please call the following number:

■ U.S. OWNERS

- In the U.S. mainland or Canada:

Lexus Roadside Assistance

1-800-25-LEXUS or 1-800-255-3987 (Toll-Free)

- In Hawaii:

Servco Automotive Roadside Assistance/Customer Services

1-800-25-LEXUS or 1-800-255-3987 (Toll-Free)

■ CANADIAN OWNERS

- In Canada or the U.S. mainland:

Lexus Roadside Assistance/Customer Service

1-800-26-LEXUS or 1-800-265-3987 (Toll-Free)

Please access our **websites** for further information.

- The U.S. mainland: **www.lexus.com**
- Hawaii: **www.servcolexus.com**
- Canada: **www.lexus.ca**

©2023 TOYOTA MOTOR CORPORATION

All rights reserved. This material may not be reproduced or copied, in whole or in part, without the written permission of Toyota Motor Corporation.



Owner's Manual Quick Guide:

Publication No. OM60V82U

Part No. 01999-60V82

Printed in Japan 01-2310-00 

LX600 Owner's Manual Quick Guide (北米U)