

Content

A-Z



OWNER'S MANUAL.

BMW 7 SERIES.





WELCOME TO BMW.

Owner's Manual.

Thank you for choosing a BMW.

The more familiar you are with the vehicle, the better control you will have on the road. We therefore strongly suggest the following:

Read this Owner's Manual before starting off in your new BMW. Also use the Integrated Owner's Manual in the vehicle. It contains important notes on vehicle operation that will help you make full use of the technical features available in your BMW. The manual also contains information designed to enhance operating reliability and traffic safety, and to contribute to maintaining the value of your BMW.

At the time of production at the plant, the printed Owner's Manual is the most current resource. After a vehicle software update – such as a Remote Software Upgrade – the Integrated Owner's Manual for the vehicle will contain the latest information.

You can find supplementary information in the additional brochures in the onboard literature.

We wish you a safe and enjoyable ride.

TABLE OF CONTENTS

After a vehicle software update – such as a Remote Software Upgrade – the Integrated Owner's Manual for the vehicle will contain the latest information.

! NOTES

Information	6
-------------------	---

🔧 QUICK REFERENCE

Getting in	16
Set-up and use	19
On the road	22

👉 CONTROLS

Dashboard	30
Sensors of the vehicle	35
Operating condition of the vehicle	40
BMW iDrive	44
BMW Remote Software Upgrade	64
Personal settings	68
Opening and closing	74
Seats, mirrors and steering wheel	104
Transporting children safely	120
Driving	126
Displays	141
Light and view	162
Safety	174
Driving stability control systems	212
Driver assistance systems	216
Parking	243
Driving comfort	271
Climate control	274
Interior equipment	290
Storage compartments	300
Cargo area	304

DRIVING TIPS

Things to remember when driving	308
Saving fuel	313

MOBILITY

Refueling	318
Wheels and tires	320
Engine compartment	348
Operating materials	351
Maintenance	358
Replacing components	360
Breakdown Assistance	364
Vehicle Care	372

REFERENCE

Technical data	378
Appendix	380
Everything from A to Z	382

© 2023 Bayerische Motoren Werke

Aktiengesellschaft

Munich, Germany

Reprinting, including excerpts, only with the written consent of BMW AG, Munich.

US English ID8 VI/23, -

Printed on environmentally friendly paper, bleached without chlorine, suitable for recycling.

Information

Using this Owner's Manual

Orientation

The fastest way to find information on a particular topic is by using the index.

For an overview of the vehicle, we recommend reading the Quick Reference Guide in the Owner's Manual.

Validity of the Owner's Manual

Production of the vehicle

At the time of production at the plant, the printed Owner's Manual is the most current resource. Due to updates after the editorial deadline, differences may exist between the printed Owner's Manual and the Integrated Owner's Manual in the vehicle.

Notes on updates can be found in the appendix of the printed Owner's Manual for the vehicle.

After a software update in the vehicle

After a vehicle software update such as via Remote Software Upgrade the Integrated Owner's Manual for the vehicle will contain the latest information.

Owner's Manual for Navigation, Entertainment, Communication

The Owner's Manual for Navigation, Entertainment, and Communication is available as a printed book from an authorized service center.

The topics are also discussed in the Integrated Owner's Manual in the vehicle.

Media at a glance

General information

The contents of the Owner's Manual are available in various media formats. The following Owner's Manual media formats are available:

- ▶ Printed Owner's Manual.
- ▶ Integrated Owner's Manual in the vehicle.

Printed Owner's Manual

The printed Owner's Manual shows all standard, country-specific, and optional equipment that is currently available, or may become available in the future, for specific models.

Integrated Owner's Manual in the vehicle

Principle

The Integrated Owner's Manual shows all standard, country-specific, and optional equipment that is currently available, or may become available in the future, for specific models. The Integrated Owner's Manual can be displayed on the control display.

Selecting the Owner's Manual

1. ■■ Apps menu
2. "All apps"
3. "Owner's Manual"
4. Select the desired method of accessing the contents.

Scrolling through the Owner's Manual

Swipe up or down until the next or previous contents are displayed.

Context help

General information

The Integrated Owner's Manual can be accessed from any menu. Depending on the selected function, either the associated description or the main menu of the Integrated Owner's Manual will be displayed.

Selecting context help from a menu

1. Press and hold the desired menu item.
2. "General help"

Selecting context help from a Check Control message

Directly from the Check Control message on the control display:

"Owner's Manual"

Supplementary Owner's Manuals

Also follow the Supplementary Owner's Manuals, which are included in addition to the on-board literature.

Additional sources of information

Authorized service center

An authorized service center, e.g., a BMW dealer or service center, will be happy to answer any questions you may have.

Internet

Vehicle information and general information on BMW such as on technology are available on the Internet: www.bmwusa.com.

BMW Driver's Guide app

The BMW Driver's Guide app shows all standard, country-specific, and optional equipment that is currently available, or may become

available in the future, for specific models. The app can be displayed on smartphones and tablets.



BMW Driver's Guide Web

The BMW Driver's Guide website shows all standard, country-specific, and optional equipment that is currently available, or may become available in the future, for specific models. The BMW Driver's Guide Web can be displayed in any current browser.

Icons and displays

Icons in the Owner's Manual

Icon Meaning

	Precautions that must be followed in order to avoid the possibility of injury to yourself and to others as well as serious damage to the vehicle.
	Measures that can be taken to help protect the environment.
"..."	Texts in vehicle used to select individual functions.
>...<	Verbal instructions to use with the voice activation system.
>>...<<	Responses generated by the voice activation system.

Action steps

Action steps to be carried out are presented as a numbered list. These steps must be carried out in the order shown.

1. First action step.
2. Second action step.

Bulletpoint lists

Items or actions without strict order or alternative options are shown as a bulletpoint list.

- ▷ First possibility.
- ▷ Second possibility.

Icons on vehicle parts

 This symbol on a vehicle component indicates that further information on the component is available in the Owner's Manual.

Vehicle features and options

This Owner's Manual shows all standard, country-specific, and optional equipment that is currently available, or may become available in the future, for specific models, i.e., model series. Therefore, this Owner's Manual also describes and illustrates equipment, systems and functions that are not available in a vehicle, for example due to the following situations:

- ▷ Selected optional equipment
- ▷ National-market version or national-market equipment
- ▷ Options for later release and software update

This also applies to safety functions and systems.

Before starting a journey, verify whether the described equipment or function is available in the vehicle. For information on whether a function is currently available in the vehicle or when the function can be installed in the vehicle, contact an authorized service center or another qualified service center.

A claim for the availability of equipment, a system or a function in the vehicle cannot be derived based on the description in the Owner's Manual.

When using these functions and systems, the applicable laws and regulations must be observed.

For any equipment and models not described in this Owner's Manual, refer to the Supplementary Owner's Manuals.

An authorized service center is happy to answer any questions that you may have about the features and options applicable to the vehicle.

Status of the Owner's Manual

Basic information

The manufacturer of the vehicle pursues a policy of constant development to ensure that our vehicles continue to embody the highest quality and safety standards. In rare cases, therefore, the features described in this Owner's Manual may deviate from those in the vehicle.

Validity of the Owner's Manual

Production of the vehicle

At the time of production at the plant, the printed Owner's Manual is the most current resource. Due to updates after the editorial deadline, differences may exist between the printed Owner's Manual and the Integrated Owner's Manual in the vehicle.

Notes on updates can be found in the appendix of the printed Owner's Manual for the vehicle.

After a software update in the vehicle

After a vehicle software update such as via Remote Software Upgrade the Integrated Owner's Manual for the vehicle will contain the latest information.

For Your Own Safety

Intended use

Heed the following when using the vehicle:

- ▶ Owner's Manual.
- ▶ Information on the vehicle. Do not remove stickers.
- ▶ Technical vehicle data.
- ▶ The traffic, speed, and safety laws where the vehicle is driven.
- ▶ Vehicle documents and statutory documents.

Warranty

The vehicle is technically configured for the operating conditions and registration requirements applicable in the country of first delivery, also known as homologation. If the vehicle is to be operated in a different country it might be necessary to adapt the vehicle to potentially differing operating conditions and registration requirements. Noncompliance with homologation requirements in a certain country may affect warranty coverage. Please consult the New Vehicle Limited Warranty Booklet for further information on warranty matters.

Maintenance and repairs

Advanced technology, for instance the use of modern materials and high-performance electronics, requires suitable maintenance and repair work.

The vehicle manufacturer therefore recommends having necessary work performed by an authorized service center, e.g., a BMW dealer or service center. If a different repair shop is selected, BMW recommends selecting a workshop that performs the appropriate work such as maintenance and repair according to BMW specifications with properly trained personnel. In the Owner's Manual, such workshops are referred to as "another qualified service center or repair shop".

If work is not carried out properly, for instance maintenance and repair, there is a risk of subsequent damages and related safety risks.

Improperly performed work on the vehicle paintwork can lead to a failure or fault of com-

ponents, e.g., the radar sensors, and thereby result in a safety hazard.

Parts and accessories

BMW recommends the use of parts and accessory products approved by BMW.

Approved parts and accessories, and advice on their use and installation are available from an authorized service center.

BMW parts and accessories have been tested by BMW for their safety and suitability in BMW vehicles.

BMW warrants genuine BMW parts and accessories.

BMW does not evaluate whether each individual product from another manufacturer can be used with BMW vehicles without presenting a safety hazard, even if a country-specific official approval was issued. BMW does not evaluate whether these products are suitable for BMW vehicles under all usage conditions.

California Proposition 65 Warning

For vehicles sold in California, the law requires vehicle manufacturers to provide the following warning:

Warning

Engine exhaust and a wide variety of Automobile components and parts, including components found in the interior furnishings in a vehicle, contain or emit chemicals known to the State of California to cause cancer and birth defects and reproductive harm. In addition, certain fluids contained in vehicles and certain products of component wear contain or emit chemicals known to the State of California to cause cancer and birth defects or other reproductive harm. Battery posts, terminals and related accessories contain lead and lead compounds. Batteries also contain other chemicals known to the State of California to cause cancer. Wash your hands after handling. Used engine oil con-

tains chemicals that have caused cancer in laboratory animals. Always protect your skin by washing thoroughly with soap and water. For more information go to www.P65Warnings.ca.gov/passenger-vehicle.

Warning

Operating, servicing and maintaining a passenger vehicle or off-highway motor vehicle can expose you to chemicals including engine exhaust, carbon monoxide, phthalates, and lead, which are known to the State of California to cause cancer and birth defects or other reproductive harm. To minimize exposure, avoid breathing exhaust, do not idle the engine except as necessary, service the vehicle in a well-ventilated area and wear gloves or wash your hands frequently when servicing the vehicle. For more information go to www.P65Warnings.ca.gov/passenger-vehicle.

Service and warranty

We recommend that you read this publication thoroughly. The vehicle is covered by the following warranties:

- ▶ New Vehicle Limited Warranty.
- ▶ Rust Perforation Limited Warranty.
- ▶ Federal Emissions System Defect Warranty.
- ▶ Federal Emissions Performance Warranty.
- ▶ California Emission Control System Limited Warranty.

Detailed information about these warranties is listed in the New Vehicle Limited Warranty Booklet.

The vehicle has been specifically adapted and designed to meet the particular operating conditions and homologation requirements in your country and continental region in order to deliver the full driving pleasure while the vehicle is operated under those conditions. If you wish

to operate the vehicle in another country or region, you may be required to adapt the vehicle to meet different prevailing operating conditions and homologation requirements. You should also be aware of any applicable warranty limitations or exclusions for such country or region. In such case, please contact Customer Relations for further information.

Maintenance

Maintain the vehicle regularly to sustain the road safety, operational reliability and the New Vehicle Limited Warranty.

Specifications for maintenance measures:

- ▶ BMW maintenance system.
Maintenance, refer to page 358.
- ▶ Maintenance Booklet, available online and accessible via a QR code in the New Vehicle Limited Warranty Booklet.
- ▶ Warranty and Service Guide Booklet for Canadian models.

If the vehicle is not maintained or is improperly maintained, this could result in serious damage to the vehicle.

A failure to maintain the vehicle or improper maintenance may affect your warranty coverage. Please consult the New Vehicle Limited Warranty Booklet for further information on warranty matters.

Refer to section on engine oil change regarding recommended service intervals for oil changes.

Data memory

General information

Electronic control devices are installed in the vehicle. Electronic control units process data they receive from vehicle sensors, self-generate or exchange with each other. Some control units are necessary for the vehicle to function safely or provide assistance while driving,

for instance driver assistance systems. Furthermore, control units facilitate comfort or infotainment functions.

Information about stored or exchanged data can be requested from the manufacturer of the vehicle, in a separate booklet, for example.

Personal reference

Each vehicle is marked with a unique vehicle identification number. Depending on the country, the vehicle owner can be identified with the vehicle identification number, license plate and corresponding authorities. In addition, there are other options to track data collected in the vehicle to the driver or vehicle owner such as via the ConnectedDrive account that is used.

Operating data in the vehicle

Control units process data to operate the vehicle.

For example, this includes:

- ▶ Status messages for the vehicle and its individual components, e.g., wheel RPM, wheel speed, deceleration, lateral acceleration, engaged seat belt indicator.
- ▶ Ambient conditions, e.g., temperature, rain sensor signals.

The processed data is only processed in the vehicle itself while the vehicle is being operated. Data is not stored beyond the operating time.

Electronic components, e.g. control units and vehicle keys, contain components for storing technical information. Information about the vehicle condition, component usage, maintenance recommendations, events or faults can be stored temporarily or permanently.

This information generally documents the state of a component, a module, a system, or the surrounding area, for instance:

- ▶ Operating states of system components such as fill levels, tire pressure, battery status.
- ▶ Malfunctions and faults in important system components, for instance lights and brakes.
- ▶ Responses by the vehicle to special driving situations such as airbag deployment or engagement of the driving stability control systems.
- ▶ Information on vehicle-damaging events.

The data is required to perform the control unit functions. Furthermore, it also serves to detect and correct malfunctions, and helps the vehicle manufacturer to optimize vehicle functions.

The majority of this data is stored temporarily and is only processed within the vehicle itself. In some circumstances the vehicle may store some data for an additional but limited period of time.

When servicing, for instance during repairs, service processes, warranty cases, and quality assurance measures, this technical information can be read out from the vehicle together with the vehicle identification number.

An authorized service center or another qualified service center or repair shop can read out the information. The diagnostic socket required by law in the vehicle is used to read out data.

The data is collected, processed, and used by the relevant organizations in the service network. The data documents technical conditions of the vehicle, which can be used to determine vehicle maintenance status, and facilitate quality improvement.

Vehicle fault and event memories can be reset by an authorized service center or another qualified service center or repair shop when performing repair or servicing work.

Data entry and data transfer into the vehicle

General information

Depending on the vehicle equipment, comfort and individual settings can be stored in the vehicle and modified or reset at any time.

For example, this includes:

- ▶ Settings for the seat and steering wheel positions.
- ▶ Chassis and climate control settings.

If necessary, data can be transferred to the entertainment and communication system of the vehicle, for instance via smartphone.

This includes the following depending on the respective equipment:

- ▶ Multimedia data such as music, films or photos for playback in an integrated multimedia system.
- ▶ Address book data for use in conjunction with an integrated hands-free system or an integrated navigation system.
- ▶ Entered navigation destinations.
- ▶ Data on the use of Internet services.

This data can be stored locally in the vehicle or is found on a device that has been connected to the vehicle, e.g., a smartphone, USB stick or MP3 player. If this data is stored in the vehicle, it can be deleted at any time.

This data is only transmitted to third parties upon personal request as part of the use of online services. The transmission depends on the selected settings for the use of the services.

Incorporation of mobile devices

Depending on the vehicle equipment, mobile devices connected to the vehicle, for instance smartphones, can be controlled via the vehicle control elements.

The sound and picture from the mobile devices can be played back and displayed through the multimedia system. Certain information is

transferred to the mobile devices at the same time. Depending on the type of incorporation, this includes, for instance, position data and other general vehicle information. This optimizes the way in which selected apps, for instance navigation or music playback, work.

There is no further interaction between the mobile device and the vehicle such as active access to vehicle data.

How the data will be processed further is determined by the provider of the particular app being used. The extent of the possible settings depends on the respective app and the operating system of the mobile device.

Services

General information

If the vehicle has a wireless network connection, it will enable data to be exchanged between the vehicle and other systems. The wireless network connection is realized via an in-vehicle transmitter and receiver unit or via personal mobile devices brought into the vehicle, for instance smartphones. This wireless network connection enables 'online functions' to be used. These include online services and apps supplied by the vehicle manufacturer or by other providers.

Services from the vehicle manufacturer

Where online services from the vehicle manufacturer are concerned, the corresponding functions are described in the appropriate place, for instance the Owner's Manual or manufacturer's web page. The relevant legal information pertaining to data protection may also be found on the manufacturer's website. Personal data may be used to perform online services. Data is exchanged over a secure connection, for instance with the IT systems of the vehicle manufacturer intended for this purpose.

Any collection, processing, and use of personal data above and beyond that needed to provide the services must always be based on a

legal permission, contractual arrangement or consent. It is also possible to activate or deactivate the data connection as a whole. This excludes functions and services required by law such as Assist systems.

Services from other providers

When using online services from other providers, these services are the responsibility of the relevant provider and subject to their data privacy conditions and terms of use. The vehicle manufacturer has no influence on the content exchanged during this process. Information on the way in which personal data is collected and used in relation to services from third parties, the scope of such data, and its purpose, can be obtained from the relevant service provider.

Event Data Recorder (EDR)

This vehicle is equipped with an event data recorder (EDR). The main purpose of an EDR is to record, in certain crash or near crash-like situations such as an air bag deployment or hitting a road obstacle, data that will assist in understanding how a vehicle's systems performed. The EDR is designed to record data related to the driving dynamics and safety systems for a short time: max. 30 seconds, typically less.

The EDR in this vehicle is designed to record the following data, for example:

- ▶ How various systems in the vehicle were operating.
- ▶ Whether or not the driver and passenger seat belts were fastened.
- ▶ How far, if at all, the driver was depressing the accelerator and/or brake pedal.
- ▶ How fast the vehicle was traveling.

This data can help provide a better understanding of the circumstances in which crashes and injuries occur.

EDR data is recorded by the vehicle only if a nontrivial crash situation occurs; no data is recorded by the EDR under normal driving conditions and no personal data, for instance name, gender, age, and crash location, are recorded.

However, other parties such as law enforcement could combine the EDR data with the type of personally identifying data routinely acquired during a crash investigation.

To read data recorded by an EDR, special equipment is required, and access to the vehicle or the EDR is needed. In addition to the vehicle manufacturer, other parties such as law enforcement that have the special equipment can read the information if they have access to the vehicle or the EDR.

Vehicle identification number

General information

Depending on the national-market equipment, the vehicle identification number is located in different positions in the vehicle. This chapter describes all possible positions for the series.

Engine compartment

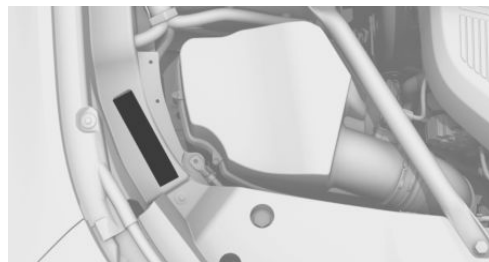

The engraved vehicle identification number can be found in the engine compartment, on the right-hand side of the vehicle.

Right nameplate



The vehicle identification number can be found on the nameplate, on the right-hand side of the vehicle.

Left nameplate



The vehicle identification number can be found on the nameplate, on the left-hand side of the vehicle.

Windshield



The vehicle identification number can also be found behind the windshield.

iDrive

It is also possible to display the vehicle identification number via iDrive.

1. ■■ Apps menu
2. "All apps"
3. "Mobile devices"
4. "Settings"
5. "Vehicle ID (VIN):"

Reporting safety defects

For US customers

The following only applies to vehicles owned and operated in the US.

If you believe that the vehicle has a defect which could cause a crash or could cause injury or death, you should immediately inform the National Highway Traffic Safety Administration (NHTSA), in addition to notifying BMW of North America, LLC, P.O. Box 1227, Westwood, New Jersey 07675-1227, Telephone 1-800-831-1117.

If NHTSA receives similar complaints, it may open an investigation, and if it finds that a safety defect exists in a group of vehicles, it may order a recall and remedy campaign.

However, NHTSA cannot become involved in individual problems between you, your dealer, or BMW of North America, LLC.

To contact NHTSA, you may call the Vehicle Safety Hotline toll-free at 1-888-327-4236 (TTY: 1-800-424-9153); go to <http://www.safercar.gov>; or write to: Administrator, NHTSA, 1200 New Jersey Avenue, SE., Washington, DC 20590. You can also obtain other information about motor vehicle safety from <http://www.safercar.gov>.

For Canadian customers

Canadian customers who wish to report a safety-related defect to Transport Canada, De-

fect Investigations and Recalls, may call the toll-free hotline 1-800-333-0510. You can also obtain other information about motor vehicle safety from <http://www.tc.gc.ca/roadsafety>.





Getting in

Opening and closing

Vehicle key



Buttons on the vehicle key.

Icon	Meaning
	Unlock.
	Lock. Stationary climate control.
	Open the cargo area.
	Panic mode. Pathway lighting.

Access to vehicle interior

Unlocking with the vehicle key

 Press the button on the vehicle key.

If only the driver's door and fuel filler flap have been unlocked due to the settings in place, press the button on the vehicle key again to unlock the other vehicle access points.

Locking with the vehicle key

1. Close the driver's door.
2.  Press the button on the vehicle key. All vehicle access points are locked.

Buttons for the central locking system

Overview

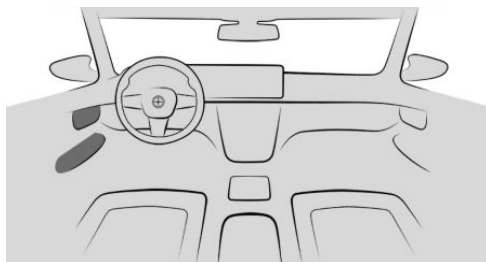

The central locking buttons are located on the front door.

 Lock.

 Unlock.

Locking the vehicle

 Press the button with the front doors closed.

The fuel filler flap remains unlocked.



Unlocking the vehicle

 Press the button.



Panic mode

You can trigger the alarm system if you find yourself in a dangerous situation.

- ▷  Press the button on the vehicle key and hold for at least 3 seconds.
- ▷  Briefly press the button on the vehicle key three times in succession.

To switch off the alarm: press any button.

Access to the cargo area

Opening the cargo area

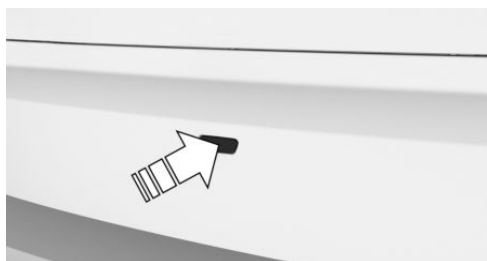

- ▷ Unlock the vehicle and then press the button on the trunk.
- ▷  Press and hold the button on the vehicle key for approx. 1 second. Depending on the setting, the doors may be unlocked.

Closing the cargo area

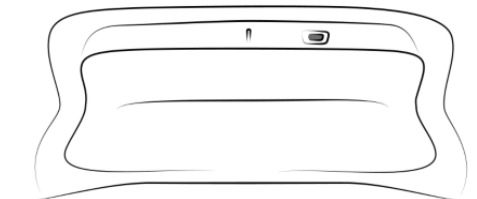

Press the button on the inside of the cargo area.

Displays, control elements

In the vicinity of the steering wheel

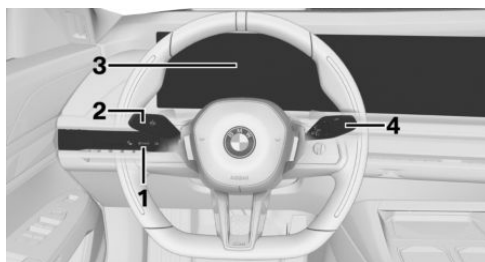

- 1 Light switch
- 2 Turn signal indicator, high beams
- 3 Instrument cluster
- 4 Wipers

Indicator/warning lights

The indicator/warning lights can illuminate in a variety of combinations and colors.

Several of the lights are checked for proper functioning and illuminate temporarily when drive-ready state is turned on.

Driver's door

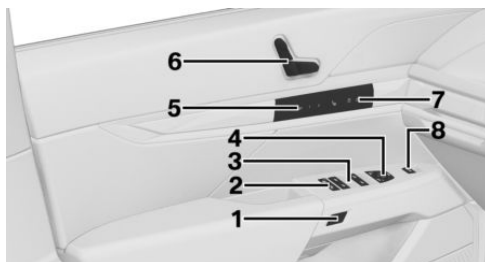

- 1 Opening the door
- 2 Safety switch
- 3 Power windows
- 4 Exterior mirrors
- 5 Seats, comfort features
- 6 Seat setting

- 7 Central locking system
- 8 Cargo area

Switch console

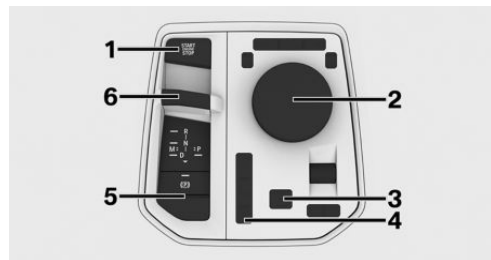



- 1 Start/Stop button
- 2 Controller
- 3 My Modes
- 4 Assistance systems
- 5 Parking brake, Automatic Hold
- 6 Selector lever



BMW iDrive

Principle

BMW iDrive is the vehicle's display and operating concept and includes a wide range of functions.

Buttons on the Controller

Button	Function
	Call up the main menu.
	Go to Media menu.
	Go to Phone menu.

Button	Function
	Go to Navigation menu.
	Go to previous menu.

BMW Intelligent Personal Assistant

Principle

The BMW Intelligent Personal Assistant is a personal assistant that enables natural voice operation of various vehicle functions.

Activating the voice control system

1.  Press the button on the steering wheel briefly.
2. Say the command.

Canceling voice control

- ▶  Press the button on the steering wheel again.
- ▶ >Cancel<
- ▶ Slide the Controller to the right or left.
- ▶ Press the Controller.

Set-up and use

Seats, mirrors and steering wheel

Adjusting seats

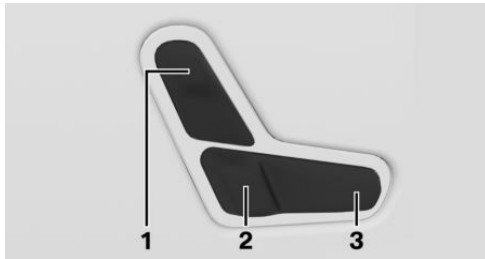

- 1 Backrest tilt/head restraint
- 2 Height/longitudinal direction
- 3 Seat tilt

Adjusting the head restraint

Adjusting the height

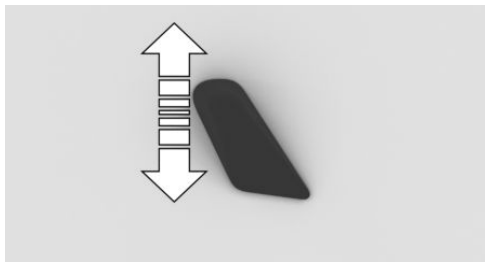

Press switch up or down.

Adjusting the distance



- ▶ Back: press the button and push the head restraint toward the rear.
- ▶ Forward: pull the head restraint toward the front.

After setting the distance, make sure that the head restraint engages correctly.

Adjusting the exterior mirrors



Icon	Meaning
	Fold the exterior mirror in and out.
	Adjust the exterior mirrors.

Icon Meaning



Select left exterior mirror.



Select right exterior mirror.

Adjusting the steering wheel position

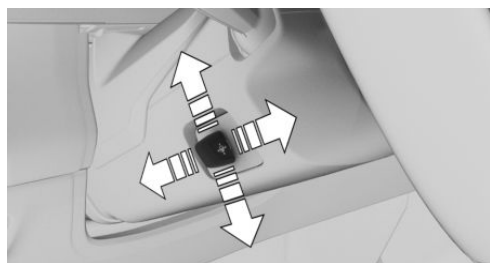

Press the switch to adjust the steering wheel forward/back position and height to the seat position.

Memory function

Principle

The following settings can be stored and, if necessary, retrieved using the memory function:

- ▶ Seat position.
- ▶ Exterior mirror adjustment.
- ▶ Steering wheel position.
- ▶ Lumbar support position.
- ▶ Height of the Head-up display.

Overview

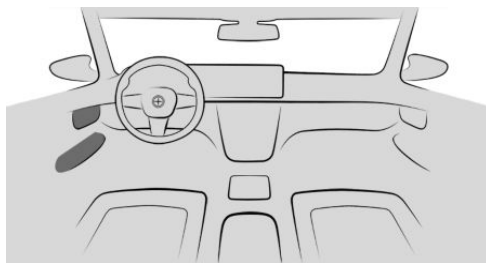

The memory buttons are located on the front doors.

Storing settings

1. Set the desired position.



2. Press the button. The LED illuminates.
3. Press the desired memory button 1 or 2 while the LED is illuminated. A signal sounds.

Calling up settings

Press the desired memory button 1 or 2.

Infotainment

Navigation destination input

1. Navigation menu
2. "Destination input"

A search box and entered information such as the search history are displayed.

3. Select the desired entry or the search box.
4. When selecting the search box, enter characters or choose one of the POI categories displayed.





If necessary, select **OK** to display more information, e.g. to preview a map.

Apply the suggested search keywords as necessary

5. Select the desired entry.
6. "Start guidance"

Entertainment

Depending on the vehicle type, the following buttons are installed on the center console or on the instrument panel:

Button	Function
	Turning the thumbwheel: adjusts the volume. Pressing the thumbwheel: turns sound output on/off.
	Change the entertainment source.
	Press once: changes the station/track.
	Press and hold: fast forward/rewind the track.

Using the mobile phone

General information

After the mobile phone is connected once to the vehicle, the mobile phone can be operated using iDrive and the steering wheel buttons.

Activate Bluetooth® on the mobile phone.

Connecting via Bluetooth®

1.  Apps menu
2. "All apps"
3. "Mobile devices"
4. "Connect new device"
Mobile phones in range are displayed on the control display.
5. Select the desired mobile phone.
6. Compare the control number displayed on the control display with the control number

in the display of the mobile phone, and confirm that they match.

7. If necessary, select the connection mode:
"Use Bluetooth®"

The device is connected and displayed in the device list.

Accepting a call

Depending on the equipment, incoming calls can be answered in several ways.



- ▶ Via iDrive:
 "Accept"



Press the button on the steering wheel.

- ▶ Use the thumbwheel on the steering wheel to select from the list in the instrument cluster: "Accept"

Dialing a number

1.  Communication menu
2. "More"
3. "Dial number"
4. Enter the numbers.
5.  Select the icon. The connection is established via the mobile phone to which this function has been assigned.

On the road

Driving

Drive-ready state

Turning on the drive-ready state



1. Depress the brake pedal.
2. Press the Start/Stop button.

Turning off drive-ready state

1. When the vehicle is stationary, apply the parking brake.
The engine is switched off.
The vehicle switches into standby state.
The READY indicator goes out and a signal tone sounds.
2. Press the Start/Stop button.

Auto Start/Stop function

The Auto Start/Stop function helps save fuel. The system switches off the engine during a stop, for instance in traffic jam or at traffic lights. Drive-ready state remains switched on. The engine starts automatically under the following preconditions:

- ▷ By releasing the brake pedal.
- ▷ When Automatic Hold is activated: step on the accelerator pedal.

Steptronic transmission

Engaging selector lever position D, N, R, S



- ▷ D is drive.
- ▷ N is neutral.
- ▷ Reverse R.
- ▷ S Sport mode.

To prevent the vehicle from moving after engaging drive or reverse, maintain pressure on the brake pedal until you are ready to drive off.

Engage selector lever position R only when the vehicle is stationary.

Sport program: the gearshift behavior is designed for a sportier driving behavior.

Engaging selector lever position P



Press the button.

The transmission lock is engaged and the parking brake is engaged.



Parking brake

Setting the parking brake



Press the button.

The LED on the button and the indicator light in the instrument cluster are illuminated.

The parking brake is engaged and transmission lock is engaged.

Releasing the parking brake



Press button with selector lever position P and activated drive-ready state.

With the brake pedal pressed and drive-ready state switched on, press the button.

The LED and the indicator light go out.

The parking brake is released.

Parking

Make sure the parking brake is engaged.

Light and view

Turn signal, high beams, headlight flasher

Turn signal

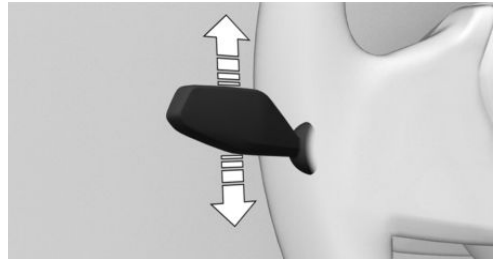

- ▶ Flashing: press the lever past the resistance point.
- ▶ One-touch signaling: lightly tap the lever up or down.
- ▶ Brief flashing: press the lever to the resistance point and hold it there for as long as you want the turn signal to flashing.

High beams, headlight flasher







Press the lever forward or pull it backward.







- ▶ High beams on, arrow 1.
The high beams illuminate when the low beams are switched on.
- ▶ High beams off/headlight flasher, arrow 2.

Lights and lighting

Buttons in the vehicle

Icon	Function
	Exterior lighting menu.
	Automatic headlight control.
	Low beams.
	Exterior lighting off.

Functions via iDrive

Icon	Function
	Automatic headlight control.
	Low beams.
	Parking lights.
	Exterior lighting off.
	Left roadside parking light.
	Right roadside parking light.

Window wiper system

Turning on window wiper system

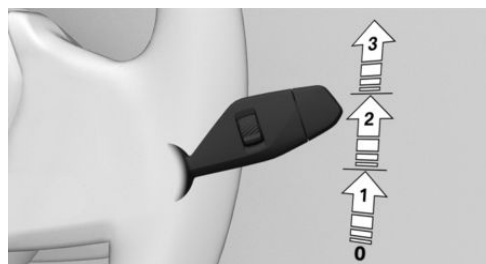

Press the lever up until the desired position is reached.

- ▶ Resting position of the wipers, position 0.
- ▶ Rain sensor, position 1.
- ▶ Normal wiper speed, position 2.
- ▶ Fast wiper speed, position 3.

Turning off the window wiper system and flick wipe

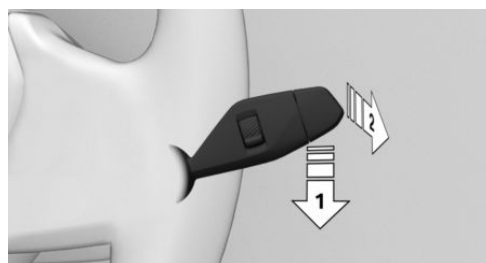

Press the lever down or forward.

- ▶ Turning off: press the lever down, arrow 1, until it reaches the 0 position.
- ▶ Flick wipe: press the lever down from the 0 position, arrow 1, and press the lever in position 0 or position 1 forward, arrow 2. The lever automatically returns to its 0 position when released.

Activating/deactivating rain sensor

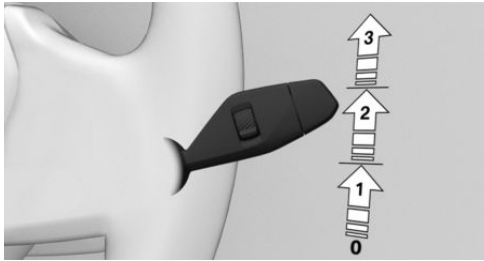

Enable: press lever up once from the 0 position, arrow 1.

Disable: press lever back into the 0 position.

Adjusting the rain sensor sensitivity

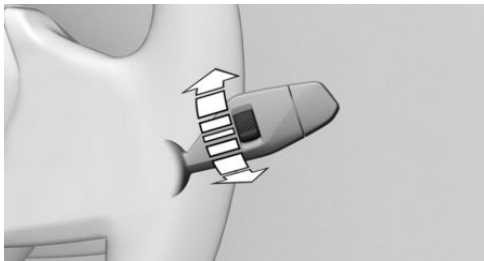

Turn the thumbwheel on the wiper lever.

Cleaning the windshield

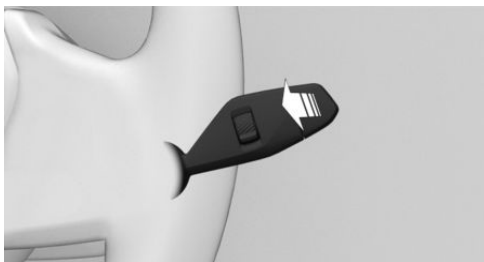















Pull the lever.

Climate control

Climate control functions



Functions in the Climate menu

Icon	Function
	Turn the climate control system on/off.
	Automatic program.
	Temperature.
	Air conditioning.
	Maximum cooling.
	Air recirculation mode.
	Automatic recirculated-air control.
	Fresh air.
	Air flow.
	Air distribution.
	SYNC program.
	Seat heating. Panel heating.

Icon	Function
	Seat cooling.
	Steering wheel heating

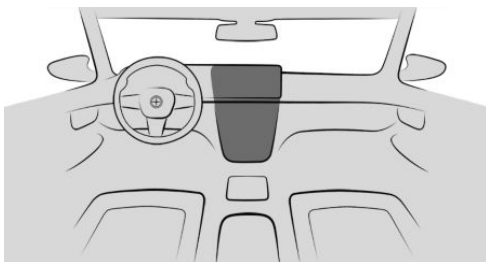





Buttons, automatic climate control

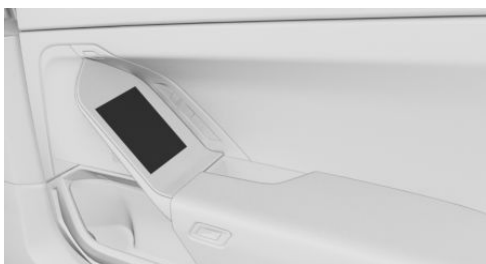

Icon	Function
	Defrost function.
	Rear window defroster.

Rear automatic climate control



Icon	Function
	Turning the rear automatic climate control on/off.
	Automatic program.
	Temperature.
	Air flow.
	Air distribution.
	Seat heating. Panel heating.
	Seat cooling.

Intermediate stop

Refueling

Fuel cap

1. To open the fuel filler flap, press on the rear edge, arrow. The fuel filler flap opens.



2. Turn the fuel cap counterclockwise.

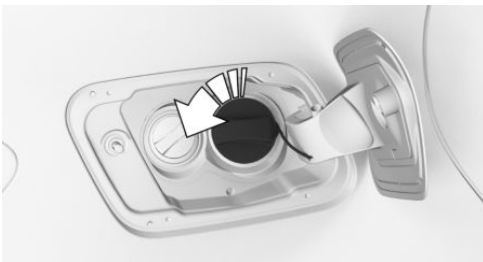

3. Place the fuel cap in the bracket attached to the fuel filler flap.



Wheels and tires

Tire pressure specifications

The tire inflation pressure specifications can be found in the tire inflation pressure table in the printed Owner's Manual.

After correcting the tire pressure

If equipped with a Tire Pressure Monitor, the corrected tire pressures are applied automatically. Make sure that the correct tire settings have been made. With tires that cannot be found in the tire pressure values on the control display, reset the Tire Pressure Monitor (TPM).

If equipped with a flat tire monitor, reinitialize the flat tire monitor.

Checking the tire pressure

Regularly check the tire inflation pressure and correct it as needed:

- ▷ At least twice a month.
- ▷ Before embarking on an extended trip.

Electronic oil measurement

Functional requirements

A current measured value is available after approx. 30 minutes of normal driving with the combustion engine running.

Displaying the engine oil level

1.  Apps menu
2. "Vehicle"
3. "Vehicle status"
4. "Engine oil level"

The engine oil level is displayed.

Adding engine oil

General information

Safely park the vehicle and switch off drive-ready state before adding engine oil.

Adding engine oil

1. Opening the hood.
2. Open the lid counterclockwise.



3. Add engine oil.
4. Close the lid.

Follow the displays on the control display.
A voice connection is established.

BMW Teleservices

Teleservices are services that help to maintain vehicle mobility.

Teleservices can comprise the following services:

- ▶ BMW Roadside Assistance.
- ▶ BMW Accident Assistance.
- ▶ Teleservice Call.
- ▶ An authorized service center.

Providing assistance

Hazard warning system

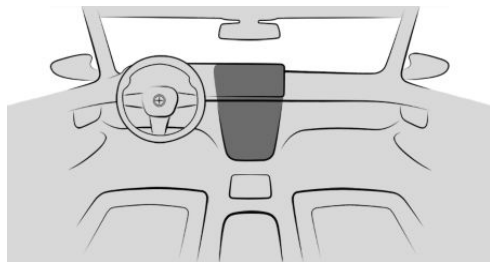

Hazard warning system button

ConnectedDrive

BMW Assistance

Contact BMW Assistance for information and support for all aspects of the vehicle.

1.  Apps menu
2. "All apps"
3. "BMW Assist"
4. Select the desired service.

Dashboard

Vehicle features and options

This chapter describes model-specific equipment, systems, and functions that are currently

available, or may become available in the future, even if they are not present in the vehicle.

Additional information:

Vehicle equipment, refer to page 8.

In the vicinity of the steering wheel

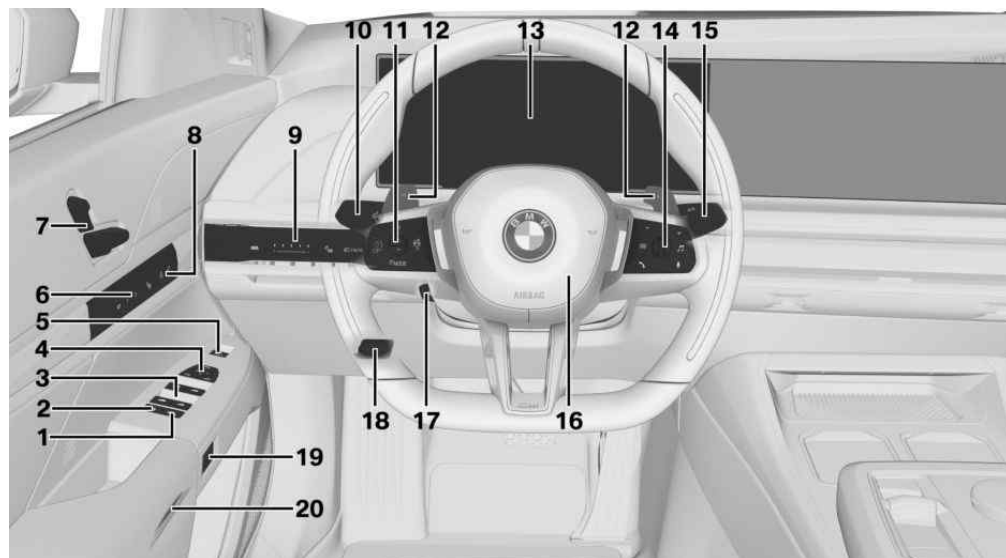

1  Doors and windows menu 47

2  Safety switch 103

3  Power windows 99

4 Exterior mirror adjustment button 115

5  Opening and closing cargo area 86

6 Seating comfort features

 Memory function 118

 Seat settings menu 47

7 Seat setting 104

8 Buttons for central locking system 93

 Unlocking

 Locking

9 Door and lightOpening and closing the door automatically [82](#)Exterior lighting menu [47](#)
Automatic High Beam Assistant [163](#)Driving lights automatic [165](#)
Low beams [165](#)Adaptive lighting functions [168](#)
Exterior lighting off [165](#)**10** Turn signal leverTurn signal [162](#)High beams, headlight flasher [162](#)**11** Steering wheel buttons, leftTurn speed control systems on/off [218](#)Select speed control system [218](#)Store speed [218](#)Set speed [218](#)**12** Shift paddles [131](#)Sport Boost function [133](#)**13** Instrument cluster [141](#)**14** Steering wheel buttons, rightSettings, instrument cluster [141](#)
Settings, Head-up display [143](#)Volume, see Owner's Manual for Navigation, Entertainment and Communication [6](#)Audio, see Owner's Manual for Navigation, Entertainment, Communication [6](#)Voice control, BMW Intelligent Personal Assistant [53](#)Telephone, see Owner's Manual for Navigation, Entertainment and Communication [6](#)Selection of configuration menus for instrument cluster and Head-up display [141](#)Using selection lists [151](#)Accessing and resetting trip data [156](#)Resetting the G-Meter values [158](#)**15** Wiper leverWipers [170](#)Rain sensor [171](#)Cleaning the windshield [172](#)

Horn, entire surface

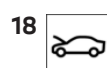
Adjusting the steering wheel [117](#)Unlocking the hood, behind the footwell trim [349](#)

19  Opening the door [93](#)

20  Door emergency unlocking [93](#)

In the vicinity of the center console

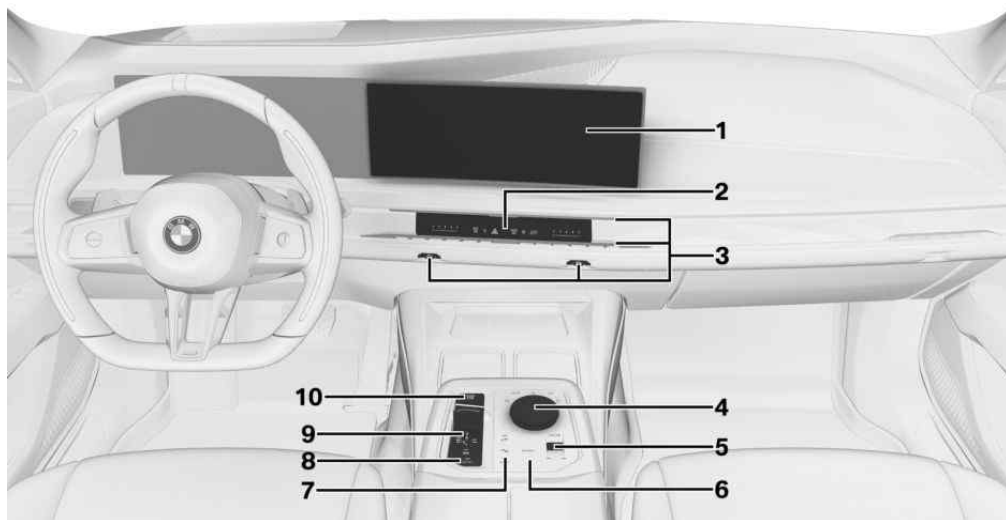

1 Control display [48](#)

2  Hazard warning system [364](#)

 Defrost function [281](#)

 Rear window defroster [282](#)

 Glove compartment [300](#)

3 Ventilation [284](#)

4 Controller with buttons [50](#)







5 Operating elements for entertainment system, see Owner's Manual for Navigation, Entertainment, Communication [6](#)

 Adjusting the volume

 Station/title forward



 Station/title back

6  My Modes [134](#)

- 7  Parking assistance systems [243](#)
-  Vehicle settings menu [47](#)
-  Two-axle ride level control [271](#)
- 8  Automatic Hold [139](#)
-  Parking brake [137](#)
- 9 Selector lever [128](#)
- 10  Turning drive-ready state on/off [126](#)

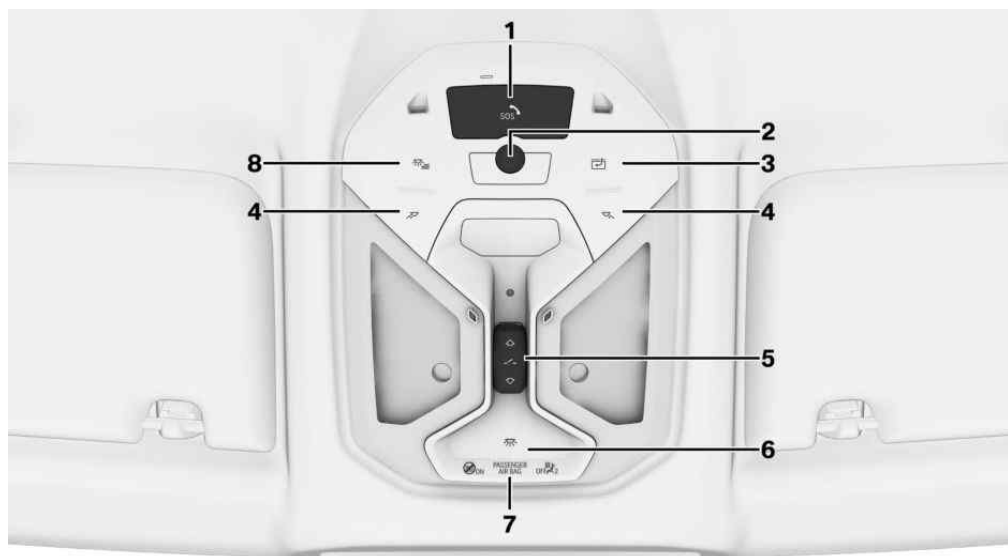
In the vicinity of the headliner



- 1  Emergency Call, SOS [366](#)
- 2 Camera
Gesture control [59](#).
Interior camera [296](#)
- 3  BMW Theater Screen, see Owner's Manual for Navigation, Entertainment, Communication [6](#)
- 4  Reading lights [169](#)

5 Glass sunroof

6  Interior lights [168](#)

7  Indicator light, front passenger
airbag [176](#)

8  Interior lighting menu [47](#)

Sensors of the vehicle

Vehicle features and options

This chapter describes model-specific equipment, systems, and functions that are currently available, or may become available in the future, even if they are not present in the vehicle.

Additional information:

Vehicle equipment, refer to page 8.

Overview

Depending on the equipment, the following cameras and sensors are installed in the vehicle:

- ▶ Front camera.
- ▶ Camera behind the windshield.
- ▶ Top view cameras.
- ▶ Rearview camera.
- ▶ Front radar sensor.
- ▶ Radar sensors, side, front.
- ▶ Radar sensors, side, rear.
- ▶ Ultrasonic sensors in the front/rear bumpers.
- ▶ Ultrasonic sensors, side.

Cameras

Front camera

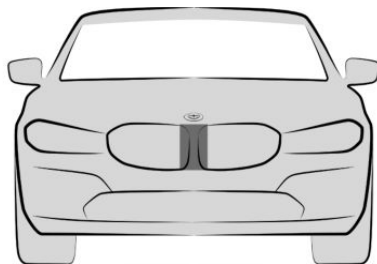

The front camera is located in the radiator grille.

Camera behind the windshield

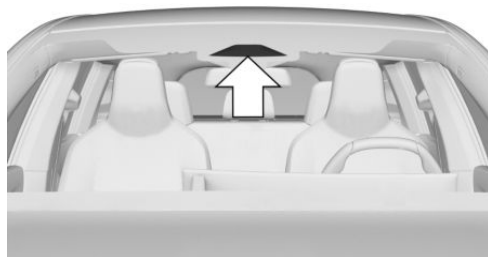

The camera behind the windshield is located near the interior mirror.

Top view cameras

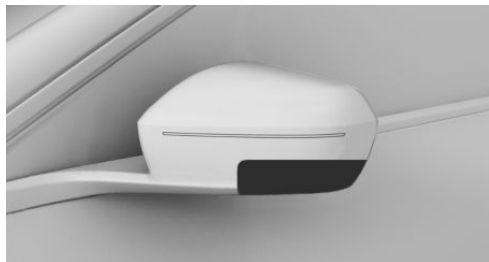

One exterior mirror camera is located at the bottom of each exterior mirror housing.

Rearview camera

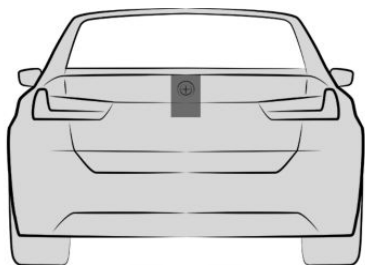

The rearview camera is located in the badge on the rear of the vehicle.

Functional requirement of the cameras

The areas of the cameras are clean and clear.

Additional information:

- ▶ Washing the vehicle, refer to page [372](#).
- ▶ Vehicle care, refer to page [374](#).

System limits of the cameras

The function of the cameras can be limited or may indicate something wrong, for instance in the following situations:

- ▶ In heavy fog, wet conditions, or snowfall.
- ▶ On steep hills, in steep depressions or in tight curves.

- ▶ When the camera field of view is covered, for instance by a fogged up windshield or labels.
- ▶ If the camera lens is dirty or damaged.
- ▶ With exterior mirrors folded in.
- ▶ With open doors or open cargo area.
- ▶ When driving toward bright lights or strong reflections, e.g., because of a setting sun.
- ▶ When it is dark outside.
- ▶ The camera has overheated due to excessive temperatures and temporarily turned off.
- ▶ During calibration of the camera immediately after vehicle delivery.

If applicable, a Check Control message will be displayed when the system limits are reached.

Radar sensors

Safety information

Warning

The vehicle radar sensors and thus also the driver assistance systems can be impaired by external influences, e.g., interference. There is a risk of accident. Watch the surrounding traffic situation closely, be ready to take over steering and braking at any time, and actively intervene where appropriate.

Front radar sensor

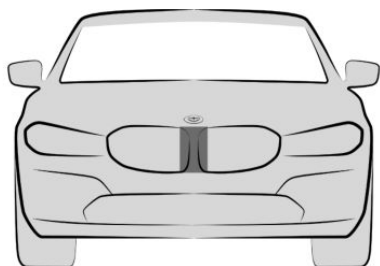

The front radar sensor is located in the radiator grille.

Radar sensors, side, front

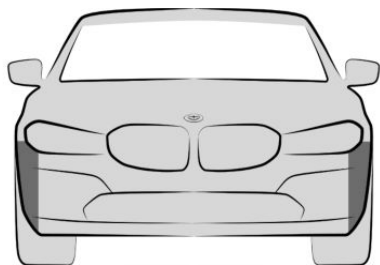

The radar sensors are located to the side in the front bumper.

Radar sensors, side, rear

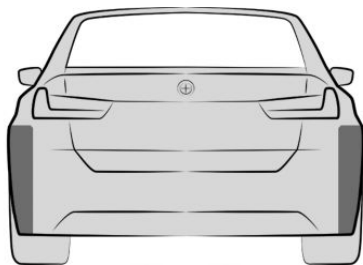

The radar sensors are located on the side in the rear bumper.

Functional requirement of the radar sensors

The areas of the radar sensors are clean and clear.

Additional information:

- ▶ Washing the vehicle, refer to page 372.
- ▶ Vehicle care, refer to page 374.

System limits of the radar sensors

The function of the radar sensors may be restricted or not available, for instance in the following situations:

- ▶ In case of dirty sensors.
- ▶ In case of iced-up sensors.
- ▶ If sensors are covered such as by labels, films or a license-plate carrier.
- ▶ If the sensor is not aligned correctly, for instance due to parking damage.
- ▶ If the radiation range of the sensors is covered, e.g., by protruding cargo.
- ▶ When the field of view of the sensors is covered, e.g., by garage walls, hedges, snow hills, vehicles or trailers.
- ▶ After improper paint work on the vehicle in the area of the sensors.
- ▶ On steep hilltops or in sharp dips in the road.

If applicable, a Check Control message will be displayed when the system limits are reached.

Ultrasonic sensors

Ultrasonic sensors, front

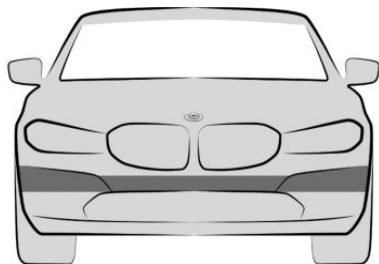

The ultrasonic sensors of the parking assistance systems are located in the front bumper.

Ultrasonic sensors, rear

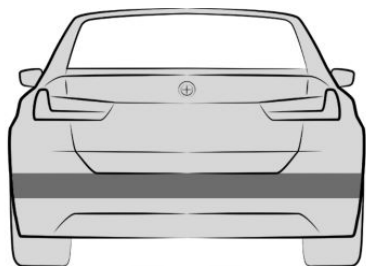

The ultrasonic sensors of the parking assistance systems are located in the rear bumper.

Ultrasonic sensors, side

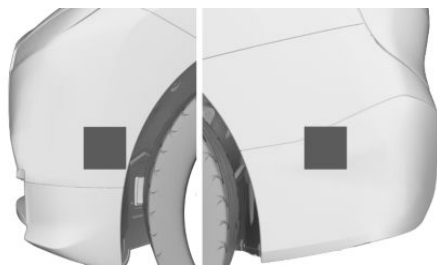

The ultrasonic sensors of the parking assistance systems are located on the side in the front and rear bumpers.

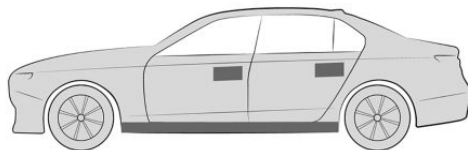

The ultrasonic sensors for the automatic doors are located near the door handles and below the door opening in the sill.

Functional requirement of the ultrasonic sensors

The areas of the ultrasonic sensors are clean and clear.

Additional information:

- ▷ Washing the vehicle, refer to page [372](#).
- ▷ Vehicle care, refer to page [374](#).

System limits of the ultrasonic sensors

The detection of objects with ultrasonic measurements can run into physical limits, e.g., in the following situations:

- ▷ For piles of snow and ice as well as snow-covered objects.
- ▷ If the sensors are dirty or covered, e.g., by stickers.
- ▷ If the sensor is not aligned correctly, for instance due to parking damage.
- ▷ After improper paint work on the vehicle in the area of the sensors.
- ▷ For small children and animals.
- ▷ For persons with certain clothing, for instance jacket.
- ▷ For objects covered by fabric, e.g., tents.
- ▷ With obstacles and persons at the edge of the lane.



- ▷ In case of external interference with the ultrasonics, for instance from passing vehicles, loud machines or other ultrasonic sources.
- ▷ Under certain weather conditions, e.g., high moisture, wet conditions, snowfall, cold, extreme heat, or strong wind.
- ▷ With tow bars and trailer hitches of other vehicles.
- ▷ For handlebars, pedals, or other bicycle or motorcycle attachments.
- ▷ For thin or wedge-shaped objects, e.g., adjacent parked vehicle with open door, pillars turned 45°.
- ▷ With moving objects.
- ▷ With elevated, protruding objects such as ledges.
- ▷ With objects with corners, edges, and smooth surfaces.
- ▷ For objects with fine surfaces or structures, e.g., wire mesh fences, shopping carts, ladders, scaffolding.
- ▷ For objects with porous surfaces.
- ▷ With small and low objects, for instance boxes.
- ▷ For protruding objects, e.g., handles on strollers or wheelchairs, mirrors on adjacent vehicles.
- ▷ For horizontal objects without support structure on ground, e.g., chains, tables.
- ▷ Low objects already displayed, for instance curbs, can be outside of the detection ranges of the sensors.
- ▷ For soft obstacles or obstacles covered with foam, e.g., hoses.
- ▷ With plants and bushes.
- ▷ In automatic car washes.
- ▷ For uneven surfaces, e.g., speed bumps, damaged curbstones.
- ▷ Due to heavy exhaust.
- ▷ Cargo that extends beyond the perimeter of the vehicle is not taken into account by the ultrasonic sensors.

If applicable, a Check Control message will be displayed when the system limits are reached.

Operating condition of the vehicle

Vehicle features and options

This chapter describes model-specific equipment, systems, and functions that are currently available, or may become available in the future, even if they are not present in the vehicle.

Additional information:

Vehicle equipment, refer to page 8.

General information

Depending on the situation, the vehicle is in one of the three states:

- ▷ Idle state.
- ▷ Standby state.
- ▷ Drive-ready state.

Idle state

Principle

When the vehicle is in idle state, it is switched off.

General information

The vehicle is in idle state prior to opening from the outside and after exiting and locking.

Safety information

Warning

An unsecured vehicle can begin to move and possibly roll away. There is a risk of accident. Before leaving the vehicle, secure the vehicle against rolling away.

In order to ensure that the vehicle is secured against rolling away, follow the following:

- ▷ Set the parking brake.
- ▷ On uphill grades or on downhill slopes, turn the front wheels in the direction of the curb.
- ▷ On uphill grades or on downhill slopes, also secure the vehicle, for instance with a wheel chock.

Warning

Unattended children or animals in the vehicle can cause the vehicle to move and endanger themselves and traffic, for example, due to the following actions:

- ▷ Pressing the Start/Stop button.
- ▷ Releasing the parking brake.
- ▷ Opening and closing the doors or windows.
- ▷ Engaging selector lever position N.
- ▷ Using vehicle equipment.

There is a risk of accidents or injuries. Do not leave children or animals unattended in the vehicle. Take the vehicle key with you when exiting and lock the vehicle.

Establishing the sleep mode automatically

The sleep mode is established automatically such as in the following situations:

- ▷ After several minutes, if no operation takes place on the vehicle.
- ▷ If the charge state of the vehicle battery is low.
- ▷ Depending on the configuration via iDrive: one or both front doors will be opened after driving when exiting the vehicle.

In some situations, the idle state is not set automatically, for instance during a phone call or when the low beams are switched on.

Establishing idle state when opening the front doors

After a trip, the sleep mode can be established by opening the front doors. For this purpose, all passengers must exit the vehicle.

1.  Apps menu
2. "Vehicle"
3. "Doors and windows"
4. "Lock/unlock"
5. "Turn off after opening door"

Establishing the sleep mode manually

To establish idle state in the vehicle after completion of trip:



Press and hold the thumbwheel in the center console until the OFF indicator in the instrument cluster goes out.

Deep sleep mode

Principle

Deep sleep mode is activated to prevent the vehicle battery from discharging when the vehicle is stationary for several weeks.

In deep sleep mode, the vehicle functions are limited to the essentials.

Activating deep sleep mode

1.  Apps menu
2. "Vehicle"
3. "System settings"
4. "Deep sleep mode"
5. Select the desired setting.

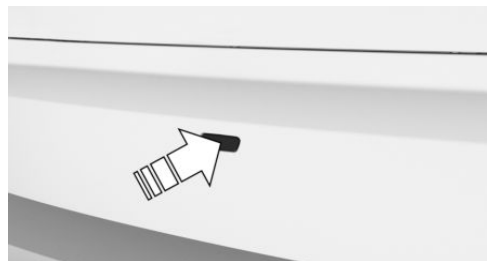

Press the button on the trunk to access the vehicle in deep sleep mode.

Deactivating deep sleep mode

- ▶ Turn off the function on the control display.
- ▶ Driving with the vehicle.

Standby state

Principle

When standby state is switched on, most functions can be used while the vehicle is stationary. Desired settings can be adjusted.

General information

The vehicle is in the standby state after the front doors are opened from the outside.

Manually setting to standby

General information

Standby can be switched back on after the vehicle is automatically set to idle state.

Via thumbwheel



Press thumbwheel in the center console. The control display and the instrument cluster illuminate.

Via start/stop button



Press the Start/Stop button. The control display and the instrument cluster illuminate.

Display in the instrument cluster



OFF is displayed in the instrument cluster. The drivetrain is switched off and standby state switched on.

Drive-ready state

Principle

Turning on drive-ready state corresponds to starting the engine.

General information

Some vehicle functions can only be used with the drive-ready state switched on.

Safety information

DANGER

If the exhaust pipe is blocked or ventilation is insufficient, harmful exhaust gases can penetrate the vehicle. The exhaust gases contain pollutants which are colorless and odorless. In enclosed areas, exhaust gases can also accumulate outside of the vehicle. There is a danger to life. Keep the exhaust pipe free and ensure sufficient ventilation.

Warning

An unsecured vehicle can begin to move and possibly roll away. There is a risk of accident. Before leaving the vehicle, secure the vehicle against rolling away.

In order to ensure that the vehicle is secured against rolling away, follow the following:

- ▷ Set the parking brake.
- ▷ On uphill grades or on downhill slopes, turn the front wheels in the direction of the curb.
- ▷ On uphill grades or on downhill slopes, also secure the vehicle, for instance with a wheel chock.

NOTICE

Repeated attempts to start the engine or repeated starting of the vehicle in rapid succession can cause the starter to overheat. This also results in unburned or inadequately burned fuel, and can cause the catalytic converter to overheat. There is a risk of damage to property. Avoid repeated starting of the vehicle, particularly repeated starting in rapid succession.

Turning on the drive-ready state

General information



Drive-ready state is switched on via the Start/Stop button.

Turning on the drive-ready state

1. Depress the brake pedal.
2. Press the Start/Stop button.

The ignition is activated automatically for a brief time and is stopped as soon as the engine starts.

Most of the indicator/warning lights in the instrument cluster illuminate for a varied length of time.

Gasoline engine

Depending on the motorization, the full drive power may not be available for approximately 30 seconds after starting the engine. In this case, the vehicle will not accelerate as usual.

Additional information:

Power gauge, refer to page [153](#).

Display in the instrument cluster

The activated drive-ready state is indicated in the instrument cluster, depending on the equipment, by the display of information required for driving or the READY display.

Turning off drive-ready state

1. When the vehicle is stationary, apply the parking brake.
2. Press the Start/Stop button.

The engine is switched off. The vehicle switches into standby state.

BMW iDrive

Vehicle features and options

This chapter describes model-specific equipment, systems, and functions that are currently available, or may become available in the future, even if they are not present in the vehicle.

Additional information:

Vehicle equipment, refer to page 8.

Display and operating concept

Principle

BMW iDrive is the vehicle's display and operating concept and includes a wide range of functions.

General information

Depending on vehicle equipment, the functions can be operated as follows:

- ▶ Via the control display.
- ▶ Via the Controller.
- ▶ Via the touchpad.
- ▶ Via the BMW Intelligent Personal Assistant.
- ▶ Via BMW Touch Command.
- ▶ Via the gesture control.
- ▶ Via the operating elements on the steering wheel.

Additional information:

Instrument cluster, refer to page 141.

Safety information

Warning

Operating the integrated information systems and communication devices while driving can distract from surrounding traffic. It is possible to lose control of the vehicle. There is a risk of accident. Only use the systems or devices when the traffic situation allows. As warranted, stop and use the systems and devices while the vehicle is stationary.

Main menu

General information

The main menu is divided into different areas.

Overview

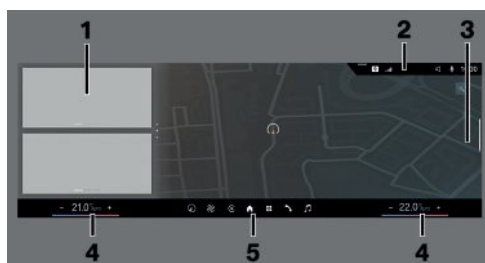

- 1 Widgets
- 2 Status information
- 3 Configuration bar for main display
- 4 Temperature setting
- 5 Menu bar

Menu bar

Menu Apps

 Access to apps and vehicle functions. A filter can be selected. If necessary, change the filter to see the apps you want.

- ▷ "All apps": All apps and functions are displayed.
- ▷ "Infotainment": Only infotainment apps are displayed.
- ▷ "Vehicle": Only vehicle adjustment functions are displayed.
- ▷ "Recently used": The most recently used apps are displayed.

Media menu

 Access to entertainment system functions, e.g., radio stations or external device pairing.

Communication menu

 Access to telephone and message function as well as pairing and management of mobile devices, e.g., smartphones.

Navigation menu

 Access to navigation system, destination entry, and traffic information. Configurable map views and other functions such as points of interest.

Climate menu

 The Climate menu provides access to all climate control functions.

Apple CarPlay® menu

 Depending on national-market version with associated function: Access to Apple CarPlay. Apple CarPlay enables the secure use of certain functions of a compatible Apple iPhone via iDrive.

Android Auto® menu

 Depending on national-market version with associated function: Access to Android Auto. Android Auto enables the secure use of certain functions of a compatible Android smartphone via iDrive.

Widgets

Widgets show real-time information and dynamic content such as current media or paired smartphones. The widgets also serve as buttons and allow jumping to the relevant menu.

Main display



The main display shows real-time information and dynamic content such as the navigation map. This display also contains buttons and lets you jump to the desired menu.

Status information



General information

The status field can be found in the upper area of the control display. Status information is displayed in the form of icons. Depending on the equipment and national-market version, different icons are available.

Telephone status information

Icon	Meaning
	Active call.
	Signal strength.
	SIM card missing.

Entertainment status information

Icon	Meaning
	USB audio.
	Bluetooth audio.
	Smartphone audio.



Icon	Meaning
	Connected Music with Spotify.
	Time shift.
	Wi-Fi.
	Apple CarPlay.
	Android Auto.
	Satellite radio is switched on.

Status information messages

Icon	Meaning
	Number of notifications.
	Check Control message.
	Suppress private information.
	Do not disturb.
	Message.

Additional information:

Owner's Manual for Navigation, Entertainment, and Communication, refer to page 6.

Other status information

Icon	Meaning
	Sound output active.
	Sound output deactivated.
	Activation word active.
	BMW ID or driver profile.
	Destination guidance active.
	Go to quick access.
	Wireless charging active.
	Park Distance Control: sound active.
	Park Distance Control: sound deactivated.

Input and display

Letters and numbers

Letters and numbers can be entered using the controller, touchpad, control display, or voice control, depending on vehicle equipment.

Icon	Function
	Change between capital and lower-case letters.
	Enter a blank space.
	Switching between languages.
	Use voice control.
	Confirm entry.
	Shift the input area to the left or right.

Entry comparison

When entering data from a database such as contacts, the selection is gradually narrowed down for each character entered, with characters being added as necessary.

Activating/deactivating the functions

Some menu items are preceded by an icon. Selecting the menu item enables or disables the function.

Icon	Meaning
	Function is activated.
	Function is deactivated.

Enabling/disabling audible feedback

For some functions, audio confirmation is given, e.g., sounds are emitted when operating the control display.

- Apps menu
- "Vehicle"
- "System settings"

- "Sound"
- Select the desired setting.

Quick access

The quick link provides access to shortcuts, certain settings, and app recommendations.

Input	Operation
Show	Swipe from top to bottom on the quick link. Slide the controller up. — Tap the icon on the status bar.
Hide	Swipe from the bottom up on the quick link. Slide the controller down.

Activating/deactivating pop-ups

For some functions, pop-ups are displayed automatically on the control display. Some of these pop-ups can be activated or deactivated.

-  Apps menu
- "Vehicle"
- "System settings"
- "Pop-ups"
- Select the desired setting.

Shortcuts

General information

The iDrive functions can be stored on the shortcuts and called up directly, for instance radio stations, navigation destinations, phone numbers and menu entries.

Storing a function

- Select the desired function.
- Press and hold the desired function.
- "Add to shortcuts"

Shortcuts can only be created with an active BMW ID or a driver profile.

Executing a function

- Swipe from top to bottom on the control display.
- Tap the desired shortcut.

The function will work immediately. This means for instance that the connection is established when a phone number is selected.

Deleting shortcuts

- Swipe from top to bottom on the control display.
- Press and hold the desired shortcut.
- "Delete shortcut"

Direct access

General information

The vehicle has buttons that can be used to access menus for the respective function directly on the control display. Then continue the operation via iDrive.

Overview

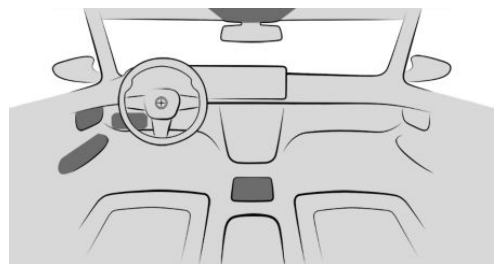

Button Function

 Go to the Driving Settings menu.

 Go to the Exterior Lighting menu.

 Go to the Interior Lighting menu.

 Go to the Seat Settings menu.

 Go to the Doors and Windows menu.

Overview



- 1 Instrument cluster 141
- 2 Control display 48

Control display

Principle

The iDrive functions are displayed on the control display.

Safety information

Warning

Devices connected to the vehicle via a cable such as mobile phones or loose objects can be thrown through the vehicle interior while driving such as in the event of an accident, braking or evasive maneuver. There is a risk of injury and risk of damage to property. Secure loose objects or devices that are connected to the vehicle via a cable.

Warning

Objects in the area in the front of the control display can slip and damage the control display. There is a risk of injury or risk of damage to property. Do not place objects in the area in front of the control display.

BMW Curved Display

Principle

The BMW Curved Display is a single-screen display in the instrument panel that is curved towards the driver. The BMW Curved Display comprises the instrument cluster on the driver's side and the control display.

General information

Follow instructions for cleaning the BMW Curved Display in the Care chapter.

Additional information:

Caring for special components, refer to page 375.

Overview

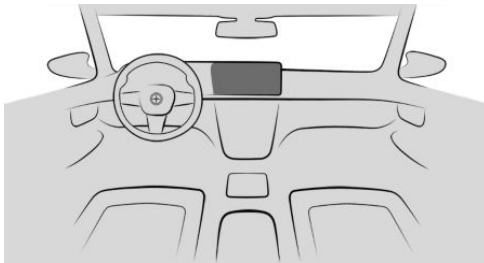

Control display

Switching the control display on/off automatically

The control display is turned on automatically when the vehicle is unlocked or as soon as the control display is needed for operation.

In certain situations, the control display is switched off automatically, for instance if no operation is performed on the vehicle for several minutes.

Switching the control display on/off manually

1. Swipe from top to bottom on the control display.
2. "Screen off"

Tap the control display to turn it on again.

Setting the brightness

1.  Apps menu
2. "Vehicle"
3. "Displays"
4. "Control display"
5. "Brightness at night"
6. Make the desired setting.

Depending on the light conditions, the brightness control may not be clearly visible.

System limits

In the case of very high temperatures on the control display, for instance due to intense solar radiation, the brightness may be reduced down to complete deactivation. Once the temperature is reduced, for instance through shade or air conditioning system, the normal functions are restored.

Controller

Principle



The Controller can be used to select menu items and enter the settings. The buttons can be used to open the menus directly.

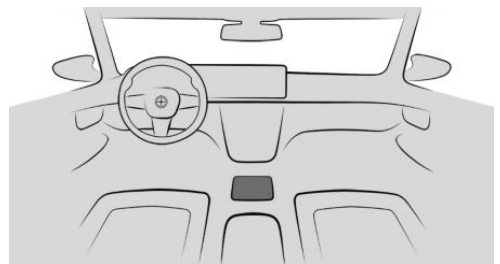

Overview



Controller

Buttons on the Controller

Button	Function
	Call up the main menu.
	Go to Media menu.
	Go to Phone menu.

Button	Function
	Go to Navigation menu.
	Go to previous menu.

Operation

- ▶ Rotate the Controller to switch between menu options, for example.

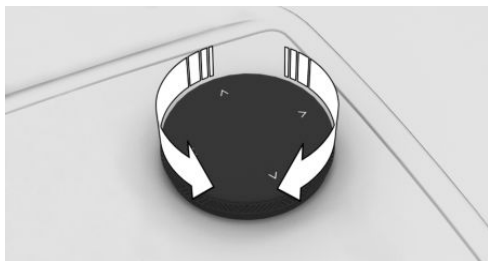

- ▶ Press the Controller to select a menu option, for example.

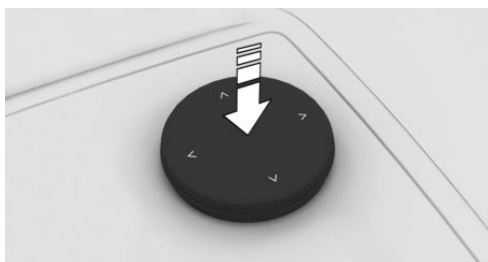

- ▶ Slide the Controller in four directions to switch between menus, for example.

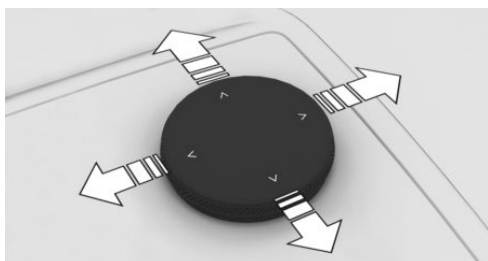

Operating via the Controller

Opening the main menu

- ▶  Press the button.

The main menu is displayed.

Selecting menu items

1. Turn the Controller until the desired menu item is highlighted.
2. Press the Controller.

Adjusting the main display

The main display can be adjusted in the main menu.

1.  Press the button.
2. If necessary, tilt the Controller to select the main display.
3. Tilt the Controller to the right.
4. Select the desired main display.

Selecting a widget

1. Use the Controller to select widgets.
2. If necessary, turn the Controller until the desired widget is selected.
3. Press the Controller.

Switching between menus

A new display opens after a menu item is selected.

- ▶ Slide the Controller to the left.
The current menu closes and the previous menu is displayed.

- ▶  Press the button.

The current menu closes and the previous menu is displayed.

Entering letters and numbers



Input

1. Turn the Controller: select letters or numbers.
2. **OK** : confirm entry.

Additional information:

Setting the system language, refer to page 55.

Deleting an entry

Icon	Function
	Press Controller: delete a letter or number.
	Hold the Controller down: delete all letters or numbers.

Using alphabetical lists

For alphabetical lists with more than 30 entries, the letters for which an entry exists can be displayed in a text box.

1. Turn the Controller to the left or right quickly.
2. Select the first letter of the desired entry.
The first entry of the selected letter is displayed in the list.

Operation via touchpad

General information

Depending on vehicle equipment, some iDrive functions can be operated with the controller touchpad.

The touchpad is located on the Controller. Touch the touchpad with your fingers. Do not use any objects.

Selecting functions

1.  Apps menu
2. "Vehicle"
3. "System settings"
4. "Touchpad"
5. Select the desired setting.

Entering letters and numbers

- ▶ Enter characters as they are displayed on the control display.
- ▶ Always enter associated characters such as accents or periods so that the letter can be clearly recognized.
- ▶ The set language determines what input is possible. Where necessary, enter special characters via the Controller.

Additional information:

Setting the system language, refer to page 55.

Entering special characters

Function	Operation
Delete a character.	Swipe to the left on the touchpad.
Enter a blank space.	Swipe to the right in the center of the touchpad.
Enter a hyphen.	Swipe to the right in the upper area of the touchpad.
Enter an under-score.	Swipe to the right in the lower area of the touchpad.

Using the map

The map in the navigation system can be moved via the touchpad.

Tap the map on the control display and then continue operation using the touchpad.

Function	Operation
Move map.	Swipe in the appropriate direction.
Display menu.	Tap once.

Using alphabetical lists

Alphabetical lists with more than 30 entries permit a direct jump to letters for which an entry exists.

Enter the first letter on the touchpad.

The first entry of the entered letter is displayed in the list.

Operation via control display

General information

Depending on the equipment version, the control display is equipped with a touchscreen.

You can tap on menu items and widgets. Touch the control display with your fingers. Do not use any objects.

Opening the main menu

 Tap on the icon.

The main menu is displayed.

Adjusting the main display

The main display can be adjusted in the main menu.

-  Tap on the icon.
- Swipe the configuration bar on the right side of the screen to the left.
- Select the desired main display.

Sorting apps

To resort the app icons, press and hold the desired icon and move it to the desired location.

Switching between menus

A new display opens after a menu item is selected.

◀ Select the arrow symbol.

The current menu closes and the previous menu is displayed.

Calling up the context menu

Depending on the menu item, a context menu with additional options can be displayed.

Press and hold the desired menu item.

The menu consists of various areas, for instance:



- ▶ "General help": Go to the Integrated Owner's Manual.
- ▶ "Add to shortcuts": define menu item as shortcut.

Entering letters and numbers

Input

- If necessary, tap the  icon or control display.
- Enter desired letters and numbers.

Deleting an entry

Icon	Function
	Tap icon: delete a letter or a number.
	Press and hold the icon: delete all letters or numbers.

Using the map

The navigation map can be moved on the control display.

Function	Operation
Move map.	Swipe in the appropriate direction.
Enlarge/shrink map.	Drag in or out with the fingers.
Display menu.	Tap once.

Using alphabetical lists

For alphabetical lists with more than 30 entries, the letters for which an entry exists can be displayed in a text box.

1. Tap the letter in front of the list.
A letter box is displayed.
2. Tap the first letter of the desired entry.
The first entry of the selected letter is displayed in the list.

BMW Intelligent Personal Assistant

Principle

The BMW Intelligent Personal Assistant is a personal assistant that enables natural voice operation of various vehicle functions. The Personal Assistant makes it easier to operate the vehicle by providing proactive suggestions and automating habits.

General information

- ▶ BMW Intelligent Personal Assistant is available depending on national-market version.
- ▶ The system includes special microphones on the driver side and front passenger side.
- ▶ Say the commands and numbers fluently as well as with normal volume, emphasis, and speed.
- ▶ >...< identifies commands that can be spoken.

Functional requirements

- ▶ A language that is supported by the Personal Assistant must be set via iDrive. Setting the system language, refer to page 55.
- ▶ Always say commands in the configured system language.

For the full range of functions, you must activate, configure, or purchase the following functions:

- ▶ Online speech processing, refer to page 56.
- ▶ For all settings under Data protection, refer to page 68.
- ▶ Activation word, refer to page 54.
- ▶ BMW ID or a driver profile.
- ▶ Relevant ConnectedDrive services from the ConnectedDrive Store.
- ▶ Get suggestions, refer to page 56.

Activating the voice control system

General information

There are various methods for activating the voice control feature:

- ▶  Press the button on the steering wheel briefly.
The microphone on the driver's side is active.
- ▶ Speaking the activation word.
The microphones on the driver's or front passenger's side are active with the following voice control, depending on where the activation word was spoken.

Then say the command. The activation word and the command can be spoken without pause in one sentence.

Microphone button on steering wheel



1. Press button briefly.
2. Say the command.

Activation word

General information

Saying the activation word will start the Personal Assistant. The Personal Assistant listens.

Preset activation word

>Hello BMW<: The default activation word can be activated and deactivated.

1.  Apps menu
2. "Vehicle"
3. "System settings"
4. "Voice control"
5. "Personal Assistant (BMW)"
6. "Wake word"
7. ""Hello BMW""

Personal activation word

In addition to the preset activation word, a personal activation word can be set up with an active BMW ID or a driver profile. The personal activation word can also be changed or deleted.

The activation word should consist of multiple syllables to ensure good recognition.

>Hello<: The additional phrase is not necessary for the activation word and does not need to be spoken.

1.  Apps menu
2. "Vehicle"
3. "System settings"
4. "Voice control"
5. "Personal Assistant (BMW)"
6. "Wake word"

7. "Personal wake word"
8. "Set"
9. "Start recording"

Activation word from third-party providers

Depending on the national-market version, some third-party providers provide digital voice assistants such as Siri or Amazon Alexa.

To use Siri, the smartphone must be connected via Apple CarPlay.

The activation word from connected third-party providers can be used in addition to your preset or personal activation word from BMW.

1.  Apps menu
2. "Vehicle"
3. "System settings"
4. "Voice control"
5. Select the desired voice assistant.
6. Select the desired setting.

Canceling voice control



- ▶ Press the button on the steering wheel again.
- ▶ >Cancel<
- ▶ Slide the Controller to the right or left.
- ▶ Press the Controller.

Possible commands

General information

Commands can be used to give instructions or ask questions, with the Personal Assistant providing assistance.

For example, you can call contacts, navigate to an address, apply settings, or ask questions about a vehicle function. Most vehicle functions can be operated via voice commands, e.g., the Automatic Parking Assistant.

Most content on the control display can be spoken as commands, e.g., menu items or list entries.

Help for voice control

- ▶ ›Voice commands‹: have possible example commands suggested.
- ▶ ›General information on voice control: have information on the operating principle of the voice control announced.
- ▶ ›Help‹: have tips and example commands for voice control announced.
- ▶ Additional example commands for the current context are displayed in the widget of the BMW Intelligent Personal Assistant.

Sample commands

- ▶ ›Call John Smith‹
- ▶ ›Drive me to JFK airport‹
- ▶ ›Play a classical music station‹
- ▶ ›Is my tire pressure still OK?‹
- ▶ ›Activate the climate control‹
- ▶ ›Increase the ACC distance‹
- ▶ ›Sport mode‹

Additional example commands can be displayed on the control display.

1.  Apps menu
2. "All apps"
3. "Personal assistant"
4. "Help"
5. "Example commands"

Sample commands for the current context are displayed in the BMW Intelligent Personal Assistant widget.

Additional information:

Adjust widgets, refer to page [52](#).

Menu items

The Personal Assistant can bring up menu items directly. Say the menu items as they are

displayed on the control display. You do not have to follow the order of the menu items when speaking them out loud.

1. Activate the voice control system.
2. ›Media‹
3. ›Presets‹

The stored stations are displayed on the control display.

Owner's Manual via voice operation

You can ask simple questions about vehicle functions and the operation of the vehicle.

The voice activation system and the feedback it provides do not replace the printed or Integrated Owner's Manual. The function is available depending on the national-market version. The speech recognition and quality of the feedback may vary.

Example command: ›How can the passenger airbag be deactivated?‹

The Personal Assistant returns feedback. When stationary, the section of the integrated Owner's Manual is displayed on the control display.

Settings

Setting the system language

1.  Apps menu
2. "Vehicle"
3. "System settings"
4. "Language"
5. Select the desired setting.

Setting the response length

You can set the Personal Assistant to use standard dialog or a short version. In case of the short version, the announcements by the

Personal Assistant are played back in an abbreviated version.

1.  Apps menu
2. "Vehicle"
3. "System settings"
4. "Voice control"
5. "Personal Assistant (BMW)"
6. "Response length"
7. Select the desired setting.

Speaking during voice output

It is possible to answer during inquiries of the Personal Assistant. The function can be disabled if requests are often canceled unintentionally, for instance due to background noise or conversations in the vehicle.

1.  Apps menu
2. "Vehicle"
3. "System settings"
4. "Voice control"
5. "Personal Assistant (BMW)"
6. "Speaking during voice output"

Suggestions

General information

The Personal Assistant helps with individual suggestions.

Activating/deactivating suggestions

1.  Apps menu
2. "Vehicle"
3. "System settings"
4. "Voice control"
5. "Personal Assistant (BMW)"
6. "Receive suggestions"

Adapting suggestions

Suggestions can be adapted, for example, by category or to output a signal tone.

1.  Apps menu
2. "Vehicle"
3. "System settings"
4. "Voice control"
5. "Personal Assistant (BMW)"
6. Select the desired setting.

Online speech processing

Online speech processing improves the quality of the speech recognition and search results for points of interest. To use the functions, data is transmitted to a service provider via an encrypted connection and stored locally there. An active ConnectedDrive contract is required for online voice processing. ConnectedDrive is available depending on the national-market version. Online speech processing is not available in all languages.

1.  Apps menu
2. "Vehicle"
3. "System settings"
4. "Voice control"
5. "Personal Assistant (BMW)"
6. "Online speech processing"

Configuring the visualization

How the Personal Assistant is visualized can be set.

1.  Apps menu
2. "Vehicle"
3. "System settings"
4. "Voice control"
5. "Personal Assistant (BMW)"
6. "Visualization"

Voice control from third-party providers

Depending on vehicle equipment, third-party voice control can be enabled by pressing and holding the microphone button on the steering wheel.

1.  Apps menu
2. "Vehicle"
3. "System settings"
4. "Voice control"
5. "Long press"
6. Select the desired setting.

Voice control in rear

Depending on vehicle equipment, the Personal Assistant can be started and operated from the rear by saying the activation word.

1.  Apps menu
2. "Vehicle"
3. "System settings"
4. "Voice control"
5. "Personal Assistant (BMW)"
6. "Rear voice control"

Adjusting the volume

Turn the volume button during the voice guidance until the desired volume is set.

The volume remains constant even if the volume of other audio sources is changed.

Using the voice activation of the smartphone

Depending on the device, a smartphone connected to the vehicle can be used via voice control.

The device must be connected via Apple CarPlay or Android Auto.

1. Press and hold the  button on the steering wheel for approx. 3 seconds.

The voice activation of the smartphone is activated.

If activation is successful, a confirmation appears on the control display.

2. Press and hold the  button on the steering wheel to cancel voice control of the smartphone.

Amazon Alexa Car Integration

Principle

Amazon Alexa Car Integration is available depending on vehicle equipment and national-market version. Alexa is a digital assistant from Amazon. With Amazon Alexa Car Integration, Alexa can be used in the vehicle. For safety reasons, the use of some Alexa functions may be restricted while driving your vehicle.

Functional requirements

- ▶ A BMW ID or driver profile is activated.
- ▶ An active Amazon account must exist.

Activating Amazon Alexa Car Integration

Amazon Alexa Car Integration is activated in the vehicle and My BMW app if necessary.

Follow the instructions from the Amazon Alexa app to set it up in the vehicle.

1.  Apps menu
2. "All apps"
3. "Amazon Alexa"
4. Select the desired setting.

After setting it up, use Amazon Alexa in the vehicle as follows:

Say the activation word "Alexa" and the desired command.

Information about the active function is displayed on the control display. If the function is restricted, reconnect Bluetooth and Wi-Fi as necessary.

Automating routines

General information

The Personal Assistant can automate routines, for instance the automatic opening of windows in the same place. Rules are created for this purpose, which can be activated and deactivated at any time.

Activating/deactivating routines

1.  Apps menu
2. "All apps"
3. "Automate habits"
4. Select the desired setting.

System limits

- ▶ The Personal Assistant provides information about vehicle functions that may not be installed in the vehicle.
This also applies to safety functions and systems.
- ▶ Certain noises can be detected and may lead to problems. Keep the doors and windows closed.
- ▶ Noises from the front passenger or occupants can impair the system. Avoid making other noise in the vehicle while speaking.
- ▶ Major language dialects can cause problems with the speech recognition feature.
- ▶ A poor data connection affects the response time of the Personal Assistant and search function.

BMW Touch Command

Principle

BMW Touch Command is a touchscreen used to operate vehicle functions.

General information

The following functions can be operated:

- ▶ Audio sources.
- ▶ My Modes.
- ▶ Interior lighting.
- ▶ Sun protection.
- ▶ Rear seats.
- ▶ Climate control in the rear.
- ▶ BMW Theater Screen.
- ▶ Wireless charging tray in rear.
- ▶ Some phone features.

Overview

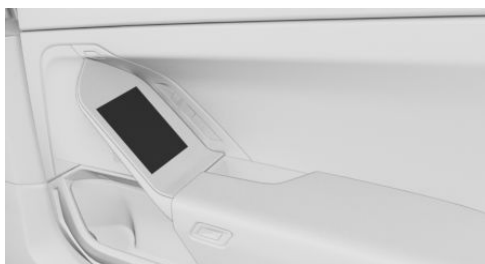

BMW Touch Command is located in the door handle of the rear doors.

Switching on BMW Touch Command

BMW Touch Command is switched on automatically after unlocking the vehicle.

If necessary, tap BMW Touch Command.

Screensaver

General information

If no input is made via BMW Touch Command, the screen saver switches on after 30 seconds. After 60 seconds, the screen saver is dimmed.

Temperature control remains possible when the screen saver is switched on.

The background of the screen saver depends on the selected My Modes Design.



Additional information:

My Modes, refer to page [134](#).

Disabling the screen saver

To disable the screen saver on the touch-screen, swipe from bottom to top.

Operating BMW Touch Command

Function	Operation
Call up the main menu.	 Tap the icon.
Adjusting volume.	 Tap the icon.
Scroll.	Drag up or down.
Confirm the selection.	Tap the screen.

Settings

Brightness

1. "Display"
2. "Touch Comm."
3. Select the desired setting.

Disabling functions

Individual functions of BMW Touch Command can be disabled on the control display.

1.  Apps menu
2. "Vehicle"
3. "System settings"
4. "Rear settings"
5. Select the desired setting.

In addition, certain functions can be disabled with the safety switch.

Additional information:

Safety switch, refer to page [103](#).

BMW Gesture Control

Principle

Several iDrive functions can be operated by hand motion using BMW Gesture Control.

Overview



The camera in the headliner detects gestures that are carried out in the area of the center console at the height of the control display.

The camera of the gesture control uses an invisible Class 1 laser.

Activate/deactivate gesture control

1.  Apps menu
2. "Vehicle"
3. "System settings"

4. "Gesture control"
5. "Gesture control"





Settings





1.  Apps menu
2. "Vehicle"
3. "System settings"
4. "Gesture control"
5. Select the desired setting.

Possible gestures

Carrying out gestures

- ▷ Perform gestures underneath the interior mirror and next to the steering wheel.
- ▷ Execute gestures clearly.
- ▷ The gestures can also be executed from the front-passenger side.

Gesture	Operation	Function
	Move extended index finger forward and backward in the direction of the control display.	Accept call. Select a highlighted entry in a list during voice control. Confirm pop-up.
	Swipe the hand in front of the control display in the direction of the passenger seat.	Reject call. Close pop-up. End voice control.
	Move extended index finger slowly in a clockwise circular movement. Gesture is detected after one circular movement.	Increase the volume.
	Move the extended index finger counter-clockwise in a circular movement. Gesture is detected after one circular movement.	Reduce the volume.
Depending on the equipment:	Bring thumb and index finger together and move the hand to the right or left.	Turn vehicle in the Live Vehicle view. 3D view: rotate camera view. This gesture can only be executed while the vehicle is stationary.
		

Gesture	Operation	Function
	Move fist with thumb extended to the left back and forth.	Reverse Skip function. The previous title is played.
	Move fist with thumb extended to right left back and forth.	Forward Skip function. The next title is played.
	With the index and middle fingers extended, point into the direction of the control display.	Perform individually assignable gesture.
	Stretch out five fingers, form a fist and stretch five fingers out again.	Perform individually assignable gesture.

Assigning gesture individually

General information

Two gestures can be assigned individually and can be configured as shortcut for certain functions such as:

- ▷ Destination guidance to home address.
- ▷ Mute/Playback
- ▷ Control display on/off

Gesture shortcuts can only be created with an active BMW ID or a driver profile.

Configure gesture shortcut

The desired function can be selected directly in every menu and configured as shortcut.

1. Press and hold the desired menu item.
2. "Add to gesture shortcuts"
3. Select the desired gesture.

Select function

Some defined functions can be selected directly in the menu for gesture control.

1.  Apps menu
2. "Vehicle"
3. "System settings"
4. "Gesture control"
5. "Point two fingers at display" or "Show five-o-five fingers"
6. Select the desired setting.

System limits

Gesture recognition by the camera in the headliner can be disturbed by the following circumstances:

- ▷ The camera lens is covered.
- ▷ Objects are located on the interior mirror.

- ▶ The camera lens is dirty, clean camera lens.
Sensors and camera lenses, refer to page 374.
- ▶ The gesture is executed outside of the detection range.
- ▶ Wearing of gloves or jewelry.
- ▶ Smoking in the car's interior.

Connecting mobile devices to the vehicle

Principle

Various connection types are available for using mobile devices in the vehicle. The connection type to select depends on the mobile device and the desired function.

General information

Detailed information on the functions and connection types can be found in the following media in the Owner's Manual under the specified keyword:

- ▶ Integrated Owner's Manual in the vehicle.
- ▶ Printed Owner's Manual for navigation, communication and entertainment.

The following information sources can also be used:

- ▶ Driver's Guide app.
- ▶ Driver's Guide Web.





Safety information





Warning

Operating the integrated information systems and communication devices while driving can distract from surrounding traffic. It is possible to lose control of the vehicle. There is a risk of accident. Only use the systems or devices when the traffic situation allows. As warranted, stop and use the systems and devices while the vehicle is stationary.

Overview

The following overview shows possible functions and the suitable connection types for them. The range of functions depends on the vehicle equipment and the mobile device.

Function	Connection type	Icon on the control display
Making calls via the hands-free system. Using phone functions via iDrive. Keyword: calling via Bluetooth.	Bluetooth. Keyword: Bluetooth connection.	
Playing music from a mobile device. Keyword: audio.	Bluetooth audio. Keyword: Bluetooth connection.	 
Calling without a mobile phone. Keyword: calling with the Personal eSIM.	Personal eSIM. Keyword: Personal eSIM.	 

Function	Connection type	Icon on the control display
Data exchange between mobile device and vehicle.	Wi-Fi. Keyword: vehicle WLAN.	
Use Internet access via the personal hotspot.	Wi-Fi via personal hotspot. Keyword: personal hotspot.	
Using Apple CarPlay via iDrive and via voice control. Keyword: Apple CarPlay preparation.	Bluetooth and Wi-Fi. Keyword: Bluetooth connection and vehicle Wi-Fi.	
Using Android Auto via iDrive and via voice control. Keyword: Android Auto preparation.	Bluetooth and Wi-Fi. Keyword: Bluetooth connection and vehicle Wi-Fi.	
Playing music from a USB device. Keyword: audio.	USB. Keyword: USB connection. Additional information: USB port, refer to page 293 .	

BMW Remote Software Upgrade

Vehicle features and options

This chapter describes model-specific equipment, systems, and functions that are currently available, or may become available in the future, even if they are not present in the vehicle.

Additional information:

Vehicle equipment, refer to page 8.

BMW Remote Software Upgrade

Principle

Remote Software Upgrade can be used to update the entire software of the vehicle. This makes new functions, functional enhancements or quality improvements available.

General information

BMW recommends performing the Remote Software Upgrade as soon as it becomes available.

Safety information

Warning

Unattended children or animals in the vehicle can cause the vehicle to move and endanger themselves and traffic, for example, due to the following actions:

- ▷ Pressing the Start/Stop button.
- ▷ Releasing the parking brake.
- ▷ Opening and closing the doors or windows.
- ▷ Engaging selector lever position N.
- ▷ Using vehicle equipment.

There is a risk of accidents or injuries. Do not leave children or animals unattended in the vehicle. Take the vehicle key with you when exiting and lock the vehicle.

Functional requirements

- ▷ Active ConnectedDrive contract.
- ▷ The integrated SIM card in the vehicle has been activated.
- ▷ Cellular network reception.
- ▷ Consent to transmit the corresponding data was given in the Data Protection menu.

Additional information:

Data protection, refer to page 68.

Search for an upgrade

Functional requirement

Standby must be turned on to search for a Remote Software Upgrade.

Automatic search

The vehicle regularly searches for updates in the background.

Manual search

1.  Apps menu
2. "All apps"
3. "System settings"
4. "Remote Software Upgrade"
5. "Search for upgrades"
6. Follow the instructions on the control display.

Download of an upgrade

Automatic download

If available, the data for a Remote Software Upgrade is automatically downloaded to the vehicle. No download consent is required.

Via My BMW App

If an upgrade is available, information on the new software version is displayed in the My BMW App.

The data for the upgrade can then be downloaded to a mobile device, for instance via an existing WLAN connection.

Data can then be sent from the mobile device to the vehicle.

This transmission method accelerates the download of the data, for instance in areas with limited mobile network availability.

1. Download the upgrade using the My BMW App on your smartphone.
2. Follow the instructions in the My BMW App.
3. Connect your smartphone to the vehicle via Bluetooth audio and Wi-Fi.

Data for the upgrade is sent from the mobile device to the vehicle both while driving and when stopped. Depending on the size of the upgrade, it may be necessary to drive your vehicle to complete the data transfer.

4. Follow the instructions on the control display.

Additional information:

Connecting mobile devices to the vehicle, see Owner's Manual for Navigation, Entertainment, Communication.

Information about the version

General information



The information about the version contains a description of the updates included in the Remote Software Upgrade. During the download

and after the installation has been successfully completed, the information about the version can be displayed on the control display.

This information is also available in the ConnectedDrive customer portal.

Displaying information





Display in the vehicle:

1.  Apps menu
2. "All apps"
3. "System settings"
4. "Remote Software Upgrade"
5.  Display currently installed version:
"Installed version:"
 Display new available version:
"Information on version"
6. Follow the instructions on the control display.

Display in the ConnectedDrive customer portal:
www.bmw-connecteddrive.com.

Installing the upgrade

General information

-  Installation of the Remote Software Upgrade may result in the deletion of software changes, e.g., performance increases not made by the manufacturer of the vehicle.
-  Modifications to the electrical system of the vehicle, for instance to control units, that have not been made by the vehicle manufacturer can lead to an interruption of the installation.
-  The installation does not occur until the consent was given.
-  The installation may take around 20 to 30 minutes.
-  The installation cannot be terminated.



- ▷ The vehicle cannot be used during the installation.
- ▷ The vehicle can be exited during the installation.

Prerequisites for the installation

- ▷ The state of charge of the vehicle battery is sufficient.
- ▷ The outside temperature is above 14 °F/-10 °C.
- ▷ The vehicle is parked in a horizontal position.
- ▷ The hazard warning system is turned off.
- ▷ The selector lever position P is engaged.
- ▷ The engine is turned off and sufficiently cooled down.

If applicable, follow the notes for further prerequisites on the control display.

Your vehicle can establish some prerequisites automatically. Follow the instructions on the control display.

If the prerequisites are not met such as a sufficient vehicle battery charge state, the upgrade will not be offered for installation.

Pay attention to an offer for installation, e.g., after longer trips.

Preparing the vehicle

- ▷ Park the vehicle safely away from the public road.
- ▷ Cellular network reception must be ensured so that a fault message can be sent to the vehicle manufacturer, for instance if the installation is terminated.
- ▷ Close the windows.
- ▷ Close the trunk.
- ▷ Remove energy consuming devices such as a mobile phone.
- ▷ The vehicle key must be located in the vehicle for the consent for installation.

- ▷ Switch off the exterior lighting.
- ▷ Remove the devices connected to the diagnostic socket.

Installing immediately

The upgrade can be installed immediately when all prerequisites have been met.

1. Apps menu
2. "All apps"
3. "System settings"
4. "Remote Software Upgrade"
5. "Start upgrade now"
6. Follow the instructions on the control display.

Installing with timer

When the trip is completed, a timer can be used to install the upgrade automatically at a configured time such as during the night. A later installation may make sense to meet functional requirements, e.g., a sufficiently cooled down engine.

1. Apps menu
2. "All apps"
3. "System settings"
4. "Remote Software Upgrade"
5. Select the desired settings.

The installation starts automatically when:

- ▷ All prerequisites for the installation have been established correctly.
- ▷ All prerequisites continue to be met at the time of installation.

The timer is turned off when the drive-ready state is turned on.

Installing via the My BMW App

If all requirements are met, you can also start the upgrade installation via the My BMW App. Follow instructions in the My BMW App.

Functional limitations

During the upgrade, the majority of functions is temporarily unavailable, for instance:

- ▷ Hazard warning system.
- ▷ Central locking system and, if necessary, Comfort Access.
- ▷ Parking lights.
- ▷ Horn.
- ▷ Alarm system.
- ▷ Emergency call.
- ▷ Power windows.
- ▷ Sun protection.
- ▷ Glove compartment.
- ▷ Checking the fuel filler flap lock.
- ▷ Operate the tailgate or trunk lid.
- ▷ Exit warning if needed.

In vehicles with frameless doors, the window may no longer close completely.

The driver's door can be locked and unlocked from the outside using the integrated key.

In vehicles with an electrical lock, the lock may temporarily not work. In this case, the vehicle can be exited by unlocking the driver's door manually.

Additional information:

Buttons for central locking system, refer to page [93](#).

After successful upgrade

The vehicle can be used again immediately.

Booked services such as Advanced Real Time Traffic Information or Remote Services are automatically reactivated during the next trip.

After an extended stationary period, charge the vehicle battery with an extended drive.

Malfunction

In the event of a malfunction, follow the instructions on the control display or in the My BMW App.

If the malfunction cannot be corrected, contact an authorized service center or another qualified service center or repair shop.

Validity of the Owner's Manual

Production of the vehicle

At the time of production at the plant, the printed Owner's Manual is the most current resource.

After a software update in the vehicle

After a vehicle software update such as via Remote Software Upgrade the Integrated Owner's Manual for the vehicle will contain the latest information.

Personal settings

Vehicle features and options

This chapter describes model-specific equipment, systems, and functions that are currently available, or may become available in the future, even if they are not present in the vehicle.

Additional information:

Vehicle equipment, refer to page [8](#).

Data protection

Data transfer

Principle

The vehicle offers different services, whose use requires a data transfer to BMW or a service provider.

General information

The data transfer can be deactivated for some services. When the data transfer is deactivated, the respective service cannot be used.

Settings

The data transfer can be configured in different stages or individually for separate services.

1.  Apps menu
2. "Vehicle"
3. "System settings"
4. "Data privacy"
5. Select the desired setting.

Deleting personal data in the vehicle

Principle

Depending on the usage, the vehicle stores personal data such as stored radio stations.

This personal data can be permanently deleted using iDrive.

General information

Depending on the equipment, the following data is deleted:

- ▶ BMW IDs or driver profiles.
- ▶ Stored radio stations.
- ▶ Stored shortcuts.
- ▶ Navigation, for instance stored destinations.
- ▶ Phone book.
- ▶ Online data, for instance Favorites, cookies.
- ▶ Office data, for instance voice memos.
- ▶ Login accounts.
- ▶ Digital key.

Altogether, the deletion of the data can take up to 15 minutes. In addition, the vehicle is removed from the My BMW App and Connected-Drive customer portal so that remote functions can no longer be used.

Functional requirements

- ▶ Data can only be deleted while stationary.
- ▶ The vehicle key must be in the vehicle.

Deleting data

The personal data in the vehicle will be deleted when the vehicle is reset to the factory settings.

Additional information:

Resetting vehicle data, refer to page [68](#).

Reset vehicle data

All individual settings can be reset to the factory settings when the drive-ready state is

switched off. Data can only be deleted while the vehicle is stationary. The vehicle key must be in the vehicle.

1.  Apps menu
2. "Vehicle"
3. "System settings"
4. "Reset vehicle data"
5. "Reset vehicle data"

If the synchronization of settings has been enabled for a BMW ID in the vehicle, the personal settings are kept in the BMW Cloud.

BMW ID/driver profiles

Principle

In ConnectedDrive countries, the BMW ID is the personal login for all relevant offers for the BMW brand. The BMW ID can be used in the vehicle to store and activate personal vehicle settings.

In non-ConnectedDrive countries, the personal vehicle settings can be stored in driver profiles.

If a vehicle is used by several people, each person can use their own BMW ID in the vehicle. If a BMW ID is activated, the settings stored for it are applied to the vehicle.

General information

The BMW ID must be registered once. A BMW ID can be registered via the My BMW App, in the ConnectedDrive Portal, or through an authorized service center.

A driver profile is created in the vehicle.

Many of the settings that are stored for a BMW ID in the vehicle can be synchronized with the BMW Cloud. This makes these settings available in any vehicle where the same BMW ID is used to log in.

The vehicle can store seven BMW IDs or seven driver profiles.

With driver recognition, a BMW ID or driver profile can be activated as soon as you unlock your vehicle. For this, a vehicle key or digital key must be linked with the BMW ID or driver profile. After unlocking, you can change the BMW ID or driver profile.

If no BMW ID or driver profile is activated when the vehicle is unlocked, the vehicle loads the guest profile.

Functional requirements

The vehicle must be stationary to create, change, delete, or edit a BMW ID.

Logging in the vehicle with a BMW ID and synchronization with the BMW Cloud are only possible when the vehicle has cellular network reception.

Welcome window

After unlocking the vehicle, a Welcome window is shown on the control display. The type of the welcome depends on the following prerequisites:

- ▶ The vehicle does not have a stored BMW ID or driver profile:
 - The welcome is neutral. An option to add a BMW ID or create a driver profile is offered.
- ▶ The vehicle key or the digital key has not been assigned to a BMW ID or a driver profile:
 - The welcome is neutral. The stored BMW IDs or the stored driver profiles are offered for selection. Additionally, it is possible to add a new BMW ID or create a new driver profile.
- ▶ A BMW ID or driver profile has been assigned to the vehicle key or digital key:
 - The welcome is personalized, the stored settings are activated. The BMW ID or the driver profile can be changed.

As soon as the drive-ready state is turned on or the control display is tapped outside of the Welcome window, the welcome will be hidden.



Adding the BMW ID

1.  Tap the BMW ID icon or the personal image on the status bar.
2. "Add BMW ID"
3. Scan the displayed QR code with your smartphone.
4. Follow the instructions on your smartphone.
 - ▶ If you have installed the My BMW App on your smartphone and saved your BMW ID, the BMW ID is automatically transferred to the vehicle.
 - ▶ If you do not have a BMW ID yet, you a new BMW ID can be registered.
5. Select the other settings you want to change, e.g., to configure driver recognition as desired.
 - ▶ To configure driver recognition, the corresponding vehicle key or digital key must be detected in the vehicle.

Driver recognition can be set or changed in the settings at a later time.
6. Change any additional settings as necessary.

Alternatively, the BMW ID can be registered by an authorized service center and added to the vehicle. The BMW ID must then be confirmed on the control display in the corresponding vehicle.

The vehicle is added to the user's My BMW App.

The vehicle is added to the user's My BMW App.

Confirming a BMW ID

If the BMW ID was created by an authorized service center and added to the vehicle, you must then confirm the BMW ID in the vehicle:

1. Select the BMW ID.
2. Scan the QR code shown.
3. Follow the instructions on your smartphone.

My BMW app

If a BMW ID has been added to a vehicle, the vehicle is automatically added to the My BMW App. This means that My BMW App functions can be used for this vehicle. To do so, the My BMW App must be used with the same BMW ID.

Alternatively, an authorized service center can add a vehicle to the My BMW App. In this case, the BMW ID must then be confirmed on the control display in the corresponding vehicle.

In rare cases, the use of My BMW App functions for this vehicle may be restricted. More information is shown on the control display.

Creating a driver profile

In countries where BMW ConnectedDrive is not available, driver profiles can be created.

1.  Tap the icon or personal picture in the status bar.
2. "Add driver profile"
3. Enter the name for the driver profile.
4. Select the desired setting:
"Transfer settings"

If the vehicle is in the guest profile, the settings of the guest profile will be applied.

Primary user

The primary user is the person who first adds their BMW ID to the vehicle and first adds the vehicle to their My BMW App. Alternatively, the

primary user can be defined by an authorized service center.

The primary user has access to the following settings, for example:

- ▷ Removing BMW IDs stored in the vehicle.
- ▷ Transferring the primary user role to another BMW ID.
- ▷ Change vehicle-wide data protection settings.
- ▷ Create the main digital key.

Additional information:

BMW Digital Key, refer to page 90.

Automatic driver recognition

If driver recognition has been established, automatic activation of the BMW ID or driver profile is triggered by the following actions:

- ▷ By unlocking the vehicle using the button on the assigned vehicle key.
- ▷ By unlocking the vehicle using an external door handle. The assigned vehicle key or the assigned Digital Key must be carried with you.
- ▷ By automatic unlocking when approaching the vehicle. The assigned vehicle key or the assigned Digital Key must be carried with you. Depending on the country, it may not be possible to recognize the Digital Key.

If there are several vehicle keys or Digital Keys in the vicinity of the vehicle, activation of the BMW ID or driver profile is done according to the following priority:

- ▷ The key that unlocks the vehicle triggers the activation of the assigned BMW ID or the assigned driver profile.

The guest profile is activated when the vehicle is unlocked using a key that is not assigned to a BMW ID or driver profile.

- ▷ If a vehicle key and a Digital Key are detected at the same time, the Digital

Key triggers the activation of the assigned BMW ID or the assigned driver profile.

- ▷ If another key is detected on the driver's door after activating the BMW ID or the driver profile, the BMW ID or the driver profile of the last key detected is activated.

If no BMW ID and no driver profile are assigned to this key, the guest profile is activated.

Setting synchronization

If synchronization is switched on, settings from the following areas, for example, are continuously synchronized:

- ▷ BMW ID, e.g., profile picture.
- ▷ Navigation, e.g., recent destinations, home address, or map settings.
- ▷ Media, e.g., favorites or saved radio stations.
- ▷ iDrive, e.g., main menu configuration, language, or units.
- ▷ Personal Assistant, e.g., suggestions or activation word.
- ▷ Exterior lighting, e.g., one-touch signaling and home lights.



Settings from the following areas are only synchronized when you log in for the first time:

- ▷ Seating and climate comfort, e.g., driver's seat position or temperature setting.
- ▷ Data protection menu.

Selecting the BMW ID/driver profile

If the BMW ID or driver profile could not be recognized when unlocking the vehicle, select the BMW ID or driver profile on the welcome window.

The BMW ID or driver profile can be changed at any time via iDrive:



1.  Tap the icon or personal picture in the status bar.
2.  "Change BMW ID"
 -  "Change driver profile"
3. Select the BMW ID or driver profile.
4. If necessary, enter the PIN.

The BMW ID or the driver profile are activated, the stored settings are loaded.





Guest profile

The guest profile can be activated and changed by anyone.



In the following cases the guest profile is automatically active:

-  A BMW ID has not yet been added or a driver profile has not yet been created.
-  No BMW ID or driver profile has been assigned to the vehicle key or the digital key that was used to unlock the vehicle.





The following limitations apply to the guest profile:

-  Certain functions are not available, e.g., navigation functions or saving favorites.
-  The guest profile cannot be renamed.
-  It is not possible to assign a PIN to the guest profile.
-  It is not possible to assign driver detection to the guest profile.
-  In ConnectedDrive countries, the synchronization with the BMW Cloud is not possible.

The guest profile is selected on the Welcome screen or via iDrive:

1.  Tap the icon or personal picture in the status bar.
2.  "Change BMW ID"
 -  "Change driver profile"
3. "Continue as guest"

Deleting the BMW ID/driver profile

1.  Tap the icon or personal picture in the status bar.
2.  "Manage BMW IDs"
 -  "Change driver profile"
3.  Tap the icon of the desired BMW ID or the desired driver profile.

Removing a BMW ID from the vehicle causes the vehicle to be removed from the My BMW App. If the BMW ID has been synchronized with the BMW Cloud, the data stored in the BMW Cloud is retained after the BMW ID is deleted. If the currently active BMW ID is removed, the guest profile is activated.

Removing a vehicle from the My BMW App removes the corresponding BMW ID from the vehicle. If the BMW ID was synchronized with the BMW Cloud, the BMW ID data stored in the BMW Cloud will be retained.

If the vehicle is removed from the primary user's My BMW App, it will also be removed from the My BMW App of the other users. The corresponding BMW IDs are removed from the vehicle.

If the vehicle is reset to factory settings, it is removed from each user's My BMW App, and all BMW IDs are removed from the vehicle.

Transfer of the vehicle key

A vehicle key that is assigned to a BMW ID or a driver profile can be used to view or change the stored personal settings.

Before a vehicle key is transferred to other persons, any assigned driver detection should be canceled. Changes to the driver detection can be made in the settings of the BMW ID or the driver profile.

The BMW Digital Key provides the option to transfer a digital key to permit other persons the use of your own vehicle.

Additional information:

BMW Digital Key, refer to page 90.

Settings

General information

Settings added when adding a BMW ID or creating a driver profile can be changed.

1.  Tap the icon or personal picture in the status bar.
2. "Settings"

The following settings are available for the BMW ID:

- ▷ The type of driver detection.
- ▷ The profile picture.
- ▷ The synchronization with the BMW Cloud.
- ▷ The personal salutation.

The following settings are available for the driver profile:

- ▷ The type of driver detection.
- ▷ The profile picture.
- ▷ The profile name.

Selecting a profile picture

The profile picture can be selected from the predefined profile pictures:

1.  Tap the icon or personal picture in the status bar.
2. "Settings"
3. "Manage profile picture"
4. "Select profile picture"

The personal profile picture for a BMW ID can be adopted from the profile in the My BMW App. This requires that the synchronization with the BMW Cloud is activated in the settings. After transferring the profile picture from the My BMW App, you can only select one of the predefined images if the profile picture in the My BMW App is deleted or synchronization is deactivated.

System limits

A clear driver detection via the vehicle key or the digital key may not always be possible in the following cases, for example:

- ▷ The driver changes, but the vehicle is not locked and unlocked.
- ▷ When multiple vehicle keys or multiple digital keys with an assigned BMW ID or driver profile are located in the outer area on the driver's side of the vehicle.
- ▷ When the vehicle was unlocked via the My BMW App.

The use of personal settings that are stored for a BMW ID in other vehicles is subject to technical limitations. For example, settings may be stored for a system that is not available, or available in a non-compatible version, in other vehicles.

Opening and closing

Vehicle features and options

This chapter describes model-specific equipment, systems, and functions that are currently available, or may become available in the future, even if they are not present in the vehicle.

Additional information:

Vehicle equipment, refer to page 8.

Vehicle key

General information

Two vehicle keys are included in the scope of delivery, each containing an integrated key.

Each vehicle key contains a replaceable battery.

Depending on the equipment and national-market version, various settings are possible for the button functions.

A BMW ID or a driver profile with personal settings can be assigned to a vehicle key.

To provide information on maintenance recommendations, the service data is stored in the vehicle key.

To prevent possible locking in of the vehicle key, take the vehicle key with you when exiting the vehicle.

Safety information

Warning





The vehicle key has a button cell battery. Batteries or button cell batteries can be swallowed and lead to serious or fatal injuries within two hours, for example due to internal burns or chemical burns. There is a risk of injury or danger to life. Keep the vehicle key and batteries out of reach of children. Imme-

diately seek medical help if there is any suspicion that a battery or button cell battery has been swallowed or is located in any part of the body.

Overview



Buttons on the vehicle key.

Icon	Meaning
	Unlock.
	Lock. Stationary climate control, refer to page 286.
	Open the cargo area.
	Panic mode. Pathway lighting, refer to page 167.

Additional vehicle keys

Additional vehicle keys are available from an authorized service center or another qualified service center or repair shop.

Loss of vehicle keys

A lost vehicle key can be disabled and replaced by an authorized service center or another qualified service center or repair shop.

If the lost vehicle key has an assigned BMW ID or driver profile, the connection to this vehicle key must be deleted. A new vehicle key can then be assigned to the BMW ID or driver profile.

Replacing the battery

NOTICE

Improper batteries in a battery-operated device can damage the device. There is a risk of damage to property. Always replace the discharged battery with a battery with the same voltage, the same size and the same specification.

1. Press and hold the button, arrow 1, and push the cover, arrow 2, forward and remove it from the side.



2. Remove the battery housing from the vehicle key to the side.



3. Remove the battery from the battery housing.



4. Insert a CR2032 3V battery with the positive side facing down.
5. Insert the battery housing into the vehicle key.

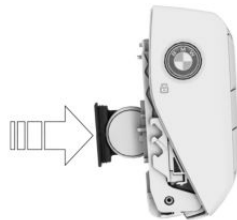

6. Insert the cover into the vehicle key.



Have old batteries disposed of by an authorized service center or another qualified service center or repair shop, or take them to a collection point.

Integrated key

General information

The vehicle can be locked and unlocked without the vehicle key using the integrated key.

Depending on the national-market version, the integrated key will fit in the glove compartment.

Safety information

Warning

For some national-market versions, unlocking from the inside is only possible with particular knowledge.

If persons or animals spend a lengthy time in the vehicle and are thereby exposed to extreme temperatures, there is a risk of injury or danger to life. Do not lock the vehicle from the outside when there are people or animals in it. Do not leave babies, toddlers or animals alone in the vehicle.

Removing the integrated key

1. Press and hold the button, arrow 1, and push the cover, arrow 2, forward and remove it from the side.



2. Slide out the integrated key at the open side of the vehicle key.



3. Remove the integrated key from the vehicle key.

Unlocking the vehicle manually

1. Press the cover cap in.
The cover cap is slightly opened.

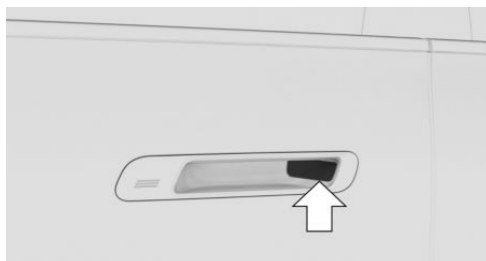

2. Pull the cover cap to the side so that the door lock is clearly visible.
3. Unlock the door lock with the integrated key.



4. Remove the integrated key from the door lock.
5. Press the cover cap in to close it.

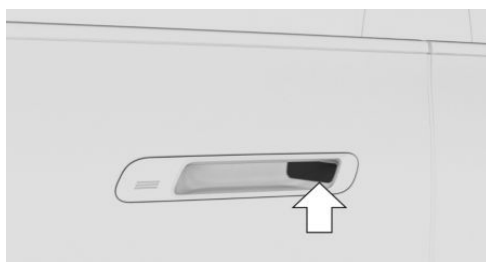

6. Press the cover cap in again to open it slightly.

7. Pull on the cover cap until the door opens.

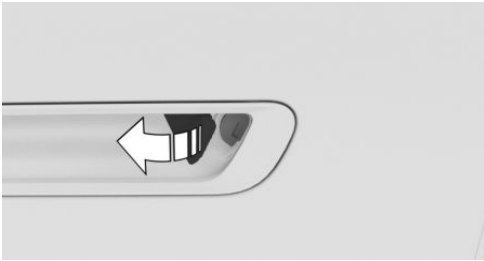

8. Open the driver's door.
 9. Press the central locking button to unlock the other doors.
 With the vehicle de-energized: pull the lever in the other doors from the inside.

Locking the vehicle manually

General information

To avoid locking the vehicle key in the vehicle, do not place the vehicle key in the vehicle.

Locking the vehicle

1. Lock the doors to be locked with the integrated key using the side door lock on the front of the doors.

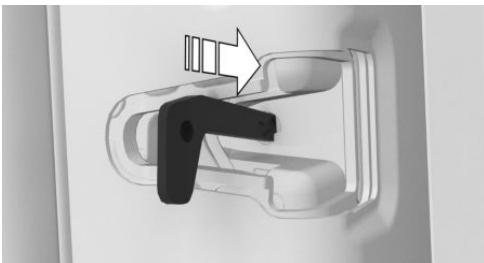

2. Close the locked doors.

Alarm system



If the vehicle is unlocked with the integrated key via the door lock, the activated alarm system will be triggered when the door is opened. In this case, use the vehicle key emergency detection to switch off the alarm.

If the vehicle is locked with the integrated key via the door lock, the alarm system will not be activated.

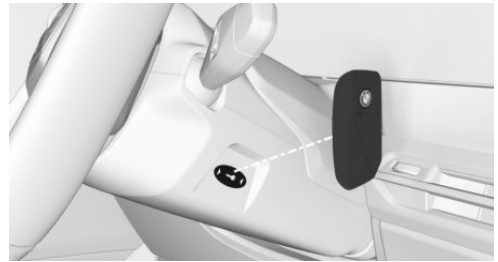
Emergency detection of the vehicle key





It is not possible to switch on the drive-ready state if the vehicle key has not been detected. Proceed as follows in this case:

1. Hold the rear of the vehicle key against the mark on the steering column. Pay attention to the display in the instrument cluster.
2.  If the vehicle key is detected:
Turn on drive-ready state within 10 seconds.
-  If the vehicle key is not detected:
Slightly change the position of the vehicle key and repeat the procedure.

Malfunction

A Check Control message is displayed where applicable.

Vehicle key detection by the vehicle may malfunction under the following circumstances:

-  The battery of the vehicle key is discharged.
-  Fault of the radio link from transmission towers or other equipment with high transmitting power.
-  Shielding of the vehicle key due to metal objects.

Do not transport the vehicle key together with metal objects.

- ▷ Fault of the radio link from mobile phones or other electronic devices in direct proximity to the vehicle key.

Do not carry the vehicle key in close proximity to other electronic devices.

- ▷ Fault of radio transmission by a charging process of mobile devices, for instance charging of a mobile phone.
- ▷ The vehicle key is located in direct proximity of the wireless charging tray.

Place the vehicle key in a different location.

In the case of interference, the vehicle can also be unlocked and locked from the outside with the integrated key. Use the Emergency detection of the vehicle key to turn on drive-ready state.

Access to vehicle interior

Safety information

Warning

People or animals in the vehicle can lock the doors from the inside and lock themselves in. In this case, the vehicle cannot be opened from the outside. There is a risk of injury. Take the vehicle key with you so that the vehicle can be opened from the outside.

Warning

For some national-market versions, unlocking from the inside is only possible with particular knowledge.

If persons or animals spend a lengthy time in the vehicle and are thereby exposed to extreme temperatures, there is a risk of injury or danger to life. Do not lock the vehicle from the outside when there are people or animals in it. Do not leave babies, toddlers or animals alone in the vehicle.

Warning

Unattended children or animals in the vehicle can cause the vehicle to move and endanger themselves and traffic, for example, due to the following actions:

- ▷ Pressing the Start/Stop button.
- ▷ Releasing the parking brake.
- ▷ Opening and closing the doors or windows.
- ▷ Engaging selector lever position N.
- ▷ Using vehicle equipment.

There is a risk of accidents or injuries. Do not leave children or animals unattended in the vehicle. Take the vehicle key with you when exiting and lock the vehicle.

Actions during unlocking

Depending on the settings, the following functions are performed when unlocking the vehicle:

- ▷ Only the driver's door and the fuel filler flap will be unlocked or all access to the vehicle will be unlocked.
- ▷ The unlocking of the vehicle can be confirmed with a light signal or a sound signal.
- ▷ The welcome light can be turned on when the vehicle is being unlocked.

In addition, the following functions are executed:

- ▷ If a BMW ID or a driver profile was assigned to the vehicle key, this BMW ID or driver profile will be activated.
- ▷ The interior lights are switched on, unless they were manually switched off.
- ▷ Depending on vehicle equipment, folded-in exterior mirrors are folded out.

If the exterior mirrors were folded in via the button in the vehicle interior, they will not be folded out during unlocking.

- ▶ Anti-theft protection is switched off.
- ▶ The alarm system is switched off.

Additional information:

- ▶ Settings, refer to page 95.
- ▶ Welcome lights, refer to page 166.
- ▶ BMW ID/driver profiles, refer to page 69.

Actions during locking

Depending on the settings, the following functions are performed when locking the vehicle:

- ▶ The locking of the vehicle can be confirmed with a light signal or a sound signal.
- ▶ Depending on vehicle equipment, the exterior mirrors can be folded in automatically when locking. The exterior mirrors are not folded in when the hazard warning flashers are switched on.

The following functions are executed:

- ▶ All doors, the tailgate, and the fuel filler flap are locked.
- ▶ Anti-theft protection is switched on. This prevents the doors from being unlocked using the lock button or door opener.
- ▶ The alarm system is switched on.

If the drive-ready state is still turned on when you lock the vehicle, the vehicle horn will honk twice. In this case, the drive-ready state must be switched off by means of the Start/Stop button.

Additional information:

Settings, refer to page 95.

With the vehicle key

Unlocking the vehicle



Press the button on the vehicle key.

If only the driver's door and fuel filler flap have been unlocked due to the settings in place,

press the button on the vehicle key again to unlock the other vehicle access points.

The lighting functions may depend on the ambient brightness.

Opening and closing automatic doors

When opening and closing manually, the doors are motor-assisted. Depending on the settings, the doors can also be opened and closed automatically using the vehicle key.

Additional information:

Automatic doors, refer to page 82.

Locking the vehicle manually

1. Close the driver's door.



2. Press the button on the vehicle key. All vehicle access points are locked.

On the external door handle

Principle

The vehicle can be accessed without operating the vehicle key.

The vehicle key is automatically detected near the vehicle.

General information

The function is available with Comfort Access.

Depending on the national-market version, the vehicle can also be unlocked and locked at the external door handle with compatible smartphones with a digital key.

Additional information:

BMW Digital Key, refer to page 90.

Functional requirements

- ▷ Carry the vehicle key with you, e.g., in your pants pocket.
- ▷ Bluetooth must be activated on the smart-phone to unlock and lock using the Digital Key.
- ▷ To lock the vehicle, the vehicle key must be outside of the vehicle near the doors.
- ▷ After locking, approx. 2 seconds must elapse before unlocking is possible.

Unlock vehicle on front door

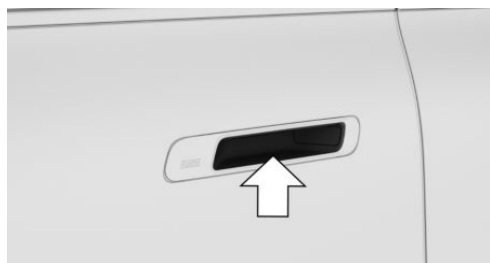

Reach into the recessed grip of a front door.

Unlocking the vehicle at the rear door

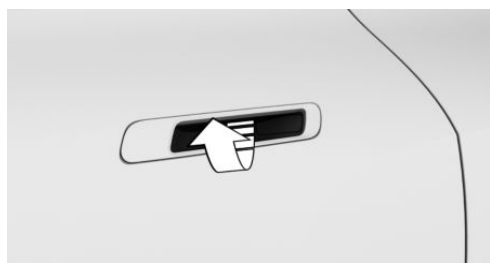

Press and hold the button in the recessed grip to unlock the vehicle and open the rear door.

Opening and closing automatic doors

When opening and closing manually, the doors are motor-assisted. The doors can also be opened and closed automatically on the external door handle.

Additional information:

Automatic doors, refer to page 82.

Locking the vehicle

1. Close the driver's door.
2. Touch the grooved surface on the external door handle of a closed front door with your finger for approx. 1 second without reaching into the recessed grip.

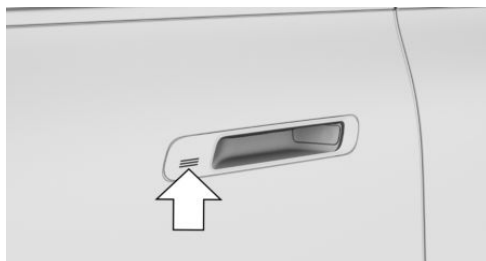

Malfunction

Wet or snowy conditions may disrupt the locking request detection on the external door handles.

In the case of a malfunction, unlock and lock the vehicle using the buttons of the vehicle key or use the integrated key.

Touchless unlocking/locking of the vehicle

Principle

When the driver approaches the locked vehicle with the vehicle key, the vehicle is unlocked.

When the driver walks away from the unlocked vehicle with the vehicle key, the vehicle will be locked.

General information

The function is available with Comfort Access.

The vehicle will be unlocked when an authorized vehicle key is detected in the unlocking zone.

The unlocking zone is located within a radius of approx. 5 ft/1.50 m around the vehicle.



The vehicle will be locked when the vehicle key leaves the locking zone.

The locking zone is located within a radius of approx. 9 ft/2 m around the vehicle.

Depending on the national-market version, touchless unlocking and locking is also possible for compatible smartphones with a digital key. Enable Bluetooth on your smartphone to do so.

If the vehicle key is located in the unlocking zone for an extended period of time without movement, the vehicle will be locked automatically.

If someone is detected on a seat while locking the vehicle, the following restrictions apply:

- ▶ The vehicle will be locked but not secured against theft.
- ▶ The fuel filler flap remains unlocked.

Additional information:

BMW Digital Key, refer to page 90.

Actions during unlocking

If the settings specify that only the driver's door and the charging socket flap will be unlocked, note the following:

The driver's door and the charging socket flap will only be unlocked when the driver is within the unlocking zone of the driver's door.

Settings, refer to page 95.

Functional requirements

- ▶ Carry the vehicle key with you, e.g., in your pants pocket.
- ▶ Bluetooth must be activated on the smartphone for contactless unlocking and locking using the Digital Key.
- ▶ Automatic unlocking and locking must be activated in the settings.
- ▶ The drive-ready state must be turned off.
- ▶ If the vehicle has been in the idle state for several days, contactless unlocking/locking

will only be available after the vehicle has been driven.

Additional information:

Settings, refer to page 95.

With the Key Card

Principle

The Key Card is a chip card on which the digital key is installed. The Key Card can be used to unlock and lock the vehicle.

Additional information:

Key Card, refer to page 89.

General information

The Key Card is available with Comfort Access.

Locking/unlocking the vehicle

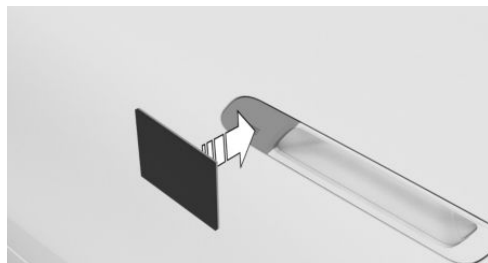

Hold activated Key Card directly on the center of the external door handle of the driver's door.

When locking the vehicle with the Key Card, make sure that all doors and the trunk are closed.

If the Key Card is not detected, slightly change the position of the Key Card and repeat the procedure.

With the BMW Digital Key

Principle

Depending on vehicle equipment and national-market version, a digital key can be installed

on a compatible smartphone and used to unlock and lock the vehicle.

Additional information:

BMW Digital Key, refer to page 90.

Locking/unlocking the vehicle

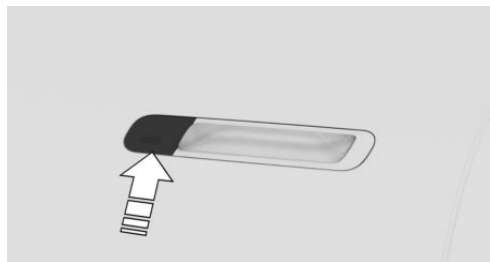

Hold the near field communication antenna of the smartphone directly and centered on the external door handle of the driver's door. The position of the near field communication antenna depends on the smartphone model.

When locking the vehicle with the smartphone, make sure that all doors and the trunk are closed.

Frequently Asked Questions

What precautions can be taken to be able to open a vehicle, despite accidentally locking in the vehicle key?

- ▶ The app's remote services offer the option to lock and unlock a vehicle.
This requires an active BMW ConnectedDrive contract, and the app must be installed on a smartphone.
- ▶ Unlocking the vehicle can be requested via the BMW ConnectedDrive Call Center.
An active BMW ConnectedDrive contract is required.

Automatic doors

Principle

The automatic doors open and close automatically. If necessary, the doors can also be operated manually.

General information

Multiple doors can be opened and closed at the same time.

The driver's door can be opened contactlessly. When opening and closing manually, the door movement is motor-assisted.

Safety information

Warning

Body parts can be jammed while operating the doors. There is a risk of injury. Make sure that the area of movement of the doors is clear while opening and closing.

Warning

The system does not release the driver from their responsibility to assess the traffic and their surroundings. Based on the limits of the system, it cannot independently react to all traffic situations. Otherwise, there is a risk people may be injured or property damaged. Observe traffic and surroundings and actively intervene in corresponding situations, e.g., manually interrupt the door movement.

Functional requirements

- ▶ The vehicle tilt is less than 10° in the longitudinal and transverse directions.
- ▶ The vehicle is at a standstill.
- ▶ The safety function is switched off. When the safety function is switched on, the rear

doors cannot be operated in the interior nor operated with the vehicle key.

Additional information:

Safety switch, refer to page [103](#).

Detection of obstacles

When the doors are opened automatically, stationary and moving obstacles are detected under the following circumstances:

- ▶ The stationary obstacles are not closer than 10 in/25 cm to the vehicle.
- ▶ The stationary obstacles are located below the window line.
- ▶ The detection area for moving obstacles corresponds to that of the Exit Warning. Exit Warning is only triggered if the doors are opened from the inside.

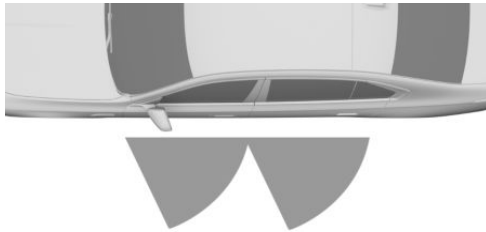

Detection range for stationary obstacles.

If an obstacle is detected, a visual warning is issued on the respective door and on the control display. Movement of the respective door is stopped.

Additional information:

Exit warning, refer to page [188](#).

Ultrasonic sensors, refer to page [38](#).

Opening/closing the driver's door contactlessly

Principle

The driver's door opens automatically when the driver approaches the closed vehicle with

their digital key. If the driver moves away from the open vehicle with their digital key, the driver's door closes automatically.

General information

The function is available with Comfort Access. Function availability depends on national-market version.

The driver's door opens automatically when an authorized digital key is detected in unlocking range.

The unlocking range is the radius of approx. 5 ft/1.50 m around the vehicle.

The driver's door closes and locks when the digital key leaves locking range.

The locking range is the radius of approx. 9 ft/2 m around the vehicle.

Safety information

NOTICE

If the function for automatically opening/closing the driver's door is activated, the driver's door may open unintentionally, e.g. when washing the vehicle. There is a risk of damage to property. In situations where the driver's door must remain closed, deactivate the hands-free opening/closing function.

Functional requirements

- ▶ The Digital Key has been activated and authorized for the vehicle.
- ▶ Contactless opening/closing of the driver's door is activated in the settings.

Additional information:

BMW Digital Key, refer to page [90](#).

On the external door handle

Principle

The vehicle can be accessed without operating the vehicle key.

The vehicle key is automatically detected near the vehicle.

General information

Depending on the national-market version, the vehicle doors can also be opened and closed automatically with the external door handle using a compatible smartphones with a digital key.

Additional information:

BMW Digital Key, refer to page 90.

Opening the door automatically

1. Press the button in the illuminated spot, arrow.

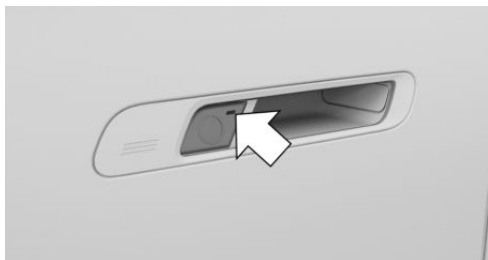

2. Leave the door's travel path if necessary.

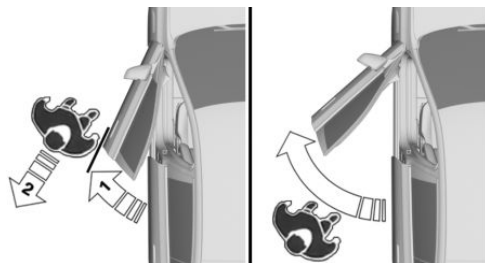

If the person opening the door is detected as an obstacle, the door stops, arrow 1. If

the door's travel path is exited immediately, arrow 2, the door continues to move.

Pressing the button again stops the door movement.

If the door does not continue to move, open the door manually.

Opening the door manually

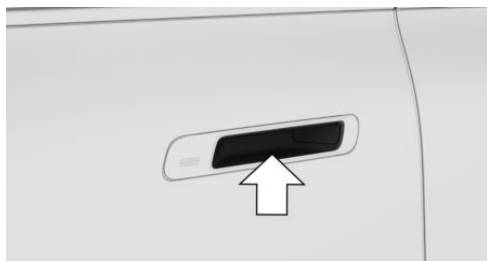

Reach into the recessed grip of the door and pull the door outward.

The movement of the door is motor-assisted.

Closing the door automatically

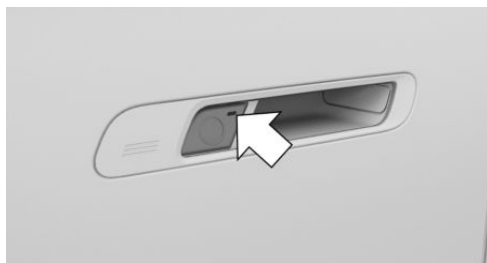

- ▶ Press the button in the illuminated spot, arrow.

Pressing the button again stops the door movement.

- ▶ Push the door briefly.

Closing the door manually

Close the open door slowly and press slightly against the vehicle. The door closes automatically.

With the My BMW app

The My BMW app can be used to open and close automatically. To do so, a digital key for the vehicle must be installed on the smartphone.

Additional information:

BMW Digital Key, refer to page 90.

In the interior

Operating the front door



Press the button in the door to unlock the door.

Push the door outward.



Press the button next to the steering wheel to open or close the door automatically.

Operating the rear doors



Press the button to unlock the door.

Push the door outward.



Press the button to open or close the door automatically.

Closing the driver's door with the brake pedal

Depress the brake pedal to close the driver's door.

This function must be activated in the settings.

Additional information:





Settings, refer to page 95.

Operating doors on the control display

Doors can be opened, closed, and stopped in motion, separately or together.

1.  Apps menu
2. "Vehicle"
3. "Doors and windows"
4. "Automatic doors"
5. Select the desired function.

Operation of individual doors:

Icon	Meaning
	Open the closed door.
	
	Close the open door.
	
	Stop the door movement.

Access to the cargo area

General information

It may not be possible to open the cargo area when the vehicle is in valet parking mode.

Additional information:

Valet parking mode, refer to page 95.

Safety information

Warning

Body parts can be jammed when operating the trunk lid. There is a risk of injury. Make sure that the travel path of the trunk lid is clear while opening and closing.

Warning

While opening, the trunk lid pivots back and up. There is a risk of injury and risk of damage to property. Make sure that the travel path of the trunk lid is clear while opening and closing.

With the vehicle key

General information

To avoid locking the vehicle key in the vehicle, do not place the vehicle key in the cargo area.

Depending on vehicle equipment and national-market version, the following settings can be changed:

- ▶ Unlocking the cargo area with the vehicle key also unlocks the doors.
- ▶ Before unlocking the cargo area with the vehicle key, first unlock the vehicle.

Functional requirements

Selector lever position P must be engaged to open the cargo area with the vehicle key.

You must enable the setting for opening with the vehicle key.

Additional information:

Settings, refer to page 95.

Opening the trunk



Press and hold the button on the vehicle key for approx. 1 second.

On the trunk

General information

With Comfort Access, the cargo area can be accessed without activating the vehicle key.

The key is automatically detected near the vehicle.

Depending on the national-market version, compatible smartphones with a digital key are also detected automatically. In this case, the cargo area can be opened with a smartphone.

Additional information:

BMW Digital Key, refer to page 90.

Functional prerequisites

- ▶ Carry the vehicle key with you, e.g., in your pants pocket.
- ▶ Bluetooth must be activated on the smartphone to detect the Digital Key.

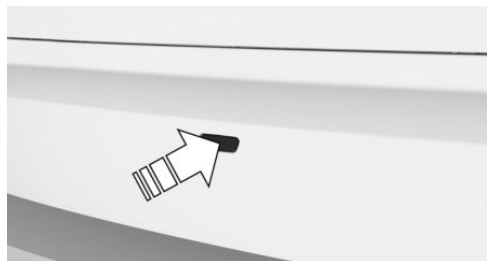

Opening the trunk

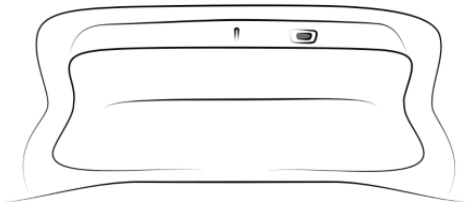

- ▶ Unlock the vehicle and then press the button on the trunk.
- ▶ With Comfort Access: carry the vehicle key with you and press the button on the trunk. Locked doors are not unlocked.

Closing the cargo area



- ▶  Press the button on the trunk.
- ▶  Press the button on the trunk. The vehicle is locked after closing the cargo area. To do so, the driver's door must be closed and the vehicle key must be outside of the vehicle near the cargo area.
- ▶ Pull the trunk lid down slightly. The trunk lid closes automatically.

In the interior

Functional prerequisite

The vehicle key or digital key must be located inside the vehicle in order to close the cargo area using the button in the vehicle interior.

Opening the trunk

- ▶  Press the button in the driver's door.

Closing the cargo area

- ▶  Pull and hold the button in the driver's door.

An acoustic signal sounds before the trunk is closed.

Interruption of the opening procedure

The opening procedure is interrupted in the following situations:

- ▶ When the vehicle starts moving.
- ▶ By pressing the button on the outside of the cargo area. Pressing it again closes the cargo area again.
- ▶ By pressing the button on the inside of the cargo area. Pressing it again closes the cargo area again.
- ▶ By pressing the button on the vehicle key. Pressing the button again continues the opening process.
- ▶ By pressing or pulling the button in the driver's door. Pressing again continues the opening procedure.

Interruption of the closing procedure

The closing procedure is interrupted in the following situations:

- ▶ If the vehicle drives off with a jerky movement.
- ▶ By pressing the button on the outside of the cargo area. Pressing it again opens the cargo area again.
- ▶ By pressing the button on the inside of the cargo area. Pressing it again opens the cargo area again.
- ▶ By releasing the button in the driver's door. Pulling again and holding continues the closing motion.

Opening and closing the cargo area contactlessly

Principle

You can open the cargo area contactlessly when carrying the vehicle key on your person. With automatic tailgate activation, the cargo area can also be closed contactlessly.

Two sensors detect a forward-directed foot movement in the central rear area and the cargo area is opened or closed.

General information

Function availability depends on vehicle equipment and national-market version.

If the vehicle key is within the sensor range, the cargo area may open or close inadvertently if you unintentionally move your foot or if a foot movement is detected.

The sensor has an approximate range of 5 ft/1.50 m extending from the rear area.

If contactless opening is used for the cargo area, the locked doors will not be unlocked.

Depending on the national-market version, contactless opening and closing of the cargo area is also possible for compatible smartphones with a Digital Key.

Additional information:

BMW Digital Key, refer to page [90](#).

Safety information

Warning

During no-touch activation, vehicle parts may be touched such as the hot exhaust system. There is a risk of injury. When moving your foot, make sure you have a firm stance and do not touch the vehicle.

Warning

Body parts can be jammed when operating the trunk lid. There is a risk of injury. Make sure that the travel path of the trunk lid is clear while opening and closing.

Warning

While opening, the trunk lid pivots back and up. There is a risk of injury and risk of damage to property. Make sure that the travel path of the trunk lid is clear while opening and closing.

Functional requirements

- ▶ To close the cargo area contactlessly, the automatic tailgate must be installed.
- ▶ To open and close the cargo area contactlessly, selector lever position P must be engaged.
- ▶ Contactless opening and closing of the trunk must be activated in the settings.
- ▶ Bluetooth must be activated on the smartphone to open and close the cargo area contactlessly using the Digital Key.

Additional information:

Settings, refer to page [95](#).

Opening the cargo area

1. Stand in the middle behind the vehicle at approx. one arm's length away from the rear of the vehicle.
2. Wave a foot under the vehicle in the driving direction and immediately pull it back.

With these movements, the leg must pass through the ranges of both sensors.

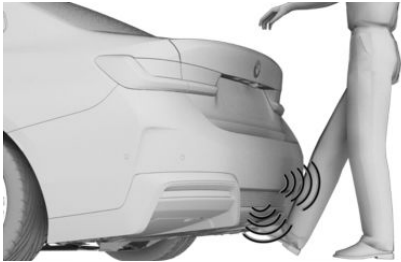

Before the cargo area opens, the hazard warning system flashes.

Moving a foot again will stop the opening procedure. The subsequent foot movement will close the cargo area again.

Closing the cargo area

Perform the foot movement for opening the cargo area.

The hazard warning system flashes and an acoustic signal sounds.

Moving a foot again will stop the closing process. The subsequent foot movement will open the cargo area again.

System limits

The detection of the foot movement may be limited due to the following external conditions:

- ▶ Ice, snow or slush on the rear of the vehicle.
- ▶ Dirt or road salt on the rear of the vehicle.

Movement in range of the sensors may cause unintended opening of the cargo area, for instance due to water running down when cleaning the vehicle or with heavy rainfall. To prevent such unintended opening of the cargo area in such cases, keep the vehicle key at a sufficient distance from the rear of the vehicle.

Trunk emergency unlocking



Pull the handle inside the cargo area.

The trunk is unlocked.

Malfunction

In the event of an electrical malfunction, operate the unlocked trunk lid manually with a slow and smooth motion.

Key Card

Principle

The Key Card allows the vehicle to be unlocked and locked, as well as started.

General information

Key Card availability depends on vehicle equipment and national-market version.

A digital key that has already been paired with the vehicle is installed on the Key Card. The digital key must be activated via iDrive.

Before leaving the vehicle, deactivate the Key Card or take the Key Card with you because the active Key Card can be used to start the vehicle. Always take the vehicle key with you to a service appointment.

Safety information

NOTICE

If the Key Card and a mobile device are in the wireless charging tray at the same time, the Key Card could become damaged. There is a risk of damage to property. Do not place the Key Card in the wireless charging tray at the same time as a mobile device.

Activating/deactivating Key Card in the vehicle

General information

When the BMW Digital Key is activated for the vehicle, a digital key can be used instead of the vehicle key.

A deactivated Key Card remains in the list of paired digital keys.

Functional requirement

A vehicle key must be located in the vehicle to activate and deactivate the Key Card.

Activating Key Card



1. Place Key Card in the center of the smartphone tray.
2. Follow instructions on the control display.

Deactivating Key Card

1.  Apps menu
2. "Vehicle"

3. "Doors and windows"
4. "Digital Key"
5. "Key Card"
6. "Deactivate Key Card"

A deactivated Key Card remains in the list of paired digital keys.

Unlocking and locking the vehicle

The vehicle can be unlocked and locked with the activated Key Card.

Additional information:

Access to the vehicle interior, refer to page [78](#).

Turning on the drive-ready state



1. Place activated Key Card in the center of the smartphone tray.
2. Press the Start/Stop button.

After drive-ready state is switched on, the Key Card can be removed from the tray.

Malfunction

The detection of the Key Card by the vehicle may be disrupted by objects between the sensors and the Key Card such as a wallet or a smartphone cover.

BMW Digital Key

Principle

BMW Digital Key allows the vehicle to be unlocked and locked, as well as started, with a compatible smartphone.

General information

BMW Digital Key availability and functionality depend on vehicle equipment and national-market version.

BMW Digital Key can be used with a compatible smartphone or other compatible mobile devices.

To unlock and start a vehicle with a compatible smartphone, this function must be offered by the smartphone manufacturer. The My BMW app can be used to check if the smartphone and vehicle are compatible and which functions are supported.

A BMW ID or a driver profile with individual settings can be assigned to a digital key.

When using a smartphone as a digital key, it is helpful to carry the deactivated Key Card in the vehicle. In situations where the vehicle is to be given to another person, they can be given the Key Card instead of the smartphone. To do so, the Key Card must be activated via iDrive.

Always take the vehicle key with you to a service appointment.

Additional information:

- ▶ BMW ID/driver profiles, refer to page 69.
- ▶ Key Card, refer to page 89.
- ▶ www.bmw.com/digitalkey

Functional requirements

- ▶ The smartphone is compatible with BMW Digital Key
- ▶ The vehicle is linked with the ConnectedDrive account of the vehicle owner.
- ▶ The rechargeable battery of the smartphone has a sufficient charge. The necessary minimum charge of the rechargeable battery depends on the smartphone.

Enabling the main digital key

Vehicle owner's smartphone is enabled as a main digital key in the vehicle. The vehicle

owner must prove his authorization for the vehicle for this purpose.

You can begin the authorization process using the My BMW app or using your activation code in the corresponding smartphone function, e.g., the Wallet app. Both vehicle keys must be in the vehicle during activation.

Follow the activation instructions in the Digital Key menu in the app or on the control display.

Sharing digital keys

General information

Digital key allows the sharing of digital keys with other people. This option is available via the smartphone that is enabled as main digital key. This function must be supported by the smartphone.

Forwarding authorization

To share the digital key, select the corresponding function on the smartphone, for instance in the Wallet app.

As soon as a digital key is shared with another person, the person will receive an invitation. When the invitation is accepted, the digital key on the recipient's smartphone will be activated.

Limiting the range of functions

Certain functions of the digital key can be limited before handing it over. For instance, if the Digital Key is passed on to a novice driver, the switch-off for driving stability control systems can be disabled and the engine power can be reduced. For more information, refer to the ConnectedDrive Portal and My BMW app.

Authentication

Depending on the recipient's smartphone model, an authentication may be required for security and safety reasons.

An authorized vehicle key, the main digital key or another method may be used for authenti-



ation. Follow the corresponding instructions on the smartphone or the control display.

Deleting digital keys

General information

Deleted digital keys will be removed from the list of enabled digital keys.

Deleted digital keys cannot be restored.

Deleting the main digital key

The main digital key can be deleted from the smartphone or via iDrive.

The deletion of the main digital key is completed immediately.

Deleting a shared key

Shared keys can be deleted using the smartphone with the master Digital Key, using the smartphone with the shared key to be deleted, or via iDrive.

The deletion via the smartphone using the main digital key will not be performed until the vehicle is used with a key other than the key to be deleted.

If the smartphone associated with a shared key or iDrive is used to delete a shared key, it will be deleted immediately.

Deletion via iDrive

To delete a digital key via iDrive, there must be an authorized vehicle key in the vehicle, or the master Digital Key must be in the smartphone tray.

1. Apps menu
2. "Vehicle"
3. "Doors and windows"
4. "Digital Key"
5. If necessary, select the digital key.
6. Delete the Digital Key.

Resetting the function

To reset the BMW Digital Key function, an authorized vehicle key must be located in the vehicle.

When resetting the BMW Digital Key function, all digital keys including the main digital key will be deleted. The Key Card digital key is not deleted.

After the reset, the vehicle can no longer be unlocked, locked or started with a digital key.

The main digital key must be enabled again to be able to use BMW Digital Key again.

1. Apps menu
2. "Vehicle"
3. "Doors and windows"
4. "Digital Key"
5. "Reset function"

Unlocking and locking the vehicle

The vehicle can be unlocked and locked as follows:

- ▶ Via the external door handle.
- ▶ With Comfort Access: depending on the national-market version, the vehicle can be locked and unlocked with no-touch activation.

Bluetooth must be activated on the smartphone for contactless unlocking and locking using the Digital Key.

BMW Digital Key availability and functionality depend on vehicle equipment and national-market version.

Additional information:

Access to the vehicle interior, refer to page [78](#).

Turning on the drive-ready state

Using the smartphone tray

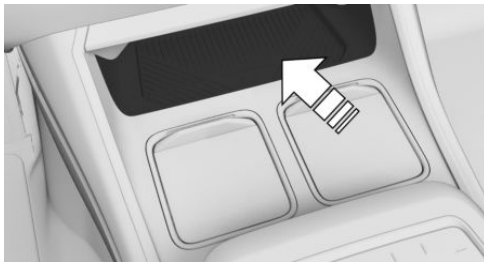

1. Place smartphone in the center of the smartphone tray.
Ensure that the display is facing up.
2. Press the Start/Stop button to turn on the drive-ready state.

In the interior

With Comfort Access, it is sufficient, depending on the country, for the smartphone with Bluetooth activated to be located inside the vehicle. Press the Start/Stop button to turn on the drive-ready state.

Sale of the smartphone

Delete all digital keys on the smartphone prior to selling the smartphone. This ensures that the smartphone can no longer be used for the vehicle.

Changing smartphones

To use a new smartphone as a master Digital Key, activate the new smartphone according to the instructions for the master Digital Key. The previous master key is deleted when the new smartphone is activated.

Sale of the vehicle

Prior to selling a vehicle, reset the Digital Key function or remove the vehicle from the ConnectedDrive account of the current vehicle owner.

When the vehicle is removed from the ConnectedDrive account, all digital keys for the vehicle will be deleted. The Key Card digital key is not deleted.

System limits

The interior motion sensor and tilt alarm sensor of the alarm system cannot be switched off with a digital key.

Additional information:

Alarm system, refer to page [97](#).

Malfunction

Digital key recognition by the vehicle may malfunction under the following circumstances:

- ▶ The smartphone is shielded from the sensors in the vehicle by a smartphone cover that is not suitable.
- ▶ Objects such as a chip card or the Key Card are located between the smartphone and the smartphone cover.
- ▶ Fault of the connection from transmission towers or other equipment with high transmitting power.
- ▶ Shielding of the smartphone due to buildings or metal objects.

Buttons for the central locking system

General information

The vehicle is automatically locked when driving off.

In the event of a severe accident, the vehicle is automatically unlocked. The hazard warning system and interior lights are illuminated.

Overview

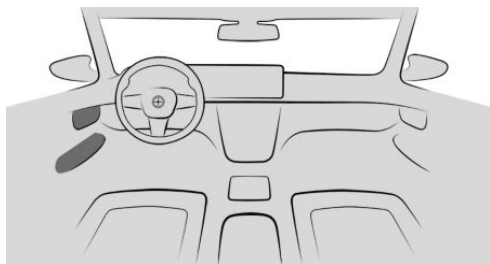

The central locking buttons are located on the front door.

Locking the vehicle



Press the button in the driver's door or front passengers door with the front doors closed.

The fuel filler flap remains unlocked.

The vehicle is not secured against theft when locking.

Unlocking the vehicle



Press the button.

Opening the door



Press the button.

The door is unlocked and slightly open.

Push the door outward.

Opening and closing automatic doors

The automatic doors can be opened and closed automatically or manually.

Additional information:

Automatic doors, refer to page [82](#).

Malfunction

General information

In case of a power failure, the doors can be unlocked manually.

Unlocking the door manually

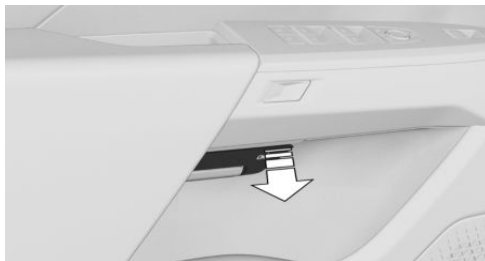

Pull the lever in the door to unlock it.

Soft-close automatic function

Principle

The soft-close automatic function reduces effort and noise when closing vehicle doors.

The door can be pushed into the door lock without effort and the door will close automatically.

Safety information

Warning

Body parts can be jammed while operating the doors. There is a risk of injury. Make sure that the area of movement of the doors is clear while opening and closing.

Closing

To close the doors, push lightly.

The closing process is automatic.

Valet parking mode

Principle

In the valet parking mode, the control display is disabled.

E.g., this mode can be used when the vehicle is handed over for valet parking.

General information

Depending on the national-market version, the valet parking mode may not be available.

Valet Parking mode has the following restrictions:

- ▶ Vehicle settings cannot be changed via iDrive.
- ▶ Settings stored to a BMW ID or guest profile cannot be changed.
- ▶ Personal data cannot be displayed.
- ▶ The volume of the audio system is limited.
- ▶ The integrated Universal Remote Control is deactivated.
- ▶ Dynamic Stability Control cannot be turned off.
- ▶ The availability of certain settings of the driving modes is limited.

Additional information:

BMW ID/driver profiles, refer to page [69](#).

Functional requirement

The driver has registered in the vehicle with a BMW ID.

Activating the valet parking mode

1.  Apps menu
2. "Vehicle"
3. "System settings"
4. "Valet parking mode"

5. "Lock tailgate"

The cargo area is locked and disconnected from the central locking system.

6. If necessary, "PIN"

If the active BMW ID does not have an assigned PIN, this PIN must be set now. The PIN is needed to deactivate the valet parking mode.

7. If necessary, enter the PIN.

8. "Activate valet parking mode"

Deactivating valet parking mode

1. Select the desired BMW ID on the lock screen.
2.  Enter the assigned PIN for the BMW ID.
If you have forgotten the PIN: enter the access data for the BMW ID.
 - ▶ If the selected BMW ID does not have an assigned PIN: enter the access data for the BMW ID.

Settings

General information

Depending on the equipment and national-market version, various settings for opening and closing are possible.

Unlocking and locking

Doors

1.  Apps menu
2. "Vehicle"
3. "Doors and windows"
4. "Lock/unlock"
5. "Unlock"
6. Select the desired setting:
 - ▶ "Driver's door only"



Only the driver's door and the fuel filler flap are unlocked. Pressing again unlocks the entire vehicle.

- ▷ "All doors"

The entire vehicle is unlocked.

Touchless unlocking/locking

1. Apps menu
2. "Vehicle"
3. "Doors and windows"
4. "Comfort access"
5. Select the desired setting.

Automatic unlocking

1. Apps menu
2. "Vehicle"
3. "Doors and windows"
4. "Lock/unlock"
5. Select the desired setting:
 - ▷ "Unlock doors at end of trip"
 - ▷ "Unlock doors when in P"

After drive-ready state is switched off, the locked vehicle is unlocked automatically by pressing the start/stop button or engaging selector lever position P.

Automatic locking

1. Apps menu
2. "Vehicle"
3. "Doors and windows"
4. "Lock/unlock"
5. "Lock after a short time"

The vehicle locks automatically after a short period of time if no door is opened after unlocking.

Confirmation signals from the vehicle

1. Apps menu
2. "Vehicle"

3. "Doors and windows"
4. "Lock/unlock"
5. Select the desired setting:
 - ▷ "Flash when unlocking"
Unlocking is confirmed by two flashes.
 - ▷ "Flash when locking"
Locking is confirmed by one flash.
 - ▷ With alarm system:
"Sound on lock/unlock"
Unlocking is confirmed with two sound signals, locking is confirmed with one sound signal.

Folding mirrors in automatically

1. Apps menu
2. "Vehicle"
3. "Doors and windows"
4. "Lock/unlock"
5. "Fold mirrors on lock/unlock"

Automatic doors

Operation using the brake pedal

The driver's door can be configured to close by pressing the brake pedal.

1. Apps menu
2. "Vehicle"
3. "Doors and windows"
4. "Automatic doors"
5. "Settings"
6. "Close door with brake"
7. Select the desired setting.

Opening and closing the driver's door contactlessly

1. Apps menu
2. "Vehicle"
3. "Doors and windows"

4. "Automatic doors"
5. "Settings"
6. Opening and closing automatically
7. Select the desired setting.

Cargo area

Cargo area and doors

1.  Apps menu
2. "Vehicle"
3. "Doors and windows"
4. "Tailgate"
5. Select the desired setting:
 - ▷ "Tailgate"

Depending on the equipment, the cargo area will be unlocked or opened.
 - ▷ "Tailgate and door(s)"

Depending on the equipment, the trunk will be unlocked or opened and the doors are unlocked.
 - ▷ "Tailgate will only open if vehicle is already unlocked"

The vehicle must be unlocked before the cargo area can be operated with the vehicle key.
 - ▷ "Lock tailgate button"

Operating the cargo area with the vehicle key is disabled.

Opening/closing the cargo area contactlessly

1.  Apps menu
2. "Vehicle"
3. "Doors and windows"
4. "Tailgate"
5. Select the desired setting.

Closing the sun protection automatically

It is possible to configure whether the roller sunblind closes automatically when the vehicle is locked.

1.  Apps menu
2. "Vehicle"
3. "Doors and windows"
4. "Close roof blind automatically"
5. Select the desired setting.

Alarm system

Principle

The alarm system issues a visual and acoustic signal when someone attempts to open the locked vehicle incorrectly.

General information

When the vehicle is locked, the vehicle alarm system reacts to the following changes:

- ▷ Opening a door, the hood, or the cargo area.
- ▷ Movements in the interior.
- ▷ Changes in the vehicle inclination such as during attempts at stealing a wheel or when towing the vehicle.
- ▷ Disconnected battery voltage.
- ▷ Improper use of the socket for OBD on-board diagnostics.
- ▷ Locking the vehicle while a device is connected to the diagnostic socket.

The alarm system signals these changes visually and acoustically:

- ▷ Acoustic alarm:

Depending on local regulations, the acoustic alarm may be suppressed.
- ▷ Optical alarm:

By flashing of the hazard warning system and headlights, where required.

Do not modify the system to ensure function of the alarm system.

Turning the alarm system on/off

The alarm system is turned on as soon as the vehicle is locked from the outside.

The alarm system is not switched on if the vehicle is locked from a greater distance with the My BMW App or manually from the inside.

The alarm system is switched off as soon as the vehicle is unlocked.

Opening the doors with the alarm system switched on

The alarm system is triggered when a door is opened if the door was unlocked using the integrated key in the door lock.

Opening the cargo area with the alarm system switched on

The cargo area can be opened even when the alarm system is switched on.

After closing the cargo area, the cargo area will be locked and monitored again. The hazard warning system flashes once during closing.

Panic mode

You can trigger the alarm system if you find yourself in a dangerous situation.



- ▶ Press the button on the vehicle key and hold for at least 3 seconds.
- ▶ Briefly press the button on the vehicle key three times in succession.

To switch off the alarm: press any button.

Indicator light on the interior mirror



- ▶ The indicator light flashes briefly every 2 seconds:

The alarm system is switched on.

- ▶ The indicator light flashes for approx. 10 seconds, then flashes briefly every 2 seconds:

Interior motion sensor and tilt alarm sensor are not active, as doors, hood, or tailgate are not correctly closed. Correctly closed access points are secured.

When the remaining open access points are closed, the interior motion sensor and tilt alarm sensor will be turned on.

- ▶ The indicator light flashes even though all access points have been closed:

Alarm system error.

- ▶ The indicator light goes out after unlocking:

The vehicle has not been tampered with.

- ▶ The indicator light flashes after unlocking until drive-ready state is switched on, but no longer than approx. 5 minutes:

The alarm has been triggered.

Tilt alarm sensor

The inclination of the vehicle is monitored.

The alarm system responds in situations such as attempts to steal a wheel or when the vehicle is towed.

Interior motion sensor

The vehicle interior is monitored.

The alarm system responds when movement is detected in the vehicle interior.

The windows must be closed for the system to function properly.

When the BMW Theater Screen is folded out, movement in the rear is only detected to a limited extent.

Avoiding unintentional alarms

General information

The tilt alarm sensor and interior motion sensor can trigger an alarm, although no unauthorized action occurred.

Possible situations for an unwanted alarm:

- ▶ In car washes.
- ▶ In duplex garages.
- ▶ During transport on trains carrying vehicles, at sea or on a trailer.
- ▶ With animals in the vehicle.
- ▶ When the vehicle is locked after start of refueling.

The tilt alarm sensor and the interior motion sensor can be switched off in such situations.

Switching off the tilt alarm sensor and interior motion sensor

- ▶  Press the button on the vehicle key within 30 seconds as soon as the vehicle is locked.

The indicator light illuminates for approx. 2 seconds and then continues to flash.

- ▶ After turning off the standby state, an option to turn off the interior motion sensor and the tilt alarm sensor will be displayed on the control display.

The tilt alarm sensor and interior motion sensor are switched off until the vehicle is locked again.

Ending the alarm

Unlock the vehicle.

If the vehicle is unlocked with the integrated key, the drive-ready state must subsequently be turned on via the emergency detection of the vehicle key.

Window

General information

When a window is frequently opened to the same position, this task can be performed by the BMW Intelligent Personal Assistant. This is useful if you frequently use the same parking garage, for example.

Additional information:

BMW Intelligent Personal Assistant, refer to page 53.

Safety information

Warning

When operating the windows, body parts and objects can be jammed. There is a risk of injury or risk of damage to property. Make sure that the travel path of the windows is clear while opening and closing.

With the vehicle key

Opening windows



Press and hold the button on the vehicle key after unlocking.

The windows open for as long as the button on the vehicle key is pressed.

Closing the windows



With Comfort Access: press and hold the button on the vehicle key after locking.

The windows close for as long as the button on the vehicle key is pressed.

Depending on the vehicle equipment, exterior mirrors are folded in unless they were folded in while locking. The exterior mirrors are not folded in when the hazard warning flashers are switched on.

On the external door handle

Principle

The windows can be closed using the external door handle without operating the vehicle key.

The vehicle key is automatically detected near the vehicle.

General information

The function is available with Comfort Access.

Depending on the national-market version, the windows can also be closed at the external door handle with compatible smartphones with digital key.

Additional information:

BMW Digital Key, refer to page 90.

Functional prerequisites

- ▶ Carry the vehicle key with you, for instance in your pants pocket.
- ▶ Bluetooth must be activated on the smartphone to close the window(s) using the digital key.

Closing the windows

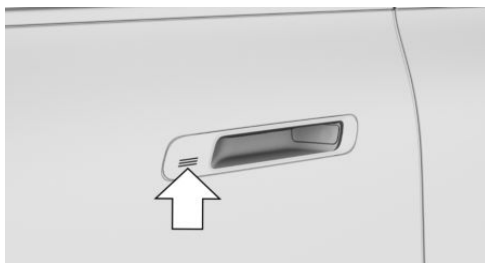

Touch the grooved surface on the external door handle of a closed front door with your finger and hold it there without grasping the recessed grip.

In addition to locking, the windows also closed.

Depending on the vehicle equipment, exterior mirrors are folded in unless they were folded in while locking. The exterior mirrors are not folded in when the hazard warning flashers are switched on.

In the interior

Overview

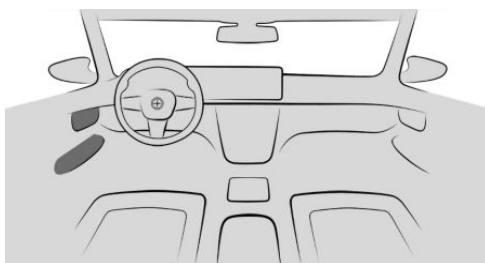



Power windows

Functional requirements



- ▶ Standby state is switched on.
- ▶ Drive-ready state is switched on.

The vehicle key or a digital key must be inside of the vehicle.

Opening windows

- ▷  Press the switch to the resistance point.
The window opens while the switch is being held.
- ▷  Press the switch beyond the resistance point.
The window opens automatically.
Pressing the switch again stops the motion.

Closing the windows

- ▷  Pull the switch to the resistance point.
The window closes while the switch is being held.
- ▷  Pull the switch beyond the resistance point.
The window closes automatically.
Pulling again stops the motion.

Jam protection system

Principle

The jam protection prevents objects or body parts becoming jammed between the door frame and window while a window is being closed.

General information

If resistance or blockage is detected while a window is being closed, the closing will be interrupted.



Safety information

Warning

Accessories on the windows such as antennas can impact jam protection. There is a risk of injury. Do not install accessories in the area of movement of the windows.

Closing without the jam protection system

In case of danger from the outside or if icing might prevent normal closing, proceed as follows:

1. Pull the  switch past the resistance point and hold it there.
The window closes with limited jam protection. If the closing force exceeds a specific threshold, closing is interrupted.
2. Pull the  switch past the resistance point again within approx. 4 seconds and hold it there.
The window closes without jam protection.

Window roller sunblinds

General information

The safety switch in the driver's door can be used to prevent, for instance, children from operating the roller sunblinds at the rear using BMW Touch Command.

Safety information

NOTICE

When operating the roller sunblind, objects stored on the rear shelf may damage the roller sunblind. There is a risk of damage to property. Make sure that the area of movement of the roller sunblind is clear during the operation.

Overview of rear doors

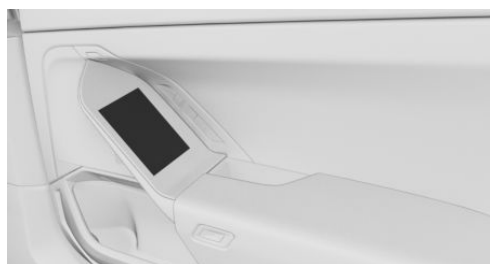

BMW Touch Command for operating the roller sunblinds.

Functional requirement

The affected window must be closed.

Operation

On the control display

1.  Apps menu
2. "Vehicle"
3. "Doors and windows"
4. "Sun blinds"
5. Select the desired function.

On the rear doors

Apply the setting using BMW Touch Command.

1.  Tap on the icon.
The main menu is displayed.
2. "Sun protection"
3. Tap the desired sun protection on the BMW Touch Command.

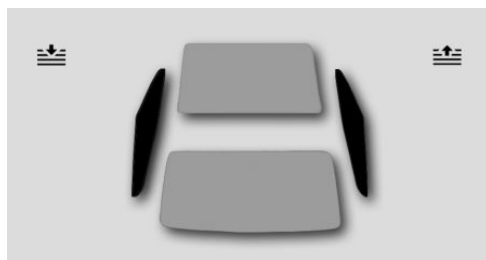

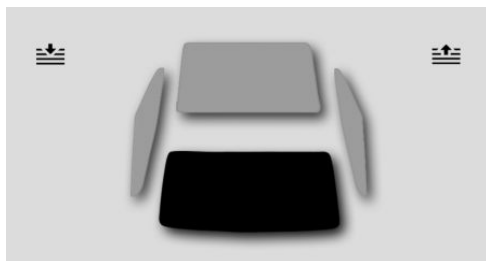

To open or close, tap the desired side sun protection.

If you tap the sun protection again while it is moving, the sun protection moves in the opposite direction.



To open or close, tap the rear window sun protection.

If you tap the sun protection again while it is moving, the sun protection moves in the opposite direction.

Icon	Function
	Open all roller sunblinds.
	Close all roller sunblinds.

System limits

If you are no longer able to move the roller sunblinds after having activated them consecutively a number of times, the overheating protection mechanism is active. The system is disabled for a limited time to prevent overheating. Let the system cool down.

The side roller sunblinds cannot be moved at low interior temperatures.

The LED in the button illuminates when the safety function is switched on.

Safety switch

Principle

With the safety switch, it is possible to disable particular functions in the rear. The locking of functions is useful, for instance, when children or animals are carried in the rear.

General information

The following functions can be disabled by pressing the safety switch:

- ▶ Open and close the rear windows using the switches in the rear or with the vehicle key.
- ▶ Open and close the roller sunblinds.
- ▶ Opening of rear doors by passengers in the rear.

The rear doors can only be opened from the outside.

- ▶ Unfold the BMW Theater Screen.

Overview

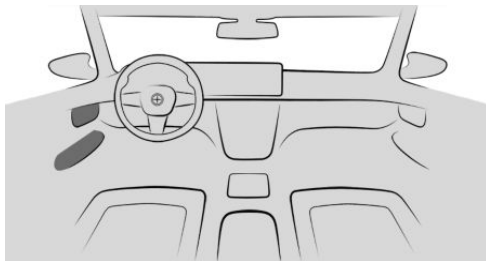

Safety switch

Turning the safety functions on/off



Press the button.

Seats, mirrors and steering wheel

Vehicle features and options

This chapter describes model-specific equipment, systems, and functions that are currently available, or may become available in the future, even if they are not present in the vehicle.

Additional information:

Vehicle equipment, refer to page 8.

Sitting safely

An ideal seat position that meets the needs of the occupants can make a vital contribution to relaxed, fatigue-free driving.

In the event of an accident, the correct seat position plays an important role. Follow the information in the following chapters.

Additional information:

- ▷ Seats, refer to page 104.
- ▷ Seat belts, refer to page 110.
- ▷ Head restraints, refer to page 112.
- ▷ Airbags, refer to page 174.

Seats, front

Safety information

Warning

Seat setting while driving can lead to unexpected movements of the seat. Vehicle control could be lost. There is a risk of accident. Only adjust the seat on the driver's side when the vehicle is stationary.

Warning

With a backrest inclined too far to the rear, the protective effect of the seat belt can no longer be ensured. There is a risk of sliding under the seat belt in an accident. There is a risk of injury or danger to life. Adjust the seat prior to starting the trip. Adjust the backrest so that it is in the most upright position as possible and do not adjust again while driving.

Warning

There is a danger of jamming when moving the seats. There is a risk of injury or risk of damage to property. Make sure that the travel path of the seat is clear prior to any adjustment.

Adjusting seats

General information

The current seat position can be stored using the memory function.

Overview



The switches for the seat settings are located at the front doors.

Seat settings menu

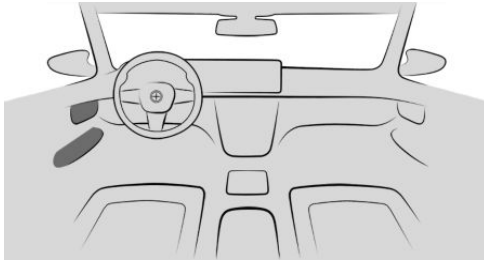

The seat adjustment menu button is located on the front door.



Press the button to go directly to the seat settings menu on the control display.

Setting the longitudinal direction

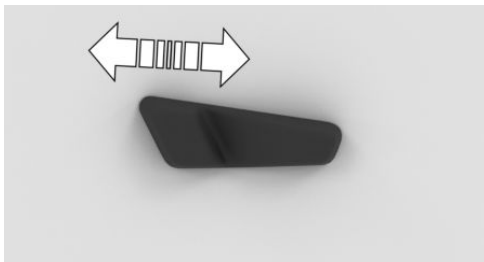

Press switch forward or backward.

Adjusting the height

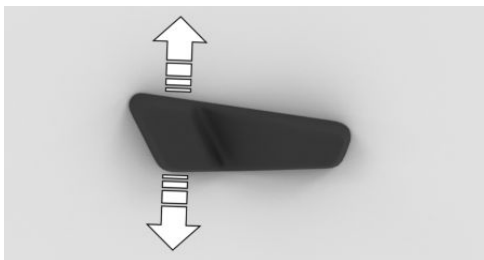

Press switch up or down.

Adjusting seat tilt

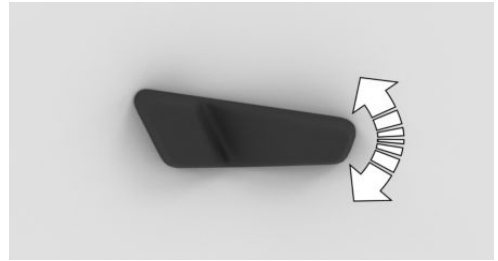

Tilt switch up or down.

Adjusting backrest tilt

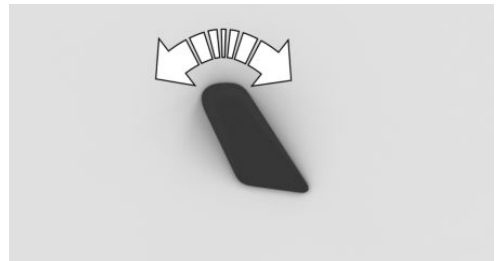

Tilt switch forward or backward.

Adjusting the seat position automatically

General information

The seat setting for the driver's seat is stored in the active BMW ID or in the active driver profile. If the BMW ID or the driver profile is reactivated at a later time, the saved position will be called up automatically.

Activate/deactivate the function

1.  Apps menu
2. "Vehicle"
3. "Seat comfort"
4. Select driver's seat.
5. "Use automatically"
6. Select the desired setting.



Thigh support

Multifunctional seat

1. Apps menu
2. "Vehicle"
3. "Seat comfort"
4. Select desired seat.
5. Select the desired function.
6. Select the desired setting.

Comfort adjustment

Principle

The thigh rest adjusts automatically when the longitudinal direction is adjusted.

Activate/deactivate the function

1. Apps menu
2. "Vehicle"
3. "Seat comfort"
4. Select desired seat.
5. "Comf. adjustm."

Lumbar support

Principle

The curvature of the seat backrest can be adjusted in a way that it supports the lumbar region of the spine. The lower back and the spine are supported for upright sitting position.

Adjusting the lumbar support

1. Apps menu
2. "Vehicle"
3. "Seat comfort"
4. Select desired seat.
5. Select the desired function.
6. Select the desired setting:
 - ▶ Press arrow left/right:

The curvature is increased/decreased.

- ▶ Press arrow up/down:

The curvature is shifted up/down.

Functional limitations

The lumbar support cannot be adjusted at very low temperatures.

Backrest width

Principle

Adjusting the backrest width may improve side support when cornering.

General information

The backrest width is changed by adjusting the side sections of the backrest.

When exiting the vehicle, the backrest width opens completely. The last set position is automatically applied before you start driving.

Adjusting the backrest width

1. Apps menu
2. "Vehicle"
3. "Seat comfort"
4. Select desired seat.
5. Select the desired function.
6. Select the desired setting.

Upper backrest

Principle

The upper backrest supports the back in the shoulder region. A correct setting leads to a relaxed seat position and reduces strain on the shoulder muscles.

General information

When exiting the vehicle, the upper backrest moves all the way back. The last set position is automatically applied before you start driving.

Adjusting the upper backrest

1.  Apps menu
2. "Vehicle"
3. "Seat comfort"
4. Select desired seat.
5. Select the desired function.
6. Select the desired setting.

Seat massage

Principle

The seat massage keeps your muscles relaxed and improves blood circulation in the lumbar region, which can help avoid fatigue.

Turning the seat massage on/off

1.  Apps menu
2. "Vehicle"
3. "Seat comfort"
4. Select desired seat.
5. "Massage"
6. "Seat massage"
7. Select the desired setting.

The seat massage is stopped when the lumbar support is operated.

Functional limitations

The massage function is not available at very low temperatures.

Calibrating the front seats

General information

As soon as the electric seat setting no longer functions precisely, a Check Control message is displayed on the control display.

To restore the accuracy of the electric seat setting, the front seats must be calibrated.

Safety information

Warning

There is a danger of jamming when moving the seats. There is a risk of injury or risk of damage to property. Make sure that the travel path of the seat is clear prior to any adjustment.

Calibrating the front seats

1. Press the longitudinal direction switch forward until the seat stops.
2. Press the switch forward and hold it until the seat stops moving forward.
3. Readjust the seat to the desired position.

As soon as the message on the control display disappears, the calibration is complete. If the message remains active, repeat the calibration.

If the message is still shown after repeated calibration, have the vehicle checked by an authorized service center or another qualified service center or repair shop.

If the vehicle is equipped with Executive Lounge Seating, have the front passenger seat calibrated by an authorized service center or another qualified service center or repair shop.

Rear seats

General information

Adjust the seat settings using BMW Touch Command.

Depending on vehicle equipment, the following seat settings are available:

- ▷ Longitudinal direction.
- ▷ Seat tilt.
- ▷ Backrest tilt.
- ▷ Upper backrest.

- ▷ Lumbar support.
- ▷ Executive Lounge Seating.
- ▷ Seat massage.

Safety information

Warning

There is a danger of jamming when moving the seats. There is a risk of injury or risk of damage to property. Make sure that the travel path of the seat is clear prior to any adjustment.

Warning

There is a danger of jamming when folding down the center armrest in the rear. There is a risk of injury. Make sure that the area of movement of the center armrest is clear during folding down.

Overview

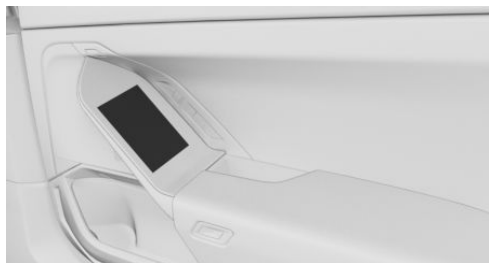

BMW Touch Command is located in the door handle of the rear doors.

Adjusting the seats

1. "Seats"
2. "Adjustment"
3. Select desired seat.
4. Select the desired function.
5. Select the desired setting.

Upper backrest

The upper backrest supports the back in the shoulder region. A correct setting leads to a relaxed seat position and reduces strain on the shoulder muscles.

Lumbar support

General information

The curvature of the seat backrest can be adjusted in a way that it supports the lumbar region of the spine. The lower back and spine are supported to promote an upright sitting position.

Functional limitations

The lumbar support cannot be adjusted at very low temperatures.

Executive Lounge Seating

Principle

The Executive Lounge Seating function enables rear passengers on the front passenger's side to travel more comfortably, e.g., by adjusting different seat functions.

Safety information

Warning

If the front passenger seat is set too far forward, the view from the front passenger window may be restricted, e.g., on the exterior mirror. There is a risk of accident. Adjust the front passenger seat such that the view from the front passenger window is not obstructed.

Retrieving the seat position

1. "Seats"
2. "Adjustment"



3. Tap on the icon.

Adjusting the seat position

1. "Seats"
2. "Adjustment"
3. Select desired seat.
4. Select the desired function.
5. Select the desired setting.

Adjusting the front passenger seat from the rear

The front passenger seat can be operated from the rear, for instance to increase the leg-room in the rear.

The front passenger seat can only be adjusted if no one is sitting on it.

1. "Seats"
2. "Adjustment"
3. Select desired seat.
4. Select the desired function.
5. Select the desired setting.

Leg rest

If there is sufficient distance between the front passenger seat and rear seat, the leg rest in the rear can be folded out electrically using BMW Touch Command.

The leg rest folds down with excessive load, for instance when a heavy object is placed on it. To return to the initial position, grasp the leg rest with both hands and lift until it clicks into place.

Footrest

If there is sufficient distance between the front passenger seat and rear seat, the footrest in

the rear can be folded out using BMW Touch Command.

Base position

Principle

The passenger side seats can be moved to a basic position to make it easier to get in and out of the vehicle.

Moving to the base position

1. "Seats"
2. "Adjustment"



3. Tap on the icon.

Seat massage

Principle

The seat massage keeps your muscles relaxed and improves blood circulation in the lumbar region, which can help avoid fatigue.

Turning the seat massage on/off

1. "Seats"
2. "Massage"
3. "On"
4. Select the desired setting.

Functional limitations

The massage function is not available at very low temperatures.

Locking the rear seats

Principle

The rear seat adjustment functions can be locked via the control display. Locking functions is useful, for instance, when children or animals are carried in the rear.

Activating/deactivating the setting

1.  Apps menu
2. "Vehicle"
3. "Seat comfort"
4. "Lock rear seats"
5. Select the desired setting.

Comfort exit

Principle

The seat position can be adjusted automatically to make it easier to get in and out of the vehicle.

General information

Front seats:

- ▶ The backrest width completely opens temporarily.
- ▶ The seat moves back.

Rear seats:

- ▶ The seat moves to the base position.
- ▶ The leg rest and foot rest move down.

Safety information

Warning

Because the leg rest folds in automatically when the door is opened, there is a risk that your leg may be trapped. There is a risk of injury or risk of damage to property. Before opening the door, make sure that the leg rest's travel path is clear.

Activating/deactivating the setting

Front seats:

1.  Apps menu
2. "Vehicle"
3. "Seat comfort"

4. "Comfort exit"
5. Select the desired setting.

Rear seats:

Depending on vehicle equipment, settings are applied automatically.

Seat belts

General information

The vehicle is fitted with five seat belts to ensure occupant safety. However, they can only offer protection when adjusted correctly.

Always make sure that seat belts are being worn by the occupants before driving off. The airbags supplement the seat belts as an additional safety device. The airbags do not replace seat belts.

All seat belt anchorage points are designed to achieve the best possible protective effect for the seat belts when used properly and with the correct seat settings.

The two outer seat belt buckles of the rear seats are intended for the persons sitting on the left and right.

The center seat belt buckle of the rear seats is intended for the person sitting in the middle.

Additional information:

Notes on sitting safely, refer to page [104](#).

Safety information

Warning

Use of a seat belt to buckle more than one person will potentially defeat the ability of the seat belt to serve its protective function. There is a risk of injury or danger to life. Do not strap in more than one person per single seat belt. Infants and children are not allowed on an occupant's lap, but must be

transported and secured in designated child restraint systems.

Warning

The protective effect of safety gear, including seat belts, can be limited or lost when seat belts are fastened incorrectly. An incorrectly fastened seat belt can cause additional injuries, for instance in the event of an accident, braking or evasive maneuvers. There is a risk of injury or danger to life. Make sure that all occupants are wearing seat belts correctly.

Warning

The protective effect of safety gear, including seat belts, may not be fully operational or fail in the following situations:

- ▷ The seat belts or seat belt buckles are damaged, soiled, or changed in any other way.
- ▷ Seat belt tensioners or roll-up mechanism were modified.

Seat belts can be imperceptibly damaged in the event of an accident. There is a risk of injury or danger to life. Keep clean and do not modify seat belts, seat belt buckles, seat belt tensioners, roll-up mechanisms, and belt anchors. After an accident, have the seat belts checked by an authorized service center or another qualified service center or repair shop.

Correct use of seat belts

- ▷ Wear the seat belt tight to your body over your lap and shoulders, without twisting it.
- ▷ Wear the seat belt deep on your hips over your lap. The seat belt must not press on your stomach.

- ▷ Do not rub the seat belt against sharp edges, or guide it or jam it in across hard or fragile objects.
- ▷ Avoid thick clothing.
- ▷ Re-tighten the seat belt frequently upward around your upper body area.

Buckling the seat belt

1. Guide the seat belt slowly over shoulder and hip to put it on.
2. Insert the buckle tongue into the seat belt buckle. The seat belt buckle must engage audibly.

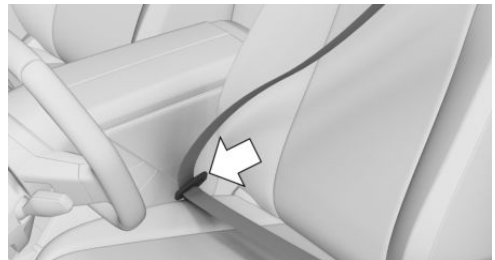

To ease accessibility to the seat belt buckle, an adjustable slider is available on the belt to help position the buckle when not in use.

Unbuckling the seat belt

1. Hold down the seat belt firmly.
2. Press the red button in the seat belt buckle.
3. Guide the seat belt back into its roll-up mechanism.

Seat belt reminder

General information

Make sure that the seat belts are positioned correctly.





The seat belt reminder becomes active in the following situations:

- ▷ When the seat belt on the driver's side or on the passenger's side is not fastened.
- ▷ When the seat belt is unfastened while driving.
- ▷ When objects are lying on a seat.

Display in the instrument cluster

The indicator light in the instrument cluster illuminates after turning on the drive-ready state when the seat belt reminder is active.

A Check Control message is displayed where applicable. Check whether the seat belt has been fastened correctly.

Icon	Meaning
	Seat belt on the driver's seat is not buckled.
	Seat belt on the passenger seat or another seat in the vehicle is not buckled.
	Seat belt is buckled on the corresponding seat.
	Seat belt is not buckled on the corresponding seat.

Rear Occupant Alert

Principle

At the end of a trip, the system informs the driver of the possible presence of occupants on the rear seats.

General information

If a door with access to the rear row seating is operated within 30 minutes before starting off, a message appears on the control display when the trip is completed and a signal tone sounds.

If the trip is continued within 30 minutes, the message is displayed again after the trip has been completed.

Activate/deactivate the function

1.  Apps menu
2. "System settings"
3. "Rear Occupant Alert"
4. Select the desired setting.

Front head restraints

Safety information

Warning

Removal or incorrect adjustment of head restraints can cause injuries in the head and neck area. There is a risk of injury.

- ▷ Before driving, install the removed head restraints on the occupied seats.
- ▷ Adjust the head restraint so its center supports the back of the head at as close to eye level as possible.
- ▷ Adjust the distance so that the head restraint is as close as possible to the back of the head. Adjust the distance via the backrest tilt as needed.

Warning

Body parts can be jammed when moving the head restraint. There is a risk of injury. Make sure that the area of movement is clear when moving the head restraint.

Warning

Objects on the head restraint reduce the protective effect in the head and neck area. There is a risk of injury.

- ▷ Do not use seat or head restraint covers.
- ▷ Do not hang objects, for instance clothes hangers, directly on the head restraint.
- ▷ Only use accessories that have been determined to be safe for attachment to a head restraint.
- ▷ Do not use any accessories, for instance pillows, while driving.

Active head restraint

In the event of a rear-end collision with a certain severity, the active head restraint automatically reduces the distance from the head.

Have the active head restraint checked and if necessary replaced in the case of damage or if it was exposed to an accident.

Adjusting the height

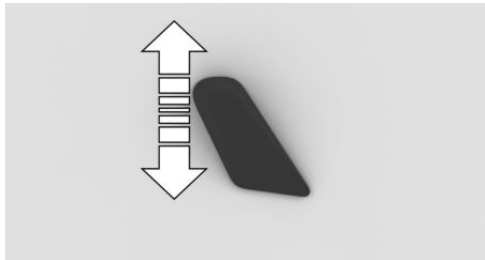

Press switch up or down.

Adjusting the distance: Manual head restraints



Press the button and push the head restraint forward or backward.

After setting the distance, make sure that the head restraint engages correctly.

Setting the distance: Multi-function seat

The distance to the back of the head is adjusted via the backrest inclination.

Adjust the distance so that the head restraint is as close as possible to the back of the head.

Removing the head restraints

The head restraints cannot be removed.

Rear head restraints

Safety information

Warning

Removal or incorrect adjustment of head restraints can cause injuries in the head and neck area. There is a risk of injury.

- ▷ Before driving, install the removed head restraints on the occupied seats.
- ▷ Adjust the head restraint so its center supports the back of the head at as close to eye level as possible.
- ▷ Adjust the distance so that the head restraint is as close as possible to the back of the head. Adjust the distance via the backrest tilt as needed.

Warning

Body parts can be jammed when moving the head restraint. There is a risk of injury. Make sure that the area of movement is clear when moving the head restraint.

Warning

Objects on the head restraint reduce the protective effect in the head and neck area. There is a risk of injury.

- ▷ Do not use seat or head restraint covers.
- ▷ Do not hang objects, for instance clothes hangers, directly on the head restraint.
- ▷ Only use accessories that have been determined to be safe for attachment to a head restraint.
- ▷ Do not use any accessories, for instance pillows, while driving.

Folding down the middle head restraint

General information

To improve the view to the rear, the center head restraint can be folded down. Only fold down the head restraint if no one will be sitting in the center seat.

Folding down the head restraint

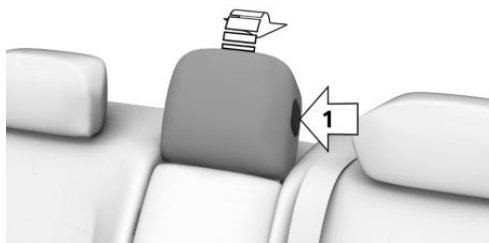

Press button, arrow 1, and fold the head restraint back.

To return the head restraint to its initial position, fold the head restraint forward as far as it will go. Make sure that the head restraint engages correctly.

Adjusting the height: manual head restraints

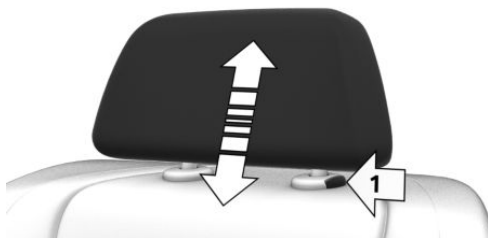

- ▷ To lower: press the button, arrow 1, and push the head restraint down.
 - ▷ To raise: push the head restraint up.
- After setting the height, make sure that the head restraint engages correctly.

Adjusting the height: Electric head restraints

General information

The height adjustment of the head restraint is deactivated when the safety switch for the rear windows has been pressed.

Additional information:

Safety switch, refer to page 103.

Adjusting the height

1. "Seats"
2. Select desired seat.
3. Select the desired function.
4. Select the desired setting.

Removing the head restraint

The head restraints cannot be removed.

Pillow for head restraints in the rear

General information

Cushions can be attached to the outer head restraints for increased comfort while driving.

Safety information

Warning

The protective effect of the head restraints may be limited or counteracted if the cushion is incorrectly fitted. There is a risk of injury. Make sure that the top edge of the cushion is below the mark.

Attaching cushions

1. Attach the cushion with the clip to the tab on the back of the head restraint.

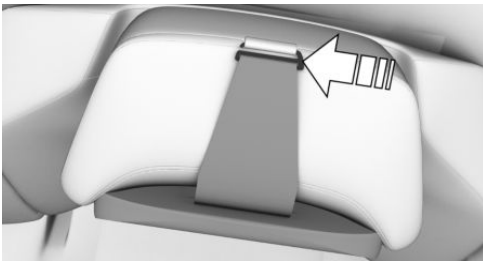

2. Bring the head restraint to a sufficiently high position.
3. Close the push-buttons.

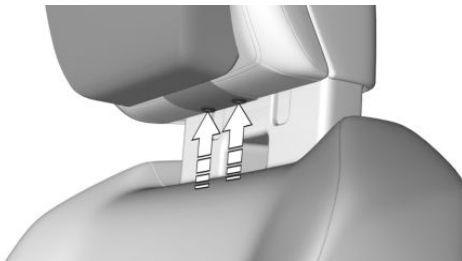

Adjusting the height

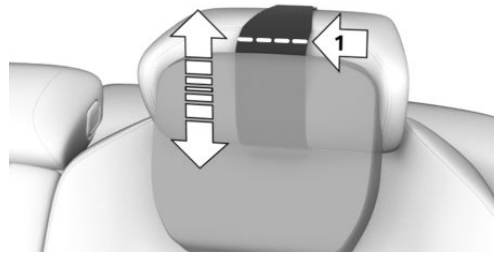

Grasp the cushion with both hands and slide it up or down.

Adjust the height so that the top edge of the cushion is below the mark, arrow 1.

Exterior mirrors

General information

The front passenger's side exterior mirror is more curved than the driver's side mirror.

The exterior mirror adjustment is stored in the active BMW ID or in the active driver profile. If the BMW ID or the driver profile is reactivated at a later time, the stored position is called up automatically.

The current exterior mirror adjustment can be stored using the memory function.

Safety information

Warning

Objects reflected in the mirror are closer than they appear. The distance to the road users behind could be incorrectly estimated, for instance while changing lanes. There is a risk of accident. Estimate the distance to the traffic behind by looking over your shoulder.

Overview



Icon	Meaning
	Fold the exterior mirror in and out.
	Adjust the exterior mirrors.
	Select left exterior mirror, Automatic Curb Monitor.
	Select right exterior mirror.



Fold the exterior mirror in and out.



Adjust the exterior mirrors.



Select left exterior mirror, Automatic Curb Monitor.



Select right exterior mirror.



Adjusting the exterior mirrors



Press the button.

The selected exterior mirror moves along with the button movement.

Selecting the exterior mirror

- ▶  Press the button to select the left exterior mirror. The LED illuminates.
- ▶  Press the button to select the right exterior mirror. The LED illuminates.

Malfunction

In case of an electrical malfunction, adjust the exterior mirror by pressing on the edges of the mirror glass.

Folding in/folding out the exterior mirrors

NOTICE

Depending on the vehicle width, the vehicle can be damaged in car washes. There is a risk of damage to property. Before washing, fold in the mirrors by hand or with the button.



Press the button.

Folding is possible up to a speed of approx. 15 mph/20 km/h.

Folding the exterior mirrors in and out is helpful in the following situations:

- ▶ In car washes.
- ▶ On narrow roads.

Exterior mirrors that were folded in are folded out automatically at a speed of approx. 25 mph/40 km/h.

Automatic heating

Both exterior mirrors are automatically heated as needed and when the drive-ready state is switched on.

Automatic dimming

The exterior mirror on the driver's side is automatically dimmed. Photocells in the interior mirror are used to control this.

Automatic Curb Monitor

Principle

If reverse gear is engaged, the mirror glass on the passenger's side is tilted downward. This improves your view of the curb and other low-lying obstacles when parking, for instance.

Activating the Automatic Curb Monitor

-  Press the button. The LED illuminates.
- Engage selector lever position R.

Deactivating the Automatic Curb Monitor

-  Press the button. The LED illuminates and the LED of the driver's side outside mirror goes out.

Interior mirror, automatic dimming feature

General information

The interior mirror is dimmed automatically. Photocells are used for control:

- ▷ In the mirror glass.
- ▷ On the rear of the mirror.

Overview



Functional requirements

- ▷ Keep the photocells clean.
- ▷ Do not cover the area between the interior mirror and the windshield.

Steering wheel

Safety information

Warning

Steering wheel adjustments while driving can lead to unexpected steering wheel movements. Vehicle control could be lost. There is a risk of accident. Adjust the steering wheel while the vehicle is stationary only.

Electric steering wheel adjustment

General information

The steering wheel adjustment is stored in the active BMW ID or in the active driver profile. If the BMW ID or the driver profile is reactivated at a later time, the stored position is called up automatically.

The current steering wheel position can be stored using the memory function.

To make it easier to enter and get out of the vehicle, the steering wheel moves temporarily into the upper position.

Adjusting the steering wheel position

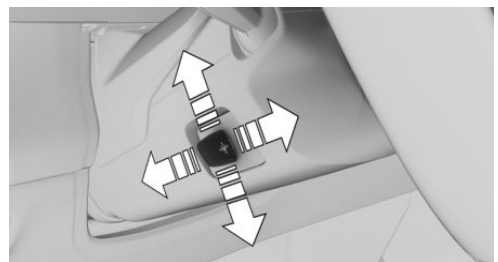

Press the switch to adjust the steering wheel forward/back position and height to the seat position.

Memory function

Principle

The following settings can be stored and, if necessary, retrieved using the memory function:

- ▷ Seat position.
- ▷ Exterior mirror adjustment.
- ▷ Steering wheel position.
- ▷ Lumbar support position.
- ▷ Height of the Head-up display.

Safety information

Warning

Using the memory function while driving can lead to unexpected seat or steering wheel movements. Vehicle control could be lost. There is a risk of accident. Only retrieve the memory function when the vehicle is stationary.

Warning



There is a danger of jamming when moving the seats. There is a risk of injury or risk of damage to property. Make sure that the travel path of the seat is clear prior to any adjustment.

Memory function, front

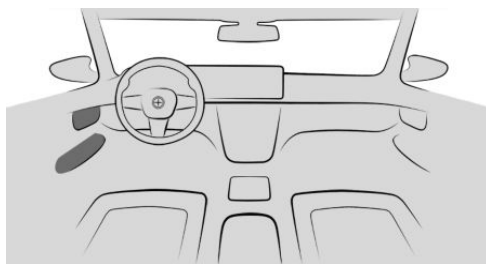
Overview



The memory buttons are located on the front doors.

Icon	Meaning
	SET button
	Memory button 1
	Memory button 2

Storing settings

Using the button:

1. Set the desired position.
2.  Press the button. The LED illuminates.
3. Press the desired memory button as long as the LED is illuminated. A signal sounds.

Via iDrive:

1.  Apps menu
2. "Vehicle"
3. "Seat comfort"
4. Select desired seat.
5. "Seat position"
6. Save the desired seat position.

Calling up settings

Using the button:

Press the desired memory button 1 or 2.

The stored position is called up.

The procedure stops when a seat setting switch or one of the memory buttons is pressed again.

The adjustment of the seat position on the driver's side is interrupted after a short time while driving.

Via iDrive:



1.  Apps menu
2. "Vehicle"
3. "Seat comfort"
4. Select desired seat.
5. "Seat position"
6. Select the desired seat position.

Memory function, rear

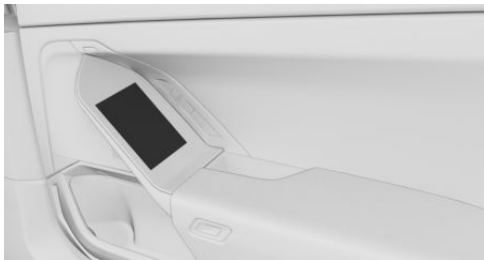
Overview



The memory function is operated via BMW Touch Command.

Icon	Meaning
	SET button
	Memory button 1
	Memory button 2

Storing settings

1. Set the desired position.
2. "SET"
3. Press the desired memory button 1 or 2.

Calling up settings

Press the desired memory button 1 or 2.

The stored position is called up.

The procedure stops when a seat setting switch or one of the memory buttons is pressed again.

Seat climate control

Various climate control functions are available for the seats.

Additional information:

Climate control, refer to page [274](#).

Transporting children safely

Vehicle features and options

This chapter describes model-specific equipment, systems, and functions that are currently available, or may become available in the future, even if they are not present in the vehicle.

Additional information:

Vehicle equipment, refer to page 8.

The right place for children

Safety information

Warning

Unattended children or animals in the vehicle can cause the vehicle to move and endanger themselves and traffic, for example, due to the following actions:

- ▷ Pressing the Start/Stop button.
- ▷ Releasing the parking brake.
- ▷ Opening and closing the doors or windows.
- ▷ Engaging selector lever position N.
- ▷ Using vehicle equipment.

There is a risk of accidents or injuries. Do not leave children or animals unattended in the vehicle. Take the vehicle key with you when exiting and lock the vehicle.

Warning

A hot vehicle may result in death to persons, especially children, or animals. There is a risk of injury or danger to life. Do not leave people, especially children, or animals unattended in the vehicle.

Warning

Exposure to intense sunlight can cause child restraint systems and their components to become very hot. Persons may sustain burn injuries when touching the hot components. There is a risk of injury. Do not expose the child restraint system to direct sunlight or cover where necessary. If necessary, let the child restraint system cool down before transporting a child. Do not leave children unattended in the vehicle.

Children in the rear seat

General information

Accident research shows that the safest place for children is in the rear seat.

Children younger than 13 years of age or shorter than 5 ft/150 cm should be transported in the rear seat in suitable child restraint systems designed for the age, weight and size of the child. Children 13 years of age or older must wear a seat belt as soon as a suitable child restraint system can no longer be used due to their age, weight, or size.

Safety information

Warning

The seat belt cannot be fastened correctly on children shorter than 5 ft/150 cm without suitable additional child restraint systems. The protective effect of safety gear, including seat belts, can be limited or lost when seat belts are fastened incorrectly. An incorrectly fastened seat belt can cause additional injuries, for instance in the event of an accident, braking or evasive maneuvers. There is a risk of injury or danger to life. Secure children

shorter than 5 ft/150 cm using suitable child restraint systems.

Children on the front passenger seat

General information

Before using a child restraint system on the front passenger seat, ensure that the front, knee, and side airbags on the passenger's side are deactivated.

Additional information:

For automatic deactivation of front passenger airbags, refer to page 176.

Safety information

Warning

Active front passenger airbags can injure a child in a child restraint system when the airbags are deployed. There is a risk of injury. Make sure that the front passenger airbags are deactivated and that the PASSENGER AIRBAG OFF indicator light illuminates.

Installing child restraint systems

General information

Pay attention to the specifications and the operating and safety information of the child restraint system manufacturer when selecting, installing, and using child restraint systems.

Safety information

Warning

The protective effect of child restraint systems and their fastening systems which have been damaged or exposed to an accident can be limited or lost. A child cannot be properly restrained in the event of an accident, braking or evasive maneuvers. There is a risk of injury or danger to life.

Do not use child restraint systems which have been damaged or exposed to an accident.

If attachment systems have been damaged or strained by an accident, have them checked and replaced by an authorized service center or another qualified service center or repair shop.

Warning

The stability of the child restraint system is limited or compromised with incorrect seat setting or improper installation of the child seat. There is a risk of injury or danger to life. Make sure that the child restraint system fits securely against the backrest. If possible, adjust the backrest tilt for all affected backrests and correctly adjust the seats. Make sure that seats and backrests are securely engaged or locked. If possible and necessary, adjust the height of the head restraints or remove them.

On the front passenger seat

Deactivating the airbags

Warning

Active front passenger airbags can injure a child in a child restraint system when the airbags are deployed. There is a risk of injury. Make sure that the front passenger airbags

are deactivated and that the PASSENGER AIRBAG OFF indicator light illuminates.

Before installing a child restraint system in the front passenger seat, make sure that the front, knee and side airbags on the passenger's side are deactivated.

Additional information:

For automatic deactivation of front passenger airbags, refer to page 176.

Seat position and height

After mounting a child restraint system, move the front passenger seat as far back as it will go and, if possible, to the lowest position. This seat position and height ensure the best possible position for the belt and offers optimal protection in the event of an accident.

After mounting a universal child restraint system, adjust the tilt of the seat backrest so that the belt is not constrained.

If the upper attachment point of the seat belt is located in front of the belt guide of the child restraint seat, move the front passenger seat carefully forward until the best possible belt guide position is reached.

Backrest width

Adjustable backrest width: Before installing a child restraint system on the front passenger seat, open the backrest width completely. Do not change the backrest width again and do not call up a memory position.

Child seat security

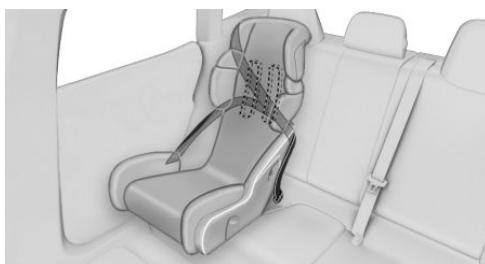

The seat belts in the rear and the front passenger seat belt can be permanently locked to fasten child restraint systems.

Locking the seat belt

1. Pull out the belt strap completely.
2. Secure the child restraint system with the seat belt.
3. Allow the belt strap to be pulled in and pull it tight against the child restraint system. The seat belt is disabled.

Unlocking the seat belt

1. Unbuckle the seat belt buckle.
2. Remove the child restraint system.
3. Allow the belt strap to be pulled in completely.

LATCH child restraint fixing system

General information

LATCH: Lower Anchors and Tether for Children.

Pay attention to the specifications, operating tips and safety instructions from the child restraint system manufacturer when selecting, installing, and using LATCH child restraint fixing systems.

Mounts for lower anchors

General information

The lower anchors may be used to attach the CRS to the vehicle seat up to a combined child and CRS weight of 65 lbs/30 kg when the child is restrained by the internal harnesses.

Safety information



Warning

If the lower anchors on child restraint system are not engaged correctly, the child restraint system will not be able to provide suitable protection. There is a risk of injury or danger to life. Make sure that the lower mountings are correctly engaged and that the child restraint system fits securely against the backrest.

Warning

The mounts for the lower mountings and attachment points of the child restraint system are intended for attaching child restraint systems only. If other objects are attached, the mounts or attachment points can be damaged. There is a risk of injury or risk of damage to property. Only attach child restraint systems at the corresponding mounts for the lower mountings or attachment points.

Position

Icon	Meaning
 	<p>The corresponding icon shows the mounts for the lower LATCH anchors.</p> <p>Seats equipped with lower mountings are marked with a pair (2) of LATCH icons.</p> <p>For vehicles equipped with a middle seat:</p> <p>It is not recommended to use the inner lower mountings of standard outer LATCH positions to fasten a child restraint system on the middle seat. Use the vehicle seat belt instead for the middle seat.</p>

Before attaching child restraint systems

Pull the seat belt away from the area of the child seat mountings.

Installing child restraint systems

1. Mount child restraint system, see manufacturer's information.
2. Make sure that the child restraint system mount is correctly engaged in the lower anchor on both sides.

With comfort rear seats: installation of child restraint systems

To mount the child restraint system in the rear, set the standard position. The function is operated via BMW Touch Command.

1. "Seats"
2. "Adjustment"
3. "Reset"

When the desired position is reached, a message is displayed:

"Default reached"

To facilitate installation, you may need to change additional settings:

1. Tilt the backrest slightly backward.
2. Mount child restraint system, see manufacturer's information.
3. Make sure that the child restraint system mount is correctly engaged in the lower anchor on both sides.
4. After installation, move the backrest back up slightly so that the child restraint system rests lightly against the backrest.

Child restraint systems with tether strap

General information

When attaching child restraint systems to the upper attachment points, observe the specifications and the operating and safety information of the child restraint system manufacturer.

Safety information

Warning

If the upper retaining strap is incorrectly used for the child restraint system, the protective effect is reduced. There is a risk of injury. Ensure that the upper retaining strap is guided to the upper attachment point without twisting and not over sharp edges.

Warning

If the rear seat backrest is not locked, the protective effect of the child restraint system is limited or nonexistent. In certain situations, for instance braking maneuvers or in case of an accident, the rear seat backrest can fold forward. There is a risk of injury or danger to

life. Make sure that the rear seat backrests are locked.

Warning

The mounts for the lower mountings and attachment points of the child restraint system are intended for attaching child restraint systems only. If other objects are attached, the mounts or attachment points can be damaged. There is a risk of injury or risk of damage to property. Only attach child restraint systems at the corresponding mounts for the lower mountings or attachment points.

Attachment points for upper retaining strap

Icon	Meaning
	The respective icon shows the attachment point for the upper retaining strap. Seats with an upper top tether are marked with this icon. It is located on the rear seat backrest, the rear shelf or the rear seat.

Routing the retaining strap

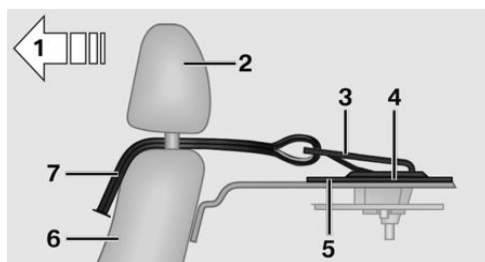

- 1 Driving direction
- 2 Head restraint
- 3 Hook for upper retaining strap
- 4 Attachment point

- 5 Rear shelf
- 6 Seat backrest
- 7 Upper retaining strap

The rear windows and doors are locked and cannot be operated in the rear.

The door can now be opened from the outside only.

Attaching the upper retaining strap to the attachment point

1. Open the attachment point cover.
2. Raise the head restraint.
3. Guide the upper retaining strap between or along both sides of the supports of the head restraint to the attachment point.
Center seat: guide the upper retaining strap over or along both sides of the head restraint to the attachment point.
4. Attach the hook of the retaining strap to the attachment point.
5. Tighten the retaining strap.

Locking the doors and windows in the rear

General information

In certain situations it may be advisable to secure the rear doors and windows, for instance when transporting children.

Button in vehicle

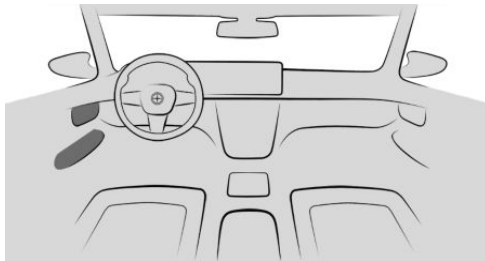

Press the button. The LED is illuminated when the safety function is turned on.

Driving

Vehicle features and options

This chapter describes model-specific equipment, systems, and functions that are currently available, or may become available in the future, even if they are not present in the vehicle.

Additional information:

Vehicle equipment, refer to page 8.

Start/Stop button

Principle

Pressing the Start/Stop button switches drive-ready state on or off.

General information

Drive-ready state is switched on when you depress the brake pedal while pressing the Start/Stop button.

Pressing the Start/Stop button again switches the drive-ready state back off and standby state is switched back on.

Additional information:

- ▶ Drive-ready state, refer to page 42.
- ▶ Standby state, refer to page 41.

Driving off

1. Turn on drive-ready state.
2. Apply gear position.
3. Driving off.

When stopping

Selector lever positions D, S, or R

On inclines, the system prevents rolling back against the set driving direction and provides drive-off support.

Driving off

Press the accelerator pedal to drive off.

The parking brake is released automatically.

Depending on the vehicle load or driving situation, the vehicle may roll back slightly.

Acoustic pedestrian protection

Depending on vehicle equipment and national-market version, Acoustic Pedestrian Protection generates a continuous driving noise in vehicles with electric or electrically assisted drives.

- ▶ With a stationary vehicle and drive-ready state turned on, as soon as the selector lever position P is exited.
- ▶ With electric driving up to approx. 20 mph/30 km/h.

A speaker system broadcasts the noise to the environment. As a result, other road users, for instance pedestrians or cyclists, can better perceive the vehicle.

Auto Start/Stop function

Principle

The Auto Start/Stop function helps save fuel. The system switches off the engine during a stop, for instance in traffic jam or at traffic lights. Drive-ready state remains switched on. The engine starts automatically for driving off.

General information

After each engine start using the Start/Stop button, the Auto Start/Stop function is ready.

The function is activated at low speeds.

Engine stop

Functional requirements

The engine is switched off automatically when stopping under the following conditions:

- ▷ The selector lever is in selector lever position D.
- ▷ The brake pedal remains depressed while the vehicle is at a standstill or the vehicle is held by Automatic Hold.
- ▷ The driver's seat belt is buckled or the driver's door is closed.

Manual engine stop

If the engine was not switched off automatically when the vehicle stopped, the engine can be switched off manually:

- ▷ Depress the brake pedal forcefully again from the current pedal position.
- ▷ Engage selector lever position P.

When all functional preconditions are fulfilled, the engine switches off.

Air conditioning system when the engine is switched off

The air flow from the air conditioning system is reduced when the engine is switched off.

Display in the instrument cluster



The display in the instrument cluster indicates that the Auto Start/Stop function is ready for an automatic engine start.

Functional limitations

The engine is not switched off automatically in the following situations:

- ▷ In case of a steep downhill grade.
- ▷ The brake pedal was not depressed hard enough.

- ▷ When the ambient temperature is high and automatic climate control is switched on.
- ▷ The vehicle interior has not yet been heated or cooled as desired.
- ▷ When window condensation is possible and automatic climate control is switched on.
- ▷ Engine or other parts are not at operating temperature.
- ▷ Engine cooling is required.
- ▷ Without Mild Hybrid technology: The wheels are at a sharp angle or the steering wheel is being turned.
- ▷ Vehicle battery is heavily discharged.
- ▷ At higher elevations.
- ▷ Hood is unlocked.
- ▷ The Automatic Parking Assistant is activated.
- ▷ For stop-and-go traffic.
- ▷ Selector lever position is in S, L, or R.
- ▷ After driving in reverse.

Starting the engine

Functional requirements

The engine starts automatically under the following preconditions:

- ▷ By releasing the brake pedal.
- ▷ When Automatic Hold is activated: step on the accelerator pedal.

Driving off

Accelerating as usual after starting the engine.

Safety mode

After the engine switches off automatically, it will not start again automatically if any one of the following conditions are met:

- ▷ The driver's seat belt is unbuckled and the driver's door is open.
- ▷ Hood was unlocked.



Some indicator lights illuminate for a varied length of time.

The engine can only be started via the Start/Stop button.

System limits

Even if driving off was not intended, the deactivated engine starts up automatically in the following situations:

- ▶ With excessive warming of the interior when cooling is turned on.
- ▶ With excessive cooling of the interior when heating is turned on.
- ▶ When window condensation is possible and automatic climate control is switched on.
- ▶ When changing the selector lever position from D or P to R.
- ▶ In case of seriously discharged vehicle battery.
- ▶ When starting an oil level measurement.

Deactivating the system manually

Principle

The engine is not automatically switched off. The engine is started during an automatic engine stop.

Via selector lever position or drive mode

The Auto Start/Stop function is deactivated by the following:

- ▶ With selector lever position S.
- ▶ In driving mode: "SPORT".

Switching off the vehicle during an automatic engine stop

If the engine stops automatically, the vehicle can be parked safely, for example to leave it.

1. Press the Start/Stop button.

- ▶ Drive-ready state is switched off.
- ▶ Standby state is switched on.
- ▶ Selector lever position P is engaged automatically.

2. Set the parking brake.

Automatic deactivation

In certain situations, the Auto Start/Stop function is deactivated automatically for safety reasons, for instance if no driver is detected.

Malfunction

The Auto Start/Stop function no longer switches off the engine automatically. A Check Control message is displayed. You may continue driving. Have the vehicle checked by an authorized service center or another qualified service center or repair shop.

Steptronic transmission

Principle

The Steptronic transmission is the vehicle's automatic transmission. With shift paddles, it offers the option of manual shifting if needed.

Safety information

Warning

An unsecured vehicle can begin to move and possibly roll away. There is a risk of accident. Before leaving your vehicle, secure it against rolling away, e.g., by applying the parking brake.

Selector lever positions

Gear position D

Selector lever position for normal driving. All gears for forward travel are activated automatically.

R reverse

Engage selector lever position R only when the vehicle is stationary.

N Neutral

The vehicle may be pushed or roll without power, for instance in car washes, in selector lever position N.

Parking position P

General information

Selector lever position, for instance for parking the vehicle. The transmission blocks the drive in selector lever position P.

P is engaged automatically

Selector lever position P is engaged automatically in situations such as the following:

- ▶ After drive-ready state is switched off, if selector lever position R, D, or S is engaged.
- ▶ After standby is switched off, if selector lever position N is engaged.
- ▶ The driver's seat belt is unbuckled and the driver's door is opened while the vehicle is stationary and selector lever position D, S, or R is engaged.

Before exiting the vehicle, make sure that selector lever position P is engaged and the parking brake is engaged. Otherwise, the vehicle may begin to move.

Additional information:

Parking brake, refer to page [137](#).

Engaging selector lever positions

General information

To prevent the vehicle from creeping after you select a gear position or reverse, maintain pressure on the brake pedal until you are ready to drive off.

Functional requirements

Only when the drive-ready state is switched on and the brake pedal is depressed is it possible to change from selector lever position P to another selector lever position.

The selection lever position P cannot be changed until all technical prerequisites are met.

Engaging selector lever position D, N, R

1. Fasten driver's seat belt.
2. Tilt or pull the selector lever into the desired direction, past a resistance point, if needed. The selector lever automatically returns to the center position when released.



Engaging selector lever position P



Press the button.

The parking brake is engaged and the transmission lock is set.

Rolling or pushing the vehicle

General information

In some situations, the vehicle is supposed to roll without its own power for a short distance, for instance in a car wash or to be pushed.

Engaging selector lever position N

NOTICE

Selector lever position P is automatically engaged when standby state is switched off. The wheels are blocked. There is a risk of damage to property. Do not switch off standby if the vehicle is meant to coast, e.g., in a car wash.

1. Switch on drive-ready state while pressing on the brake pedal.
2. Depress the brake pedal.
3. Engage selector lever position N.
4. Switch off drive-ready state.

In this way, standby state remains switched on, and a Check Control message is displayed.

The vehicle can roll.

Selector lever position P is engaged automatically after approximately 35 minutes.

If the system is not operational, you may not be able to change the selector lever position.

Electronically unlock the transmission lock, if needed.

Additional information:

Electronic unlocking of the transmission lock, refer to page 131.

Kickdown

Kickdown is used to achieve maximum driving performance.

Step on the accelerator pedal beyond the resistance point at the full throttle position.

S Sport mode

Principle

The shifting points and shifting times in the Sport program are designed for sportier handling. The transmission, for instance shifts up later and the shifting times are shorter.

Activating the Sport program



Pull the selector lever from selector lever position D to D/S.

The engaged gear is displayed in the instrument cluster, for instance S1.

The sport program of the transmission is activated.

Ending the Sport program

Pull the selector lever to D/S.

D is displayed in the instrument cluster.

Displays in the instrument cluster

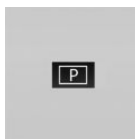

The selector lever position is displayed, for example P.

Electronic unlocking of the transmission lock

General information

Unlock the transmission lock electronically, e.g., to maneuver the vehicle out of a hazardous area in the event of a malfunction.

Before unlocking the transmission lock, secure the vehicle against rolling away, for instance with a wheel chock.

Engaging selector lever position N

1. Quickly press the Start/Stop button three times without stepping on the brake.
2. Depress the brake pedal.
3. Press the selector lever to position N.
An appropriate Check Control message is displayed.
Position N is indicated on the selector lever.
4. Maneuver the vehicle from the hazardous area and secure it against rolling away.

Shift paddles

Principle

The shift paddles on the steering wheel are used to change gears manually.

General information

Shifting

The vehicle only shifts at suitable RPM and road speeds.

Even in manual mode, the transmission shifts automatically in certain situations, e.g., when speed limits are reached.

Temporary manual mode

In selector lever position D, pulling a shift paddle switches into manual mode temporarily.

The engaged gear is also displayed in the instrument cluster, for instance D1.

After conservative driving in manual mode without acceleration or shifting via the shift paddles for a certain amount of time, the transmission switches back to automatic mode.

It is possible to switch into automatic mode:

- ▶ Pull and hold the right shift paddle until D is displayed in the instrument cluster.
- ▶ In addition to the pulled right shift paddle, pull the left shift paddle.

Continuous manual mode

In Sport program S, pulling a shift paddle switches to manual mode M permanently.

The engaged gear is displayed in the instrument cluster, for instance M1.

It is possible to switch into automatic mode:

- ▶ Pull and hold the right shift paddle until S is displayed on the instrument cluster.
- ▶ In addition to the pulled right shift paddle, pull the left shift paddle.
- ▶ Pull the selector lever to D/S.

When M2 is set manually while the vehicle is stationary, the transmission will no longer shift back to M1. This shift behavior is maintained until M1 is engaged manually or manual mode M is exited.

Shifting



- ▶ Upshifting: pull the right shift paddle.
- ▶ Downshifting: pull left shift paddle.



The selected gear is briefly displayed in the instrument cluster, followed by the current gear.

Advanced mode

General information

Depending on vehicle equipment, the Steptronic transmission offers an advanced mode with adapted shift characteristics.

- ▶ Automatic downshift to lowest possible gear.

If the left shift paddle is pulled and held, the Steptronic transmission automatically shifts down to the lowest possible gear.

- ▶ Avoid automatic upshifting in manual mode.

In manual mode, the Steptronic transmission does not shift up automatically when speed limits are reached.

- ▶ There is no downshifting for kickdown.

Enabling advanced mode

The advanced mode is enabled in manual mode when Dynamic Stability Control is disabled.

Depending on vehicle equipment, the advanced mode can also be enabled in manual mode as follows, for example:

- ▶ "SPORT PLUS": Setting under Drive in Sport Mode in My Modes.
- ▶ Increased driving dynamics enabled.

Launch Control

Principle

Launch Control enables optimum acceleration on roads with good traction under dry surrounding conditions.

General information

Using Launch Control causes premature component wear since this function represents a very heavy load for the vehicle.

Do not turn the steering wheel when driving off with Launch Control.

Do not use Launch Control when breaking in the vehicle.

Additional information:

Break-in, refer to page 308.

Functional requirement

Launch Control can be used when the engine is at operating temperature. The engine is at operating temperature after an uninterrupted trip of at least 6 miles/10 km.

Driving off with Launch Control

1. Turn on drive-ready state.



2. Press the button.

3. "Switch mode"

4. Select drive mode: "SPORT".

5. "Settings"

6. "Driving dynamics"

7. "SPORT PLUS"

8. With the left foot, press down forcefully on the brake.

9. Press the accelerator pedal all the way down and hold.

A destination flag is displayed in the instrument cluster.

10. The starting engine speed adjusts. Within 3 seconds, release the brake.

The vehicle accelerates.

Launch Control is active as long as the Launch Control information is displayed and the accelerator pedal is not released.

Repeated use during a trip

After Launch Control has been used, the transmission must cool down for a short time before Launch Control can be used again. Launch Control adjusts to the surrounding conditions when used again.

After using Launch Control

To support driving stability, reactivate Dynamic Stability Control as soon as possible.

System limits

An experienced driver may be able to achieve better acceleration values in DSC OFF without Launch Control mode.

Sport Boost function

Principle

The SPORT BOOST function can be used for upcoming acceleration, for example.

The system prepares the vehicle for the upcoming acceleration process. The response characteristics of the accelerator pedal become more sporty.

General information

The Sport Boost function is operated with the shift paddles on the steering wheel.

Overview



The shift paddles for the Sport Boost function are located on the steering wheel.

Display in the instrument cluster

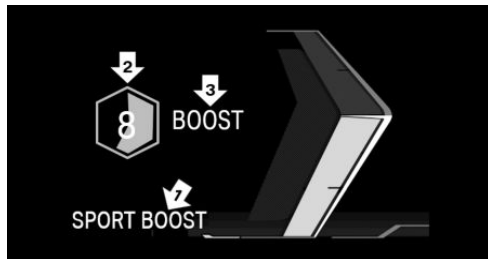

- ▶ Arrow 1: The function is active.
- ▶ Arrow 2: Countdown, the function is active.
- ▶ Arrow 3: The function is used for maximum acceleration.

Using the function

1. SPORT BOOST: Pull and hold the left shift paddle until this display appears, arrow 1.
 - ▶ The function is active.
 - ▶ A countdown is displayed on the instrument cluster, arrow 2.
2. Before the countdown changes to 0, press the accelerator pedal.
 - ▶ The vehicle accelerates.
 - ▶ BOOST: This display is shown on the instrument cluster, arrow 3.

The countdown can be restarted, for example if the function cannot be used immediately.

To restart the countdown, pull and hold the left shift paddle again until the countdown is reset.

Stopping the function

The function is automatically interrupted if the countdown has reached 0 or if the function was used in the acceleration process.

Deactivating the function

Pull and hold the right shift paddle until this display goes out.

My Modes

Principle

My Modes influence vehicle handling characteristics and the staging of the overall experience in the interior.

The vehicle can be adapted depending on the situation using the various My Modes.

General information

Depending on the equipment, the following systems are affected, for instance:

- ▷ Drivetrain.
- ▷ Steering.
- ▷ Chassis.
- ▷ Cruise control.
- ▷ Display in the instrument cluster.
- ▷ Comfort features in the vehicle interior.
- ▷ Drive sound.

Overview

Button in the vehicle

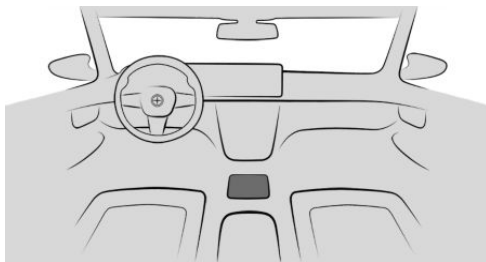

Displays in the instrument cluster



If applicable, the driving mode selected is displayed on the instrument cluster.

My Modes in detail

General information

Various My Modes are available depending on vehicle equipment.

My Modes that influence the handling characteristics are also referred to as driving mode.

Personal Mode

Driving mode for comfort oriented settings.

Sport Mode

Driving mode for increased agility of the vehicle.

Individual settings can be entered such as for driving dynamics, chassis and drivetrain.

"SPORT PLUS": with this setting under driving dynamics, the Dynamic Stability Control and thereby the driving stability will be limited.

- ▷ Dynamic Stability Control, refer to page 212.
- ▷ Setting for increased driving dynamics, refer to page 213.

Efficient Mode

Driving mode for a consumption optimized setting with anticipatory display.

Additional information:

Efficient mode, refer to page 314.

Theater Mode

Mode for a luxurious entertainment experience for rear-seat occupants.

Handling characteristics are set in a comfort-oriented manner.

More My Modes

Depending on the vehicle equipment, more My Modes are available that change the ambiance in the vehicle interior:

- ▷ Expressive Mode.
- ▷ Digital Art Mode.
- ▷ Relax Mode
- ▷ Silent Mode

Selecting My Modes



1.  Press the button.
2. "Switch mode"
3. Select the desired mode.

Configuring My Modes

Some modes can be configured individually.



1.  Press the button.
2. Select mode.
3. "Settings"
4. Select the desired settings.

Changing the start mode

Some modes can be set as the start mode.

The start mode set is enabled when drive-ready state is switched on.

1.  Press the button.
2. Select mode.
3. "Settings"
4. "Start mode"

My Modes Design

Specific depictions of a mode can be shown on the control display under My Modes Design.

1.  Press the button.
2. "My Modes design"

Operation in rear

General information

Some modes can be selected in the rear using BMW Touch Command.

For safety reasons, it is not always possible to change My Modes, e.g., when drive-off assistance is enabled or if vehicle handling is influenced as a result.

Overview

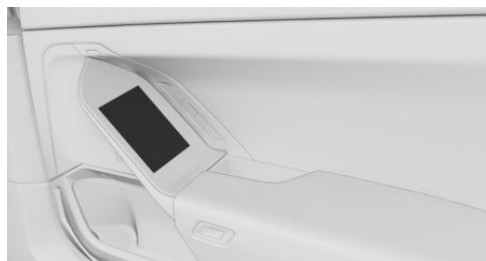

BMW Touch Command is located in the door handle of the rear doors.

Selecting My Modes

1. Tap on the icon.
2. "My Modes"
3. Select the desired mode.

Additional information:

BMW Touch Command, refer to page 58

My Programs

Principle

Various vehicle functions in the vehicle interior are adapted to each other in a program.

When you select a program, the interior lighting, climate control, and music selection will be adjusted, among other things.

Safety information

Warning

People or animals in the vehicle can lock the doors from the inside and lock themselves in. In this case, the vehicle cannot be opened from the outside. There is a risk of injury. Take the vehicle key with you so that the vehicle can be opened from the outside.

Warning

For some national-market versions, unlocking from the inside is only possible with particular knowledge.

If persons or animals spend a lengthy time in the vehicle and are thereby exposed to extreme temperatures, there is a risk of injury or danger to life. Do not lock the vehicle from the outside when there are people or animals in it. Do not leave babies, toddlers or animals alone in the vehicle.

Functional requirements

Various requirements must be met for the programs:

"Vitalize":

- ▷ Selector lever position D is engaged.
- ▷ The driver's door is closed.
- ▷ Automatic climate control is turned on.
- ▷ My Mode Theater Mode must be deactivated.

"Power Nap":

- ▷ Standby state is switched on.
- ▷ The parking brake is set.
- ▷ All doors, flaps, the hood and the tailgate are closed.
- ▷ Automatic climate control is turned on.
- ▷ The state of battery charge is sufficient.
- ▷ No objects or persons on the rear seat.

My Programs in detail

My Programs	Description
"Vitalize"	This program lasts three minutes and revitalizes occupants using music and certain comfort settings.
"Power Nap"	This program creates an atmosphere that encourages sleep, allowing you to use long stops to relax.
"HAPPY KIDS"	This program creates an atmosphere that encourages sleep for children in the rear.

Activating/deactivating My Programs

1.  Apps menu
2. "All apps"

3. ▷ "Vitalize"
 - ▷ "Power Nap"
 - ▷ "HAPPY KIDS"
4. Select the desired setting.

Parking brake

Principle

The parking brake is used to prevent the vehicle from rolling away when it is parked.

Safety information

Warning

An unsecured vehicle can begin to move and possibly roll away. There is a risk of accident. Before leaving the vehicle, secure the vehicle against rolling away.

In order to ensure that the vehicle is secured against rolling away, follow the following:

- ▷ Set the parking brake.
- ▷ On uphill grades or on downhill slopes, turn the front wheels in the direction of the curb.
- ▷ On uphill grades or on downhill slopes, also secure the vehicle, for instance with a wheel chock.

Warning

Unattended children or animals in the vehicle can cause the vehicle to move and endanger themselves and traffic, for example, due to the following actions:

- ▷ Pressing the Start/Stop button.
- ▷ Releasing the parking brake.
- ▷ Opening and closing the doors or windows.
- ▷ Engaging selector lever position N.
- ▷ Using vehicle equipment.

There is a risk of accidents or injuries. Do not leave children or animals unattended in the vehicle. Take the vehicle key with you when exiting and lock the vehicle.

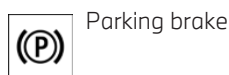
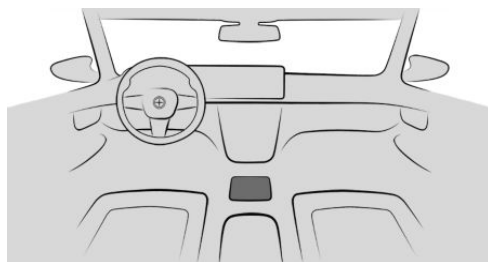

Overview

Button in the vehicle





Setting the parking brake

With a stationary vehicle

-  Press the button.
The LED illuminates.
-  The indicator light in the instrument cluster illuminates red.
The parking brake is engaged and transmission lock is engaged.

While driving

Use while driving serves as an emergency braking function.

-  Press and hold this button. The vehicle brakes hard as long as the button is pressed.
-  The indicator light in the instrument cluster illuminates red, a signal sounds, and the brake lights illuminate.

A Check Control message is displayed.

The parking brake is engaged and the transmission lock is set when the vehicle is stationary.

Engaging the parking brake automatically

In some situations, the parking brake is engaged automatically, e.g., through Automatic Hold.

Additionally, the system can be set to automatically engaging the parking brake when the drive-ready state is turned off.

1.  Apps menu
2. "Vehicle"
3. "Driving settings"
4. "Drivetrain and chassis"
5. "Parking brake"
6. Select the desired setting.

In selector lever position N, the parking brake will not be engaged automatically.

Releasing the parking brake

Releasing the parking brake manually

1. Turn on drive-ready state.
2.  Press the button while pressing on the brake pedal.
The LED and the indicator light go out.
The parking brake is released.
The transmission lock remains engaged until a gear position is selected.

Releasing the parking brake automatically

The parking brake is released automatically when you drive off.

The LED and the indicator light go out.

Using the parking brake via iDrive

The parking brake can also be engaged or disengaged via iDrive. Additionally, further information is displayed.

1.  Apps menu
2. "Vehicle"
3. "Driving settings"
4. "Drivetrain and chassis"
5. "Parking brake"
6. Select the desired setting.

Malfunction



If the parking brake fails or malfunctions, secure the vehicle so that it does not roll away before you exit.

A Check Control message is displayed.

Secure the vehicle against rolling away, for instance with a wheel chock, after getting out of the vehicle.

After a power interruption

To reestablish parking brake operability after a power interruption, an initialization may be required.

1. Turn on standby state.
2.  Press the button.
3.  Press the button again after 2 seconds.
The Check Control messages for the parking brake go out.
Possible function-related noises are normal.

 The indicator light indicates that the parking brake is ready for operation again.

Automatic Hold

Principle

Automatic Hold assists the driver by automatically setting and releasing the brake such as when moving in stop-and-go traffic.

When a gear position is engaged, the vehicle is automatically held in place when it is stationary.

On uphill grades the system prevents the vehicle from rolling back when driving off.

General information

The parking brake is automatically engaged under the following conditions:

- ▷ Drive-ready state is switched off.
- ▷ The driver's door is open for more than one second and no pedal is pressed during this time.
- ▷ The moving vehicle is brought to a standstill using the parking brake.

In selector lever position N, Automatic Hold is temporarily deactivated.

Safety information

Warning

An unsecured vehicle can begin to move and possibly roll away. There is a risk of accident. Before leaving the vehicle, secure the vehicle against rolling away.

In order to ensure that the vehicle is secured against rolling away, follow the following:

- ▷ Set the parking brake.
- ▷ On uphill grades or on downhill slopes, turn the front wheels in the direction of the curb.
- ▷ On uphill grades or on downhill slopes, also secure the vehicle, for instance with a wheel chock.

Warning

Unattended children or animals in the vehicle can cause the vehicle to move and endanger themselves and traffic, for example, due to the following actions:

- ▷ Pressing the Start/Stop button.
- ▷ Releasing the parking brake.
- ▷ Opening and closing the doors or windows.
- ▷ Engaging selector lever position N.
- ▷ Using vehicle equipment.

There is a risk of accidents or injuries. Do not leave children or animals unattended in the vehicle. Take the vehicle key with you when exiting and lock the vehicle.

Overview

Button in the vehicle

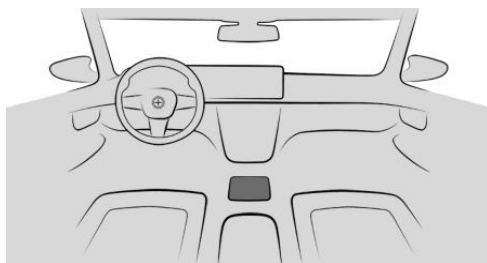

 Automatic Hold

Activating Automatic Hold

1. Turn on drive-ready state.

2.  Press the button.
The LED illuminates.

-  The indicator light illuminates green.
Automatic Hold is activated.

After every vehicle restart, the last selected setting is active.

Automatic Hold holding the vehicle

Automatic Hold is activated and the driver's door is closed.

 After stopping, the vehicle is automatically secured against rolling away as soon as the indicator light illuminates green.

Driving off

Press the accelerator pedal to drive off.

The brake is released automatically and the indicator light of the parking brake is no longer illuminated.

Automatic parking brake application

The parking brake is automatically set if drive-ready state is switched off while the vehicle is being held by Automatic Hold or if the vehicle is exited.

 The indicator light changes from green to red.

The parking brake is not set automatically if the drive-ready state was switched off while the vehicle was coasting. Automatic Hold is temporarily deactivated in this case.

Deactivate Automatic Hold

 Press the button.
The LED goes out.

 The indicator light goes out.

Automatic Hold is switched off.

If the vehicle is being held by Automatic Hold, also press on the brake pedal when switching off.

Displays

Vehicle features and options

This chapter describes model-specific equipment, systems, and functions that are currently available, or may become available in the future, even if they are not present in the vehicle.

Additional information:

Vehicle equipment, refer to page 8.

Instrument cluster

Principle

The instrument cluster comprises various digital displays, e.g., a speedometer, time, range, temperature as well as indicator and warning lights.

General information

The layout of the instrument cluster adapts to the respective driving mode. The positions of some displays may vary, e.g., the selector lever display.

Some of the displays in the instrument cluster may differ from the illustrations in the Owner's Manual.

Safety information

Warning

If the displays on the instrument cluster fail, do not use the vehicle. There may be a risk of accidents or risk of damage to property. Immediately park the vehicle in a safe manner. Turning drive-ready state off and on again may correct the malfunction, allowing you to continue driving. If the malfunction cannot be corrected, have the vehicle checked by an au-

thorized service center or another qualified service center or repair shop.

Overview

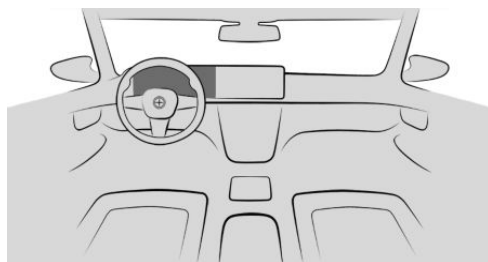

Instrument cluster

Display ranges on the instrument cluster

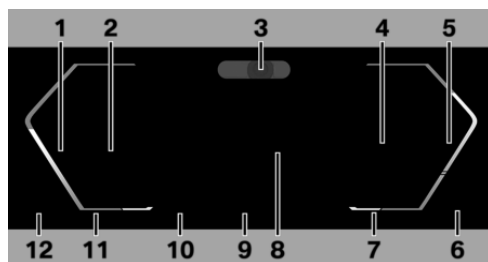

- 1 Speedometer
- 2 Driver assistance systems 216
Parking assistance systems 243
- 3 Driver Attention Camera 210
- 4 Check Control 144
Selector lever display 128
Gear shift indicator 152
Selection lists 151
Efficiency trainer 315
- 5 Power gauge 153
Tachometer 153



- 6 Engine temperature [154](#)
- 7 Outside temperature [154](#)
- 8 Central display range [155](#)
Shift lights [155](#)
- 9 My Modes drive mode [134](#)
- 10 Speed Limit Info [216](#)
Speed Limit Assistant [237](#)
- 11 Time [158](#)
- 12 Fuel gauge [159](#)
Range [159](#)

Additional information:

Indicator/warning lights, refer to page [145](#).

Operating elements on the steering wheel

Operating element	Function
-------------------	----------



Display the menu bar on the instrument cluster.



Turn knurled wheel: scroll selection up or down.

Tilt knurled wheel in corresponding direction: Move selection to left or right.

Press knurled wheel: confirm selection.

Configuring the layout

In Personal Mode drive mode, the layout in the instrument cluster can be individually configured and displayed.



1. Press the button on the steering wheel.

A menu bar is displayed in the instrument cluster.

2. "LAYOUT"

Select the menu by tilting the thumbwheel on the steering wheel where applicable.

3. Select the desired setting using the thumbwheel on the steering wheel.

Settings

Specific displays can be configured individually, e.g., a second actual speed.

1. Apps menu
2. "Vehicle"
3. "Displays"
4. "Instrument cluster"
5. Select the desired setting.

Live Vehicle

Principle

Live Vehicle is a virtual representation of your own vehicle with different information, e.g., vehicle status or energy flow indicators.

General information

Appropriate information is shown on the control display depending on the driving situation. Fault statuses are not taken into account.

Adaptive content

The following content is displayed in alternating order and, if necessary, depending on the selected drive mode:

- ▶ Vehicle status, refer to page [160](#).
- ▶ Current driving condition, refer to page [160](#).
- ▶ Sport displays, refer to page [161](#).
- ▶ Efficiency trainer, refer to page [315](#).
- ▶ Trip data, refer to page [156](#).

Static information

The following information may be shown permanently on the control display regardless of the driving situation and driving mode set.

- ▷ Vehicle status.
- ▷ Trip data.

Adjusting the display

In the Live Vehicle menu, you can choose between an adaptive display and static content.

1.  Apps menu
2. "Vehicle"
3. "Live Vehicle"
4. "Content"
5. Select the desired setting.

BMW Head-up display

Principle

The Head-up display projects important information, e.g., speed, onto the windshield in the driver's field of view. Information can be recorded without you having to look away from the road.

The steering wheel buttons can be used to configure various views for the Head-up display. Additional settings can be changed on the control display, e.g., brightness or height.

General information

Follow instructions for cleaning the Head-up display in the Vehicle Care chapter.

Additional information:

Caring for special components, refer to page [375](#).

Overview

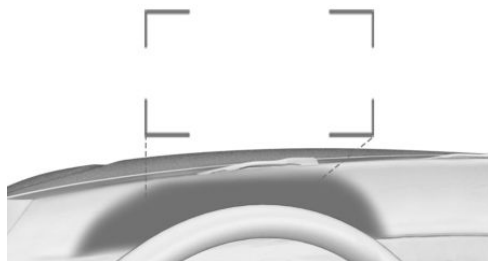

Head-up display views are projected onto the windshield using protective glass. The protective glass is located between the steering wheel and windshield.

Displayable information

The following information is displayed on the Head-up display:

- ▷ Vehicle speed.
- ▷ Navigation instructions.
- ▷ Check Control messages.
- ▷ Sport displays.
- ▷ Shift lights.
- ▷ Efficiency trainer.
- ▷ Lists and messages.
- ▷ Driver assistance systems.

Some of this information is only displayed briefly as needed.

Configuring a view

The views for the Head-up display can be set independently of the display on the instrument cluster, e.g., a reduced view.

1.  Press the button on the steering wheel.
A menu bar is displayed in the instrument cluster.
2. "HEAD-UP"



Select the menu by tilting the thumbwheel on the steering wheel where applicable.

3. Select the desired setting using the thumbwheel on the steering wheel.

Turning the Head-up display on/off

1. Apps menu
2. "Vehicle"
3. "Displays"
4. "Head-up display"
5. "Head-up display"

Settings

Individual settings can be entered for the Head-up display such as for the height, brightness or illustration. In addition, individual displays in the Head-up display can be set up separately such as for Driver Assistance.

1. Apps menu
2. "Vehicle"
3. "Displays"
4. "Head-up display"
5. Select the desired setting.

Visibility of the display

The visibility of the displays in the Head-up display is influenced by the following factors:

- ▷ Seat position.
- ▷ Objects on the Head-up display's protective glass.
- ▷ Dust or dirt on the Head-up display's protective glass.
- ▷ Windshield dirty on inside or outside.
- ▷ Sunglasses with certain polarization filters.
- ▷ Wet road.
- ▷ Unfavorable light conditions.

If the image is distorted, have the basic settings checked by an authorized service center or another qualified service center or repair shop.

Special windshield

The windshield is part of the system.

The shape and coating of the special windshield enable the system to function.

If damaged, have the special windshield replaced by an authorized service center or another qualified service center or repair shop.

Check Control

Principle

The Check Control system monitors functions in the vehicle and notifies you of faults in the monitored systems.

A Check Control message is displayed as a combination of indicator/warning lights and text messages on the instrument cluster and, if applicable, on the Head-up display. In addition, an acoustic signal may sound and a text message may appear on the control display.

Some Check Control messages are hidden automatically after approx. 20 seconds, but they will be stored. Stored Check Control messages can be displayed on the control display. Urgent Check Control messages are permanently displayed but can be hidden temporarily.

Hiding Check Control messages

Permanently displayed Check Control messages can be hidden temporarily. These messages are automatically displayed again after approx. 8 seconds.

◀ An arrow icon next to the Check Control message indicates whether the Check Control message can be hidden.



To hide Check Control messages, tilt the knurled wheel on the steering wheel to the left.



Displaying stored Check Control messages

Additional information such as the cause of a fault or the required action can be called up via Check Control.

Depending on the Check Control message, further help can be selected.

1.  Apps menu
2. "Vehicle"
3. "Vehicle status"
4. "Check Control"
5. Select the desired text message.

Display

A Check Control message is displayed in the instrument cluster as a text message with an icon.

For urgent messages, an added text is automatically displayed on the control display.

If several faults occur at once, the messages are displayed consecutively.

Certain messages displayed while driving are displayed again after drive-ready state is switched off.



Icons in the instrument cluster indicate an active or saved Check Control message.



Indicator lights and warning lights

Principle

The indicator lights and the warning lights on the instrument cluster show the status of some functions in the vehicle. The indicator and warning lights indicate faults in monitored systems.

General information

Indicator lights and warning lights can illuminate in a variety of combinations and colors.

Several of the lights are checked for proper functioning and illuminate temporarily when drive-ready state is turned on.

Red lights

Seat belt reminder



Seat belt on the driver's seat is not buckled.

Additional information:

Seat belt reminder, refer to page [111](#).

Airbag system



Warning light illuminates briefly: Indicates that the entire airbag system and seat belt tensioners are operational when drive-ready state is switched on.

Warning light does not illuminate or illuminates continuously: the airbag system or the seat belt tensioners may not be operational. Have the vehicle checked immediately by an authorized service center or another qualified service center or repair shop.

Additional information:

Airbags, refer to page [174](#).

Parking brake



The parking brake is set.

Additional information:

Parking brake, refer to page [137](#).

Brake system



The brake pads are worn or there is another issue with the brake system.



The braking assistance may not function. A higher pedal force may be required for braking.

Have the vehicle checked immediately by an authorized service center or another qualified service center or repair shop.

Emergency Stop Assistant



The Emergency Stop Assistant is triggered.

Additional information:

Emergency Stop Assistant, refer to page [202](#).

Risk of collision



Warning light illuminates or flashes in conjunction with an acoustic signal if there is risk of imminent collision.

Additional information:

Forward Collision Mitigation, refer to page [179](#).

Pedestrian Warning



Warning light illuminates: risk of collision with a person, e.g., a pedestrian or a cyclist. Increased awareness is required.

Warning light flashes and a signal sounds: risk of imminent collision with a person, e.g., a pedestrian or a cyclist. Immediately initiate braking or an evasive maneuver.

Additional information:

Warning function for pedestrians, refer to page [185](#).

Forward Collision Warning



Warning light illuminates: risk of collision, e.g., with a vehicle, is detected. Increased awareness is required.

Warning light flashes and a signal sounds: risk of imminent collision with a vehicle detected. Immediately initiate braking or an evasive maneuver.

Additional information:

Warning function in a rear-end collision situation, refer to page [182](#).

Intersection Collision Warning: vehicle detected from the right



Warning light illuminates: risk of collision with vehicle crossing from the right detected. Increased awareness is required.

Warning light flashes and a signal sounds: risk of imminent collision with a crossing vehicle detected. Immediately initiate braking or an evasive maneuver.

Additional information:

Warning function at intersections, refer to page [186](#).

Intersection Collision Warning: vehicle detected from the left



Warning light illuminates: risk of collision with vehicle crossing from the left detected. Increased awareness is required.

Warning light flashes and a signal sounds: risk of imminent collision with a crossing vehicle detected. Immediately initiate braking or an evasive maneuver.

Additional information:



Warning function at intersections, refer to page [186](#).

Distance Control



Warning light flashes and acoustic signal sounds: Brake and evade as necessary.

Additional information:

Distance control, refer to page [223](#).

Assisted Driving Mode



Warning light flashes and acoustic signal sounds:

The system is switched off or will be interrupted very soon.

Warning light illuminates and acoustic signal sounds:

The driver's line of sight is not directed at the surrounding traffic. Yellow: System interruption is imminent. The system reduces the speed to a standstill if applicable. It is possible that the system will not execute any supporting steering movements.

Additional information:

Assisted Driving Mode, refer to page [229](#).

Assisted Driving Mode: Hands are not on steering wheel



Warning light illuminates and acoustic signal sounds:

The hands are not on the steering wheel or, depending on the vehicle equipment and national-market version, the driver's line of sight is not directed at the surrounding traffic. Yellow: System interruption is imminent.

The system reduces the speed to a standstill if applicable.

It is possible that the system will not execute any supporting steering movements.

Immediately grasp the steering wheel with your hands and pay attention to the surrounding traffic.

Additional information:

Assisted Driving Mode, refer to page [229](#).

Yellow lights

Antilock Braking System



The system may not be operational. The Antilock Braking System is not available.



The ability to steer may be restricted during full braking.

Have the vehicle checked immediately by an authorized service center or another qualified service center or repair shop.

Additional information:

Antilock Braking System, refer to page [212](#).

Assisted Driving Mode



Warning light illuminates and acoustic signal sounds: A system interruption is imminent.

Warning light flashes: A lane boundary has been crossed.

Additional information:

Assisted Driving Mode, refer to page [229](#).

Assisted Driving Mode: Hands are not on steering wheel



Hands are not grasping the steering wheel. The system is still active.

Grab the steering wheel with your hands.

Additional information:

Assisted Driving Mode, refer to page [229](#).

Dynamic Stability Control



Warning light flashes: Dynamic Stability Control is regulating the driving and brake power. The vehicle is stabilized.

Reduce the vehicle speed and adjust your driving style to the road conditions.

Warning light illuminates: Dynamic Stability Control has malfunctioned or is initializing.

Driving stabilization is restricted or has failed.

If the warning light illuminates continuously, have the vehicle checked immediately by an authorized service center or another qualified service center or repair shop.

Additional information:

Dynamic Stability Control, refer to page [212](#).

The Dynamic Stability Control deactivated or increased driving dynamics activated



Dynamic Stability Control is deactivated or enhanced driving dynamics is activated.

Additional information:

- ▷ Dynamic Stability Control, refer to page [212](#).
- ▷ Setting for increased driving dynamics, refer to page [213](#).

Flat tire monitor



Warning light illuminates: Flat tire or tire pressure loss has been detected.

Reduce your speed and stop cautiously. Avoid sudden braking and steering maneuvers.

Additional information:

Flat tire monitor, refer to page [341](#).

Tire pressure monitor



Warning light illuminates: Flat tire or tire pressure loss has been detected. Follow the information in the Check

Control message.

Warning light flashes then illuminates continuously: Flat tires or tire pressure losses cannot be detected.

- ▷ Fault caused by systems or devices with the same radio frequency: after leaving the area of the interference, the system automatically becomes active again.
- ▷ In the case of tires with special approval: the tire pressure monitor was unable to complete the reset. Reset the system again.
- ▷ Wheel without wheel electronics installed: Have it checked by an authorized service center or another qualified service center or repair shop as needed.
- ▷ Malfunction: have the vehicle checked by an authorized service center or another qualified service center or repair shop.

Additional information:

Tire pressure monitor, refer to page [334](#).

Steering system



The steering system may not be operational.

Have the vehicle checked by an authorized service center or another qualified service center or repair shop.

Additional information:

Integral Active Steering, refer to page [215](#).

Emissions



- ▷ The warning light illuminates: Worsening emissions, e.g., due to an incorrectly fitted fuel cap. Have

the vehicle checked as soon as possible.

- ▶ The warning light flashes under certain circumstances:

This indicates that there is excessive misfiring in the engine.

Reduce the vehicle speed and have the vehicle checked immediately; otherwise, serious engine misfiring within a brief period can seriously damage emission control components, in particular the catalytic converter.

Have the vehicle checked by an authorized service center or another qualified service center or repair shop.

Additional information:

Socket for OBD on-board diagnostics, refer to page [359](#).

Acoustic pedestrian protection



Acoustic pedestrian protection has malfunctioned. Increased caution when maneuvering.

If malfunctioning repeatedly, have the vehicle checked by an authorized service center or another qualified service center or repair shop.

Additional information:

Acoustic pedestrian protection, refer to page [126](#).

Green lights

Turn signal



Turn signal is on.

Unusually rapid flashing of the indicator light indicates that a turn signal bulb has failed.

Additional information:

Turn signal, refer to page [162](#).

Parking lights



Parking lights are switched on.

Additional information:

Parking lights, low beams, refer to page [165](#).

Low beams



Low beams are switched on.

Additional information:

Parking lights, low beams, refer to page [165](#).

Automatic High Beam Assistant



Low beams are switched on and the Automatic High Beam Assistant is activated.

High beams are switched on and off automatically depending on the traffic situation.

Additional information:

Automatic High Beam Assistant, refer to page [163](#).

Lane departure warning



Depending on vehicle equipment and national-market version:

Indicator light flashes: the system is performing a steering intervention.

Additional information:

Lane departure warning, refer to page [190](#).

Automatic Hold: vehicle is held automatically



Automatic Hold is ready to use. The vehicle is automatically held in place when it is stationary.

Additional information:

Automatic Hold, refer to page [139](#).

Automatic Hold: vehicle secured against rolling away

 The vehicle is automatically secured against rolling away after stopping.

Additional information:

Automatic Hold, refer to page [139](#).

Cruise Control

 The system is active.

Additional information:

Cruise control, refer to page [221](#).

Distance Control

 Indicator light illuminates: Vehicle has been detected ahead of you. The vehicle icon goes out if no vehicle has been detected ahead of you.

Indicator lamp is flashing: vehicle ahead is driving off.

Additional information:

Distance control, refer to page [223](#).

Speed Limit Assist

 The detected speed limit can be applied with the SET button. As soon as the speed limit has been applied, a green checkmark is displayed.

Additional information:

Speed Limit Assistant, refer to page [237](#).

Assisted Driving Mode

 The system supports the driver in keeping the vehicle within the lane.

Additional information:

Assisted Driving Mode, refer to page [229](#).

Lane Change Assistant: lane change in progress

 Arrow icon for lane change green: the system carries out a lane change.

Additional information:

Lane Change Assistant, refer to page [233](#).

Lane Change Assistant: lane change not possible

 Gray line for lane boundary on the appropriate side: system detected a lane change request. Lane change not currently possible.

Additional information:

Lane Change Assistant, refer to page [233](#).

Assisted Driving Mode Plus

 The system is active.

Additional information:

Assisted Driving Mode Plus, refer to page [234](#).

Blue lights

High beams

 High beams have been switched on.

Additional information:

High beams, refer to page [162](#).

Automatic High Beam Assistant

 High beams are switched on via the Automatic High Beam Assistant.

Additional information:

Automatic High Beam Assistant, refer to page [163](#).



Gray lights

Seat belt reminder



Seat belt on the passenger seat or another seat in the vehicle is not buckled.

Additional information:

Seat belts, refer to page [110](#).

Distance Control



Indicator light flashes: Conditions are not adequate for the system to work.

The system was deactivated but applies the brakes until you actively resume control by pressing on the brake pedal or accelerator pedal.

Additional information:

Distance control, refer to page [223](#).

Assisted Driving Mode



The system is on standby and does not manipulate steering movements.

System activates automatically as soon as all function conditions are fulfilled.

Additional information:

Assisted Driving Mode, refer to page [229](#).

Assisted Driving Mode Plus



The system is interrupted and will activate automatically as soon as all functional requirements are met.

Additional information:

Assisted Driving Mode Plus, refer to page [234](#).

White lights

Cruise Control with Distance Control



No Distance Control displayed since the accelerator pedal is being pressed.

Additional information:

Distance control, refer to page [223](#).

Assisted Driving Mode Plus



The system can be activated.

Additional information:

Assisted Driving Mode Plus, refer to page [234](#).

Selection lists

Principle

Lists can be displayed and, if necessary, used for certain functions in the instrument cluster or the Head-up display.

- ▷ Entertainment source.
- ▷ Current audio source.
- ▷ List of most recent telephone calls.

If necessary, the corresponding menu will open on the control display.

Displaying and using the list

The selection lists can be displayed and operated using the operating elements on the steering wheel.

Control elements **Function**



 Change the entertainment source.
Pressing the button again will close the currently displayed list.

 Show list of most recent telephone calls.

 Turn the knurled wheel: display the list for currently selected entertainment source or scroll up or down in the list.
Tilt knurled wheel in corresponding direction: Move selection to left or right.
Press knurled wheel: confirm selection.

3. Turn the knurled wheel to select a radio station.
4. Press the knurled wheel to confirm the selected radio station.

Example: changing the entertainment source

1.  Press the entertainment sources button.
2.  To select an entertainment source, turn the knurled wheel.
3. Press the knurled wheel to confirm the selected entertainment source.

Gear shift indicator

Principle

The shift point indicator recommends the gear that best suits the current driving situation. Using the optimal gear supports an efficient driving style.

General information

The gear shift indicator is active in manual mode M depending on vehicle equipment and national-market version.

Displays

Information on upshifting, downshifting, or engaged gear is displayed on the instrument cluster.

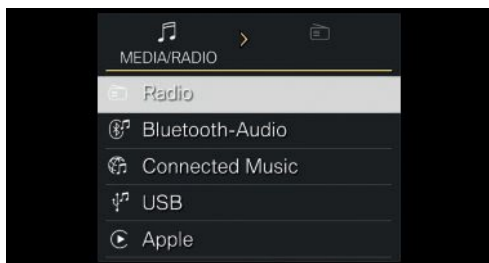

On vehicles without a gear shift indicator, the engaged gear is displayed.

Display



Selection lists, e.g., entertainment sources, are displayed on the instrument cluster.

Example: selecting a radio station

1.  Press the entertainment sources button.
2.  To switch to the radio stations list, tilt the knurled wheel to the right.

Example Description

M3

In continuous manual mode M:
Optimal gear is engaged.

D3

With shift paddles: temporary
manual mode.

S3

With shift paddles: Sport program.

2-3

Shift information.

Additional information:

Shift paddles, refer to page [131](#).

Power gauge

Principle

The power gauge indicates the currently drawn drive power as a percentage.

Enabling/disabling the power gauge

The power display or tachometer is shown depending on the driving mode selected or the individual configuration of the layout.

Display



Needle in range of arrow 1: display for energy recovery such as while decelerating CHARGE.

Needle in range of arrow 2: the drive power in percent, POWER.

Reduced drive power

The available power may be reduced due to certain factors. The power gauge is automatically adjusted accordingly.

In addition, the icons on the power gauge and tachometer indicate reduced drive power.

Icon**Description**

Blue icon: cold drivetrain.

White icon: increased drive system temperature, for instance due to sustained or high power demand when driving on mountain roads.



Depending on vehicle equipment and national-market version:

Drive power limitation defined via the BMW Digital Key.



System-related functional limitation.

A Check Control message is displayed in addition where applicable.

Tachometer

General information

Always avoid RPM in the red warning field. In this range, the fuel supply is reduced to protect the engine.

Activating/deactivating the tachometer

The tachometer is displayed depending on the selected drive mode or the individually configured layout.

The tachometer display changes depending on the selected driving mode.

Reduced engine speed range

The available engine speed range may be reduced due certain factors such as a cold drive system. The tachometer display is automatically adjusted depending on the available engine speed range.

Standby state and drive-ready state



OFF is displayed in the instrument cluster. Drive-ready state is turned off and standby state turned on.



READY is displayed in the instrument cluster. The Auto Start/Stop function is ready for automatic engine start.

Additional information:

- ▶ Operating condition of the vehicle, refer to page 40.
- ▶ Auto Start/Stop function, refer to page 126.

Engine temperature



- ▶ Cold engine: the needle is in the blue temperature range, close to the stop of the temperature display, and the word WARM-UP is displayed.

Drive at moderate RPM and vehicle speeds.

- ▶ Normal operating temperature: the needle is in the middle or in the left half of the temperature display.
- ▶ Hot engine: the needle is in the red temperature range. In addition, a Check Control message is displayed.

Additional information:

Coolant level, refer to page 355.

Display



- ▶ Cold engine: the needle is in the blue temperature range, close to the stop of the temperature display, and the word WARM-UP is displayed.

Drive at moderate RPM and vehicle speeds.

- ▶ Normal operating temperature: the needle is in the middle or in the left half of the temperature display.
- ▶ Hot engine: the needle is in the red temperature range. In addition, a Check Control message is displayed.

Additional information:

Coolant level, refer to page 355.

Indicator light in the instrument cluster



A red indicator light is displayed.

Outside temperature

General information

If the indicator drops to +37°F/+3°C or lower, a signal sounds.

A Check Control message is displayed.
There is an increased risk of ice on roads.

Safety information

Warning

Even at temperatures above +37 °F/+3 °C there is a risk of icy roads, for instance on bridges or shady sections of the road. There is a risk of accident. Modify your driving style to the weather conditions at low temperatures.

Shift lights

Principle

Shift lights indicate the suitable upshift point at which optimal acceleration can be achieved.

General information

The shift lights are active in manual mode M and can be displayed on the instrument cluster or on the Head-up display in combination with the tachometer.

Functional requirements

- ▷ Manual mode M must be activated.
- ▷ Advanced mode must be activated.

Additional information:

Advanced mode, refer to page [132](#).

Display



Successive fields illuminating yellow indicate an upcoming shift point.

- ▷ Shift when all fields illuminate red at the latest.
- ▷ When the maximum RPM is reached, the entire display flashes red and the fuel supply is interrupted in order to protect the engine.

Central display range

Displayable content

The following settings can be selected:

- ▷ Reduced display.
- ▷ Trip data, refer to page [156](#).
- ▷ Assisted View, refer to page [158](#).
- ▷ Navigation system route preview.
- ▷ Navigation system map view.
- ▷ G-Meter, refer to page [158](#).
- ▷ Entertainment.
- ▷ Augmented View.

Depending on vehicle equipment, Augmented View on the instrument cluster enables the visualization of driver assistance systems on the actual vehicle's surroundings.

Grey lines indicate the recommended minimum distance to the preceding vehicle



when speed control systems are deactivated.

▷ Android Auto©.

Depending on vehicle equipment and national-market version, select functions of a compatible smartphone can also be displayed, e.g., map views.

Some contents for the central display range can also be configured as a view in the Head-up display.

Additional information:

Head-up display, refer to page 143.

Owner's Manual for Navigation, Entertainment, and Communication, refer to page 6.

Configuring the central display range

The content of the central display range on the instrument cluster can be configured individually, for instance the trip data display.



1. Press the button on the steering wheel.

A menu bar is displayed in the instrument cluster.

2. "CONTENT"

Select the menu by tilting the thumbwheel on the steering wheel where applicable.

3. Select the desired setting using the thumbwheel on the steering wheel.

Trip data

Principle

The trip data display provides various information about the trip, e.g., average consumption or trip distance.

General information

The trip data can be displayed on the control display and in the instrument cluster.

Depending on the setting in the Live Vehicle menu, the trip data is shown on the control display.

The values can be displayed and reset depending on different intervals.

Display on the control display

General information

The following trip data is shown on the control display:

- ▷ Configured interval for displaying trip data.
- ▷ Average fuel consumption depending on the configured interval.
- ▷ Travel time depending on the configured interval.
- ▷ Distance traveled depending on the configured interval.
- ▷ Distance traveled in Coasting mode.

Displaying trip data continuously

1. Apps menu
2. "Vehicle"
3. "Live Vehicle"
4. "Content"
5. "Trip data"

Display in the instrument cluster

Information on consumption and distance covered can be displayed in the instrument cluster.

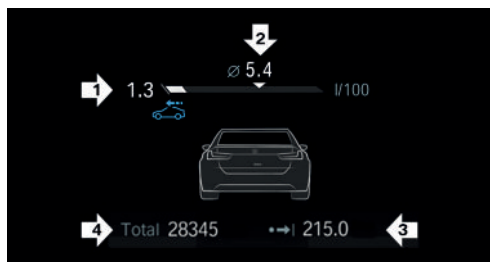

- ▶ Current consumption, arrow 1.
- ▶ Average consumption, arrow 2.
- ▶ Distance traveled depending on the configured interval, arrow 3.
 -  The icon is displayed when the vehicle is in Coasting mode.
- ▶ Total mileage, arrow 4.

Current consumption

The current fuel consumption display allows you to check the current fuel consumption, e.g., to drive economically and in an environmentally-friendly manner.

Mild hybrid technology: Depending on vehicle equipment, the fuel supply is interrupted and the engine continues to run when driving slowly or even when the vehicle is stationary. In this case, the internal combustion engine is operated electrically.

Average consumption

The average fuel consumption is displayed depending on how the intervals for displaying trip data are configured.

Adjusting the display of the trip data

The intervals for the display of the trip data in the instrument cluster and on the control display are adjustable.

1.  Apps menu
2. "Vehicle"
3. "System settings"

4. "Time period for trip data"
5. "Values"
6. Select the desired setting:
 - ▶ "Since start of trip ()": the values are automatically reset approx. four hours after the vehicle has come to a standstill.
 - ▶ "Since last refuel ()": the values are automatically reset after refueling with a larger quantity of fuel.
 - ▶ "Since factory": the values since the time of the factory delivery are displayed.
 - ▶ "Since Individual ()": the values since the last manual reset are displayed. The values can be reset at any time.

Resetting average values manually

The following interval can be reset manually at any time:

"Since Individual ()"

Using the thumbwheel on the steering wheel:

1. Display trip data in the instrument cluster.
2. Press and hold the  knurled wheel on the steering wheel until the values are reset.

Via iDrive:

1.  Apps menu
2. "Vehicle"
3. "System settings"
4. "Time period for trip data"
5. "Reset Individual"

The average values and counters are reset. Once the average values and counters have been reset, the following interval is automatically activated:

"Since Individual ()"

Assisted View

Principle

With Assisted View, information on driver assistance systems can be displayed on the instrument cluster with a vehicle animation.

Information on parking and maneuvering is displayed in the Assisted View whenever the parking assistance system is active.

Safety information

Warning

The system cannot serve as a substitute for the driver's personal judgment in assessing the traffic situation. Based on the limits of the system, it cannot independently react to all traffic situations. There is a risk of accident. Adjust driving style to traffic conditions. Watch the surrounding traffic situation closely, be ready to take over steering and braking at any time, and actively intervene where appropriate.

General

You can configure how Assisted View is displayed on the central display range.

Additional information:

Central display area, refer to page [155](#)

Display

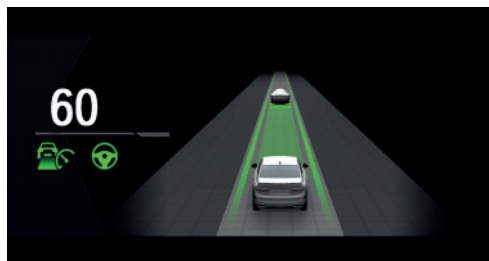

An example of active Driver Assistance: Indicator and warning lights for Distance Control and Assisted Driving Mode are displayed. At the same time, the Distance Control is animated in Assisted View.

System limits

The system's detection capability is limited.

Only objects that are detected by the system are taken into account.

Additional information:

- ▷ Cameras, refer to page [35](#).
- ▷ Radar sensors, refer to page [36](#).

G-Meter

General information

The G-Meter indicates the forces that are applied in longitudinal and transverse direction on the vehicle occupants while driving.

The display can be configured on the central display range of the instrument cluster.

The values are automatically reset whenever you start a new drive.

Additional information:

Central display area, refer to page [155](#)

Manually resetting G-Meter values

1. Display the G-Meter on the instrument cluster.
2.  Press and hold the thumbwheel on the steering wheel until the values are reset.

Date and time

Various settings can be applied for the date and time display such as the date format.

Depending on vehicle equipment and national-market version, the time zone can be set and automatic time setting can be activated. With automatic time setting, the time, date and, if necessary, the time zone are updated automatically.

1.  Apps menu
2. "Vehicle"
3. "System settings"
4. "Date and time"
5. Select the desired settings.

Fuel gauge

Principle

The current fill level of the fuel tank is displayed.

General information

Vehicle inclination may cause the display to vary.

Additional information:

Refueling, refer to page [318](#).

Display



An arrow beside the fuel pump icon shows which side of the vehicle the fuel filler flap is on.

The current range is displayed as numerical value.

Indicator light in the instrument cluster



The yellow indicator light illuminates, once the fuel reserve is reached.

Range

Principle

The range indicates the distance that can still be covered with the current tank of fuel.

General information

The estimated range with remaining fuel is permanently displayed on the instrument cluster.

With a low remaining range, a Check Control message is briefly displayed. A low remaining range means that engine functions cannot always be ensured for sporty driving, e.g., when cornering at speed.

The Check Control message appears continuously below a range of approx. 30 miles/50 km.

Safety information

NOTICE

With a range below 30 miles/50 km, the engine may no longer have sufficient fuel. Engine functions are not ensured anymore. There is a risk of damage to property. Refuel promptly.

Display

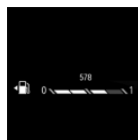

The current range is displayed as a numerical value next to the fuel gauge.

Setting the units of measurement

Depending on the national-market version, you can set the units of measurement for some

values, for instance consumption, distances, and temperature.

1.  Apps menu
2. "Vehicle"
3. "System settings"
4. "Units"
5. Select the desired setting.

Vehicle status





General information

The status can be displayed and actions performed for several systems such as for Check Control.

Displaying vehicle status

1.  Apps menu
2. "Vehicle"
3. "Vehicle status"

Overview

Icon	Description
	"FLAT TIRE MONITOR": Status of the flat tire monitor, refer to page 341.
	"Tire Pressure Monitor": status of the Tire Pressure Monitor, refer to page 334.
	"Engine oil level": electronic oil measurement, refer to page 353.
	"Check Control": displaying stored Check Control messages, refer to page 144.
	"Required services": display of the service notification, refer to page 161.

Current driving condition

General information

The current driving condition is displayed dynamically while driving in the Live Vehicle menu on the control display.

The following states can be displayed:

- ▷ Driving.
- ▷ Coasting mode: "EFFICIENT COASTING"
- ▷ "CHARGING BATTERY"

With mild hybrid technology:

- ▷ Adaptive recuperation.
Depending on the situation, additional information on adaptive recuperation is displayed.
- ▷ Efficient rolling with engine switched off.

Additional information:

- ▷ Adaptive recuperation, refer to page 313.
- ▷ Coasting, refer to page 314.

Functional requirements

- ▷ Personal or Efficient driving mode is selected.
- ▷ The following setting is selected for Live Vehicle: "Adaptive content"

Display

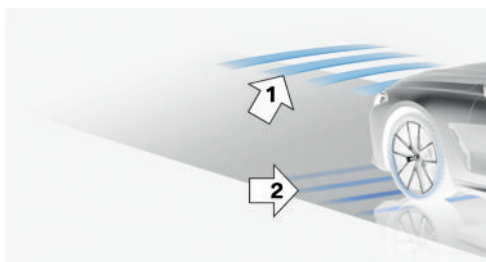

An example:

The adaptive recuperation is active, arrow 1.

The vehicle battery is charged when the vehicle decelerates, arrow 2.

Sport displays

Principle

The Sport displays especially support a sporty driving style.

Functional requirements

- ▶ SPORT driving mode is selected.
- ▶ The following setting is selected for Live Vehicle: "Adaptive content"

Display

The sport displays are displayed in the Live Vehicle menu on the control display.

The following information is displayed:

- ▶ Torque.
- ▶ Power.
- ▶ Boost pressure.
- ▶ Engine oil temperature.

Service notification

Principle

Service notifications indicate necessary maintenance measures.

General information

After turning on, the next service appointment or the distance remaining until the next servicing is displayed briefly on the instrument cluster.

A Service Advisor can read out the maintenance work from the vehicle key.

Display

More information on the maintenance measures required may be displayed on the control display.

1.  Apps menu
2. "Vehicle"
3. "Vehicle status"
4. "Required services"

Maintenance measures as well as legally mandated inspections are displayed.

5. Select the desired entry.

Entering appointment dates

Dates for mandatory vehicle inspections can be entered.

Make sure that the vehicle's date and time are set correctly.

1.  Apps menu
2. "Vehicle"
3. "Vehicle status"
4. "Required services"
5. "Vehicle inspection"
6. "Date:"
7. Select the desired setting.

Light and view

Vehicle features and options

This chapter describes model-specific equipment, systems, and functions that are currently available, or may become available in the future, even if they are not present in the vehicle.

Additional information:

Vehicle equipment, refer to page 8.

Turn signal

Turn signal in exterior mirror

When driving and during operation of the turn signals or hazard warning system, do not fold in the exterior mirrors so that the turn signal lamps on the exterior mirror are easy to see.

Flashing

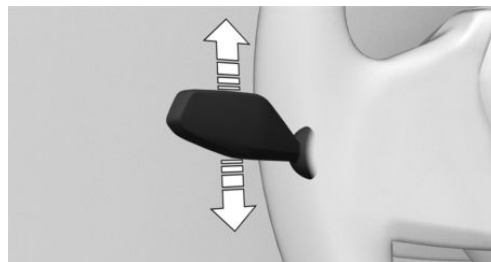

Press the lever past the resistance point.

One-touch signaling

Lightly tap the lever up or down.

The one-touch signaling duration can be adjusted.

1.  Apps menu
2. "Vehicle"
3. "Exterior lighting"

4. If necessary, "Additional settings"
5. "One-touch turn signal"
6. Select the desired setting.

Brief flashing

Press the lever to the resistance point and hold it there for as long as you want the turn signal to flash.

High beams, headlight flasher

Press the lever forward or pull it backward.



- ▶ High beams on, arrow 1.
The high beams illuminate when the low beams are switched on.
- ▶ High beams off/headlight flasher, arrow 2.



The indicator light in the instrument cluster illuminates when the high beams are turned on.

Automatic High Beam Assistant

Principle

The Automatic High Beam Assistant detects other road users early on and automatically switches the high beams on or off depending on the traffic situation.

General information

The Automatic High Beam Assistant ensures that the high beams are switched on, whenever the traffic situation allows. In the low speed range, the high beams are not switched on by the system.

The system responds to light from oncoming traffic and traffic driving ahead of you, and to ambient lighting, for instance in towns and cities.

The high beams can be switched on and off manually at any time.

Functional requirements

- ▷ Automatic headlight control is activated.
- ▷ Low beams are switched on.

Activating Automatic High Beam Assistant

1.  Apps menu
2. "Vehicle"
3. "Exterior lighting"
4. "Additional settings"
5. "Automatic High Beams"

 The indicator light in the instrument cluster is illuminated when the low beams are switched on.

The headlights are automatically changed between low beams and high beams.



The blue indicator light in the instrument cluster illuminates when the system switches on the high beams.

Interruption of the journey with activated Automatic High Beam Assistant: the Automatic High Beam Assistant remains activated when continuing the journey.

The Automatic High Beam Assistant is deactivated when manually switching the high beams on and off.



To reactivate the Automatic High Beam Assistant, press the turn signal lever up, arrow 1.

Deactivating Automatic High Beam Assistant



Press the turn signal lever forward, arrow 1, or pull the turn signal lever backward when the high beams are switched on, arrow 2.

When the Automatic High Beam Assistant is deactivated via iDrive, the operation with the turn signal lever is not possible.

Sensitivity of the Automatic High Beam Assistant

General information

The sensitivity of the Automatic High Beam Assistant can be adjusted.

Safety information

Warning

If adjustments have been made or the sensitivity has been modified, oncoming traffic may be momentarily blinded. There is a risk of accident. If adjustments have been made and the sensitivity has been modified, make sure that oncoming traffic is not momentarily blinded. Switch off the high beams manually if required.

Functional requirements

- ▶ Setting at standstill only.
- ▶ Drive-ready state is switched on.
- ▶ Light is turned off.

Increasing sensitivity

Push the turn signal lever to the front for approximately 10 seconds.

A Check Control message is displayed. The system responds more sensitively.

Resetting the sensitivity

Push the turn signal lever to the front again for approx. 10 seconds or switch off the drive-ready state.

The sensitivity of the Automatic High Beam Assistant is reset to the factory settings.

System limits

The Automatic High Beam Assistant cannot replace the driver's personal judgment of when

to use the high beams. When appropriate, dim the high beams manually.

The system may not be fully operational in the following situations, and driver intervention may be necessary:



- ▶ In very unfavorable weather conditions such as fog or heavy precipitation.
- ▶ When detecting poorly-lit road users such as pedestrians, cyclists, horseback riders and wagons; when driving close to train or ship traffic; or at animal crossings.
- ▶ In tight curves, on hilltops or in depressions, in crossing traffic or half-observed oncoming traffic on highways.
- ▶ In poorly-lit towns and cities or in the presence of highly reflective signs.
- ▶ When the windshield in front of the interior mirror is fogged up, dirty or covered with stickers, etc.

Exterior lighting



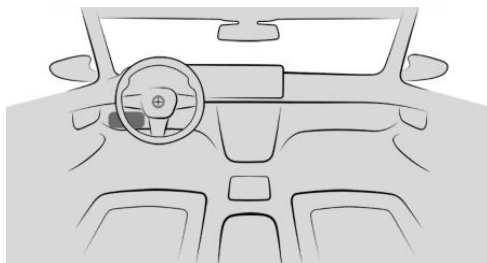



Overview

Buttons in the vehicle





Icon	Function
	Exterior lighting menu.
	Automatic headlight control. Low beams. Exterior lighting off.
	Exterior lighting off.

Functions via iDrive

Icon	Function
	Automatic headlight control.
	Low beams.
	Parking lights.
	Exterior lighting off.
	Left roadside parking light.
	Right roadside parking light.

Buttons on the vehicle key

Icon	Function
	Interior lighting. Parts of the exterior lighting.
	Pathway lighting.

Automatic headlight control

Principle

The low beams are switched on and off automatically depending on the ambient brightness, for example in tunnels, in twilight or if there is precipitation.

General information

A blue sky with the sun low on the horizon can cause the lights to be turned on.

If the low beams are switched on manually, the automatic headlight control is deactivated.

Activate automatic headlight control

 Press the button on the light switch.

The icon in the button illuminates green.

 The indicator light in the instrument cluster is illuminated when the low beams are switched on.

System limits

The automatic headlight control cannot replace your personal judgment of lighting conditions.

For example, the sensors are unable to detect fog or hazy weather. In these situations, turn the lights on manually.

Parking lights, low-beams and roadside parking lights

General information

If the driver's door is opened when the drive-ready state is switched off, the exterior lighting is automatically switched off after a period of time.

Parking lights

General information

The parking lights can only be switched on in the low speed range.

Turning on parking lights

1.  Apps menu
2. "Vehicle"
3. "Exterior lighting"
4. "Parking light"

 The indicator light in the instrument cluster illuminates.

The vehicle is illuminated on all sides.

Do not use the parking lights for extended periods; otherwise, they might drain the vehicle battery and it would then be impossible to switch on drive-ready state.

Turning off parking lights

The following options are available to turn off the parking lights:

▷  Press the button on the light switch.

▷  Press and hold the button on the light switch.

▷ Turn off light via iDrive.

▷ Turn on drive-ready state.

After the drive-ready state is switched on, the automatic headlight control will be activated.

Low beams

Turning on low beams

 Press the button on the light switch.

The low beams illuminate when drive-ready state is switched on.

 The indicator light in the instrument cluster illuminates.

Press the button again to switch on the low beams when the standby state is switched on.

Turning off low beams

Depending on the national-market version, the low beams can be turned off in the low speed range:

▷  Press the button on the light switch.

▷  Press and hold the button on the light switch.

▷ Turn off light via iDrive.

Roadside parking lights

When the vehicle is parked, a one-sided roadside parking light can be switched on.

1.  Apps menu
2. "Vehicle"
3. "Exterior lighting"
4. "Left roadside park. light" or "Right roadside park. light"

Welcome lights

Principle

The welcome light turns on automatically for a limited period of time when approaching or unlocking the vehicle.

General information

Depending on the equipment, the exterior lighting of the vehicle can be set individually.

Activating/deactivating welcome light

1.  Apps menu
2. "Vehicle"
3. "Exterior lighting"
4. If necessary, "Additional settings"
5. Depending on the equipment, select the following setting:
 - ▷ "Welcome and goodbye"

When unlocking the vehicle, individual lighting functions are turned on.
 - ▷ "BMW Iconic Glow"

The radiator grille lighting can only be adjusted when the vehicle is stationary and the drive-ready state is switched off.

Turning on the welcome light

- ▷ Automatically on approach.
- ▷ During unlocking.

- ▷  Press the button on the vehicle key with the vehicle locked.

Depending on the settings, the interior lighting and parts of the exterior lighting will be turned on.

The function is not available for the first 10 seconds after locking.

LED light carpet



The light source is located in the position indicated.

Keep the light source clean and unobstructed.

Pathway lighting

Principle

For the pathway lighting, the exterior lighting turns on for a certain period of time after leaving the vehicle in order to illuminate the area surrounding the vehicle.

Switching pathway lighting on

- ▷ After switching off the drive-ready state, briefly push the turn signal lever forward.

- ▷  Press and hold the button on the vehicle key for approx. 1 second.

Setting the duration

1.  Apps menu
2. "Vehicle"
3. "Exterior lighting"
4. If necessary, "Additional settings"
5. "Pathway lighting"
6. Select the desired setting.

Daytime driving lights

General information

The daytime driving lights illuminate when drive-ready state is switched on.

Activating/deactivating daytime driving lights

In some countries, daytime driving lights are mandatory, so it may not be possible to deactivate the daytime driving lights in front.

1.  Apps menu
2. "Vehicle"



3. "Exterior lighting"
4. If necessary, "Additional settings"
5. Depending on vehicle equipment or national-market version:
 - ▷ "Daytime driving lights"
 - ▷ "Rear daytime driving lights"
 - ▷ "BMW Iconic Glow"

Adaptive lighting functions

Principle

Adaptive lighting functions enable dynamic illumination of the road.

General information

The adaptive lighting functions may consist of one system or multiple systems, depending on the equipment version:

- ▷ Cornering light.

Activating the adaptive lighting functions



Press the button on the light switch.

The LED in the button illuminates.

The adaptive lighting functions are active when the drive-ready state is switched on.

Cornering light

Principle

In tight curves, for instance on mountainous roads or when turning, an additional cornering light is switched on that illuminates the inside of the curve when the vehicle is moving below a certain speed.

General information

The cornering light is automatically switched on depending on the steering-wheel angle or, where applicable, the use of turn signals.

When driving in reverse, the cornering lights may be automatically switched on regardless of the steering-wheel angle.

Adaptive headlight range control

The adaptive headlight range control feature balances out acceleration and braking processes as well as the vehicle load conditions in order to avoid blinding oncoming traffic.

Instrument lighting

Functional requirement

The brightness can only be adjusted in darkness and with turned on parking lights or low beams.

Setting the brightness

1. Apps menu
2. "Vehicle"
3. "Interior lighting"
4. "Cockpit brightness at night"
5. Select the desired setting.

Interior lighting

General information

Depending on the equipment version, interior lights, footwell lights, entry lights, ambient lighting, and speaker lighting are automatically controlled.

Overview

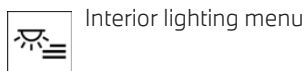
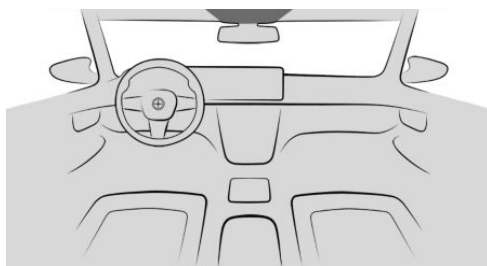

Interior lighting menu



Reading lights



Interior lights

Turning interior lights on/off



Using the button:



Press the button.

To switch off permanently: press the button and hold for approx. 3 seconds.

Via iDrive:

1.  Apps menu
2. "Vehicle"
3. "Interior lighting"
4. "Reading light"
5.  Tap on the icon.

Turning reading lights on/off

Using the button:



Press the button.

Depending on the vehicle equipment, the reading lights are located next to the interior lights in the front and rear.

Via iDrive:

1.  Apps menu
2. "Vehicle"
3. "Interior lighting"
4. "Reading light"
5. Tap the desired seat.

The brightness of the reading lights can be adjusted when they are turned on.

Changing settings

Depending on vehicle equipment, individual settings can be applied to specific seats via iDrive or BMW Touch Command.

Via iDrive:

1.  Apps menu
2. "Vehicle"
3. "Interior lighting"
4. "Reading light"
5. Tap the desired seat.
6. Select the desired settings.

Via BMW Touch Command:

1. "Light"
2. "Reading lights" or "Ambience"
3. Select the desired settings.

Ambient light

General information

Depending on the equipment version, lighting can be adjusted for some lights in the car's interior.

Activating/deactivating ambient light

1.  Apps menu
2. "Vehicle"
3. "Interior lighting"



4. If necessary, "Ambience"
5. "Ambient lighting"

Turning ambient light on/off

The ambient light is switched on when the vehicle is unlocked, and switched off when the vehicle is locked.

If the ambient light was deactivated via iDrive, it will not be turned on when the vehicle is unlocked.

Selecting the color

The color of the ambient light can only be selected in Personal Mode.

1. Apps menu
2. "Vehicle"
3. "Interior lighting"
4. If necessary, "Ambience"
5. "Color"
6. Select the desired setting.

Setting the brightness

1. Apps menu
2. "Vehicle"
3. "Interior lighting"
4. If necessary, "Ambience"
5. "Background light" or "Accent lighting"
6. Select the desired setting.

Dynamic light

Certain situations, for example incoming calls or obstacles detected when opening doors, are indicated by light effects. If the ambient light is disabled, the light effects are still displayed.

1. Apps menu
2. "Vehicle"
3. "Interior lighting"
4. If necessary, "Ambience"

5. "Lighting events"
6. Select the desired setting.

Reduced for night drive

Some lights of the interior lighting are reduced when the vehicle is driven in the dark.

1. Apps menu
2. "Vehicle"
3. "Interior lighting"
4. If necessary, "Ambience"
5. "Reduced for night driving"

Speaker lighting

Principle

Some speakers in the vehicle are illuminated.

General information

When the speakers are muted, the speaker lighting is turned off. When the ambient lighting effects are enabled, the speakers illuminate white.

Turning speaker lighting on/off

The speaker lighting is switched on when the vehicle is unlocked, and switched off when the vehicle is locked.

Window wiper system

Safety information

Warning

If the wipers start moving in the folded away state, body parts can be jammed or damage may occur to parts of the vehicle. There is a risk of injury or risk of damage to property. Make sure that the vehicle is switched off when the wipers are in the folded-away state

and the wipers are folded in when switching on.

NOTICE

The wiper blades can wear out or become damaged prematurely when wiping on a dry window for a longer period of time. The wiper motor can overheat. There is a risk of damage to property. Do not use the wipers when the window is dry.

NOTICE

If the wipers are frozen to the windshield, the wiper blades can be torn off and the wiper motor can overheat when switching on. There is a risk of damage to property. Defrost the windshield prior to switching the wipers on.

Turning on window wiper system

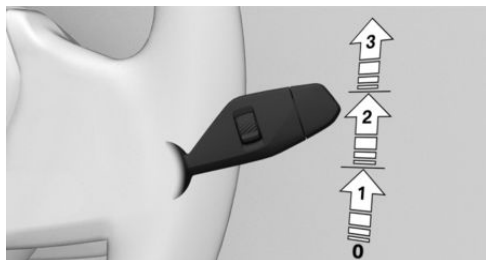

Press the lever up until the desired position is reached.

- ▶ Resting position of the wipers, position 0.
- ▶ Rain sensor, position 1.
- ▶ Normal wiper speed, position 2.
- ▶ Fast wiper speed, position 3.

When the journey is interrupted with the window wiper system turned on: when the journey continues, the wipers resume at their previous speed.

The wiper speed can be reduced gradually to protect the wiper motor from overheating.

Turning off the window wiper system and flick wipe

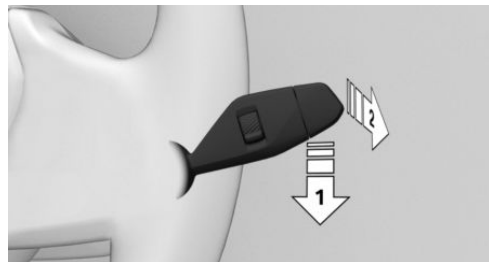

Press the lever down or forward.

- ▶ Turning off: press the lever down, arrow 1, until it reaches the 0 position.
- ▶ Flick wipe: press the lever down from the 0 position, arrow 1, and press the lever in position 0 or position 1 forward, arrow 2.

The lever automatically returns to its 0 position when released.

Rain sensor

Principle

The rain sensor automatically controls the wiper operation depending on the intensity of the rainfall.

General information

The sensor is located on the windshield, directly in front of the interior mirror.

Safety information

NOTICE

If the rain sensor is activated, the wipers can accidentally start moving in car washes. There is a risk of damage to property. Deactivate the rain sensor in car washes.



Activating rain sensor

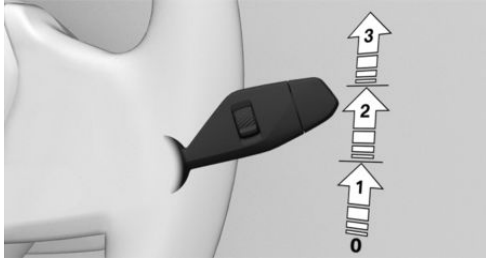

Press lever up once from the 0 position, arrow 1.

Wiping operation is started.

The LED in the wiper lever is illuminated.

In frosty conditions, wiping operation may not start.

Deactivating rain sensor

Press lever back into the 0 position.

Adjusting the rain sensor sensitivity

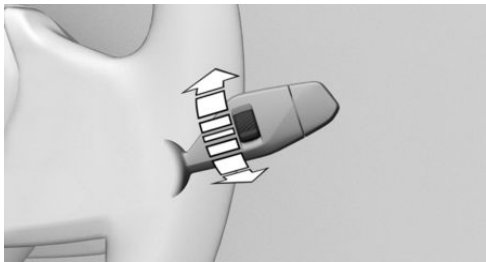

Turn the thumbwheel to adjust the sensitivity of the rain sensor.

- ▷ Upward: high rain sensor sensitivity.
- ▷ Downward: low rain sensor sensitivity.

Windshield washer system

Safety information

Warning

The washer fluid can freeze onto the window at low temperatures and obstruct the view. There is a risk of accident. Only use the washer systems if the washer fluid cannot freeze. Use washer fluid with antifreeze, if needed.

NOTICE

When the washer fluid reservoir is empty, the washer pump cannot work as intended. There is a risk of damage to property. Do not use the washer system when the washer fluid reservoir is empty.

Cleaning the windshield

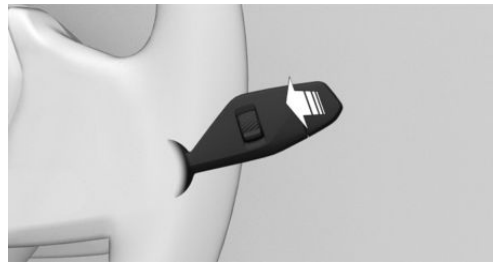

Pull the lever.

The washer fluid is sprayed onto the windshield directly in front of the wiper blade when the wiper moves upward.

Fold-out position of the wipers

Principle

In the fold-out position, the wipers can be folded out from the windshield, which is important, for instance, when changing the wiper

blades or for folding away under frosty conditions.

Safety information

Warning

If the wipers start moving in the folded away state, body parts can be jammed or damage may occur to parts of the vehicle. There is a risk of injury or risk of damage to property. Make sure that the vehicle is switched off when the wipers are in the folded-away state and the wipers are folded in when switching on.

NOTICE

If the wipers are frozen to the windshield, the wiper blades can be torn off and the wiper motor can overheat when switching on. There is a risk of damage to property. Defrost the windshield prior to switching the wipers on.

Folding out the wipers

1. Turn on standby state.
2. Press and hold the wiper lever down until the wipers stop in a nearly vertical position.

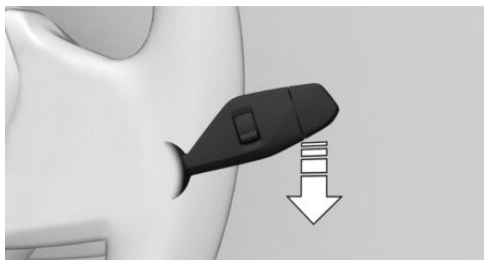

3. Fold the wipers all the way out from the windshield.



Folding in the wipers

1. Fold the wipers back in onto the windshield.
2. Switch on standby state and press and hold the wiper lever down again.

Wipers return to their resting position and are ready again for operation.

Safety

Vehicle features and options

This chapter describes model-specific equipment, systems, and functions that are currently

available, or may become available in the future, even if they are not present in the vehicle.

Additional information:

Vehicle equipment, refer to page 8.

Airbags

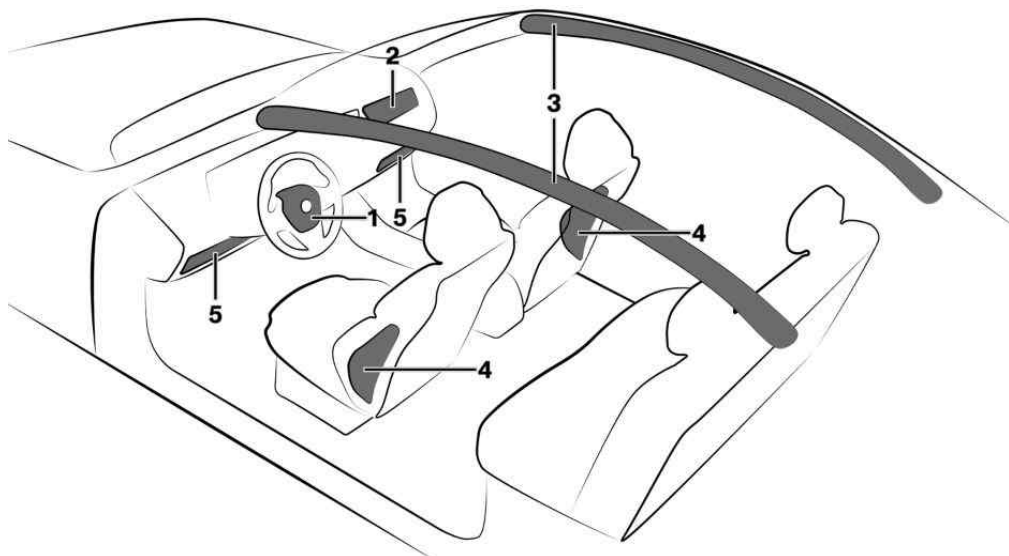

1 Front airbag, driver

2 Front airbag, front passenger

3 Head airbag

4 Side airbag

5 Knee airbag

Front airbags

The front airbag helps protect the driver and front passenger in the event of a frontal impact in which the seat belts alone would not provide adequate protection.

Side airbag

In the event of a side collision, the side airbag protects the side of the body in the chest and lap area.

Head airbag

In the event of a side collision, the head airbag protects the head.

Ejection Mitigation

The head airbag system is designed as an ejection mitigation countermeasure to reduce the likelihood of ejections of vehicle occupants through side windows during rollovers or side collision events.

Knee airbag

Depending on the national-market version:

The knee airbag protects the legs in the event of a frontal impact.

Protective effect

General information

Airbags are not deployed in every impact situation, e.g., in less severe accidents.

Information on optimum protective effect of the airbags

Warning

If the seat position is incorrect, the seat belts are fastened incorrectly or the deployment area of the airbags is impaired, the airbag system cannot provide protection as intended and may cause additional injuries due to deployment. There is a risk of injury or danger to life. Follow the information on achieving the optimum protective effect of the airbag system.

- ▷ Keep a distance from the airbags.
- ▷ Fasten the seat belts correctly.
- ▷ Always grasp the steering wheel on the steering wheel rim. Hold your hands at the 3 o'clock and 9 o'clock positions to keep the risk of injury to your hands or arms as low as possible when the airbag is deployed.
- ▷ Adjust seat and steering wheel so that hands can be crossed over the steering wheel. Select the settings so that the shoulder rests against the backrest when

crossing the hands and the upper body is as far back as possible while still maintaining a comfortable grip on the steering wheel.

- ▷ Make sure that the front passenger is sitting correctly, i.e., with their feet and legs in the footwell, not resting on the dashboard.
- ▷ Make sure that occupants keep their heads away from the side airbag.
- ▷ There should be no additional persons, animals or objects between an airbag and a person.
- ▷ Dashboard and windshield on the passenger's side must stay clear - do not attach adhesive film or coverings and do not attach brackets or cables, for instance for navigation devices or mobile phones.
- ▷ Do not bond the airbag cover panels with adhesive, do not cover them or modify them in any way.
- ▷ Do not use the cover of the front airbag on the passenger's side as a storage area.
- ▷ Keep storage compartments near the airbags closed, e.g., glove compartment or center armrest.
- ▷ Do not place slip covers, seat cushions, or other objects on the front seats unless they are specifically designed for seats with integrated airbags.
- ▷ Do not hang pieces of clothing such as jackets over the backrests.
- ▷ Do not modify individual components or wiring. This also applies to steering wheel covers, the dashboard, and the seats.
- ▷ Do not disassemble the airbag system.

Even when you follow all instructions very closely, injury from contact with the airbags cannot be fully ruled out in certain situations.

The ignition and inflation noise may lead to short-term and, in most cases, temporary hearing impairment in sensitive occupants.

Vehicle modifications for a person with disabilities may affect the air bag system; contact



BMW Customer Relations for further information.

Warnings and information on the airbags are also found on the sun visors.

Operational readiness of the airbag system

Safety information

Warning

Individual components can be hot after deployment of the airbag system. There is a risk of injury. Do not touch individual components.

Warning

Improperly executed work can lead to failure, malfunction or unintentional deployment of the airbag system. In the case of a malfunction, the airbag system might not deploy as intended despite the accident severity. There is a risk of injury or danger to life. Have the airbag system checked, repaired, disassembled, and scrapped by an authorized service center or another qualified service center or repair shop.

Display in the instrument cluster



When drive-ready state is turned on, the warning light in the instrument cluster illuminates briefly, thereby indicating the operational readiness of the entire airbag system and the seat belt tensioners.

Malfunction



- ▶ Warning light does not illuminate when drive-ready state is turned on.
- ▶ The warning light illuminates continuously.

The airbag system or the seat belt tensioners may be not operational. Have the vehicle checked immediately by an authorized service center or another qualified service center or repair shop.

Setting the front seat positions

The power that deploys the driver's/front passenger airbags depends on the position of the driver's/front passenger seat.

To maintain the accuracy of this function, calibrate the electrical front seats as soon as a respective message appears on the control display.

Additional information:

Seats, refer to page 104.

Automatic deactivation of the front passenger airbags

Principle

The automatic front passenger airbag deactivation can detect if the front passenger seat is occupied.

The front passenger airbags are thus activated or deactivated.

Safety information

Warning

To ensure the front passenger airbag function, the system must be able to detect whether a person is sitting in the front passenger seat. The entire seat surface must be used for this purpose. There is a risk of injury or danger to life. Make sure that the front passenger keeps his or her feet in the footwell.

Functional requirements

To enable accurate recognition of the occupied seat surface:

- ▶ Do not attach covers, cushions, ball mats or other items to the front passenger seat unless they are specifically determined to be safe for use on the front passenger seat.
- ▶ Do not place objects under the seat that can press against the seat from below.
- ▶ Sit upright in the seat with your back against the backrest.
- ▶ Sit down with your feet touching the floor.

Installing child restraint systems

To enable accurate recognition of the occupied seat surface of the front passenger seat:

- ▶ Pay attention to the specifications and the operating and safety information of the child restraint system manufacturer when using child restraint systems.
- ▶ Make sure that the seat surface of the child restraint system rests as flat as possible on the seat surface.
- ▶ Move the head restraint up or remove it to ensure that the child restraint system rests as flat as possible against the rear seat backrest.
- ▶ Observe the maximum size of the child restraint system, for example to avoid possible touching the roof.

Before transporting a child on the front passenger seat, refer to the safety information and instructions for children on the front passenger seat, see Children.

More information: installation of child restraint systems, refer to page 121.

Indicator light for the front passenger airbags

The indicator light for the front-seat passenger airbag in the headliner indicates the operating state of the front-seat passenger airbag.

The light indicates whether the airbags are either activated or deactivated.

After drive-ready state is switched on, the light shortly illuminates and then indicates whether the airbags are either activated or deactivated.

Display	Function
	The indicator light is continuously illuminated when the seat is not occupied or when a child is detected on the seat in a provided child restraint system as intended. The airbags on the passenger's side are not activated.
	The indicator light does not illuminate when, for instance, a correctly seated person of sufficient size is detected on the seat. The airbags on the passenger's side are activated.

When the front passenger seat is occupied, check the indicator light before and while driving.

Fault of the automatic deactivation system

When transporting older children and adults, the front passenger airbags may be deactivated in certain seat positions. In this case, the indicator light for the front passenger airbags illuminates.

In this case, change the seat position so that the front passenger airbags are activated and the indicator light goes out.

If it is not possible to activate the airbags, have the person sit in the rear seat.

Occupancy detection

The occupancy detection meets the statutory requirements of the Federal Motor Vehicle Safety Standard FMVSS 208 and deactivates

the passenger airbags under certain conditions.

Collision warning systems

General information

Depending on the equipment, the vehicle has different systems that can help prevent the risk of imminent collision.

- ▷ Forward Collision Mitigation with brake intervention, refer to page [179](#).
- ▷ Exit warning, refer to page [188](#).
- ▷ Lane departure warning, refer to page [190](#).
- ▷ Active Blind Spot Detection, refer to page [193](#).
- ▷ Side collision mitigation, refer to page [195](#).
- ▷ Rear-end collision preparation, refer to page [197](#).
- ▷ Traffic light and sign warning, refer to page [198](#).
- ▷ Wrong way warning, refer to page [200](#).
- ▷ No Turn on Red function, refer to page [201](#).
- ▷ Emergency Stop Assistant, refer to page [202](#).

Safety information

Warning

The system cannot serve as a substitute for the driver's personal judgment in assessing the traffic situation. Based on the limits of the system, it cannot independently react to all traffic situations. There is a risk of accident. Adjust driving style to traffic conditions. Watch the surrounding traffic situation closely, be ready to take over steering and braking at any time, and actively intervene where appropriate.

Warning

Indicators and warnings cannot serve as a substitute for the driver's personal judgment. Due to its limits, the system may not issue warnings or responses, or these may be issued late or in a manner that is not consistent with their normal use. There is a risk of accident. Adjust driving style to traffic conditions. Watch surrounding traffic closely and actively intervene where appropriate.

Sensors

Depending on vehicle equipment, the Intelligent Safety systems are controlled by the following sensors:

- ▷ Camera behind the windshield.
- ▷ Front radar sensor.
- ▷ Radar sensors, side, front.
- ▷ Radar sensors, side, rear.

Additional information:

Sensors of the vehicle, refer to page [35](#).

Turning on/turning off collision warning systems

Depending on national-market version, some of the systems are automatically activated whenever you start driving.

The following functions are adjustable.

1.  Apps menu
2. "Vehicle"
3. "Driving settings"
4. "Driver Assistance"
5. "Safety and warnings"
6. Select the desired settings.

Resetting the settings

The settings of the collision warning systems can be reset to the default settings at vehicle delivery.

1.  Apps menu
2. "Vehicle"
3. "Driving settings"
4. "Driver Assistance"
5. "Safety and warnings"
6. "Reset to recommended settings"

System limits

Safety information

Warning

Due to its limits, the system may not react, or it may react too late or in a manner that is not consistent with normal use. There may be a risk of accidents or risk of damage to property. Actively intervene as warranted. Refer to the information in this Owner's Manual regarding the scope of the system's operation and limitations.

Detection capability

The system's detection capability is limited.

The system only takes into account objects that are located in the detection range of the installed sensors and are detected by the system.

Depending on the vehicle equipment, the area is monitored by cameras or radar sensors.

Thus, a system response might not come or might come late.

System limits of the sensors

Additional information:

Sensors of the vehicle, refer to page 35.

Forward Collision Mitigation with brake intervention

Principle

The Forward Collision Mitigation can help prevent accidents. If an accident cannot be avoided, the system can help reduce the severity of the accident.

The system can issue a warning of a possible risk of collision and activate the brakes independently, if needed.

General information

Depending on the equipment version, the Forward Collision Mitigation system includes the following functions:

- ▷ Warning function in rear-end collision situations, refer to page 182.
- ▷ Warning function for oncoming traffic, refer to page 183.
- ▷ Warning function for turning with oncoming traffic, refer to page 184.
- ▷ Warning function for pedestrians, refer to page 185.
- ▷ Warning function at intersections, refer to page 186.
- ▷ Evasion Assistant, refer to page 187.

Safety information

Warning

The system cannot serve as a substitute for the driver's personal judgment in assessing the traffic situation. Based on the limits of the system, it cannot independently react to all traffic situations. There is a risk of accident. Adjust driving style to traffic conditions. Watch the surrounding traffic situation closely, be ready to take over steering and braking at any time, and actively intervene where appropriate.

 **Warning**

Indicators and warnings cannot serve as a substitute for the driver's personal judgment. Due to its limits, the system may not issue warnings or responses, or these may be issued late or in a manner that is not consistent with their normal use. There is a risk of accident. Adjust driving style to traffic conditions. Watch surrounding traffic closely and actively intervene where appropriate.

 **Warning**

Individual functions may not work correctly when towing with Forward Collision Mitigation enabled or Cruise Control switched on. There is a risk of accident. Switch off Forward Collision Mitigation and Cruise Control before towing.

Sensors

Depending on the equipment, the system is controlled by the following sensors:

- ▶ Camera behind the windshield.
- ▶ Front radar sensor.
- ▶ Radar sensors, side, front.

Additional information:

Sensors of the vehicle, refer to page [35](#).

Speed range

The system issues a warning of a possible risk of collision at speeds above approx. 3 mph/5 km/h.

If the vehicle speed exceeds approx. 155 mph/250 km/h, the system is deactivated temporarily.

Some functions are deactivated earlier.

The system is enabled as soon as the speed drops below these values again.

Turning the Forward Collision Mitigation on/off

Turning on the system automatically

Depending on the national-market version, the system is automatically active after every departure.

Turning on system manually

The system is activated by setting the warning time.

Additional information:

Setting the warning time, refer to page [180](#).

Turning system off manually

Depending on national-market version, the adjustment can only be made when the vehicle is at a standstill or in a very low speed range.

If necessary, the switch-off must be confirmed successively on the control display.

1.  Apps menu
2. "Vehicle"
3. "Driving settings"
4. "Driver Assistance"
5. "Safety and warnings"
6. "Forward Collision Mitigation"
7. "Off"

Setting the warning time





1.  Apps menu
2. "Vehicle"
3. "Driving settings"
4. "Driver Assistance"
5. "Safety and warnings"
6. "Forward Collision Mitigation"
7. Select the desired setting.

The more sensitive the warning time is set to be, the more warnings will be displayed. The system can therefore also issue more early or unfounded warnings and reactions.

The system checks for visual impairments. Depending on the vehicle equipment, the Driver Attention Camera in the instrument cluster captures the driver's field of vision. Visibility and field of vision also affect the timing of the warnings.

Display in the instrument cluster

The following indicator/warning lights are shown on the instrument cluster and, depending on vehicle equipment, on the Head-up display:

Icon	Meaning
	Risk of collision with a person, e.g., a pedestrian.
	Risk of collision, for instance with an oncoming or a vehicle driving ahead.
	Risk of collision, e.g., with a vehicle crossing from the right.
	Risk of collision, e.g., with a vehicle crossing from the left.
	General risk of collision.

The corresponding indicator lights and warning lights may display differently if the system detects multiple objects.

Warning function

The Forward Collision Mitigation warns on different warning levels, depending on the respective hazardous situation.

In the event of a prewarning, a warning light illuminates red. In the event of an acute warning, a warning light flashes red and a warning tone sounds.

In the event of a system warning, the driver must intervene immediately and in accordance with the situation.

- ▷ Red warning light illuminates:
A hazardous situation has been detected. Increased awareness is required.
- ▷ Red warning light flashes:
There is a risk of collision. Intervene immediately.
- ▷ A warning signal sounds:
There is a risk of collision. Intervene immediately.
- ▷ Automatic brake intervention:
Depending on the equipment and situation in case of risk of imminent collision, the system can also intervene with an automatic brake intervention and automatically decelerate the vehicle, if necessary, to a complete stop.

When the brake pedal is depressed quickly and hard, the maximum brake power of the vehicle is used.

Automatic brake intervention

In case of a risk of collision, the system can assist with an automatic brake intervention, if necessary.

When the vehicle is traveling at a low speed, the vehicle may come to a complete stop.

During automatic brake intervention, Dynamic Stability Control activates automatically.

A brake intervention can be canceled by depressing the accelerator pedal with sufficient force, releasing the brake pedal, or by actively steering.

Depending on the equipment and situation, the brake intervention can occur up to approx. 155 mph/250 km/h.

At speeds above approx. 130 mph/210 km/h, only a brief brake intervention will occur.

System limits

Safety information

Warning

Due to its limits, the system may not react, or it may react too late or in a manner that is not consistent with normal use. There may be a risk of accidents or risk of damage to property. Actively intervene as warranted. Refer to the information in this Owner's Manual regarding the scope of the system's operation and limitations.

Detection capability

The system's detection capability is limited.

The system only takes into account objects that are located in the detection range of the installed sensors and are detected by the system.

Depending on the vehicle equipment, the area is monitored by cameras or radar sensors.

Thus, a system response might not come or might come late.

System limits of the sensors

Additional information:

Sensors of the vehicle, refer to page 35.

Functional limitations

The system may be limited in the following situations:

- ▶ In tight curves.
- ▶ With limitation of the driving stability control systems.
- ▶ Up to 10 seconds after drive-ready state is switched on via the Start/Stop button.

Warning function in forward collision situations

Principle

The warning function in forward collision situations warns of a possible risk of collision and may brake independently.

In the event of an accident, the system helps by reducing impact speed.

General information

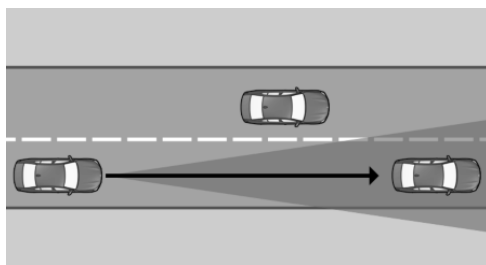

Sensors detect the traffic situation in their detection range.

The system issues a warning of a possible risk of collision with vehicles at speeds above approx. 3 mph/5 km/h. The timing of warnings may vary with the current driving situation.

The system considers the driver's vehicle handling when responding. If an active driving style is detected, warnings and brake interventions occur less frequently.

Safety information

Follow the safety information in Chapter "Forward Collision Mitigation".

Display in the instrument cluster

If there is a risk of collision with a detected vehicle, a warning light is displayed.

Icon	Meaning
	Forward Collision Warning with a detected vehicle.
	General risk of collision.



Warning function

The warning prompts the driver to intervene.

Additional information:

Forward Collision Mitigation, refer to page 179.

System limits

General information

Follow the system limits in the "Forward Collision Mitigation" chapter.

Detection range

The following situations may not be detected, or only detected with a delay, for instance:

- ▶ Vehicle driving slowly in front and being approached at high speed.
- ▶ Vehicles that suddenly swerve in front of you, or strongly decelerating vehicles.
- ▶ Vehicles with unusual rear designs.

Warning function for oncoming traffic

Principle

The warning function for oncoming traffic can warn of a possible risk of collision with oncoming vehicles and may brake independently.

In the event of an accident, the system helps by reducing impact speed.

General information

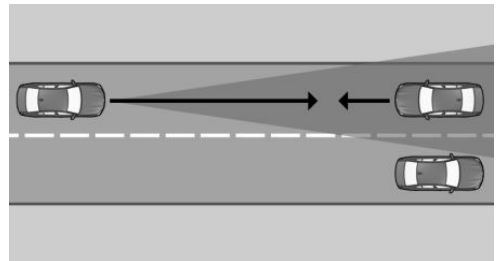

Sensors detect the traffic situation in their detection range.

The system issues a warning of a possible risk of collision with vehicles at speeds above approx. 3 mph/5 km/h. The timing of warnings may vary with the current driving situation.

Safety information

Follow the safety information in Chapter "Forward Collision Mitigation".

Display in the instrument cluster

If there is a risk of collision with a detected vehicle, a warning light is displayed.

Icon	Meaning
	Oncoming traffic warning when a vehicle is detected.
	General risk of collision.



Warning function

The warning prompts the driver to intervene.

In case of a possible risk of collision, a brake intervention is triggered.

Additional information:

Forward Collision Mitigation, refer to page 179.

System limits

General information

Follow the system limits in the "Forward Collision Mitigation" chapter.

Detection range

The following situations may not be detected, for instance:

- ▶ Oncoming vehicles at a very high speed.
- ▶ Vehicles with an unusual front view.

Warning function for turning with oncoming traffic

Principle

There is a risk of an accident with oncoming vehicles when turning across the oncoming lane. The system can issue a warning of a possible risk of collision and activate the brakes independently, if needed.

In the event of an accident, the system helps by reducing impact speed.

General information

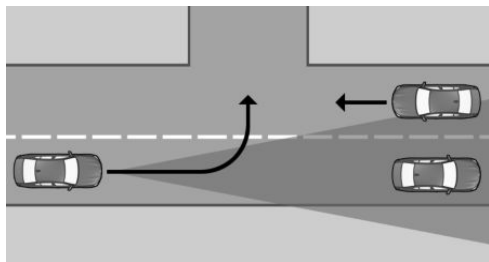

Sensors detect the traffic situation in their detection range.

The system issues a warning of a possible risk of collision with oncoming vehicles at speeds from approx. 3 mph/5 km/h. The timing of warnings may vary with the current driving situation.

Safety information

Follow the safety information in Chapter "Forward Collision Mitigation".

Display in the instrument cluster

If there is a risk of collision with a detected vehicle, a warning light is displayed.

Icon	Meaning
	Oncoming traffic warning when a vehicle is detected.
	General risk of collision.

Warning function

The warning prompts the driver to intervene.

Additional information:

Forward Collision Mitigation, refer to page 179.

System limits

General information

Follow the system limits in the "Forward Collision Mitigation" chapter.

Detection range

The following situations may not be detected, for instance:

- ▶ Oncoming vehicles at a very high speed.
- ▶ Vehicles that are hidden by other vehicles.
- ▶ Vehicles with an unusual front view.

Upper speed limit

The system is active when the own speed is below approx. 15 mph/25 km/h.

Warning function for pedestrians

Principle

At speeds that are common in towns and cities, the warning function warns the driver of a possible risk of collision with pedestrians and cyclists. The system may brake automatically. In the event of an accident, the system helps by reducing impact speed.

General information

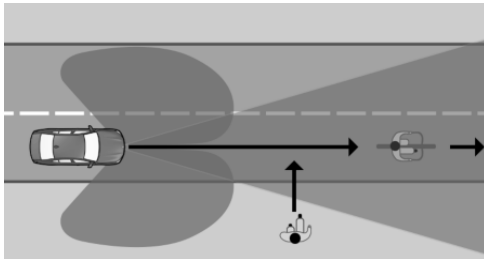

Sensors detect the traffic situation in their detection range when on a straight line.

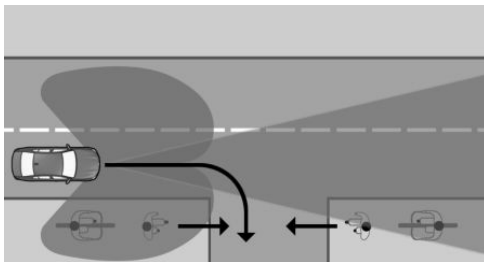

Sensors detect the traffic situation in their detection range when turning.



The system issues a warning of a possible risk of collision with pedestrians or cyclists at speeds above approx. 3 mph/5 km/h.

Safety information

Follow the safety information in Chapter "Forward Collision Mitigation".

Display in the instrument cluster

If there is a risk of collision with a detected pedestrian or cyclist, a warning light is displayed.

Icon	Meaning
	Risk of collision with a person, e.g., a pedestrian.
	General risk of collision.

Warning function

The warning prompts the driver to intervene. Additional information: Forward Collision Mitigation, refer to page 179.

System limits

General information

Follow the system limits in the "Forward Collision Mitigation" chapter.

Detection range

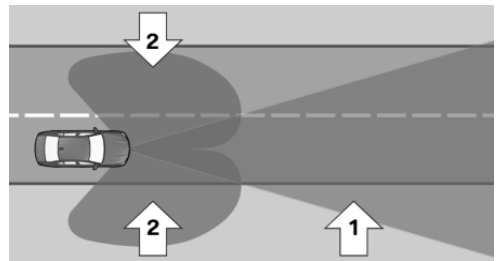

The detection range consists of the following parts:

- ▶ Area in front of the vehicle, arrow 1.
- ▶ With side radar sensors in front: side areas, arrows 2.

The following situations may not be detected, for instance:

- ▶ Partially covered pedestrians or bikes.
- ▶ Pedestrians that are not detected as such because of their contour or posture.
- ▶ Pedestrians with insufficient height.

Upper speed limit

Depending on the vehicle equipment, the system responds to pedestrians and cyclists when your vehicle speed is less than approx. 50 mph/80 km/h.

Warning function at intersections

Principle

At speeds that are common in towns and cities, the Intersection Collision Warning function can warn the driver of a possible risk of collision with crossing traffic at intersections and junctions. The system may brake automatically.

In the event of an accident, the system helps by reducing impact speed.

General information

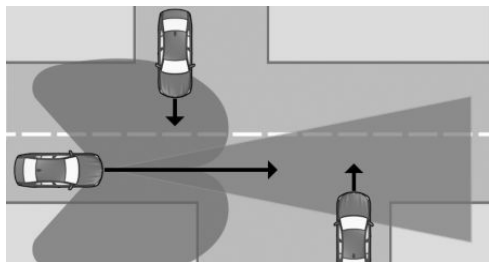

Sensors detect the traffic situation in their detection range.

Vehicles crossing your driving direction can be detected by the system as soon as these vehicles enter into detection range of the sensors.

At intersections and junctions, a warning is issued when a risk of collision with crossing traffic is detected.

The system issues a warning of a possible risk of collision with vehicles at speeds above approx. 3 mph/5 km/h.

The timing of warnings may vary with the current driving situation.

Safety information

Follow the safety information in Chapter "Forward Collision Mitigation".

Display in the instrument cluster

If there is a risk of collision with a detected vehicle, a warning light is displayed.

Icon	Meaning
	Risk of collision with vehicle crossing from the right.
	Risk of collision with vehicle crossing from the left.
	General risk of collision.

Warning function

The warning prompts the driver to intervene.

Additional information:

Forward Collision Mitigation, refer to page 179.

System limits

General information

Follow the system limits in the "Forward Collision Mitigation" chapter.

Detection range

The following situations may not be detected, for instance:

- ▷ Crossing vehicles when they are hidden, e.g. by buildings.
- ▷ Vehicles with an unusual side view.
- ▷ Vehicles in highly dynamic driving situations.

Upper speed limit

The system responds to crossing vehicles when the vehicle speed is below approx. 50 mph/80 km/h.

Evasion Assistant

Principle

The Evasion Assistant can support the driver in making evasive maneuvers in certain situations such as when obstacles or persons suddenly appear.

General information

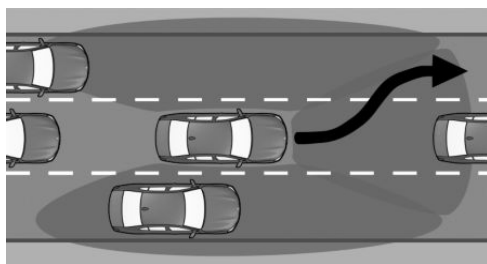

The system issues a warning and intervenes to support the driver if a lateral evasive maneuver is possible.

Sensors monitor and detect the clearance in front of the vehicle. Depending on the vehicle equipment, the areas next to the vehicle are also monitored.

If the system identifies space alongside the vehicle, it supports an evasive maneuver made by the driver by safely performing automatic steering movements.

Safety information



Follow the safety information in Chapter "Forward Collision Mitigation".

Functional requirements

- ▷ Forward Collision Mitigation is active.
- ▷ Sensors detect sufficient clearance around vehicle.

Display in the instrument cluster

If there is a risk of collision with a detected vehicle or detected person, e.g., a pedestrian, a warning light is displayed.

Icon	Meaning
	Warning when a vehicle is detected.
	Risk of collision with a pedestrian.
	Risk of collision with unknown obstacle.

Warning function with evasion support

If the vehicle approaches another object at a high differential speed, a warning is displayed if there is an immediate risk of collision.

Intervene in case of a warning.

The system is designed to provide assistance during evasive maneuvers when there is a risk of collision.

A message in the instrument cluster and, depending on the equipment, in the Head-up display signals the evasion support.

System limits

General information

Follow the system limits in the "Forward Collision Mitigation" chapter.

Detection range

The following situations may not be detected, for instance:

- ▶ Vehicle driving slowly in front and being approached at high speed.
- ▶ Vehicles that suddenly swerve in front of you, or strongly decelerating vehicles.
- ▶ Vehicles with unusual rear designs.
- ▶ Two-wheeled vehicles ahead of you.
- ▶ Partially covered pedestrians or bikes.
- ▶ Pedestrians that are not detected as such because of their contour or posture.
- ▶ Pedestrians with insufficient height.

Exit warning

Principle

The exit warning helps to avoid accidents.

The system can warn the occupants when they are opening the doors and a risk of collision with approaching objects is detected.

General information

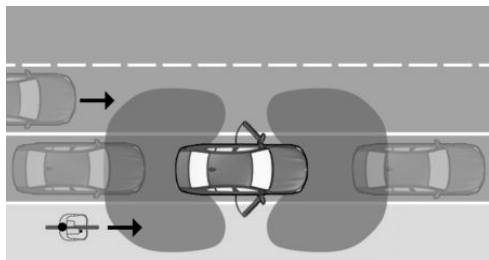

Two radar sensors in the rear bumper monitor the area behind the vehicle.

Depending on the vehicle equipment, the area around the vehicle in front of the vehicle is monitored as well. Two additional radar sensors are located in the front bumpers.

The system monitors the vehicle's surroundings for a limited time after you get in or park.

A possible risk of collision is indicated by various warning functions.

Safety information

Follow the safety information in the "Forward Collision Mitigation" chapter.

Sensors

The system is controlled by the following sensors:

- ▶ Radar sensors, side, rear.
- ▶ Depending on the equipment: radar sensors, side, front.

Turning the exit warning on/off

Turning on the system automatically

The exit warning activates automatically after departure if the function was switched on at the completion of the last trip.

Turning system off manually

1. Apps menu
2. "Vehicle"
3. "Driving settings"
4. "Driver Assistance"
5. "Safety and warnings"
6. "Exit warning"
7. "Off"

Adjusting the exit warning

1. Apps menu
2. "Vehicle"
3. "Driving settings"
4. "Driver Assistance"
5. "Safety and warnings"
6. "Exit warning"
7. Select the desired setting.

Turning the warning signal on/off

1.  Apps menu
2. "Vehicle"
3. "Driving settings"
4. "Driver Assistance"
5. "Safety and warnings"
6. "Exit warning"
7. "Warning tone"

Displays

Warning light in exterior mirror



The warning light in the exterior mirror warns of a possible collision with a detected vehicle.

Ambient light

Depending on the equipment, warnings are also indicated by the ambient light in the interior.

Warning function

Prewarning

In the event of an advance warning, the warning light in the exterior mirror illuminates. Depending on the equipment, the ambient light also flashes.

An object was detected in the opening area. Increased awareness is required.

Acute warning

In the event of an acute warning, the warning light in the exterior mirror flashes, as does the ambient light, depending on vehicle equipment. In addition, a signal tone sounds.

There is a risk of collision when opening the doors.

Door functions

In vehicles with electrical door locks, unlocking is delayed.

On vehicles with automatic doors, opening of the doors is canceled.

System limits

General information

Follow the system limits in the "Collision warning systems" chapter.

Detection range

The following situations may not be detected, for instance:

- ▷ Fully or partially hidden objects.
- ▷ Stationary or very slow objects.
- ▷ Pedestrians.

Functional limitations

The system may be limited in the following situations:

- ▷ The speed of an approaching vehicle is too fast or too slow.
- ▷ In curves.
- ▷ In case of fully or partially hidden objects.

Lane Departure Warning with active return

Principle

The lane departure warning alerts when the vehicle is about to run off the road or exit the lane.

An automatic steering intervention helps to keep the vehicle in its lane.

General information

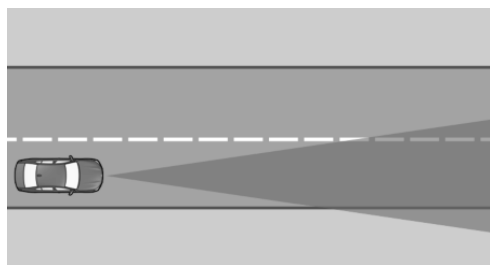

Sensors detect the traffic situation in their detection range.

The system issues a warning starting at a minimum speed. The minimum speed is country-specific and displayed on the control display.

Warnings are displayed in the instrument cluster. In addition, the steering wheel vibrates.

The system does not provide a warning if the turn signal is set in the respective direction before exiting the lane.

Safety information

Warning

The system cannot serve as a substitute for the driver's personal judgment in assessing road and traffic situations. There is a risk of accident. Adjust driving style to traffic conditions. Watch surrounding traffic closely and actively intervene where appropriate. Do

not jerk the steering wheel in response to a warning.

Warning

Indicators and warnings cannot serve as a substitute for the driver's personal judgment. Due to its limits, the system may not issue warnings or responses, or these may be issued late or in a manner that is not consistent with their normal use. There is a risk of accident. Adjust driving style to traffic conditions. Watch surrounding traffic closely and actively intervene where appropriate.

Functional requirement

The camera must detect the lane boundaries for the lane departure warning to be active.

The areas of the sensors must be clean and clear.

Sensors

Depending on the equipment, the system is controlled by the following sensors:

- ▶ Camera behind the windshield.
- ▶ Front radar sensor.
- ▶ Radar sensor, side, front.
- ▶ Radar sensor, side, rear.

Turning the Lane Departure Warning on/off

Turning on the system automatically

Depending on the national-market version, the system is automatically active after every departure.

Turning on system manually

The system is activated by setting the warning time.

Additional information:

Setting the warning time, refer to page 191.

Turning system off manually

Depending on vehicle equipment and national-market version, you must successively confirm the switch-off on the control display.

1.  Apps menu
2. "Vehicle"
3. "Driving settings"
4. "Driver Assistance"
5. "Safety and warnings"
6. "Lane Departure Warning"
7. "Off"

Setting Lane Departure Warning

Setting the warning time

1.  Apps menu
2. "Vehicle"
3. "Driving settings"
4. "Driver Assistance"
5. "Safety and warnings"
6. "Lane Departure Warning"
7. Select the desired setting.

- ▶ "Expanded"

If the system detects that your vehicle is about to leave your lane or cross a lane marking, a warning is issued. The system performs a steering intervention.

- ▶ "In dangerous situations"

With interrupted lane markings: If the system detects that your vehicle is about to inadvertently cross a lane marking, or if the sensors detect an on-coming vehicle, a warning is issued and a steering intervention is performed.

Depending on national-market version, with continuous lane markings: If the system detects that your vehicle is about to inadvertently leave your lane

or cross a lane marking, a warning is issued and a steering intervention is performed.

Setting the intensity of the steering wheel vibration

1.  Apps menu
2. "Vehicle"
3. "Driving settings"
4. "Driver Assistance"
5. "Feedback via steering wheel"
6. "Vibration intensity"
7. Select the desired setting.

The setting is applied to all collision warning systems.

Depending on the national-market version: turning steering intervention on/off

1.  Apps menu
2. "Vehicle"
3. "Driving settings"
4. "Driver Assistance"
5. "Safety and warnings"
6. "Lane Departure Warning"
7. "Steering intervention"

Depending on the national-market version, the steering intervention is automatically active after every driving off.

Display in the instrument cluster

Different system statuses are displayed on the instrument cluster, depending on vehicle equipment and national-market version.

Icon	Meaning
	Indicator light flashes green: System is performing a steering intervention.



Depending on vehicle equipment and national-market version, information for the system is displayed in the Assisted View of the instrument cluster.

Additional information:

Assisted View, refer to page 158.

Warning function

If you leave the lane

If you leave the lane and if a lane boundary has been detected, the steering wheel vibrates in accordance with the steering wheel vibration setting.



In addition, the indicator light flashes green.

When the turn signal is switched on in the corresponding direction before changing the lane, a warning is not issued.

Steering intervention

Depending on the equipment and the national-market version: if a lane marking is crossed in the speed range up to 130 mph/210 km/h, the system intervenes with a brief active steering intervention in addition to vibrating. The system supports the driver in keeping the vehicle within the lane. The steering intervention can be noticed on the steering wheel and can be manually overridden at any time.



When steering intervention is active, the indicator light flashes green.

For instance, the steering intervention will be suppressed in the following situations:

- ▷ With hard accelerating or braking.
- ▷ When flashing.
- ▷ With hazard warning system switched on.
- ▷ In driving situation with high driving dynamics.
- ▷ While Dynamic Stability Control regulates driving stability.

- ▷ While Dynamic Stability Control is limited.
- ▷ Immediately following a steering intervention by the vehicle systems.

Warning signal

Depending on the national-market version: in the event of multiple active steering interventions by the system within 3 minutes without the driver's intervention at the steering wheel during the steering intervention itself, an acoustic warning will sound. A short warning signal will sound at the second steering intervention. Beginning with the third steering intervention, a continuous warning will sound.

In addition, a Check Control message is displayed.

The warning signal and Check Control message advise to pay closer attention to the lane.

The extended warning tone stops when the steering wheel is moved manually.

End of warning

For instance, the warning or an active steering intervention will be canceled in the following situations:

- ▷ Automatically after a few seconds.
- ▷ When returning to your own lane.
- ▷ With hard accelerating or braking.
- ▷ With hazard warning system switched on.
- ▷ When flashing.
- ▷ While Dynamic Stability Control regulates driving stability.
- ▷ Immediately following a steering intervention by the vehicle systems.
- ▷ With manual steering intervention.
- ▷ When another driver assistance system is activated, if applicable.
- ▷ No lane boundaries detected.
- ▷ When the system limits are reached.

System limits

General information

Follow the system limits in the "Collision warning systems" chapter.

Functional limitations

The system may be limited in the following situations:

- ▶ In the event of missing, worn, poorly visible, merging, diverging, or multiple lane boundaries such as in construction areas.
- ▶ With lane boundaries that are covered in snow, ice, dirt or water.
- ▶ In tight corners or on narrow roads.
- ▶ With lane boundaries that are covered by objects.
- ▶ When driving very close to the vehicle in front of you.
- ▶ Up to 10 seconds after drive-ready state is switched on via the Start/Stop button.
- ▶ While Dynamic Stability Control regulates driving stability.
- ▶ While Dynamic Stability Control is limited.

A Check Control message may be displayed when the system is limited. A yellow warning light also illuminates, depending on national-market version.

Active Blind Spot Detection with active return

Principle

Active Blind Spot Detection detects vehicles in the blind spot or vehicles approaching from behind in the adjacent lane.

The warning light in the exterior mirror gives warnings at different levels.

An automatic steering intervention helps to keep the vehicle in its lane.

General information

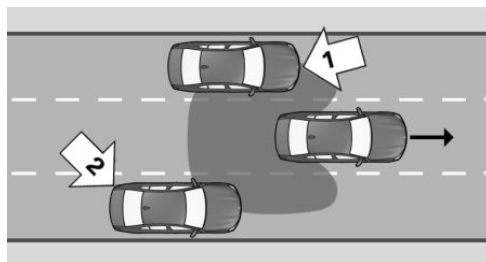

Radar sensors monitor the area behind and next to the vehicle when traveling faster than a minimum speed.

The minimum speed is country-specific and displayed in the Active Blind Spot Detection menu.

The system indicates whether there are vehicles in your blind spot, arrow 1, or approaching from behind in an adjacent lane, arrow 2. The warning light in the exterior mirror illuminates dimly.

The system will warn in the previously named situations prior to a lane change. The warning light in the exterior mirror flashes and the steering wheel vibrates.

When turning at a speed of up to approx. 12 mph/20 km/h, the steering wheel will not vibrate.

Safety information

Follow the safety information in the "Forward Collision Mitigation" chapter.

Sensors

The system is controlled by the following sensors:

- ▶ Camera behind the windshield.
- ▶ Radar sensors, side, rear.
- ▶ Depending on the equipment: radar sensors, side, front.



Functional requirement

The areas of the sensors must be clean and clear.

Turning Active Blind Spot Detection on/off

1. Apps menu
2. "Vehicle"
3. "Driving settings"
4. "Driver Assistance"
5. "Safety and warnings"
6. "Active Blind Spot Detection"
7. Select the desired setting.

Depending on vehicle equipment and national-market version, the system activates automatically whenever you start driving.

Adjusting the Active Blind Spot Detection

Setting the warning time

1. Apps menu
2. "Vehicle"
3. "Driving settings"
4. "Driver Assistance"
5. "Safety and warnings"
6. "Active Blind Spot Detection"
7. Select the desired setting.

Setting the intensity of the steering wheel vibration

1. Apps menu
2. "Vehicle"
3. "Driving settings"
4. "Driver Assistance"
5. "Feedback via steering wheel"
6. "Vibration intensity"
7. Select the desired setting.

The setting is applied to all collision warning systems.

Depending on the national-market version: turning steering intervention on/off

1. Apps menu
2. "Vehicle"
3. "Driving settings"
4. "Driver Assistance"
5. "Safety and warnings"
6. "Active Blind Spot Detection"
7. "Steering intervention"

Warning function

Warning light in exterior mirror



The warning light in the exterior mirror warns of a possible collision with a detected vehicle.

Prewarning

The dimmed warning light in the exterior mirror indicates when vehicles are in your blind spot or approaching from the rear.

Acute warning

When an acute warning occurs, the steering wheel vibrates briefly. The warning light in the exterior mirror flashes brightly.

An acute warning is issued if the following conditions are met:

- ▷ Another vehicle is located in the critical area.
- ▷ Your own vehicle is approaching the other lane.
- ▷ Depending on the system setting when the turn signal is turned on.

The warning stops when the other vehicle has left the critical area.

Steering intervention

Depending on the national-market version: when there is no response to the vibration of the steering wheel at speeds of up to 130 mph/210 km/h and the lane marking is crossed, the system engages the active steering intervention. The steering intervention helps return the vehicle into the lane. The steering intervention can be noticed on the steering wheel and can be manually overridden at any time.

The steering intervention is carried out from a minimum speed. The minimum speed is displayed on the control display.

Warning light flashing

When the vehicle is unlocked, the warning light in the exterior mirror flashes for self-testing purposes.

System limits

General information

Follow the system limits in the "Collision warning systems" chapter.

Upper speed limit

If the vehicle speed exceeds approx. 155 mph/250 km/h, the system is deactivated temporarily.

If the vehicle speed falls below approx. 155 mph/250 km/h, the system is reactivated.

Displaying warnings

Depending on the selected warning settings, e.g., warning time, more or fewer warnings can be displayed. However, there may also be an excess of unwarranted warnings of critical situations.

Functional limitations

The system may be limited in the following situations:

- ▷ When a vehicle is approaching at a speed much faster than your own.
- ▷ In tight corners or on narrow roads.
- ▷ The bumper is dirty, iced up or covered, for instance by stickers.

Depending on the national-market version, the steering intervention e.g. in the following situations:

- ▷ In the event of missing, worn, poorly visible, merging, diverging, or multiple lane boundaries such as in construction areas.
- ▷ With lane boundaries that are covered in snow, ice, dirt or water.
- ▷ With lane boundaries that are not white.
- ▷ With lane boundaries that are covered by objects.
- ▷ When driving very close to the vehicle in front of you.
- ▷ If the camera is impaired.
- ▷ Up to 10 seconds after drive-ready state is switched on via the Start/Stop button.

A Check Control message may be displayed when the system is limited. A yellow warning light also illuminates, depending on national-market version.

Side collision mitigation

Principle

The side-collision warning helps to avoid an impending side collision.



General information

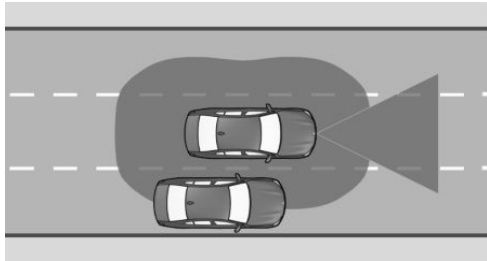

Radar sensors monitor the space next to the vehicle when traveling faster than a minimum speed and up to approx. 130 mph/210 km/h.

The minimum speed is country-specific and displayed on the control display.

If, for example, another vehicle is detected next to your vehicle and there is a risk of collision with this vehicle, the system helps avoid a collision. For this purpose, the system issues a warning with a flashing LED in the exterior mirror, a Check Control message and a vibrating steering wheel. If necessary, an active steering intervention is performed by the system.

Safety information

Follow the safety information in the "Forward Collision Mitigation" chapter.

Functional requirement

The camera behind the windshield determines the lane boundary positions.

The camera must detect the lane markings for the side collision mitigation with steering intervention to be active.

Sensors

The system is controlled by the following sensors:

- ▶ Camera behind the windshield.
- ▶ Radar sensors, side, front.
- ▶ Radar sensors, side, rear.

Turning the side collision warning on/off

1. Apps menu
2. "Vehicle"
3. "Driving settings"
4. "Driver Assistance"
5. "Safety and warnings"
6. "Side collision warning"
7. Select the desired setting.

Setting the intensity of the steering wheel vibration

1. Apps menu
2. "Vehicle"
3. "Driving settings"
4. "Driver Assistance"
5. "Feedback via steering wheel"
6. "Vibration intensity"
7. Select the desired setting.

The setting is applied to all collision warning systems.

Displays in the instrument cluster

Depending on vehicle equipment and national-market version, information for the system is displayed in the Assisted View of the instrument cluster.

Additional information:

Assisted View, refer to page [158](#).

Warning function

Warning light in exterior mirror



The warning light in the exterior mirror warns of a possible collision with a detected vehicle.

Acute warning

If there is a risk of collision, the warning light in the exterior mirror flashes and the steering wheel starts vibrating.

A Check Control message is displayed at the same time.

Steering intervention

Depending on the national-market version, if necessary, the system engages the active steering intervention to prevent a collision and maintain the vehicle within its own lane. The steering intervention can be noticed on the steering wheel and can be manually overridden at any time.

System limits

General information

Follow the system limits in the "Collision warning systems" chapter.

Functional limitations

The system may be limited in the following situations:

- ▷ In tight corners or on narrow roads.
- ▷ In the event of missing, worn, poorly visible, merging, diverging, or multiple lane boundaries such as in construction areas.
- ▷ With lane boundaries that are covered in snow, ice, dirt or water.
- ▷ With lane boundaries that are not white.
- ▷ With lane boundaries that are covered by objects.
- ▷ When driving very close to the vehicle in front of you.
- ▷ Up to 10 seconds after drive-ready state is switched on via the Start/Stop button.

A Check Control message may be displayed when the system is limited.

Rear-end collision preparation

Principle

Depending on the equipment and national-market version, the rear-end collision preparation can react to vehicles approaching from behind.

General information

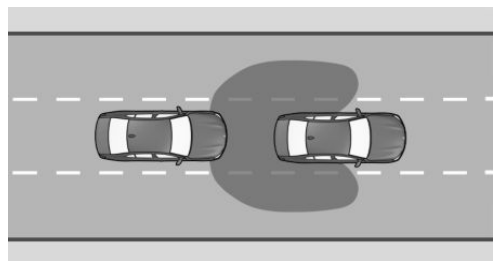

Radar sensors monitor the area behind the vehicle.

When a vehicle approaches from the rear at a certain speed, the system can react as follows:



- ▶ Where applicable, the hazard warning flashers will be switched on.
- ▶ Where applicable, the PreCrash functions are triggered.

Safety information

Follow the safety information in the "Forward Collision Mitigation" chapter.

Sensors

The system is controlled by the radar sensors on the sides and rear.

Turning rear-end collision preparation on/off

The system is automatically active when the vehicle is turned on.

The system is deactivated when reversing.

System limits

General information

Follow the system limits in the "Collision warning systems" chapter.

Functional limitations

This function may be restricted if the speed of the approaching vehicle is much higher or similar to your own speed.

Traffic light and sign warning

Principle

The traffic light and sign warning provides support in situations in which the right-of-way needs to be yielded based on road signs or traffic lights.

General information

The system evaluates traffic signs and traffic lights using a camera behind the windshield.



The navigation system directs information on the road layout to the system.

A warning is given if the right of way is about to be violated, e.g., in the following traffic situations:

- ▶ At an intersection.
- ▶ At a road entrance.
- ▶ On a highway entrance ramp.
- ▶ At a roundabout.
- ▶ With a red traffic light.

The system issues a warning as from a variable minimum speed and at speeds up to approx. 60 mph/100 km/h.

The following traffic signs are taken into account for the traffic light and sign warning:

Sign	Meaning
	Give way signs: A pre-warning is issued for these road signs.
	Stop signs: A pre-warning is issued for these road signs.
	When traffic lights are red, a pre-warning and an acute warning will be issued.

Safety information

Follow the safety information in the "Forward Collision Mitigation" chapter.

Functional requirement

The right-of-way situation ahead of the vehicle must be clearly controlled by traffic signs or light signal systems.

Sensors

The system is controlled by a camera behind the windshield.

Turning the traffic light and sign warning on/off

1.  Apps menu
2. "Vehicle"
3. "Driving settings"
4. "Driver Assistance"
5. "Safety and warnings"
6. "Traffic Light and Sign Warning"
7. Select the desired setting.

Setting the warning time

1.  Apps menu
2. "Vehicle"
3. "Driving settings"
4. "Driver Assistance"
5. "Safety and warnings"
6. "Traffic Light and Sign Warning"
7. Select the desired setting.

The selected setting is saved and adopted for the next journey.

Warning function

General information



The system issues a two-phase warning:

- ▶ Prewarning: visual warning by an icon in the instrument cluster.
- ▶ Acute warning: visual warning by an icon in the instrument cluster and an additional acoustic signal.

The timing of the warning varies with the actual driving situation and the warning time setting.

Prewarning

If there is a risk that a right of way is about to be violated, one of the following icons appears in the instrument cluster:

Icon	Meaning
	Give way.
	Stop.
	Red traffic light.

When a prewarning is issued, intervene as appropriate for the situation; for example, by braking.

Acute warning

If there is an acute risk that the right of way is about to be violated, an acoustic signal will sound and one of the following icons will appear in the instrument cluster:

Icon	Meaning
	Red traffic light.

When an acute warning is issued, intervene as appropriate for the situation; for example, by braking.

Display in the Head-up display

Depending on the vehicle equipment, the warning is displayed simultaneously in the Head-up display and in the instrument cluster.

System limits

General information

Follow the system limits in the "Collision warning systems" chapter.

No warning

The system does not issue a warning in the following situations, for example:

- ▷ In right-of-way situations without right-of-way signs, stop signs, or red light signal systems.
- ▷ With intersections with relevant traffic lights that are illuminated yellow or green.

Functional limitations

The system may be limited in the following situations:

- ▷ If road signs or light signal systems are unclear.
- ▷ If traffic signs or light signal systems are fully or partially concealed or soiled.
- ▷ If traffic signs or light signal systems are difficult to read or rotated.
- ▷ If traffic signs or light signal systems are too small or too large.
- ▷ If the traffic signs do not correspond to the standard.
- ▷ When traffic signs are detected that apply to a junction or parallel street.
- ▷ In the presence of country-specific road signs or road layouts.
- ▷ With intersections with flashing light signal systems.
- ▷ Up to 10 seconds after drive-ready state is switched on via the Start/Stop button.
- ▷ In the case of navigation data that is invalid, outdated or not available.
- ▷ In some regions, the system may not be available or only partially available.

Wrong way warning

Principle

The wrong way warning warns the driver of an upcoming wrong entry onto roads, for in-

stance onto freeways, roundabouts and one-way streets.

General information

Depending on the equipment version, the system uses navigation data and traffic signs to check the traffic situation.

For example, the system takes the following traffic signs into account:

- ▷ No entrance.
- ▷ Roundabout.
- ▷ Directional arrows: mandatory bypass.

Safety information

Follow the safety information in the "Forward Collision Mitigation" chapter.

Functional requirement

The road layout ahead must be controlled clearly with traffic signs.

Sensors

The system is controlled by a camera behind the windshield.

Turning wrong way warning on/off

Depending on national-market version, the wrong way warning is automatically activated whenever you start driving.

Warning function



A warning is displayed and a signal tone sounds, for example when the vehicle is traveling in the wrong direction on a highway, roundabout or one-way street.

Warnings are displayed in the instrument cluster and, depending on the equipment, in the Head-up display.

System limits

General information

Follow the system limits in the "Collision warning systems" chapter.

No warning

For example, the system does not issue a warnings for road layouts without traffic signs.

Functional limitations

The function may be limited in the following situations, for instance, and will either output an incorrect wrong way warning or no warning at all:

- ▶ When the signage is not clear.
- ▶ If the traffic signs are fully or partially concealed or soiled.
- ▶ If the traffic signs are poorly legible or rotated.
- ▶ If the traffic signs are too small or too large.
- ▶ If the traffic signs do not correspond to the standard.
- ▶ When traffic signs are detected that apply to a junction or parallel street.
- ▶ In the presence of country-specific road signs or road layouts.
- ▶ Up to 10 seconds after drive-ready state is switched on via the Start/Stop button.
- ▶ In the case of navigation data that is invalid, outdated or not available.
- ▶ It may not be possible to use the system in all regions.

No Turn on Red function

Principle

This function provides assistance to the driver at traffic lights where turning on red is prohibited.

To do so, this function analyzes traffic lights and traffic signs using the camera behind the windshield. In addition, the navigation system data is used.

Safety information

Follow the safety information in the "Forward Collision Mitigation" chapter.

Functional requirements

- ▶ The system detects the right-of-way situation ahead by analyzing traffic lights and traffic signs.
- ▶ Vehicle is less than approx. 164 ft/50 m from the traffic lights.

Sensors

The system is controlled by a camera behind the windshield.

Display in the instrument cluster



If the driver approaches a red traffic light with a traffic sign that prohibits a turn on red, an indicator light is displayed on the instrument cluster.

The indicator light goes out automatically after you drive off at a speed greater than approx. 9 mph/15 km/h.

System limits

General information

Follow the system limits in the "Collision warning systems" chapter.

Functional limitations

The system may be limited in the following situations:

- ▶ If road signs or light signal systems are unclear.
- ▶ If traffic signs or light signal systems are fully or partially concealed or soiled.



- ▷ If traffic signs or light signal systems are difficult to read or rotated.
- ▷ If traffic signs or light signal systems are too small or too large.
- ▷ If the traffic signs do not correspond to the standard.
- ▷ With intersections with flashing light signal systems.
- ▷ In the case of navigation data that is invalid, outdated or not available.
- ▷ In some regions, this function may not be completely available or not available at all.

Emergency Stop Assistant

Principle

If the driver can no longer drive the vehicle safely, the Emergency Stop Assistant helps to bring the vehicle to a safe standstill.

General information

The Emergency Stop Assistant is triggered automatically.

When the system is triggered, the vehicle is brought to a standstill in its own lane by use of lane guidance.

Safety information

Warning

The system cannot serve as a substitute for the driver's personal judgment in assessing one's physical state. An increasing lack of alertness or fatigue may not be detected or not be detected in time. There is a risk of accident. Make sure that the driver is rested and alert. Adjust driving style to traffic conditions.

Functional requirements

- ▷ The Emergency Stop Assistant is activated via iDrive.
- ▷ The system is activated from a speed of approx. 43 mph/70 km/h.
- ▷ The Driver Attention Camera detects driver activity.

Triggering the Emergency Stop Assistant

If the system detects that the driver is no longer driving the vehicle safely or ignores warnings, the Emergency Stop Assistant is triggered automatically. The triggered system is displayed in the instrument cluster.

The Emergency Stop Assistant can also be triggered via voice input.

Additional information:

BMW Intelligent Personal Assistant, refer to page 53.

An immediate emergency call can be triggered on the control display.

The following is performed automatically when the Emergency Stop Assistant is triggered:

- ▷ A display is shown on the instrument cluster.
- ▷ The system takes over vehicle handling until the vehicle comes to a standstill.
- ▷ The hazard warning system is switched on.
- ▷ An emergency call is triggered when stationary, depending on vehicle equipment.

Activating/deactivating Emergency Stop Assistant

1.  Apps menu
2. "Vehicle"
3. "Driving settings"
4. "Driver Assistance"
5. "Safety and warnings"

6. "Emergency stop"
7. Select the desired setting.

Canceling Emergency Stop Assistant

The driver can cancel the Emergency Stop Assistant by actively taking control of the vehicle throughout the entire process.

For instance, the system will be canceled in the following situations:

- ▷ With strong countersteering.
- ▷ When flashing.
- ▷ If the accelerator pedal is pressed hard.
- ▷ When switching off the hazard warning system.
- ▷ If the system is interrupted on the control display.
- ▷ When changing the selector lever position if the vehicle was already stationary.

At standstill

As soon as the vehicle is stationary, the system will carry out the following settings:

- ▷ The vehicle is secured against rolling away.
- ▷ The interior lights are switched on.
- ▷ The central locking system is unlocked.

Displays in the instrument cluster

Icon	Status
	Emergency Stop Assistant is triggered.

System limits

The system cannot replace the roadworthy driving performance of a driver.

The Emergency Stop Assistant may be restricted in the following situations:

- ▷ When the Driver Attention Camera is covered by the steering wheel.
- ▷ With sunglasses with high protection from infrared light.

Cross traffic warning with brake function

Principle

At blind driveway exits or when driving out of perpendicular parking spaces, road users approaching from the side are detected sooner by the cross traffic warning than is possible from the driver's seat.

General information

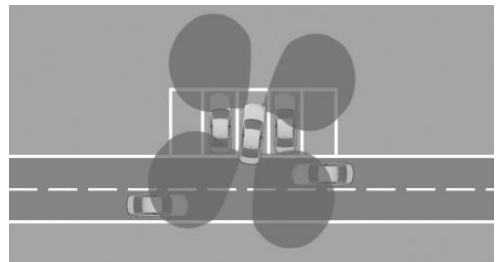

The area behind the vehicle is monitored by sensors.

Depending on the vehicle equipment, the area around the vehicle in front of the vehicle is monitored as well.

The system indicates approaching road users. If there is a collision risk when reversing, the system will provide assistance by performing an automatic brake intervention.

Follow the information in the "Parking assistance systems" chapter.



Safety information

Warning

The system cannot serve as a substitute for the driver's personal judgment in assessing the traffic situation. Based on the limits of the system, it cannot independently react to all traffic situations. There is a risk of accident. Adjust driving style to traffic conditions. Watch the surrounding traffic situation closely, be ready to take over steering and braking at any time, and actively intervene where appropriate.

Sensors

The system is controlled by the following sensors:

- ▷ Radar sensors, side, rear.
- ▷ Depending on the equipment: radar sensors, side, front.

Activating/deactivating Cross Traffic Warning

The system must be activated on the control display for the Cross Traffic Warning and brake intervention to switch on automatically.

1.  Apps menu
2. "Vehicle"
3. "Driving settings"
4. "Driver Assistance"
5. "Parking"
6. Depending on the equipment, select the following setting:
 - ▷ "Rear warning"
 - ▷ "Front and rear warning"
 - ▷ "Brake intervention at rear"

Turning on the cross traffic warning automatically

The system must be activated on the control display. The system turns on automatically as soon as Park Distance Control or a camera view activates and you engage a gear position.

If reverse gear is engaged, the rear system is switched on.

Depending on the equipment, the front system is turned on when a gear position is engaged.

Depending on the national-market version, the system is automatically active when the vehicle is started.

Turning off the cross traffic warning automatically

The system is automatically turned off in the following situations:

- ▷ When the speed exceeds walking speed.
- ▷ When a certain distance covered is exceeded.

Warning function

General information

The control display shows the corresponding view, an acoustic signal may sound as necessary, and the warning light in the exterior mirror flashes.

In case of a brake intervention, a message is displayed on the control display and close after a brief period of time.

Visual warning

Warning light in exterior mirror



The warning light in the exterior mirror flashes if the rear sensors detect other vehicles when the vehicle is reversing.

Display in the Park Distance Control view



In the Park Distance Control view, the respective boundary area flashes red if vehicles are detected by the sensors.

Display in camera image

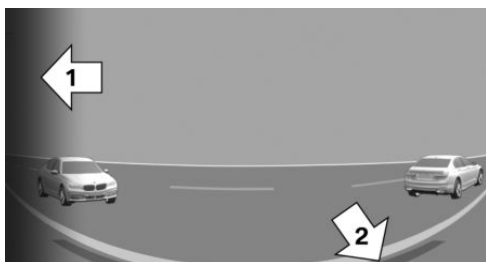

Depending on the direction of travel, the view to the front or back is displayed in the camera image.

The respective boundary area, arrow 1, in the camera image flashes red if vehicles are detected by the sensors.

Yellow lines, arrow 2, mark the bumper of your own vehicle.

Acoustic warning

In addition to the visual warning, a signal tone sounds if your own vehicle moves into the respective direction.

Depending on the national-market version, the signal tone will already sound when the gear position is engaged.

System limits

System limits of the sensors

Additional information:

Sensors of the vehicle, refer to page [35](#).

Functional limitations

The function can be limited, for instance in the following situations:

- ▶ In tight curves.
- ▶ Crossing objects are moving at a very slow or a very fast speed.
- ▶ Other objects that hide cross traffic are in the capture range of the sensors.

BMW Drive Recorder

Principle

The BMW Drive Recorder stores brief video recordings of the vehicle surroundings, e.g., to document surrounding traffic.

General information

Video recordings can be saved in different ways:

- ▶ Automatic storage of the recording.



The function makes it possible to document the accident or theft of the vehicle with the corresponding recording type set.

- ▶ Manual storage of the recording.

This function is used to document traffic situations with the configured recording type.

The assistance systems' cameras are used to record, e.g., Panorama View.

Additionally, the following parameters are stored for the trip:

- ▶ Date.
- ▶ Time.
- ▶ Vehicle speed.
- ▶ Global Positioning System coordinates.

Data protection

The permissibility of recording and using video recordings is contingent upon the statutory regulations of the country in which the system is to be used. The user is responsible for the use of the system and compliance with respective applicable regulations.

The manufacturer of the vehicle recommends confirming there are no statutory or regulatory constraints on use of the system in your state or country prior to the initial use. In addition, the laws with respect to use of the system should be verified in regular intervals, especially when borders are frequently crossed.

Other drivers of the vehicle must be informed about the system. In addition, information about the system is required when handing off the vehicle.

Functional requirements

- ▶ Standby state or drive-ready state is switched on.
- ▶ BMW Drive Recorder is activated.
- ▶ Privacy Policy was accepted.
- ▶ Recording type was selected.
- ▶ Recording time was selected.

Theft notification:

- ▶ The theft notification was activated in the Data Protection menu or in the Drive Recorder menu.
- ▶ Data transfer is activated.
- ▶ My BMW App is installed on the mobile device.
- ▶ My BMW App is linked with the Connected-Drive account.
- ▶ Privacy Policy was accepted.

Activating/deactivating the BMW Drive Recorder

The BMW Drive Recorder must be activated before the first use of the recording function.

1. Apps menu
2. "All apps"
3. "Drive Recorder"
4. Accept Privacy Policy.
5. "Settings"
6. "Allow recording"
7. Select the desired setting.

Recording functions

Automatic recording

The recording is automatically stored when the vehicle sensors detect an accident or theft.

- ▶ In case of accident:
The system saves recordings up to 30 seconds before and after storage is triggered.
- ▶ In case of theft:
Depending on the selected recording duration, the system saves the recording after it has been triggered.
When the alarm system is triggered, a message is sent to the My BMW App.
After saving the recording, the reduced quality video can be downloaded to a mobile device.

If the vehicle accelerates rapidly, an automatic recording may be taken.

Manual recording

Using the button

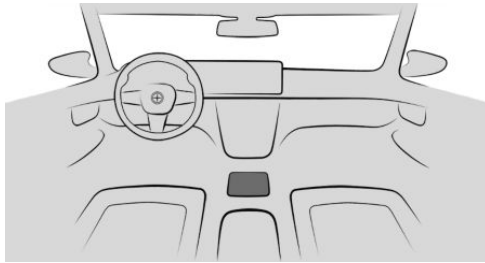

Press and hold this button.

Via iDrive

Start the recording:

1.  Apps menu
2. "All apps"
3. "Drive Recorder"
4. "Recording"
5. "Start recording"

Stop the recording: "Stop recording".

The system saves recordings up to 30 seconds before and after storage is triggered.

Recording playback and administration

Stored video recordings can be played back, exported and deleted.

For your own safety, the video recording is only displayed on the control display up to approx. 2 mph/3 km/h. In some national-market versions, the video recording is only displayed

if the parking brake is engaged or if the selector lever is in the P position.

1.  Apps menu
2. "All apps"
3. "Drive Recorder"
4. "Recordings"
5. Select desired recording.
6. If necessary, select camera.

Settings

Recording type

1.  Apps menu
2. "All apps"
3. "Drive Recorder"
4. "Settings"
5. Select the desired setting.

Recording time

1.  Apps menu
2. "All apps"
3. "Drive Recorder"
4. "Settings"
5. Select the desired setting.

Recording on a mobile device

Principle

Depending on the equipment version, video recordings can be stored directly on a mobile device such as a smartphone or USB storage.

General information

The length of the video that can be stored depends on the available memory capacity on the mobile device.

Functional requirements

- ▶ Privacy Policy was accepted.
- ▶ BMW Drive Recorder is activated.



To transfer recordings to a mobile device:

- ▷ Depending on vehicle equipment, a mobile device is connected to the vehicle via Wi-Fi and Bluetooth audio, or a USB storage device is connected.
- ▷ My BMW App is installed on the mobile device.
- ▷ My BMW App is linked with the Connected-Drive account.

Recording

The recording can be started and stopped manually.

Start the recording:

1. Apps menu
2. "All apps"
3. "Drive Recorder"
4. "Recording"
5. "Start recording"

Stop the recording: "Stop recording".

Cameras

Different cameras can be selected.

1. Apps menu
2. "All apps"
3. "Drive Recorder"
4. "Settings"
5. "Cam. selection"
6. Select desired camera.

System limits

In the event of serious accidents, it may not be possible to store recordings if the damage on the vehicle is too great or the power supply was interrupted.

If you overwrite a USB drive multiple times, it may not be possible to export recordings correctly.

The preferred file system for USB storage is NTFS. Other file systems may have limitations.

In case of theft, the recording is only stored automatically when the anti-theft warning system has been triggered.

If the internet connection is weak or cannot be established, theft alerts and video downloads may be restricted or not available.

The quality of the Wi-Fi connection affects whether recordings can be saved on your smartphone. This function may be restricted or not available if the connection is weak.

Active Protection

Principle

Active Protection prepares occupants and the vehicle for a possible accident in critical driving or collision situations.

General information

Depending on vehicle equipment and national-market version, Active Protection consists of various PreCrash functions.

The system is used to detect certain critical driving situations that might lead to an accident. This includes the following critical driving situations:

- ▷ Emergency braking.
- ▷ Severe understeering.
- ▷ Severe oversteering.

Certain functions of several systems can, within the system limits, lead to Active Protection triggering:

- ▷ Forward Collision Mitigation: automatic brake intervention.
- ▷ Forward Collision Mitigation: brake booster.
- ▷ Rear-end collision preparation: detection of impending rear-end collisions.

Safety information

Warning

The system cannot serve as a substitute for the driver's personal judgment. Due to the system limits, critical situations might not be detected reliably or in time. There is a risk of accident. Adjust driving style to traffic conditions. Watch surrounding traffic closely and actively intervene where appropriate.

Function

Depending on the equipment and requirements, the following individual functions are active in accident-critical driving situations:

- ▶ Automatic closing of the windows.
The windows remain open with a small gap.
- ▶ Automatic closing of glass sunroof.
- ▶ Automatic positioning of the backrest for the front passenger seat.
- ▶ Rear comfort seats: automatic positioning of the rear seat backrests.

Systems can be returned to the desired settings following a critical driving situation without accident.

PostCrash – iBrake

Principle

In certain accident situations, the PostCrash – iBrake can automatically bring the vehicle to a standstill without intervention by the driver.

General information

The PostCrash – iBrake can reduce the risk of a further collision and its consequences.

At standstill

After coming to a halt, the brake is released automatically.

Harder vehicle deceleration

In certain situations, it may be necessary to bring the vehicle to a halt more quickly than automatic braking with PostCrash iBrake allows.

To do this, quickly apply extra force to the brake. For a brief period, the brake pressure will be higher than the brake pressure that is achieved by the automatic brake function. Automatic braking is interrupted.

Abort automatic braking

It may be necessary to interrupt automatic braking in certain situations, for instance when making an evasive maneuver.

Abort automatic braking:

- ▶ By depressing the brake pedal.
- ▶ By pressing the accelerator pedal.

Fatigue alert

Principle

The Fatigue Alert break recommendation feature can detect when the driver is fatigued or less alert during long, monotonous trips, for instance on highways. The system recommends a break.

Safety information

Warning

The system cannot serve as a substitute for the driver's personal judgment in assessing one's physical state. An increasing lack of alertness or fatigue may not be detected or not be detected in time. There is a risk of accident. Make sure that the driver is rested

and alert. Adjust driving style to traffic conditions.

Break recommendation

Function

After starting the trip, the system is trained to the driver, so that decreasing alertness or fatigue can be detected.

This procedure takes, for example, the following criteria into account:

- ▷ Personal driving style, for instance steering behavior.
- ▷ Driving conditions, for instance time, length of trip.
- ▷ Depending on the equipment: attention of the driver through the Driver Attention Camera.

The system is active starting at approx. 43 mph/70 km/h and can also display a break recommendation.

Setting break recommendation

The break recommendation can be switched on, off and adjusted via iDrive.

1.  Apps menu
2. "Vehicle"
3. "Driving settings"
4. "Driver Assistance"
5. "Safety and warnings"
6. "Fatigue Alert"
7. Select the desired setting.

Display

If the driver becomes less alert or fatigued, a message is displayed in the control display with the recommendation to take a break.

During the display, various settings can be selected.

The system is reset approx. 45 minutes after parking the vehicle. A break recommendation can only be displayed again after this time has elapsed.

System limits

The Fatigue Alert system may be limited. If the system is limited, either no warning may be issued or an unwarranted warning may be issued.

The break recommendation function may be limited in the following situations:

- ▷ If the time is set incorrectly.
- ▷ At a predominantly driven speed below approx. 43 mph/70 km/h.
- ▷ With a sporty driving style such as during rapid acceleration or when cornering fast.
- ▷ In active driving situations such as when changing lanes frequently.
- ▷ When the road condition is poor.
- ▷ In the event of strong side winds.

Driver Attention Camera

Principle

A camera in the instrument cluster monitors the driver's activity and, depending on the equipment, the driver's viewing direction.

General information

The assistance systems help drivers by analyzing whether they are paying attention, e.g., by evaluating their head position and eyes.

For full operability, make sure that the field of view of the Driver Attention Camera is not obstructed.

Overview

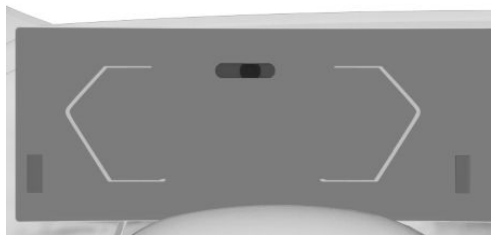

Depending on the equipment, the instrument cluster has up to three infrared light sources. Depending on the light conditions, these light sources can be visible when the vehicle is in standby mode.

System limits

The Driver Attention Camera may not be fully operational in the following situations:

- ▶ When the Driver Attention Camera is covered by the steering wheel.
- ▶ With sunglasses with high protection from infrared light.

Driving stability control systems

Vehicle features and options

This chapter describes model-specific equipment, systems, and functions that are currently available, or may become available in the future, even if they are not present in the vehicle.

Additional information:

Vehicle equipment, refer to page 8.

Antilock Braking System

Principle

The Antilock Braking System prevents locking of the wheels while braking.

You remain able to steer your vehicle even during full braking, which increases active driving safety.

General information

The Antilock Braking System is ready after each time drive-ready state is turned on.

Malfunction



The warning light on the instrument cluster illuminates.



A Check Control message is displayed.

- ▶ The Antilock Braking System is not available.
- ▶ Steerability is limited during full braking.

Have the vehicle checked immediately by an authorized service center or another qualified service center or repair shop.

Brake assistant

The brake assistant automatically applies maximum braking assistance when the brake pedal is depressed quickly. This reduces the braking distance to a minimum for full braking.

To make full use of braking assistance, do not reduce the pressure on the brake pedal during full braking.

Dynamic Stability Control

Principle

Dynamic Stability Control helps keep the vehicle on a steady course in critical driving situations. The drive power is reduced depending on the situation, and wheels can be braked individually.

General information

The system detects the following unstable driving conditions, for instance:

- ▶ Skidding, which can lead to oversteering.
- ▶ Loss of adhesion of the front wheels, which can lead to understeering.

Safety information

Warning

The system cannot serve as a substitute for the driver's personal judgment in assessing the traffic situation. Based on the limits of the system, it cannot independently react to all traffic situations. There is a risk of accident. Adjust driving style to traffic conditions. Watch the surrounding traffic situation closely, be ready to take over steering and

braking at any time, and actively intervene where appropriate.

Overview

Button in the vehicle

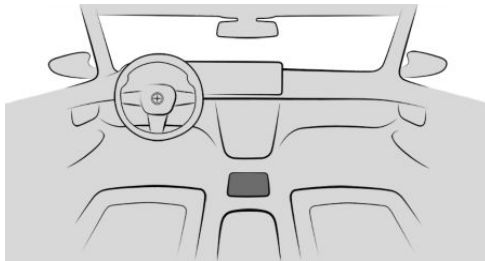

My Modes

Activating/deactivating Dynamic Stability Control

If Dynamic Stability Control is deactivated, driving stability is restricted when accelerating and cornering.

To support driving stability, reactivate Dynamic Stability Control as soon as possible.

1.  Press the button.
2. "Switch mode"
3. "SPORT"
4. "Settings"
5. "Driving dynamics"
6. "DSC OFF"

Dynamic Stability Control is automatically activated when changing to another drive mode.

"SPORT": when you switch to this drive mode, the last setting is automatically reactivated.

Displays in the instrument cluster



View when Dynamic Stability Control is deactivated.



Indicator light illuminates: Dynamic Stability Control is deactivated.



Warning light flashes: Dynamic Stability Control is regulating the driving and brake power. The vehicle is stabilized. Reduce speed and modify your driving style to the driving circumstances.



Warning light illuminates: Dynamic Stability Control has failed or is initializing. Driving stabilization is restricted or has failed.

If the warning light illuminates continuously, have the vehicle checked immediately by an authorized service center or another qualified service center or repair shop.

Setting for increased driving dynamics

Principle

For a more dynamic driving experience, you can configure the vehicle for increased driving dynamics via My Modes.

General information

The Dynamic Stability Control and thereby the driving stability are limited during acceleration and when cornering.

Overview

Button in the vehicle

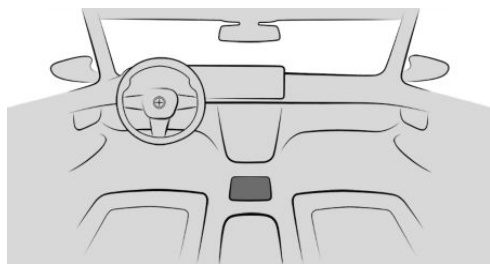

Activating/deactivating increased driving dynamics

1.  Press the button.
2. "Switch mode"
3. "SPORT"
4. "Settings"
5. "Driving dynamics"
6. "SPORT PLUS"

Dynamic Stability Control is activated when changing to another drive mode.

"SPORT": the last setting applied to Dynamic Stability Control remains saved in the mode.

Display in the instrument cluster

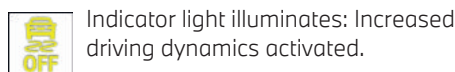

Indicator light illuminates: Increased driving dynamics activated.

Automatic program change

The increased driving dynamics will be deactivated automatically, for instance in the following situations:

- ▷ When the Distance Control is activated.
- ▷ In case of a brake intervention by Forward Collision Mitigation. Deactivate Forward Collision Mitigation as necessary.
- ▷ If the suspension control system fails.
- ▷ The vehicle has a flat tire.

Additional information:

Forward Collision Mitigation with brake intervention, refer to page 179.

Drive-off support

Principle

The moving-off support offers the best possible traction when moving off in certain situations on difficult ground such as on snow or sand.

General information

The function provides maximum drive power with adapted driving stability in the low speed range.

Activating/deactivating the drive-off support

1.  Apps menu
2. "Vehicle"
3. "Driving settings"
4. "Drivetrain and chassis"
5. "Drive-off support"
6. "Activate once" or "Deactivate"

The drive-off support remains active until it is deactivated or the driving mode is changed.

BMW xDrive

Principle

BMW xDrive is the all-wheel-drive system of the vehicle. Concerted action by the BMW

xDrive and other suspension control systems such as Dynamic Stability Control further optimizes traction and driving dynamics.

General information

BMW xDrive variably distributes the drive forces to the front and rear axles as required by the driving situation and road conditions.

Integral Active Steering

Principle

The Integral Active Steering increases the maneuverability of the vehicle and makes a more direct steering response possible. Driving stability is also increased at high speeds.

General information

Integral Active Steering combines the variable steering gear ratio of the front axle with active rear-wheel steering.

The rear axle steering acts to increase maneuverability at low speeds by turning the rear wheels slightly in the opposite direction to the front wheels.

At higher speeds, the rear wheels are turned in the same direction as the front wheels. For instance, this results in a harmonious lane change.

In critical driving situations, integral active steering can stabilize the vehicle by automatically steering the rear wheels, for example e.g. when oversteering.

Setting

The system offers several different settings. With the driving modes of the My Modes, the system can be set to comfortable or dynamic. Additional information:

My Modes, refer to page [134](#).

Using snow chains

In order to guarantee free movement of the wheels when operating with snow chains, rear axle steering must be turned off when snow chains are mounted.

Additional information:

Rear axle steering during operation with snow chains, refer to page [334](#).

Malfunction



The warning light on the instrument cluster illuminates.

A Check Control message is displayed.

The steering system may not be operational. Integral Active Steering assistance may no longer be provided.

- ▶ Larger steering movements are required at low speeds.
- ▶ The response of the vehicle is more sensitive in higher speed ranges.
- ▶ Proceed cautiously and practice anticipatory driving.

Have the vehicle checked by an authorized service center or another qualified service center or repair shop.

Driver assistance systems

Vehicle features and options

This chapter describes model-specific equipment, systems, and functions that are currently available, or may become available in the future, even if they are not present in the vehicle.

Additional information:

Vehicle equipment, refer to page 8.

Speed warning

Principle

The speed warning can be used to set a speed limit. A warning will be issued when this speed limit is exceeded.

General information

Another warning occurs when the set speed limit is exceeded again after it has dropped by 3 mph/5 km/h.

Activating/deactivating the speed warning

1.  Apps menu
2. "Vehicle"
3. "Driving settings"
4. "Driver Assistance"
5. "Safety and warnings"
6. "Speed warning"

Adjusting the speed

1.  Apps menu
2. "Vehicle"
3. "Driving settings"
4. "Driver Assistance"
5. "Safety and warnings"

6. "Speed warning"
7. "Warning above:"
8. Select the desired setting.

Applying current speed as the speed warning

1.  Apps menu
2. "Vehicle"
3. "Driving settings"
4. "Driver Assistance"
5. "Safety and warnings"
6. "Speed warning"
7. "Adopt current speed"

Speed Limit Info

Speed Limit Info

Principle

Speed Limit Info shows the currently valid speed limit in the instrument cluster and, if necessary, the Head-up display.

General information

The camera in the area of the interior mirror detects traffic signs at the edge of the road as well as overhead sign posts.

Traffic signs with extra icons are considered and compared with the vehicle's onboard data. The traffic sign will then be either displayed or ignored depending on the situation in the instrument cluster and the Head-up display.

The system may also show speed limits that apply to routes that are not signposted if the navigation system has current map data.



For Speed Limit Info to function correctly, current map data for the country in which the vehicle is operated must be downloaded.

For information on the current map version and map updates, see Map update in the Navigation system chapter.

Without a navigation system, the system is subject to limitations imposed by technology. Traffic signs with speed limitations are detected and displayed only. Speed limits due to entering towns/cities, highway signs, etc., are not displayed. Speed limits with extra traffic signs are always displayed.

Additional information:

- ▷ Owner's Manual for Navigation, Entertainment, and Communication, refer to page 6.

Safety information

Warning

The system cannot serve as a substitute for the driver's personal judgment in assessing the traffic situation. Based on the limits of the system, it cannot independently react to all traffic situations. There is a risk of accident. Adjust driving style to traffic conditions. Watch the surrounding traffic situation closely, be ready to take over steering and braking at any time, and actively intervene where appropriate.

Sensors

The system is controlled by a camera behind the windshield.

Displaying Speed Limit Info

General information

The Speed Limit Info can be shown or hidden via iDrive in the instrument cluster. Depending on the national-market version, Speed Limit





Info is continuously displayed in the instrument cluster.

Displaying Speed Limit Info

1.  Apps menu
2. "Vehicle"
3. "Driving settings"
4. "Driver Assistance"
5. "Driving"
6. "Speed Limit Assistant"
7. "Speed limits"
8. "Show current limit"

Display

Speed Limit Info

Icon	Description
	Current speed limit. Depending on the national-market version, it is possible to switch between the units of measurement.
	
	No data on current speed limit available.
	Speed Limit Info not available.

Warning signals

General information

The display flashes if the detected speed limit is exceeded or the speed limit changes. Depending on national-market version, an acoustic signal also sounds.

Signal for exceeding speed limit

The warning for exceeding the maximum permissible speed can be activated or deactivated via iDrive:

1.  Apps menu
2. "Vehicle"
3. "Driving settings"
4. "Driver Assistance"
5. "Driving"
6. "Speed Limit Assistant"
7. "Warning when speeding"

Signal for speed limit change

The warning for speed limit changes can be activated or deactivated via iDrive:

1.  Apps menu
2. "Vehicle"
3. "Driving settings"
4. "Driver Assistance"
5. "Driving"
6. "Speed Limit Assistant"
7. "Sound when speed limit changes."

Settings

1.  Apps menu
2. "Vehicle"
3. "Driving settings"
4. "Driver Assistance"
5. "Driving"
6. "Speed Limit Assistant"
7. Select the desired setting.

System limits

System limits of the sensors

Additional information:

- ▷ Camera, refer to page 35.

Functional limitations

The system function may be limited and may provide incorrect information in the following situations:

- ▷ Traffic signs are fully or partially concealed by objects, stickers, or paint.
- ▷ Traffic signs do not comply with the standard.
- ▷ In areas that are not included in the navigation system map data.
- ▷ If navigation system map data is invalid, outdated, or unavailable.
- ▷ When roads deviate from the navigation such as due to changes in road layout.
- ▷ When driving very close to the vehicle in front of you.
- ▷ When passing buses or trucks with traffic signs applied to them.
- ▷ In case of electronic traffic signs.
- ▷ When traffic signs that are valid for a parallel road are detected.
- ▷ In the presence of country-specific road signs or road layouts.

Speed control systems

Principle

The speed control systems provide support when driving.

General information

Depending on the equipment, the speed control systems include the following individual systems.

- ▷ Cruise control, refer to page 221.
- ▷ Distance control, refer to page 223.
- ▷ Assisted Driving Mode, refer to page 229.
- ▷ Assisted Driving Mode Plus, refer to page 234.

Depending on the equipment and national-market version, the individual systems are enhanced with additional functions.

Some functions can be operated via voice control.

Additional information:

BMW Intelligent Personal Assistant, refer to page 53.

Safety information

Warning

The system cannot serve as a substitute for the driver's personal judgment in assessing the traffic situation. Based on the limits of the system, it cannot independently react to all traffic situations. There is a risk of accident. Adjust driving style to traffic conditions. Watch the surrounding traffic situation closely, be ready to take over steering and braking at any time, and actively intervene where appropriate.

Warning

Individual functions may not work correctly when towing with Forward Collision Mitigation enabled or Cruise Control switched on. There is a risk of accident. Switch off Forward Collision Mitigation and Cruise Control before towing.

Overview

Buttons on the steering wheel

Button Function



Turn last active speed control system on/off.



Interrupt and continue speed control systems.



Select the desired speed control system.





Store current speed.
Speed Limit Assistant: accept suggested speed manually.



Set speed.

Turning on/selecting speed control systems

1.  Turn on: press the button.
2.  Select: when the system active, press the button repeatedly until the desired speed control system is displayed in the toolbar in the instrument cluster.

Icon Speed control system



Cruise control.



Distance control.



Assisted Driving Mode: Dynamic Cruise Control, Steering Assistance with Lane Keeping.

The activated system is shown in green.



The system is shown in white when the system can be activated.

The system is grayed out if the system has failed or if the functional requirements are not met.

Interrupting speed control systems automatically

Depending on the system, speed control systems are interrupted automatically, for instance in the following situations:

- ▷ When moving from selector lever position D to P, N, or R.
- ▷ While Dynamic Stability Control regulates driving stability.
- ▷ While Dynamic Stability Control is disabled.
- ▷ "SPORT PLUS": the settings for increased driving dynamics are activated.
- ▷ When braking manually.

Interrupting speed control systems manually



- ▷ Press the button.



- ▷ Press button to select another speed control system.

Continuing speed control systems



Press the button.

Turning off speed control systems automatically

The speed control systems turn off automatically when the drive-ready state is turned off.

Turning off speed control systems manually



Press and hold this button.

The speed control systems are turned off and the displays extinguish.

Adjusting speed values



Repeatedly press the rocker button on the steering wheel up or down until the desired value is set.

- ▷ Each time the rocker button is pressed to the resistance point, the set speed increases or decreases by 1 mph/1 km/h.
- ▷ Each time the rocker button is pressed past the resistance point, the set speed changes by a maximum of 5 mph/10 km/h.

Display in the instrument cluster

Display in the speedometer



A mark is displayed on the speedometer for the set speed.

- ▷ Green marking: system is active.
- ▷ Gray marking: system is interrupted.
- ▷ No marking: system is switched off.

Notifications

In addition to the respective check lamps, notifications are displayed for some functions.

The scope of notifications can be set.

1. Apps menu
2. "Vehicle"
3. "Driving settings"
4. "Driver Assistance"
5. "Driving"



6. "Notifications"
7. Select the desired setting.

Cruise Control

Principle

With the Cruise Control, a set speed can be adjusted using the buttons on the steering wheel. The system maintains the set speed. The system accelerates and brakes automatically as needed.

General information

The system can be activated starting at 20 mph/30 km/h.

Depending on the vehicle setting, the Cruise Control settings can change under certain conditions. For instance, the acceleration can change depending on the driving mode.

Safety information

Warning

The system cannot serve as a substitute for the driver's personal judgment in assessing the traffic situation. Based on the limits of the system, it cannot independently react to all traffic situations. There is a risk of accident. Adjust driving style to traffic conditions. Watch the surrounding traffic situation closely, be ready to take over steering and braking at any time, and actively intervene where appropriate.

Warning

The use of the system can lead to an increased risk of accidents in the following situations, for instance:

- ▷ On winding roads.
- ▷ With high traffic volume.
- ▷ On slippery roads, in fog, snow, or wet conditions, or on a loose road surface.

There may be a risk of accidents or risk of damage to property. Only use the system if driving at constant speed is possible.

Warning

The set speed can be incorrectly adjusted or called up by mistake. There is a risk of accident. Adjust the set speed to the traffic conditions. Watch surrounding traffic closely and actively intervene where appropriate.

Overview

Buttons on the steering wheel

Button Function



Turn last active speed control system on/off.

Interrupt and continue speed control systems.



Select the desired speed control system.



Store current speed.
Speed Limit Assistant: accept suggested speed manually.



Set speed.



Turning on the Cruise Control

In vehicles with distance control: change the mode of the Cruise Control to Cruise Control without distance control.

Additional information:

Distance control, refer to page [223](#).

In vehicles without distance control: turn on the Cruise Control with the buttons on the steering wheel.

1.  If necessary, press the button.
2.  If necessary, press the button repeatedly until the Cruise Control is selected.

Cruise control is active. The current speed is maintained and stored as desired speed.

The indicator lights in the instrument cluster illuminate and the mark on the speedometer is set to the current speed.

The driving mode changes or Dynamic Stability Control activates when cruise control is switched on.

Turning the speed control system off/interrupting

The speed control system can be turned off or canceled automatically or manually.

Additional information:

Speed control systems, refer to page 218.

Adjusting the speed

Store/maintain speed



Press the rocker button up or down once while the system is stopped.

When the system is switched on, the current speed is maintained and stored as the set speed.

The stored speed is displayed on the speedometer.

When the Speed Limit Assistant is not active, the current speed can also be stored by pressing a button:



Press the button.

Changing the speed



Repeatedly press the rocker button up or down until the desired speed is set.

If active, the displayed speed is stored and the vehicle reaches the stored speed when the road is clear.

The maximum speed that can be set depends on the vehicle.

Press rocker button to resistance point and hold: The vehicle accelerates or decelerates without the accelerator pedal being pressed.

After the rocker button is released, the vehicle maintains the final speed achieved. Pressing the switch beyond the resistance point causes the vehicle to accelerate more rapidly.

Continuing cruise control

With saved speed

Warning

The set speed can be incorrectly adjusted or called up by mistake. There is a risk of accident. Adjust the set speed to the traffic conditions. Watch surrounding traffic closely and actively intervene where appropriate.

An interrupted cruise control can be continued by calling up the stored speed. The difference between the current speed and the stored speed should be as little as possible.



Press the button with the system interrupted.

Cruise control is continued with the stored values.

In the following cases, the stored speed value is deleted and cannot be called up again:

- ▶ When the system is switched off.
- ▶ When drive-ready state is switched off.



At the current speed



Press the rocker button up or down to continue cruise control at the current speed.

Speed Limit Assistant: at the suggested speed



When a speed is suggested, press the button to accept the Cruise Control at the suggested speed.

Displays in the instrument cluster

Display in the speedometer



- ▶ Green marking: system is active, the marking indicates the desired speed.
- ▶ Gray marking: system is interrupted, the marking indicates the stored speed.

▶ No marking: system is switched off.

Indicator light



Indicator light green: system is active.

Displays in the Head-up display

Depending on the equipment, some system information can also be displayed in the Head-up display.

System limits

The set speed is also maintained downhill. The speed may not be maintained on uphill grades if the drive power is insufficient.

Depending on the driving mode, the vehicle may exceed or drop below the set desired speed in some situations; for instance, on downhill or uphill grades.

Distance control

Principle

With the distance control, a distance to a vehicle driving ahead can be adjusted in addition to the Cruise Control.

General information

The system maintains the set speed on clear roads. The vehicle accelerates or brakes automatically.

If a vehicle is driving ahead of you, the system adjusts the speed of the vehicle so that the set distance to the vehicle ahead is maintained. The speed is adjusted as far as the given situation allows.

The distance can be adjusted at several levels. For safety reasons, it depends on the respective speed.

If the vehicle ahead of you brakes to a standstill and then drives off again within a brief period, the system is able to detect this within the given system limits.

Otherwise, drive off independently such as by stepping on the accelerator pedal or by pressing the button for the speed setting on the steering wheel.

Safety information

Warning

The system cannot serve as a substitute for the driver's personal judgment in assessing the traffic situation. Based on the limits of the system, it cannot independently react to all traffic situations. There is a risk of accident. Adjust driving style to traffic conditions. Watch the surrounding traffic situation closely, be ready to take over steering and braking at any time, and actively intervene where appropriate.

Warning

An unsecured vehicle can begin to move and possibly roll away. There is a risk of accident. Before leaving the vehicle, secure the vehicle against rolling away.

In order to ensure that the vehicle is secured against rolling away, follow the following:

- ▷ Set the parking brake.
- ▷ On uphill grades or on downhill slopes, turn the front wheels in the direction of the curb.
- ▷ On uphill grades or on downhill slopes, also secure the vehicle, for instance with a wheel chock.

Warning

The set speed can be incorrectly adjusted or called up by mistake. There is a risk of accident. Adjust the set speed to the traffic conditions. Watch surrounding traffic closely and actively intervene where appropriate.

Warning





Risk of accident is greater when there is a high speed differential to other vehicles, for instance in the following situations:

- ▷ When approaching a slowly moving vehicle at speed.
- ▷ Vehicle suddenly swerving into own lane.
- ▷ When approaching stationary vehicles at speed.

There is a risk of injury or danger to life. Watch surrounding traffic closely and actively intervene where appropriate.

Overview

Buttons on the steering wheel

Button	Function
	Turn last active speed control system on/off. Interrupt and continue speed control systems.
	Select the desired speed control system.
	Store current speed. Speed Limit Assistant: accept suggested speed manually.
	Set speed.

Sensors

The system is controlled by the following sensors:

- ▷ Camera behind the windshield.
- ▷ Front radar sensor.

Additional information:

Sensors of the vehicle, refer to page 35.

Application range



The system is best used on well-maintained roads.

The maximum speed that can be set is limited and depends, for example, on the vehicle and the vehicle equipment.

The system can also be activated when stationary.



Turning on Cruise Control with distance control

-  If necessary, press the button.
-  If necessary, press the button repeatedly until distance control is selected.

Cruise control with distance control is active. The current speed is maintained and stored as desired speed.

The selected distance to a vehicle driving ahead is maintained.

The indicator lights in the instrument cluster illuminate and the mark on the speedometer is set to the current speed.

The driving mode changes or Dynamic Stability Control activates when Distance Control is switched on.

Adjusting the speed

The speed can be set using the rocker button on the steering wheel.

Additional information:

Cruise control, refer to page [221](#).

Interrupting Cruise control with distance control automatically

The system is stopped automatically in the following situations, for example:

- ▷ When braking manually.
- ▷ Selector lever position D is disengaged.
- ▷ While Dynamic Stability Control is disabled.
- ▷ "SPORT PLUS": the settings for increased driving dynamics are activated.
- ▷ While Dynamic Stability Control regulates driving stability.
- ▷ Driver's seat belt and driver's door are opened.
- ▷ The system has not detected objects for an extended period, for instance on a

road with very little traffic without curb or shoulder markings.

- ▷ The detection range of the radar is impaired, for instance by contamination or heavy precipitation.
- ▷ After a longer stationary period when the vehicle has been braked to a stop by the system.

Turning the speed control system off/interrupting

The speed control system can be turned off or canceled automatically or manually.

Additional information:

Speed control systems, refer to page [218](#).

Continuing cruise control while driving

Warning

The set speed can be incorrectly adjusted or called up by mistake. There is a risk of accident. Adjust the set speed to the traffic conditions. Watch surrounding traffic closely and actively intervene where appropriate.

An interrupted cruise control can be continued by calling up the stored speed. The difference between the current speed and the stored speed should be as little as possible.

Additional information:

Cruise control, refer to page [221](#).

Continuing cruise control while vehicle is stationary

In certain situations, this system requires the driver to confirm their intention to drive off.

The displays show the following:



The mark on the speedometer illuminates gray.



The indicator light illuminates green.

Cruise control can be continued as follows:

▷ Pressing the accelerator pedal.



▷ Press the rocker button on the left side of the steering wheel.



▷ Press the button on the left side of the steering wheel.

Distance

Safety information

Warning

The system cannot serve as a substitute for the driver's personal judgment. Due to the system limits, deceleration can be late. There may be a risk of accidents or risk of damage to property. Be aware of the surrounding traffic situation at all times. Adjust the distance to the traffic and weather conditions and maintain the prescribed safety distance, possibly by braking.

Adjusting the distance

1.  Apps menu
2. "Vehicle"
3. "Driving settings"
4. "Driver Assistance"
5. "Driving"
6. "Distance control"

7. "Distance"
8. Select the desired setting.

Automatic adaptation of the distance

Depending on the equipment and national-market version: the system can be set so that the distance to the vehicle in front is automatically adjusted within the set distance. The system takes into account the traffic situation and ambient conditions, e.g. poor visibility.

1.  Apps menu
2. "Vehicle"
3. "Driving settings"
4. "Driver Assistance"
5. "Driving"
6. "Distance control"
7. "Situational distance control"

Changing between Cruise Control with/without Distance Control

Safety information

Warning

The system does not react to traffic driving ahead of you, but instead maintains the stored speed. There may be a risk of accidents or risk of damage to property. Adjust the set speed to the traffic conditions and brake as needed.

Changing over the Cruise Control mode

Turning Cruise Control without distance control on or off:

1.  Apps menu
2. "Vehicle"
3. "Driving settings"
4. "Driver Assistance"
5. "Driving"



6. "Distance control"
7. "Switch to Cruise Control"

The setting is reset when the vehicle is parked.

Displays in the instrument cluster

General information

Depending on the equipment version, the displays in the instrument cluster may vary.

Display in the speedometer

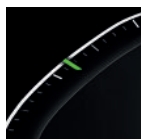

- ▶ Green marking: system is active, the marking indicates the desired speed.
- ▶ Gray marking: system is interrupted, the marking indicates the stored speed.
- ▶ No marking: system is switched off.

Indicator lights and warning lights

Icon	Description
	White indicator light: No Distance Control because accelerator pedal is being pressed.
	Indicator light illuminates green: Vehicle has been detected ahead of you. The vehicle icon goes out if no vehicle has been detected ahead of you. Indicator light flashes green: Preceding vehicle has driven off.

Icon	Description
	Indicator light flashes gray: Conditions are not adequate for the system to work. The system was deactivated but applies the brakes until you actively resume control by pressing on the brake pedal or accelerator pedal.
	Warning light flashes red and acoustic signal sounds: Brake and make an evasive maneuver, if necessary.

Assisted View

Depending on the equipment and national-market version, information for the system is displayed in the Assisted View in the central display area of the instrument cluster.

Additional information:

Assisted View, refer to page 158.

Displays in the Head-up display

Set speed

Depending on the equipment, some system information can also be displayed in the Head-up display.

Distance information



The icon is displayed when the distance from the vehicle traveling ahead is too short.

The distance information is active in the following situations:

- ▶ Cruise Control with Distance Control switched off.
- ▶ Display in the Head-up display selected.
Head-up display, refer to page 143.

- ▷ Distance too short.
- ▷ Speed greater than approx. 40 mph/70 km/h.

System limits

System limits of the sensors

Additional information:

- ▷ Cameras, refer to page 35.
- ▷ Radar sensors, refer to page 36.

Detection range

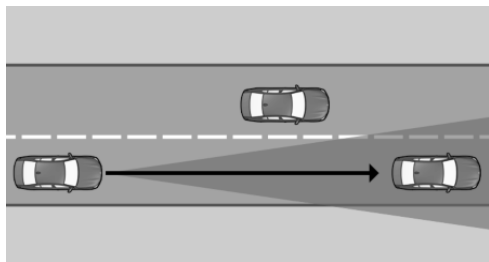

Sensors detect the traffic situation in their detection range.

The detection capability of the system and the automatic braking performance are limited.

For instance, two-wheeled vehicles may not be detected.

Deceleration

The system does not decelerate in the following situations:

- ▷ For pedestrians or similarly slow-moving road users.
- ▷ For cross traffic.
- ▷ For oncoming traffic.

Merging vehicles

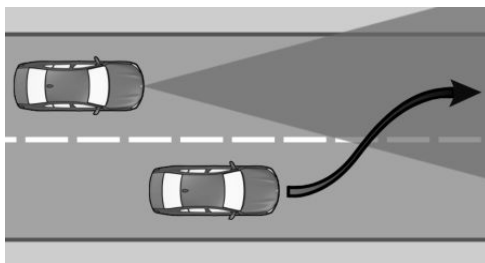

If a vehicle driving ahead of you suddenly merges into your lane, the system may not be able to automatically restore the selected distance. It may not be possible to restore the selected distance in certain situations, including if you are driving significantly faster than vehicles driving ahead of you, for instance when rapidly approaching a truck. When a vehicle driving ahead of you is reliably detected, the system requests that the driver intervene by braking and making an evasive maneuver, if needed.

Cornering

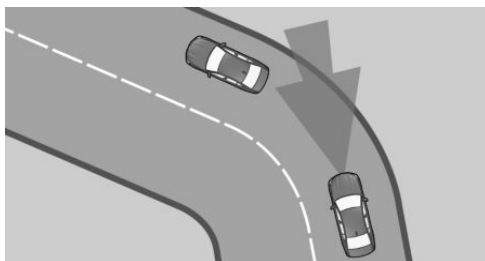

When the set speed is too high for a curve, the speed is reduced slightly. Because curves may not be anticipated in advance, drive into a curve at an appropriate speed.

The system has a limited detection range. Situations can arise in tight curves where a vehicle driving ahead will not be detected or will be detected very late.

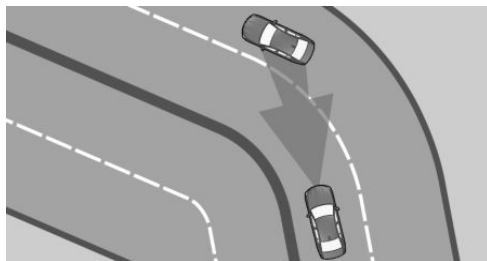

When you approach a curve the system may briefly report vehicles in the next lane due to the bend of the curve. If the system decelerates you may compensate for it by briefly accelerating. After releasing the accelerator pedal the system is reactivated and controls speed independently.

Driving off

In some situations, the vehicle cannot drive off automatically; for example:

- ▶ On steep uphill grades.
- ▶ In front of bumps in the road.

In these cases, step on the accelerator pedal.

Weather

The following restrictions can occur under unfavorable weather or light conditions:

- ▶ Poorer vehicle detection.
- ▶ Short-term interruptions for vehicles that are already recognized.

Drive attentively, and react to the current surrounding traffic situation. If necessary, intervene actively, for instance by braking, steering or making an evasive maneuver.

Drive power

The set speed is also maintained downhill. The speed may not be maintained on uphill grades if the drive power is insufficient.

Depending on the driving mode, the vehicle may exceed or drop below the set desired speed in some situations; for instance, on downhill or uphill grades.

Assisted Driving Mode

Principle

Assisted Driving Mode enhances Distance Control with Steering Assistance and Lane Guidance. The system assists the driver in keeping the vehicle within the lane. For this purpose, the system executes supporting steering movements, for instance when cornering.

General information

Depending on the speed, the system orients itself according to the lane boundaries or vehicles in front.

Sensors in the steering wheel detect whether the steering wheel is being touched.

Depending on the vehicle equipment and national-market version, the Driver Attention Camera in the instrument cluster monitors the driver's attention.

Safety information

Warning

The system cannot serve as a substitute for the driver's personal judgment in assessing the traffic situation. Based on the limits of the system, it cannot independently react to all traffic situations. There is a risk of accident. Adjust driving style to traffic conditions. Watch the surrounding traffic situation closely, be ready to take over steering and braking at any time, and actively intervene where appropriate.

The Cruise Control and Distance Control alerts also apply.

Additional information:

- ▶ Cruise control, refer to page [221](#).
- ▶ Distance control, refer to page [223](#).

Overview

Buttons on the steering wheel

Button	Function
	Turn last active speed control system on/off. Interrupt and continue speed control systems.
	Select the desired speed control system.
	Store current speed. Speed Limit Assistant: accept suggested speed manually.
	Set speed.



Turn last active speed control system on/off.
Interrupt and continue speed control systems.



Select the desired speed control system.



Store current speed.
Speed Limit Assistant: accept suggested speed manually.



Set speed.

Sensors

The system is controlled by the following sensors:

- ▷ Camera behind the windshield.
- ▷ Front radar sensor.
- ▷ Depending on the equipment:
Radar sensors, side, front.
- ▷ Depending on the equipment:
Radar sensors, side, rear.
- ▷ Sensors in steering wheel.
- ▷ Depending on the vehicle equipment and national-market version: Driver Attention Camera

Additional information:



- ▷ Sensors of the vehicle, refer to page 35.
- ▷ Driver Attention Camera, refer to page 210.

Functional requirements

- ▷ Depending on the equipment: speed below 130 mph/210 km/h or 110 mph/180 km/h.
- ▷ Sufficient lane width.

- ▷ Hands on the steering wheel rim.
- ▷ Sufficiently wide curve radius.
- ▷ Drive in the center of the lane.
- ▷ The sensor system calibration process is complete.
- ▷ Distance control is active.
- ▷ Seat belt on the driver's side fastened.
- ▷ Forward Collision Mitigation is active.
- ▷ Depending on the equipment:
Side-collision warning is active.

Switching on Assisted Driving Mode

1.  If necessary, press the button.
2.  If necessary, press the button repeatedly until Assisted Driving Mode is selected.



Indicator light illuminates gray:
The system is on standby and does not manipulate steering movements.

System activates automatically as soon as all function conditions are fulfilled.



The indicator light illuminates green.
The system is active and helps to keep the vehicle in the lane.

When the system is switched on, the Forward Collision Mitigation and, depending on the equipment, the side-collision warning are active.

Stopping Assisted Driving Mode automatically

The system interrupts the supporting steering movements automatically, for example in the following situations:



- ▷ Depending on the equipment: at a speed above 130 mph/210 km/h or 110 mph/180 km/h.
- ▷ After releasing the steering wheel.
- ▷ With strong steering intervention.
- ▷ When leaving own lane.
- ▷ When the turn signal is switched on or, depending on the vehicle equipment, when the driver turns the steering wheel while the turn signal is switched on.
- ▷ When the lane is too narrow.
- ▷ If a lane boundary is not detected and there is no vehicle driving in front.
- ▷ The Cruise Control with distance control is interrupted.
- ▷ The seat belt on the driver's side is unfastened.



Indicator light illuminates gray:
The system is on standby and does not manipulate steering movements.

System activates automatically as soon as all function conditions are fulfilled.

Displays in the instrument cluster

Icon	Description
	Indicator light illuminates gray: The system is ready.
	Indicator light illuminates green: The system is activated. The system supports the driver in keeping the vehicle within the lane.
	Warning light flashes yellow and steering wheel vibrates: A lane boundary has been crossed.



Indicator light illuminates gray:
The system is ready.



Indicator light illuminates green:
The system is activated.
The system supports the driver in keeping the vehicle within the lane.



Warning light flashes yellow and steering wheel vibrates:
A lane boundary has been crossed.

Icon	Description
	Warning light illuminates and acoustic signal sounds: Yellow: System interruption is imminent.
	Warning light flashes red and acoustic signal sounds: The system is switched off or will be interrupted very soon.
	Warning light illuminates yellow: Hands are not grasping the steering wheel. The system is still active. Grab the steering wheel with your hands.
	Warning light illuminates red, acoustic signal sounds: The hands are not on the steering wheel or, depending on the vehicle equipment and national-market version, the driver's line of sight is not directed at the surrounding traffic. Yellow: System interruption is imminent. The system reduces the speed to a standstill if applicable. It is possible that the system will not execute any supporting steering movements. Immediately grasp the steering wheel with your hands and pay attention to the surrounding traffic.



Warning light illuminates and acoustic signal sounds:
Yellow: System interruption is imminent.



Warning light flashes red and acoustic signal sounds:
The system is switched off or will be interrupted very soon.



Warning light illuminates yellow:
Hands are not grasping the steering wheel. The system is still active.
Grab the steering wheel with your hands.



Warning light illuminates red, acoustic signal sounds:
The hands are not on the steering wheel or, depending on the vehicle equipment and national-market version, the driver's line of sight is not directed at the surrounding traffic. Yellow: System interruption is imminent.
The system reduces the speed to a standstill if applicable.



It is possible that the system will not execute any supporting steering movements.

Immediately grasp the steering wheel with your hands and pay attention to the surrounding traffic.

Depending on the vehicle equipment and national-market version, a Check Control message is displayed if the Driver Attention Camera detects that the driver is inattentive.

Depending on the equipment and national-market version, information for the system is displayed in the Assisted View in the central display area of the instrument cluster.

Additional information:

Assisted View, refer to page 158.

Displays on the steering wheel

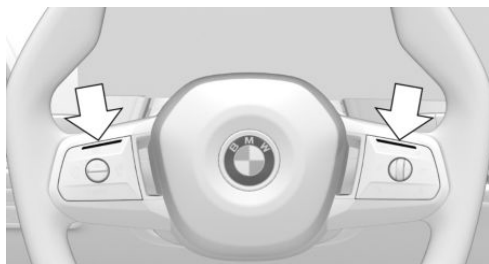

Similar to the instrument cluster views, the two LEDs above the keypads illuminate.

The steering wheel displays can be turned on/off.

1. Apps menu
2. "Vehicle"
3. "Driving settings"
4. "Driver Assistance"
5. "Feedback via steering wheel"
6. "Light elements"
7. Select the desired setting.

Displays in the Head-up display

Depending on the equipment, the system information can also be displayed in the Head-up display.

Setting the intensity of the steering wheel vibration

1. Apps menu
2. "Vehicle"
3. "Driving settings"
4. "Driver Assistance"
5. "Feedback via steering wheel"
6. "Vibration intensity"
7. Select the desired setting.

This setting is applied to all collision warning systems.

System limits

General information

The system cannot be activated or meaningfully used in certain situations.

Safety information

Warning

Due to its limits, the system may not react, or it may react too late or in a manner that is not consistent with normal use. There may be a risk of accidents or risk of damage to property. Actively intervene as warranted. Refer to the information in this Owner's Manual regarding the scope of the system's operation and limitations.

The Cruise Control and Distance Control alerts also apply.

Additional information:

- ▷ Cruise control, refer to page 221.
- ▷ Distance control, refer to page 223.

System limits of the sensors

Additional information:

- ▷ Cameras, refer to page 35.
- ▷ Radar sensors, refer to page 36.
- ▷ Driver Attention Camera, refer to page 210.

Hands on the steering wheel

The sensors cannot detect hand-steering wheel contact in the following situations:

- ▷ Driving with gloves.
- ▷ Protective covers on the steering wheel.

Weather

The following restrictions can occur under unfavorable weather or light conditions:

- ▷ Poorer recognition of vehicles and lane boundaries.
- ▷ Short-term interruptions in case of already detected vehicles and lane boundaries.

Drive attentively, and react to the current surrounding traffic situation. If necessary, intervene actively, for instance by braking, steering or making an evasive maneuver.

Lane Change Assistant

Principle

The Lane Change Assistant also assists when changing lanes on multi-lane roads.

General information

The system uses the Assisted Driving Mode sensors.

Safety information

Warning

The system cannot serve as a substitute for the driver's personal judgment in assessing the traffic situation. Based on the limits of the system, it cannot independently react to all traffic situations. There is a risk of accident. Adjust driving style to traffic conditions. Watch the surrounding traffic situation closely, be ready to take over steering and braking at any time, and actively intervene where appropriate.

Federal, state, or local laws may differ, and the use of this function may be prohibited or limited. Before use, check federal, state, and local laws.

The Assisted Driving Mode alerts also apply.

Additional information:

Assisted Driving Mode, refer to page [229](#).

Functional requirements

- ▷ The functional requirements for Assisted Driving Mode have been met. Assisted Driving Mode, refer to page [229](#).
- ▷ Driving on a road without pedestrians or cyclists and with physical barriers to oncoming traffic such as crash barriers.
- ▷ A vehicle has been detected at a sufficient distance behind your own vehicle since beginning the drive.
- ▷ Crossable lane boundaries are detected.
- ▷ Maximum speed approx. 110 mph/180 km/h.
- ▷ The minimum speed is country-specific.

Turning on/turning off Lane Change Assistant

1.  Apps menu
2. "Vehicle"
3. "Driving settings"
4. "Driver Assistance"
5. "Driving"
6. "Assisted Driving"
7. "Automatic Lane Change"

The settings for the Automatic Lane Change Assistant can be configured, depending on vehicle equipment and national-market version.

Changing lanes

1. Ensure that the traffic situation permits changing lanes.
2. Start the lane change.
 - ▷ To initiate the lane change, press the indicator stalk in the desired direction to the resistance point.
 - ▷ Depending on the vehicle equipment, the indicator/high-beam stalk can also be pressed beyond the resistance point.
 - ▷ Depending on the vehicle equipment, the lane change can already be started

by the driver checking their field of vision to ensure that the traffic situation permits a lane change. For this case, Lane Change Assistant must clearly recognize the driving situation and the Driver Attention Camera must clearly recognize the driver's line of sight. To do so, it may be necessary to turn on the Lane Change Assistant when route guidance is on, or to configure this function on the control display.



After a short time, Lane Change Assistant initiates a lane change.

After the lane change, the system helps keep the vehicle in the new lane.

Canceling a lane change

The lane change can be canceled by steering movement into the opposite direction or by operating the turn signal in the opposite direction.

Displays in the instrument cluster

Icon	Description
	Steering wheel icon and lane change arrow icon are green: The system carries out a lane change.
	Steering wheel icon is green and line for lane marking on respective side is gray: The system detected the lane change request. Lane change not currently possible.

Depending on the equipment and national-market version, information for the system is displayed in the Assisted View in the central display area of the instrument cluster.

Additional information:

Assisted View, refer to page 158.

System limits

The limits of the Assisted Driving Mode system apply.

The limits of the Driver Attention Camera system also apply to automatic lane changes.

Additional information:

- ▶ Assisted Driving Mode, refer to page 229.
- ▶ Driver Attention Camera, refer to page 210.

Assisted Driving Mode Plus

Principle

Assisted Driving Mode Plus provides assistance when driving on highways.

The system increases driving comfort in suitable driving situations.

Sensors in the steering wheel detect whether the steering wheel is being touched.

Different versions of this function are available depending on vehicle equipment and national-market version.

- ▶ Version for speeds up to approx. 40 mph/60 km/h, e.g., traffic jam.
- ▶ Version for speeds up to approx. 85 mph/135 km/h.

General information

For versions up to 85 mph/135 km/h, the following applies:

Assisted Driving Mode Plus will be active at the time of vehicle delivery and will only be available for a limited period. Information about the duration of availability for Assisted Driving Mode Plus will be available prior to and at the time of vehicle sale. Assisted Driving Mode Plus may be terminated earlier due to technical or legal requirements. Further information about the availability of Assisted Driving Mode Plus can be requested from an authorized service center.



Safety information

Warning

The system cannot serve as a substitute for the driver's personal judgment in assessing the traffic situation. Based on the limits of the system, it cannot independently react to all traffic situations. There is a risk of accident. Adjust driving style to traffic conditions. Watch the surrounding traffic situation closely, be ready to take over steering and braking at any time, and actively intervene where appropriate.

Warning

The system is only intended for use on roads with structural separations such as highways. Because of the system limits, the system can also remain active on roads without structural separations and may not react as expected. There is a risk of accident. Deactivate the system if it is enabled on roads without structural separations.

Federal, state, or local laws may differ, and the use of this function may be prohibited or limited. Before use, check federal, state, and local laws.

The Assisted Driving Mode alerts also apply.

Additional information:

Assisted Driving Mode, refer to page [229](#).

Overview

Sensors

The system is controlled by the following sensors:

- ▷ Camera behind the windshield.
- ▷ Front radar sensor.
- ▷ Side radar sensors, front.
- ▷ Side radar sensors, rear.

- ▷ The sensors in the steering wheel.
- ▷ Driver Attention Camera.

The version up to 85 mph/135 km/h additionally uses the following sensors:

- ▷ Front camera.
- ▷ Exterior mirror cameras.
- ▷ Rearview camera.

Additional information:

Sensors of the vehicle, refer to page [35](#).

Functional requirements

The following functional requirements apply to Assisted Driving Mode Plus:

- ▷ Assisted Driving Mode Plus must be available in the country in which the vehicle is driven.
- ▷ The functional requirements for Assisted Driving Mode have been met.

Assisted Driving Mode is active and the LED displays on the steering wheel are switched on.

Assisted Driving Mode, refer to page [229](#).
- ▷ Driving on a highway-like road without pedestrians or cyclists and with physical barriers to oncoming traffic, e.g., guard rails.
- ▷ Lane boundaries are detected.
- ▷ Sufficient lane width.
- ▷ Sufficiently wide curve radius.
- ▷ The navigation system must clearly identify the road and vehicle position.
- ▷ This function must be available on the road on which the vehicle is driving.
- ▷ Antennas located in the roof must not be covered, e.g., by roof loads or snow.
- ▷ The Driver Attention Camera in the instrument cluster detects that the driver is paying attention to the surrounding traffic.

For the version up to 40 mph/60 km/h, the following additional functional requirements apply:

- ▷ A vehicle has been detected ahead of you.
- ▷ Speed below approx. 40 mph/60 km/h.

For the version up to 85 mph/135 km/h, the following additional functional requirements apply:

- ▷ Assisted Driving Mode Plus is enabled in the vehicle.
- ▷ The navigation data must be up to date.
- ▷ Vehicle speed is less than approx. 85 mph/135 km/h.
- ▷ The systems in the vehicle, e.g., the Attention Assistant and the Driver Attention Camera recognize that the driver is rested.

Switching Assisted Driving Mode Plus on/off

1.  Apps menu
2. "Vehicle"
3. "Driving settings"
4. "Driver Assistance"
5. "Driving"
6. "Assisted Driving"
7. "Assisted Driving Plus"

Assisted Driving Mode Plus is automatically offered when Assisted Driving Mode is active and all functional requirements for Assisted Driving Mode Plus have been met.

Two green LED lights are illuminated on the steering wheel.



The indicator light in the instrument cluster is shown in green.

The system begins to assist the driver with vehicle control.

When the system is switched on, the following functions are enabled:

- ▷ Forward Collision Mitigation.
- ▷ Side collision mitigation.
- ▷ For the version up to 85 mph/135 km/h: Some speed control systems, e.g., adjusting speed to course of road.

Displays in the instrument cluster

Icon	Description
	Indicator light green: system is active.
	Indicator light gray: the system has been interrupted and will activate automatically as soon as all functional requirements are met.
	White indicator light: the system can be activated.

Depending on the equipment and national-market version, information for the system is displayed in the Assisted View in the central display area of the instrument cluster.

Additional information:

Assisted View, refer to page 158.

Displays on the steering wheel

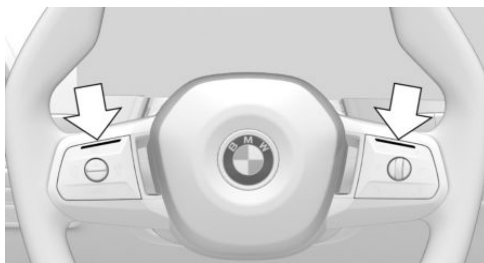

The two LEDs above the keypads illuminate depending on the situation.

- ▷ Green: the system is active.
- ▷ Yellow: system will be interrupted. Grab the steering wheel with your hands.
- ▷ Red: system will be deactivated. Grab the steering wheel immediately with your hands.

Additional information:

Assisted Driving Mode, refer to page 229.

Displays in the Head-up display

Depending on the equipment, the system information can also be displayed in the Head-up display.

Navigation system displays

For the version up to 85 mph/135 km/h, roads on which Assisted Driving Mode Plus supports vehicle control can be displayed on the navigation system.

1.  Navigation menu
2. "Suggestions"
3. Select the desired setting.

System limits

The system limits of the following systems apply:

- ▷ Assisted Driving Mode
- ▷ Driver Attention Camera
- ▷ For the version up to 85 mph/135 km/h: Fatigue Alert
- ▷ Sensors of the vehicle

Additional information:

- ▷ Assisted Driving Mode, refer to page [229](#).
- ▷ Driver Attention Camera, refer to page [210](#).
- ▷ Fatigue alert, refer to page [209](#).
- ▷ Sensors of the vehicle, refer to page [35](#).

Speed Limit Assistant

Principle

Speed Limit Assistant supports driving at the speed limit. A suggested speed can be applied.

General information

When the systems in the vehicle, e.g., Speed Limit Info, detect a change of the speed limit,

this new speed value can be applied for the following systems:

- ▷ Cruise control.
- ▷ Distance control.
- ▷ Assisted Driving Mode.
- ▷ Assisted Driving Mode Plus.

The speed value is suggested as the new desired speed to be applied. To apply the speed value, the corresponding system must be activated.

Safety information

Warning



The system cannot serve as a substitute for the driver's personal judgment in assessing the traffic situation. Based on the limits of the system, it cannot independently react to all traffic situations. There is a risk of accident. Adjust driving style to traffic conditions. Watch the surrounding traffic situation closely, be ready to take over steering and braking at any time, and actively intervene where appropriate.

Warning

The set speed can be incorrectly adjusted or called up by mistake. There is a risk of accident. Adjust the set speed to the traffic conditions. Watch surrounding traffic closely and actively intervene where appropriate.

Overview

Buttons on the steering wheel

Button	Function
	Accept suggested speed manually.
	Set speed, refer to Cruise Control.

Turning Speed Limit Assistant on/off



1.  Apps menu
2. "Vehicle"
3. "Driving settings"
4. "Driver Assistance"
5. "Driving"
6. "Speed Limit Assistant"
7. "Speed limits"
8. Select the desired setting:
 - ▶ "Adjust manually": detected speed limits can be applied manually.
 - ▶ "Show current limit": current speed limits are displayed without being applied in the instrument cluster.
 - ▶ "Off": depending on the national-market version, Speed Limit Info and Speed Limit Assistant will be turned off.
If necessary, other anticipatory comfort functions will be turned off.

Additional information:

Speed Limit Info, refer to page [216](#).

Displays in the instrument cluster

A message is displayed in the instrument cluster when the system and a speed control system are activated.

Icon	Function
	Detected change of a speed limit with immediate effect.
	Depending on the national-market version, it is possible to switch between the units of measurement.
	Indicator light illuminates green: the detected speed limit can be applied with the SET button. After it has been applied, a green checkmark is displayed.

Manual adoption

A detected speed limit can be applied manually to the active speed control system.

 When the SET icon is displayed, press the button.

Speed adjustment

Principle

It can be adjusted whether the speed limit is applied exactly or with a tolerance.

General information

A speed adaptation for all speed limits and an additional speed adaptation for speed limits up to 40 mph/60 km/h can be set up.

The additional speed adaptation for speed limits up to 40 mph/60 km/h can be activated or deactivated.

Setting the speed adjustment

1.  Apps menu
2. "Vehicle"
3. "Driving settings"
4. "Driver Assistance"
5. "Driving"

6. "Speed Limit Assistant"
7. Select the desired setting:
 - ▷ "Adjust speed limits": set the tolerance for speed adjustments, which applies to all speed limits.
 - ▷ "2nd adjustm. up to": activate or deactivate additional speed adaptation.
 - ▷ "Adjust speed limits": with activated additional speed adjustment, set the tolerance for speed limits up to 40 mph/60 km/h.

System limits

Speed Limit Assistant is based on the Speed Limit Info system.

Consider the system limits of Speed Limit Info.

Additional information:

- ▷ System limits of Speed Limit Info, refer to page 218.
- ▷ System limits of the sensors, refer to page 35.

Adapting the speed to the route

Principle

The system can be configured so that with active distance control, the vehicle adapts the speed automatically to the route.

For instance, the speed will be reduced in the following situations as necessary:

- ▷ Before making turns.
- ▷ Before a roundabout.
- ▷ Before a curve.
- ▷ In front of an exit ramp on highways or highway-like roads.

Safety information

Warning

The system cannot serve as a substitute for the driver's personal judgment in assessing the traffic situation. Based on the limits of the system, it cannot independently react to all traffic situations. There is a risk of accident. Adjust driving style to traffic conditions. Watch the surrounding traffic situation closely, be ready to take over steering and braking at any time, and actively intervene where appropriate.

The Cruise Control, Distance Control, Assisted Driving Mode, and Speed Limit Assist alerts also apply.

Additional information:

- ▷ Cruise control, refer to page 221.
- ▷ Distance control, refer to page 223.
- ▷ Assisted Driving Mode, refer to page 229.
- ▷ Speed Limit Assistant, refer to page 237.

Functional requirements

- ▷ Cruise Control and distance control are activated.
- ▷ Driving on a highway or highway-like road.
- ▷ With navigation system: guidance is activated.

The use of navigation software via Apple CarPlay or Android Auto may lead to functional limitations, for instance deviations with navigation instructions.

- ▷ The function must be available in the country in which the vehicle is driven.

Adapting speed automatically to route

1.  Apps menu
2. "Vehicle"
3. "Driving settings"



4. "Driver Assistance"
5. "Driving"
6. "Route and intersection assistant"
7. "Automatically adjust speed to route"

Adjusting the cornering speed

The cornering speed can be adjusted depending on national-market version.

1. Apps menu
2. "Vehicle"
3. "Driving settings"
4. "Driver Assistance"
5. "Driving"
6. "Route and intersection assistant"
7. "Cornering speed"
8. Select the desired setting.

Displays in the instrument cluster

Depending on the equipment and national-market version, information for the system is displayed in the Assisted View in the central display area of the instrument cluster.

Additional information:

Assisted View, refer to page 158.

System limits

Depending on the national-market version or country in which the vehicle is currently being driven, the function may not be available.

The system does not react or reacts to a limited extent to the route ahead in the following situations:

- ▶ If the vehicle location cannot be clearly determined by the navigation system.
- ▶ On wintry roads.

Additionally, the limits for Cruise Control, Distance Control, Assisted Driving, and Speed Limit Assist systems apply.

Additional information:

- ▶ Cruise control, refer to page 221.
- ▶ Distance control, refer to page 223.
- ▶ Assisted Driving Mode, refer to page 229.
- ▶ Speed Limit Assistant, refer to page 237.

Lane change with active guidance

Principle

Lane change with active guidance assists the driver when lane changes are necessary to reach a destination. A notice is also displayed on the instrument cluster. In addition, a slight jerk can be felt on the steering wheel.

General information

The system uses the Assisted Driving Mode sensors.

Safety information

Warning

The system cannot serve as a substitute for the driver's personal judgment in assessing the traffic situation. Based on the limits of the system, it cannot independently react to all traffic situations. There is a risk of accident. Adjust driving style to traffic conditions. Watch the surrounding traffic situation closely, be ready to take over steering and braking at any time, and actively intervene where appropriate.

The Cruise Control, Distance Control, and Assisted Driving alerts also apply.

Additional information:

- ▶ Cruise control, refer to page 221.
- ▶ Distance control, refer to page 223.
- ▶ Assisted Driving Mode, refer to page 229.



Functional requirements

- ▶ Cruise Control and Distance Control are activated.
- ▶ Driving on a highway or highway-like road.
- ▶ A situation-dependent minimum speed has been reached.
- ▶ The system detects a sufficiently large gap in traffic in the adjacent lane.
- ▶ A crossable lane boundary on the side of the desired lane change is detected.
- ▶ Destination guidance is active on the navigation system.

The function is not available when using navigation software via Apple CarPlay or Android Auto.

- ▶ The function must be available in the country in which the vehicle is driven.
- ▶ The Driver Attention Camera in the instrument cluster detects that the driver is paying attention to the surrounding traffic.

Switching lane change on/off with active destination guidance

1.  Apps menu
2. "Vehicle"
3. "Driving settings"
4. "Driver Assistance"
5. "Driving"
6. "Route and intersection assistant"
7. "Lane Guiding with Navigation"

Switching the steering wheel jerk on/off

You can switch the steering wheel jerk assistance on/off.

1.  Apps menu
2. "Vehicle"
3. "Driving settings"
4. "Driver Assistance"

5. "Driving"
6. "Route and intersection assistant"
7. "Steering wheel impulse"

Changing lanes

If lane changes are necessary to reach a navigation destination, a corresponding notice is displayed on the instrument cluster. In addition, a slight jerk can be felt on the steering wheel.

To change lanes, follow the instructions on the instrument cluster.





1.  The system detects a suitable gap in the flow of traffic in the adjacent lane. A green checkmark is displayed on the lane change icon on the instrument cluster. The system prepares for the lane change.
2. When a suitable gap is detected, the speed is adapted so that the vehicle remains level with the opening.
3. A Check Control message indicates a lane change suggestion.
4. When the traffic situation permits a lane change, the driver can steer the vehicle into the next lane.

For vehicles equipped with Lane Change Assistant: the Lane Change Assistant can be started, e.g., by operating the turn signal after the Check Control message appears.

5. If necessary, the system automatically starts additional lane changes.

Display in the instrument cluster

Icon	Function
	Indicates a necessary lane change. The icon varies depending on the traffic situation.
	A green checkmark on the icon indicates that the function is active. A red cross on the icon indicates that the system cannot assist with the lane change.

Depending on vehicle equipment and national-market version, the traffic situation is displayed in Assisted View on the instrument cluster.

Additional information:

Assisted View, refer to page [158](#).

System limits

The limits of the Cruise Control, Distance Control, and Assisted Driving Mode systems and Driver Attention Camera apply.

Additional information:

- ▷ Cruise control, refer to page [221](#).
- ▷ Distance control, refer to page [223](#).
- ▷ Assisted Driving Mode, refer to page [229](#).
- ▷ Driver Attention Camera, refer to page [210](#).

Parking

Vehicle features and options

This chapter describes model-specific equipment, systems, and functions that are currently available, or may become available in the future, even if they are not present in the vehicle.

Additional information:

Vehicle equipment, refer to page 8.

Parking assistance systems

General information

The parking assistance systems include different individual systems. The individual systems help the driver when parking, maneuvering, or reversing by providing various assistance functions, sensors, and camera views.

Additional information:

- ▶ Rearview camera, refer to page 248.
- ▶ Semi-automatic camera perspective, refer to page 249.
- ▶ Automatic camera perspective, refer to page 249.
- ▶ Side view, refer to page 250.
- ▶ 3D view, refer to page 250.
- ▶ Car wash view, refer to page 251.
- ▶ Panorama View, refer to page 251.
- ▶ Automatic activation of panorama view, refer to page 252.
- ▶ Door opening angle, refer to page 253.
- ▶ Remote 3D View, refer to page 253.
- ▶ Park Distance Control, refer to page 254.
- ▶ Active Park Distance Control, refer to page 257.
- ▶ Drive-off monitoring, refer to page 258.

- ▶ Automatic Parking Assistant, refer to page 259.
- ▶ Maneuver Assistant, refer to page 264.
- ▶ Remote Control Parking, refer to page 267.
- ▶ Back-up Assistant, refer to page 268.

Safety information

Warning

The system cannot serve as a substitute for the driver's personal judgment in assessing the traffic situation. Based on the limits of the system, it cannot independently react to all traffic situations. There is a risk of accident. Adjust driving style to traffic conditions. Watch the surrounding traffic situation closely, be ready to take over steering and braking at any time, and actively intervene where appropriate.

Overview

Button in the vehicle

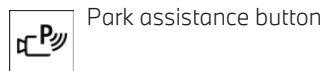
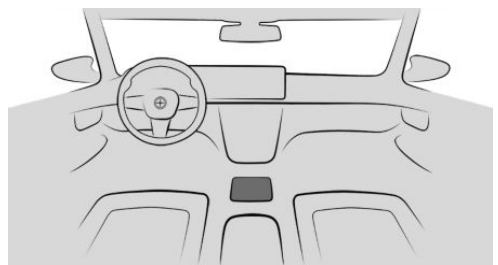

Park assistance button

Sensors

The parking assistance systems are controlled by the following sensors:

- ▶ Ultrasonic sensors in the front/rear bumpers.
- ▶ Ultrasonic sensors, side.
- ▶ Radar sensors, side, front.
- ▶ Radar sensors, side, rear.
- ▶ Front camera.
- ▶ Top view cameras.
- ▶ Rearview camera.

Additional information:

Sensors of the vehicle, refer to page 35.

Operating concept

The camera-based individual systems are operated with the function bars on the control display. The camera views can be viewed by selecting the appropriate icon.

In the Parking menu, some parking assistance systems can be configured individually.

Some parking assistance systems can be started by voice control, e.g., driving in/out of a parking space with the Automatic Parking Assistant.

Additional information:

BMW Intelligent Personal Assistant, refer to page 53.

Calling up Park menu

1.  Apps menu
2. "Vehicle"
3. "Driving settings"
4. "Driver Assistance"
5. "Parking"
6. Select the desired settings.

Display

Principle

With the Park Distance Control display and various camera views, the parking assistance

systems help you park, maneuver, and reverse your vehicle.

General information

Depending on the equipment, one or more cameras capture the area from different selectable perspectives.

Depending on the view, the vehicle's surroundings or a part of it is depicted.

Depending on the national-market version, either the automatic or the semi-automatic camera perspective is displayed.

Turning display on/off

General information

The parking assistance systems view switches off automatically when driving forwards or if a certain distance or speed is exceeded.

With reverse

When drive-ready state is switched on, the display is automatically switched on if selector lever position R is engaged.

Via Parking Assistant button



Press the button.

Via iDrive

1.  Apps menu
2. "Vehicle"
3. "Parking"

Display in the instrument cluster

The instrument cluster shows displays of some parking assistance systems such as Park Distance Control or Automatic Parking Assistant.

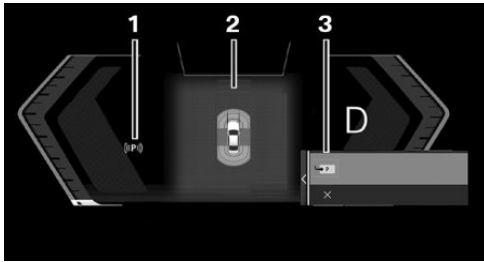

- 1 Status of parking assistance systems
- 2 Assisted View
- 3 Selection menu

Display on the control display

General information

Depending on vehicle equipment and on the activated parking assistance system, the control display will vary.

Assistance view

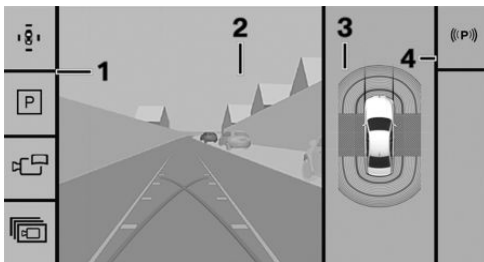

- 1 Toolbar, left
- 2 Camera image
- 3 Vehicle top view
- 4 Toolbar, right



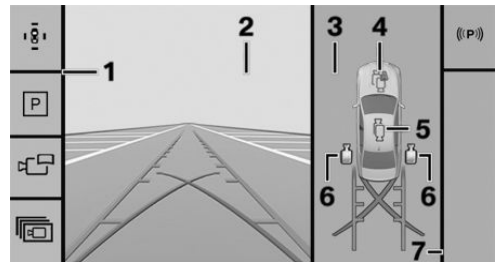



Parking view



- 1 Toolbar, left
- 2 Camera image
- 3 Selection window
- 4 Automatic camera perspective
- 5 Semi-automatic camera perspective
- 6 Side view
- 7 Toolbar, right

Toolbar, left

Different views and settings can be selected via the left toolbar depending on the equipment:

- ▷  "Parking view"
Depending on vehicle equipment, camera views or the Park Distance Control view are displayed.
- ▷  "Assist view"
A stylized top view of the vehicle is displayed.
- ▷  "Panorama view"
The cross traffic view is displayed.
- ▷  "More"
 - ▷  "3D view"
A three-dimensional view is displayed.
 - ▷  "Car wash view"
The display of your own lane can be turned on for easier driving into the car wash.
 - ▷  "Camera cleaning"

Cleaning of the front camera and rear-view camera can be switched on as needed.

- ▷  "Settings"
Settings can be entered in the Park menu.

Toolbar, right

The Parking Assistant functions are displayed in the right toolbar.



- ▷ Status of the parking assistance systems.
- ▷ Available parking methods of the Automatic Parking Assistant.
- ▷ Functions of the Back-up Assistant.
- ▷ Functions of the Maneuver Assistant.
- ▷ Additional information in case of malfunctions.



Status of parking assistance systems

The status of the following parking assistance systems is displayed:

- ▷ Automatic Parking Assistant.
- ▷ Maneuver Assistant.
- ▷ Back-up Assistant.

The icons are shown on the control display in the right toolbar and in the status area in the instrument cluster. In addition to the icon, a message is shown on the control display.

Icon	Meaning
	No search for parking assistance system offers. No other parking assistance systems available. Parking assistance systems have failed.
	Search for parking assistance system offers is active.

Icon	Meaning
	White: an available maneuver is selected but is not being performed. Functional requirements have not been met or the functions transfer has been completed. Green: parking assistance system is active. Functions are controlled depending on the system activated.
	Maneuver Assistant records the maneuver to be stored.

Additional displays

General information

Additional displays can be shown in the camera image of the display of the parking assistance systems, e.g., parking aid lines, to make parking and maneuvering easier.

Several additional displays can be active at the same time.

Turning additional displays on/off

1.  Apps menu
2. "Vehicle"
3. "Driving settings"
4. "Driver Assistance"
5. "Parking"
6. Select the desired setting.

Parking aid lines

Pathway lines

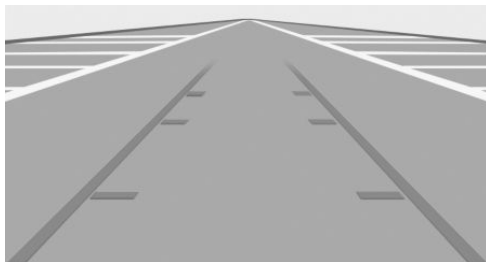

Pathway lines help you to estimate the space required when parking and maneuvering on level roads.

Lane lines are displayed in front of or behind the vehicle depending on the gear engaged.

The pathway lines are continuously adjusted to the steering movements depending on the steering-wheel angle.

Turning circle lines

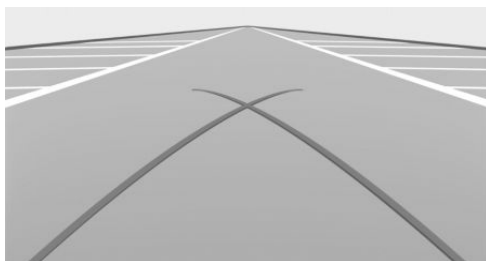

Turning circle lines can only be superimposed on the camera image together with pathway lines.

The lines show the course of the smallest possible turning circle on a level road.

Only one turning circle line is displayed after the steering wheel is turned past a certain angle.

Using parking aid lines

1. Position the vehicle so that the red turning circle line leads to within the limits of the parking space.
2. Turn the steering wheel to the point where the green pathway line covers the corresponding turning circle line.

Obstacle marking

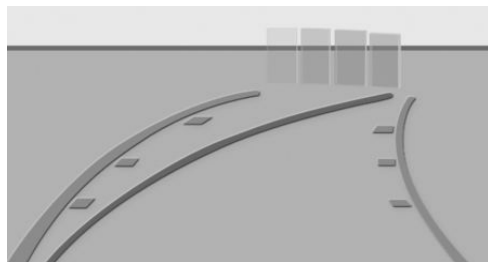

Obstacles are detected by the sensors.

The obstacles detected by the Park Distance Control are shown by marks in the camera image.

Colored gradients for the obstacle markings in green, yellow and red indicate the distances.

Functional limitations

The system can be used only to a limited extent in the following situations:

- ▶ With a door open.
- ▶ With open cargo area.
- ▶ With exterior mirrors folded in.

Areas with gray hatching with an icon in the camera image identify areas that are currently not shown such as an open door.

System limits

Safety information

Warning

Due to its limits, the system may not react, or it may react too late or in a manner that is not consistent with normal use. There may be a risk of accidents or risk of damage to property. Actively intervene as warranted. Refer to the information in this Owner's Manual regarding the scope of the system's operation and limitations.

System limits of the sensors

Additional information:

Sensors of the vehicle, refer to page 35.

Field of view

Because of the camera angle, the areas under the vehicle cannot be viewed by the cameras.

Detection of objects

Very low obstacles as well as high, protruding objects such as ledges may not be detected by the system.

The objects displayed on the control display may be closer than they appear. Do not estimate the distance to the objects on the control display.

Protruding cargo or a rear carrier can limit the detection range of the camera.

Malfunction

A camera failure is displayed on the control display.

The detection range of the failed camera is shown shaded on the control display.

Rearview camera

Principle

The rearview camera helps when reverse parking and maneuvering. The area behind the vehicle is shown on the control display.

Additional views can be shown on the display, e.g., parking aid lines and obstacle markings.

General information

Follow the information in the "Parking assistance systems" chapter.

Functional requirements

- ▷ The trunk is fully closed.
- ▷ The camera area is clean and clear.

Turning the rearview camera on/off

Turning the camera view on automatically



When drive-ready state is switched on, the rearview camera is automatically switched on if selector lever position R is engaged.

Turning the camera view off automatically

The rearview camera turns off automatically when driving forward or when a certain distance or speed is exceeded.

Turning the camera view on/off manually



1.  Press the button.
2. Engage selector lever position R.
 -  Depending on vehicle equipment: The icon in the selection window is selected automatically.

To exit rearview camera view, select another camera view in the selection window or press the button again.

Deactivated rearview camera

When the rearview camera is deactivated, for instance when the trunk is open, the camera image is displayed with gray shading.

Semi-automatic camera perspective

Principle



Depending on the parking direction and engaged selector lever position, a fixed camera perspective is displayed with the areas in front of or behind the vehicle.

General information

Follow the information in the "Parking assistance systems" chapter.

Turning the semi-automatic camera perspective on/off



1.  Press the button.
2.  Select the icon in the selection window.
To exit the fixed camera view, select another camera view in the selection window.

Automatic camera perspective

Principle

The automatic camera perspective shows a steering-dependent view in the respective driving direction.

This perspective adapts to the respective driving situation.

General information

As soon as obstacles are detected, the view changes to a fixed display of the area in front of or behind the bumper, or switches to side Park Distance Control as necessary.

When reverse gear is engaged, the automatic camera perspective is, if necessary, exited and the system uses a semi-automatic camera perspective to the rear. If necessary, select the automatic camera perspective when reverse gear is engaged. The automatic camera perspective will then be maintained for the current parking operation.

Follow the information in the "Parking assistance systems" chapter.

Turning the automatic camera perspective on/off



Turning the camera view on/off automatically

When the parking assistance systems' display is turned on, automatic camera perspective is selected automatically.

 The icon in the selection window is selected automatically.

To exit the steering-dependent camera view, select another camera view in the selection window.

Turning the camera view on/off manually

1.  Press the button.
2.  The icon in the selection window is selected automatically.

To exit the steering-dependent camera view, select another camera view in the selection window or press the button again.

Side protection

Principle

The side Park Distance Control is automatically displayed when the automatic camera perspective is turned on. The function shows obstacles located next to the vehicle.

General information

Follow the information in the "Parking assistance systems" chapter.

Display



To protect the sides of the vehicle, obstacle markings are displayed on the sides of the vehicle.

- ▶ No markings: no obstacles detected.
- ▶ Color marks: warning against detected obstacles.

System limits

The system only displays stationary obstacles that were previously detected by sensors while passing them.

The system does not detect whether an obstacle moves later on. For this reason, at standstill, the marks are not shown anymore in the display after a certain time. The area next to the vehicle must be newly captured.

Side view

Principle

Side view shows the vehicle's side surroundings, making it easier to position the vehicle at the curb or with other obstacles on the side.



The side view looks from rear to front and, in case of danger, focuses automatically on possible obstacles.

General information

Follow the information in the "Parking assistance systems" chapter.

Turning the side view on/off

The selection window lets you choose the side view for the left or right side of the vehicle.

1.  Press the button.
2.  Select the icon for the desired vehicle side in the selection window.

To exit the side view, select another camera view in the selection window.

3D view

Principle

With 3D view, a circle is displayed around the vehicle top view in the selection window.

Specified perspectives can be selected on the circle.

General information

The current perspective is marked with a camera icon.

Follow the information in the "Parking assistance systems" chapter.

Turning the 3D view on/off



1. Press the button.
2. "More"
3. "3D view"

To exit the 3D view, select another camera view on the left toolbar.

Car wash view

Principle

The car wash view assists when entering a car wash.

General information

Follow the information in the "Parking assistance systems" chapter.

Turning the car wash view on/off



1. Press the button.
2. "More"
3. "Car wash view"

To exit the car wash view, select a different camera view in the left toolbar.

Display

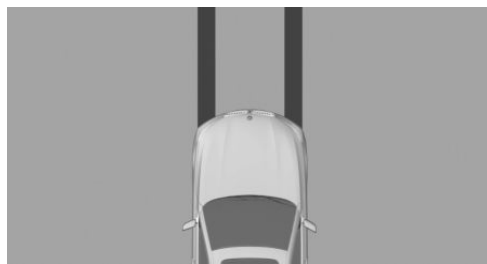

Your own lane is displayed for easier driving into a car wash.

This view can be used to position the vehicle correctly within the washing system guide rails.

In a car wash, the vehicle must be able to roll freely forward.

Additional information:

Rolling or pushing the vehicle, refer to page [130](#).

Panorama View

Principle

The panoramic view gives you an earlier view of crossing traffic at blind driveway exits and intersections.

General information

Road users concealed by obstacles to the left and right of the vehicle can only be detected relatively late from the driver's seat. The front camera and the rearview camera capture the area around the side of the vehicle to improve the view.

The camera image shows different levels of distortion in some areas and is thus not suitable for distance estimations.

Depending on vehicle equipment, the function can be used when driving forward or in reverse.

Follow the information in the "Parking assistance systems" chapter.

Sensors

The system is controlled by the following cameras:

- ▷ Rearview camera.
- ▷ Depending on the equipment: front camera.

Turning the panoramic view on/off

-  Press the button.
- "Panorama view"
To exit panorama view, select another camera view on the left toolbar.

Display



Yellow lines on the screen display identify the bumpers of your own vehicle.

Depending on the engaged selector lever position, the camera view of the rearview camera or front camera will be displayed.

Automatic activation of panorama view

Principle

Positions at which panorama view should switch on automatically can be saved as activation points.

General information

Up to ten activation points can be stored.

The activation points can be used when driving forward and, depending on national-market version, when reversing.

Follow instructions in the Parking assistance systems chapter.

Functional requirements

- ▶ A GPS signal must be received.
- ▶ Depending on national-market version: A BMW ID or driver profile must be activated.
- ▶ The direction of travel, selector lever position, and vehicle angle must correspond to a stored activation point.

Storing activation points

1. Drive your vehicle to the location where you want the system to turn on, then stop.

-  Press the button.
3. "Panorama view"
4. "Activation point"
The current position is displayed.
5. "Save activation point"

Activation points are saved with the following information, for example:

- ▶ With the city/town.
- ▶ With the city/town and the street.
- ▶ With the GPS coordinates.

You can rename the location and street information created automatically.

Using activation points

The use of activation points can be switched on and off.

1.  Apps menu
2. "Vehicle"
3. "Driving settings"
4. "Driver Assistance"
5. "Parking"
6. "GPS-based"

Editing activation points

You can rename or delete specific activation points or all of them.



1. Press the button.

2. "Panorama view"

3. "Manage points"

A list of all saved activation points is displayed.

4. Select the desired setting.

Door opening angle

Principle

Depending on vehicle equipment, the door opening angle display is shown automatically when stationary.

This display helps estimate how far the doors can be opened when parking.

If obstacle marking is activated, the parking view indicates fixed obstacles that obstruct the opening angles of the doors.

General information

Follow the information in the "Parking assistance systems" chapter.

Display

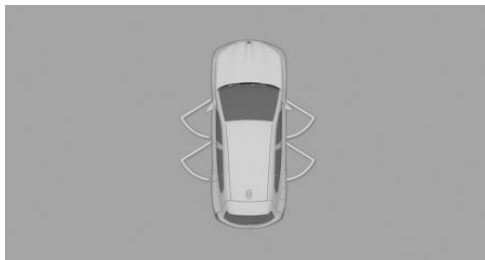

The maximum opening angle of the doors is displayed in selector lever position P.

System limits

The system does not provide a warning of approaching road users.

The vehicle's surroundings are distorted in the display for technical reasons.

Even if the door opening angle indicator on the control display does not overlap with any other objects, it is necessary to park carefully next to other objects.

Because of the perspective, higher, protruding objects may be closer than they appear on the control display.

Remote 3D View

Principle

The My BMW App and camera views in parking view such as automatic camera perspective enable you to display the vehicle's surroundings on a mobile device.

The function displays a snapshot of the situation.

General information

For reasons of data protection, the function can only be used three times within two hours.

Follow the information in the "Parking assistance systems" chapter.

Sensors

The system is controlled by the following cameras:

- ▷ Front camera.
- ▷ Top view cameras.
- ▷ Rearview camera.

Functional requirements

- ▷ Data transfer must be activated.

Data protection, refer to page 68.

- ▶ The My BMW App must be installed on the mobile end device.
- ▶ ConnectedDrive countries: a BMW ID with an existing ConnectedDrive account must be activated.
BMW ID/driver profiles, refer to page 69.

Activating/deactivating Remote 3D View

The function can be activated or deactivated individually or together with other functions.

1.  Apps menu
2. "Vehicle"
3. "System settings"
4. "Data privacy"
5. Select the desired setting.
After activation, Remote 3D View can be accessed using the My BMW App.

Functional limitations

The system may not be fully operational or may not be available in the following situations:

- ▶ With a door or the cargo area open. Dark fields in the display indicate areas that are not recorded by the system.
- ▶ With manually folded-in exterior mirrors.
- ▶ When other camera functions are being performed in the vehicle.
- ▶ The vehicle moves faster than walking speed.
- ▶ In case of missing or weak Internet connection.

Park Distance Control

Principle

Park Distance Control assists with parking. Acoustic and visual warnings signal obstacles in front of or behind the vehicle.

Obstacles that are detected by the side ultrasonic sensors can also be reported.

General information

The range of the system, depending on obstacles and environmental conditions, is approx. 6 ft/2 m.

An acoustic warning sounds in case of an impending collision at a distance to the object of approx. 27 in/70 cm.

For objects behind the vehicle, the acoustic warning is issued as early as a distance to the object of approx. 5 ft/1.50 m.

Follow the information in the "Parking assistance systems" chapter.

Safety information

Warning

The system cannot serve as a substitute for the driver's personal judgment in assessing the traffic situation. Based on the limits of the system, it cannot independently react to all traffic situations. There is a risk of accident. Adjust driving style to traffic conditions. Watch the surrounding traffic situation closely, be ready to take over steering and braking at any time, and actively intervene where appropriate.

Warning

Due to high speeds when the Park Distance Control is activated, the warning can be delayed due to physical circumstances. There is a risk of injury or risk of damage to property.

Avoid approaching an object too fast. Avoid driving off quickly while Park Distance Control is not yet active.

Sensors

The system is controlled by the following sensors:

- ▷ Ultrasonic sensors in the front/rear bumpers.
- ▷ Ultrasonic sensors, side.

Turning Park Distance Control on/off

Turning on the system automatically

The system switches on automatically in the following situations:

- ▷ When drive-ready state is switched on when selector lever position R is engaged.
- ▷ While approaching detected obstacles if the speed is lower than approx. 2.5 mph/4 km/h. The activation distance depends on the situation in question.

The automatic activation of detected obstacles can be activated or deactivated.

1.  Apps menu
2. "Vehicle"
3. "Driving settings"
4. "Driver Assistance"
5. "Parking"
6. "Automatic PDC activation"

Turning off the system automatically

When driving forward, the system turns off automatically as needed when a certain distance or speed is exceeded.

Turning the system on/off manually



Press the button.

- ▷ On: the LED illuminates.
- ▷ Off: the LED goes out.

If the system is manually switched on when the reverse gear is engaged, the rearview camera image is displayed.

Depending on the national-market version, the system cannot be turned off manually when the reverse gear is engaged.

Acoustic warning

General information

An intermittent tone indicates when the vehicle is approaching an object. E.g., when an object is detected at the rear left of the vehicle, a sound is heard from the rear left speaker.

The shorter the distance to the object, the shorter the intervals of the intermittent tones.

When the distance to a detected object is less than approx. 8 in/20 cm, a continuous tone is sounded.

When there are objects in front of and behind the vehicle at the same time, at a distance smaller than approx. 8 in/20 cm, an alternating continuous tone will sound between the front and rear speakers.

The intermittent tones and the continuous tone are turned off when selector lever position P is engaged.

Depending on national-market version, the intermittent tones are switched off after a short time when the vehicle is stationary.

If an object approaches when the vehicle is stationary, the acoustic signal is reactivated.

Adjusting the volume

The volume of the acoustic warning can be adjusted.

1.  Apps menu
2. "Vehicle"
3. "Driving settings"

4. "Driver Assistance"
5. "Parking"
6. "PDC signal volume"
7. Set the desired value.

Turning off the acoustic warning

Depending on the national-market version, the acoustic warning can be switched off after the start of the parking manoeuver.

Press , the icon in the status field at the top of the control display.

No audible warning is emitted during active parking.

When the Park Distance Control is switched on again, the acoustic warning is automatically switched on again.

Visual warning

General information

The approach to an object is displayed on the control display and in the instrument cluster as soon as the system is activated.

Objects that are farther away are already displayed before a signal sounds.

Depending on the view, pathway lines, turning circle lines and obstacle markings are shown for a better estimation of the space required.

Depending on the equipment, the detection range of the sensors is represented by shaded annular surfaces. Green, yellow, and red markings indicate when obstacles are detected in the detection zone.

If vehicle is equipped with Cross Traffic Warning: A warning is also shown on the display for vehicles approaching from the side at the rear and front.

To protect the sides of the vehicle, obstacle markings are displayed on the sides of the vehicle.

Display

Depending on vehicle equipment, warnings may be displayed in front of, next to, and behind the vehicle.

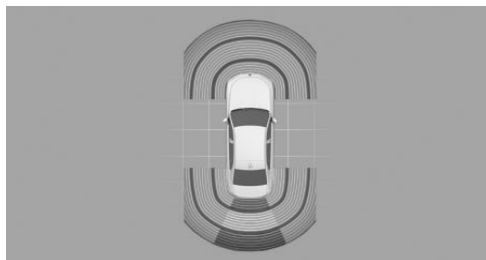

View behind vehicle.

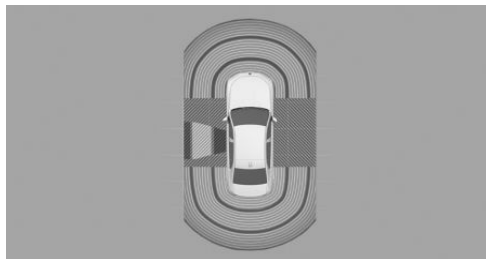

View next to vehicle.

- ▶ Shaded area: detection range of sensors.
- ▶ Gray shaded area: no obstacles were detected in the detection range.
- ▶ Colored marks in shaded area: obstacles were detected in the detection range.
- ▶ Shaded area interrupted: the area next to the vehicle has not yet been detected.

System limits

General information

The function for protecting the vehicle sides only shows stationary obstacles that were previously detected by the sensors when passing by.

The system does not detect whether an obstacle moves later on. When the vehicle is station-

ary, the gray shaded areas on the sides are hidden after a certain time. The area on the side of the vehicle must be newly captured. Also follow the information on system limits in the "Parking assistance systems" chapter.

Unwarranted warnings

Reaching the system limits can cause unwarranted warnings.

To prevent unwarranted warnings, for instance in car washes, turn off automatic Park Distance Control activation on obstacle detection.

Malfunction



An icon is displayed on the control display.

Depending on the vehicle equipment: the detection range of the sensors is not displayed on the control display.

A Check Control message is displayed.

Park Distance Control malfunction. Have the vehicle checked by an authorized service center or another qualified service center or repair shop.

Active Park Distance Control

Principle

The Park Distance Control brake function initiates emergency braking if there is an acute risk of collision.

General information

Due to system limits, a collision cannot be prevented under all circumstances.

The function is available below walking speed when driving in reverse or rolling backward.

Pressing the accelerator pedal interrupts the brake intervention. Emergency braking is not performed.

After emergency braking to a stop, further creeping toward an obstacle is possible. Proceed with caution. To move forward, lightly press the accelerator pedal and release as needed.

If the accelerator pedal is depressed longer, the vehicle drives off. Manual braking is possible at any time.

Follow the information in the "Parking assistance systems" chapter.

Safety information

Warning

The system cannot serve as a substitute for the driver's personal judgment in assessing the traffic situation. Based on the limits of the system, it cannot independently react to all traffic situations. There is a risk of accident. Adjust driving style to traffic conditions. Watch the surrounding traffic situation closely, be ready to take over steering and braking at any time, and actively intervene where appropriate.

Sensors

The system is controlled by the following sensors:

- ▶ Ultrasonic sensors in the rear bumpers.
- ▶ Ultrasonic sensors, side.

Deactivating Active Park Distance Control temporarily

After emergency braking, the function can be temporarily deactivated on the control display.

1. "Obstacle detected. Emergency braking."
2. "Deactivate temporarily"

During continued driving in this surrounding situation, no further emergency braking will occur.



The function is automatically reactivated when Park Distance Control is switched on again.

Settings

It is possible to set which areas on the vehicle will be protected by the system.

1. Apps menu
2. "Vehicle"
3. "Driving settings"
4. "Driver Assistance"
5. "Parking"
6. "Active PDC emergency braking"
7. Select the desired setting.

Display



As soon as the system engages, an icon is displayed with a corresponding message.

System limits

General information

Follow the system limits in the "Parking assistance systems" chapter.

Drive-off monitoring

Principle

In case of a risk of collision, the start-up monitoring reduces the drive power when driving off.

General information

When obstacles are detected in close range in front of the vehicle, the acceleration will be reduced. If necessary, this permits timely manual braking.

When obstacles are detected behind the vehicle, the system will brake.

Follow the information in the "Parking assistance systems" chapter.

Safety information

Warning

The system cannot serve as a substitute for the driver's personal judgment in assessing the traffic situation. Based on the limits of the system, it cannot independently react to all traffic situations. There is a risk of accident. Adjust driving style to traffic conditions. Watch the surrounding traffic situation closely, be ready to take over steering and braking at any time, and actively intervene where appropriate.

Sensors

The system is controlled by the following sensors:

- ▶ Ultrasonic sensors in the front/rear bumpers.
- ▶ Ultrasonic sensors, side.

Functional requirements

- ▶ Selector lever position D or R is engaged when the vehicle is stationary.
- ▶ Obstacles in the immediate vicinity are detected in front of or behind the vehicle.
- ▶ The accelerator pedal is heavily applied, nearly to the end point.
- ▶ The accelerator pedal is immediately applied after engaging the selector lever position and obstacle detection.

Turning drive-off monitoring on/off

1. Apps menu
2. "Vehicle"
3. "Driving settings"
4. "Driver Assistance"

5. "Parking"
6. "Drive off monitoring"
7. "Drive off monitoring"

A Check Control message is displayed where applicable.

Depending on the national-market version, the system is automatically turned on again at the next drive.

Canceling reduced drive power

The reduction of the drive power is canceled in the following situations:

- ▶ The accelerator pedal is released.
- ▶ After the accelerator pedal has been depressed completely twice.
- ▶ A specific distance has been traveled.

If the reduction in drive power is canceled by covering a certain distance, the drive power is released gradually.

Display



As soon as the system engages, an icon is displayed with a corresponding message.

System limits

General information

Follow the system limits in the "Parking assistance systems" chapter.

Automatic Parking Assistant

Principle

Automatic Parking Assistant provides support when parallel parking and parking transverse to the road.

In addition, the system makes it easier to park out of parallel and perpendicular parking spaces.

The ultrasonic sensors measure both sides of the vehicle when driving slowly forward. Suitable parking spaces are calculated based on the objects detected, e.g., parking vehicles. The system status is displayed.

The system calculates the best possible parking line for driving in or out of parking spaces, and takes control of the vehicle while parking.

The operating principle and operation of the system is divided into the following steps:

- ▶ Parking space search.
- ▶ Turning on.
- ▶ Parking.
- ▶ Driving out of parking spaces.

The parking manoeuvre during parking is performed automatically.

When driving out of parallel parking spaces, the vehicle maneuvers automatically until it reaches a position where it can be driven out of the parking space without further steering movements.

When driving out of perpendicular parking spaces, the vehicle is maneuvered out of the parking space to enable continued driving in the desired direction.

The Automatic Parking Assistant Professional increases the comfort and range of uses of the Automatic Parking Assistant. In addition to the parking methods of the Automatic Parking Assistant, parking in parking spaces that are marked with lines is possible.

With Park Assist Professional, you can use Remote Control Parking on your smartphone to park the vehicle.

Vehicle features and options

This system may not be available in the owned vehicle, e.g. due to the selected optional equipment, the national-market version or the option for later enabling and software updates. This also applies to individual functions of the system.

For information on whether a function is currently available in the vehicle or when the function can be installed in the vehicle, contact an authorized service center or another qualified service center.

Additional information:

Vehicle equipment, refer to page 8.

General information

Follow the information in the "Parking assistance systems" chapter.

Safety information

Warning

The system cannot serve as a substitute for the driver's personal judgment in assessing the traffic situation. Based on the limits of the system, it cannot independently react to all traffic situations. There is a risk of accident. Adjust driving style to traffic conditions. Watch the surrounding traffic situation closely, be ready to take over steering and braking at any time, and actively intervene where appropriate.

Warning

The system can steer the vehicle over or onto curbs. There is a risk of injury or risk of damage to property. Watch surrounding traffic closely and actively intervene where appropriate.

Parking methods

Park Assist supports the following functions:

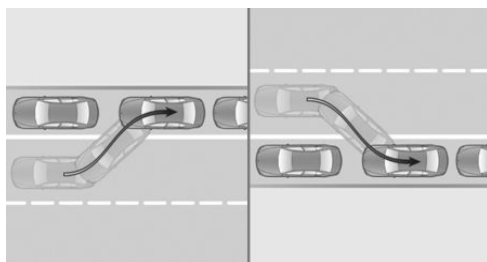

Parallel parking: reverse parking parallel to the road.

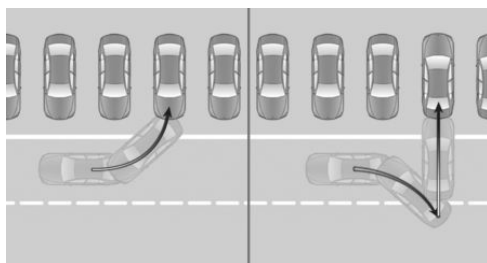

Perpendicular parking: reverse or forward parking perpendicular to the road.

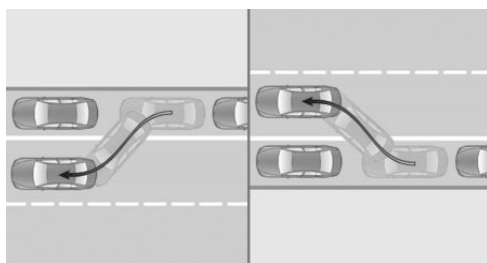

Driving out of parallel parking spaces.

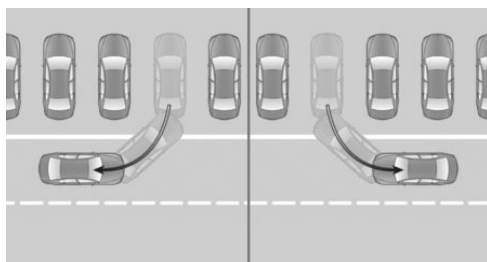

Driving out of perpendicular parking spaces.

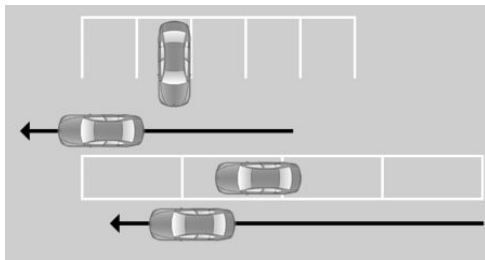

Park Assist Professional: Parking in parking spaces with parking lines.

Sensors

The Automatic Parking Assistant is controlled by the following sensors:

- ▷ Ultrasonic sensors in the front/rear bumpers.
- ▷ Ultrasonic sensors, side.

The Automatic Parking Assistant Professional is additionally controlled by the following cameras:

- ▷ Front camera.
- ▷ Exterior mirror camera.
- ▷ Rearview camera.

Functional requirements

Measurement of parking spaces

- ▷ Maximum speed while driving forward approx. 22 mph/35 km/h.
- ▷ Maximum distance to row of parked vehicles: 5 ft/1.5 m.

Suitable parking space

Longitudinal parking:

- ▷ Minimum length of a detected object, e.g., a parking vehicle: approx. 3 ft/1 m.
- ▷ Minimum length of gap between two objects: own vehicle length plus approx. 2.6 ft/0.8 m.
- ▷ Minimum depth: approx. 5 ft/1.5 m.

Perpendicular parking:

- ▷ Minimum length of a detected object, e.g., a parking vehicle: approx. 3 ft/1 m.
- ▷ Minimum width of the gap: own vehicle width plus approx. 2.3 ft/0.7 m.
- ▷ Minimum depth: own vehicle length.

The depth of perpendicular parking spaces must be estimated by the driver. Due to technical limitations, the system is only able to approximate the depth of perpendicular parking spaces.

Parking lines for Park Assist Professional:

The parking space must be clearly marked with lines.

Parking operation

- ▷ Doors and cargo area are closed.
- ▷ Driver's seat belt is fastened.

Leaving parking spaces

- ▷ The vehicle was parked using the Automatic Parking Assistant, and an object has been detected in the area around the vehicle.
- ▷ The vehicle was manually parked in reverse, and objects have been detected in the immediate vicinity of the vehicle. The distance to a detected curb is at least 6 inches/15 cm.
- ▷ The parking space is at least 2.6 ft/0.8 m longer than the vehicle.

Displays

General information

The current status of the parking assistance systems is shown in the right-hand toolbar, in the instrument cluster and, depending on the equipment, in the Head-up display.

Different icons are shown on the control display for selecting the parking method.

The sequence of the displayed icons corresponds to the prioritized parking option.

The direction of the arrow changes for the icons for parking methods for driving out of a parking space.

Icon	Meaning
	Reverse lengthwise parking, right.
	Reverse lengthwise parking, left.
	Reverse perpendicular parking.
	Forward perpendicular parking.

Turning parking operation display on/off

When the Automatic Parking Assistant is active, the parking operation is displayed in the camera image on the control display.

1. Apps menu
2. "Vehicle"
3. "Driving settings"
4. "Driver Assistance"
5. "Parking"
6. "Show assistance info"

Turning the signal tone on/off

The signal tone for suitable parking spaces can be turned on and off.

1. Apps menu
2. "Vehicle"
3. "Driving settings"
4. "Driver Assistance"
5. "Parking"
6. "Sound when available"

Parking using the Automatic Parking Assistant

1. For the parking space search when driving past parked vehicles at a speed of up to

approx. 22 mph/35 km/h and a distance of max. 5 ft/1.5 m.

The parking space search is activated.

2. Press the button or engage reverse gear.

The parking assistance systems view is displayed.

The status of the parking space search and possible parking spaces are displayed on the control display and in the instrument cluster.

3. On the control display: Select one of the parking maneuvers offered. You can switch to another parking maneuver as necessary.

In the instrument cluster: select suggested parking method with the thumbwheel on the steering wheel.

Green: the system takes control of the parking operation.

4. Follow the instructions on the control display or in the instrument cluster.

The speed can be reduced with the brake. Other interventions will cancel the system.

Depending on national-market version, an intermittent or continuous tone sounds for Park Distance Control.

At the end of the parking operation, selector lever position P is set.

The end of the parking operation is indicated on the control display and in the instrument cluster.

5. Adjust the parking position yourself, if needed.

Driving out of a parking space using the Automatic Parking Assistant

1. Turn on drive-ready state.

2. With the vehicle at a standstill, press button or engage reverse gear.

The parking assistance systems view is displayed.

3. On the control display: select the desired parking method.

In the instrument cluster: select suggested parking method with the thumbwheel on the steering wheel.

4. Follow the instructions on the control display or in the instrument cluster.

 Green: the system takes control of maneuvering.

The speed can be reduced with the brake. Other interventions will cancel the system. A message will be displayed at the end of the maneuver.

5. Make sure that the traffic situation permits driving out of parking space and driving off as usual.

The Automatic Parking Assistant is turned off automatically.

Canceling Automatic Parking Assistant manually

The Automatic Parking Assistant can be canceled manually at any time, e.g.:

- ▷ Step lightly on the accelerator pedal twice in succession.
- ▷ Step lightly on the accelerator pedal and move the steering wheel slightly at the same time.
- ▷ Depress the brake pedal and operate the selector lever at the same time.

The Automatic Parking Assistant is canceled without engaging selector lever position P. Driving can continue immediately.

Canceling Automatic Parking Assistant automatically

The system automatically cancels in situations such as the following:

- ▷ When the driver grasps the steering wheel or takes over steering.
- ▷ When operating the accelerator pedal or the selector lever.
- ▷ When setting the parking brake.
- ▷ When unfastening the driver's seat belt.
- ▷ With open cargo area.
- ▷ With open hood.
- ▷ With the doors open.
- ▷ During activation or intervention by driver assistance systems.
- ▷ When changing over to another function on the control display.
- ▷ When the view on the control display is overlaid with messages.
- ▷ On snow-covered or slippery road.
- ▷ On steep uphill or downhill grades.
- ▷ When there are obstacles that are hard to overcome such as curbs.
- ▷ When there are obstacles that suddenly appear.
- ▷ With insufficient distances, which are indicated by Park Distance Control.
- ▷ When a maximum number of parking attempts or the time taken for parking is exceeded.

When the system is automatically aborted, selector lever position P is engaged.

A Check Control message is displayed where applicable.

Continuing the parking operation

If parking or leaving a parking space has been interrupted, the operation can be continued, if needed.

Turn the Automatic Parking Assistant on again and follow the instructions on the control display or in the instrument cluster.

System limits

General information

Follow the system limits in the "Parking assistance systems" chapter.

No parking assistance

The Automatic Parking Assistant does not offer assistance in the following situations:

- ▷ In tight curves.
- ▷ For diagonal parking spaces.
- ▷ Automatic Parking Assistant: for parking spaces that are only marked with lines on the ground. The system orients itself according to objects.
- ▷ For special parking spaces, e.g., metered parking spaces with automatic locking mechanisms, or mechanical parking systems.

Functional limitations

The system may be limited in the following situations:

- ▷ On bumpy road surfaces such as gravel roads.
- ▷ On slippery ground.
- ▷ On steep uphill or downhill grades.
- ▷ With accumulations of leaves/snow in the parking space.
- ▷ In case of changes to an already-measured parking space.
- ▷ With ditches or edges, for instance an edge of a port.
- ▷ Parking spaces that are not suitable may be detected or suitable parking spaces may not be detected at all.

Malfunction

A Check Control message is displayed.

The Automatic Parking Assistant has malfunctioned. Have the vehicle checked by an author-

ized service center or another qualified service center or repair shop.

Maneuver Assistant

Principle

The Maneuver Assistant provides support for recurring parking and maneuvering situations.

Parking and maneuvering operations can be recorded and then carried out automatically by the system.

Vehicle features and options

This system may not be available in the owned vehicle, e.g. due to the selected optional equipment, the national-market version or the option for later enabling and software updates. This also applies to individual functions of the system.

For information on whether a function is currently available in the vehicle or when the function can be installed in the vehicle, contact an authorized service center or another qualified service center.

Additional information:

Vehicle equipment, refer to page 8.

General information

A recurring maneuver is driven manually and thereby recorded.

When the vehicle reaches the activation area for the distance covered by the stored maneuver, the maneuver can be activated on the control display or in the instrument cluster.

After the activation, the system takes control of the vehicle and carries out the maneuver automatically.

Use Remote Control Parking on a smartphone to perform the parking maneuver.

Follow the information in the "Parking assistance systems" chapter.

Safety information

Warning

The system cannot serve as a substitute for the driver's personal judgment in assessing the traffic situation. Based on the limits of the system, it cannot independently react to all traffic situations. There is a risk of accident. Adjust driving style to traffic conditions. Watch the surrounding traffic situation closely, be ready to take over steering and braking at any time, and actively intervene where appropriate.

Warning

The system can steer the vehicle over or onto curbs. There is a risk of injury or risk of damage to property. Watch surrounding traffic closely and actively intervene where appropriate.

Detection range

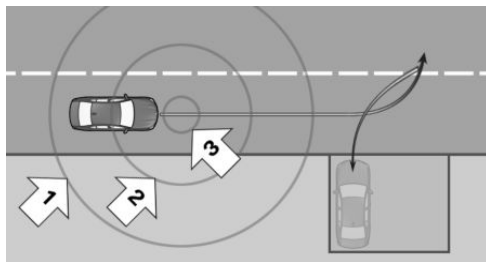

The detection range for a maneuver is divided into the following areas:

- ▷ Proximity range, arrow 1: the system will begin with the localization in the background within a range of approx. 26 ft/8 m around the distance covered of a stored maneuver.
- ▷  Close range, arrow 2: in a range of approx. 6 ft/2 m around the distance covered,

a stored maneuver can be displayed on the control display.

- ▷  Activation range, arrow 3: the stored maneuver on the control display can be activated within a range of approx. 3.5 ft/1 m. After the activation, the system takes control of the vehicle and carries out the maneuver automatically.

Sensors

The system is controlled by the following sensors and cameras:

- ▷ Ultrasonic sensors in the front/rear bumpers.
- ▷ Ultrasonic sensors, side.
- ▷ Front camera.
- ▷ Top view cameras.
- ▷ Rearview camera.

Recording maneuver

General information

Up to ten maneuvers can be recorded at different locations.

Up to four overlapping maneuvers can be recorded.

Identical maneuvers under different ambient conditions can be recorded such as light conditions.

For each maneuver, a maximum distance covered of 656 ft/200 m is possible.

In total, a distance covered of approx. 1,969 ft/600 m distributed to the ten possible maneuvers can be recorded.

Maneuvers with a distance covered of less than 20 ft/6 m cannot be recorded.

Recording maneuver

1. Drive the vehicle to the starting point from which a maneuver must be recorded and stop.



2. Press the button.

The parking assistance systems view is displayed.

3.  "Record new path"

4. Drive the vehicle to the desired end position.



The maneuver is recorded.

When recording a route, do not drive faster than 9 mph/15 km/h.

While recording, the distance covered will be displayed.

When the maximum distance covered or the maximum speed is reached, a message will be displayed and a signal tone will sound.

5. With a stationary vehicle: "Save recording"

6. "Name:"

If necessary, enter the desired name for the recorded maneuver.

7. "Save recording"

Do not move the vehicle until the recording has been stored.

Performing stored maneuver

1. Drive the vehicle into the activation range and stop. The control display and instrument cluster indicate that a stored maneuver can be activated.

2.  ^P : activate stored maneuver.

 Green: after activation, the system takes control of the vehicle and performs the maneuver automatically. If applicable, follow the instructions on the control display or in the instrument cluster.

The speed can be reduced with the brake. Other interventions will cancel the system.

At the end of the parking operation, selector lever position P is set.

Canceling the Maneuver Assistant manually

The vehicle can be controlled manually during an active maneuver by taking the following actions:

- ▶ Step lightly on the accelerator pedal twice in succession.
- ▶ Step lightly on the accelerator pedal and move the steering wheel slightly at the same time.
- ▶ Depress the brake pedal and operate the selector lever at the same time.

The Maneuver Assistant is canceled without engaging selector lever position P. Driving can continue immediately.

Canceling the Maneuver Assistant automatically

The system automatically cancels in situations such as the following:

- ▶ When the driver grasps the steering wheel or takes over steering.
- ▶ When operating the accelerator pedal or the selector lever.
- ▶ When the driver's seat belt is not fastened.
- ▶ With open cargo area.
- ▶ With open hood.
- ▶ With the doors open.
- ▶ During activation or intervention by driver assistance systems.
- ▶ When the system limits of the ultrasonic sensors and cameras are reached.
- ▶ When changing over to another function on the control display.
- ▶ When the view on the control display is overlaid with messages.
- ▶ In case of obstacles.

- ▷ On snow-covered or slippery road.
- ▷ When the lane is too narrow.
- ▷ On steep uphill or downhill grades.

In the event of an automatic cancellation of the system, the vehicle is decelerated to a complete stop and selector lever position P is engaged.

An interrupted maneuver can be continued, if needed. Turn the Maneuver Assistant on again and follow the instructions on the control display or in the instrument cluster.

Editing stored maneuvers

Individual or all maneuvers can be deleted or renamed.

1.  Apps menu
2. "Vehicle"
3. "Driving settings"
4. "Driver Assistance"
5. "Parking"
6. "Recorded paths"
7. Select the desired setting.

System limits

General information

Follow the system limits in the "Parking assistance systems" chapter.

Functional limitations

System limits can cause functional limitations such as in the following situations:

- ▷ With poor GPS reception.
- ▷ On steep uphill or downhill grades.
- ▷ In case of recorded maneuvers where the system minimum distance to objects cannot be maintained.
- ▷ Greatly deviating conditions when storing and driving the distance covered, for in-

stance other tires or changed ambient conditions like light conditions or weather.

- ▷ Delayed display of overlapping stored maneuvers when driving into the activation area.
- ▷ In multi-story parking garages, for recordings at different parking levels, or for recordings that run over several parking levels.

Remote Control Parking

Principle

With Remote Control Parking, the vehicle can be driven remotely when parking and maneuvering using the Maneuver Assistant and Park Assist Professional.

The maneuver is performed independently, outside the vehicle, using a smartphone. This makes it easy to get in and out of the vehicle.

When parking in a suitable spot, e.g., a garage, you can correct the parking position with Remote Control Parking by maneuvering slightly.

A maneuver that has already been started can be continued at any time with Remote Control Parking.

Vehicle features and options

This system may not be available in the owned vehicle, e.g. due to the selected optional equipment, the national-market version or the option for later enabling and software updates. This also applies to individual functions of the system.

For information on whether a function is currently available in the vehicle or when the function can be installed in the vehicle, contact an authorized service center or another qualified service center.

Additional information:

Vehicle equipment, refer to page 8.

General information

Note the information in the Automatic Parking Assistant and Maneuver Assistant chapter.

Protect the smartphone against unauthorized use.

The low-beam headlights are switched on for the duration of the maneuver.

A parking maneuver offered by Park Assist Professional is only available for Remote Control Parking for a short time after exiting the vehicle.

Functional requirements

- ▶ All occupants have left the vehicle.
- ▶ Doors and cargo area are closed.
- ▶ The smartphone is compatible with Remote Control Parking.
- ▶ The My BMW App must be installed on a compatible smartphone.
- ▶ The My BMW App must be linked to a ConnectedDrive account.
- ▶ Bluetooth must be enabled on the smartphone.
- ▶ The distance between vehicle and smartphone is no greater than approx. 19 ft/6 m.
- ▶ A valid digital key must be set up for the vehicle.

Additional information:

BMW Digital Key, refer to page 90.

Parking with Remote Control Parking

1. Engage selector lever position P.
2. Leave the vehicle and close the doors and trunk.
3. Open Remote Control Parking in the My BMW app and maneuver forward or backward, or select the desired parking method.
4. Follow the instructions on the smartphone.

Stop the vehicle manually if obstacles are present.

Depending on the option selected in the My BMW app, the vehicle is either parked at the end of the parking maneuver or you can take control of the vehicle again.

System limits

Due to ambient conditions, e.g., impaired Bluetooth connection transmission due to external faults, Remote Control Parking may be interrupted.

If the power supply of the vehicle battery is not sufficiently ensured, e.g., due to excessive discharge, Remote Control Parking may not be available. Follow the instructions in the My BMW App.

Back-up assistant

Principle

The Back-up Assistant helps when reversing, e.g., when pulling out of tight or unclear parking or road situations.

Vehicle features and options

This system may not be available in the owned vehicle, e.g. due to the selected optional equipment, the national-market version or the option for later enabling and software updates. This also applies to individual functions of the system.

For information on whether a function is currently available in the vehicle or when the function can be installed in the vehicle, contact an authorized service center or another qualified service center.

Additional information:

Vehicle equipment, refer to page 8.

General information

The vehicle stores the driving movements of the last distance covered. This stored distance can be driven in reverse with automated steering.

The system takes over the steering. The driver must control the speed using the accelerator and brake pedals.

Back-up Assistant: a maximum of 164 ft/50 m are stored.

Back-up Assistant Professional: a maximum of 656 ft/200 m are stored.

Follow the information in the "Parking assistance systems" chapter.

Safety information

Warning

The system cannot serve as a substitute for the driver's personal judgment in assessing the traffic situation. Based on the limits of the system, it cannot independently react to all traffic situations. There is a risk of accident. Adjust driving style to traffic conditions. Watch the surrounding traffic situation closely, be ready to take over steering and braking at any time, and actively intervene where appropriate.

Warning

The system can steer the vehicle over or onto curbs. There is a risk of injury or risk of damage to property. Watch surrounding traffic closely and actively intervene where appropriate.

Functional requirements

- ▶ Drive forward without interruption to store the distance covered.
- ▶ To store the distance covered, do not drive faster than 22 mph/35 km/h.
- ▶ Back-up Assistant Professional: sufficiently bright light conditions on the saved route.
- ▶ Back-up Assistant Professional: the cameras on the vehicle must be clean and clear.

Driving in reverse with automated steering

1. Turn on drive-ready state.



2.  With the vehicle at a standstill, press button or engage reverse gear.

The parking assistance systems view is displayed.

3.  "Start back-up Assistant"

The length of the distance covered is displayed on the control display and in the instrument cluster.

If applicable, follow the instructions on the control display or in the instrument cluster.

4. Take your hands off the steering wheel and carefully drive in reverse with the accelerator pedal and the brake.

 Green: the system takes control of steering.

When driving in reverse, observe the vehicle's surroundings.

In case of obstacles, stop immediately and take over control of the vehicle. Follow the instructions for Park Distance Control.

5. Right before the end of the stored distance covered, a signal tone will sound and a message is displayed.

Stop no later than when normal road traffic is reached and take control of the vehicle such as by shifting to forward gear.



Canceling the Back-up Assistant manually

The assisted reversing by the Back-up Assistant can be canceled manually:

- ▷  "Cancel"
- ▷  Press the button.

Canceling the Back-up Assistant automatically

The system automatically cancels in situations such as the following:

- ▷ When the driver grasps the steering wheel or takes over steering.
- ▷ When shifting from reverse to another selector lever position.
- ▷ During activation or intervention by driver assistance systems.
- ▷ After an extended period of time when the vehicle is stationary.
- ▷ When exiting the stored lane when reversing, for instance with maximum steering-wheel angle.
- ▷ When the view on the control display is overlaid with messages.
- ▷ In case of a slippery surface.
- ▷ When the vehicle is rolling such as on a slope.
- ▷ In case of changed ambient conditions.
- ▷ If the vehicle speed exceeds approx. 6 mph/10 km/h.
- ▷ Reversing Assistant Professional: if sensor functionality is limited beyond approx. 164 ft/50 m.

System limits

- ▷ The maximum speed when reversing is limited to approx. 6 mph/10 km/h.
A warning is issued at a speed of approx. 4 mph/7 km/h.

If the maximum speed is exceeded, the function is interrupted.

Different influences can lead to side deviations when driving the stored distance covered in reverse. For example, this includes the following factors:

- ▷ Steering movements when the vehicle is stationary while storing the distance covered.
- ▷ The speed is not adapted to the distance covered.
- ▷ Certain road characteristics such as gradients, inclines or slippery road surface.
- ▷ Greatly deviating conditions when storing and driving the route, for instance other tires or changed ambient conditions like weather.
- ▷ Back-up Assistant Professional: for changed light conditions.

Also follow the information on system limits in the "Parking assistance systems" chapter.



Driving comfort

Vehicle features and options

This chapter describes model-specific equipment, systems, and functions that are currently available, or may become available in the future, even if they are not present in the vehicle.

Additional information:

Vehicle equipment, refer to page 8.

Executive Drive Pro

Executive Drive Pro is an actively controlled chassis. The system combines a high level of driving comfort with dynamic handling characteristics and minimizes roll tendency when cornering.

Executive Drive Pro consists of Active Roll Stabilization and Integral Active Steering.

Additional information:

Integral Active Steering, refer to page 215.

Active Roll Stabilization, refer to page 271.

Active roll stabilization

Active roll stabilization provides increased driving comfort, improves vehicle agility and vehicle stability. Among other things, the system enables a more dynamic response to steering movements and reduces the body's tendency to roll when cornering quickly or making quick evasive maneuvers. This means that, e.g., the lateral head movements of the occupants are reduced.

In addition, unevenness on one side of the road is largely compensated for and is barely perceptible to the occupants.

Two-axle ride level control

Principle

The two-axle self-leveling suspension uses air springs to ensure the best possible driving comfort. Regardless of the load, the vehicle will be maintained at the configured vehicle level.

General information

The shock absorbers can be set from comfortable to sporty via the My Modes drive modes.

Depending on the driving situation, the vehicle level can be set to different levels:

- ▶ Normal level: for normal road condition.
- ▶ Increased level: in the event of poor road conditions or unevenness.

Safety information

Warning

Adjusting the vehicle height may result in trapped body parts or damaged vehicle parts. There is a risk of injury or risk of damage to property. When adjusting the vehicle height, make sure that the areas of movement around the vehicle and at the wheel housing are free.

Overview

Button in vehicle

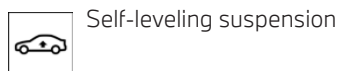
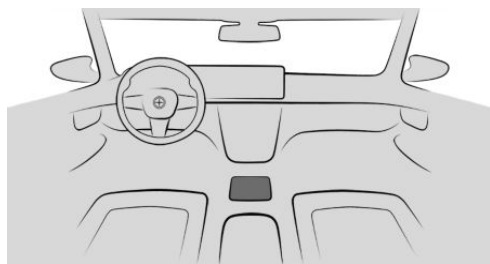

Functional requirement

All doors are closed.

Opening a door while raising or lowering the vehicle interrupts the process. The process continues after closing the door.

Activating/deactivating self-leveling suspension

The system can be deactivated, e.g., to change a wheel or for towing.

Deactivate system:

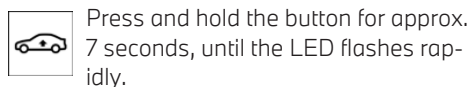

To activate system:

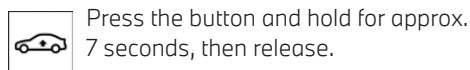

The self-leveling suspension is automatically activated after driving off at speeds above approx. 6 mph/10 km/h.

Setting the vehicle level manually



Depending on vehicle speed, using this button lifts the vehicle to the raised level.

LED display

- ▷ LED off: Normal vehicle level.
- ▷ LED flashes: Vehicle level is being adjusted.
- ▷ LED illuminates: Raised vehicle level.
- ▷ LED flashes rapidly: Vehicle level cannot be adjusted.

Setting the vehicle level automatically

The vehicle will lower automatically in the following situations:

- ▷ My Modes: "SPORT".
- ▷ At higher speeds.

When a set vehicle level is exited due to the speed, the vehicle level will be adjusted according to the selected driving mode.

Long stationary periods

During long stationary periods, the vehicle may lower itself. This is not a malfunction.

When the drive-ready state is switched on with the doors closed, the vehicle is raised to the normal level automatically.

Depending on the condition of the vehicle, raising to normal level may take several minutes.

System limits

- ▷ It may not possible to change the vehicle level during sporty driving.
- ▷ It may not be possible to change the vehicle level with articulated axles.
- ▷ It may only be possible to raise the vehicle level in the drive-ready state.
- ▷ If the vehicle battery charge is too low, the vehicle level cannot be changed.
- ▷ If the vehicle level is frequently changed in quick succession, the system switches off

to prevent overheating and will be temporarily unavailable or operate at a delay. Let the system cool down, if needed.

- ▶ If the payload is increased, the highest driving level may be disabled or automatically exited in order to protect the system.

Malfunction

A Check Control message is displayed.

In case of a malfunction, the vehicle will have changed handling characteristics or a noticeably reduced driving comfort.

Have the vehicle checked by an authorized service center or another qualified service center or repair shop.

BMW IconicSounds

Depending on vehicle equipment and national-market version, the vehicle drive sound can be adjusted using BMW IconicSounds.

1.  Apps menu
2. "Vehicle"
3. "Driving settings"
4. "Drivetrain and chassis"
5. "IconicSounds"
6. Select the desired setting.

Climate control

Vehicle features and options

This chapter describes model-specific equipment, systems, and functions that are currently available, or may become available in the future, even if they are not present in the vehicle.







Additional information:







Vehicle equipment, refer to page 8.

Climate control

Overview



Functions in the Climate menu

Icon	Function
	Turn the climate control system on/off.
	Automatic program.
	Temperature.
	Air conditioning.
	Maximum cooling.
	Air recirculation mode.
	Automatic recirculated-air control.

Icon	Function
	Fresh air.
	Air flow.
	Air distribution.
	SYNC program.
	Seat heating. Panel heating.
	Seat cooling.
	Steering wheel heating

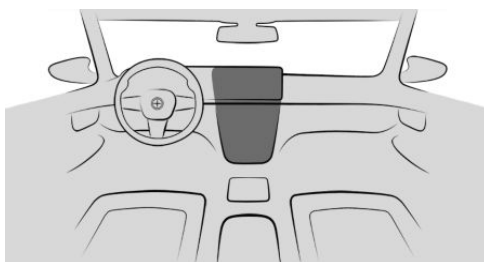





Buttons, automatic climate control



Icon	Function
	Defrost function.
	Rear window defroster.

Rear automatic climate control



Icon	Function
	Turning the rear automatic climate control on/off.
	Automatic program.
	Temperature.
	Air flow.
	Air distribution.
	Seat heating. Panel heating.
	Seat cooling.

Calling up climate control functions

The Climate menu can be accessed via iDrive:



-  Tap the icon for the Climate menu on the menu bar.

Or:

-  Apps menu
- "Vehicle"
- "Climate control"

Turning the air conditioning system on/off

The climate control system can be turned on or off via iDrive.

-  Tap the icon for the Climate menu on the menu bar.
-  Tap the power button.

The entire climate control system is turned on or off with the last settings applied.

When the air conditioning system is turned on, individual climate control functions can be turned off.

Settings

You can configure individual settings for climate control functions via iDrive, e.g.:

- ▷ Intensity of seat heating.
- ▷ Pre-ventilation.

-  Tap the icon for the Climate menu on the menu bar.
- "Individual settings" or "General settings"
- Select the desired setting.

Turning rear automatic climate control on/off

Functional requirements

- ▷ Automatic climate control is turned on.
- ▷ Defrost function is deactivated.

Via iDrive



-  Tap the icon for the Climate menu on the menu bar.
- "Individual settings"
- "Second row of seats"

4. "Rear climate control"
5. Select the desired setting.

The rear automatic climate control can be activated with standard setting for temperature and AUTO program:

"Activate with default settings"

Via BMW Touch Command

1.  Tap on the icon.
2. Tap the climate bar on the touchscreen.
3.  Tap on the icon.
4. Select the desired setting.

Locking the rear automatic climate control



1. Tap the icon for the Climate menu on the menu bar.
2. "Individual settings"
3. "Second row of seats"
4. "Lock rear climate control"

Automatic program

Principle

The automatic program ensures a comfortable climate, which can be modified with the desired temperature and individual settings.

The automatic program cools, ventilates or heats the vehicle interior automatically.

General information

Depending on the equipment, the automatic program provides the best possible settings for climate control functions depending on the outside temperature, interior temperature, sunlight, seat occupancy and the desired temperature setting:

- ▷ Air flow.
- ▷ Air distribution.
- ▷ Temperature.
- ▷ Seat and panel heating.
- ▷ Seat cooling.
- ▷ Steering wheel heating

The automatic program takes seat occupancy into account, regulating the climate in an energy-efficient manner that is tailored to the occupants.

- ▷ If only the driver's seat is occupied, the temperature set on the driver's side is automatically applied to all other zones.
- ▷ If another seat is occupied, the temperature last set there is restored.

At the same time, a condensation sensor controls the automatic program in order to prevent window condensation to the extent possible.

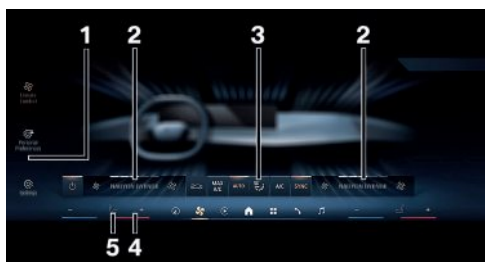

Overview



- 1 Settings
- 2 Air flow intensity
- 3 Climate control functions bar
- 4 Temperature
- 5 Seat heating
Steering wheel heating
Seat cooling

Turning the automatic program on/off

The AUTO program can be switched on or off via iDrive.

-  Tap the icon for the Climate menu on the menu bar.
-  Tap the AUTO program button.

Switching the rear climate control automatic program on/off

Via iDrive

-  Tap the icon for the Climate menu on the menu bar.
- "Individual settings"
- "Second row of seats"
- "Automatic climate"
- Select the desired setting.

Via BMW Touch Command

-  Tap on the icon.
- Tap the climate bar on the touchscreen.
- "AUTO"
- Select the desired setting.

Setting the intensity

When the automatic program is activated, the intensity of individual climate control functions, e.g., seat heating, is adjusted individually.

-  Tap the icon for the Climate menu on the menu bar.
- "Individual settings"
- Select the desired setting, e.g.:

- ▷ "LOW"
- ▷ "MEDIUM"
- ▷ "HIGH"

Each level has a specific control range of the intensity.

Based on the stored data models, the intensities are dynamically adjusted while driving. It is not necessary to manually change the desired intensity to lower or higher levels while driving.

The individually selected settings of the climate control functions are stored and automatically set up again such as after the vehicle is started again.

Display

The indicator on the menu bar provides information about the temperature difference between the configured desired temperature and current interior temperature.

- ▷ The red or blue bar next to the temperature display indicates the progress of heating or cooling.
- ▷ The desired interior temperature is reached as soon as the bar is no longer displayed.

Active climate control functions, e.g., seat heating, are indicated by the icons on the menu bar.

Temperature

Principle

The automatic climate control cools or heats to the configured temperature and then keeps the temperature constant.

General information

Do not rapidly switch between different temperature settings. Otherwise, the automatic climate control will not have sufficient time to adjust the set temperature.

Setting the temperature

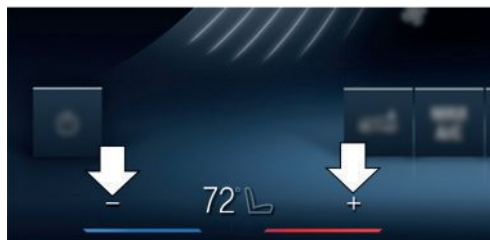

You can set the desired temperature for driver and front passenger individually on the menu bar.

- ▷ + Raise the temperature.
- ▷ — Lower temperature.

Setting the rear automatic climate control temperature

Via iDrive

1.  Tap the icon for the Climate menu on the menu bar.
2. "Individual settings"
3. "Second row of seats"
4. Set the desired temperature.

Via BMW Touch Command

The temperature can be set individually for the driver's and front passenger side in the air conditioning bar.

1.  Tap on the icon.
2. Set the desired temperature:
 - ▷ + Raise the temperature.
 - ▷ — Lower temperature.

Footwell temperature

General information

The air temperature in the footwell can be adjusted.

This does not change the set interior temperature for the driver and front passenger.

Adjusting the footwell temperature

1.  Tap the icon for the Climate menu on the menu bar.
2. "Individual settings"
3. "Driver" or "Front passenger"
4. "Temperature adjustment for footwell"
5. Increase or decrease temperature.

Air flow

General information

The air flow generated by the blower can be adjusted as needed.

Adjusting the air flow

The air flow can be set via iDrive.

1.  Tap the icon for the Climate menu on the menu bar.

The air flow may be reduced to preserve the vehicle battery.





Adjusting the air volume of the rear climate control

Via iDrive

1.  Tap the icon for the Climate menu on the menu bar.
2. "Individual settings"

3. "Second row of seats"
4. "Fan"
5. Select the desired setting.

Via BMW Touch Command

1.  Tap on the icon.
2. Tap the climate bar on the touchscreen.
3.  Tap on the icon.
4. Select desired setting, for example, "MEDIUM".
 - ▷  Increase air flow.
 - ▷  Reduce air flow.



Air distribution settings

Principle

The air distribution can be adjusted as required in manual mode.

Adjusting the air distribution

The air distribution can be set via iDrive:

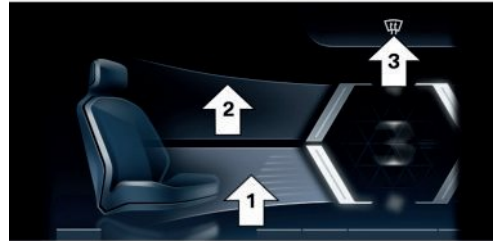

1.  Tap the icon for the Climate menu on the menu bar.
2.  Tap the air distribution icon on the climate control functions bar.
3. Select the desired setting:
 - ▷ Aim the air flow downward, arrow 1.
 - ▷ Aim the air flow upward, arrow 2.
 - ▷ Aim the air flow at the windshield , arrow 3.

The selected air distribution is displayed.



Adjusting the air distribution of the rear climate control

The function is operated via BMW Touch Command.

1.  Tap on the icon.
2. Tap the climate bar on the touchscreen.
3.  Tap on the icon.
4.  Air distribution.
5. Select the desired setting.

Air conditioning

Principle



With the climate control function, the air inside the vehicle is cooled and dehumidified, then warmed again depending on the temperature settings.

Functional requirement

Standby or drive-ready state is switched on.

Switching the cooling function on/off

The air conditioning can be switched on or off via iDrive:

1.  Tap the icon for the Climate menu on the menu bar.
2.  Tap the air conditioning button.

In recirculated-air mode, air conditioning is automatically switched on to dry the air and avoid window condensation.

Depending on the weather, the windshield and the side windows may fog up briefly when drive-ready state is switched on.

When using the cooling mode, condensation that will exit below the vehicle.

Maximum cooling

Principle

Maximum cooling lets you cool the vehicle interior quickly and effectively.

The lowest temperature and the maximum air flow are set automatically.



The function is automatically activated in the rear when the SYNC program is turned on.

Functional requirement

The function is available at an outside temperature above approx. 32 °F/0 °C and with the drive-ready state switched on.

Turning maximum cooling on/off

Maximum cooling can be turned on or off via iDrive:

1.  Tap the icon for the Climate menu on the menu bar.
2.  Tap the maximum cooling button.

Air flows out of the air vents to the upper body area. Open the vents.

Air recirculation mode

Principle

You may react to unpleasant odors or pollutants in the immediate environment by temporarily suspending the supply of outside air. The system then recirculates the interior air.

In automatic recirculated-air control mode, outside air is fed in or the interior air recirculated depending on the outside air quality.

When the air recirculation is turned off, outside air is directed into the interior.

General information

If there is window condensation, turn off the air recirculation.



The interior filter cleans the incoming fresh air or the circulated interior air in recirculation mode.

Turning air recirculation on/off

Air recirculation mode can be switched on or off via iDrive:

1.  Tap the icon for the Climate menu on the menu bar.
2. The current operating mode is displayed on the climate control functions bar. Tap the

button until the desired operating mode is set.

- ▶  Recirculating air.
- ▶  Fresh air.
- ▶  Automatic air recirculation.

In recirculated-air mode, air conditioning is automatically switched on to dry the air and avoid window condensation.

Depending on vehicle equipment, air recirculation will turn off automatically based on ambient conditions in order to prevent window condensation.

SYNC program

Principle

If SYNC program is activated, the settings on the driver's side are transferred to the passenger's side and to the rear.

If the SYNC program is deactivated, the following settings are made automatically in the automatic program depending on the seat occupancy:

- ▶ If the front passenger's seat is not occupied, the settings on the driver's side are applied.
- ▶ If the seats in the rear are unoccupied, the default settings are applied.



General information

The following settings can be transferred:

- ▶ Temperature.
- ▶ Air flow.
- ▶ Air distribution.
- ▶ Automatic program.

Turning the SYNC program on/off

The SYNC program can be switched on or off via iDrive:

1.  Tap the icon for the Climate menu on the menu bar.
2.  Tap the SYNC program button.

If the settings on the front passenger side or in the rear are changed, the program is automatically switched off.

Defrost function

Principle

With the defrost function, ice and condensation are quickly removed from the windshield and the front side windows.

The air flow and air temperature are automatically optimized for the removal of ice and condensation.

The air distribution is directed toward the windshield and front side windows.

If there is window condensation, turn on the automatic program to take advantage of the condensation sensor.

When the defrost function is turned on, the rear automatic climate control is deactivated to provide maximum performance.

Turning the defrost function on/off

 Press the defrost button on the instrument panel.

The LED of the button is illuminated when the system is switched on.

When the defrost function is turned on, the rear automatic climate control is deactivated to provide maximum performance.

Make sure that air is able to flow to the windshield and front side windows.

Rear window defroster

Principle

With the rear window defroster, ice and condensation are quickly removed from the rear window.

Functional requirement

Standby or drive-ready state is switched on.

Turning the rear window defroster on/off



Press the rear window heating button on the instrument panel.

The LED is illuminated with rear window defroster switched on.

The rear window defroster switches off automatically after a certain period of time.

Seat heating

Principle

The system heats seats and panels as needed.

General information

Seat heating can also be used without panel heating. Deactivate panel heating as necessary.

Adjusting seat heating

Automatic program

When the automatic program is activated, the intensity of seat heating can be adjusted: As you drive, the heater output is automatically adjusted according to your set intensity.

Adjusting seat heating manually

The heater output level can be adjusted manually:



1. Tap the icon for seat climate control on the menu bar, arrow 1.



2. Press the seat heating button repeatedly until the desired level is selected, arrow 2.

If a consumption-optimized drive mode is selected, the heater output is reduced.

Turning the rear automatic climate control seat heating on/off

The function is operated via BMW Touch Command.

1. "Seats"
2. "Seat climate control"
3. Select desired seat.
4. Tap on the icon.
5. Select the desired setting.

Seat cooling

Principle

The system cools the seat and backrest surfaces as necessary, ensuring a pleasant seat temperature.

Adjusting the seat cooling

Automatic program

When the AUTO program is on, the intensity of seat cooling can be adjusted. As you drive, the cooling power is automatically adjusted to the set intensity.

Adjusting the seat cooling manually

The cooling level can be adjusted manually:



1. Tap the icon for seat climate control on the menu bar, arrow 1.

2.  Press the seat cooling button repeatedly until the desired level is selected, arrow 2.

Turning the rear automatic climate control seat cooling on/off

1. "Seats"
2. "Seat climate control"
3. Select desired seat.
4.  Tap on the icon.
5. Select the desired setting.

Steering wheel heating

Principle

The system heats the steering wheel as necessary.

Adjusting steering wheel heating

Automatic program

When the automatic program is activated, the intensity of steering wheel heating can be adjusted. As you drive, the heater output is automatically adjusted according to your set intensity.

Adjusting steering wheel heating manually

The heater output level can be adjusted manually:



1. Tap the icon for seat climate control on the menu bar, arrow 1.

2.  Press the steering wheel heating button repeatedly until the desired level is selected, arrow 2.

If a consumption-optimized drive mode is selected, the heater output is reduced.

Panel heating

Principle

The interior is quickly and energy efficiently heated with radiant heat.

General information

The elements of the panel heating are integrated in the doors, the glove compartment

lid and in the lower area of the instrument panel.

The heat is supplied without direct contact to the heated surface.

The set desired temperature heats the surfaces more or less.

Switching panel heating on/off

The panel heating can be switched on or off in addition to the seat heating.



1. Tap the icon for the Climate menu on the menu bar.
2. "Individual settings"
3. Select desired seat.
4. Select the desired setting.

Setting the panel heating



1. Tap the icon for the Climate menu on the menu bar.
2. Tap the seat climate control icon on the menu bar.
3. Press the seat heating button repeatedly until the desired level is selected.

Adjusting the rear climate control panel heating

The function is operated via BMW Touch Command.

1. "Seats"
2. "Seat climate control"
3. Select desired seat.
4. Select the desired function.
5. Select the desired setting.

Ventilation

Principle

The ventilation system offers individual ranges of adjustment for direct or indirect ventilation to optimize the air flows in the vehicle.

General information

Open the air vents and position them to ensure effective climate control.

The air flow heats or cools noticeably, depending on the set desired temperature.

Front ventilation



- ▷ Change the air flow direction, arrow 1.
- ▷ Adjustment of the air volume at the vent, arrow 2.

Ventilation in the rear



- ▷ Change the air flow direction, arrow 1.
- ▷ Thumbwheel for variable opening and closing of the air vents, arrow 2.

Ventilation in the rear, on the side

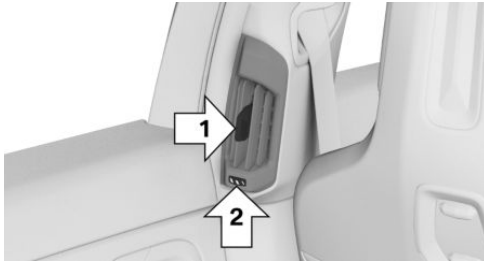

- ▶ Lever for changing the airflow direction, arrow 1.
- ▶ Thumbwheel for variable opening and closing of the air vents, arrow 2.

Setting the ventilation

Depending on the desired ventilation, align the air flow directly or indirectly toward the passengers.

Air quality

General information

The air quality in the interior is improved by the following components:

- ▶ Emission tested passenger compartment.
- ▶ Interior filter.
- ▶ Air conditioning system to control the temperature, air flow and recirculated-air mode.
- ▶ Pre-ventilation.

Interior filter

The interior filter cleans the incoming fresh air or the circulated interior air in recirculation mode.

Depending on the equipment:

- ▶ Dust and pollen is filtered out from the incoming air.
- ▶ Nano-particle emissions are reduced.

- ▶ Gaseous pollutants are filtered.
- ▶ Microbial particles, viruses and allergens are filtered.

The manufacturer of the vehicle recommends having the interior filter changed during vehicle maintenance.

Pre-ventilation

Principle

The car's interior can be cooled or heated before driving off with the pre-ventilation. Depending on set temperature and ambient temperature, the car's interior is ventilated or possibly heated using the residual engine heat.

General information

The system can be switched on and off directly or via a preset departure time.

The activation time is determined based on the outside temperature. The system promptly switches on before the selected departure time.

The system switches off automatically after a certain period of time. The system continues to run for some time after being switched off.

Functional requirements

- ▶ The vehicle is in idle state or standby state.
- ▶ The vehicle battery is sufficiently charged.

If pre-ventilation is switched on, the vehicle battery will be discharged. Thus, limit the maximum activation time to save the vehicle battery. The system will be available again after the engine is started or after a short trip.

- ▶ Time and date are set correctly.
- ▶ The ventilation air vents are open.

Switching pre-ventilation on/off

1.  Tap the icon for the Climate menu on the menu bar.
2. "General settings"
3. "Pre-ventilation"
4. Select the desired setting.

Departure time

General information

Different departure times can be set to ensure a comfortable interior temperature in the vehicle at the time of departure.

- ▶ One-time departure time: the time can be set.
The system is switched on once.
- ▶ Departure time with weekday: time and day of the week can be set.
On the desired weekdays, the system will be switched on before the set departure time.

The departure time is preselected in two steps:

- ▶ Set departure times.
- ▶ Activate departure times.

A minimum of 10 minutes should pass between setting and activating the departure time and the planned departure time to allow a sufficient period of time for the climate control.

Setting the departure time

1.  Tap the icon for the Climate menu on the menu bar.
2. "General settings"
3. "Pre-ventilation"
4. "Departure plan"
5. Select the desired departure time.
6. Set the desired departure time.
7. Select day of the week, if needed.

Activating the departure time

1.  Tap the icon for the Climate menu on the menu bar.
2. "General settings"
3. "Pre-ventilation"
4. "Departure plan"
5. Activate the desired departure time.

Display

Icon	Description
	Icon on the instrument panel. Icon illuminates: a departure time is activated. Icon flashes: pre-ventilation is switched on.

Activating with My BMW App

Depending on vehicle equipment, the My BMW App with remote functionality can be used to turn on pre-cooling at a preset departure time or immediately.

Pre-conditioning through Remote Engine Start

Principle

Pre-conditioning cools or heats the car's interior prior to start of the trip to a comfortable temperature. The system automatically cools, vents, and heats depending on the interior, external, and set temperature. Snow and ice may be removed more easily.

The system starts the engine automatically and allows it to run for a limited period of time.

Safety information

DANGER

If the exhaust pipe is blocked or ventilation is insufficient, harmful exhaust gases can pollute the area in and around the vehicle or penetrate the vehicle. The exhaust gases contain pollutants which are colorless and odorless. In enclosed areas or areas with insufficient ventilation, exhaust gases can also accumulate outside of the vehicle. There is a danger to life. Keep the exhaust pipe free and ensure sufficient ventilation. Do not switch on stationary climate control in enclosed areas or areas with insufficient ventilation, e.g. in enclosed garages.

Warning

When stationary climate control is in operation, high temperatures can occur underneath the body, for instance caused by the exhaust system. If combustible materials such as leaves or grass come in contact with hot parts of the exhaust system, these materials can ignite. There is a risk of fire. Make sure that no combustible materials can come in contact with hot vehicle parts during stationary climate control operation, e.g. leaves, grass, gas, gasoline, oil or other combustible objects.

Functional requirements

- ▶ The vehicle is in idle state or standby state.
- ▶ Battery is sufficiently charged.
- ▶ The fuel tank capacity is sufficient.
- ▶ Hood is closed.
- ▶ Make sure that the vehicle's date and time are set correctly.
- ▶ Air vents are opened.

Enabling the automatic engine start function

The automatic engine start must be enabled before using the system. Otherwise, the engine cannot switch on automatically to climatize the car's interior.



1. Tap the icon for the Climate menu on the menu bar.
2. "General settings"
3. "Pre-conditioning"
4. "Remote Engine Start"
5. "Start engine for climate cont."
6. Confirm the disclaimer.

Turning on/turning off the pre-conditioning

General information

The system switches off automatically after max. 15 minutes for safety reasons.

The system can be switched on a maximum of two times in a row.

The system will be available again as soon as the drive-ready state is activated and deactivated again.

Switching on via iDrive



1. Tap the icon for the Climate menu on the menu bar.
2. "General settings"
3. "Pre-conditioning"
4. "Start now"

Switching on/off via vehicle key

The system can be switched on and off using the vehicle key.



Press the button on the vehicle key three times within 1 second.

After operating the vehicle key, it will take approximately 3 seconds until the engine is switched on.

To switch off the system, press the button again three times.

Switching off with the Start/Stop button

The system can be switched off directly by pressing the Start/Stop button without depressing the brake pedal.

Climate control for departure time

General information

Scheduled departure times can be set up in the system to ensure a comfortable interior temperature in the vehicle at the time of departure.

- ▶ One-time departure time: the time of the scheduled departure can be set.

The system is switched on once.

- ▶ Departure time with weekday: time and day of the week of the scheduled departure can be set.

The departure time is preselected in two steps:

- ▶ Set departure times.
- ▶ Activate departure times.

The system is activated automatically a few minutes before the set departure time. The system remains switched on for a short time after the set departure time.

For safety reasons, the air conditioning can only be activated once for the departure time.

The system will be available again as soon as the drive-ready state is activated and deactivated again.

Observe the information about the intended use of the vehicle.

Additional information:

For Your Own Safety, refer to page 8.

Setting the departure time



1. Tap the icon for the Climate menu on the menu bar.
2. "General settings"
3. "Pre-conditioning"
4. "Departure plan"
5. Set the departure time.
6. Select day of the week, if needed.

Activating the departure time



1. Tap the icon for the Climate menu on the menu bar.
2. "General settings"
3. "Pre-conditioning"
4. "Departure plan"
5. Activate the desired departure time.

Display

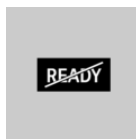

In the instrument cluster:

The engine runs for the purpose of operating the pre-conditioning. The vehicle is not ready to drive.

Icon	Description
	Icon on the instrument panel. Icon illuminates: a departure time is activated. Icon flashes: pre-conditioning is switched on.

Confirmation signals from the vehicle

The activation of the system is confirmed by flashing twice.

The parking lights are switched on as long as the system is switched on.

Interior equipment

Vehicle features and options

This chapter describes model-specific equipment, systems, and functions that are currently available, or may become available in the future, even if they are not present in the vehicle.

Additional information:

Vehicle equipment, refer to page 8.

Integrated universal remote control

Principle

The integrated universal remote control in the interior mirror can operate remote-controlled systems such as garage door openers, alarm systems or locking systems.

General information

The integrated universal remote control replaces up to three different hand-held transmitters. To operate the remote control, the buttons on the interior mirror must be programmed with the desired functions.

Before selling the vehicle, delete the stored functions for the sake of security.

If possible, do not install the antenna of the remote-controlled system near metal objects to ensure the best possible operation.

Safety information

Warning

The operation of remote-controlled systems with the integrated universal remote control such as the garage door may result in injury, for example, body parts becoming jammed in a garage door. There is a risk of injury or risk

of damage to property. Make sure that the travel path of the respective system is clear during programming and operation. Also follow the safety information for the hand-held transmitter.

Compatibility



If this icon is printed on the packaging or in the operating instructions of the remote-controlled system, the system is generally compatible with the integrated universal remote control.

Additional questions are answered by:

- ▶ An authorized service center or another qualified service center or repair shop.
- ▶ www.homelink.com on the Internet.

HomeLink is a registered trademark of Gentex Corporation.

For any additional questions, contact an authorized service center or another qualified service center or repair shop.

Control elements on the interior mirror



- ▶ Buttons, arrow 1.
- ▶ LED, arrow 2.
- ▶ Hand-held transmitter of the remote-controlled system, arrow 3.

Programming the integrated universal remote control

Functional requirement

The battery of the hand-held transmitter must be fully charged at the time of programming to ensure an optimal range of the integrated universal remote control.

Programming individual buttons

1. Park the vehicle within range of the remote-controlled system.
2. Turn on standby state.
3. Select desired button on the interior mirror:
 - ▶ Program available button:
Press the button.
 - ▶ Program already assigned button:
Press and hold the button for approx. 20 seconds.

The LED on the interior mirror will slowly begin flashing orange.

4. Hold the hand-held transmitter for the remote-controlled system approx. 1 to 12 in/2.5 to 30 cm away from the buttons on the interior mirror.
The required distance depends on the hand-held transmitter.
5. Press and hold the button on the hand-held transmitter.
Canada: if programming with the hand-held transmitter was interrupted, hold down the interior mirror button and repeatedly press and release the hand-held transmitter button for 2 seconds.
6. The LED can illuminate in different ways:
 - ▶ The LED illuminates green: programming completed.
Release button.
 - ▶ The LED flashes green rapidly: the hand-held transmitter was detected but programming is not complete.

Press and hold the button on the interior mirror for approx. 2 seconds. Perform this procedure three times.

If the integrated universal remote control remains nonoperational, continue with the special features for rolling code radio systems.

- ▶ LED does not illuminate green after 60 seconds: programming not completed.
Repeat steps 3 to 5.

Special feature of the rolling code wireless system

For systems with a rolling code radio system, the integrated universal remote control and the system also have to be synchronized.

Refer to information on synchronization in the operating instructions of the remote-controlled system.

1. Program the desired button on the interior mirror.
2. Locate and press the synchronizing button on the remote-controlled system such as on the garage door.

You have approx. 30 seconds for the next step.

Synchronizing is easier with the aid of a second person.

3. Press and hold the programmed button on the interior mirror for approx. 3 seconds.
If necessary, repeat this step up to three times in order to end synchronization. Once synchronization is complete, the programmed function will be carried out.

Operation

After programming, the remote-controlled system can be operated with the button on the interior mirror.

Press and hold the desired button of the remote-controlled system within range until the function is triggered.

The LED on the interior mirror is continuously illuminated green during the transmission of the radio signal.

Deleting a button assignment

The button assignment cannot be deleted individually.

Press and hold the two outer buttons on the interior mirror simultaneously for approximately 10 seconds until the LED flashes green rapidly.

All stored button assignments will be deleted.

Sun visor

Glare shield

Fold the sun visor down or up.

Glare shield from the side

Folding the sun visor out

1. Fold the sun visor down.
2. Detach it from the holder and swing it toward the side window.
3. Shift it back to the desired position.

Folding the sun visor in

Proceed in the reverse order to close the sun visor.

Vanity mirror

A vanity mirror is located in the sun visor behind a cover.

Sockets

Principle

The socket can be used for electronic devices when the standby or drive-ready state is switched on.

General information

The total load of all sockets must not exceed 140 watts at 12 volts.

Do not damage the socket by using unsuitable connectors.

Safety information

Warning

Devices and cables in the unfolding area of the airbags such as portable navigation devices can hinder the unfolding of the airbag or be thrown around in the car's interior while unfolding. There is a risk of injury and risk of damage to property. Make sure that devices and cables are not in the airbag's area of unfolding.

Warning

Battery chargers that charge the vehicle battery via sockets or cigarette lighters in the vehicle may overload or damage the 12 V electrical system. There is a risk of injury or risk of damage to property. Only connect battery chargers for the vehicle battery to the jump-start terminals in the engine compartment.

⚠ Warning

If metal objects fall into the socket, they can cause a short circuit. There is a risk of injury or risk of damage to property. Insert the cigarette lighter or socket cover again after using the socket.

Front center armrest



The center armrest contains a socket.

USB port

General information

Follow the information regarding the connection of mobile devices to the USB port in the section on USB connections.

Additional information:

USB connection, see Owner's Manual for Navigation, Entertainment, Communication;

In the front center armrest



Two USB ports are located in the center armrest.

Properties:

- ▷ USB port Type C.
- ▷ For charging mobile devices and for data transfer.
- ▷ Charge current: max. 3 A.

In the rear center armrest

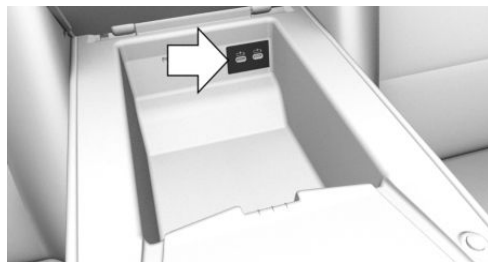

Two USB ports are located in the center armrest.

Properties:

- ▷ USB port Type C.
- ▷ For charging mobile devices.
- ▷ Charging current: max. 3 A / 45 W.

BMW Travel & Comfort System

General information

USB ports and mounts for attaching special accessories, e.g., universal holders for tablets or clothes hangers, are located on the backrests of the front seats.

Properties of the USB ports:

- ▶ USB port Type C.
- ▶ For charging mobile devices.
- ▶ Charge current: maximum 3 A / 45 W per seat.

For more information, contact an authorized service center or another qualified service center or repair shop.

Overview

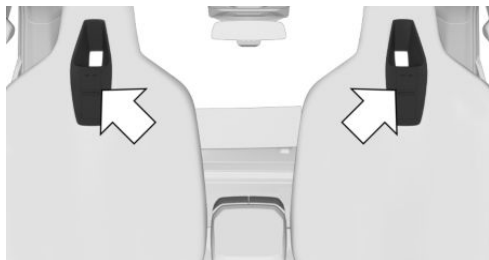

The mounts and USB ports are located behind the marked covers.

Installing optional accessories

1. Slide the cover all the way up.



2. Mount the optional accessories, refer to Assembly Instructions.

Wireless charging tray

Principle

The wireless charging tray allows wireless charging of mobile phones and other mobile devices certified according to the Qi standard.

General information

Quick charging functions are supported depending on the mobile device.

The integrated fan cools the device to be charged.

When inserting the device to be charged, make sure that there are no objects between the device to be charged and the wireless charging tray.

(🔌) The charging process is displayed as follows:

- ▶ Tray in center console: charging indicator on control display.
The charge indicator is shown alternately in the status field with additional status information.
- ▶ Tray in rear center armrest: charging display on BMW Touch Command.

Safety information

Warning

When charging a Qi-compatible device in the wireless charging tray, any metal objects on the tray together with the device can become very hot. If storage media or electronic cards, e.g., chip cards, cards with magnetic strips, or cards that transmit signals, are placed on the tray together with the device, they may not function correctly. There is a risk of injury and risk of damage to property. When charging mobile devices, make sure there are no objects on the tray together with the device.

Warning

When charging mobile devices in the wireless charging tray, an electromagnetic field is created. This may cause damage to pacemakers, implanted defibrillators, and similar devices. There is a risk of injury or danger to life. When loading mobile devices with your upper body area, maintain a distance of at least 2 inches/5 cm to the wireless charging tray.

Overview

Tray across in the center console:

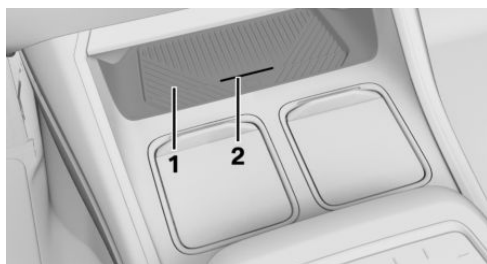

1 Storage area

2 Fan

Storage tray in the rear center armrest:

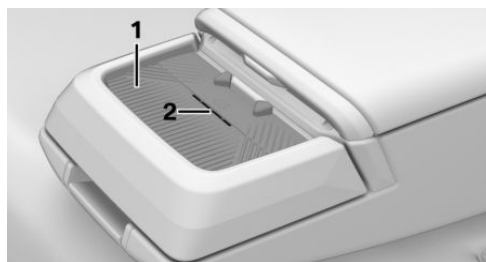

1 Storage area

2 Fan

Functional requirements

- ▶ The device to be charged must be certified according to the Qi standard.
- ▶ Standby state is switched on.
- ▶ Charging function is turned on.
- ▶ The mobile phone cannot exceed a maximum size of approx. 6.69 x 3.34 x 0.7 in/170 x 85 x 18 mm.
- ▶ Protective sleeves and covers must be suitable for wireless charging.
- ▶ Storage tray in the rear center armrest:
 - The rubber mat is located in the storage compartment.
- ▶ The mobile phone to be charged is located in the center of the tray. The mobile phone display is pointing upwards.
- ▶ The tray in the rear center armrest: the center armrest remains folded down.

Turning the charging function on/off

Control display

The charging function for the front and rear trays can be switched on and off on the control display.

1.  Apps menu
2. "Vehicle"
3. "System settings"



- "Wireless charging tray"
- "Wireless charging"

BMW Touch Command

The charging function for the rear tray can be switched on and off via BMW Touch Command.

- "Telephone" or "Wireless char."
- If necessary, "Wireless charging"
- "Activate charging"

Inserting the mobile phone

Tray in the center console

Place the mobile phone centered in the tray with the display facing up.

Tray in the rear center armrest

- Fold down the center armrest.
- Place the mobile phone centered in the tray with the display facing up.

Forgotten warning

General information

A warning can be given if when leaving the vehicle, a Qi-certified mobile phone was forgotten in the wireless charging tray in the center console.

The forgotten warning is displayed in the instrument cluster.

Enable/Disable Forgotten Warning

- Apps menu
- "Vehicle"
- "System settings"
- "Wireless charging tray"
- "Mobile phone reminder"

System limits

The charge current may be reduced or charging may be temporarily interrupted in the wireless charging tray in the following situations:

- ▶ Due to excessive temperatures on the surface of the tray and mobile phone.
- ▶ If there are objects between the mobile phone and the wireless charging tray.
- ▶ If storage media or electronic cards, e.g., chip cards, cards with magnetic stripes, or cards for signal transmission, are located between the mobile phone and wireless charging tray.
- ▶ Due to protective sleeves and covers that exceed a thickness of 0.07 in/2 mm
- ▶ Due to protective sleeves and covers made of unsuitable material, e.g., with magnetic parts.
- ▶ Due to add-on parts for mobile phone, e.g., holders.
- ▶ By settings on the mobile phone, for instance for charging. Follow the relevant instructions on the control display and in the instructions for the mobile phone, if applicable.

Interior camera

Principle

The interior camera can be used to record the vehicle interior.

General information

The interior camera can provide the following functions:

- ▶ Interior camera.
You can record, save and display media.
- ▶ Remote Inside View.
The vehicle interior can be recorded with the My BMW App.
- ▶ Anti-theft recorder.

If the alarm system is triggered, the vehicle interior is automatically recorded. The recording can be shown using the My BMW App.

Data protection

General information

The permissibility of recording and using recordings is contingent upon the statutory regulations of the country in which the system is to be used. The user is responsible for the use of the system and compliance with respective applicable regulations.

The manufacturer of the vehicle recommends confirming there are no statutory or regulatory constraints on use of the system in your state or country prior to the initial use. In addition, the laws with respect to use of the system should be verified in regular intervals, especially when borders are frequently crossed.

Other users and occupants of the vehicle must be informed about the system. In addition, information about the system is required when handing off the vehicle.

Data transfer and data storage

The data transfer and data storage of the media recordings depends on the recording function.

Interior camera:

- ▶ Data transfer to a mobile device, connection to the vehicle via WLAN.
- ▶ Data is stored in the vehicle and assigned to the BMW ID or a driver profile.

Remote Inside View:

- ▶ Data transfer with My BMW App to a mobile device, connection with ConnectedDrive account.
- ▶ Data is stored in the My BMW App and after data has been sent on the mobile device.

Anti-theft recorder:

- ▶ Data transfer with My BMW App to a mobile device, connection with ConnectedDrive account.
- ▶ Data is stored in the vehicle and after the data transfer in the mobile device.

More information on the scope and content of data processing is available on the Internet in the ConnectedDrive privacy notices/service descriptions.

Functional requirements

Interior camera:

- ▶ Privacy Policy accepted.
Data protection, refer to page 68.
- ▶ The camera is activated.

To transfer recordings to mobile devices:

- ▶ Data transfer is activated.
- ▶ Mobile device is connected to the vehicle via WLAN.

Remote Inside View/Anti-theft recorder:

- ▶ Privacy Policy accepted.
- ▶ The My BMW App is installed on the mobile device.
- ▶ My BMW App is linked with the ConnectedDrive account.
- ▶ Vehicle is parked and locked.
- ▶ Anti-theft recorder: equipped with alarm system.

Ensure that the faces of occupants are visible and are not partially or completely covered, for instance by face masks.

Overview

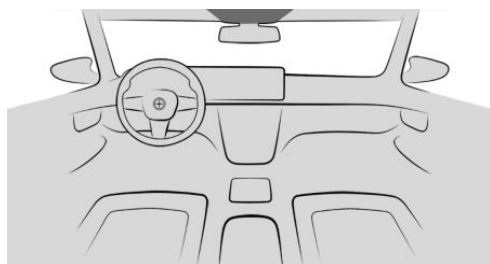

The interior camera is located on the headliner.

Additional information:

Around the headliner, refer to page 33.

Activating/deactivating interior camera

Prior to the first use of the interior camera, the recording function and, if necessary, data transfer must be activated. To do this, confirm the query on the control display.

Follow applicable legal regulations.

The recording function or data transfer can be deactivated or activated.

1. Apps menu
2. "All apps"
3. "Interior camera"
4. "Settings"
5. Select the desired setting.

Interior camera

Recording mode

Recording mode	Function
"Single photo"	Shortly after triggering, a photo will be taken.
"Smile"	When the system detects a smile, a picture will be taken.

Recording mode	Function
"Self-timer (3 sec.)"	After the timer has expired, a photo will be taken.
"Burst mode"	Shortly after triggering, a series of pictures will be taken.

Take picture

1. Apps menu
2. "All apps"
3. "Interior camera"
4. "Photo"
5. Select desired recording mode.
6. Triggering a photo.

Depending on the selected recording mode, the photo is taken shortly after triggering, when a smile is recognized, or if the timer has elapsed.

For burst shots, the series of pictures will be displayed as a preview.

Recording video

1. "MENU"
2. "All apps"
3. "Interior camera"
4. "Video"
5. Start video recording.

You can only record video for a certain time.

Displaying and managing recordings

Saved recordings can be displayed, transferred and deleted in the vehicle.

In some national-market versions, the recordings are only shown on the control display for up to approx. 2 mph/3 km/h for your own safety.

1. Apps menu
2. "All apps"

3. "Interior camera"
4. "Gallery"
5. Select the desired recording.
6. Select the desired setting.

Scan the QR code shown in the display to transfer recordings to a mobile device. The recording is transferred when the pop-up on the mobile device is opened. The mobile device must be connected to the vehicle via WLAN.

Settings

1.  Apps menu
2. "All apps"
3. "Interior camera"
4. "Settings"
5. Select the desired setting.

An individual gesture can be assigned for recordings with the interior camera.

Remote Inside View

Recordings from the vehicle interior can be displayed on a mobile device with the My BMW App to check the vehicle interior, e.g., for forgotten objects.

The function is not suitable for monitoring people or animals left behind.

Anti-theft recorder

If the alarm system is triggered, the vehicle interior is automatically recorded. The My BMW App notifies you when recording. The recording can be shown on a mobile device.

Up to three media recordings can be stored in the vehicle and synchronized with the My BMW App. The media recording stored in the vehicle will be deleted when the vehicle is reset to factory settings.

Occupying the seats

The interior camera is also used for the detection of occupied seats.

When all doors are closed, the interior camera switches on automatically on a regular basis. The system analyzes the vehicle interior to detect occupied seats. No media recordings are made in the process. Two infrared light sources next to the camera lens illuminate while the interior camera is active. Depending on the lighting conditions, the infrared light sources may be visible.

Storage compartments

Vehicle features and options

This chapter describes model-specific equipment, systems, and functions that are currently available, or may become available in the future, even if they are not present in the vehicle.

Additional information:

Vehicle equipment, refer to page 8.

Safety information

Warning

Devices connected to the vehicle via a cable such as mobile phones or loose objects can be thrown through the vehicle interior while driving such as in the event of an accident, braking or evasive maneuver. There is a risk of injury and risk of damage to property. Secure loose objects or devices that are connected to the vehicle via a cable.

Warning

Open flaps of the storage compartments, e.g., glove compartment or center armrest, protrude into the interior when folded open and may be in the way of an airbag that deploys. In addition, objects in the open storage compartment can be thrown into the vehicle interior during the trip, for instance, in the event of an accident or when braking or making an evasive maneuver. There is a risk of injury. Always close storage compartments immediately after use.

Warning

Anti-slip pads such as anti-slip mats can damage the dashboard. Attached objects could come loose. There is a risk of injury or risk of damage to property. Do not use anti-slip pads.

Glove compartment

Opening the glove compartment

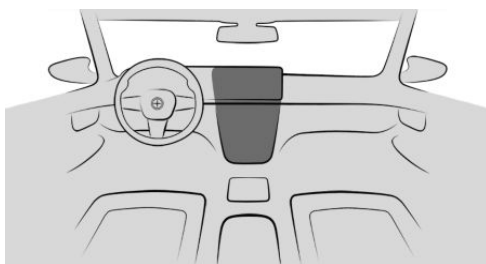

Press the button.

The glove compartment opens automatically.

Locking the glove compartment

Use the valet parking mode to lock the glove compartment.

Additional information:

Valet parking mode, refer to page 95.

Malfunction

The glove compartment is unlocked electrically. The glove compartment can be unlocked manually in the event of a malfunction or during a BMW Remote Software Upgrade, for

instance to obtain an item that is urgently needed.

1. Open the front passenger door.
2. Remove the instrument panel side cover using a suitable blunt object.

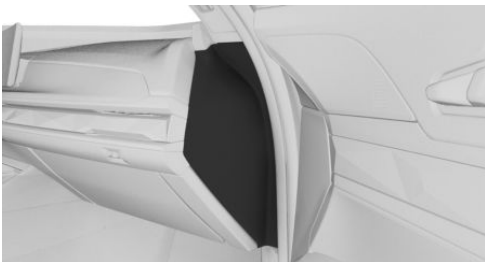

3. Press the sound insulation downward or remove it.
4. Using a suitable object such as a screwdriver, press the locking bolt inward.

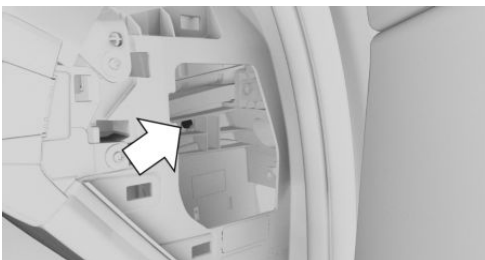

5. Pull the object out of the opening again. The glove compartment opens.

After manually unlocking the glove compartment, have the locking system checked by an authorized service center or another qualified service center or repair shop.

Storage compartments in the doors

General information

There are storage compartments in the doors.

Safety information

Warning

Breakable objects such as glass bottles or glasses can break in the event of an accident, braking or an evasive maneuver. Broken glass can be scattered in the car's interior. There is a risk of injury or risk of damage to property. Do not use any breakable objects while driving. Only stow breakable objects in closed storage compartments.

Front center armrest

General information

A storage compartment is located in the center armrest between the seats.

Opening the center armrest

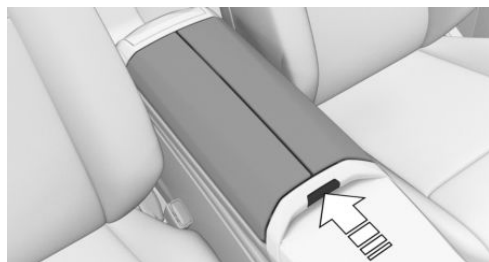

Press the button.

Closing the center armrest

Press both lids down until they engage.

Rear center armrest

General information

A storage compartment is located in the center armrest between the seats.

Folding down the center armrest

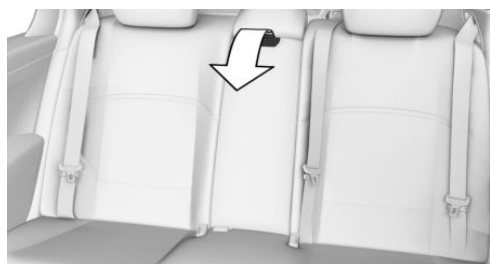

Fold the center armrest forward on the handle.

Opening the center armrest



Press the button, arrow 1, and fold the lid up, arrow 2.

Closing the center armrest

Press the lid down until it engages.

Front cup holder

Safety information

Warning

Unsuitable containers in the cup holders may damage the cup holders or be thrown about the car's interior in the event of an accident, an evasive maneuver, or forceful braking. Spilled liquids can distract from the surrounding traffic conditions, lead to an accident and damage vehicle components. Hot drinks can damage the cup holder or lead to scalding.

There is a risk of injury or risk of damage to property. Do not force objects into the cup holder. Use lightweight, shatterproof, and sealable containers. Clean up spilled liquids immediately. Do not transport hot beverages.

Opening the cup holder



Pull the cover backward until it engages.

Closing the cup holder

Tap the cover on the handle. The cover closes automatically.

Rear cup holder

Safety information

Warning

Unsuitable containers in the cup holders may damage the cup holders or be thrown about the car's interior in the event of an accident, an evasive maneuver, or forceful braking. Spilled liquids can distract from the surrounding traffic conditions, lead to an accident and damage vehicle components. Hot drinks can damage the cup holder or lead to scalding. There is a risk of injury or risk of damage to property. Do not force objects into the cup holder. Use lightweight, shatterproof, and sealable containers. Clean up spilled liquids immediately. Do not transport hot beverages.

⚠ NOTICE

With an open cup holder, the center armrest cannot be folded back up. There is a risk of damage to property. Press back the covers before the center armrest is folded up.

Opening the cup holder

1. Fold down the center armrest.

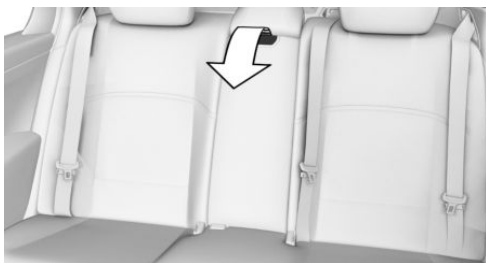

2. Press the button. The cup holder extends automatically.



Closing the cup holder

Push the cup holder back until it engages.

Coat hooks

General information

The coat hooks are located in the grab handles and on the door pillar in the rear.

Safety information

⚠ Warning

Clothing articles on the coat hooks can obstruct the view while driving. There is a risk of accident. When suspending clothing articles from the coat hooks, ensure that they will not obstruct the driver's view.

⚠ Warning

Improper use of the coat hooks can lead to a risk of objects flying about during braking and evasive maneuvers. There is a risk of injury and risk of damage to property. Only hang lightweight objects, for instance clothing articles, from the coat hooks.

Cargo area

Vehicle features and options

This chapter describes model-specific equipment, systems, and functions that are currently available, or may become available in the future, even if they are not present in the vehicle.

Additional information:

Vehicle equipment, refer to page 8.

Loading

Safety information

 **Warning**

High gross vehicle weight can overheat the tires, damage them internally and cause a sudden tire pressure loss. Driving characteristics may be negatively impacted, reducing directional stability, lengthening the braking distances and changing the steering response. There is a risk of accident. Pay attention to the permitted load-carrying capacity of the tires and never exceed the permitted gross vehicle weight.

 **Warning**

Devices connected to the vehicle via a cable such as mobile phones or loose objects can be thrown through the vehicle interior while driving such as in the event of an accident, braking or evasive maneuver. There is a risk of injury and risk of damage to property. Secure loose objects or devices that are connected to the vehicle via a cable.

 **Warning**

Improperly stowed objects can slip and be thrown into the car's interior, for instance in the event of an accident, braking or an evasive maneuver. Vehicle occupants can be hit and injured. There is a risk of injury and risk of damage to property. Stow and secure objects and cargo properly.

 **NOTICE**

Fluids in the cargo area can cause damage. There is a risk of damage to property. Make sure that no fluids leak in the cargo area.

Steps for determining correct load limit

1. Locate the statement "The combined weight of occupants and cargo should never exceed XXX kg or XXX lbs" on the vehicle's placard.
2. Determine the combined weight of the driver and passengers that will be riding in the vehicle.
3. Subtract the combined weight of the driver and passengers from XXX kg or XXX lbs
4. The resulting figure equals the available amount of cargo and luggage load capacity. For example, if the "XXX" amount equals 1,400 lbs and there will be five 150 lbs passengers in the vehicle, the amount of available cargo and luggage load capacity is 650 lbs (1,400 - 750 (5 x 150) = 650 lbs)
5. Determine the combined weight of luggage and cargo being loaded on the vehicle. That weight may not safely exceed the

available cargo and luggage load capacity calculated in Step 4.

- If the vehicle will be towing a trailer, load from your trailer will be transferred to the vehicle. Consult this manual to determine how this reduces the available cargo and luggage load capacity of the vehicle.

Payload

 +  \leq Max. Load

 +  \leq Max. Load

 +  \leq Max. Load

The maximum payload is the sum of the weight of the occupants and the cargo.

The greater the weight of the occupants, the less cargo that can be transported.

Stowing and securing cargo

- ▶ Cover sharp edges and corners on the cargo.
- ▶ Fasten the aids for securing the load to the lashing eyes in the cargo area.
- ▶ Small and light cargo: secure with tensioning straps or tension bands or with a luggage compartment net.
- ▶ Larger and heavy cargo: secure with cargo straps.
- ▶ Heavy cargo: stow as far forward as possible, directly behind and at the bottom of the rear seat backrests.
- ▶ Very heavy cargo: stow as far forward as possible, directly behind and at the bottom of the rear seat backrests. When the rear seat is not occupied, secure each of the outer seat belts in the opposite buckle.

Lashing eyes in the cargo area

General information

Attach auxiliary materials to secure the cargo such as lashing straps, tensioning straps, draw straps, or cargo nets to the lashing eyes.

Overview



The lashing eyes are located on the loading sill and on the side walls of the trunk.

Multifunction hook

General information

A multifunction hook is located on the left and right side in the cargo area.

Safety information

Warning

Improper use of the multifunction hooks can lead to a risk of objects flying about, e.g., during braking and evasive maneuvers. There is a risk of injury and risk of damage to property. Only hang lightweight objects from the multifunction hooks. Only transport heavy luggage in the cargo area if it has been appropriately secured.

Storage compartment on the left side

General information

A storage compartment is located on the left side in the cargo area.

Opening the storage compartment

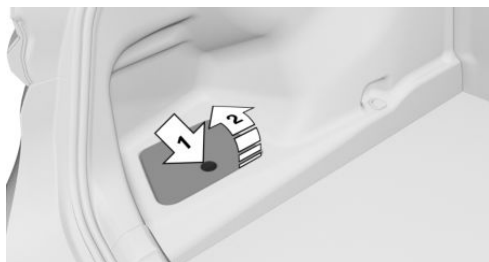

Turn the screw cap in the cover by 90°, arrow 1, and fold down the trim panel, arrow 2.

Through-loading system

Principle

The through-loading system allows the transport of long objects such as skis.

Opening the through-loading system

1. Fold down the center armrest.
2. Loosen the cover.

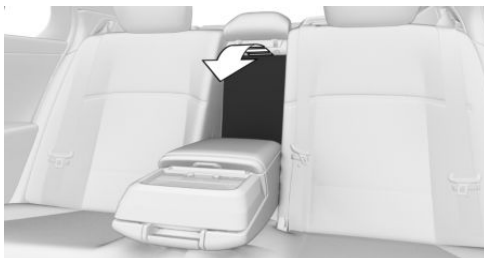

3. Pull handle, arrow 1, down and fold trim forward, arrow 2.

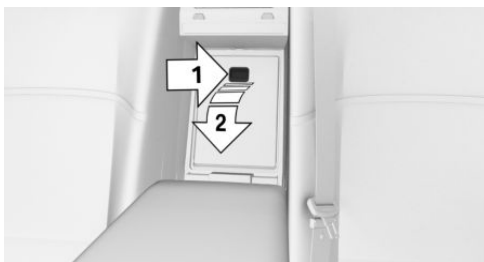

Things to remember when driving

Vehicle features and options

This chapter describes model-specific equipment, systems, and functions that are currently available, or may become available in the future, even if they are not present in the vehicle.

Additional information:

Vehicle equipment, refer to page 8.

Break-in procedures

General information

Moving parts need to work together smoothly.

The following instructions will help you to achieve a long vehicle life and good efficiency.

Safety information

Warning

Due to new parts and components, safety and driver assistance systems can react with a delay. There is a risk of accident. After installing new parts or with a new vehicle, drive conservatively and intervene early if necessary. Observe the break-in procedures of the respective parts and components.

Engine, transmission, and axle drive

Up to 1,200 miles/2,000 km

Do not exceed the maximum engine and road speed:

- ▶ With gasoline engine: 4500 rpm and 100 mph/160 km/h.

Avoid full throttle or kickdown under all circumstances.

For 760i: The maximum engine power is reduced and gradually increased during the first 310 miles/500 km.

From 1,200 miles/2,000 km

The engine and vehicle speed can gradually be increased.

Tires

Tire traction is not optimal due to manufacturing circumstances when tires are brand new.

Drive conservatively for the first 200 miles/300 km.

Brake system

Brake disks and brake pads must be run in to avoid possible brake noise. Drive cautiously for the first approx. 300 miles/500 km.

Following part replacement

Observe the break-in procedures again if components mentioned above are replaced.

General driving notes

Closing the trunk lid

Safety information

Warning

An open trunk lid protrudes from the vehicle and can endanger occupants and other road users or damage the vehicle in the event of an accident, braking or evasive maneuvers. In addition, exhaust gas or water may enter the vehicle interior. There is a risk of injury or risk of damage to property. Do not drive with the trunk lid open.

Driving with the trunk lid open

If the vehicle still needs to be driven with the trunk lid open:

- ▷ Close all windows.
- ▷ Greatly increase the blower output.
- ▷ Drive moderately.
- ▷ Fasten the trunk lid, e.g., with a tensioning belt.

Hot exhaust system

Warning

High temperatures can occur underneath the body, for instance caused by the exhaust system, while driving. Contact with the exhaust system can cause burns. There is a risk of injury. Do not touch the exhaust system, including the exhaust pipe, when hot.

Warning

If combustible materials such as leaves or grass come in contact with hot parts of the exhaust system, these materials can ignite. There is a risk of fire and an injury hazard. Do not remove the heat shields installed and never apply undercoating to them. Make sure that no combustible materials can come in contact with hot vehicle parts while driving, in Neutral or during parking.

Exhaust gas particulate filter

Principle

The exhaust gas particulate filter collects soot particles. The soot particles are burned at high temperatures to clean the exhaust gas particulate filter as necessary.

General information

During several minutes of cleaning the following may occur:

- ▷ Temporarily, the engine may run less smoothly.
- ▷ A somewhat higher RPM is necessary to reach usual power development.
- ▷ A slight smoke formation coming from the exhaust system, even after the engine is switched off.
- ▷ Noises such as those caused by the radiator fan running, even several minutes after the engine is switched off.

Overrun of the radiator fan for several minutes is normal even after short trips.

Condensation detected in drive system

Various drive profiles ensure that the drive system functions properly. A driving style with consistently low loads can negatively affect overall functionality (e.g., condensation formation in the drive system). Occasionally running the engine longer with higher loads can counteract this.

The next time you drive outside of town, proceed as follows for around 30 minutes:

For a gasoline engine:

- ▷ Deactivate the speed control system.
- ▷ Activate Sport program.
- ▷ If possible, drive at varying speeds.

Additional information:

Steptronic transmission, refer to page [128](#).

Attachment point for radio systems

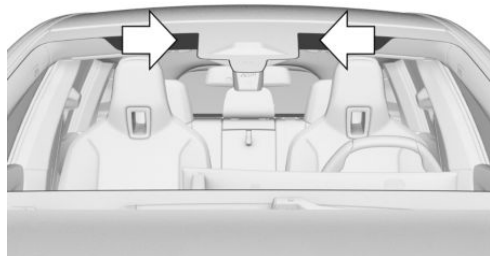

With climate comfort windshield: the marked area is not covered with heat-reflective coating.

The marked area can be used for the attachment of radio systems, e.g.:

Climate Comfort laminated glass

The vehicle laminated glass provides complete protection against the harmful effects of ultra-violet radiation on the skin.

In addition, Climate Comfort laminated glass reduces heat radiation and prevents the interior from becoming too hot.

Mobile radio in the vehicle

Warning

Vehicle electronics and mobile communication devices can influence one another. There is radiation due to the transmission operations of mobile communication devices. There is a risk of injury or risk of damage to property. If possible, in the car's interior only use mobile communication devices such as mobile phones with a direct connection to an external antenna or the Personal eSIM in order to prevent mutual interference and to deflect radiation from the vehicle interior.

Aquaplaning

On wet or slushy roads, a wedge of water can form between the tires and road surface.

This phenomenon is referred to as aquaplaning. It is characterized by a partial or complete loss of contact between the tires and the road surface, ultimately undermining your ability to steer and brake the vehicle.

Driving through water

General information

When driving through water, follow the following:

- ▶ Only drive through when the combustion engine is running.
- ▶ Prevent the combustion engine from shutting down, e.g., by deactivating Auto Start/Stop.
- ▶ Drive through calm water only.
- ▶ Drive through water only up to a maximum height of 9.8 inches/25 cm.
- ▶ Drive through water at a maximum of walking speed, up to 3 mph/5 km/h.

Safety information

NOTICE

When driving too quickly through deep water, the water can penetrate the engine compartment, the electrical system, or the transmission. There is a risk of damage to property. When driving through water, do not exceed the maximum indicated water level and the maximum speed for driving through water.

Braking safely

General information

The vehicle is equipped with an Antilock Braking System as a standard feature.

Perform emergency braking when appropriate. To achieve the best possible braking assistance, do not reduce the pressure on the brake pedal during full braking.

Steering is still responsive. You can still avoid any obstacles with a minimum of steering movement.

Sounds from the hydraulic circuits indicate that the Antilock Braking System is regulating.

Objects in the travel path of the pedals

Warning

Objects in the driver's footwell can limit the pedal travel or block a depressed pedal. There is a risk of accident. Stow objects in the vehicle such that they are secured and cannot enter into the driver's footwell. Use floor mats that are suitable for the vehicle and can be safely attached to the floor. Do not use loose floor mats and do not layer several floor mats. Make sure that there is sufficient clearance for the pedals. Ensure that the floor mats are securely fastened again after they were removed, for instance for cleaning.

Pedal feel when driving off

After turning on drive-ready state from idle state, the pedal may feel unusual, e.g., the pedal travel path may feel short or long. After the brake pedal has been fully released, the pedal will feel as usual again.

Driving in wet conditions

In case of wet roads, exposure to road salt or in heavy rain, gently depress the brake pedal every few kilometers.

Ensure that this action does not endanger other road users.

The heat generated while braking dries brake disks and brake pads and protects them against corrosion.

In this way the brake power will be available when you need it.

Hills

General information

Drive long or steep downhill gradients in the gear that requires least braking effort. Otherwise, the brake system may overheat and reduce braking effect.

You can increase the engine braking effect by downshifting, going all the way to first gear, if needed.

Safety information

Warning

Light but consistent pressure on the brake pedal can lead to high temperatures, brake wear and possibly even brake system failure. There is a risk of accident. Avoid placing excessive stress on the brake system.

Warning

In Neutral or with drive-ready state switched off, safety functions, for instance engine braking effect, braking assistance and steering assistance, may be restricted or not available. There is a risk of accident. Do not attempt to drive in idle state or with drive-ready state switched off.

Brake disk corrosion

Corrosion on the brake disks and contamination on the brake pads are increased by the following circumstances:

- ▶ Low mileage.
- ▶ Extended stationary periods.
- ▶ Infrequent use of the brakes.
- ▶ Aggressive, acidic, or alkaline cleaning agents.

Corrosion buildup on the brake disks will cause a pulsating effect on the brakes when braking slowly - generally this cannot be corrected.

Condensation water under the parked vehicle

When using the automatic climate control, condensation water develops and collects underneath the vehicle.

Pennant bracket

Safety information

⚠ NOTICE

At high speeds, a mounted pennant can cause damage to the vehicle, the pennant bracket, and the pennant itself. There is a risk of damage to property. Do not exceed a speed of 80 mph / 130 km/h. Remove pennant before trips at high speeds.

Overview



The pennant bracket is located on the side of the vehicle.

Installation

1. Remove the protective cap.
2. Insert pennant horizontally.
3. Turn the pennant clockwise by 90° to retain the pennant.

Driving on racetracks

⚠ Warning

The vehicle is not designed for use in M Sport or motorsport-like competition. There is a risk of accident. Do not use the vehicle for M Sport or motorsport-like competitions.

Higher mechanical and thermal loads during racetrack operation lead to increased wear. Use of the vehicle in M Sport or motor sport type competition is an improper use of the vehicle and may affect your warranty coverage. Please consult the "New Vehicle Limited Warranty" Booklet for further information on warranty matters.

Saving fuel

Vehicle features and options

This chapter describes model-specific equipment, systems, and functions that are currently available, or may become available in the future, even if they are not present in the vehicle.

Additional information:

Vehicle equipment, refer to page 8.

Reducing fuel consumption

Principle

The vehicle contains advanced technologies for the reduction of consumption and emission values.

There are some actions you can take to change your fuel consumption and environmental impact:

- ▶ Remove unnecessary cargo from the vehicle.
- ▶ Remove add-on parts, e.g., a rear carrier, after use.
- ▶ Close the windows while driving.
- ▶ Check the tire pressure regularly and increase it as necessary.
- ▶ Switch off the engine if the vehicle is to remain stationary for a longer period.
- ▶ Practice anticipatory driving and let the vehicle coast more often.
- ▶ Deactivate functions that are not required, e.g., rear window heating.
- ▶ Have the vehicle serviced regularly.

Adaptive recuperation

Principle

The adaptive recuperation supports an anticipatory and comfort-oriented driving style.

Various sensors analyze the current driving situation, e.g., the distance to the vehicle in front.

General information

Adaptive recuperation is available depending on the equipment and national-market version.

The system decides based on the situation if energy is recovered through recuperation or if the vehicle is to coast.

In vehicles with mild hybrid technology, the power of recuperation is adaptive, which causes the vehicle to decelerate to varying degrees when coasting.

Activating/deactivating adaptive recuperation

Adaptive recuperation is deactivated by activating SPORT driving mode.

Adaptive recuperation is activated when changing to another driving mode.

Display

Display in the instrument cluster

Adaptive recuperation can be displayed on the instrument cluster.

Additional information:

Power gauge, refer to page 153.

Display on the control display

The adaptive recuperation can be displayed on the control display.

Additional information:

Current driving condition, refer to page 160.

Coasting

Principle

The drive system allows the vehicle to roll freely with minimal deceleration in selector lever position D. This driving condition is referred to as coasting. This reduces fuel consumption.

Vehicles with mild hybrid technology do not consume fuel when coasting.

General information

An anticipatory driving style helps the driver to use the function often and supports the efficient effect of coasting.

Coasting is automatically adapted to the respective driving situation.

The coasting mode is displayed in the Live Vehicle menu as efficient coasting.

Additional information:

Current driving condition, refer to page 160.

Exemplary driving situations

If a route can be traveled without an anticipated need for braking, it is advantageous to roll.

The following exemplary driving situations may be suitable:

- ▶ Rolling on a straight downhill route without obstacles.
- ▶ Coasting on a distance without obstacles.

Avoid late or strong braking.

Functional requirements

- ▶ Selector lever position D is engaged.
- ▶ Brake is not depressed.

- ▶ Accelerator pedal is not operated.
- ▶ Engine and transmission are at operating temperature.

The function is available in the speed range from approx. 16 mph/25 km/h to 100 mph/160 km/h.

Operation via shift paddles

Principle

Depending on the vehicle's equipment, the Coasting mode can be influenced with the shift paddles.

Activating/deactivating coasting via shift paddles

Long press the right shift paddle to activate.

To deactivate, actuate the left shift paddle.

System limits

- ▶ While Active Cruise Control is active.
- ▶ With defective, dirty or covered sensors.
- ▶ Driving in the dynamic limit range and on steep uphill or downhill grades.
- ▶ Battery charge status temporarily too low or vehicle electrical system drawing excessive current.

Efficient mode

Principle

Efficient mode helps promote an efficient driving style.

When certain prerequisites are met the engine is automatically decoupled from the transmission in the D selector lever position. The vehicle continues traveling in Neutral to reduce consumption. The D selector lever position remains engaged.

In addition, the efficiency trainer displays situation dependent notes to assist with an efficient driving style.

The achieved extended range is displayed in the instrument cluster as bonus range.

Overview

Button in the vehicle

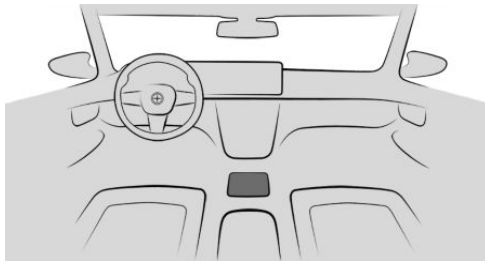

My Modes

Configuring Efficient mode

1.  Press the button.
2. "EFFICIENT"
3. "Settings"
4. Select the desired setting.

Resetting the settings

1.  Press the button.
2. "EFFICIENT"
3. "Settings"
4. "Reset settings"

Efficiency trainer

Principle

The system provides assistance for an anticipatory and comfort-oriented driving style. For this purpose, map information and sensor data is used to analyze the current driving situation such as upcoming speed limits and vehicles driving ahead. Based on this information, the driver receives notices for an efficient driving style early on. The efficiency of the driving style is evaluated in the control display and shown in three categories.

General information

The system has different displays to support the driver with an efficient driving style.

Functional requirements

- ▶ Selector lever position D is engaged.
- ▶ Efficient mode is activated.

Display

Power gauge

When the Efficient mode is activated, the display changes to a special configuration.

Depending on the equipment, some system information can also be displayed in the Head-up display.

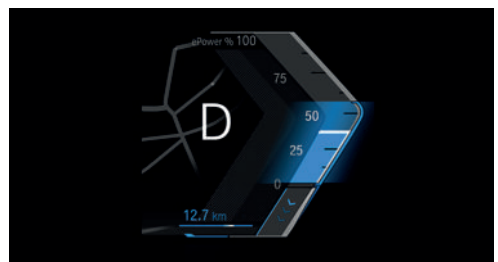

The efficient range of the power gauge is colored blue. Additionally, the bonus range will be displayed.

The efficient range is adjusted depending on the driving situation.

If the power gauge moves within the blue range, the current driving style is efficient. The display will change to gray if the driving style is inefficient.

Bonus range

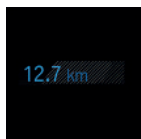

A modified driving style helps you extend your driving range.

The range extension is displayed as the bonus range in the instrument cluster.

If the bonus range is shown in gray or is hidden, the current driving style is inefficient.

The display turns blue as soon as all conditions for efficient driving are met.

The intervals for resetting the bonus range depend on the settings of the trip data.

Display in case of inefficient driving style



When driving above the efficient range, an arrow will be displayed.

For instance, this is displayed for the following situations:

- ▶ Excessive acceleration.
- ▶ Excessive speed.

In addition, a notice to coast in advance is displayed.

System limits

For example, the function is not available in the following situations:

- ▶ While Active Cruise Control is active.
- ▶ With trailer towing.

Efficiency evaluation

General information

The efficiency of the driving style, e.g., acceleration, is evaluated on the control display and shown in three categories. The current trip is analyzed.

Functional requirement

This function is available in Efficient mode.

Calling up the efficiency evaluation

1.  Apps menu
2. "Vehicle"
3. "Live Vehicle"

Additional information:

Live Vehicle, refer to page [142](#)

Display on the control display

The display of the efficiency analysis shows the efficiency of the driving style.

The more efficient the driving style, the larger the area that is displayed in color and the faster the bonus range increases.

In contrast, a reduced area will be displayed with an inefficient driving style.

Refueling

Vehicle features and options

This chapter describes model-specific equipment, systems, and functions that are currently available, or may become available in the future, even if they are not present in the vehicle.

Additional information:

Vehicle equipment, refer to page [8](#).

Follow the following when refueling

General information

Follow the fuel recommendation prior to refueling.

When refueling, hook the filler nozzle completely into the filler pipe. Lifting up the filler nozzle while refueling causes:

- ▶ Premature switching off.
- ▶ Reduced return of the fuel vapors.

The fuel tank is full when the filler nozzle clicks off the first time.

Make sure that the fuel cap is closed properly after refueling, otherwise the emissions warning light may illuminate.

Follow safety regulations posted at the filling station.

Additional information:

Fuel quality, refer to page [351](#).

Safety information

NOTICE

With a range below 30 miles/50 km, the engine may no longer have sufficient fuel. Engine functions are not ensured anymore. There is a risk of damage to property. Refuel promptly.

NOTICE

Fuels are toxic and aggressive. Overfilling of the fuel tank can damage the fuel system. Painted surfaces may be damaged by contact with fuel. Escaping fuel can harm the environment. There is a risk of damage to property. Avoid overfilling.

Fuel cap

General information

If the fuel filler cap is not fitted correctly, the emissions indicator light illuminates on the instrument cluster.

Additional information:

Indicator/warning lights, refer to page [145](#).

Safety information

Warning

The retaining strap of the fuel cap can be jammed and crushed while closing. The cap cannot be correctly closed. Fuel or fuel vapors can escape. There is a risk of injury or risk of damage to property. Pay attention that

the retaining strap is not jammed or crushed when closing the cap.

Opening

1. To open the fuel filler flap, press on the rear edge, arrow. The fuel filler flap opens.



2. Turn the fuel cap counterclockwise.

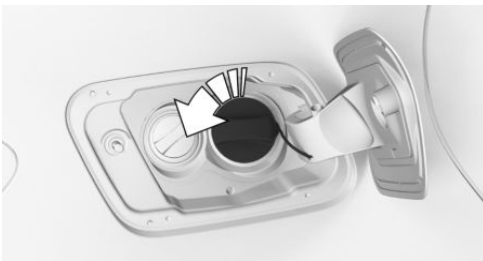

3. Place the fuel cap in the bracket attached to the fuel filler flap.

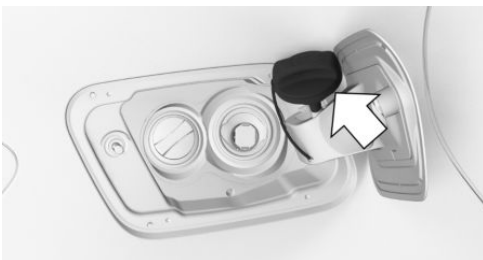

Closing

1. Fit the fuel cap and turn it clockwise until you clearly hear a click.
2. Press on the fuel filler flap until it engages.

Emergency unlocking

It may be necessary in certain situations to unlock the fuel filler flap manually, for instance with an electrical malfunction.

Have the fuel filler flap unlocked by an authorized service center or another qualified service center or repair shop.

Wheels and tires

Vehicle features and options

This chapter describes model-specific equipment, systems, and functions that are currently available, or may become available in the future, even if they are not present in the vehicle.

Additional information:

Vehicle equipment, refer to page 8.

Tire pressure

General information

The tire condition and tire pressure influence the following:

- ▷ The service life of the tires.
- ▷ Driving safety.
- ▷ Driving comfort.
- ▷ Fuel consumption.

Safety information

Warning

A tire with too little or no tire inflation pressure may heat up significantly and sustain damage. This will have a negative impact on aspects of handling such as steering and braking response. There is a risk of accident. Regularly check the tire inflation pressure, and correct it as needed, for instance twice a month and before a long trip.

Tire pressure specifications

In the tire pressure table

The tire pressure table contains all tire inflation pressure specifications for given tire sizes at ambient temperature. The tire inflation pres-

sure specifications apply to the tire sizes approved by the vehicle manufacturer for the corresponding vehicle types.

To identify the correct tire inflation pressure, please note the following:

- ▷ Tire sizes of the vehicle.
- ▷ Maximum speed for driving.

On the control display

The current tire inflation pressure values and the intended tire inflation pressure values for the mounted tires can be displayed on the control display.

To ensure that they are displayed correctly, the tire sizes must be stored in the system and must have been set for the mounted tires.

The current tire inflation pressure value is located on each tire.

The reference tire inflation pressure value is located in the lower area of the control display.

Checking the tire pressure

General information

The tires heat up while driving. The tire pressure increases with the tire temperature.

Tires have a natural, consistent tire pressure loss.

The displays of inflation devices may under-read by up to 0.1 bar/2 psi.

Checking via tire inflation pressure specifications in tire pressure table

1. Determine the intended tire inflation pressure levels for the mounted tires.
2. Check the tire inflation pressure in all four tires, using a pressure gage, for example.

3. Correct the tire inflation pressure if the actual tire inflation pressure deviates from the intended tire inflation pressure.
4. Make sure that all valve caps are screwed onto the tire valves.

The tire inflation pressure specifications in the tire inflation pressure table only relate to cold tires or tires at the same temperature as the ambient temperature.

Only check the tire inflation pressure levels when the tires are cold, i.e.:

- ▶ A distance traveled of max. 1.25 miles/2 km has not been exceeded.
- ▶ If the vehicle has not moved again for at least two hours after a trip.

If equipped with an emergency wheel: check the tire pressure of the emergency wheel in the cargo area regularly and correct if necessary.

Checking using the tire inflation pressure specifications on the control display

1.  Apps menu
2. "Vehicle"
3. "Vehicle status"
4. "Tire Pressure Monitor"
5. Check whether the current tire inflation pressure levels deviate from the intended tire pressure value.
6. Correct the tire inflation pressure if the actual tire inflation pressure deviates from the intended tire inflation pressure.

The display of current tire pressure on the control display may be restricted when the vehicle is stationary. After a short drive, the tire pressure is updated.

After correcting the tire pressure

If equipped with a Tire Pressure Monitor, the corrected tire pressures are applied automatically. Make sure that the tire settings are correct. With tires that cannot be found in the tire

pressure values on the control display, reset the Tire Pressure Monitor (TPM).

If equipped with a flat tire monitor, reinitialize the flat tire monitor.

Tire inflation pressures up to 100 mph/160 km/h

For speeds of up to 100 mph/160 km/h and for optimum driving comfort, follow the tire inflation pressure specifications in the tire pressure table and adjust as necessary.



The tire inflation pressure specifications can also be found on the tire pressure label on the driver's door pillar.

Do not exceed a speed of 100 mph/160 km/h.

Tire pressure values up to 100 mph/160 km/h

740i, 740i xDrive

Tire size	Pressure specifications in bar/PSI	
-----------	------------------------------------	--

Specifications in bar/PSI with cold tires

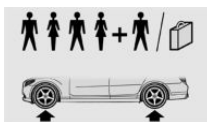

245/50 R 19 105 H XL A/S	2.4 / 35	2.4 / 35
--------------------------	----------	----------

245/50 R 19 105 H XL M+S		
--------------------------	--	--

245/50 R 19 105 W XL		
----------------------	--	--

Front: 255/45 R 20 105 H XL A/S	2.2 / 32	-
---------------------------------	----------	---

Rear: 285/40 R 20 108 H XL A/S	-	2.2 / 32
--------------------------------	---	----------

Front: 255/45 R 20 105 Y XL	2.2 / 32	-
-----------------------------	----------	---

Rear: 285/40 R 20 108 Y XL	-	2.2 / 32
----------------------------	---	----------

Front: 255/40 R 21 102 Y XL	2.4 / 35	-
-----------------------------	----------	---

Rear: 285/35 R 21 105 Y XL	-	2.4 / 35
----------------------------	---	----------

Front: HL 255/35 R 22 102 Y XL	2.5 / 36	-
--------------------------------	----------	---

Rear: HL 285/30 R 22 104 Y XL	-	2.6 / 38
-------------------------------	---	----------

Front: 255/45 R 20 105 V XL M+S	2.2 / 32	-
---------------------------------	----------	---

Tire size	Pressure specifications in bar/PSI	
-----------	------------------------------------	--

Rear: 285/40 R 20 108 V XL M+S	-	2.2 / 32
--------------------------------	---	----------

Front: 255/40 R 21 102 H XL M+S	2.4 / 35	-
---------------------------------	----------	---

Rear: 285/35 R 21 105 H XL M+S	-	2.4 / 35
--------------------------------	---	----------

Emergency wheel: T 155/80 R 19 114 M	Speed up to a max. of 50 mph / 80 km/h	
--------------------------------------	--	--

	4.2 / 60	
--	----------	--

760i xDrive

Tire size	Pressure specifications in bar/PSI	
-----------	------------------------------------	--

Specifications in bar/PSI with cold tires

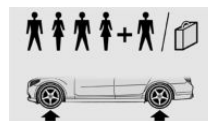

245/50 R 19 105 H XL M+S	2.4 / 35	2.5 / 36
--------------------------	----------	----------

245/50 R 19 105 W XL		
----------------------	--	--

Front: 255/45 R 20 105 H XL A/S	2.3 / 33	-
---------------------------------	----------	---

Rear: 285/40 R 20 108 H XL A/S	-	2.3 / 33
--------------------------------	---	----------

Front: 255/45 R 20 105 Y XL	2.3 / 33	-
-----------------------------	----------	---

Rear: 285/40 R 20 108 Y XL	-	2.3 / 33
----------------------------	---	----------

Front: 255/40 R 21 102 Y XL	2.5 / 36	-
-----------------------------	----------	---

Rear: 285/35 R 21 105 Y XL	-	2.5 / 36
----------------------------	---	----------

Tire size	Pressure specifications in bar/PSI	
Front: HL 255/35 R 22 102 Y XL	2.6 / 38	-
Rear: HL 285/30 R 22 104 Y XL	-	2.7 / 39
Front: 255/45 R 20 105 V XL M+S	2.3 / 33	-
Rear: 285/40 R 20 108 V XL M+S	-	2.3 / 33
Front: 255/40 R 21 102 H XL M+S	2.5 / 36	-
Rear: 285/35 R 21 105 H XL M+S	-	2.5 / 36
Emergency wheel:	Speed up to a max. of 50 mph / 80 km/h	
T 155/80 R 19 114 M	4.2 / 60	

Tire inflation pressures at maximum speeds above 100 mph/160 km/h

Warning

In order to drive at maximum speeds in excess of 100 mph/160 km/h, please observe and, if necessary, adjust tire pressures for speeds exceeding 100 mph/160 km/h from the relevant table on the following pages. Otherwise, tire damage and accidents could occur.

For speeds over 100 mph/160 km/h and for optimum driving comfort, note the pressure values in the tire inflation pressure table and adjust as necessary.

Tire pressure values over 100 mph/160 km/h

740i, 740i xDrive

Tire size	Pressure specifications in bar/PSI	
Specifications in bar/PSI with cold tires		
245/50 R 19 105 H XL A/S	2.4 / 35	2.7 / 39
245/50 R 19 105 H XL M+S		
245/50 R 19 105 W XL	2.6 / 38	3.1 / 45
Front: 255/45 R 20 105 H XL A/S	2.4 / 35	-
Rear: 285/40 R 20 108 H XL A/S	-	2.5 / 36
Front: 255/45 R 20 105 Y XL	2.4 / 35	-
Rear: 285/40 R 20 108 Y XL	-	2.5 / 36
Front: 255/40 R 21 102 Y XL	2.7 / 39	-
Rear: 285/35 R 21 105 Y XL	-	2.8 / 41
Front: HL 255/35 R 22 102 Y XL	2.8 / 41	-
Rear: HL 285/30 R 22 104 Y XL	-	2.9 / 42
Front: 255/45 R 20 105 V XL M+S	2.7 / 39	-

Tire size		Pressure specifications in bar/PSI	
Rear: 285/40 R 20 108 V XL M+S	-	2.8 / 41	
Front: 255/40 R 21 102 H XL M+S	2.7 / 39	-	
Rear: 285/35 R 21 105 H XL M+S	-	2.8 / 41	
Emergency wheel:	Speed up to a max. of 50 mph / 80 km/h		
T 155/80 R 19 114 M	4.2 / 60		

760i xDrive

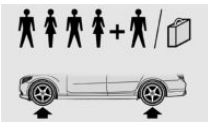
Tire size		Pressure specifications in bar/PSI	
Specifications in bar/PSI with cold tires			
245/50 R 19 105 H XL M+S	2.6 / 38	2.8 / 41	
245/50 R 19 105 W XL	2.9 / 42	3.2 / 46	
Front: 255/45 R 20 105 H XL A/S	2.6 / 38	-	
Rear: 285/40 R 20 108 H XL A/S	-	2.6 / 38	
Front: 255/45 R 20 105 Y XL	2.6 / 38	-	
Rear: 285/40 R 20 108 Y XL	-	2.6 / 38	
Front: 255/40 R 21 102 Y XL	2.9 / 42	-	
Rear: 285/35 R 21 105 Y XL	-	2.9 / 42	

Tire size		Pressure specifications in bar/PSI	
Front: HL 255/35 R 22 102 Y XL	2.9 / 42	-	
Rear: HL 285/30 R 22 104 Y XL	-	3.0 / 44	
Front: 255/45 R 20 105 V XL M+S	2.9 / 42	-	
Rear: 285/40 R 20 108 V XL M+S	-	2.9 / 42	
Front: 255/40 R 21 102 H XL M+S	2.9 / 42	-	
Rear: 285/35 R 21 105 H XL M+S	-	2.9 / 42	
Emergency wheel:	Speed up to a max. of 50 mph / 80 km/h		
T 155/80 R 19 114 M	4.2 / 60		

Tire marking

Tire size

245/45 R 18 96 Y

245: nominal width in mm

45: cross-sectional relationship in %

R: radial tire code

18: rim diameter in inches

96: load bearing capacity

Y: speed code letter

ZR tires: reinforced radial tire for speeds exceeding 150 mph/240 km/h

Maximum tire load

Maximum tire load is the maximum permissible weight for which the tire is approved.

Locate the maximum tire load on the tire sidewall and the Gross Axle Weight Rating – GAWR – on the certification label on the driver door B-pillar. Divide the tire load by 1.1. It must be greater than one-half of the vehicle's Gross Axle Weight Rating – GAWR. Note, front vs. rear GAWR and tire loads, respectively.

Speed letter

Designation	Maximum speed
Q	up to 100 mph/160 km/h
R	up to 106 mph/170 km/h
S	up to 112 mph/180 km/h
T	up to 118 mph/190 km/h
H	up to 131 mph/210 km/h
V	up to 150 mph/240 km/h
W	up to 167 mph/270 km/h
Y	up to 186 mph/300 km/h
(Y)	above 186 mph/300 km/h

Tire Identification Number

DOT Code: DOT xxxx xxx 1923

xxxx: manufacturer code for the tire brand

xxx: tire size and tire design

1923: tire age

Tires with DOT codes meet the guidelines of the U.S. Department of Transportation.

Tire age

Recommendation

Regardless of the tire tread depth, replace tires at least every 6 years.

Production date

You can find the tire production date on the tire sidewall.

Designation	Production date
DOT ... 1923	19th week of 2023

Uniform Tire Quality Grading

Quality grades can be found where applicable on the tire sidewall between tread shoulder and maximum section width.

E.g.: Treadwear 200; Traction AA; Temperature A

DOT Quality Grades

Treadwear

Traction AA A B C

Temperature A B C

All passenger vehicle tires must conform to Federal Safety Requirements in addition to these grades.

Treadwear

The treadwear grade is a comparative rating based on the wear rate of the tire when tested under controlled conditions on a specified government test course. E.g., a tire graded 150 would wear one and one-half, 1 g, times as well on the government course as a tire graded 100. The relative performance of tires depends upon the actual conditions of their use, however, and may depart significantly from the norm due to variations in driving habits, service practices and differences in road characteristics and climate.

Traction

The traction grades, from highest to lowest, are AA, A, B, and C.

Those grades represent the tire's ability to stop on wet pavement as measured under controlled conditions on specified government

test surfaces of asphalt and concrete. A tire marked C may have poor traction performance.

The traction grade assigned to this tire is based on straight-ahead braking traction tests, and does not include acceleration, cornering, hydroplaning, or peak traction characteristics.

Temperature

The temperature grades are A, the highest, B, and C, representing the tire's resistance to the generation of heat and its ability to dissipate heat when tested under controlled conditions on a specified indoor laboratory test wheel. Sustained high temperature can cause the material of the tire to degenerate and reduce tire life, and excessive temperature can lead to sudden tire failure. The grade C corresponds to a level of performance which all passenger car tires must meet under the Federal Motor Vehicle Safety Standard No. 109. Grades Band A represent higher levels of performance on the laboratory test wheel than the minimum required by law.

Warning

The temperature grade for this tire is established for a tire that is properly inflated and not overloaded. Excessive speed, underinflation, or excessive loading, either separately or in combination, can cause heat buildup and possible tire failure.

M+S

Winter tires, as well as all-season tires with better winter performance than summer tires, can be identified by the M+S marking on the tire side wall.

Tire tread

Safety information

Warning

If the tire tread depth is too low, driving safety may be impaired in critical situations such as aquaplaning or slush on the road. There is a risk of accident. The tire tread depth may not fall below 0.12 in/3 mm for summer tires and 0.16 in/4 mm for winter and all-season tires, or observe the statutory regulations on minimum tread depth.

Minimum tread depth



The tire manufacturer's wear indicators are distributed over the tire circumference. These indicators have a height of min. 0.06 in/1.6 mm and serve as an indicator for tire tread wear.

The positions of the wear indicators are marked on the tire sidewall with TWI, Tread Wear Indicator.

Tire damage

General information

Check your tires regularly for damage, foreign bodies lodged in the tread, and tread wear.

Indications of tire damage or another vehicle malfunction:

- ▷ Unusual vibrations.
- ▷ Unusual tire or running noises.
- ▷ Unusual handling such as a strong tendency to pull to the left or right.
- ▷ Uneven wear pattern, e.g., increased wear in the area of the tire shoulder.

Damage can be caused by the following situations, for instance:

- ▷ Driving over curbs.
- ▷ Road damage.
- ▷ Tire pressure too low.
- ▷ Vehicle overloading.
- ▷ Incorrect tire storage.

Safety information

Warning

Damaged tires can lose tire inflation pressure, which can lead to loss of vehicle control. There is a risk of accident. If tire damage is suspected while driving, immediately reduce speed and stop. Have wheels and tires checked. To do so, drive carefully to an authorized service center or another qualified service center or repair shop. Have the vehicle towed or transported as needed. Do not repair damaged tires, but have them replaced.

Warning

Driving over curbs, road damage or other obstacles can damage wheels, tires and chassis components. Larger wheels have a smaller tire cross-section. The smaller the tire cross-section, the higher the risk of tire damage. There may be a risk of accidents and risk of damage to property. If possible, avoid driving over curbs, road damage or other obstacles, or drive over them slowly and carefully.

Exchanging wheels and tires

Mounting and wheel balancing

Have the wheel mounted and balanced by an authorized service center or another qualified service center or repair shop.

Suitable wheels and tires

General information

Only certain wheel/tire combinations are suitable depending on vehicle and equipment. The vehicle manufacturer determines wheel/tire combinations on the basis of the following criteria:

- ▷ Tire size, e.g., tire width, aspect ratio.
- ▷ Wheel size, e.g., rim diameter, offset.

Ask an authorized service center or another qualified service center or repair shop about wheels and tires that are suitable for the vehicle as well as special equipment.

Safety information

Warning

Wheels and tires that are not suitable for the vehicle can damage parts of the vehicle. There is a risk of accident. The vehicle manufacturer recommends that you use only wheels and tires that have been recommended for the vehicle type.

Warning

Mounted steel wheels can cause technical problems, for instance unexpected loosening of the lug bolts and damage to the brake disks. There is a risk of accident. Do not mount steel wheels.

Warning

Wheel/tire combinations that are not suitable to the vehicle can impair vehicle handling and a number of system functions such as the Antilock Braking System or Dynamic Stability Control. There is a risk of accident. The manufacturer of the vehicle recommends that you use wheels and tires that have been recommended by the vehicle manufacturer for the vehicle type. Following tire damage, have the original wheel/tire combination remounted on the vehicle as soon as possible.

Recommended tire brands



Tire types are developed for each vehicle and optimized specifically for the individual requirements of that vehicle, e.g.:

- ▷ Handling.
- ▷ Comfort.
- ▷ Noise characteristics.

Specially developed tires are marked with a star on the tire sidewall. After replacing wheels and tires, the vehicle manufacturer recommends using star-marked tires again. The vehicle manufacturer recommends that you use tires of the same make and tread design.

New tires

Tire traction is not optimal due to manufacturing circumstances when tires are brand new.

Drive conservatively for the first 200 miles/300 km.

Retreaded tires

Warning

Retreaded tires can have different tire casing structures. With advanced age the service life can be limited. There is a risk of accident. The manufacturer of the vehicle does not recommend the use of retreaded tires.

Maximum speed

Safety information

Warning

If the maximum permissible speed of your mounted tires is exceeded, the tires may be damaged. There is a risk of accident. Do not exceed the maximum permissible speed of the tires.

Maximum speed of winter tires

If the maximum speed of the vehicle is higher than the maximum permissible speed of the winter tires, the maximum permissible speed must be indicated with a sign placed in the field of vision. The info label is available from an authorized service center or another qualified service center or repair shop.

Winter tires



Winter tires are recommended for operating on winter roads.

Winter tires can be identified by the mountain/snowflake icon and the letters M+S on the tire sidewall.

So-called all-season tires with M+S marking but without mountain and snowflake icon have better winter properties than summer tires. As a rule, all-season tires do not perform the same as winter tires.

Wheel change between axles

Warning

A wheel change between the axles on vehicles with different tire sizes or rim sizes on the front and rear axles can cause damage to the tires and the vehicle. There is a risk of accident. Do not rotate the tires between the axles on vehicles with different tire sizes or rim sizes on the front and rear axles.

Different abrasion patterns can occur on the front and rear axles depending on individual driving conditions. The tires can be rotated in pairs between the axles to achieve even abrasion. For more information, contact an authorized service center or another qualified service center or repair shop. After changing, check the tire pressure and correct, if needed.

Storing tires

Tire pressure

Do not exceed the maximum tire inflation pressure indicated on the tire sidewall.

Storage

- ▶ Store wheels and tires in a cool, dry and dark place.
- ▶ Always protect tires against all contact with oil, grease, and solvents.
- ▶ Do not leave the tires in plastic bags.
- ▶ Remove dirt from wheels or tires.

Repairing a flat tire

Safety precautions

- ▶ Park the vehicle on solid and non-slip ground at a safe distance from road traffic.
- ▶ Turn on the hazard warning system.
- ▶ Set the parking brake.
- ▶ Turn the steering wheel until the front wheels are in the straight-ahead position and engage the steering wheel lock.
- ▶ As soon as permitted by the traffic flow, have all vehicle occupants get out and make sure that they remain outside the hazardous area such as behind a guardrail.
- ▶ If necessary, set up the hazard triangle or hazard warning lights at an appropriate distance.

Tire repair set

Principle

With the tire repair set, minor tire damage can be sealed temporarily to enable continued driving.

General information

- ▶ The filled in tire sealant closes the damage from the inside when it hardens.
- ▶ Follow the instructions on using the tire repair set found on the compressor and sealant bottle.
- ▶ The use of a tire repair set can be ineffective if the tire puncture measures above approx. 0.16 in/4 mm.
- ▶ Do not remove foreign objects that have penetrated the tire. Remove foreign objects only when they are visibly protruding from the tire.
- ▶ The compressor can be used to check the tire inflation pressure.

Overview

Storage

Depending on the equipment, storage for the tire repair set is provided as follows:

- ▶ In the cargo area under the cargo floor panel.
- ▶ In the cargo area on the left or right side.
- ▶ In the cargo area behind a side trim panel.

Sealant bottle and filler hose

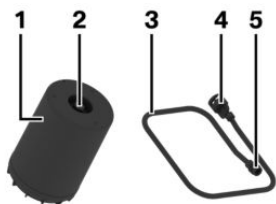

- 1 Sealant bottle
- 2 Sealant bottle outlet
- 3 Filler hose
- 4 Sealant bottle connection
- 5 Wheel valve connection

Compressor



- 1 Compressor
- 2 Tire pressure display
- 3 Pressure reducing valve button
- 4 Sealant bottle mount

- 5 Connector for socket
- 6 Power switch

Safety precautions

- ▶ Park the vehicle as far away as possible from passing traffic and on solid ground.
- ▶ Turn on the hazard warning system.
- ▶ Set the parking brake.
- ▶ Turn the steering wheel until the front wheels are in the straight-ahead position and engage the steering wheel lock.
- ▶ As soon as permitted by the traffic flow, have all vehicle occupants get out and make sure that they remain outside the hazardous area such as behind a guardrail.
- ▶ If necessary, set up the hazard triangle or hazard warning lights at an appropriate distance.
- ▶ Remove the warning label for maximum permissible speed from the compressor and attach it in a visible location in the vehicle interior.
- ▶ Remove the warning label from the sealant bottle and stick it to the rim.

Preparing the tire repair set

1. Insert the sealant bottle into the mount on the housing of the compressor.

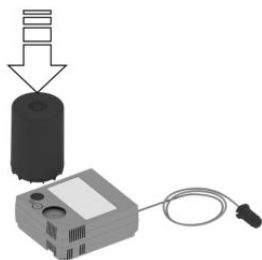

2. Turn the sealant bottle clockwise by 90° to the stop.

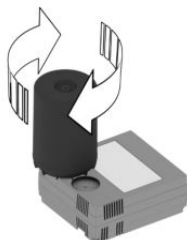

3. Connect the filler hose to the outlet of the sealant bottle and turn clockwise by 90° to the stop.



4. Unscrew the valve cap from the wheel and screw the connecting piece of the filler hose onto the valve.

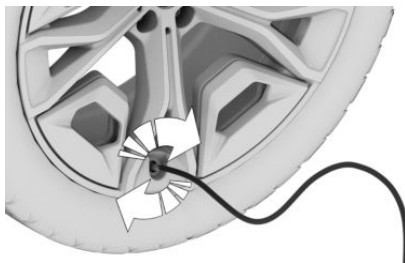

5. With the compressor switched off, insert the connector into the power socket in the vehicle interior.

Filling the tire with sealing compound

Safety information

DANGER

If the exhaust pipe is blocked or ventilation is insufficient, harmful exhaust gases can penetrate the vehicle. The exhaust gases contain pollutants which are colorless and odorless. In enclosed areas, exhaust gases can also accumulate outside of the vehicle. There is a danger to life. Keep the exhaust pipe free and ensure sufficient ventilation.

NOTICE

The compressor can overheat during extended operation. There is a risk of damage to property. Do not run the compressor for more than 10 minutes.

Filling the tire with sealing compound

1. With standby state or drive-ready state switched on, switch on the compressor.

Let the compressor run for max. 10 minutes to fill in the tire sealant and reach a tire pressure of 2.5 bar/36 psi.

While the tire is being filled with tire sealant, the tire pressure can briefly reach approx. 6 bar/87 psi. Do not turn off the compressor in this phase.



2. Switch off the compressor.

Checking the tire pressure

Read the tire pressure on the tire pressure display of the compressor. The tire pressure must be at least 2.5 bar/36 psi.

Tire pressure too high

If the tire pressure is too high, reduce the tire pressure with the pressure reducing valve on the compressor.

Minimum tire inflation pressure is not reached

Do not continue driving unless a minimum tire pressure of 2.5 bar/36 psi is reached. Contact an authorized service center or another qualified service center or repair shop.

Minimum tire inflation pressure is reached

1. Pull the connector out of the socket in the vehicle interior.
2. Disconnect the hose from the sealant bottle and the valve on the wheel.
3. Screw the valve cap onto the valve.

4. Stow the tire repair set in the cargo area.
5. Immediately drive 5 miles/10 km to ensure that the tire sealant is evenly distributed in the tire.

Do not exceed the speed limit of 50 mph/80 km/h.

If possible, do not drive at speeds less than 12 mph/20 km/h.

Tire sealant may spray from the damaged area during the initial wheel rotations.

Adjusting the tire pressure

1. Stop at a suitable location.
2. Connect the hose directly to the compressor and turn clockwise by 90° until it audibly engages.



3. Unscrew the valve cap from the wheel and screw the connecting piece of the hose onto the valve.

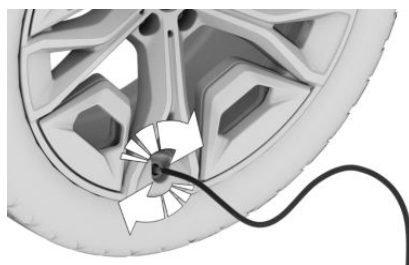

4. Insert the connector into the socket in the vehicle interior.
5. Read the tire pressure on the tire pressure display of the compressor.

Do not continue driving unless a minimum tire pressure of 1.3 bar/19 psi is displayed. Contact an authorized service center or another qualified service center or repair shop.

6. Correct the tire pressure to 2.5 bar/36 psi.
 - ▶ Increase tire pressure: with standby or drive-ready state turned on, turn on the compressor and let it run for a maximum of 10 minutes.
 - ▶ Reduce tire pressure: Press the pressure reducing valve button on the compressor.

Remove and stow the tire repair set

1. Switch off the compressor.
2. Pull the connector out of the socket in the vehicle interior.
3. Disconnect the hose from the compressor and the valve on the wheel.
4. Screw the valve cap onto the valve.
5. Stow the tire repair set in the cargo area.

Continuing the trip

Do not exceed the speed limit of 50 mph/80 km/h.

Do not exceed a maximum distance travelled of 125 miles/200 km.

Re-initialize the flat tire monitor or reset the Tire Pressure Monitor.

Replace the faulty tire and the sealant bottle of the tire repair set promptly.

Additional information:

- ▶ Flat tire monitor, refer to page [341](#).
- ▶ Tire pressure monitor, refer to page [334](#).

System limits

If the tire cannot be made drivable, contact an authorized service center or another qualified service center or repair shop.

With Tire Pressure Monitor: Using sealant can damage the air pressure sensor. In this case,

have the electronics checked and replaced at the next opportunity.

Snow chains

Safety information

Warning

Mounting snow chains on unsuitable tires can cause the snow chains to come into contact with vehicle parts. There may be a risk of accidents or risk of damage to property. Only fit snow chains on tires recommended by the vehicle manufacturer for use with snow chains.

Warning

Insufficiently tight snow chains may damage tires and vehicle components. There may be a risk of accidents or risk of damage to property. Make sure that the snow chains are always sufficiently tight. Re-tighten as needed according to the snow chain manufacturer's instructions.

Fine-link snow chains

The manufacturer of the vehicle recommends the use of fine-link snow chains. Certain types of fine-link snow chains have been tested by the manufacturer of the vehicle and recommended as road-safe and suitable.

For information on suitable snow chains, contact an authorized service center or another qualified service center or repair shop.

Use

Use is only permitted in pairs on rear wheels equipped with the tires of the following wheel/tire sizes:

Tire size	Wheel size	Rim offset (IS)
245/50 R19	8.5J x 19	26

Information on the wheel size and rim offset is located on the inside of the wheel.

The list can also include wheel/tire sizes that are only suitable for certain models.

Information on wheels and tires approved for the vehicle can be requested from an authorized service center or another qualified service center or repair shop.

Follow the snow chain manufacturer's instructions.

If vehicle is equipped with Tire Pressure Monitor: When using snow chains, do not reset the Tire Pressure Monitor, otherwise, incorrect values may be displayed.

If vehicle is equipped with flat tire monitor: When using snow chains, do not initialize the flat tire monitor, otherwise, incorrect values may be displayed.

When driving with snow chains, activate the drive-off support to optimize the drive power.

Maximum speed with snow chains

Do not exceed a speed of 30 mph/50 km/h when using snow chains.

Rear axle steering during operation with snow chains

General information

In order to guarantee free movement of the wheels when operating with snow chains, rear axle steering must be turned off when snow chains are mounted.

Rear-wheel steering is switched on again automatically when the permitted maximum speed for snow chains is exceeded: 30 mph/50 km/h.

The setting for equipped snow chains can only be used below 30 mph/50 km/h.

Safety information

Warning

When rear axle steering is switched on and snow chains are mounted, there can be contact between snow chains and the body. There may be a risk of accidents or risk of damage to property. With mounted snow chains, switch off the rear axle steering.

Switching off rear axle steering

The rear axle steering is switched off by specifying that snow chains are installed.

1.  Apps menu
2. "Vehicle"
3. "Driving settings"
4. "Drivetrain and chassis"
5. "Snow chains"

Tire pressure monitor

Principle

The Tire Pressure Monitor monitors the tire pressure and issues a warning if the tire pressure has dropped.

General information

Sensors in the tire valves measure the tire inflation pressure and tire temperature.

Depending on the tires detected or registered, the system displays the specified nominal pressures on the control display and compares them with the current tire pressures.

If tires are being used that are not specified in the tire inflation pressure details on the vehicle such as tires with special approval, the system needs to be actively reset. The system will then take over the actual tire inflation pressures as the target pressures.

When operating the system, also note the information found in the Tire inflation pressure chapter.

Additional information:

Tire inflation pressure, refer to page [320](#).

Safety information

Warning

The display of the target pressures is not a substitute for the tire inflation pressure details on the vehicle. Incorrect entries in the tire settings can lead to incorrect target tire inflation pressure values. In this case, it cannot be guaranteed that the notification of a tire pressure loss will be reliable. There is a risk of injury and risk of damage to property. Make sure that the sizes of your mounted tires are displayed correctly and match the information on the tires and the tire inflation pressure specifications on the vehicle.

Functional requirements

The following prerequisites must be met for the system; otherwise, reliable notification of a tire pressure loss is not assured:

- ▶ After each tire or wheel change, the system detects and updates the mounted tires on the control display and displays them after a short trip.

Enter the information about the mounted tires in the tire settings when the system does not automatically detect the tires.

- ▶ The Tire Pressure Monitor does not activate until after driving for a few minutes:
 - ▶ After a tire or wheel change.
 - ▶ After a reset, when using tires with special approval.
 - ▶ After changing the tire setting.
- ▶ For tires with special approval:

- ▶ After a tire or wheel change, a reset was performed with the correct tire inflation pressure.
- ▶ After the tire inflation pressure was adjusted to a new value, a reset was performed.
- ▶ Wheels with air pressure sensor.

Tire settings

General information

The information about the mounted tires can be entered in the tire settings if the system does not automatically detect the tires.

The tire sizes of the mounted tires can be gathered from the tire inflation pressure details on the vehicle or directly on the tires.

The tire details do not need to be re-entered when the tire pressure is corrected.

For summer and winter tires, the tire details entered last are stored. After a tire or wheel change, the settings of the tire sets used last can be selected.

Adjusting the tires

1.  Apps menu
2. "Vehicle"
3. "Vehicle status"
4. "Tire Pressure Monitor"
5. "Tire settings"
6. "Tire selection"
7. "Manual"
8. "Tire type"
9. Select the tire size for the rear axle.
For tires with special approval:
"Other tires"
Observe further proceeding in the perform a reset section.
10. Select the maximum speed to be driven.
11. "Save tire settings"

The measurement of the current tire inflation pressure is started. The measurement progress is displayed.

Status display

Current status

The system status can be displayed on the control display, e.g., whether or not the system is active.

1.  Apps menu
2. "Vehicle"
3. "Vehicle status"
4. "Tire Pressure Monitor"

The current status is displayed.

Current tire pressure

The current tire pressure is displayed for each tire.

The current tire inflation pressures may change while driving or depending on the outside temperature.

Current tire temperature

The current tire temperatures are displayed depending on the model.

The current tire temperatures may change while driving or due to the outside temperature.

Nominal pressure

The nominal pressure for the tires on the front and rear axles is displayed.

The specified nominal pressures take the influence of driving and outside temperature on the tire temperature into account. The appropriate nominal pressure is always displayed, independent of the weather situation, tire temperatures and travel times.

The displayed nominal pressure may change and may differ from the tire inflation pressure details on the door pillar of the driver's door.

The tire inflation pressure can thus be corrected to the value of the displayed target pressures.

The nominal pressure is immediately adjusted if the vehicle load status is changed in the tire settings.

Tire conditions

General information

Tire and system status are indicated by the color of the wheels and a text message on the control display.

Any existing messages may not be deleted if the nominal pressure is not reached after the tire inflation pressure is corrected.

All wheels green

- ▶ The system is active and bases warnings on the target pressures.
- ▶ For tires with special approval: the system is active and bases warnings on the tire inflation pressures stored during the last reset.

One to four yellow wheels

A flat tire or major tire pressure loss has occurred in the indicated tires.

Gray wheels

It may not be possible to identify tire pressure losses.

Possible causes:

- ▶ Malfunction.
- ▶ During tire inflation pressure measurement, after confirmation of the tire settings.
- ▶ For tires with special approval: a reset is performed for the system.

For tires with special approval: performing a reset

1.  Apps menu
2. "Vehicle"
3. "Vehicle status"
4. "Tire Pressure Monitor"
5. Make sure that the tire settings are correct.
Tire settings, refer to page [335](#).
6. Turn on drive-ready state and do not drive off.
7. Reset tire pressure: "Perform reset".
8. Drive off.

The wheels are displayed in gray and the following is displayed: "Resetting tire pressure...".

After a travel time of several minutes, the set tire inflation pressures are accepted as the predefined tire inflation pressures. The reset is completed automatically while driving.

After a successfully completed reset, the wheels on the control display are shown in green and the following is displayed: "Reset successful."

You may interrupt this trip at any time. When you continue driving the reset resumes automatically.

Messages: for tires without special approval

General information

When a flat tire is indicated, the Dynamic Stability Control may be turned on.

Safety information

Warning

A damaged regular tire with low or no tire inflation pressure impacts handling such as steering and braking response. There is a risk of accident. Do not continue driving. Repair the flat tire or replace the wheel.

With recommended tire pressure test

Message

An icon with service information is shown on the control display and, if necessary, in the My BMW App.

Icon	Possible cause
	Leak detected on the tire.

Measure

Check the tire pressure and correct as needed.

If a tire inflation pressure check is required

Message

An icon with a Check Control message appears on the control display.

Icon	Possible cause
	Inflation was not carried out according to specifications, for instance when the tire has not been sufficiently inflated or in the case of a natural steady tire pressure loss.

Measure

Check the tire pressure and correct as needed.

If the tire inflation pressure is too low

Message



A yellow warning light is illuminated in the instrument cluster.

In addition, an icon with a Check Control message appears on the control display.

Icon	Possible cause
------	----------------



There is a tire pressure loss.

Measure

1. Reduce the vehicle speed. Do not exceed a speed of 80 mph/130 km/h.
2. At the next opportunity, for instance at a filling station, check the tire inflation pressure in all four tires and correct if necessary.

If there is a significant tire pressure loss

Message



A yellow warning light is illuminated in the instrument cluster.

In addition, an icon with the affected tire appears in a Check Control message on the control display.

Icon	Possible cause
------	----------------



There is a flat tire or a major tire pressure loss.

Measure

1. Reduce your speed and stop cautiously. Avoid sudden braking and steering maneuvers.
2. Read the description on what to do in case of a flat tire.

Actions in the event of a flat tire, refer to page 339.

Messages: for tires with special approval

General information

When a flat tire is indicated, the Dynamic Stability Control may be turned on.

Safety information

Warning

A damaged regular tire with low or no tire inflation pressure impacts handling such as steering and braking response. There is a risk of accident. Do not continue driving. Repair the flat tire or replace the wheel.

If a tire inflation pressure check is required

Message

An icon with a Check Control message appears on the control display.

Icon	Possible cause
------	----------------



Inflation was not carried out according to specifications, e.g., the tire has not been sufficiently inflated.

The system has detected a wheel change, but no reset was done.

The tire inflation pressure has fallen below the level of the last reset.

No reset was performed for the system. The system issues a warning based on the tire inflation pressures stored during the last reset.

Measure

1. Check the tire pressure and correct as needed.
2. Perform a system reset.

If the tire inflation pressure is too low

Message



A yellow warning light is illuminated in the instrument cluster.

In addition, an icon with a Check Control message appears on the control display.

Icon	Possible cause
------	----------------



There is a tire pressure loss.

No reset was performed for the system. The system issues a warning based on the tire inflation pressures stored during the last reset.

Measure

1. Reduce the vehicle speed. Do not exceed a speed of 80 mph/130 km/h.
2. At the next opportunity, for instance at a filling station, check the tire inflation pressure in all four tires and correct if necessary.
3. Perform a system reset.

If there is a significant tire pressure loss

Message



A yellow warning light is illuminated in the instrument cluster.

In addition, an icon with the affected tire appears in a Check Control message on the control display.

Icon	Possible cause
------	----------------



There is a flat tire or a major tire pressure loss.

No reset was performed for the system. The system issues a warning based on the tire inflation pressures stored during the last reset.

Measure

1. Reduce your speed and stop cautiously. Avoid sudden braking and steering maneuvers.
2. Read the description on what to do in case of a flat tire.

Actions in the event of a flat tire, refer to page 339.

Actions in the event of a flat tire

1. Identify the damaged tire.

Check the tire pressure in all four tires, for instance using the tire pressure display from a tire repair set.

For tires with special approval: when the tire pressure in all four tires is correct, the Tire Pressure Monitor may not have been reset. In this case, perform the reset.

If no tire damage can be identified, contact an authorized service center or another qualified service center or repair shop.

2. Repair the flat tire, for instance with a tire repair set or by changing the wheel.

Using a sealing compound, for instance from the tire repair set, may damage the wheel electronics. Have the electronics replaced at the next opportunity.

System limits

Temperature

The tire inflation pressure depends on the tire's temperature.

Driving or exposure to the sun will increase the tire temperature, thus increasing the tire inflation pressure.

The tire inflation pressure is reduced when the tire temperature falls again.

These circumstances may cause a warning when temperatures fall very sharply.

Following a temperature-related warning, the target pressures are displayed on the control display again after a short distance.

Sudden tire pressure loss

The system cannot indicate sudden and serious tire damage caused by external circumstances.

Failure performing a reset

Tires with special approval: the system will not function correctly if a reset was not performed, for example a flat tire may be indicated although the tire inflation pressures are correct.

Malfunction

Message



The yellow warning light flashes and is then illuminated continuously. A Check Control message is displayed. It may not be possible to identify tire pressure losses.

Measure

- ▷ A wheel without air pressure sensor is mounted: Have the wheels checked as needed.
- ▷ Fault caused by systems or devices with the same transmission frequency: The system automatically reactivates after leaving the area of the interference.

- ▷ For tires with special approval: the system was unable to complete the reset. Perform a system reset again.
- ▷ If the Tire Pressure Monitor malfunctions: Have the vehicle checked by an authorized service center or another qualified service center or repair shop.

Declaration according to NHTSA/ FMVSS 138 Tire Pressure Monitoring System

Each tire, including the spare (if provided) should be checked monthly when cold and inflated to the inflation pressure recommended by the vehicle manufacturer on the vehicle placard or tire inflation pressure label. (If the vehicle has tires of a different size than the size indicated on the vehicle placard or tire inflation pressure label, you should determine the proper tire inflation pressure for those tires.) As an added safety feature, the vehicle has been equipped with a tire pressure monitoring system (TPMS) that illuminates a low tire pressure telltale when one or more of your tires is significantly under-inflated. Accordingly, when the low tire pressure telltale illuminates, you should stop and check your tires as soon as possible, and inflate them to the proper pressure. Driving on a significantly under-inflated tire causes the tire to overheat and can lead to tire failure. Under-inflation also reduces fuel efficiency and tire tread life, and may affect the vehicle's handling and stopping ability. Please note that the TPMS is not a substitute for proper tire maintenance, and it is the driver's responsibility to maintain correct tire pressure, even if under-inflation has not reached the level to trigger illumination of the TPMS low tire pressure telltale. The vehicle has also been equipped with a TPMS malfunction indicator to indicate when the system is not operating properly. The TPMS malfunction indicator is combined with the low tire pressure telltale. When the system detects a malfunction, the telltale will flash for approximately one minute and then remain continuously il-

illuminated. This sequence will continue upon subsequent vehicle start-ups as long as the malfunction exists. When the malfunction indicator is illuminated, the system may not be able to detect or signal low tire pressure as intended. TPMS malfunctions may occur for a variety of reasons, including the installation of replacement or alternate tires or wheels on the vehicle that prevent the TPMS from functioning properly. Always check the TPMS malfunction telltale after replacing one or more tires or wheels on the vehicle to ensure that the replacement or alternate tires and wheels allow the TPMS to continue to function properly.

Flat tire monitor

Principle

The flat tire monitor detects a tire pressure loss while driving and issues a warning if the tire pressure has dropped.

General information

The system detects tire pressure loss on the basis of rotation speed differences between the individual wheels while driving.

In the event of a tire pressure loss, the diameter and therefore the rotational speed of the corresponding wheel changes. The difference will be detected and reported as a flat tire.

The system does not measure the actual inflation pressure in the tires.

Functional requirements

The following prerequisites must be met for the system; otherwise, reliable notification of a tire pressure loss is not assured:

- ▶ After a tire or wheel change, an initialization was carried out at the correct tire pressure.
- ▶ After the tire pressure was adjusted to a new value, an initialization was performed.

Status display

The current status of the flat tire monitor can be displayed, e.g., whether the flat tire monitor is active.

1.  Apps menu
2. "Vehicle"
3. "Vehicle status"
4. "FLAT TIRE MONITOR"

The status is displayed.

Initialization required

An initialization must be performed in the following situations:

- ▶ After the tire inflation pressure has been adjusted.
- ▶ After a tire or wheel change.

Performing initialization

When initializing, the set tire inflation pressures serve as reference values in order to detect a flat tire. Initialization is started by confirming the tire inflation pressures.

Do not initialize the system when driving with snow chains.

1.  Apps menu
2. "Vehicle"
3. "Vehicle status"
4. "FLAT TIRE MONITOR"
5. Turn on drive-ready state and do not drive off.
6. Start the initialization with: "Perform reset"
7. Drive off.

The initialization is completed while driving, which can be interrupted at any time.

The initialization automatically continues when driving continues.

Messages

General information

When a flat tire is indicated, the Dynamic Stability Control (DSC) is turned on, if needed.

Safety information

Warning

A damaged regular tire with low or no tire inflation pressure impacts handling such as steering and braking response. There is a risk of accident. Do not continue driving. Repair the flat tire or replace the wheel.

Indication of a flat tire



A yellow warning light is illuminated in the instrument cluster.

In addition, an icon with a Check Control message appears on the control display.

Icon	Possible cause
	There is a flat tire or a major tire pressure loss.



Measure

1. Reduce your speed and stop cautiously. Avoid sudden braking and steering maneuvers.
2. Read the description on what to do in case of a flat tire.

Actions in the event of a flat tire

1. Identify the damaged tire.

To do this, check the tire pressure in all four tires, for instance using the tire pressure display from a tire repair set.

When the tire inflation pressure in all four tires is correct, the flat tire monitor may not

have been initialized. In this case, initialize the system.

If tire damage cannot be identified, contact an authorized service center or another qualified service center or repair shop.

2. Repair the flat tire, for instance with a tire repair set or by changing the wheel.

System limits

The system may be delayed or malfunction in the following situations:

- ▷ A natural, even tire pressure loss in all four tires will not be recognized. Therefore, check the tire inflation pressure regularly.
- ▷ Sudden and serious tire damage caused by external circumstances cannot be recognized in advance.
- ▷ The system has not been initialized.
- ▷ When driving on a snowy or slippery road.
- ▷ Sporty driving style: slip on traction wheels, high lateral acceleration (drifting).
- ▷ When driving with snow chains.

Changing wheels/tires

General information

When a tire repair set is used, the wheel does not always need to be changed immediately in the event of a breakdown when there is tire pressure loss.

If necessary, a suitable wheel change tool, e.g., a jack, is available as an accessory from an authorized service center or another qualified service center or repair shop.

Safety information

Warning

The jack is only provided for short-term lifting of the vehicle for wheel changes. Even if all safety precautions are observed, there is a risk of the raised vehicle falling if the jack tips over. There is a risk of injury or danger to life. When the vehicle is raised with the jack, do not lie under the vehicle and do not switch on the drive-ready state.

Warning

Placing supports, e.g., wooden blocks or similar, under the jack may reduce its ability to bear weight because of the limited height. The load-carrying capacity of the wooden blocks may be exceeded and the vehicle may tip over. There is a risk of injury or danger to life. Do not place supports under the jack.

Warning

The jack, issued by the vehicle manufacturer, is provided in order to perform a wheel change in the event of a breakdown. The jack is not designed for frequent use, e.g., changing from summer to winter tires. Using the jack frequently may cause it to become jammed or damaged. There is a risk of injury and risk of damage to property. Only use the jack to change an emergency or spare wheel in the event of a breakdown.

Warning

The jack may slip on soft, uneven, or slippery ground, e.g., snow, ice, tiles, etc. There is a risk of injury. If possible, change the wheel on a flat, solid, slip-resistant surface.

Warning

The jack is optimized for lifting the vehicle and for the jacking points on the vehicle only. There is a risk of injury. Do not lift any other vehicle or cargo using the jack.

Warning

When the jack is not inserted into the jacking point provided for this purpose, the vehicle may be damaged or the jack may slip when it is being cranked up. There is a risk of injury or risk of damage to property. When cranking up the jack, ensure that it is inserted in the jacking point next to the wheel well.

Warning

A vehicle that is raised on a jack may fall off of the jack if lateral forces are exerted on it. There is a risk of injury and risk of damage to property. While the vehicle is raised, do not exert lateral effort on the vehicle or pull abruptly on the vehicle. Have a stuck wheel removed by an authorized service center or another qualified service center or repair shop.

NOTICE

Using an impact wrench to loosen or tighten the wheel lock bolt can damage the wheel lock bolt. There is a risk of damage to property. Only use a lug wrench to loosen and tighten the wheel lock bolt.

Securing the vehicle against rolling away

General information

The vehicle manufacturer recommends to additionally secure the vehicle against rolling away when changing a wheel.

On a level surface



Place wheel chocks or other suitable objects in front and behind the wheel that is diagonal to the wheel to be changed.

On a slight downhill gradient



If you need to change a wheel on a slight downhill grade, place chocks and other suitable objects, for instance rocks, under the proper side of the wheels of both the front and rear axles to block the car from rolling downhill.

Lug bolt lock

Principle

The wheel lug bolts have a special coding. The lug bolts can only be released with the adapter which matches the coding.

Overview

The adapter of the lug bolt lock is in the on-board vehicle tool kit or in a storage compartment close to the onboard vehicle tool kit.

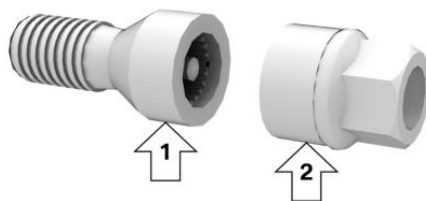

- ▷ Lug lock bolt, arrow 1.
- ▷ Adapter, arrow 2.

Unscrewing

1. Attach the adapter to the lug lock bolt.
2. Unscrew the lug lock bolt.
3. Remove the adapter after unscrewing the lug bolt.

Screwing on

1. Attach the adapter to the lug lock bolt. If necessary, turn the adapter until it fits on the wheel lug bolt.
2. Screw on the lug lock bolt. The tightening torque is 101 lbs ft/140 Nm.
3. Remove the adapter and stow it after screwing on the lug bolt.

Safety precautions

- ▷ Park the vehicle on solid and non-slip ground at a safe distance from road traffic.
- ▷ Turn on the hazard warning system.
- ▷ Set the parking brake.
- ▷ Turn the steering wheel until the front wheels are in the straight-ahead position and engage the steering wheel lock.
- ▷ Engage a gear or move the selector lever to position P.
- ▷ As soon as permitted by the traffic flow, have all vehicle occupants get out and make sure that they remain outside the hazardous area such as behind a guardrail.
- ▷ If necessary, set up the hazard triangle or hazard warning lights at an appropriate distance.
- ▷ Depending on vehicle equipment, remove the wheel change set and, if necessary, the emergency wheel from the vehicle.
- ▷ Secure the vehicle additionally against rolling away.
- ▷ Loosen the lug bolts a half turn.
- ▷ For air suspension: disable the air suspension level adjustment.
Two-axle ride level control, refer to page 271.

Jacking points

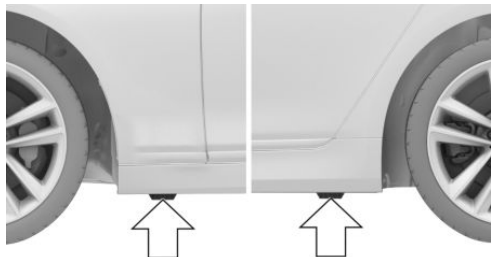

The jacking points are located at the indicated positions.

Jacking up the vehicle

Warning

Hands and fingers can be jammed when using the jack. There is a risk of injury. Comply with the described hand position and do not change this position while using the jack.

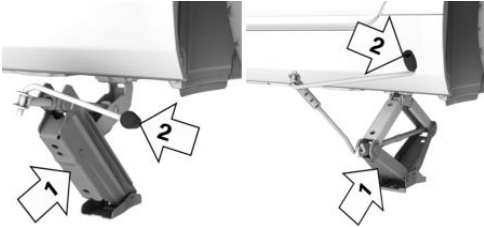
1. Hold the vehicle jack with one hand, arrow 1, and grasp the jack crank handle or lever with your other hand, arrow 2.
- 
2. Insert the jack into the rectangular recess of the jacking point closest to the wheel to be changed.

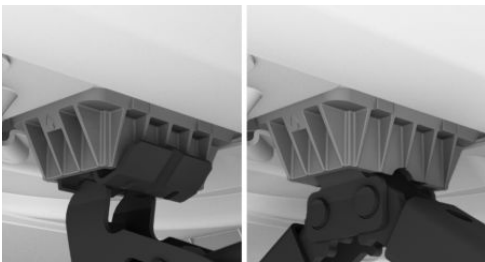

3. Extend the jack by turning the jack crank handle or lever clockwise.



- Take your hand away from the jack as soon as the jack is under load and continue turning the jack crank handle or lever with one hand.
- Make sure that the car jack foot extends vertically and is at a right angle beneath the jacking point.

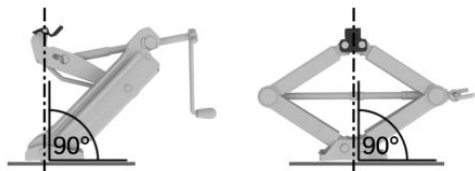

- Crank the vehicle up until the entire jack surface is on the ground and the corresponding wheel is lifted max. 1.2 inches/3 cm above the ground.

Mounting a wheel

Mount one emergency wheel only, as required.

- Unscrew the lug bolts.
- Remove the wheel.
- Put the new wheel or emergency wheel on and screw in at least two lug bolts in a crosswise pattern until hand-tight.

When non-original light-alloy wheels of the vehicle manufacturer are mounted, the accompanying lug bolts may have to be used as well.

- Hand-tighten the remaining lug bolts and tighten all lug bolts well in a crosswise pattern.
- Turn the jack crank handle counterclockwise to retract the jack and lower the vehicle.
- Remove the jack and stow it securely.

After the wheel change

- Tighten the lug bolts crosswise. The tightening torque is 101 lbs ft/140 Nm.
- Stow the faulty wheel in the cargo area, if necessary.
- Check tire inflation pressure at the next opportunity and correct as needed.
- Re-initialize the flat tire monitor or reset the Tire Pressure Monitor.
- Check to make sure the lug bolts are tight with a calibrated torque wrench.
- Drive to the nearest authorized service center or another qualified service center or repair shop, then have the damaged tire replaced.

Emergency wheel

Principle

In the event of a flat tire, the emergency wheel can be used in place of the wheel with the faulty tire. The emergency wheel is only intended for temporary use until the faulty tire/wheel has been replaced.

General information

Mount one emergency wheel only.

Also check the tire inflation pressure of the emergency wheel in the cargo area regularly, and correct it as needed.

Safety information

Warning

The emergency wheel has particular dimensions. When driving with an emergency wheel, changed driving properties may occur, for instance reduced directional stability when braking, longer braking distance, and changed self-steering properties in the limit range. There is a risk of accident. Drive

moderately and do not exceed a speed of 50 mph/80 km/h.

Overview

The emergency wheel and wheel change set are located in a bag in the cargo area.

Removing the emergency wheel

1. Loosen the strap at the buckles.
2. Detach the snap hooks of the tensioning straps at the lashing eyes.
3. Remove the bag containing the emergency spare wheel and wheel change set from the cargo area.
4. Open the bag, then remove the spare wheel and wheel change set.

Inserting the emergency wheel

1. Stow the emergency spare wheel and wheel change set in the bag.
2. Place the bag in the cargo area.
3. Attach the snap hooks of the tensioning straps at the lashing eyes.
4. Fasten the tensioning straps. Make sure that it is correctly and firmly seated.

Engine compartment

Vehicle features and options

This chapter describes model-specific equipment, systems, and functions that are currently

available, or may become available in the future, even if they are not present in the vehicle.

Additional information:

Vehicle equipment, refer to page 8.

Overview

6-cylinder engine

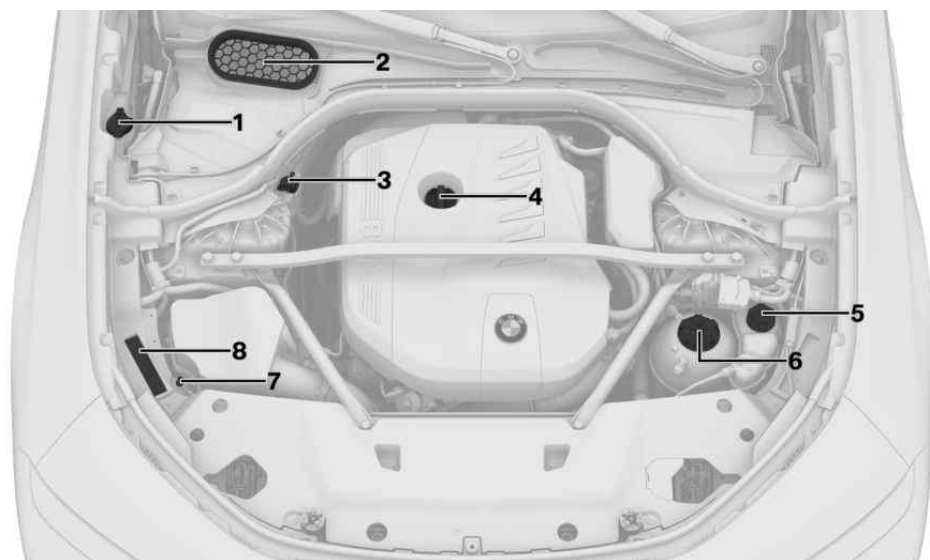

- | | | | |
|---|--|---|--|
| 1 | Filler neck for washer fluid | 5 | Coolant reservoir, auxiliary cooling |
| 2 | Fresh air intake | 6 | Coolant reservoir, engine |
| 3 | Jump-starting, positive battery terminal | 7 | Jump-starting, negative battery terminal |
| 4 | Oil filler neck | 8 | Vehicle identification number |

8-cylinder engine

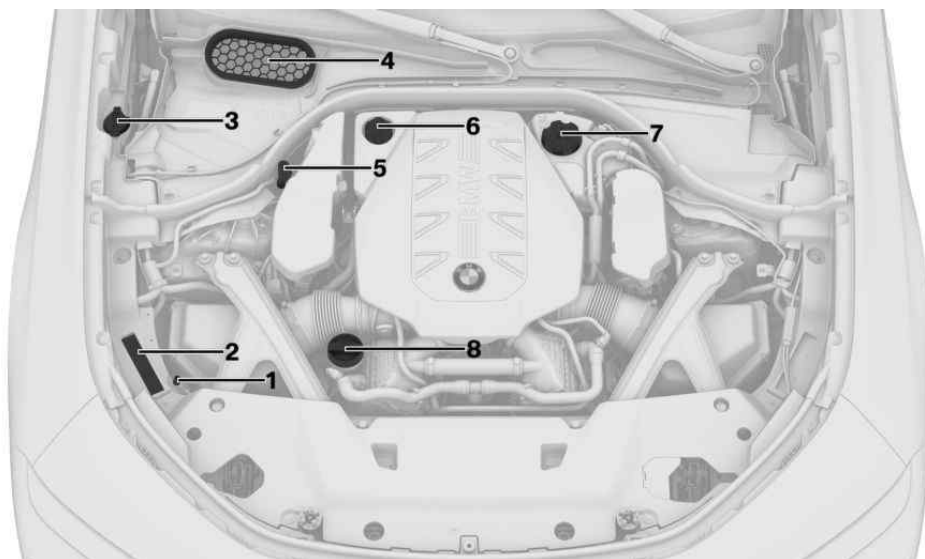

- | | |
|--|---|
| <p>1 Jump-starting, negative battery terminal</p> <p>2 Vehicle identification number</p> <p>3 Filler neck for washer fluid</p> <p>4 Fresh air intake</p> | <p>5 Jump-starting, positive battery terminal</p> <p>6 Coolant reservoir, auxiliary cooling</p> <p>7 Coolant reservoir, engine</p> <p>8 Oil filler neck</p> |
|--|---|

Hood

Safety information

Warning

Improperly executed work in the engine compartment can damage vehicle components and impair vehicle functions. There is a risk of an accident and damage to property.

The manufacturer of the vehicle recommends that, in the effort to avoid such risks, work in the engine compartment be performed by an authorized service center or another qualified service center or repair shop.

Warning

The engine compartment accommodates moving components. Certain components in the engine compartment can also move with the vehicle switched off, for instance the radiator fan. There is a risk of injury. Do not reach into the area of moving parts. Keep articles of clothing and hair away from moving parts.

Warning

There are protruding parts, for instance locking hooks, on the inside of the hood. There is a risk of injury. If the hood is open, pay attention to protruding parts and keep clear of these areas.

Warning

An incorrectly locked hood can open while driving and restrict visibility. There is a risk of accident. Stop immediately and correctly close the hood.

Warning

Body parts can be jammed when opening and closing the hood. There is a risk of injury. Make sure that the area of movement of hood is clear while opening and closing.

NOTICE

Folded-out wipers can be jammed when the hood is opened. There is a risk of damage to property. Make sure that the wipers with the wiper blades mounted are folded down onto the windshield before opening the hood.

NOTICE

When the hood is closed, it must engage on both sides. Pressing again can damage the hood. There is a risk of damage to property. Open the hood again and then close it energetically. Avoid pressing again.

Opening hood

The lever for unlocking the hood is located behind the footwell trim.

1. Pull the lever, arrow 1.
Hood is unlocked.

An acoustic signal and a notice in the instrument cluster indicate that the hood is open.



2. Release the lever and pull it again, arrow 2.
Hood can be opened.
3. Be careful of protruding parts on the hood.

Closing the hood

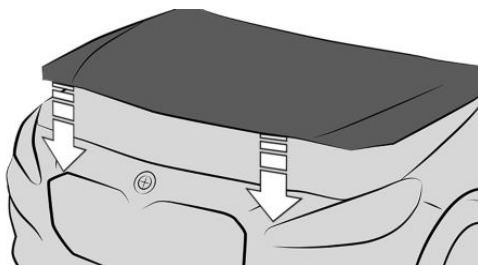

Energetically close the hood from approx. 20 in/50 cm.

The hood must engage on both sides.

Operating materials

Vehicle features and options

This chapter describes model-specific equipment, systems, and functions that are currently available, or may become available in the future, even if they are not present in the vehicle.

Additional information:

Vehicle equipment, refer to page 8.

Fuel recommendation

General information

Depending on the region, many filling stations sell fuel that has been customized to winter or summer conditions. Fuel that is available in winter, for instance helps make a cold start easier.

Gasoline

General information

For the best fuel efficiency, the gasoline should be sulfur-free or very low in sulfur content.

Fuels that are marked on the gas pump as containing metal must not be used.

Fuels with a maximum ethanol content of 10 %, i.e., E10, may be used for refueling.

The power and consumption specifications refer to operating with RON 98 E10 fuel

When using minimum quality AKI 87 fuel, there may be knocking noises as well as driving and acoustic abnormalities. These have no effect on the engine service life.

Safety information

Caution

The use of poor-quality fuels may result in harmful engine deposits or damage. Additionally, problems relating to drivability, starting and stalling, especially under certain environmental conditions such as high ambient temperature and high altitude, may occur.

If drivability problems are encountered, we recommend switching to a high quality gasoline brand and a higher octane grade — AKI number — for a few tank fills. To avoid harmful engine deposits, it is highly recommended to purchase gasoline from Top Tier retailers.

Failure to comply with these recommendations may result in the need for additional maintenance.

Warning

Even small quantities of the wrong fuel or wrong fuel additives can damage the fuel system and engine. Furthermore, the catalytic converter can be permanently damaged. There is a risk of injury and risk of damage to property. Do not refuel or add the following in the case of gasoline engines:

- ▷ Leaded gasoline.
- ▷ Metallic additives, for instance manganese or iron.

Do not press the Start/Stop button after refueling with the wrong fuel. Contact an authorized service center or another qualified service center or repair shop.

NOTICE

Fuel that does not comply with the minimum quality can compromise engine function or cause engine damage. There is a risk of damage to property. Do not fill with fuel that does not comply with the minimum quality.

NOTICE

Incorrect fuels can damage the fuel system and the engine. There is a risk of damage to property. Do not use fuels with a higher ethanol content than recommended. Do not refuel with fuels containing methanol, e.g. M5 to M100.

Recommended gas quality

BMW recommends AKI 91.

Minimum fuel grade

BMW recommends AKI 87.

If you use gasoline with this minimum AKI Rating, the engine may produce knocking sounds when starting at high external temperatures. This has no effect on the engine life.

**BMW recommends
Shell Quality Fuels** 

Engine oil

General information

The engine oil consumption and engine oil properties depend on the driving style and operating conditions.

Therefore, regularly check the engine oil level after refueling by taking a detailed measurement.

The engine oil consumption can increase in the following situations, for instance:

- ▷ Sporty driving style.
- ▷ Break-in of the engine.
- ▷ Idle operation of the engine.
- ▷ With use of engine oil types that are not recommended.

Different Check Control messages are shown on the control display depending on the engine oil level and engine oil properties.

The vehicle manufacturer recommends having the engine oil changed by an authorized service center or another qualified service center or repair shop. The suitable viscosity grade is indicated on a sign in the engine compartment.

Safety information

NOTICE

An engine oil level that is too low causes engine damage. There is a risk of damage to property. Immediately add engine oil.

NOTICE

Too much engine oil can damage the engine or the catalytic converter. There is a risk of damage to property. Do not add too much engine oil. If there is excess engine oil, have the engine oil level corrected by an authorized service center or another qualified service center or repair shop.

⚠ NOTICE

Engine oil that is not changed in timely fashion can cause increased engine wear and thus engine damage. There is a risk of damage to property. It is recommended that you do not exceed the service intervals indicated in the vehicle.

Electronic oil measurement

General information

The electronic oil measurement has two measuring principles:

- ▷ Monitoring.
- ▷ Detailed measurement.

When making frequent short-distance trips or using a sporty driving style, for instance when cornering aggressively, regularly perform a detailed measurement.

Monitoring

Principle

The engine oil level is monitored electronically while driving and can be shown on the control display.

If the engine oil level is outside its permissible operating range, a Check Control message is displayed.

Functional requirements

A current measured value is available after approx. 30 minutes of normal driving.

Displaying the engine oil level

1.  Apps menu
2. "Vehicle"
3. "Vehicle status"
4. "Engine oil level"

The engine oil level is displayed.

System limits

When making frequent short-distance trips or using a sporty driving style, it may not be possible to calculate a measured value. In this case, the measured value for the last, sufficiently long trip is displayed.

Detailed measurement

Principle

The engine oil level is checked when the vehicle is stationary and displayed via a scale.

If the engine oil level is outside its permissible operating range, a Check Control message is displayed.

General information

During the measurement, the idle speed is increased somewhat.

Depending on vehicle equipment, an optimum operating range for racetrack use is displayed on the scale.

Functional requirements

- ▷ Vehicle is parked in a horizontal position.
- ▷ The drive-ready state is switched on by pressing the Start/Stop button.
- ▷ The engine is at operating temperature.
- ▷ Selector lever in selector lever position N or P and accelerator pedal not depressed.

Performing a detailed measurement

1.  Apps menu
2. "Vehicle"
3. "Vehicle status"
4. "Engine oil level"
5. "Oil level measurement"
6. "Start measurement"

The engine oil level is checked and displayed via a scale.

Adding engine oil

General information

Only add engine oil when the message is displayed in the instrument cluster. The top-up quantity is indicated in the message shown on the control display.

Only add suitable types of engine oil.

Safely park the vehicle and switch off drive-ready state before adding engine oil.

Take care not to add too much engine oil.

Safety information

Warning

Operating materials, for instance oils, greases, coolants, fuels, can contain harmful ingredients. There is a risk of injury or danger to life. Follow the instructions on the containers. Avoid the contact of articles of clothing, skin or eyes with operating materials. Do not refill operating materials into different bottles. Store operating materials out of reach of children.

NOTICE

An engine oil level that is too low causes engine damage. There is a risk of damage to property. Immediately add engine oil.

NOTICE

Too much engine oil can damage the engine or the catalytic converter. There is a risk of damage to property. Do not add too much engine oil. If there is excess engine oil, have the engine oil level corrected by an authorized service center or another qualified service center or repair shop.

Overview

The oil filler neck is located in the engine compartment.

Additional information:

For an overview, refer to page [348](#).

Adding engine oil

1. Opening the hood.
Opening, refer to page [350](#).
2. Open the lid counterclockwise.



3. Add engine oil.
4. Close the lid.

Engine oil types to add

General information

The engine oil grade is critical for the service life of the engine.

Only add with the types of engine oil which are listed.

Safety information

NOTICE

Oil additives can damage the engine. There is a risk of damage to property. Do not use oil additives.

⚠ NOTICE

Incorrect engine oil can cause malfunctions in the engine or damage it. There is a risk of damage to property. When selecting an engine oil, make sure that the engine oil has the correct oil specification.

Suitable engine oil types

When topping up engine oil, the following oil specification applies:

Gasoline engine

BMW Longlife-01 FE.

BMW Longlife-22 FE++.

The BMW Longlife-22 FE++ oil specification is not suitable for the 60i gasoline engine.

Alternative engine oil types

If an engine oil suitable for continuous use is not available, up to 1 US quart/liter of an engine oil with the following oil rating can be added:

Oil specification

API SL.

API SM.

API SN.

Viscosity grades

When selecting an engine oil, make sure that the engine oil has a suitable viscosity grade. The suitable viscosity grade is indicated on a sign in the engine compartment.

More information about suitable oil specifications and engine oil viscosity grades can be requested from an authorized service center or another qualified service center or repair shop.

**BMW recommends
Original BMW Engine Oil.**

Coolant**General information**

Coolant consists of water and coolant additive. Not all commercially available coolant additives are suitable for the vehicle. The vehicle manufacturer recommends using coolant with the BMW LC-18 specification. Do not mix coolant additives of different colors. Use a 50:50 mixing ratio of water to coolant additive. Information on suitable coolant additives can be provided by an authorized service center or another qualified service center or repair shop.

Safety information**⚠ Warning**

With the engine hot and the cooling system open, coolant can escape and lead to scalding. There is a risk of injury. Only open the cooling system with the engine cooled down.

⚠ Warning

Additives are harmful and incorrect additives can damage the engine. There is a risk of injury and risk of damage to property. Do not allow additives to come into contact with skin, eyes or articles of clothing. Use suitable additives only.

NOTICE

Too much water reduces the cooling and antifreeze properties of the coolant. There is a risk of damage to property. Use a 50:50 mixing ratio of water to coolant additive.

Coolant level

General information

The coolant may be overfilled in the coolant reservoir when the vehicle is delivered from the factory. Run longer to achieve the normal coolant level.

The nominal coolant level is indicated by the maximum mark in the filler neck of the coolant reservoir.

Additional information:

For an overview, refer to page 348.

Checking the coolant level

1. Let the engine cool down.
2. Opening the hood.
Opening, refer to page 350.
3. Turn the lid of the coolant reservoir slightly counterclockwise to allow any excess pressure to dissipate, then open it.
4. Open the coolant reservoir lid.
5. The coolant level is correct when it is just below the maximum mark in the filler neck.



6. Close the lid.

Disposal



Comply with the relevant environmental protection regulations when disposing of coolant and coolant additives.

Washer fluid

General information

All spray nozzles are supplied from one tank.

Use a mixture of tap water and windshield washer concentrate. If desired, a windshield washer concentrate containing antifreeze can be used.

Recommended minimum fill quantity: 0.4 US gal/2 liters.

Safety information

Warning

Some types of antifreeze can contain harmful substances and are flammable. There is a risk of fire and an injury hazard. Follow the instructions on the containers. Keep antifreeze away from ignition sources. Do not refill operating materials into different bottles. Store operating materials out of reach of children.

United States: the washer fluid mixture ratio is regulated by the U.S. EPA and many individual states; do not exceed the allowable washer fluid dilution ratio limits that apply. Follow the usage instructions on the washer fluid container.

Use of BMW's Windshield Washer Concentrate or the equivalent is recommended.

Warning

Washer fluid can ignite and catch fire on contact with hot engine parts. There is a risk of injury or risk of damage to property. Only add washer fluid when the engine is cooled down.

Next, fully close the lid of the washer fluid reservoir.

NOTICE

Silicon-containing additives in the washer fluid for the water-repelling effect on the windows can lead to damage to the car wash. There is a risk of damage to property. Do not add silicon-containing additives to the washer fluid.

NOTICE

Mixing different windshield washer fluid concentrates or antifreeze can damage the washer system. There is a risk of damage to property. Do not mix different windshield washer fluid concentrates or antifreeze. Follow the information and mixture ratios provided on the containers.

Overview



The washer fluid reservoir is located in the engine compartment.

Refilling washer fluid

1. Pull out the filler neck with the cover closed.

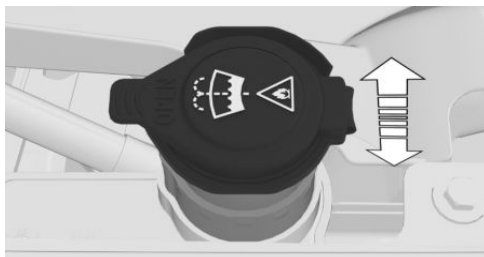

2. Open the lid and add washer fluid.
3. Close the lid and press the filler neck down again.

Malfunction

The use of undiluted windshield washer fluid concentrate or alcohol-based antifreeze can lead to incorrect readings at temperatures below +5 °F/-15 °C.

Maintenance

Vehicle features and options

This chapter describes model-specific equipment, systems, and functions that are currently available, or may become available in the future, even if they are not present in the vehicle.

Additional information:

Vehicle equipment, refer to page 8.

BMW maintenance system

Principle

The maintenance system provides service notifications and thereby provides support in maintaining road safety and the operational reliability of the vehicle.

General information

In some cases, scopes and intervals of the maintenance system may vary according to the country version. Replacement work, spare parts, fuels and lubricants, and wear materials are calculated separately. Further information is available from an authorized service center or another qualified service center or repair shop.

Condition Based Service

Principle

Condition Based Service determines the maintenance recommendation using sensors and special algorithms that take into account the operating conditions of the vehicle.

The maintenance measures are determined taking into account the individual usage profile of the vehicle.

General information

Service notifications can be displayed on the control display.

Additional information:

Service notifications, refer to page 161.

Service data in the vehicle key

Information on the service notifications is continuously stored in the vehicle key. An authorized service center can read this data out and suggest a maintenance scope for the vehicle.

Therefore, hand the service advisor the vehicle key with which the vehicle was driven most recently.

Stationary periods

Stationary periods during which the vehicle battery was disconnected are not taken into account.

In such cases, have any time-dependent maintenance measures, e.g., brake fluid, engine oil, and microfilter/activated-charcoal filter checks, performed by an authorized service center or another qualified service center or repair shop.

Maintenance Booklet for US Models

Please consult your Maintenance Booklet for additional information on the performance of service and maintenance work.

The manufacturer of the vehicle recommends that maintenance and repair be performed by an authorized service center or another qualified service center or repair shop. Records of regular maintenance and repair work should be retained.

Diagnostic socket

General information

Devices connected to the diagnostic socket will trigger the alarm system after locking the vehicle.

Remove devices connected to the diagnostic socket before locking the vehicle.

Additional information:

Indicator/warning lights, refer to page 145.

Safety information

NOTICE

The socket for Onboard Diagnosis is an intricate component intended to be used in conjunction with specialized equipment to check the vehicle's primary emissions system. Improper use of the socket for Onboard Diagnosis, or contact with the socket for Onboard Diagnosis for other than its intended purpose, can cause vehicle malfunctions and creates risks of personal and property damage. Given the foregoing, it is strongly recommended that access to the socket for Onboard Diagnosis be limited to an authorized service center or another qualified service center or repair shop, or other persons that have the specialized training and equipment for purposes of properly utilizing the socket for Onboard Diagnosis.

Position

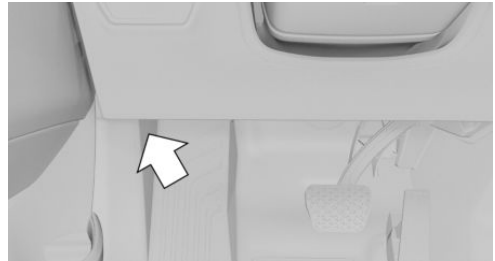

There is an onboard diagnostic port for reading out vehicle data on the left side of the vehicle.

Emissions



- ▶ The warning light illuminates: Worsening emissions, e.g., due to an incorrectly fitted fuel cap. Have the vehicle checked as soon as possible.
- ▶ The warning light flashes under certain circumstances: This indicates that there is excessive misfiring in the engine. Reduce the vehicle speed and have the vehicle checked immediately; otherwise, serious engine misfiring within a brief period can seriously damage emission control components, in particular the catalytic converter.

Have the vehicle checked by an authorized service center or another qualified service center or repair shop.

Replacing components

Vehicle features and options

This chapter describes model-specific equipment, systems, and functions that are currently available, or may become available in the future, even if they are not present in the vehicle.

Additional information:

Vehicle equipment, refer to page 8.

Onboard vehicle tool kit



The onboard vehicle tool kit is located in the left storage compartment of the cargo area.

Turn the cover lock, arrow 1, and fold out the trim panel, arrow 2.

Wiper blades

Safety information

NOTICE

The window may sustain damage if the wiper falls onto it without the wiper blade installed. There is a risk of damage to property. Hold the wiper firmly when changing the wiper blade. Do not fold in or switch on the wiper without a wiper blade installed.

NOTICE

Folded-out wipers can be jammed when the hood is opened. There is a risk of damage to property. Make sure that the wipers with the wiper blades mounted are folded down onto the windshield before opening the hood.

Replacing the wiper blades

1. To change the wiper blades, bring wipers into fold-out position.
Fold-out position of the wipers, refer to page 172.
2. Fold out and hold the wiper arm firmly.
3. Squeeze the retaining spring, arrow 1, and fold up the wiper blade, arrow 2.

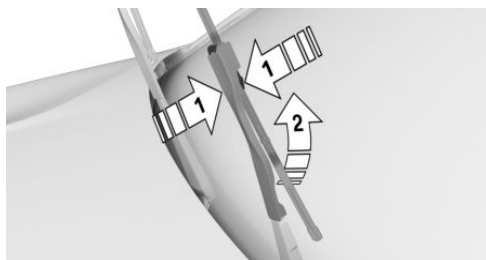

4. Remove the wiper blade forward from the detent.
5. Insert the new wiper blade in reverse order of removal until it locks in place.
6. Fold in the wipers.

Lights and bulbs

General information

Lights and bulbs make an essential contribution to driving safety.

All headlights and lights are designed using LED technology at least.

In the event of a malfunction, the vehicle manufacturer recommends having an authorized service center or another qualified service center or repair shop perform any necessary work.

Safety information

Warning

Intense brightness can irritate or damage the retina of the eye. There is a risk of injury. Do not look directly into the headlights or other light sources. Do not remove the LED covers.

Headlight glass

The inside of the headlight glass can fog up in cool or humid weather. When driving with the lights switched on, the condensation evaporates after a short time. The headlight glass does not need to be changed.

If, despite driving with the headlights switched on, moisture such as water droplets increasingly forms in the light, have the headlights checked.

Vehicle battery

General information

The battery is maintenance-free.

More information on the battery can be requested from an authorized service center or another qualified service center or repair shop.

Safety information

DANGER

Contact with live components can lead to an electric shock. There is a risk of injury or danger to life. Do not touch any components that are under voltage.

Warning

Vehicle batteries that are not compatible can damage vehicle systems and impair vehicle functions. There is a risk of an accident and damage to property. Only vehicle batteries that are compatible with the vehicle type should be installed in the vehicle. Information on compatible vehicle batteries is available at an authorized service center or another qualified service center or repair shop.

Registering the battery to the vehicle

The vehicle manufacturer recommends having an authorized service center or another qualified service center or repair shop register the vehicle battery to the vehicle after the battery has been changed. Once the battery has been registered again, all comfort features will be available without limitation and any Check Control messages displayed which relate to comfort features will disappear.

Charging the battery

General information

Make sure that the battery is always sufficiently charged to guarantee that the battery remains usable for its full service life.



A discharged battery is indicated by a red indicator light.

Charge the battery when acceleration is insufficient.

The following circumstances can have a negative effect on the performance of the battery:

- ▷ Frequent short-distance drives.
- ▷ Stationary periods of more than one month.

Safety information

Warning

Battery chargers that charge the vehicle battery via sockets or cigarette lighters in the vehicle may overload or damage the 12 V electrical system. There is a risk of injury or risk of damage to property. Only connect battery chargers for the vehicle battery to the jump-start terminals in the engine compartment.

Charging the battery

Charge the battery only when the engine is off and via the jump-start terminals in the engine compartment.

With Mild Hybrid technology: charge the battery only when the hood is opened.

Additional information:

Jump-start terminals, refer to page [368](#).

Power interruption

After a power interruption, some equipment needs to be newly initialized or individual settings updated, for example:

- ▷ Parking brake, refer to page [138](#).
- ▷ With Memory function: store the positions again.
- ▷ Time: update.
- ▷ Date: update.

Deep sleep mode

Use deep sleep mode for long stationary periods.

Additional information:

Idle state, refer to page [40](#)

Mild Hybrid technology

Principle

Part of the Mild Hybrid technology is a battery that works with a voltage of 48 volts. Mild Hybrid technology can lower the fuel consumption.

Safety information

DANGER

Contact with live components can lead to an electric shock. There is a risk of injury or danger to life. Do not touch any components that are under voltage.

General information

The battery for mild hybrid technology is located below the cargo area floor.

Notice

Do not exchange or work on the battery for the Mild Hybrid technology.

Disposing of old batteries



Have old batteries disposed of by an authorized service center or another qualified service center or repair shop, or take them to a collection point.

Maintain the filled battery in an upright position for transport and storage. Secure the battery so that it does not tip over during transport.

Fuses

General information

The fuses are located at different places in the vehicle.

Information on the fuse layout and the positions of the fuse boxes is available on the Internet: fusecard.bmw.com.

Safety information

Warning

Incorrect and repaired fuses can overload electrical lines and components. There is a risk of fire. Never attempt to repair a blown fuse. Do not replace a nonworking fuse with a substitute of another color or amperage rating.

Replacing fuses

The vehicle manufacturer recommends having the fuses replaced by an authorized service center or another qualified service center or repair shop.

Breakdown Assistance

Vehicle features and options

This chapter describes model-specific equipment, systems, and functions that are currently available, or may become available in the future, even if they are not present in the vehicle.

Additional information:

Vehicle equipment, refer to page 8.

Hazard warning system

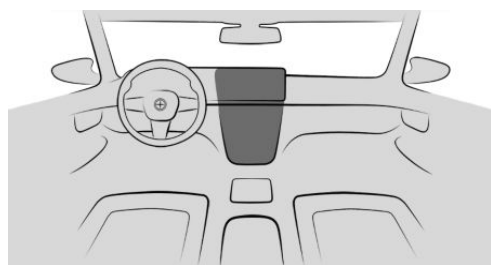

Hazard warning system button

The red light in the button flashes when the hazard warning system is turned on.

Warning triangle

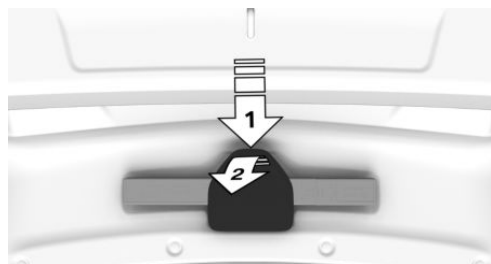

The warning triangle is located on the inside of the tailgate.

Press on the release, arrow 1, and swivel the cover down, arrow 2.

First-aid kit

General information

Depending on the vehicle equipment and national-market version, the vehicle is equipped with a first-aid kit.

Some of the articles have a limited service life.

Check the expiration dates of the contents regularly and replace any expired items promptly.

Storage

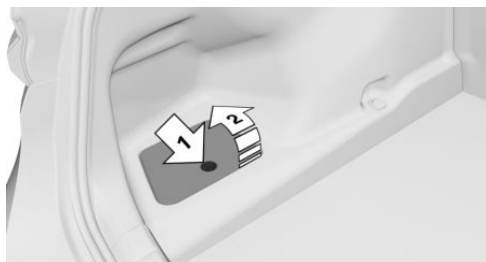

Storage for the first-aid kit is provided in the left storage compartment of the cargo area.

Turn the screw cap in the cover by 90°, arrow 1, and fold down the trim panel, arrow 2.

BMW Assist

Principle

In the event of a breakdown, accident or if you have any questions about the vehicle, BMW Assist can be used to contact BMW Group's customer support.

General information

The offering depends on the vehicle equipment and the national-market version.

For more information on this service, the vehicle manufacturer recommends contacting an authorized service center or the hotline/customer support.

Starting services

1.  Apps menu
2. "All apps"
3. "BMW Assist"
4. "BMW Assist"

A voice connection to customer support is being established.

BMW Roadside Assistance

Principle

BMW Group Roadside Assistance can be contacted if assistance is needed in the event of a breakdown.

General information

In the event of a breakdown, data on the vehicle's condition is transmitted to the BMW Roadside Assistance.

There are various ways of contacting BMW Roadside Assistance.

- ▶ Via additional text in the Check Control message.
- ▶ Via a call with a mobile phone.
- ▶ Via the BMW app.

Functional requirements

- ▶ Active ConnectedDrive contract, equipment with intelligent emergency call or BMW ConnectedDrive services.
- ▶ Cellular network reception.
- ▶ Standby state is switched on.

Starting BMW Roadside Assistance manually

If the vehicle is equipped with Teleservices, support is first offered through Teleservice Diagnosis and, where applicable, then through Teleservice Help.

1.  Apps menu
2. "All apps"
3. "BMW Assist"
4. "BMW Roadside Assistance" or select the desired service.

Follow the displays on the control display. A voice connection is established.

Teleservice Diagnosis

Teleservice Diagnostics enables detailed vehicle data to be transmitted via cellular networks, which is necessary for vehicle diagnosis. This data is transmitted automatically. It may be necessary to approve this on the control display.

Teleservice Help

Depending on the country, Teleservice Help enables an in-depth diagnosis of the vehicle by BMW Roadside Assistance via wireless transmission.

You can launch Teleservice Help by requesting it through BMW Roadside Assistance.

1. Park the vehicle in a safe place.
2. Set the parking brake.
3. Turn on control display.
4. Consent to Teleservice Help.

BMW Accident Assistance

Principle

BMW Group Accident Assistance can be contacted if assistance is needed in the event of an accident.

General information

If the vehicle sensors detect a minor to moderately severe accident, which did not deploy any airbags, a Check Control message is displayed in the instrument cluster. In addition, a text message appears on the control display.

When BMW Accident Assistance is triggered, data on the vehicle's condition is sent to BMW.

Functional requirements

- ▶ Active ConnectedDrive contract, equipment with intelligent emergency call or BMW ConnectedDrive services.
- ▶ Cellular network reception.
- ▶ Standby state is switched on.

Starting BMW Accident Assistance

If an accident is detected automatically

A text message relating to BMW Accident Assistance appears on the control display.

The connection can be established directly:

"Contact accident assistance"

The Check Control message for BMW Accident Assistance can also be called up from the stored Check Control messages for a certain length of time.

Additional information:

Check Control, refer to page 144.

Starting BMW Accident Assistance manually

BMW Accident Assistance can also be contacted independently of the automatic accident detection function.

1.  Apps menu
2. "All apps"
3. "BMW Assist"
4. "BMW Accident Assistance" or select the desired service.

Follow the displays on the control display. A voice connection is established.

Emergency Call

Intelligent emergency call

Principle

In case of an emergency, an emergency call can be triggered automatically by the system or manually.

General information

Depending on the vehicle equipment and national-market version, the vehicle is equipped with an Assist system.

Only press the SOS button in the headliner in an emergency.

The Intelligent Assist system establishes a connection with the BMW Response Center.

For technical reasons, the emergency call cannot be guaranteed under unfavorable conditions.

Overview

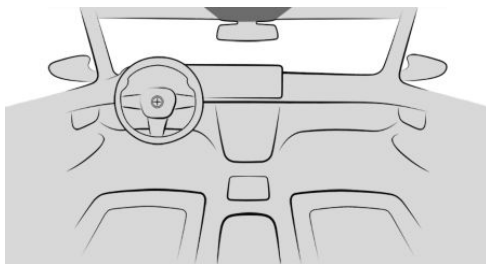

The SOS button is located in the headliner.

Functional requirements

- ▷ Standby state is switched on.
- ▷ The Assist system is functional.
- ▷ The integrated SIM card in the vehicle has been activated.

Automatic triggering

Under certain conditions, for example if the airbags are deployed, an emergency call is automatically triggered immediately after an accident of corresponding severity. Automatic Collision Notification is not affected by pressing the SOS button.

Manual triggering

1. Tap the cover flap.
 2. Press and hold the SOS button until the LED in the area of the button illuminates green.
- ▷ The LED is illuminated green when an emergency call has been initiated.
If a cancel prompt appears on the control display, the emergency call can be aborted.
If the situation allows, wait in the vehicle until the voice connection has been established.
 - ▷ The LED flashes green when a connection to the BMW Response Center has been established.

The BMW Response Center then makes contact with the occupants of the vehicle and initiates further steps to help.

Even if you are unable to respond, the BMW Response Center can take further steps to help you under certain circumstances.

For this purpose, data that serves to determine the necessary rescue measures, for instance the current position of the vehicle when it can be determined, is transmitted to the BMW Response Center.

Even if the BMW Response Center is no longer heard through the loudspeakers, the BMW Response Center may still be able to hear the occupants of the vehicle.

The BMW Response Center ends the emergency call.

Malfunction

The function of the emergency call may be impaired.

The LED near the SOS button flashes for approximately 30 seconds. A Check Control message is displayed.

Have the vehicle checked by an authorized service center or another qualified service center or repair shop.

Jump-starting

General information

If the battery is discharged, the engine can be started using the battery of another vehicle and two jumper cables. Only use jumper cables with fully insulated clamp handles.

Safety information

DANGER

Contact with live components can lead to an electric shock. There is a risk of injury or danger to life. Do not touch any components that are under voltage.

Warning

If the jumper cables are connected in the incorrect order, spark formation may occur. There is a risk of injury. Pay attention to the correct order during connection.

Warning

In the case of body contact between the two vehicles, a short circuit can occur while jump-starting. There is a risk of injury or risk of damage to property. Make sure that no body contact occurs.

Preparation

1. Check whether the battery of the other vehicle has a voltage of 12 volts. The voltage information can be found on the battery.
2. Switch off the engine of the assisting vehicle.
3. Switch off any electrical components in both vehicles.

Jump-start terminals

The jump-start terminals are located in the engine compartment.

Additional information:

For an overview, refer to page [348](#).

Open the covers of the jump-start terminals.

Connecting the cables

Before you begin, switch off all unnecessary electronic systems/components such as the radio on the assisting and receiving vehicles.

1. Open the lid of the jump-start terminal.
2. Attach one terminal clamp of the positive jumper cable to the positive battery terminal, or to the corresponding jump-start terminal of the vehicle providing assistance.
3. Attach the terminal clamp on the other end of the cable to the positive battery terminal, or to the corresponding jump-start terminal of the vehicle to be started.
4. Attach one terminal clamp of the negative jumper cable to the negative battery terminal,

or to the corresponding engine or body ground of assisting vehicle.

5. Attach the second terminal clamp to the negative battery terminal, or to the corresponding engine or body ground of the vehicle to be started.

Starting the engine

Never use spray fluids to start the engine.

1. Start the engine of the assisting vehicle and let it run for several minutes at an increased idle speed.

If the vehicle to be started has a diesel engine: let the engine of the assisting vehicle run for approx. 10 minutes.

2. Start the engine of the vehicle that is to be started in the usual way.

If the first attempt to start the engine is not successful, wait a few minutes before making another attempt in order to allow the discharged battery to recharge.

3. Let both engines run for several minutes.
4. Disconnect the jumper cables in the reverse order.

Check the battery and recharge, if needed.

Tow-starting and towing

General information

Depending on vehicle equipment, deactivate the air suspension level adjustment.

Two-axle ride level control, refer to page [271](#).

Safety information

Warning

Individual functions may not work correctly when towing with Forward Collision Mitigation enabled or Cruise Control switched on. There is a risk of accident. Switch off Forward

Collision Mitigation and Cruise Control before towing.

Steptronic transmission: Transporting the vehicle

General information

Do not transport the vehicle by towing it.

Safety information

NOTICE

The vehicle can be damaged when towing the vehicle with a single lifted axle. There is a risk of damage to property. The vehicle should only be transported on a loading platform.

Warning

The vehicle can become damaged when lifting and securing it.

There is a risk of injury or risk of damage to property.

- ▷ Lift the vehicle using suitable means.
- ▷ Do not lift or secure the vehicle by its tow fitting, body parts, or suspension parts.

Pushing the vehicle

To remove a broken-down vehicle from the hazardous area, push it for a short distance at a speed of no more than 6 mph/10 km/h.

Additional information:

Rolling or pushing the vehicle, refer to page [130](#).

Tow truck

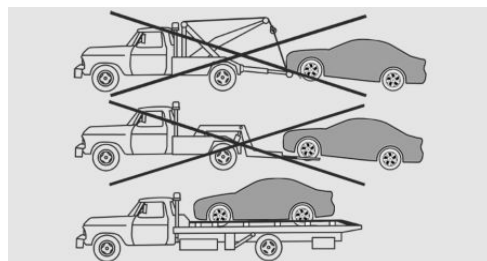

The vehicle should only be transported on a loading platform.

Towing other vehicles

General information

Switch on the hazard warning system, depending on local regulations.

If the electrical system has failed, clearly identify the vehicle being towed by placing a sign or a warning triangle in the rear window.

Safety information

Warning

If the approved gross vehicle weight of the towing vehicle is lighter than the vehicle to be towed, the tow fitting can tear off or it will not be possible to control handling. There is a risk of accident. Make sure that the gross vehicle weight of the towing vehicle is heavier than the vehicle to be towed.

Warning

Different levels of braking may occur when towing with adaptive recuperation. There is a risk of accident. Deactivate adaptive recuperation before towing.

NOTICE

If the tow bar or tow rope is attached incorrectly, damage to other vehicle parts can occur. There is a risk of damage to property. Correctly attach the tow bar or tow rope to the tow fitting.

Tow bar

The tow fittings used should be on the same side on both vehicles.

If it is impossible to avoid mounting the tow bar at an inclination, note the following:

- ▶ Free movement is limited when cornering.
- ▶ The tow bar will generate lateral forces if it is secured with an inclination.

Tow rope

Observe the following notes when using the tow rope:

- ▶ Use nylon ropes or straps, which will enable the vehicle to be towed without jerking.
- ▶ Make sure the tow rope is not twisted when fastening.
- ▶ Check the attachment of the tow fitting and tow rope in regular intervals.
- ▶ Do not exceed a towing speed of 30 mph/50 km/h.
- ▶ Do not exceed a towing distance of 3 miles/5 km.
- ▶ When driving off to tow the vehicle, make sure that the tow rope is taut.

Tow fitting**General information**

The screw-in tow fitting should always be carried in the vehicle.

The tow fitting can be screwed in at the front or rear of the vehicle.

The tow fitting is found in the onboard vehicle tool kit.

Observe the following notes when using the tow fitting:

- ▶ Use only the tow fitting provided with the vehicle.
- ▶ Turn the tow fitting at least 5 turns clockwise and screw it in as far as it will go. If necessary, tighten with a suitable object.
- ▶ After use, unscrew the tow fitting counter-clockwise.
- ▶ Use the tow fitting for towing on paved roads only.
- ▶ Avoid lateral loading of the tow fitting, for instance do not lift the vehicle by the tow fitting.
- ▶ Check the attachment of the tow fitting in regular intervals.

Additional information:

Onboard vehicle tool kit, refer to page [360](#).

Safety information

NOTICE

If the tow fitting is not used as intended, there may be damage to the vehicle or to the tow fitting. There is a risk of damage to property. Follow the notes on using the tow fitting.

Screw thread for tow fitting



Press on the mark on the edge of the cover to push it out.

Tow-starting

Do not tow-start the vehicle.

Start the engine by jump-starting, if possible.

Have the cause of starting issues corrected by an authorized service center or another qualified service center or repair shop.

Additional information:

Jump-starting, refer to page [367](#).

Vehicle Care

Vehicle features and options

This chapter describes model-specific equipment, systems, and functions that are currently available, or may become available in the future, even if they are not present in the vehicle.

Additional information:

Vehicle equipment, refer to page 8.

Washing the vehicle

General information

Regularly remove foreign bodies such as leaves or snow in the area below the windshield.

Wash the vehicle frequently, particularly in winter. Intense contamination and road salt can damage the vehicle.

Additional information:

Fold-out position of the wipers, refer to page 172.

Safety information

NOTICE

When washing with an open fuel filler flap, damage may occur. There is a risk of damage to property. Close the fuel filler flap before washing. Clean dirt behind the fuel filler flap with a cloth.

NOTICE

If the function for automatically opening/closing the driver's door is activated, the driver's door may open unintentionally, e.g. when washing the vehicle. There is a risk of damage to property. In situations where the driv-

er's door must remain closed, deactivate the hands-free opening/closing function.

Steam cleaner and high pressure cleaner

Safety information

NOTICE

When cleaning with high pressure cleaners, components can be damaged due to the pressure or temperatures being too high. There is a risk of damage to property. Maintain sufficient distance and do not spray too long continuously. Follow the operating instructions for the high pressure cleaners.

Distances and temperature

- ▶ Maximum temperature: 140 °F/60 °C.
- ▶ Minimum distance from sensors, cameras, seals and lights: 12 inches/30 cm.
- ▶ Minimum distance from glass sunroof: 31.5 in/80 cm.

Automatic car washes or car washes

Safety information

NOTICE

Improper use of automatic car washes can cause damage to the vehicle. There is a risk of damage to property. Follow the following instructions:

- ▷ Give preference to cloth car washes or those that use soft brushes in order to avoid paint damage.
- ▷ Do not drive through a car wash with guide rails higher than 4 in/10 cm to avoid damage to the body.
- ▷ Observe the tire width of the guide rail to avoid damage to tires and rims.
- ▷ Fold in exterior mirrors to avoid damage to the exterior mirrors.
- ▷ Deactivate the wiper and, if necessary, rain sensor to avoid damage to the window wiper system.

Driving into a car wash

NOTICE

Selector lever position P is automatically engaged when standby state is switched off. The wheels are blocked. There is a risk of damage to property. Do not switch off standby if the vehicle is meant to coast, e.g., in a car wash.

In a car wash, the vehicle must be able to roll freely.

Some car washes do not permit persons in the vehicle. The vehicle cannot be locked from the outside when in selector lever position N. A signal sounds when an attempt is made to lock the vehicle.

Additional information:

Rolling or pushing the vehicle, refer to page [130](#).

Driving out of a car wash

Ensure that the vehicle key is in the car.

Turn on drive-ready state.

Additional information:

Drive-ready state, refer to page [42](#).

Lights

Do not rub wet lights dry and do not use abrasive or acidic cleaning agents or cleaning agents containing alcohol.

Soak areas that have been dirtied, for instance from insects, with auto shampoo and wash off with water.

Thaw ice with de-icing spray; do not use an ice scraper.

Fresh air intake for automatic climate control

Safety information

NOTICE

After opening the hood, foreign bodies or liquids may enter the automatic climate control via the fresh air intake under the hood. There is a risk of damage to property. Follow the following instructions:

- ▷ Make sure that no foreign bodies or liquids enter the fresh air intake, e.g., when washing the engine or cleaning the area under the windshield.
- ▷ Do not direct the steam jet or high-pressure cleaner at the fresh air intake.
- ▷ Regularly check the fresh air intake and remove foreign bodies.

Overview



After washing the vehicle

After washing the vehicle, apply the brakes briefly to dry them; otherwise, braking effect can be reduced. The heat generated while braking dries brake disks and brake pads and protects them against corrosion.

Completely remove all residues on the windows to minimize loss of visibility due to smearing and to reduce wiper noises and wiper blade wear.

Vehicle care

Vehicle care products

General information

BMW recommends using vehicle care and cleaning agents from BMW. Suitable vehicle care products are available from an authorized service center or another qualified service center or repair shop.

Safety information

Warning

Cleaning agents can contain substances that are dangerous and harmful to your health. There is a risk of injury. When cleaning the interior, open the doors or windows. Only use products intended for cleaning vehicles. Follow the instructions on the packaging.

Vehicle paintwork

General information

Regular vehicle care contributes to driving safety and value retention. Environmental influences in areas with elevated air pollution or natural contaminants such as tree resin or pollen can affect the vehicle paintwork. Tailor the frequency and extent of the vehicle care to these influences.

Aggressive substances such as spilled fuel, oil, grease or bird droppings must be removed immediately to prevent alterations or discolorations of the finish.

Matte paintwork

Only use cleaning and care products suitable for vehicles with matte paintwork.

Leather care

Remove dust from the leather regularly, using a cloth or vacuum cleaner.

Otherwise, particles of dust and road grime chafe in pores and folds, and lead to heavy abrasion and premature degradation of the leather surface.

To guard against discoloration such as from clothing, clean leather and provide leather care roughly every two months.

Clean light-colored leather more frequently because contamination on such surfaces is substantially more visible.

Use leather care products; otherwise, dirt and grease will gradually break down the protective coating of the leather surface.

Remove aggressive substances, e.g., sunscreen, immediately to prevent alterations or discolorations of the leather.

Synthetic leather care

Clean synthetic leather regularly with a damp microfiber cloth or vacuum cleaner.

Otherwise, dust and road grime particles will rub into pores and folds, causing significant abrasion and premature degradation of the surface.

In case of major soiling, use a moist soft sponge or microfiber cloth with suitable interior cleaners.

Immediately remove aggressive substances, e.g., sunscreen, to prevent alterations or discolorations of the synthetic leather.

Fabric care

General information

In case of major contaminations such as beverage stains, use a moist soft sponge or microfiber cloth with a suitable interior cleaners.

Immediately remove aggressive substances, e.g., sunscreen, to prevent alterations or discolorations of the fabric.

Safety information

NOTICE

Open hook and loop fasteners on articles of clothing can damage the seat covers and other cloth upholstery in the vehicle. There is a risk of damage to property. Ensure that any Velcro® fasteners are closed.

Upholstery material care

Vacuum regularly with a vacuum cleaner.

Clean extensively down to the seams. Avoid rubbing the material vigorously.

If upholstery material containing cashmere is soiled, use only a damp, soft sponge with a suitable interior cleaner.

Textile care

Use a microfiber cloth for cleaning minor contamination.

Dampen the cloth with water.

If fabrics containing cashmere are soiled, use only a damp, soft sponge with a suitable interior cleaner.

Caring for special components

Displays, operating elements, and protective glass of the Head-up display

NOTICE

Surfaces can be damaged by improper cleaning, e.g., by using chemical cleaners, or from moisture or liquid of any kind. Physical damage to the material is possible.

- ▷ Avoid pressure that is too high and do not use any scratching materials.
- ▷ Use a dry, clean antistatic microfiber cloth for cleaning displays.
- ▷ Clean the operating elements and, depending on vehicle equipment, the protective glass of the Head-up display with a damp microfiber cloth and standard household dish soap.

Light-alloy wheels

When cleaning the vehicle, use only neutral rim cleaners having a pH value from 5 to 9. Do not use abrasive cleaning agents or steam cleaners above 140 °F/60 °C. Follow the manufacturer's instructions.

Aggressive, acidic or alkaline cleaning agents can destroy the protective coating of adjacent components such as the brake disk.

After cleaning, apply the brakes shortly to dry them. The heat generated while braking dries brake disks and brake pads and protects them against corrosion.

Chrome surfaces

Carefully clean Chrome surfaces, especially in case of exposure to road salt, with plenty of water and added auto shampoo as needed.

Rubber components

Environmental influences can cause surface contamination of rubber parts and a loss of gloss. Use only water and suitable cleaning agents for cleaning.

Treat especially worn rubber parts with rubber care products at regular intervals. When cleaning rubber seals, do not use any silicon-containing vehicle care products in order to avoid damage or noises.

Wiper blades

The wiper blades are cleaned by using the washer system.

Avoid cleaning the wiper blades manually, as this may reduce wiper performance.

Fine wood parts

Clean the fine wood veneer and fine wood components with a damp cloth. Then dry with a soft cloth.

Kenaf

Only treat parts made of Kenaf fibers using a suitable care product.

Plastic components

NOTICE

Solvent cleaners that contain alcohol or solvents such as lacquer thinners, cold cleaning agents, fuel and such, can damage plastic parts. There is a risk of damage to property. Clean with a microfiber cloth. Dampen the cloth lightly with water, if needed.

Do not soak the headliner.

Seat belts

Warning

Chemical solvent cleaners can destroy the fabric of the seat belts and lead to seat belts no longer having their protective effect. There is a risk of injury or danger to life. Use only a mild soap solution for cleaning the seat belts.

Dirty belt straps impede the reeling action and thus should be avoided for safety reasons.

Use only a mild soap solution for cleaning the installed belt straps.

Seat belts should only be allowed to retract if they are dry.

Rear head restraint cushion

The cover must be washed by hand.

Inner cushion cannot be washed.

Carpets and floor mats

Warning

Objects in the driver's footwell can limit the pedal travel or block a depressed pedal. There is a risk of accident. Stow objects in the vehicle such that they are secured and cannot enter into the driver's footwell. Use floor mats that are suitable for the vehicle and can be safely attached to the floor. Do not use loose floor mats and do not layer several floor mats. Make sure that there is sufficient clearance for the pedals. Ensure that the floor mats are securely fastened again after they were removed, for instance for cleaning.

The floor mats can be removed from the interior for cleaning.

If the floor carpets are very contaminated, clean with a microfiber cloth and water or a textile cleaner. To prevent matting of the carpet, rub back and forth in the driving direction only.

Sensors and camera lenses

General information

To clean sensors and camera lenses, use a cloth moistened with a small amount of glass detergent.

Cleaning the front camera and rearview camera

If soiling is detected, cleaning of front camera and rear-view camera is offered on the control display or can be switched on manually.

1.  Apps menu
2. "Vehicle"
3. "Parking"
4. "More"
5. "Camera cleaning"
6. Select the desired setting.

Taking the vehicle out of service

When the vehicle is shut down for longer than three months, special measures must be taken. For more information, contact an authorized service center or another qualified service center or repair shop.

Technical data

Vehicle features and options

This chapter describes model-specific equipment, systems, and functions that are currently

available, or may become available in the future, even if they are not present in the vehicle.

Additional information:

Vehicle equipment, refer to page 8.

General information

The technical data and specifications in the Owner's Manual are used as guidance values. Vehicle-specific data may deviate from this, for instance due to the optional equipment chosen, national-market version, or country-

specific measuring process. More specific values can be obtained in approval documents, on the vehicle info label, or from an authorized service center or another qualified service center or repair shop.

Dimensions

The dimensions can vary depending on the model version, equipment version or country-specific measurement procedure.

The height of the vehicle can also differ, e.g. due to tires and vehicle load.

BMW 7 Series

Width with mirrors	in/mm	86.3/2,192
Width without mirrors	in/mm	76.8/1,950
Height	in/mm	60.8/1,544
Length	in/mm	212.2/5,391
Wheelbase	in/mm	126.6/3,215
Turning radius diameter		
without xDrive and Integral Active Steering	ft/m	42.3/12.9
without xDrive and with Integral Active Steering	ft/m	39.7/12.1
with xDrive and without Integral Active Steering	ft/m	43.0/13.1
with xDrive and Integral Active Steering	ft/m	40.4/12.3

Weights

BMW 740i Series Sedan

Permissible gross weight	lbs/kg	6,140/2,785
Payload	lbs/kg	1,098/498
Approved front axle weight	lbs/kg	2,954/1,340
Approved rear axle weight	lbs/kg	3,373/1,530

BMW 740i xDrive Sedan

Permissible gross weight	lbs/kg	6,283/2,850
Payload	lbs/kg	1,111/504
Approved front axle weight	lbs/kg	3,064/1,390
Approved rear axle weight	lbs/kg	3,417/1,550

BMW 760i xDrive Sedan

Permissible gross weight	lbs/kg	6,570/2,980
Payload	lbs/kg	1,124/510
Approved front axle weight	lbs/kg	3,241/1,470
Approved rear axle weight	lbs/kg	3,549/1,610

Filling capacities

BMW 7 Series

Fuel tank, approx.	US gal/liters	19.5/74.0
--------------------	---------------	-----------

Observe further information on fuel quality, refer to page [351](#).

Appendix

General information

Any updates to the Owner's Manual of the vehicle are listed here.

Updates made after the editorial deadline

The following chapters were updated in the printed version of the Owner's Manual after the editorial deadline for the Integrated Owner's Manual in the vehicle had closed:

- ▶ Operation: Opening and closing: Automatic doors: Hands-free opening/closing of driver's door: Safety instructions.
- ▶ Operation: Seats, mirrors, and steering wheel: Front seats: Front seat calibration: Calibrating the front seats.
- ▶ Operation: Seats, mirrors, and steering wheel: Seat belts: Safety function.
- ▶ Operation: Safety: Active Protection: Function.

License Texts and Certifications

USA/Canada

Basis Central Platform

Canada

Lear

IC: 6276A-BCP01

This device complies with part 15 of the FCC Rules and Industry Canada license-exempt RSS standard(s). Operation is subject to the following two conditions:

(1) This device may not cause harmful interference, and

(2) this device must accept any interference received, including interference that may cause undesired operation.

Le présent appareil est conforme aux CNR d'Industrie Canada applicables aux appareils radio exempts de licence. L'exploitation est autorisée aux deux conditions suivantes: (1) l'appareil ne doit pas produire de brouillage, et (2) l'utilisateur de l'appareil doit accepter tout brouillage radioélectrique subi, même si le brouillage est susceptible d'en compromettre le fonctionnement.

Visteon

IC 11505A-BCP01

ISED CANADA

This device complies with Industry Canada license-exempt RSS standard(s).

Operation is subject to the following two conditions:

(1) this device may not cause interference, and
 (2) this device must accept any interference, including interference that may cause undesired operation of the device.

Le présent appareil est conforme aux CNR d'Industrie Canada applicables aux appareils radio exempts de licence.

L'exploitation est autorisée aux deux conditions suivantes:

(1) l'appareil ne doit pas produire de brouillage, et

(2) l'utilisateur de l'appareil doit accepter tout brouillage radioélectrique subi, même si le brouillage est susceptible d'en compromettre le fonctionnement.

USA

Lear



TTR-BCP01

This device complies with part 15 of the FCC rules.

Operation is subject to the following two conditions:

- (1) This device may not cause harmful interference, and
- (2) This device must accept any interference received, including interference that may cause undesired operation.

Visteon

FCC ID: 2AA98-BCP01

FCC

This device complies with part 15 of the FCC Rules. Operation is subject to the following two conditions:

Operation is subject to the following two conditions:

- (1) this device may not cause interference, and
- (2) this device must accept any interference, including interference that may cause undesired operation of the device.

Changes or modifications not expressly approved by the party responsible for compliance could void the user's authority to operate the equipment.

Everything from A to Z

Index

0-9

2-axle air suspension, see Two-axle level control [271](#)

3D view [250](#)

48-volt technology, see Mild Hybrid technology [362](#)

A

ABS, see Antilock Braking System [212](#)

Acceleration Assistant, see Launch Control [132](#)

Acceleration sensor, see G-Meter [158](#)

Accessories and parts [9](#)

Accident Assistance, see BMW Accident Assistance [365](#)

Accident prevention, see Active Protection [208](#)

Acoustic pedestrian protection [126](#)

Activated carbon filter, see Interior filter [285](#)

Activation points, panorama view [252](#)

Activation word [54](#)

Active Blind Spot Detection [193](#)

Active comfort chassis, see Executive Drive Pro [271](#)

Active Cruise Control, Distance Control, see Speed control systems [218](#)

Active Guard, see Collision warning systems [178](#)

Active Park Distance Control [257](#)

Active Protection [208](#)

Active roll stabilization [271](#)

Active Steering, integral [215](#)

Adaptive 2-axle air suspension, see Two-axle level control [271](#)

Adaptive lighting functions [168](#)

Adaptive recuperation [313](#)

Adding engine oil types [354](#)

Additional camera view displays [246](#)

Additives, engine oil types [354](#)

Adjusting speed to route [239](#)

After run of fan, see Exhaust gas particulate filter [309](#)

Airbags, warning light [174](#)

Airbags, warning light [176](#)

Air circulation, see Recirculated-air mode [280](#)

Air conditioning, climate [279](#)

Air distribution, manual [279](#)

Air drying, see air conditioning [279](#)

Air flow, automatic climate control [278](#)

Air outlets, see Ventilation [284](#)

Air pressure, tires [320](#)

Air quality [285](#)

Air suspension, see Two-axle level control [271](#)

Air vent, see Ventilation [284](#)

Alarm, avoiding [99](#)

Alarm system [97](#)

All-season tires, see Winter tires [328](#)

All-season tires, tread [326](#)

All-wheel drive, see BMW xDrive [214](#)

Amazon Alexa Car Integration [57](#)

Ambient light [169](#)

Android Auto, see Owner's Manual for Navigation, Entertainment, Communication [6](#)

Antifreeze, see Washer fluid [356](#)

Antilock Braking System [212](#)

Anti-theft protection, lug bolt lock [344](#)

Apple CarPlay, see Owner's Manual for Navigation, Entertainment, Communication [6](#)

Applications see Owner's Manual for Navigation, Entertainment, Communication [6](#)

Applications, see Owner's Manual for Navigation, Entertainment, Communication [6](#)

Apps, see Owner's Manual for Navigation, Entertainment, Communication [6](#)

Aquaplaning [310](#)

Artificial engine noise, see Acoustic pedestrian protection [126](#)

Assistance, BMW [364](#)

Assistance with breakdown [364](#)

Assisted Driving Mode, lane keeping, see Speed control systems [218](#)

Assisted Driving Mode Plus, see Speed control systems [218](#)

Assisted View [158](#)

Attachment point for radio systems [310](#)

Audio player, see Owner's Manual for Navigation, Entertainment, Communication [6](#)

Audio, see Owner's Manual for Navigation, Entertainment and Communication [6](#)

Authorized service center, see BMW Accident Assistance [365](#)

Authorized service center, see BMW Roadside Assistance [365](#)

AUTO H button, see Automatic Hold [139](#)

Automatic camera perspective [249](#)

Automatic climate control [274](#)

Automatic control, headlight [165](#)

Automatic Curb Monitor, exterior mirror [116](#)

Automatic deactivation, front-seat passenger airbags [176](#)

Automatic dimming, see Automatic High Beam Assistant [163](#)

Automatic doors [82](#)

Automatic headlight control [165](#)

Automatic High Beam Assistant [163](#)

Automatic Hold [139](#)

Automatic locking [96](#)

Automatic Parking Assistant [259](#)

Automatic Parking Assistant Professional [259](#)

Automatic Parking Assistant, see Maneuver Assistant [264](#)

Automatic program, automatic climate control [276](#)

Automatic time setting [158](#)

Automatic transmission, see Steptronic transmission [128](#)

Automatic unlocking [96](#)

Automating routines, BMW Intelligent Personal Assistant [58](#)

AUTO program, automatic climate control [276](#)

Auto Start/Stop function [126](#)

Average consumption, see Trip data [156](#)

Axle loads, approved [379](#)

B

Backrest curvature, see Lumbar support [106](#)

Backrest, seats [104](#)

Backrest tilt [105](#)

Backrest width [106](#)

Back-up Assistant [268](#)

Back-up Assistant Professional [268](#)

Bandages, see First-aid kit [364](#)

Bar for tow-starting/towing [370](#)

Base position, rear seats [109](#)

Battery, disposing of [362](#)

Battery, vehicle [361](#)

Being towed, see Tow-starting and towing [368](#)

Belts, see Seat belts [110](#)

Blind spot collision warning [193](#)

Blocking, power window, see Safety switch [103](#)

Blower, see Air flow [278](#)

Bluetooth audio, see Owner's Manual for Navigation, Entertainment, Communication [6](#)

Bluetooth connection, see Owner's Manual for Navigation, Entertainment, Communication [6](#)

BMW Accident Assistance [365](#)

BMW app, see Owner's Manual for Navigation, Entertainment, Communication [6](#)

BMW Assist, see Owner's Manual for Navigation, Entertainment and Communication [6](#)

BMW Curved Display [48](#)

BMW Digital Key [90](#)

BMW Drive Recorder [205](#)

BMW Gesture Control [59](#)

BMW IconicSounds [273](#)

BMW ID [69](#)

BMW iDrive [44](#)

BMW Intelligent Personal Assistant [53](#)

BMW Live Cockpit Plus, see BMW Curved Display [48](#)

BMW Live Cockpit Professional, see BMW Curved Display [48](#)

BMW maintenance system [358](#)

BMW Natural Interaction, see BMW Gesture Control [59](#)

BMW Operating System, see BMW iDrive [44](#)

BMW Roadside Assistance [365](#)

BMW SIM Reader, see Owner's Manual for Navigation, Entertainment, Communication [6](#)
 BMW Theater Screen, see Owner's Manual for Navigation, Entertainment, Communication [6](#)
 BMW Touch Command [58](#)
 BMW xDrive [214](#)
 Boost, see Sport Boost function [133](#)
 Bottle holder, front, see Cup holder, front [302](#)
 Bottle holder, rear, see Cup holder, rear [302](#)
 Bracket, flag [312](#)
 Brake assistant [212](#)
 Brake disks, see Brake system [308](#)
 Brake pads, see Brake system [308](#)
 Brake system [308](#)
 Braking, information [310](#)
 Breakdown assistance [364](#)
 Break-in [308](#)
 Break-in procedures [308](#)
 Break recommendation, see Fatigue alert [209](#)
 Brightness, control display [49](#)
 Button, central locking system [93](#)
 Buttons on the steering wheel [30](#)
 Button, SOS, see Intelligent emergency call [366](#)
 Button, Start/Stop [126](#)
 Bypassing, see Jump-starting [367](#)

C

Cable for tow-starting/towing [370](#)
 Calibration of the front seats [107](#)
 California Proposition 65 Warning [9](#)
 Call, gesture control [60](#)
 Camera cleaning [377](#)
 Camera, instrument cluster, see Driver Attention Camera [210](#)
 Camera lenses, care [377](#)
 Camera perspective, automatic [249](#)
 Camera perspective, semi-automatic [249](#)
 Camera, rearview camera [248](#)
 Cameras, see Vehicle sensors [35](#)
 Camera view aid lines [246](#)
 Can holder, front, see Cup holder, front [302](#)
 Can holder, rear, see Cup holder, rear [302](#)
 Captain's Chair, see Executive Lounge Seating [108](#)

Care [372](#)
 Care, displays, screens [375](#)
 Care, Head-up display [375](#)
 Care, light-alloy wheels [375](#)
 Care, vehicle [374](#)
 Cargo [304](#)
 Cargo area [304](#)
 Cargo area, securing, see Valet parking mode [95](#)
 Cargo straps, see Lashing eyes in the cargo area [305](#)
 Car key, see Vehicle key [74](#)
 Carpet, care [376](#)
 Car seats, see Transporting children safely [120](#)
 Car wash [372](#)
 Car wash, automatic [372](#)
 Car wash view [251](#)
 Catalytic converter, see Hot exhaust gas system [309](#)
 CBS, see Condition Based Service [358](#)
 Cell phone, see Owner's Manual for Navigation, Entertainment and Communication [6](#)
 Center armrest, front [301](#)
 Center armrest, rear [301](#)
 Center console [32](#)
 Central display area, instrument cluster [155](#)
 Central Information Display (CID), see Control display [48](#)
 Central locking switch, see Central locking system [93](#)
 Central locking system [93](#)
 Central screen, see Control display [48](#)
 Changes, technical, see For Your Own Safety [8](#)
 Change, wheels and tires [327](#)
 Changing parts [360](#)
 Changing wheels [342](#)
 Charging cradle [294](#)
 Charging smartphone, see Wireless charging tray [294](#)
 Charging tray for smartphones, see Wireless charging tray [294](#)
 Chassis number, see Vehicle identification number [13](#)
 Check Control [144](#)
 Checking the engine oil level electronically [353](#)
 Children, seating position [120](#)

- Children, transporting safely [120](#)
 - Child restraint seats [120](#)
 - Child restraint systems, mounting [121](#)
 - Child restraint systems, see Transporting children safely [120](#)
 - Child safety latch [125](#)
 - Child safety locks [125](#)
 - Child seat installation [121](#)
 - Child seat, mounting [121](#)
 - Child seat mountings LATCH [122](#)
 - Child seats, see Transporting children safely [120](#)
 - Chrome-plated surfaces, care [375](#)
 - Chrome surfaces, care [375](#)
 - Cleaning, see Care [374](#)
 - Climate comfort laminated safety glass [310](#)
 - Climate comfort windshield [310](#)
 - Climate control [274](#)
 - Climate, fresh air intake [373](#)
 - Closing with the Key Card [89](#)
 - Closing with the smartphone, see BMW Digital Key [90](#)
 - Clothes hooks [303](#)
 - Coasting [314](#)
 - Coasting with idling engine [314](#)
 - Coat hooks [303](#)
 - Collision warning systems [178](#)
 - Comfort Access [80](#)
 - Comfort entry [110](#)
 - Comfort exit [110](#)
 - Communication, see Owner's Manual for Navigation, Entertainment and Communication [6](#)
 - Compact wheel, see Emergency wheel [346](#)
 - Comparison of entries, see Entry comparison [46](#)
 - Compartments in the doors [301](#)
 - Compressor [330](#)
 - Concierge Service, see BMW Assist [364](#)
 - Condensation on the window surfaces [281](#)
 - Condensation water under the parked vehicle [312](#)
 - Condensation, windshield [281](#)
 - Condition Based Service [358](#)
 - ConnectedDrive, see Owner's Manual for Navigation, Entertainment and Communication [6](#)
 - ConnectedDrive services, see Owner's Manual for Navigation, Entertainment and Communication [6](#)
 - Connected Music, see Owner's Manual for Navigation, Entertainment, Communication [6](#)
 - Connecting mobile devices to the vehicle [62](#)
 - Connection, electrical devices, see Sockets [292](#)
 - Consumption, see Trip data [156](#)
 - Contactless operation of the trunk lid [88](#)
 - Contacts, see Owner's Manual for Navigation, Entertainment, Communication [6](#)
 - Continued driving with a flat tire, see Tire Pressure Monitor [334](#)
 - Continued driving with flat tire, see Flat tire monitor [341](#)
 - Control display [48](#)
 - Controller [49](#)
 - Control systems, driving stability [212](#)
 - Convoy Assistant, Assisted Driving Mode Plus, see Speed control systems [218](#)
 - Coolant [355](#)
 - Coolant level [356](#)
 - Coolant temperature, see Engine temperature [154](#)
 - Cooling, maximum [280](#)
 - Cooling system [355](#)
 - Cornering light [168](#)
 - Corrosion, brake disks [311](#)
 - Cosmetic mirror [292](#)
 - Cross Traffic Warning [203](#)
 - Cruise Control, Cruise Control, see Speed control systems [218](#)
 - Cruise Control, see Speed control systems [218](#)
 - Cruising range [159](#)
 - Cup holder, front [302](#)
 - Cup holder, rear [302](#)
 - Current driving condition [160](#)
 - Curved Display [48](#)
 - Cushions for rear head restraints, care [376](#)
 - Customer support [364](#)
- ## D
- Damage, tires [326](#)
 - Dashboard [30](#)
 - Dashboard, see Instrument cluster [141](#)

- Dashcam, see BMW Drive Recorder [205](#)
- Data memory [10](#)
- Data protection, settings [68](#)
- Data, see Personal data, deleting [68](#)
- Data, technical [378](#)
- Date [158](#)
- Day, see Date [158](#)
- Daytime driving lights [167](#)
- Daytime running lights [167](#)
- Deep sleep mode [41](#)
- Defrosting, windshield [281](#)
- Deleting, personal data [68](#)
- Departure schedule, see Pre-ventilation [285](#)
- Departure time, preconditioning via Remote Engine Start [288](#)
- Departure time, pre-ventilation [286](#)
- Destination input [6](#)
- Diagnostic connection [359](#)
- Diagnostic socket [359](#)
- Digital Key [90](#)
- Digital Key, see BMW Digital Key [90](#)
- Dimensions [378](#)
- Dimmable interior mirror [117](#)
- Dimming exterior mirror [116](#)
- Direct dial buttons, see Shortcuts [47](#)
- Display and operating concept, see BMW iDrive [44](#)
- Display, iDrive [46](#)
- Displaying information on parking assistance, see Assisted View [158](#)
- Display lighting, see Instrument lighting [168](#)
- Display panel, see Instrument cluster [141](#)
- Displays [141](#)
- Displays and icons [7](#)
- Displays for the vehicle, see Live Vehicle [142](#)
- Display speed limit, see Speed Limit Info [216](#)
- Disposal, coolant [356](#)
- Disposal, vehicle battery [362](#)
- Distance Control, see Speed control systems [218](#)
- Distance to vehicle driving ahead, see Speed control systems [218](#)
- Distance Warning, see Park Distance Control [254](#)
- Door handle lighting, see Welcome lights [166](#)
- Door opening angle [253](#)
- Drive mode Efficient, see My Modes [134](#)
- Drive mode Personal, see My Modes [134](#)
- Drive mode Sport, see My Modes [134](#)
- Drive-off assistant, see Dynamic Stability Control [212](#)
- Drive-off monitoring [258](#)
- Drive-off support [214](#)
- Drive power reduced [153](#)
- Driver activity, see Driver Attention Camera [210](#)
- Driver Assistance, parking, see Parking assistance systems [243](#)
- Driver assistance systems [216](#)
- Driver Attention Camera [210](#)
- Drive-ready state, see Operating condition of the vehicle [40](#)
- Drive Recorder [205](#)
- Driver profiles [69](#)
- Driver profiles, welcome screen [69](#)
- Drive sound, see BMW IconicSounds [273](#)
- Driving [126](#)
- Driving Assistant, see Collision warning systems [178](#)
- Driving comfort [271](#)
- Driving condition, display [160](#)
- Driving dynamics, setting [213](#)
- Driving Experience Control, see My Modes [134](#)
- Driving notes [308](#)
- Driving off, see Drive-off support [214](#)
- Driving stability control systems [212](#)
- Driving, Start/Stop button [126](#)
- Driving through water [310](#)
- Driving tips, see General driving notes [308](#)
- DSC, see Dynamic Stability Control [212](#)
- DTC, see Setting for increased driving dynamics [213](#)
- Dynamic Drive [271](#)
- Dynamic Stability Control [212](#)
- Dynamic Traction Control, see Setting for increased driving dynamics [213](#)

E

- Efficiency Coach, Efficient mode [315](#)
- Efficient drive mode [314](#)
- Efficient Mode [314](#)
- Efficient Mode, see My Modes [134](#)

- Efficient rolling, see Current driving condition [160](#)
- Electronic oil measurement [353](#)
- Electronic Stability Program ESP, see Dynamic Stability Control [212](#)
- Emergency brake, see Emergency Stop Assistant [202](#)
- Emergency braking, see PostCrash – iBrake [209](#)
- Emergency call [366](#)
- Emergency release, fuel filler flap [319](#)
- Emergency release, glove compartment [300](#)
- Emergency release, transmission lock [131](#)
- Emergency Stop Assistant [202](#)
- Emergency unlocking, trunk lid [89](#)
- Emergency wheel [346](#)
- Energy savings, see Gear shift indicator [152](#)
- Engine, automatic Start/Stop function [126](#)
- Engine compartment [348](#)
- Engine coolant [355](#)
- Engine idling when driving, see Coasting [314](#)
- Engine noise, artificial, see Acoustic pedestrian protection [126](#)
- Engine oil filler neck [354](#)
- Engine oil, topping up [354](#)
- Engine oil types to add [354](#)
- Engine sound, see BMW IconicSounds [273](#)
- Engine start, see Drive-ready state [42](#)
- Engine start, see Jump-starting [367](#)
- Engine stopping, see Drive-ready state [42](#)
- Engine temperature [154](#)
- Entering a destination, see Owner's Manual for Navigation, Entertainment, Communication [6](#)
- Entering an address, navigation, see Owner's Manual for Navigation, Entertainment and Communication [6](#)
- Entertainment, see Owner's Manual for Navigation, Entertainment and Communication [6](#)
- Entertainment, selection list in the instrument cluster [151](#)
- Entry assistance, exit assistance [110](#)
- Entry comparison [46](#)
- Equipment, interior [290](#)
- Error indicators, see Check Control [144](#)
- eSIM telephony, see Owner's Manual for Navigation, Entertainment, Communication [6](#)
- ESP Electronic Stability Program, see Dynamic Stability Control [212](#)
- Evasion Assistant, see Forward Collision Mitigation [179](#)
- Event Data Recorder EDR [13](#)
- Exchange, wheels and tires [327](#)
- Executive Drive Pro [271](#)
- Executive Lounge Seating [108](#)
- Exhaust gas particulate filter [309](#)
- Exhaust gas system [309](#)
- Exhaust, see Exhaust gas system [309](#)
- Exit Warning [188](#)
- Exterior lighting, locked vehicle [167](#)
- Exterior mirror [115](#)
- Exterior mirror, Automatic Curb Monitor [116](#)
- Exterior mirror cameras, see Vehicle sensors [35](#)
- External start, see Jump-starting [367](#)
- Eyelet for towing [370](#)
- Eyes, see Lashing eyes in the cargo area [305](#)
- ## F
- Factory settings, see Vehicle data, resetting [68](#)
- Failure message, see Check Control [144](#)
- Fan after run, see Exhaust gas particulate filter [309](#)
- Fastening seat belts, see Seat belts [110](#)
- Fatigue Alert [209](#)
- Fatigue Alert, see Driver Attention Camera [210](#)
- Fatigue warner, see Fatigue Alert [209](#)
- Fault indicators, see Check Control [144](#)
- Filler neck for engine oil [354](#)
- Filter, see Interior filter [285](#)
- Fine wood parts, care [376](#)
- First-aid kit [364](#)
- Flag bracket [312](#)
- Flat tire, changing wheels [342](#)
- Flat tire, continued driving, see Flat tire monitor [341](#)
- Flat tire, continued driving, see Tire Pressure Monitor [334](#)
- Flat tire message, see Flat tire monitor [342](#)
- Flat tire message, see Tire Pressure Monitor [338](#)
- Flat tire monitor [341](#)

Flat tire, repairing [329](#)
 Flat tire, see Flat tire monitor [341](#)
 Flat tire, see Tire Pressure Monitor [334](#)
 Flat tire warning light, see Flat tire monitor [342](#)
 Flat tire warning light, see Tire Pressure Monitor [338](#)
 Floods, driving through [310](#)
 Floor carpet, care [376](#)
 Floor mats, care [376](#)
 Fold-away position, wiper [172](#)
 Fold-out position [172](#)
 Foot brake [310](#)
 Footrest [108](#)
 Forward Collision Mitigation [179](#)
 Forward Collision Warning, see Forward Collision Mitigation [179](#)
 For Your Own Safety [8](#)
 Fresh air intake, climate [373](#)
 Front airbags [174](#)
 Front camera, see Vehicle sensors [35](#)
 Front lights, replacing, see Lights and bulbs [360](#)
 Front passenger's side exterior mirror, tilting down, see Automatic Curb Monitor [116](#)
 Front passenger airbags, automatic deactivation [176](#)
 Front radar sensor, see Vehicle sensors [35](#)
 Front-seat passenger airbag, indicator light [177](#)
 Front seats [104](#)
 Fuel [351](#)
 Fuel filler cap [318](#)
 Fuel filler flap [318](#)
 Fuel gauge [159](#)
 Fuel quality [351](#)
 Fuel recommendation [351](#)
 Fuel tank, see Filling capacity [379](#)
 Fuses [363](#)

G

Garage door opener, see Integrated Universal Remote Control [290](#)
 Gasoline [351](#)
 Gasoline particulate filter, see Exhaust gas particulate filter [309](#)
 Gasoline quality [352](#)

Gear change, Steptronic transmission [128](#)
 General driving notes [308](#)
 Gesture Control [59](#)
 Gestures, see BMW Gesture Control [59](#)
 Glare shield, see Sun visor [292](#)
 Glove compartment [300](#)
 G-Meter [158](#)
 GPS navigation, navigation, see Owner's Manual for Navigation, Entertainment, Communication [6](#)
 Gross vehicle weight, approved [379](#)
 Guest profile, see BMW ID [69](#)

H

Handbrake, see Parking brake [137](#)
 Hand-held transmitter, alternating code [291](#)
 Hands-free device, see Owner's Manual for Navigation, Entertainment, Communication [6](#)
 Hands-free system [6](#)
 Hazard warning system [364](#)
 Head airbag [174](#)
 Headlight control, automatic [165](#)
 Headlight flasher [162](#)
 Headlight glass [361](#)
 Headlights, care [373](#)
 Headlights, replacing, see Lights and bulbs [360](#)
 Headlights, turning up, dimming, see Automatic High Beam Assistant [163](#)
 Headliner [33](#)
 Head restraint cushions, care [376](#)
 Head restraint pillow [114](#)
 Head restraints and seats [104](#)
 Head restraints, front [112](#)
 Head restraints, rear [113](#)
 Head-up display [143](#)
 Head-up display, care [375](#)
 Head-up display, position, saving see Memory function [118](#)
 Heated steering wheel [283](#)
 Heavy cargo, stowing [305](#)
 Height, vehicle [378](#)
 High beams [162](#)
 Highway Assistant, Assisted Driving Mode Plus, see Speed control systems [218](#)

Hills [311](#)
Holder for beverages, front [302](#)
Holder for beverages, rear [302](#)
HomeLink, see Integrated Universal Remote Control [290](#)
Homepage, see Internet [7](#)
Hood [348](#)
Horn [30](#)
Hotel function, see Valet parking mode [95](#)
Hot exhaust gas system [309](#)
Hotline, see Customer support [364](#)
Hour, see Time [158](#)

I

iBrake – PostCrash [209](#)
Ice warning, see Outside temperature [154](#)
IconicSounds [273](#)
Icons and displays [7](#)
Identification marks, tires [324](#)
Identification number, see Vehicle identification number [13](#)
iDrive [44](#)
ID transmitter, see Vehicle key [74](#)
Ignition key, see Vehicle key [74](#)
Inclination [105](#)
Indicator light, front-seat passenger airbag [177](#)
Indicator lights [145](#)
Individual air distribution [279](#)
Individual settings, see BMW ID [69](#)
Inductive charging, smartphone, see Wireless charging tray [294](#)
Information [6](#)
Information on Driver Assistance, displaying, see Assisted View [158](#)
Information window, control display [47](#)
Initialization, see flat tire monitor [341](#)
Input, iDrive [46](#)
Installation of child restraint systems [121](#)
Instrument cluster [141](#)
Instrument lighting [168](#)
Instrument panel, see Instrument cluster [141](#)
Integral Active Steering [215](#)
Integrated key [75](#)
Integrated Owner's Manual in the vehicle [6](#)
Integrated Universal Remote Control [290](#)

Intelligent emergency call [366](#)
Intelligent Personal Assistant [53](#)
Intended use [8](#)
Interior camera [296](#)
Interior equipment [290](#)
Interior filter [285](#)
Interior lights [168](#)
Interior lights, locked vehicle [167](#)
Interior mirror [117](#)
Interior mirror, automatic dimming feature [117](#)
Interior motion sensor [98](#)
Internet page [7](#)
Intersection Collision Warning, see Forward Collision Mitigation [179](#)
Interval indicator, see Service notification [161](#)

J

Jacking points [345](#)
Jacking points for the vehicle jack [345](#)
Jam protection system, windows [101](#)
Journey data [156](#)
Joystick, Steptronic transmission [128](#)
Jump-starting [367](#)
Jump-starting terminals [368](#)
Jump-start terminals [368](#)

K

Kenaf, care [376](#)
Key Card [89](#)
Keyless Go, see Comfort Access [80](#)
Key, mechanical [75](#)
Key, see Vehicle key [74](#)
Kickdown, Steptronic transmission [128](#)
Knee airbag [175](#)

L

Labeling [324](#)
Lane boundary [190](#)
Lane Change Assistant [233](#)
Lane change with active destination guidance [240](#)
Lane departure warning [190](#)

Lane Keeping Assistant with active side collision protection, see Side Collision Warning [195](#)

Lane keeping, Assisted Driving Mode, see Speed control systems [218](#)

Lane lines, additional camera view displays [246](#)

Lane threshold, warning [190](#)

Language, setting [55](#)

Lashing eyes in the cargo area [305](#)

LATCH child seat mountings [122](#)

Lateral Parking Aid [249](#)

Launch Control [132](#)

Leather care [374](#)

LED headlights, changing, see Lights and bulbs [360](#)

Legrest [108](#)

Length, vehicle [378](#)

Letters and numbers, entering [46](#)

Level control, see Two-axle level control [271](#)

Light-alloy wheels, care [375](#)

Light carpet, see Welcome Light Carpet [166](#)

Light in exterior mirror, see Active Blind Spot Detection [193](#)

Light in exterior mirror, see Cross Traffic Warning [203](#)

Lighting [164](#)

Lighting, speakers [170](#)

Light replacement, see Lights and bulbs [360](#)

Lights [162](#)

Lights and bulbs [360](#)

Lights, care [373](#)

Light switch [164](#)

List, instrument cluster, see Selection lists [151](#)

Live Cockpit Plus, see BMW Curved Display [48](#)

Live Cockpit Professional, see BMW Curved Display [48](#)

Live Vehicle [142](#)

Load [305](#)

Loading [304](#)

Loading the cargo area, see Cargo [304](#)

Local time, see Time [158](#)

Locking, see Opening and Closing [74](#)

Locking, settings [95](#)

Locking the rear automatic climate control [276](#)

Lock, lug bolts [344](#)

Long idle times, see Deep sleep mode [41](#)

Loop [370](#)

Low beams [166](#)

Lower back support, see Lumbar support [106](#)

Lug bolt lock [344](#)

Luggage straps [305](#)

Lumbar massage, see Rear seat massage [109](#)

Lumbar massage, see Seat massage [107](#)

Lumbar support [106](#)

M

Maintenance [358](#)

Maintenance recommendation, see Condition Based Service [358](#)

Maintenance, see Service notification [161](#)

Maintenance system, BMW [358](#)

Make-up mirror [292](#)

Malfunction, vehicle key [77](#)

Maneuver Assistant [264](#)

Manual brake, see Parking brake [137](#)

Manually unlocking doors, see Integrated key [75](#)

Manual mode, transmission [131](#)

Map, see Owner's Manual for Navigation, Entertainment, Communication [6](#)

Map update, see Owner's Manual for Navigation, Entertainment, Communication [6](#)

Matte paintwork [374](#)

Matt paint, care [374](#)

Maximum cooling [280](#)

Maximum speed, display, see Speed Limit Info [216](#)

Maximum speed, winter tires [328](#)

Medical supplies, see First-aid kit [364](#)

Memory function [118](#)

Messages, see Check Control [144](#)

Messages, see Owner's Manual for Navigation, Entertainment, Communication [6](#)

Meters, see Instrument cluster [141](#)

Microfilter, see Interior filter [285](#)

Mild Hybrid technology [362](#)

Minimum tread depth, tires [326](#)

Minute, see Time [158](#)

Mirror position, saving, see Memory function [118](#)

- Mobile devices, connecting [62](#)
- Mobile phone, see Owner's Manual for Navigation, Entertainment and Communication [6](#)
- Mobile radio in the vehicle [310](#)
- Mobile Service, see BMW Accident Assistance [365](#)
- Mobile Service, see BMW Roadside Assistance [365](#)
- Mobility System, see Tire repair set [329](#)
- MODE button, see Speed control systems [218](#)
- Modifications, technical, see For Your Own Safety [8](#)
- Moisture in headlight, see Headlight glass [361](#)
- Monitor, see Control display [48](#)
- Mounting of child restraint systems [121](#)
- MP3 player, see Owner's Manual for Navigation, Entertainment, Communication [6](#)
- Multifunction hook [305](#)
- Multi-function steering wheel [30](#)
- Multifunction steering wheel, buttons [30](#)
- My BMW app, see Owner's Manual for Navigation, Entertainment, Communication [6](#)
- My Modes [134](#)
- ## N
- Neck restraints, front, see Head restraints, front [112](#)
- Neck restraints, rear, see Head restraints, rear [113](#)
- Neutral cleaner, see Light-alloy wheels, care [375](#)
- Notifications, see Owner's Manual for Navigation, Entertainment, Communication [6](#)
- No Turn on Red function [201](#)
- Nylon rope for tow-starting/towing [370](#)
- ## O
- OBD, see On-board diagnosis [359](#)
- Obstacle marking, additional camera view displays [246](#)
- Octane number, see Gasoline quality [352](#)
- Odometer, see Trip data [156](#)
- OFF display, instrument cluster, see Standby and Drive-ready state [154](#)
- Oil filler neck [354](#)
- Oil level, checking electronically [353](#)
- Oil service interval, see Service notification [161](#)
- Oil, topping up [354](#)
- Oil types to add, engine [354](#)
- Old battery [362](#)
- On-board computer, see Trip data [156](#)
- On-board diagnosis [359](#)
- Onboard toolkit [360](#)
- On-call service, see BMW Accident Assistance [365](#)
- On-call service, see BMW Roadside Assistance [365](#)
- One-touch signaling [162](#)
- Opening and closing [74](#)
- Opening and closing the cargo area [86](#)
- Opening and closing the trunk lid [86](#)
- Opening with the Key Card [89](#)
- Opening with the smartphone, see BMW Digital Key [90](#)
- Operating condition of the vehicle [40](#)
- Operating principle, see BMW iDrive [44](#)
- Operating system, see BMW iDrive [44](#)
- Operating temperature, see Engine temperature [154](#)
- Operation via voice [53](#)
- Optional equipment, see Vehicle equipment [8](#)
- Outside temperature [154](#)
- Overheating of the engine, see Engine temperature [154](#)
- Overwintering, see Long-term vehicle storage [377](#)
- Owner's Manual via voice operation, BMW Intelligent Personal Assistant [55](#)
- ## P
- Paint, vehicle care [374](#)
- Paintwork [374](#)
- Panel heating [283](#)
- Panic alarm, see Panic mode [98](#)
- Panic mode [98](#)
- Panorama View [251](#)
- Panorama View, see Panorama View [251](#)
- Panoramic display, see Owner's Manual for Navigation, Entertainment, Communication [6](#)

Park Distance Control [254](#)
 Parking aid lines, additional camera view displays [246](#)
 Parking assistance systems [243](#)
 Parking assistant [259](#)
 Parking Assistant Plus, see Parking assistance systems [243](#)
 Parking Assistant Professional, see Parking assistance systems [243](#)
 Parking Assistant, see Park Distance Control [254](#)
 Parking Assistant, see Parking assistance systems [243](#)
 Parking brake [137](#)
 Parking brake function, see Active Park Distance Control [257](#)
 Parking lights [166](#)
 Parking view, gesture control [60](#)
 Parking with Automatic Hold [139](#)
 Particulate filter, see Exhaust gas particulate filter [309](#)
 Parts and accessories [9](#)
 Pathway lighting [167](#)
 Pathway lighting, turning on [167](#)
 Payload [305](#)
 Payload, technical data [379](#)
 PDC, see Park Distance Control [254](#)
 Pedestrian protection, acoustic [126](#)
 Pedestrian Warning, see Forward Collision Mitigation [179](#)
 Pennant [312](#)
 Performance display, see Sport displays [161](#)
 Personal Assistant [53](#)
 Personal data, deleting [68](#)
 Personal eSIM, see Owner's Manual for Navigation, Entertainment, Communication [6](#)
 Personal hotspot, see Owner's Manual for Navigation, Entertainment, Communication [6](#)
 Personal Mode, see My Modes [134](#)
 Personal profile, see BMW ID [69](#)
 Personal settings [68](#)
 Physical units, see Units of measurement, setting [159](#)
 Pillow for head restraints in the rear [114](#)
 Plastic parts, care [376](#)
 Pop-up [47](#)

Possible gestures, gesture control [60](#)
 PostCrash – iBrake [209](#)
 Power Display, instrument cluster [153](#)
 Power failure [362](#)
 Power interruption [362](#)
 Power Meter, see Power Display [153](#)
 Power windows [99](#)
 Pre-conditioning [286](#)
 Pressure monitor, tire, see Tire Pressure Monitor [334](#)
 Pressure, tires [320](#)
 Pressure warning, see Flat tire monitor [341](#)
 Pressure warning, see Tire Pressure Monitor [334](#)
 Pre-ventilation [285](#)
 Prevention of rear-end collision, see Rear-end collision preparation [197](#)
 Primary user, see BMW ID [70](#)
 Protective function, windows, see Jam protection system [101](#)
 Push-and-turn reel, see Controller [49](#)

R

Racing track [312](#)
 Radar sensors, see Vehicle sensors [35](#)
 Radiator fan, see Exhaust gas particulate filter [309](#)
 Radiator fluid [355](#)
 Radio information, see Owner's Manual for Navigation, Entertainment, Communication [6](#)
 Radio, see Owner's Manual for Navigation, Entertainment and Communication [6](#)
 Radio stations, see Owner's Manual for Navigation, Entertainment, Communication [6](#)
 Rain sensor [171](#)
 READY display, instrument cluster, see Standby and Drive-ready state [154](#)
 Real Time Traffic Information, see Owner's Manual for Navigation, Entertainment, Communication [6](#)
 Rear automatic climate control [274](#)
 Rear axle steering, see Integral Active Steering [215](#)
 Rear-end collision preparation [197](#)

- Rear lights, replacing, see Lights and bulbs [360](#)
- Rear seat massage [109](#)
- Rear seats [107](#)
- Rearview camera [248](#)
- Rearview camera, see Vehicle sensors [35](#)
- Rear-view mirror, exterior [115](#)
- Rearview mirror, interior [117](#)
- Rear window defroster [282](#)
- Recirculated-air mode [280](#)
- Recirculating air filter, see Interior filter [285](#)
- Recommended tire brands [328](#)
- Recuperation, adaptive [313](#)
- Reduced drive power [153](#)
- Refueling [318](#)
- Release fuel filler flap, manual [319](#)
- Remote 3D View [253](#)
- remote control, see Remote Control Parking [267](#)
- Remote control, see Vehicle key [74](#)
- Remote control, universal [290](#)
- Remote Engine Start, see Stationary climate control [286](#)
- Remote parking [267](#)
- Remote services, see Owner's Manual for Navigation, Entertainment, Communication [6](#)
- Remote Software Upgrade [64](#)
- Renewal, wheels and tires [327](#)
- Replacement, wheels and tires [327](#)
- Replacing bulbs, see Lights and bulbs [360](#)
- Replacing light diodes, see Lights and bulbs [360](#)
- Replacing parts [360](#)
- Replacing the battery, vehicle key [75](#)
- Reporting safety malfunctions [14](#)
- Reserve warning, see Range [159](#)
- Reservoir, washer fluid [356](#)
- Resetting, vehicle data [68](#)
- Reset, Tire Pressure Monitor [337](#)
- Reset, vehicle settings [68](#)
- Restricted Driving, see BMW Digital Key [90](#)
- Retreaded tires [328](#)
- Reversing Assistant [268](#)
- Risk of collision when exiting [188](#)
- Roadside Assistance, see BMW Roadside Assistance [365](#)
- Roadside parking lights [166](#)
- Roller sunblind, rear window [101](#)
- Roller sunblinds, rear side windows [101](#)
- Rolling code hand-held transmitter [291](#)
- Rolling to a stop with engine decoupled, see Coasting [314](#)
- Roll stabilization, see Active roll stabilization [271](#)
- RON, see gasoline quality [352](#)
- Roofliner [33](#)
- Rope for tow-starting/towing [370](#)
- Route and Intersection Assistant, see Adjusting speed to route [239](#)
- Route, navigation, see Owner's Manual for Navigation, Entertainment, Communication [6](#)
- Rubber components, care [376](#)

S

- Safe braking [310](#)
- Safe Exit, see Exit warning [188](#)
- Safe Share function, see BMW Digital Key [90](#)
- Safety and warning, see Collision warning systems [178](#)
- Safety locks, doors, and windows [125](#)
- Safety package, see Active Protection [208](#)
- Safety switch, windows [103](#)
- Safety systems, see Airbags [174](#)
- Safety systems, see Collision warning systems [178](#)
- Satellite radio, see Owner's Manual for Navigation, Entertainment, Communication [6](#)
- Saved stations, see Owner's Manual for Navigation, Entertainment, Communication [6](#)
- Screen, see BMW Curved Display [48](#)
- Screen, see Control display [48](#)
- Sealing compound, see Tire repair set [329](#)
- Seamless mode change, see Remote Control Parking [267](#)
- Seat belt reminder, see Seat belt warning [111](#)
- Seat belts [110](#)
- Seat belts, care [376](#)
- Seat belt warning [111](#)
- Seat calibration [107](#)
- Seat cooling [282](#)
- Seat cooling distribution [282](#)

- Seat heating [282](#)
- Seating position for children [120](#)
- Seat massage [107](#)
- Seat position, saving, see Memory function [118](#)
- Seats and head restraints [104](#)
- Seats, front [104](#)
- Seats, rear [107](#)
- Securing, cargo [305](#)
- Selection list on the instrument cluster [151](#)
- Selector lever, Steptronic transmission [128](#)
- Semi-automatic camera perspective [249](#)
- Sensors, care [377](#)
- Service and warranty [10](#)
- Service notification [161](#)
- Service notifications, see Condition Based Service [358](#)
- SET button, see Speed control systems [218](#)
- Setting driving dynamics, see My Modes [134](#)
- Setting the time, see Time [158](#)
- Shift lights [155](#)
- Shift paddles on the steering wheel [131](#)
- Shift point display [152](#)
- Shift point indicator, tachometer [155](#)
- Shift recommendation for fuel-efficient driving, see Shift point display [152](#)
- Shortcuts, iDrive [47](#)
- Side airbag [174](#)
- Side Collision Warning [195](#)
- Side protection, see Automatic camera perspective [249](#)
- Side view [250](#)
- Signaling, horn [30](#)
- Signals when unlocking, see Confirmation signals [96](#)
- SIM Reader, see Owner's Manual for Navigation, Entertainment, Communication [6](#)
- Sitting safely [104](#)
- Sleep mode, see Operating condition of the vehicle [40](#)
- Slipperiness, see Outside temperature [154](#)
- Slippery road, see Outside temperature [154](#)
- Smallest turning circle, vehicle [378](#)
- Smartphone, see Owner's Manual for Navigation, Entertainment and Communication [6](#)
- Smartphone, using via voice control [57](#)
- Snapshot camera, see Interior camera [296](#)
- Snow chains [333](#)
- Sockets, electrical devices [292](#)
- Soft-close automatic, doors [94](#)
- Soft-close automatic function [94](#)
- Software Update, see Remote Software Upgrade [64](#)
- Software Upgrade, see Remote Software Upgrade [64](#)
- Soot particulate filter, see Exhaust gas particulate filter [309](#)
- SOS button, see Intelligent emergency call [366](#)
- Sound settings, see Owner's Manual for Navigation, Entertainment, Communication [6](#)
- Sound system, see Owner's Manual for Navigation, Entertainment, Communication [6](#)
- Spare tire, see Emergency wheel [346](#)
- Speaker lighting [170](#)
- Speed control systems [218](#)
- Speed Limit Assist [237](#)
- Speed Limit Assistant [237](#)
- Speed limit device, speed limiter, see Speed control systems [218](#)
- Speed limit, display, see Speed Limit Info [216](#)
- Speed limiter, manual, see Speed control systems [218](#)
- Speed Limit Info [216](#)
- Speed warning [216](#)
- Sport Boost function [133](#)
- Sport displays [161](#)
- Sport Mode, see My Modes [134](#)
- SPORT PLUS setting, see Setting for increased driving dynamics [213](#)
- Sport program, transmission [128](#)
- Stability control systems [212](#)
- Standard equipment, see Vehicle equipment [8](#)
- Standby, see Operating condition of the vehicle [40](#)
- Start/stop, automatic function [126](#)
- Start/Stop button [126](#)
- Starting aid terminals [368](#)
- Starting, see Drive-ready state [42](#)
- Starting the engine, see Drive-ready state [42](#)
- Starting the engine with the Key Card [89](#)
- Stationary climate control via Remote Engine Start [286](#)

- Stations, see Owner's Manual for Navigation, Entertainment, Communication [6](#)
- Status control display, tires [336](#)
- Status information, iDrive [45](#)
- Status of Owner's Manual [8](#)
- Status, vehicle [160](#)
- Steering column adjustment [117](#)
- Steering, see Integral Active Steering [215](#)
- Steering wheel, adjusting [117](#)
- Steering wheel, buttons [30](#)
- Steering wheel heating [283](#)
- Steering wheel position, saving, see Memory function [118](#)
- Steptronic Sport transmission, see Steptronic transmission [128](#)
- Steptronic transmission [128](#)
- Stopping the engine, see Drive-ready state [42](#)
- Storage compartment, cargo area [306](#)
- Storage compartments [300](#)
- Storage, tires [329](#)
- Storing the vehicle [377](#)
- Stowage, cargo [305](#)
- Straps for cargo, see Lashing eyes in the cargo area [305](#)
- Summer tires, tread [326](#)
- Sun visor [292](#)
- Supplementary Owner's Handbooks [7](#)
- Supplementary Owner's Manuals [7](#)
- Switches, see Dashboard [30](#)
- SYNC program, automatic climate control [281](#)
- System language, setting, see Language, setting [55](#)
- ## T
- Tachometer [153](#)
- Tail light, changing, see Lights and bulbs [360](#)
- Taking the vehicle out of service [377](#)
- Tank volume [379](#)
- Technical changes, see For Your Own Safety [8](#)
- Technical data [378](#)
- Telephone, see Owner's Manual for Navigation, Entertainment and Communication [6](#)
- Telephone, selection list in the instrument cluster [151](#)
- Teleservices, see Owner's Manual for Navigation, Entertainment, Communication [6](#)
- Temperature, automatic climate control [277](#)
- Temperature display, see outside temperature [154](#)
- Theft alarm system, see Alarm system [97](#)
- Thigh support [106](#)
- Through-loading system [306](#)
- Tilt alarm sensor [98](#)
- Tilt, backrest [105](#)
- Tilting down, front passenger's side exterior mirror, see Automatic Curb Monitor [116](#)
- Time [158](#)
- Time of day, see Time [158](#)
- Time setting, automatic [158](#)
- Time zone [158](#)
- Tire brands, recommendation [328](#)
- Tire change [327](#)
- Tire damage [326](#)
- Tire identification marks [324](#)
- Tire inflation pressure [320](#)
- Tire marking [324](#)
- Tire pressure [320](#)
- Tire Pressure Monitor [334](#)
- Tire pressure monitoring, see Flat tire monitor [341](#)
- Tire Pressure Monitor, reset [337](#)
- Tire pressure, tires [320](#)
- Tire pressure warning, see Flat tire monitor [341](#)
- Tire repair set [329](#)
- Tires and wheels [320](#)
- Tire sealant, see Tire repair set [329](#)
- Tire settings [335](#)
- Tire tread [326](#)
- Title, gesture control [60](#)
- Tools [360](#)
- Torque display, see Sport displays [161](#)
- Touch Command [58](#)
- Touchpad, Controller [51](#)
- Tow bar [370](#)
- Tow fitting [370](#)
- Towing [368](#)
- Tow rope [370](#)
- Tow-starting [368](#)

Traction control system, see Dynamic Stability Control [212](#)

Traffic bulletins, see Owner's Manual for Navigation, Entertainment, Communication [6](#)

Traffic Jam Assistant, Assisted Driving Mode Plus, see Speed control systems [218](#)

Traffic light and sign warning [198](#)

Transmission, see Steptronic transmission [128](#)

Transporting children safely [120](#)

Travel & Comfort System [294](#)

Tread, tires [326](#)

Trip data [156](#)

Trip odometer, see Trip data [156](#)

Trunk, emergency unlocking [89](#)

Trunk lid, contactless operation [88](#)

Trunk lid, emergency unlocking [89](#)

Trunk, see Cargo area [304](#)

Turn indicators, see Turn signals [162](#)

Turning circle lines, additional camera view displays [246](#)

Turning circle, vehicle [378](#)

Turning display, see No Turn on Red function [201](#)

Turn signal, indicator light [149](#)

Turn signal, replacing bulbs, see Lights and bulbs [360](#)

Turn signals [162](#)

Turn Warning, see Forward Collision Mitigation [179](#)

Two-axle level control [271](#)

U

Ultrasonic sensors, see Vehicle sensors [35](#)

Unintended alarm, see Unintentional alarm, avoiding [99](#)

Unintentional alarm, avoiding [99](#)

Units of measurement, setting [159](#)

Units, see Units of measurement, setting [159](#)

Universal remote control [290](#)

Unlocking, see Opening and Closing [74](#)

Unlocking, settings [95](#)

Unlocking the transmission lock, electronic [131](#)

Updates made after the editorial deadline [8](#)

Upgrade, see Remote Software Upgrade [64](#)

Upholstery material care [375](#)

Upper backrest, front [106](#)

Upper retaining strap, top tether [124](#)

USB audio, see Owner's Manual for Navigation, Entertainment, Communication [6](#)

USB port, position in vehicle [293](#)

Used battery, disposing of [362](#)

Use, intended [8](#)

User, see BMW ID [69](#)

Using menus, see BMW iDrive [44](#)

V

Valet parking mode [95](#)

Vanity mirror [292](#)

Variable steering, see Integral Active Steering [215](#)

Vehicle battery [361](#)

Vehicle breakdown, see Breakdown assistance [364](#)

Vehicle care [374](#)

Vehicle care products [374](#)

Vehicle data, resetting [68](#)

Vehicle equipment [8](#)

Vehicle identification number [13](#)

Vehicle issues [364](#)

Vehicle key [74](#)

Vehicle key, additional [74](#)

Vehicle key, loss [75](#)

Vehicle paint, care [374](#)

Vehicle paintwork [374](#)

Vehicle sensors [35](#)

Vehicle status [160](#)

Vehicle storage [377](#)

Ventilation [284](#)

Ventilation, see Pre-ventilation [285](#)

Venting, see Ventilation [284](#)

Version Software, see Remote Software Upgrade [64](#)

Video recording, see BMW Drive Recorder [205](#)

Video, see Owner's Manual for Navigation, Entertainment and Communication [6](#)

VIN, see Vehicle identification number [13](#)

Vision Access, see Automatic doors [82](#)

Voice activation system [53](#)

Voice control [53](#)

Voice control, see BMW Intelligent Personal Assistant [53](#)
Voice recognition [53](#)
Volume, gesture control [60](#)
Volume, see Owner's Manual for Navigation, Entertainment, Communication [6](#)

W

Wake word [54](#)
Warning for crossing traffic [203](#)
Warning function for incorrect driving direction, see Wrong Way Warning [200](#)
Warning function for oncoming traffic, see Forward Collision Mitigation [179](#)
Warning function, rear-end collision [197](#)
Warning light in exterior mirror, see Active Blind Spot Detection [193](#)
Warning light in exterior mirror, see Cross Traffic Warning [203](#)
Warning lights [145](#)
Warning messages, see Check Control [144](#)
Warning systems for collision hazards [178](#)
Warning triangle [364](#)
Warning when exiting [188](#)
Warning when opening doors, see Exit Warning [188](#)
Warranty [9](#)
Warranty Booklet, see Warranty [9](#)
Washer fluid [356](#)
Washing the vehicle [372](#)
Washing, vehicle [372](#)
Water on roads [310](#)
Water, see Condensation water under the parked vehicle [312](#)
Website, see Internet [7](#)
Weights [379](#)
Welcome Light Carpet, see Welcome light [166](#)
Welcome lights [166](#)
Welcome screen, driver profiles [69](#)
Wheelbase [378](#)
Wheel base, vehicle [378](#)
Wheel change [342](#)
Wheels and tires [320](#)
Wheels and tires, exchange [327](#)
Widgets, iDrive [45](#)

Widgets, instrument cluster, see Central display area [155](#)
Width, vehicle [378](#)
Wi-Fi connection, see Owner's Manual for Navigation, Entertainment, Communication [6](#)
Window, defrosting [281](#)
Window fogging [281](#)
Windows, powered [99](#)
Windshield cleaning system, see Wiper system [170](#)
Windshield, climate comfort [310](#)
Windshield, defrosting [281](#)
Windshield, removing condensation [281](#)
Windshield washer fluid, see Washer fluid [356](#)
Windshield wipers, see Wiper system [170](#)
Winter storage, see Long-term vehicle storage [377](#)
Winter tires [328](#)
Winter tires, tread [326](#)
Wiper blades, changing [360](#)
Wiper fluid, see Washer fluid [356](#)
Wiper, fold-away position [172](#)
Wipers, see Wiper system [170](#)
Wiper system [170](#)
Wireless charging, smartphone, see Wireless charging tray [294](#)
Wireless charging tray for smartphones [294](#)
Wood parts, care [376](#)
Wordmatch principle, see Entry comparison [46](#)
Workshop, see Service notification [161](#)
Wrong Way Warning [200](#)

X

xDrive [214](#)

Y

Yield warning [198](#)



01405A88D30 ue

California Proposition 65 Warning

For vehicles sold in California:

California Proposition 65 Warning



WARNING

Operating, servicing and maintaining a passenger vehicle or off-highway motor vehicle can expose you to chemicals including engine exhaust, carbon monoxide, phthalates, and lead, which are known to the State of California to cause cancer and birth defects or other reproductive harm. To minimize exposure, avoid breathing exhaust, do not idle the engine except as necessary, service your vehicle in a well-ventilated area and wear gloves or wash your hands frequently when servicing your vehicle. For more information go to www.P65Warnings.ca.gov/passenger-vehicle.

BMW DRIVER'S GUIDE APP.

YOUR DIGITAL VEHICLE INFORMATION.

The BMW Driver's Guide app explains the equipment of your vehicle and offers further scopes and functions:



All information surrounding navigation, entertainment and communication

Photorealistic animations for various vehicle functions

Keyword search

360° view: Explore your vehicle interactively inside and out

Smart Scan for Apple iPhone: Icon and optical character recognition on the buttons in the vehicle

Available in more than 30 languages

Can be used offline after download

