

**LINK:**  
**CONTENT & A-Z**



The Ultimate  
Driving Machine®



# OWNER'S MANUAL.

## THE BMW X1.





# **WELCOME TO BMW.**

## **Owner's Manual.**

### **BMW X1.**

Thank you for choosing a BMW.

The more familiar you are with your vehicle, the better control you will have on the road. We therefore strongly suggest:

Read this Owner's Manual before starting off in your new BMW. Also use the Integrated Owner's Manual in your vehicle. It contains important information on vehicle operation that will help you make full use of the technical features available in your BMW. The manual also contains information designed to enhance operating reliability and road safety, and to contribute to maintaining the value of your BMW.

Any updates made after the editorial deadline can be found in the appendix of the printed Owner's Manual for the vehicle.

You can find supplementary information in the additional brochures in the on-board literature.

We wish you a safe and enjoyable ride.

# TABLE OF CONTENTS

## NOTES

Information .....	8
-------------------	---

## QUICK REFERENCE

Your BMW at a glance .....	18
----------------------------	----

## AT A GLANCE

Cockpit .....	36
iDrive .....	40
Voice activation system .....	49
General settings .....	52
Owner's Manual media .....	64

## CONTROLS

Opening and closing .....	68
Seats, mirrors, and steering wheel .....	89
Transporting children safely .....	100
Driving .....	105
Displays .....	127
Lights .....	143
Safety .....	148
Driving stability control systems .....	169
Driving comfort .....	175
Climate control .....	195
Interior equipment .....	204
Storage compartments .....	217

## DRIVING TIPS

Things to remember when driving .....	224
Loading .....	228
Saving fuel .....	231

**Navigation, Entertainment and Communication can be called up via  
the Integrated Owner's Manual in the vehicle.**

## **MOBILITY**

Refueling .....	240
Fuel .....	242
Wheels and tires .....	244
Engine compartment .....	262
Engine oil .....	265
Coolant .....	269
Maintenance .....	271
Replacing components .....	273
Breakdown assistance .....	283
Care .....	290

## **REFERENCE**

Technical data .....	296
Appendix .....	298
Everything from A to Z .....	300

---

© 2018 Bayerische Motoren Werke

Aktiengesellschaft

Munich, Germany

Reprinting, including excerpts, only with the written consent of BMW AG, Munich.

US English ID5 X/18, 11 18 490

Printed on environmentally friendly paper, bleached without chlorine, suitable for recycling.



# ! NOTES

Information .....	8
-------------------	---

# Information

## Using this Owner's Manual

### Orientation

The fastest way to find information on a particular topic is by using the index.

An initial overview of the vehicle is provided in the first chapter.

### Updates made after the editorial deadline

Due to updates after the editorial deadline, differences may exist between the printed Owner's Manual and the Integrated Owner's Manual in the vehicle.

Notes on updates can be found in the appendix of the printed Owner's Manual for the vehicle.

### Owner's Manual for Navigation, Entertainment, Communication

The Owner's Manual for Navigation, Entertainment, and Communication can be obtained as printed book from the service center.

The topics are also discussed in the Integrated Owner's Manual in the vehicle.

## Additional sources of information

### Dealer's service center

A dealer's service center will be glad to answer questions at any time.

### Internet

The Owner's Manual and general information on BMW, for example on technology, are available on the Internet: [www.bmwusa.com](http://www.bmwusa.com).

## Integrated Owner's Manual in the vehicle

The Integrated Owner's Manual specifically describes features and functions found in the vehicle. The Integrated Owner's Manual can be displayed on the Control Display. Additional information, refer to page 64.

### BMW Driver's Guide app



Driver's Guide App shows the most suitable information for the selected vehicle. If possible, only equipment and functions that are actually installed in the vehicle will be explained.

### BMW Driver's Guide Web

Driver's Guide Web shows the most suitable information for the selected vehicle. If possible, only equipment and functions that are actually installed in the vehicle will be explained. Driver's Guide Web can be displayed in any current browser.

## Symbols and displays

### Symbols in the Owner's Manual

Symbol	Meaning
	Precautions that must be followed in order to avoid the possibility of injury to yourself and to others as well as serious damage to the vehicle.
	Measures that can be taken to help protect the environment.
"..."	Texts in vehicle used to select individual functions.



Symbol	Meaning
>...<	Verbal instructions to use with the voice activation system.
»...«	Responses generated by the voice activation system.

## Action steps

Action steps to be carried out are presented as numbered list. The steps must be carried out in the defined order.

1. First action step.
2. Second action step.

## Enumerations

Enumerations without mandatory order or alternative possibilities are presented as list with bullet points.

- ▷ First possibility.
- ▷ Second possibility.

## Symbols on vehicle components

 This symbol on a vehicle component indicates that further information on the component is available in the Owner's Manual.

## Vehicle features and options

This Owner's Manual describes all models and all standard, country-specific and optional equipment that is offered in the model series. Therefore, this Owner's Manual also describes and illustrates features and functions that are not available in a vehicle, for example because of the selected optional features or the country-specific version.

This also applies to safety-related functions and systems.

When using these functions and systems, the applicable laws and regulations must be observed.

For any options and equipment not described in this Owner's Manual, refer to the Supplementary Owner's Manuals.

Your dealer's service center is happy to answer any questions that you may have about the features and options applicable to your vehicle.

## Status of the Owner's Manual

### Basic information

The manufacturer of your vehicle pursues a policy of constant development that is conceived to ensure that our vehicles continue to embody the highest quality and safety standards. In rare cases, therefore, the features described in this Owner's Manual may differ from those in your vehicle.

### Updates made after the editorial deadline

Due to updates after the editorial deadline, differences may exist between the printed Owner's Manual and the Integrated Owner's Manual in the vehicle.

Notes on updates can be found in the appendix of the printed Owner's Manual for the vehicle.

## For Your Own Safety

### Intended use

Follow the following when using the vehicle:

- ▷ Owner's Manual.
- ▷ Information on the vehicle. Do not remove stickers.
- ▷ Technical vehicle data.

- ▷ The traffic, speed, and safety laws where the vehicle is driven.
- ▷ Vehicle documents and statutory documents.

## Warranty

Your vehicle is technically configured for the operating conditions and registration requirements applying in the country of first delivery, also known as homologation. If your vehicle is to be operated in a different country it might be necessary to adapt your vehicle to potentially differing operating conditions and registration requirements. If your vehicle does not comply with the homologation requirements in a certain country you may not be able to lodge warranty claims for your vehicle there. Further information on warranty is available from a dealer's service center.

## Maintenance and repairs

### WARNING

Improperly performed work on the vehicle paint can lead to a failure or malfunction of the radar sensors and thereby result in a safety risk. There is a risk of accidents or risk of damage to property. Have paintwork or paintwork repairs on bumpers of vehicles with radar sensors performed by a dealer's service center or another qualified service center or repair shop only.

Advanced technology, e. g. the use of modern materials and high-performance electronics, requires suitable maintenance and repair work.

The manufacturer of the vehicle recommends that you entrust corresponding procedures to a BMW dealer's service center. If you choose to use another service facility, BMW recommends use of a facility that performs work, for instance maintenance and repair, according to BMW specifications with properly trained personnel, referred to in this Owner's Manual as "another qualified service center or repair shop".

If work is performed improperly, for instance maintenance and repair, there is a risk of subsequent damage and related safety risks.

## Parts and accessories

BMW recommends the use of parts and accessory products approved by BMW.

Approved parts and accessories, and advice on their use and installation are available from a BMW dealer's service center.

BMW parts and accessories have been tested by BMW for their safety and suitability in BMW vehicles.

BMW warrants genuine BMW parts and accessories.

BMW does not evaluate whether each individual product from another manufacturer can be used with BMW vehicles without presenting a safety hazard, even if a country-specific official approval was issued. BMW does not evaluate whether these products are suitable for BMW vehicles under all usage conditions.

## California Proposition 65 Warning

California law requires vehicle manufacturers provide the following warning:

### WARNING

Engine exhaust and a wide variety of Automobile components and parts, including components found in the interior furnishings in a vehicle, contain or emit chemicals known to the State of California to cause cancer and birth defects and reproductive harm. In addition, certain fluids contained in vehicles and certain products of component wear contain or emit chemicals known to the State of California to cause cancer and birth defects or other reproductive harm. Battery posts, terminals and related accessories contain lead and lead compounds. Batteries also contain other chemicals known to the State of California to cause can-

cer. Wash your hands after handling. Used engine oil contains chemicals that have caused cancer in laboratory animals. Always protect your skin by washing thoroughly with soap and water. For more information go to [www.P65Warnings.ca.gov/passenger-vehicle](http://www.P65Warnings.ca.gov/passenger-vehicle).

### WARNING

Operating, servicing and maintaining a passenger vehicle or off-highway motor vehicle can expose you to chemicals including engine exhaust, carbon monoxide, phthalates, and lead, which are known to the State of California to cause cancer and birth defects or other reproductive harm. To minimize exposure, avoid breathing exhaust, do not idle the engine except as necessary, service your vehicle in a well-ventilated area and wear gloves or wash your hands frequently when servicing your vehicle. For more information go to [www.P65Warnings.ca.gov/passenger-vehicle](http://www.P65Warnings.ca.gov/passenger-vehicle).

## Service and warranty

We recommend that you read this publication thoroughly. Your vehicle is covered by the following warranties:

- ▷ New Vehicle Limited Warranty.
- ▷ Rust Perforation Limited Warranty.
- ▷ Federal Emissions System Defect Warranty.
- ▷ Federal Emissions Performance Warranty.
- ▷ California Emission Control System Limited Warranty.

Detailed information about these warranties is listed in the Service and Warranty Information Booklet for US models or in the Warranty and Service Guide Booklet for Canadian models.

Your vehicle has been specifically adapted and designed to meet the particular operating conditions and homologation requirements in your country and continental region in order to deliver the full driving pleasure while the vehicle is operated under those conditions. If you wish to oper-

ate your vehicle in another country or region, you may be required to adapt your vehicle to meet different prevailing operating conditions and homologation requirements. You should also be aware of any applicable warranty limitations or exclusions for such country or region. In such case, please contact Customer Relations for further information.

## Maintenance

Maintain the vehicle regularly to sustain the road safety, operational reliability and the New Vehicle Limited Warranty.

Specifications for required maintenance measures:

- ▷ BMW Maintenance system.
- ▷ Service and Warranty Information Booklet for US models.
- ▷ Warranty and Service Guide Booklet for Canadian models.

If the vehicle is not maintained according to these specifications, this could result in serious damage to the vehicle. Such damage is not covered by the BMW New Vehicle Limited Warranty.

## Data memory

### General information

Electronic control devices are installed in the vehicle. Electronic control units process data they receive from vehicle sensors, self-generate or exchange with each other. Some control units are necessary for the vehicle to function safely or provide assistance during driving, for instance driver assistance systems. Furthermore, control devices facilitate comfort or infotainment functions.

Information about stored or exchanged data can be requested from the manufacturer of the vehicle, in a separate booklet, for example.

## Personal reference

Each vehicle is marked with a unique vehicle identification number. Depending on the country, the vehicle owner can be identified with the vehicle identification number, license plate and corresponding authorities. In addition, there are other options to track data collected in the vehicle to the driver or vehicle owner, e.g. via the ConnectedDrive account that is used.

## Operating data in the vehicle

Control units process data to operate the vehicle.

For example, this includes:

- ▶ Status messages for the vehicle and its individual components, e.g., wheel rotational speed, wheel speed, deceleration, transverse acceleration, engaged safety belt indicator.
- ▶ Ambient conditions, e.g., temperature, rain sensor signals.

The processed data is only processed in the vehicle itself and generally volatile. The data is not stored beyond the operating period.

Electronic components, e.g. control units and ignition keys, contain components for storing technical information. Information about the vehicle condition, component usage, maintenance requirements or faults can be stored temporarily or permanently.

This information generally records the state of a component, a module, a system, or the environment, for instance:

- ▶ Operating states of system components, e.g., fill levels, tire inflation pressure, battery status.
- ▶ Malfunctions and faults in important system components, for instance lights and brakes.
- ▶ Responses by the vehicle to special situations such as airbag deployment or engagement of the driving stability control systems.
- ▶ Information on vehicle-damaging events.

The data is required to perform the control device functions. Furthermore, it also serves to rec-

ognize and correct malfunctions, and helps the vehicle manufacturer to optimize vehicle functions.

The majority of this data is transient and is only processed within the vehicle itself. Only a small share of the data is stored event-related in event or fault memories.

When servicing, for instance during repairs, service processes, warranty cases, and quality assurance measures, this technical information can be read out from the vehicle together with the vehicle identification number.

A dealer's service center or another qualified service center or repair shop can read out the information. The socket for OBD Onboard Diagnosis required by law in the vehicle is used to read out the data.

The data is collected, processed, and used by the relevant organizations in the service network. The data documents technical conditions of the vehicle, helps with the identification of the fault, compliance with warranty obligations and quality improvement.

Furthermore, the manufacturer has product monitoring duties to meet in line with product liability law. To fulfill these duties, the vehicle manufacturer needs technical data from the vehicle. The data from the vehicle can also be used to check customer claims for warranty and guaranty.

Fault and event memories in the vehicle can be reset when a dealer's service center or another qualified service center or repair shop performs repair or servicing work.

## Data entry and data transfer into the vehicle

### General information

Depending on the vehicle equipment, comfort and individual settings can be stored in the vehicle and modified or reset at any time.

For example, this includes:

- ▶ Settings for the seat and steering wheel positions.
- ▶ Suspension and climate control settings.

If necessary, data can be transferred to the entertainment and communication system of the vehicle, e.g. via smartphone.

This includes the following depending on the respective equipment:

- ▶ Multimedia data such as music, films or photos for playback in an integrated multimedia system.
- ▶ Address book data for use in conjunction with an integrated hands-free system or an integrated navigation system.
- ▶ Entered navigation destinations.
- ▶ Data on the use of Internet services.

This data can be stored locally in the vehicle or is found on a device that has been connected to the vehicle, e.g., a smartphone, USB stick or MP3 player. If this data is stored in the vehicle, it can be deleted at any time.

This data is only transmitted to third parties upon personal request as part of the use of online services. The transmission depends on the selected settings for the use of the services.

## Incorporation of mobile end devices

Depending on the vehicle equipment, mobile devices connected to the vehicle, for instance smartphones, can be controlled via the vehicle control elements.

The sound and picture from the mobile device can be played back and displayed through the multimedia system. Certain information is transferred to the mobile device at the same time. Depending on the type of incorporation, this includes, for instance position data and other general vehicle information. This optimizes the way in which selected apps, for instance navigation or music playback, work.

There is no further interaction between the mobile device and the vehicle, for instance active access to vehicle data.

How the data will be processed further is determined by the provider of the particular app being used. The extent of the possible settings depends on the respective app and the operating system of the mobile device.

## Services

### General information

If the vehicle has a wireless network connection, this enables data to be exchanged between the vehicle and other systems. The wireless network connection is realized via an in-vehicle transmitter and receiver unit or via personal mobile devices brought into the vehicle, for instance smartphones. This wireless network connection enables 'online functions' to be used. These include online services and apps supplied by the vehicle manufacturer or by other providers.

### Services from the vehicle manufacturer

Where online services from the vehicle manufacturer are concerned, the corresponding functions are described in the appropriate place, for instance the Owner's Manual or manufacturer's website. The relevant legal information pertaining to data protection is provided there too. Personal data may be used to perform online services. Data is exchanged over a secure connection, for instance with the IT systems of the vehicle manufacturer intended for this purpose.

Any collection, processing, and use of personal data above and beyond that needed to provide the services must always be based on a legal permission, contractual arrangement or consent. It is also possible to activate or deactivate the data connection as a whole. That is, with the exception of functions and services required by law such as Assist systems.

### Services from other providers

When using online services from other providers, these services are the responsibility of the relevant provider and subject to their data privacy

conditions and terms of use. The vehicle manufacturer has no influence on the content exchanged during this process. Information on the way in which personal data is collected and used in relation to services from third parties, the scope of such data, and its purpose, can be obtained from the relevant service provider.

## Event Data Recorder EDR

This vehicle is equipped with an event data recorder EDR. The main purpose of an EDR is to record, in certain crash or near crash-like situations, such as an air bag deployment or hitting a road obstacle, data that will assist in understanding how a vehicle's systems performed. The EDR is designed to record data related to vehicle dynamics and safety systems for a short period of time, typically 30 seconds or less.

The EDR in this vehicle is designed to record such data as:

- ▶ How various systems in your vehicle were operating.
- ▶ Whether or not the driver and passenger safety belts were fastened.
- ▶ How far, if at all, the driver was depressing the accelerator and/or brake pedal.
- ▶ How fast the vehicle was traveling.

This data can help provide a better understanding of the circumstances in which crashes and injuries occur.

EDR data is recorded by your vehicle only if a nontrivial crash situation occurs; no data is recorded by the EDR under normal driving conditions and no personal data, for instance name, gender, age, and crash location, are recorded.

However, other parties, such as law enforcement, could combine the EDR data with the type of personally identifying data routinely acquired during a crash investigation.

To read data recorded by an EDR, special equipment is required, and access to the vehicle or the EDR is needed. In addition to the vehicle manu-

facturer, other parties, such as law enforcement, that have the special equipment, can read the information if they have access to the vehicle or the EDR.

## Vehicle identification number

### Engine compartment

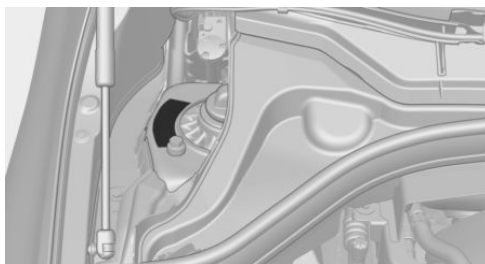

The vehicle identification number can be found in the engine compartment, on the right-hand side of the vehicle.

### Windshield



The vehicle identification number can also be found behind the windshield.

### iDrive

It is also possible to display the vehicle identification number via iDrive, refer to page 57.

## Reporting safety defects

---

### For US customers

The following only applies to vehicles owned and operated in the US.

If you believe that your vehicle has a defect which could cause a crash or could cause injury or death, you should immediately inform the National Highway Traffic Safety Administration NHTSA, in addition to notifying BMW of North America, LLC, P.O. Box 1227, Westwood, New Jersey 07675-1227, Telephone 1-800-831-1117.

If NHTSA receives similar complaints, it may open an investigation, and if it finds that a safety defect exists in a group of vehicles, it may order a recall and remedy campaign.

However, NHTSA cannot become involved in individual problems between you, your dealer, or BMW of North America, LLC.

To contact NHTSA, you may call the Vehicle Safety Hotline toll-free at 1-888-327-4236 (TTY: 1-800-424-9153); go to <http://www.safercar.gov>; or write to: Administrator, NHTSA, 400 Seventh Street, SW., Washington, DC 20590. You can also obtain other information about motor vehicle safety from <http://www.safercar.gov>.

### For Canadian customers

Canadian customers who wish to report a safety-related defect to Transport Canada, Defect Investigations and Recalls, may call the toll-free hotline 1-800-333-0510. You can also obtain other information about motor vehicle safety from <http://www.tc.gc.ca/roadsafety>.







A dark, curved interior space, possibly a tunnel or a modern architectural structure. The walls are composed of a grid of dark panels. Numerous long, horizontal light fixtures are mounted on the walls, creating a series of parallel light streaks. The floor is made of dark, square tiles. The overall atmosphere is dramatic and industrial.

## ⚡ QUICK REFERENCE

Your BMW at a glance ..... 18

# Your BMW at a glance

## Opening and closing

### Buttons on the remote control

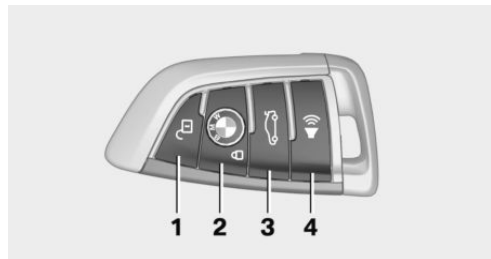

- 1 Unlocking
- 2 Locking
- 3 Unlocking the tailgate

With automatic tailgate operation: open the tailgate

- 4 Panic mode

### Unlocking the vehicle

 Press the button on the remote control.

Depending on the settings, either only the driver's door or all vehicle access points are unlocked.

If only the driver's door is unlocked, press the button on the remote control again to unlock the other vehicle access points.

 Press and hold the button on the remote control after unlocking.

The windows and the glass sunroof are opened, as long as the button on the remote control is pressed.

### Locking the vehicle

 Press the button on the remote control.

All vehicle access points are locked.

### Buttons for the central locking system

#### Overview



Buttons for the central locking system.

#### Locking

 Press the button with the front doors closed.

The fuel filler flap remains unlocked.

#### Unlocking

 Press the button.

#### Panic mode

You can trigger the alarm system if you find yourself in a dangerous situation.

 Press button on the remote control for at least 3 seconds.

To switch off the alarm: press any button.



## Comfort Access

### Concept

The vehicle can be accessed without activating the remote control.

All you need to do is to have the remote control with you, such as in your pants pocket.

The vehicle automatically detects the remote control when it is in close proximity or in the car's interior.

### Unlocking the vehicle

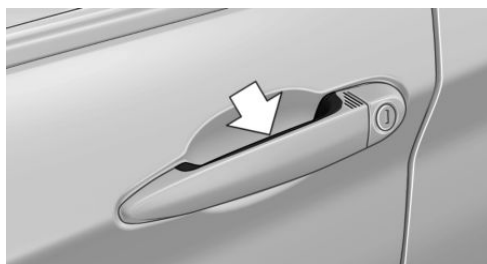

Grasp the door handle on the driver's or front passenger door completely.

### Locking the vehicle

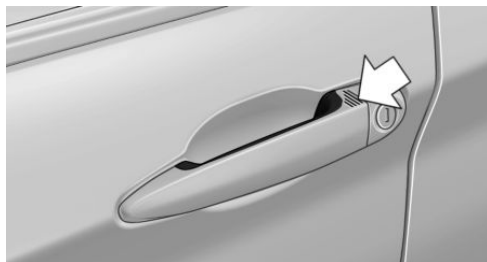

Touch the surface on the door handle of the driver's or front passenger door with your finger for approx. 1 second without grasping the door handle.

## With automatic tailgate operation: opening and closing the tailgate with no-touch activation

### Concept

The tailgate can be opened and closed with no-touch activation using the remote control you are carrying.

### Performing the foot movement

1. Stand in the middle behind the vehicle at approx. one arm's length away from the rear of the vehicle.
2. Wave a foot under the vehicle in the direction of travel and immediately pull it back. With this movement, the leg must pass through the ranges of both sensors.

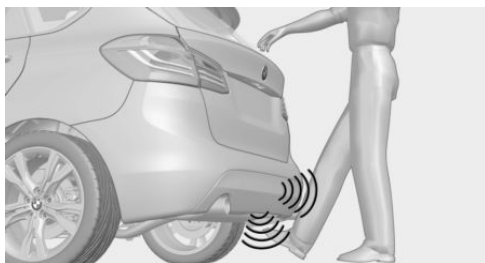

## Tailgate

### Opening

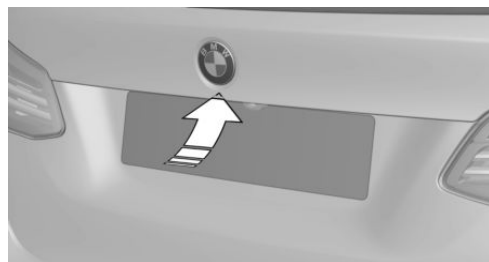

- ▷ Unlock the vehicle and press the button on the tailgate.
- ▷ If carrying the remote control, press the button on the tailgate.

- ▶  Press the button on the remote control for approx. 1 second.

Depending on the setting, the doors may also be unlocked.

## Closing



- ▶ Press button on the inside of the tailgate, arrow 1.
- ▶ Press button, arrow 2.

The vehicle will be locked after closing the tailgate. The driver's door must be closed for this purpose and the remote control must be outside of the vehicle in the area of the tailgate.

## Seats, mirrors, and steering wheel

### Electrically adjustable seats

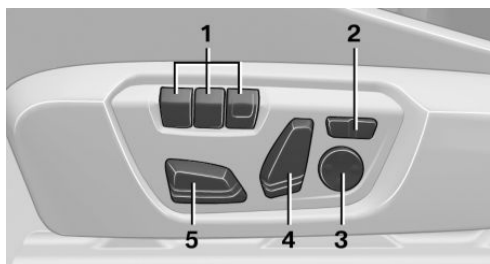

- 1 Memory function
- 2 Backrest width
- 3 Lumbar support

- 4 Backrest tilt
- 5 Forward/backward, height, seat tilt

## Adjusting the head restraint

### Height

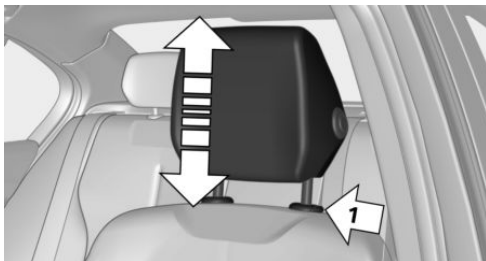

- ▶ To raise: push the head restraint up.
- ▶ To lower: press button, arrow 1, and push head restraint down.

## Adjusting the exterior mirrors



- 1 Settings
- 2 Selecting a mirror, Automatic Curb Monitor
- 3 Folding in and out





## Adjusting the steering wheel

### Manual steering wheel adjustment

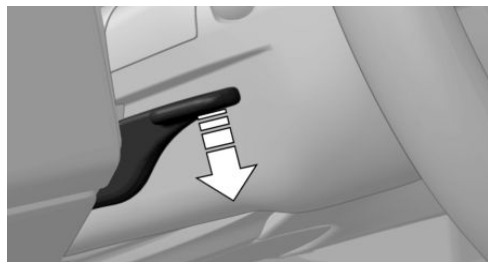

1. Fold the lever down.
2. Move the steering wheel to the preferred height and angle to suit your seating position.
3. Fold the lever back up.

## Memory function

### Concept

The following settings can be stored and, if necessary, retrieved using the memory function:

- Seat position.
- Exterior mirror position.
- Height of the Head-up Display.

### Storing

1. Switch on the ignition.
2. Set the desired position.
3.  Press button. The LED in the button lights up.
4. Press selected button 1 or 2 while the LED is lit. The LED goes out.

### Calling up settings

The stored position is called up automatically.

Press selected button 1 or 2.

The procedure stops when a switch for setting the seat or one of the memory buttons is pressed.

While driving, the seat position adjustment on the driver's side is interrupted after a short time.

## Displays and control elements

### In the vicinity of the steering wheel

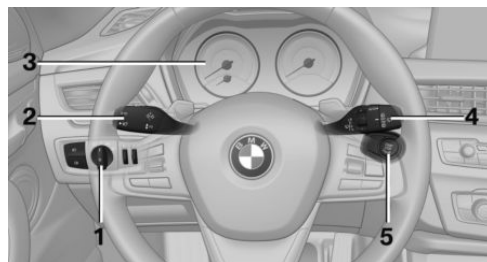

- 1 Light switch element
- 2 High beams, headlight flasher, turn signal
- 3 Instrument cluster
- 4 Washer/wiper system
- 5 Start/Stop button

## Indicator/warning lights

### Instrument cluster

The indicator/warning lights can light up in a variety of combinations and colors.

Several of the lights are checked for proper functioning and light up temporarily when the engine is started or the ignition is switched on.

## Driver's door

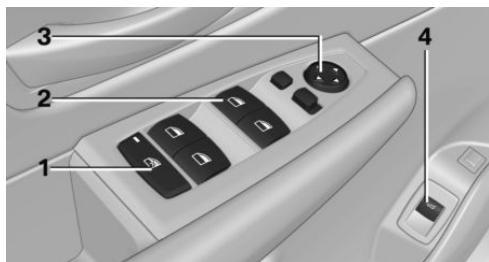

- 1 Safety switch
- 2 Power windows
- 3 Exterior mirrors
- 4 With automatic tailgate operation: opening/closing the tailgate

## Switch console

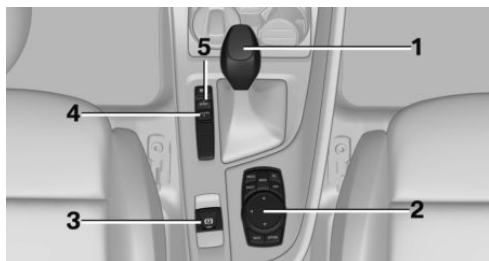

- 1 Selector lever
- 2 Controller
- 3 Parking brake
- 4 Driver assistance systems
- 5 Driving Dynamics Control

## iDrive

### Concept







The iDrive combines the functions of many switches. These functions can be operated via the Controller and, depending on the equipment version, the touchscreen.

## Controller

### General information

The buttons can be used to open the menus directly. The Controller can be used to select menu items and enter the settings.

### Buttons on the Controller

Button	Function
	Press once: call up main menu. Press twice: display all menu items of the main menu.
	Open the Communication menu.
	Open the Media/Radio menu.
	Open destination input menu for navigation.
	Open navigation map.
	Press once: open the previous display. Press and hold: open the menus used last.
	Open the Options menu.

## Voice activation

### Using the voice activation system

#### Activating the voice activation system

1.  Press the button on the steering wheel.
2. Wait for the signal.
3. Say the command.



The symbol on the Control Display indicates that voice activation system is active.

If no other commands are possible, operate the function via iDrive.

### Terminating the voice activation system



Press the button on the steering wheel or »Cancel«.

### Help on the voice activation system

- ▷ To have information on the operating principle of the voice activation system read out loud: »Help with voice activation«.
- ▷ To have help for the current menu read out loud: »Help«.

## Information on Emergency Requests

Do not use the voice activation system to initiate an Emergency Request. In stressful situations, the voice and vocal pitch can change. This can unnecessarily delay the establishment of a phone connection.

Instead, use the SOS button close to the interior mirror.

## Driving

### Starting and stopping the engine

#### Ignition on/off



- ▷ On: press the Start/Stop button.  
Most of the indicator/warning lights light up for a varied length of time.
- ▷ Off: press the Start/Stop button again.  
All indicator lights go out.
- ▷ Radio-ready state: when the ignition is switched off, press the ON/OFF button on

the radio or when the engine is running, press the Start/Stop button.

Some electronic systems/power consumers remain ready for operation.

### Starting/stopping the engine

#### Steptronic transmission: starting

1. Depress the brake pedal.
2. Press the Start/Stop button.

#### Steptronic transmission: switching off

1. When the vehicle is stationary, apply the parking brake.
2. Engage selector lever position P.
3. Press the Start/Stop button.

#### Auto Start/Stop function

Steptronic transmission: switches the engine off automatically while stationary to save fuel. The engine starts automatically when the brake pedal is released.

### Parking brake

#### Setting



Pull the switch.

The LED and indicator light light up.

#### Releasing



With the ignition switched on:

Steptronic transmission: press the switch while the brake is pressed or selector lever position P is set.

The LED and indicator light go out.

The parking brake is released.

### Steptronic transmission

#### Selector lever positions

Parking position P.

Reverse R.

Neutral N.

Drive mode D.

Engage selector lever position P or R only when the vehicle is stationary.

To prevent the vehicle from creeping after you select a drive mode or reverse, maintain pressure on the brake pedal until you are ready to start.

### Selector lever lock

A lock prevents an inadvertent change from selector lever position P to another selector lever position and, depending on the transmission version, inadvertent switching to selector lever position P or R.

To release the lock: with the brake pedal depressed, press the button on the front or side of the selector lever.

### Steptronic transmission, Sport and manual mode

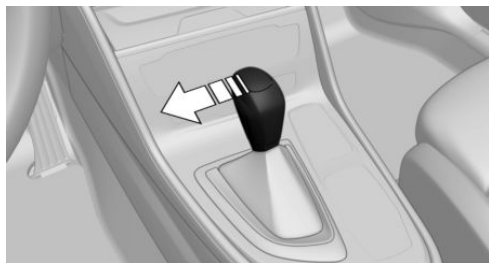

**Sport program:**

Press the selector lever to the left out of selector lever position D.

**Manual mode:**

- ▶ To shift down: press the selector lever forward.
- ▶ To shift up: pull the selector lever rearwards.

### High beams, headlight flasher, turn signal, roadside parking light

#### High beams, headlight flasher

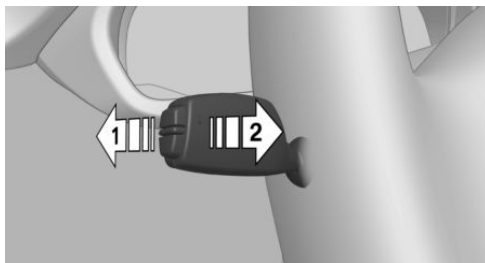

Push the lever forward or pull it backward.

- ▶ High beams on, arrow 1.  
The high beams light up when the low beams are switched on.
- ▶ High beams off/headlight flasher, arrow 2.

#### Turn signal

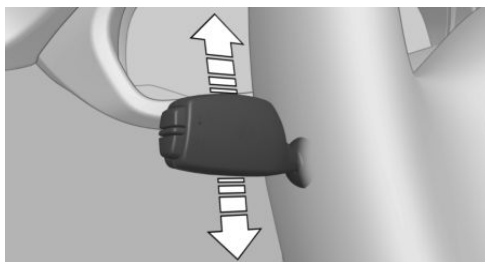

- ▶ On: press the lever past the resistance point.
- ▶ Off: press the lever past the resistance point in the opposite direction.
- ▶ Off: lightly tap the lever to the resistance point.
- ▶ Triple turn signal activation: lightly tap the lever up or down.
- ▶ Brief signaling: press the lever to the resistance point and hold it there for as long as you want the turn signal to flash.



## Canada: roadside parking light

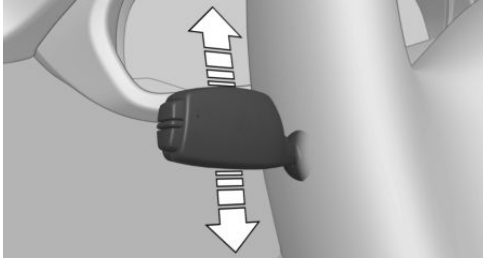







Illuminate the vehicle on one side.

- ▶ On: with the ignition switched off, press the lever either up or down past the resistance point for approx. 2 seconds.
- ▶ Off: briefly press the lever to the resistance point in the opposite direction.

## Lights and lighting

### Light functions

Symbol	Function
	Front fog lights.
	Automatic headlight control. Cornering light.
	Lights off. Daytime running lights.
	Parking lights.
	Low beams.
	Instrument lighting.

## Washer/wiper system

### Switching the wipers on/off and brief wipe

#### Switching on

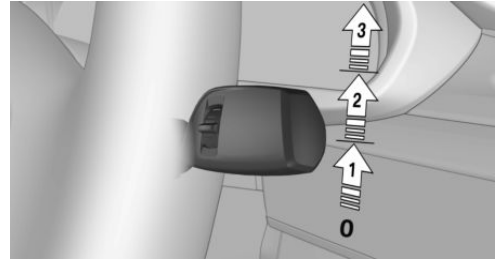

Press the lever up until the desired position is reached.

- ▶ Resting position of the wipers: position 0.
- ▶ Rain sensor: position 1.
- ▶ Normal wiper speed: position 2.
- ▶ Fast wiper speed: position 3.

#### Brief wipe and switching off

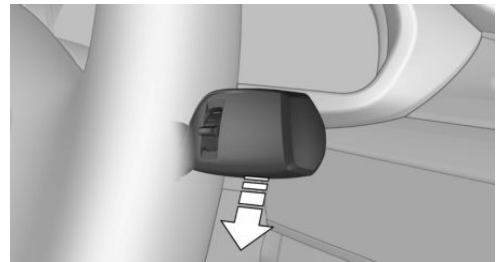

Press the lever down.

- ▶ Switching off: press the lever down until it reaches its standard position.
- ▶ Brief wipe: press the lever down from the standard position.

## Rain sensor

### Activating/deactivating

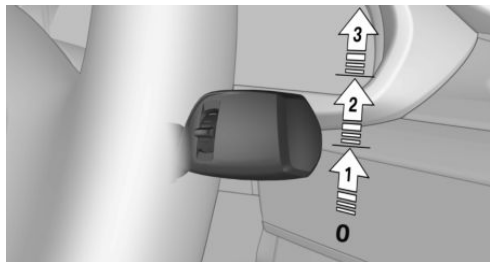

To activate: press the lever up once from its standard position, arrow 1.

To deactivate: press the lever back into the standard position.

### Set interval or sensitivity of the rain sensor

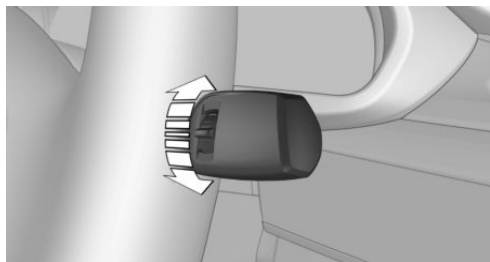

Turn the thumbwheel on the wiper lever.

## Cleaning the windshield and headlights

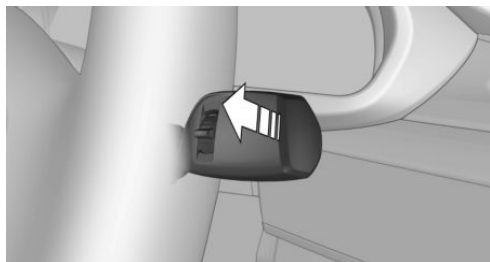

Pull the lever.

## Rear window wiper

### Switching on

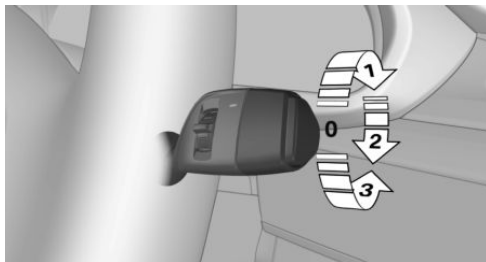

Turn the outer switch upward.

- ▶ Resting position of the wiper, position 0.
- ▶ Intermittent mode, arrow 1. When reverse gear is engaged, the system switches to continuous operation.

### Clean the rear window

Turn the outer switch in the desired direction.

- ▶ In resting position: turn the switch downward, arrow 3. The switch automatically returns to its resting position when released.
- ▶ In intermittent mode: turn the switch further, arrow 2. The switch automatically returns to its intermittent position when released.

## Canada: wiper system Wiper system

### Switching the wipers on/off and brief wipe

#### Switching on

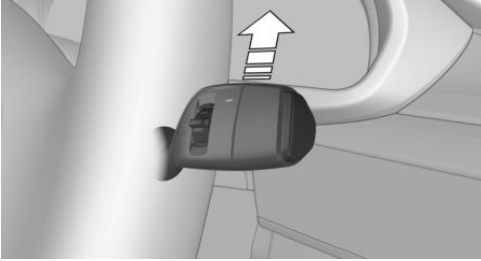

- ▶ Normal wiper speed: tap up once.
- ▶ Fast wiper speed: tap up twice or tap once beyond the resistance point.

#### Brief wipe and switching off

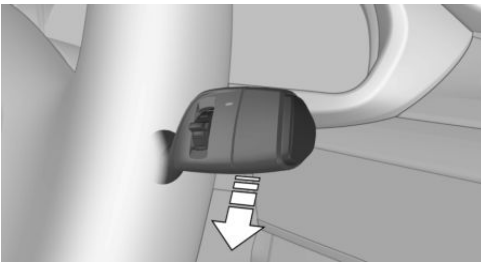

Push wiper lever down.

- ▶ Brief wipe: press down once.
- ▶ To switch off normal wipe: press down once.
- ▶ To switch off fast wipe: press down twice.

## Rain sensor

### Activating/deactivating

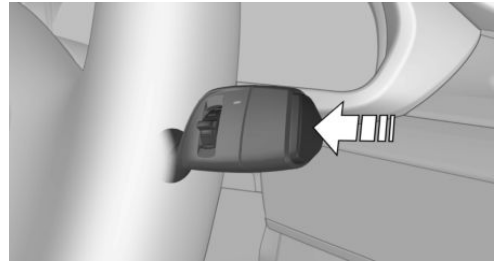

Press the button on the wiper lever.

### Adjusting the sensitivity

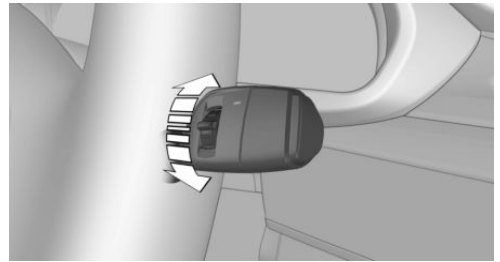

Turn the thumbwheel on the wiper lever.

### Cleaning the windshield and headlights

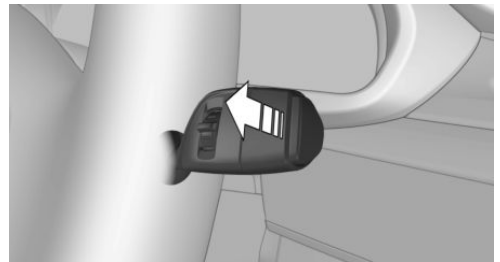

Pull the wiper lever towards you.

## Rear window wiper

### Switching on

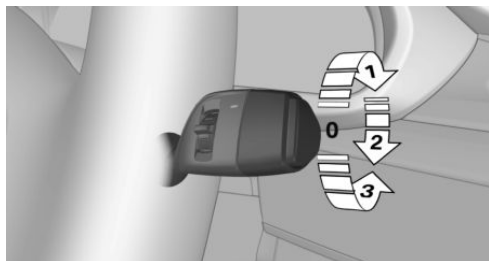

Turn the outer switch upward.

- ▷ Resting position of the wiper, position 0.
- ▷ Intermittent mode, arrow 1. When reverse gear is engaged, the system switches to continuous operation.

### Clean the rear window

Turn the outer switch in the desired direction.

- ▷ In resting position: turn the switch downward, arrow 3. The switch automatically returns to its resting position when released.
- ▷ In intermittent mode: turn the switch further, arrow 2. The switch automatically returns to its intermittent position when released.

## Climate control

### Air conditioner



Button	Function
	Temperature.
	Air conditioning.
	Recirculated-air mode

Button	Function
	Air flow, manual.
	Air distribution, manual.
	Rear window defroster.
	Seat heating.

### Automatic climate control

Button	Function
	Temperature.
	Air conditioning.
	Maximum cooling.
	AUTO program.
	Recirculated-air mode/AUC.
	Air flow, manual.
	Air distribution, manual.
	SYNC program.
	Defrost and defog window.
	Rear window defroster.



Button	Function
	Seat heating.
	Switch off the system.

## Infotainment

### Radio

#### Control elements

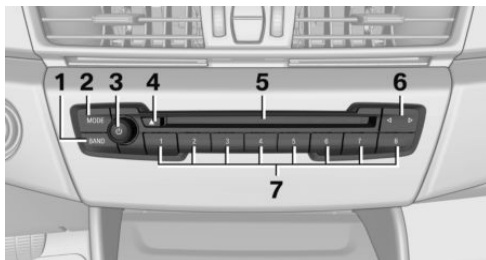

- 1 Waveband/satellite radio
- 2 Changing the entertainment source
- 3 Sound output on/off, volume
- 4 Depending on the vehicle equipment: ejecting a CD/DVD
- 5 Depending on the vehicle equipment: CD/DVD drive
- 6 Change station/track
- 7 Programmable memory buttons

### Navigation destination entry

#### Entering a destination via address

##### State/province

1. "Navigation"
2.  "Enter address"

3. "State/Province?"
4. Move the Controller to the right to select the state from the list.

##### Entering the address

The address can be entered in any order.

Example: entering the address via the town/city

1. "City/Postal code?"
2. Enter the town/city.  
The list is narrowed down further with each entry.
3. **OK** Select the symbol.
4. Select a town/city from the list.
5. If necessary, enter the street.
6. Select the street as you would the town/city.
7. If necessary, enter a house number.
8. **OK** Select the symbol.
9. Select a house number or range of house numbers from the list.

#### Starting destination guidance

"Start guidance"

If only the town/city was entered: destination guidance is started to the town/city center.

#### Connecting a mobile phone

After the mobile phone is connected once to the vehicle, the mobile phone can be operated using iDrive, the steering wheel buttons and spoken instructions.

1. "My Vehicle"
2. "iDrive settings"
3. "Mobile devices"
4. "Connect new device"
5. Select the functions for which the mobile phone is to be used.

The Bluetooth name of the vehicle is displayed on the Control Display.

6. To perform additional steps on the mobile phone, refer to the mobile phone owner's manual: e.g., search for or connect the Bluetooth device or a new device.  
The Bluetooth name of the vehicle appears on the mobile phone display. Select the Bluetooth name of the vehicle.
7. Depending on the mobile device, a control number is displayed or the control number must be entered.
  - ▷ Compare the control number displayed on the Control Display with the control number on the display of the device.  
Confirm the control number on the device and on the Control Display.
  - ▷ Enter and confirm the same control number on the device and via iDrive.  
The device is connected and displayed in the device list.

## Using the phone

### Accepting a call

Incoming call can be accepted via iDrive or the button on the steering wheel.

#### Via iDrive

 "Accept"

#### Via the button on the steering wheel



Press the button.

### Dialing a number

1. "Communication"
2. "Dial number"
3. Enter the numbers.
4.  Select the symbol. The connection is established via the mobile phone to which this function has been assigned.

Establish the connection via the additional phone:

1.  Press button.
2. "Call via"

## Apple CarPlay preparation

### Concept

CarPlay allows certain functions of a compatible Apple iPhone to be used via Siri voice operation and iDrive.

### Functional requirements

- ▷ Compatible iPhone.  
iPhone 5 or later with iOS 7.1 or later.
- ▷ Corresponding mobile wireless contract.
- ▷ Bluetooth, WiFi, and Siri voice operation are switched on on the iPhone.

### Switching on Bluetooth and CarPlay

Via iDrive:

1. "My Vehicle"
2. "iDrive settings"
3. "Mobile devices"
4. "Settings"
5. Select the following settings:
  - ▷ "Bluetooth®"
  - ▷ "Apple CarPlay"

### Pairing iPhone with CarPlay

Pair iPhone via Bluetooth with the vehicle.

Select CarPlay as the function:

 "Apple CarPlay"

The iPhone is connected to the vehicle and displayed in the device list.



## Refueling

### Refueling

#### Fuel cap

1. Press the rear edge of the fuel filler flap to open it.



2. Turn the fuel cap counterclockwise.
3. Place the fuel cap in the bracket attached to the fuel filler flap.

#### Gasoline

For the best fuel efficiency, the gasoline should be sulfur-free or very low in sulfur content.

Refuel only with unleaded gasoline without metallic additives.

Information on the recommended fuel grade can be found in the Owner's Manual.

### Wheels and tires

#### Tire inflation pressure specifications



The tire inflation pressure values can be found on the sign on the door pillar.

#### After correcting the tire inflation pressure

Reinitialize the Flat Tire Monitor.

Reset the Tire Pressure Monitor.

#### Checking the tire inflation pressure

Regularly check the tire inflation pressure and correct it as needed:

- ▷ At least twice a month.
- ▷ Before embarking on an extended trip.

### Electronic oil measurement

#### Requirements

A current measured value is available after approx. 30 minutes of driving. During a shorter trip, the status of the last, sufficiently long trip is displayed.

#### Displaying the engine oil level

1. "My Vehicle"
2. "Vehicle status"
3.  "Engine oil level"

### Adding engine oil

#### General information

Switch off the ignition and safely park the vehicle before engine oil is added.

## Adding

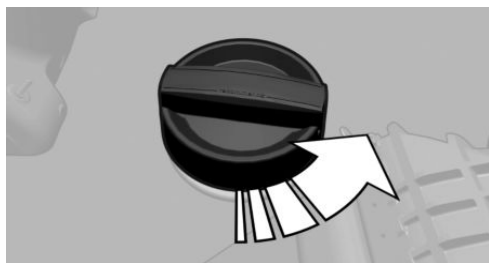

Only add engine oil when the message is displayed in the instrument cluster.

Observe the quantity to be added in the message.

Take care not to add too much engine oil.

Observe recommended engine oil types.

## Providing assistance

### Hazard warning flashers

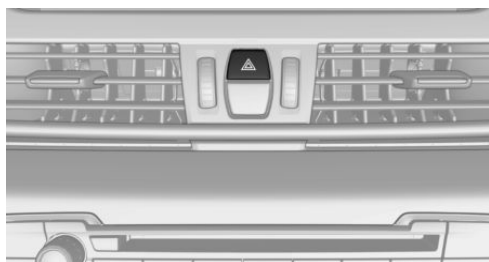

The button is located in the center console.

## Breakdown assistance

### BMW Roadside Assistance

Via iDrive:

1. "ConnectedDrive"
2. "BMW Assist"
3. "BMW Roadside Assistance"

A voice connection is established to BMW Roadside Assistance.

## ConnectedDrive

### Concierge service

The BMW Assist Concierge service offers information on events, gas stations or hotels, and provides phone numbers and addresses. Many hotels can be booked directly by the BMW Concierge service. The Concierge service is part of the optional BMW Assist Response Center.

1. "ConnectedDrive"
2. "Concierge"

### Teleservices

Teleservices are services that help to maintain vehicle mobility.

Depending on the equipment version, Teleservices comprise the following services:

- ▷ Roadside Assistance.
- ▷ Service Request.
- ▷ Automatic Service Request.
- ▷ Teleservice Report.
- ▷ Teleservice Battery Guard.
- ▷ Your dealer's service center.







A scenic landscape featuring a valley with a small town and vineyards, surrounded by large, rugged mountains under a hazy sky. The scene is captured from an elevated perspective, looking down into the valley.

## ☰ AT A GLANCE

Cockpit .....	36
iDrive .....	40
Voice activation system .....	49
General settings .....	52
Owner's Manual media .....	64

# Cockpit

## Vehicle features and options

This chapter describes all standard, country-specific and optional features offered with the series.

It also describes features that are not necessarily available in your vehicle, e. g., due to the selected options or country versions. This also applies to safety-related functions and systems. When using these functions and systems, the applicable laws and regulations must be observed.

## In the vicinity of the steering wheel

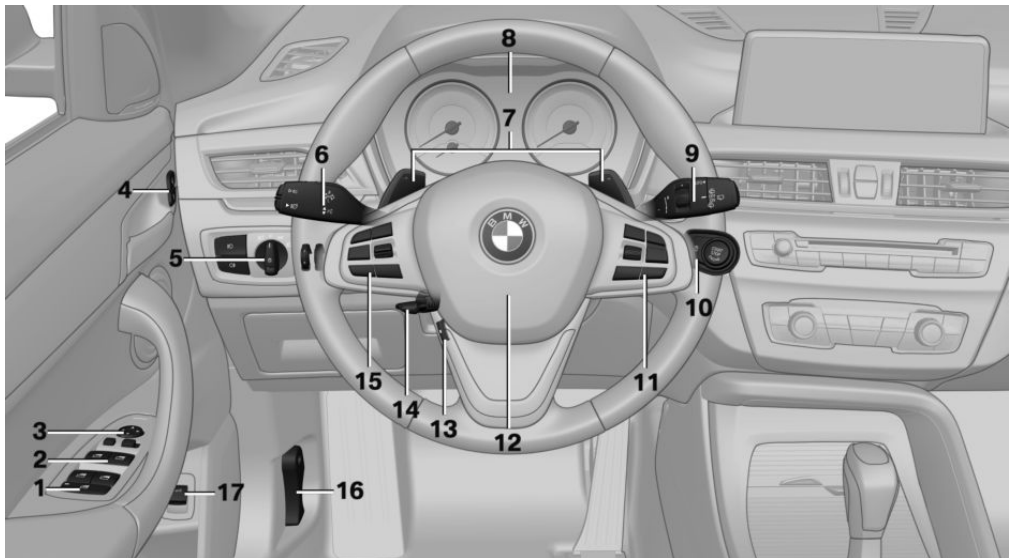

1 Rear window safety switch 86

2 Power windows 85

3 Exterior mirror operation 97

4 Central locking system



Unlock 73



Lock 73

5 Lights



Front fog lights 146



Light switch 143





























Lights off  
Daytime running lights 145



Parking lights 143



Low beams 143

-  Automatic headlight control [144](#)  
 Cornering light [145](#)  
 High-beam Assistant [145](#)
-  Instrument lighting [146](#)
- 6** Steering column stalk, left
-  Turn signal [111](#)
-  High beams, headlight flasher [111](#)
-  High-beam Assistant [145](#)
-  Roadside parking lights [144](#)
-  Onboard Computer [136](#)
- 7** Shift paddles [119](#)
- 8** Instrument cluster [127](#)
- 9** Steering column stalk, right
-  Wiper [112](#)  
 Wiper on Canadian models [115](#)
-  Rain sensor [112](#)  
 Rain sensor on Canadian models [116](#)
-  Clean the windshield and headlights [113](#)
-  Rear window wiper in Canadian models [117](#)
-  Rear window wiper [114](#)
-  Clean the rear window [114](#)
- 10**  Start/stop the engine and switch the ignition on/off [106](#)
-  Auto Start/Stop function [107](#)
- 11** Steering wheel buttons, right
-  Entertainment source
-  Volume
-  Voice activation [49](#)
-  Telephone, see Owner's Manual for Navigation, Entertainment and Communication [8](#)
- Thumbwheel for selection lists [136](#)
- 12**  Horn, entire surface
- 13**  Heated steering wheel [99](#)
- 14** Adjust steering wheel [99](#)
- 15** Steering wheel buttons, left
-  Cruise control on/off [181](#)
-  Active Cruise Control on/off [175](#)
-  Cruise control: store speed
-  Pausing, continuing cruise control
-  Camera-based cruise control: reduce distance
-  Camera-based cruise control: increase distance
- Cruise control rocker switch

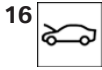

**16** Unlock hood [263](#)

**17** With automatic tailgate operation: open/close the tailgate [77](#)

## In the vicinity of the center console

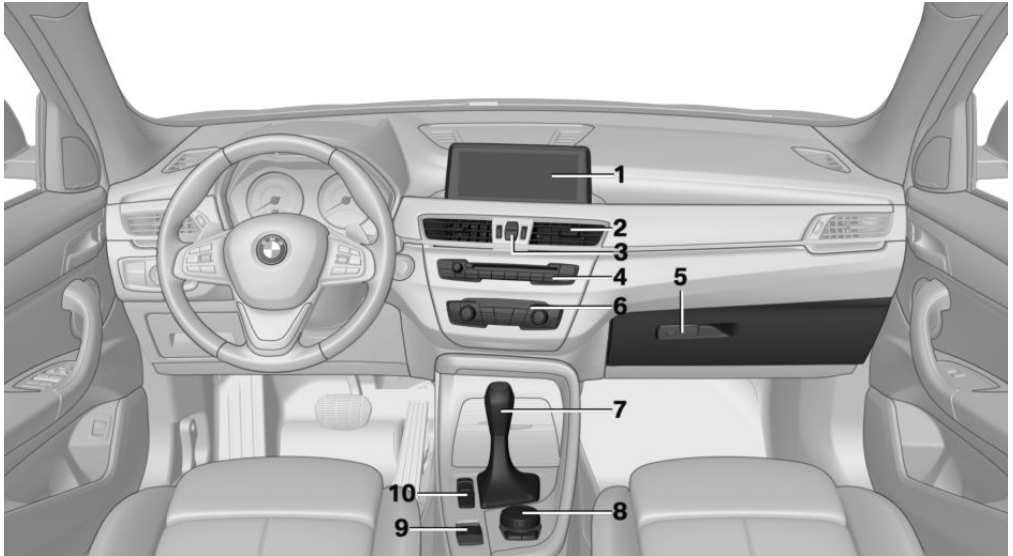

**1** Control Display [40](#)

**2** Ventilation [202](#)

**3**  Hazard warning system [283](#)

 Intelligent Safety [158](#)

**4** Radio/Multimedia

**5** Glove compartment [218](#)

**6** Climate control [195](#)

**7** Steptronic transmission selector lever [119](#)

**8** Controller with buttons [42](#)

**9** Parking brake [109](#)

**10**  DSC Dynamic Stability Control [169](#)

 Driving Dynamics Control [173](#)





 PDC Park Distance Control [184](#)  
Rearview camera [187](#)

Parking assistant [190](#)

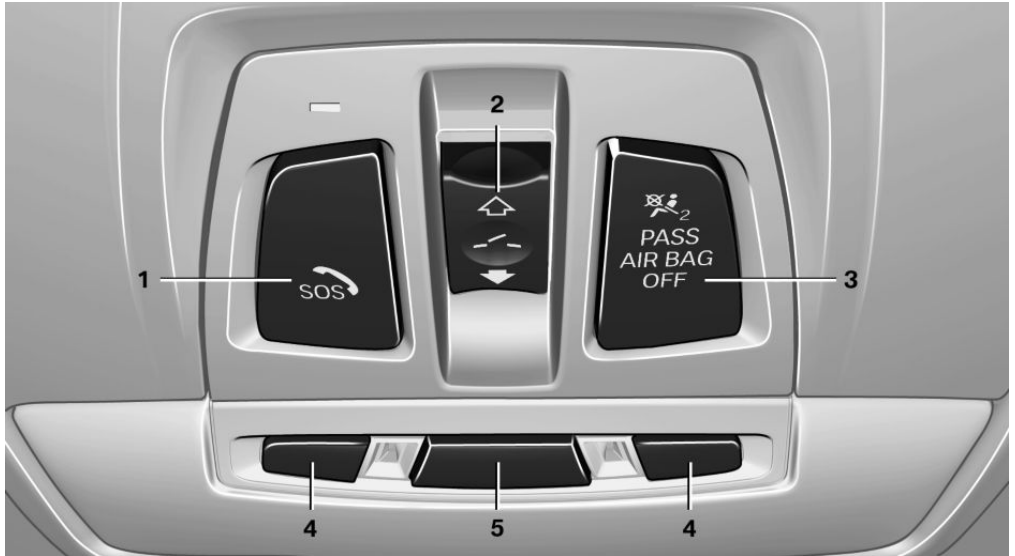
 HDC Hill Descent Control [171](#)

## In the vicinity of the roofliner



- |   |   |  |   |   |                                     |
|---|---|--|---|---|-------------------------------------|
| 1 |  | Emergency Request, SOS <a href="#">284</a>                       | 4 |  | Reading lights <a href="#">147</a>  |
| 2 |  | Glass sunroof <a href="#">87</a>                                 | 5 |  | Interior lights <a href="#">147</a> |
| 3 |  | Indicator light, front-seat passenger airbag <a href="#">151</a> |   |   |                                     |

# iDrive

## Vehicle features and options

This chapter describes all standard, country-specific and optional features offered with the series. It also describes features that are not necessarily available in your vehicle, e. g., due to the selected options or country versions. This also applies to safety-related functions and systems. When using these functions and systems, the applicable laws and regulations must be observed.

## Concept

The iDrive combines the functions of many switches. These functions can be operated via the Controller and, depending on the equipment version, the touchscreen.

## Safety information



### WARNING

Operating the integrated information systems and communication devices while driving can distract from traffic. It is possible to lose control of the vehicle. There is a risk of an accident. Only use the systems or devices when the traffic situation allows. As warranted, stop and use the systems and devices while the vehicle is stationary.

## Input and display

### Letters and numbers

Depending on the menu, you can switch between entering upper and lower case, letters and numbers.

Symbol	Function
abc or ABC	Change between capital and lower-case letters.
	Insert blank space.
	Use voice activation.
OK	Confirm entry.

### Entry comparison

When entering names and addresses, the choice is narrowed down with every letter entered and letters may be added automatically.

Entries are continuously compared with data stored in the vehicle.

- ▶ Only those letters are offered during entry for which data is available.
- ▶ Destination search: place names can be entered in all languages that are available in iDrive.

### Activating/deactivating the functions

Several menu items are preceded by a checkbox. The checkbox indicates whether the function is activated or deactivated. Selecting the menu item activates or deactivates the function.

- Function is activated.
- Function is deactivated.



## Status information













### General information

The status field can be found in the upper area of the Control Display. Status information is displayed in the form of symbols.



### Radio symbols



Symbol	Meaning
	HD Radio station is being received.
<b>SXM</b>	Satellite radio is switched on.

### Telephone symbols





Symbol	Meaning
	Incoming or outgoing call.
	Missed call.
	Signal strength of cellular network.
	Network search.
	Cellular network is not available.
	The critical charge state of the mobile phone has been reached.
	Roaming is active.
	SMS text message received.
	Message received.
	Reminder.
	Sending not possible.
	Contacts are loaded.

### Entertainment symbols

Symbol	Meaning
	CD/DVD player.
	Bluetooth audio.

Symbol	Meaning
	USB audio interface.
	Online Entertainment.
	WiFi.

### Other symbols

Symbol	Meaning
	Check Control message.
	The sound output has been switched off.
	Encrypted connection not active.
	Request for the current vehicle position.
	Checking the current vehicle position.

## Split screen, split screen display

### General information

Additional information can be displayed in several menus on the right side of the split screen display, the so-called split screen, for instance information from the Onboard Computer.

The additional information remains visible even when switching to another menu on the split screen.

### Switching on/off

-  Press the button.
- "Split screen"

### Selecting the display

The display can be selected in menus, where the split screen is supported.

- Move the Controller to the right until the split screen is selected.

2. Press the Controller.
3. Select the desired setting.

### Specifying the number of displays

It is possible to specify the number of displays.

1. Move the Controller to the right until the split screen is selected.
2. Press the Controller.
3. "Personalize menu"
4. Select the desired setting.
5. Move the Controller to the left.

## Control elements

### Overview

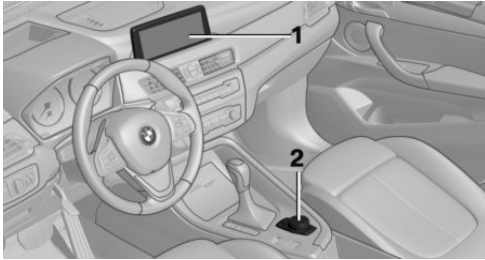

- 1 Control Display, with touchscreen depending on the equipment version
- 2 Controller with buttons and, depending on the equipment version, with touchpad

### Control Display

#### General information

To clean the Control Display, follow the care instructions, refer to page 293.

In the case of very high temperatures on the Control Display, for instance due to intense solar radiation, the brightness may be reduced down to complete deactivation. Once the temperature is reduced, for instance through shade or air conditioning, the normal functions are restored.

### Safety information

#### **NOTICE**

Objects in the area in the front of the Control Display can shift and damage the Control Display. There is a risk of damage to property. Do not place objects in the area in front of the Control Display.

#### Switching on/off automatically

The Control Display is switched on automatically after unlocking.

In certain situations, the Control Display is switched off automatically, for instance if no operation is performed on the vehicle for several minutes.

#### Switching on/off manually

The Control Display can also be switched off manually.

1.  Press button.
2. "Turn off control display"

Press the Controller or any button on the Controller to switch it back on again.

### Controller with navigation system

#### General information

The buttons can be used to open the menus directly. The Controller can be used to select menu items and enter the settings.

Some iDrive functions can be operated using the touchpad on the Controller, refer to page 47.

#### Operation

- ▶ Turn to switch between menu items, for example.

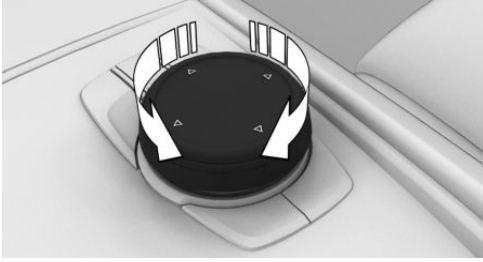

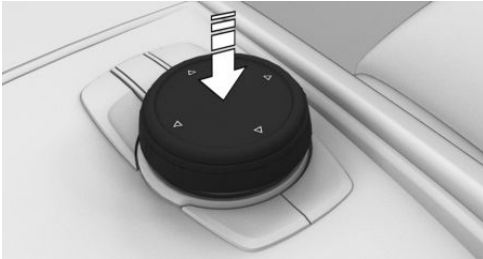

- ▶ Press to select a menu item, for example.



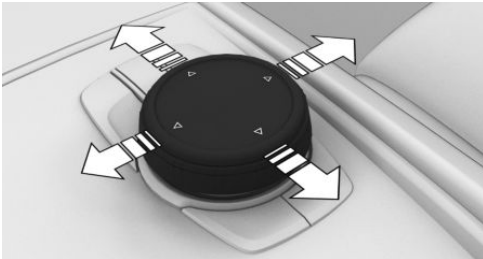



- ▶ Tilt in four directions to switch between displays, for example.



## Buttons on the Controller

Button	Function
	Press once: call up main menu. Press twice: display all menu items of the main menu.
	Open the Communication menu.
	Open the Media/Radio menu.

Button	Function
	Open destination input menu for navigation.
	Open navigation map.
	Press once: open the previous display. Press and hold: open the menus used last.
	Open the Options menu.

## Controller without navigation system

### General information

The buttons can be used to open the menus directly. The Controller can be used to select menu items and enter the settings.

### Operation

- ▶ Turn to switch between menu items, for example.

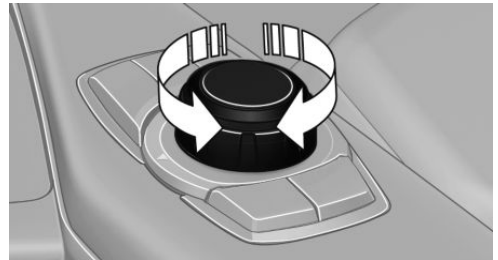



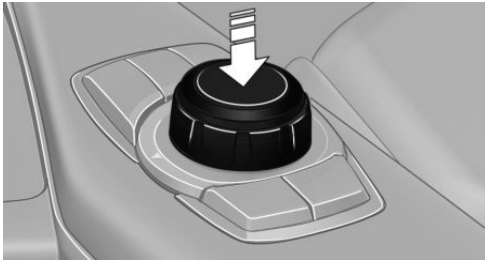

- ▶ Press to select a menu item, for example.

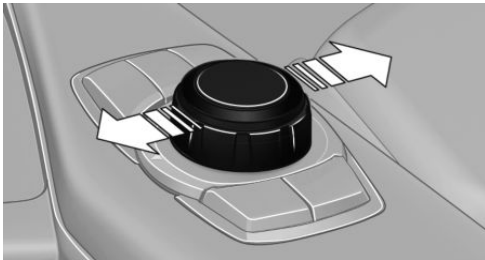

▷ Tilt in two directions to switch between displays, for example.



### Buttons on the Controller

Button	Function
	Press once: call up main menu. Press twice: display all menu items of the main menu.
	Open the Communication menu.
	Open the Media/Radio menu.
	Press once: open the previous display. Press and hold: open the menus used last.
	Open the Options menu.

## Operating with the Controller

### Opening the main menu

 Press the button.

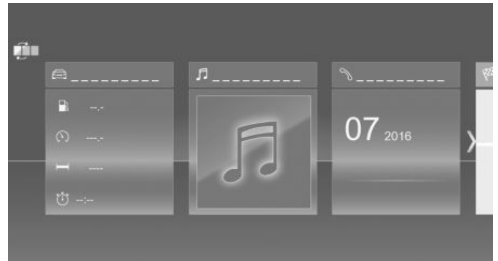

The main menu is displayed.

All iDrive functions can be called up via the main menu.

### Adapting the main menu

-  Press the button twice.  
All menu items of the main menu are displayed.
- Select a menu item.
- To move the menu item to the desired position, tilt the Controller to the right or left.

### Selecting menu items

Highlighted menu items can be selected.

- Turn the Controller until the desired menu item is highlighted.

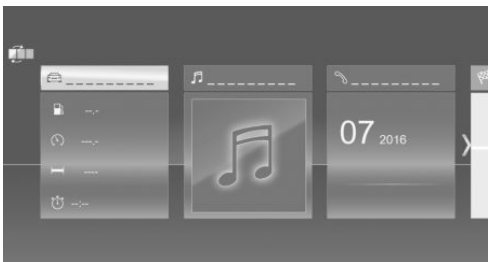

2. Press the Controller.

## Changing between displays

After a menu item is selected, for instance "iDrive settings", a new display appears.

- ▶ Move the Controller to the left.  
Closes the current display and shows the previous display.
- ▶  Press the button.  
The previous display opens.
- ▶ Move the Controller to the right.  
New display is opened.

An arrow indicates that additional displays can be opened.

## Opening recently used menus

The recently used menus can be displayed.

- ▶  Press and hold this button.

The recently used menus are displayed.

## Opening the Options menu

- ▶  Press the button.

The "Options" menu is displayed.

The menu consists of various areas:

- ▶ Screen settings, for instance "Split screen".
- ▶ Control options for the selected main menu, for instance for "Media/Radio".
- ▶ If applicable, further operating options for the selected menu, for instance "Save station".

## Changing settings

Settings, such as brightness, can be entered.

Via iDrive:

1. "My Vehicle"
2. "iDrive settings"
3. "Displays"



4. "Control display"
5. "Brightness"
6. Turn the Controller until the desired setting is displayed.
7. Press the Controller.

## Entering letters and numbers

### Input

1. Turn the Controller: select letters or numbers.
2. **OK** : confirm entry.

### Deleting

Symbol	Function
	Press the Controller: delete letters or number.
	Hold the Controller down: delete all letters or numbers.

## Using alphabetical lists

For alphabetical lists with more than 30 entries, the letters for which there is an entry are displayed at the left edge.

1. Turn the Controller to the left or right quickly.  
All letters for which there are entries are displayed on the left edge.
2. Select the first letter of the desired entry.  
The first entry of the selected letter is displayed.

## Operating via touchscreen

### General information

The Control Display is equipped with a touchscreen.

Touch screen with your fingers. Do not use any objects.

## Opening the main menu

Tap on symbol.

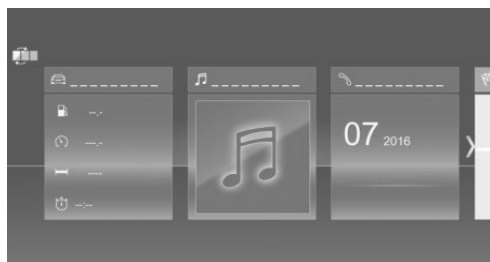

The main menu is displayed.

All iDrive functions can be called up via the main menu.

## Adapting the main menu

- Tap on symbol.  
All menu items of the main menu are displayed.
- Drag the menu item to the desired position on the right or left.

## Selecting menu items

Tap desired menu item.

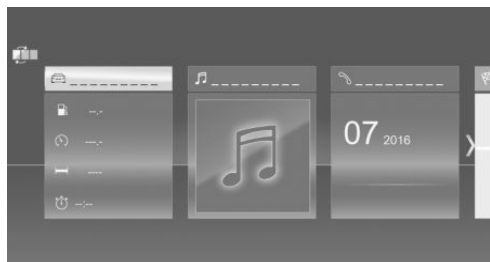

## Changing between displays

After a menu item is selected, a new display opens.

An arrow indicates that additional displays can be opened.

- Swipe to the left.
- Tap arrow.

New display is opened.

## Changing settings

Settings such as brightness can be changed via the touchscreen.

Via iDrive:

- "My Vehicle"
- "iDrive settings"
- "Displays"
- "Control display"
- "Brightness"
- To create the desired setting:
  - Slide in the selected field to the right or left, until the desired setting is displayed.
  - Tap on symbol.

## Entering letters and numbers

### Input

- Touch the symbol on the touchscreen.  
A keyboard is displayed in the Control Display.
- Enter letters and numbers.

## Deleting

Symbol	Function
←	Tapping the symbol: delete the letter or number.
←	Tapping and holding the symbol for an extended period: delete all letters or numbers.

## Operating navigation map

The navigation map can be moved with the touchscreen.

Function	Operation
Enlarge/shrink map.	Drag in or out with the fingers.

## Touchpad

### General information

Some iDrive functions can be operated using the touchpad on the Controller.

### Selecting functions

Via iDrive:

1. "My Vehicle"
2. "iDrive settings"
3. "Touchpad"
4. Select desired setting:
  - ▷ "Speller": enter letters and numbers.
  - ▷ "Map": using the map.
  - ▷ "Search fields": write letters without selecting the list field.
  - ▷ "Audio feedback": pronounces entered letters and numbers.

### Entering letters and numbers

Entering letters requires some practice at the beginning. When entering, pay attention to the following:

- ▷ The system distinguishes between upper and lower-case letters and numbers. To make entries, it may be necessary to change between upper and lower-case letters, numbers and characters, refer to page 45.
- ▷ Enter characters as they are displayed on the Control Display.
- ▷ Always enter associated characters, such as accents or periods so that the letter can be clearly recognized. The set language determines what input is possible. Where necessary, enter special characters via the Controller.

## Entering special characters

Input	Operation
Delete a character.	Swipe to the left on the touchpad.
Enter a blank space.	Swipe to the right in the center of the touchpad.
Enter a hyphen.	Swipe to the right in the upper area of the touchpad.
Enter an underscore.	Swipe to the right in the lower area of the touchpad.

## Using the map

The map in the navigation system can be moved via the touchpad.

Function	Operation
Move map.	Swipe in the appropriate direction.
Enlarge/shrink map.	Drag in or out on the touchpad with fingers.
Display menu.	Tap once.



## Programmable memory buttons

### General information

The iDrive functions can be stored on the programmable memory buttons and called up directly, for instance radio stations, navigation destinations, phone numbers and menu entries.



Settings are stored for the driver profile currently used.

### Storing a function

1. Select function via iDrive.
2.  ...  Press and hold the desired button until a signal sounds.



## Running a function

  Press the button.

The function will work immediately. This means, for instance that the number is dialed when a phone number is selected.

## Displaying the key assignment

Touch buttons with finger. Do not wear gloves or use objects.

The button assignment is displayed at the top edge of screen.

## Deleting the button assignments

1. Press buttons 1 and 8 simultaneously for approx. 5 seconds.
2. "OK"

# Voice activation system

## Vehicle features and options

This chapter describes all standard, country-specific and optional features offered with the series. It also describes features that are not necessarily available in your vehicle, e. g., due to the selected options or country versions. This also applies to safety-related functions and systems. When using these functions and systems, the applicable laws and regulations must be observed.

## Concept

Most functions displayed on the Control Display can be operated by voice commands via the voice activation system. The system supports you with announcements during input.

## General information

- ▶ Functions that can only be used when the vehicle is stationary can only be operated via the voice activation system to a limited extent.
- ▶ The system uses a special microphone on the driver's side.
- ▶ ›...‹ in the Owner's Manual denotes verbal instructions to use with the voice activation system.
- ▶ Say the commands, numbers, and letters smoothly and with normal volume, emphasis, and speed.
- ▶ Always say commands in the language of the voice activation system.

## Requirements

Via the Control Display, set a language that is also supported by the voice activation system so that the spoken commands can be identified.

To set the language, refer to page 52.

## Using the voice activation system

### Activating the voice activation system

1.  Press the button on the steering wheel.
2. Wait for the signal.
3. Say the command.



The symbol on the Control Display indicates that voice activation system is active.

No other commands may be available. In this case, operate the function via iDrive.

### Terminating the voice activation system





Press the button on the steering wheel or ›Cancel‹.

### Using a smartphone via voice activation

A smartphone connected to the vehicle can be used via voice activation.

Activate voice command response on the smartphone for this purpose.

1. Press and hold the  button on the steering wheel for approx. 3 seconds.  
Voice command response is activated on the smartphone.

2. Release the  button.  
If activation is successful, a confirmation appears on the Control Display.

If it was not possible to activate voice command response, the list of Bluetooth devices appears on the Control Display.

## Possible commands

### General information

Most menu items on the Control Display can be voiced as commands.

Commands from other menus can also be spoken.

You may select list entries such as phone list entries via voice activation. Read these list entries out loud exactly as they are shown in the respective list.

### Displaying possible commands

The following is displayed in the top area of the Control Display:

- ▷ Some possible commands for the current menu.
- ▷ Some possible commands from other menus.
- ▷ Status of the voice recognition.
- ▷  Encrypted connection is not available.

## Help on the voice activation system

- ▷ To have information on the operating principle of the voice activation system read out loud: ›Help with voice activation‹.
- ▷ To have help for the current menu read out loud: ›Help‹.

## Example: opening the tone settings

The commands of the menu items are spoken just as they are selected via the Controller.

1. Switch on the Entertainment sound output, if needed.
2.  Press button on the steering wheel.
3. ›Media and radio‹
4. ›Tone‹

## Settings

### Setting the voice dialog

You can set the system to use standard dialog or a short version.

The short version of the voice dialog plays back short messages in abbreviated form.

Via iDrive:

1. "My Vehicle"
2. "iDrive settings"
3. "Language"
4. "Speech mode:"
5. Select the desired setting.

### Activating voice recognition via the server

The voice recognition feature via the server provides a dictation function and a natural method of

entering destinations while improving the quality of voice recognition. To use the functions, data is transmitted to a service provider and locally stored there.

Via iDrive:

1. "My Vehicle"
2. "iDrive settings"
3. "Language"
4. "Server speech recognition"

## Setting the language

---

The language to be used for voice activation and system announcements can be set.

Via iDrive:

1. "My Vehicle"
2. "iDrive settings"
3. If necessary, "Language"
4. "Language:"
5. Select the desired language.

## Adjusting the volume

---

Turn the volume button during the spoken instructions until the desired volume is set.

- ▶ The volume remains constant even if the volume of other audio sources is changed.
- ▶ The volume is stored for the driver profile currently used.

## Information for Emergency Requests

---

Do not use the voice activation system to initiate an Emergency Request. In stressful situations, the voice and vocal pitch can change. This can unnecessarily delay the establishment of a phone connection.

Instead, use the SOS button, refer to page [284](#), close to the interior mirror.

## Environmental conditions

---

- ▶ Keep the doors, windows, and glass sunroof closed to prevent noise interference.
- ▶ Avoid making other noise in the vehicle while speaking.

# General settings

## Vehicle features and options

This chapter describes all standard, country-specific and optional features offered with the series. It also describes features that are not necessarily available in your vehicle, e. g., due to the selected options or country versions. This also applies to safety-related functions and systems. When using these functions and systems, the applicable laws and regulations must be observed.

## Language

### Setting the language

Via iDrive:

1. "My Vehicle"
2. "iDrive settings"
3. If necessary, "Language"
4. "Language:"
5. Select the desired setting.

The setting is stored for the driver profile currently used.

### Setting the voice dialog

Voice dialog for the voice activation system, refer to page 50.

## Time

### Setting the time zone

Via iDrive:

1. "My Vehicle"
2. "iDrive settings"
3. "Date and time"

4. "Time zone:"
5. Select the desired setting.

The setting is stored for the driver profile currently used.

### Setting the time

Via iDrive:

1. "My Vehicle"
2. "iDrive settings"
3. "Date and time"
4. "Time:"
5. Turn the Controller until the desired hours are displayed.
6. Press the Controller.
7. Turn the Controller until the desired minutes are displayed.
8. Press the Controller.

### Setting the time format

Via iDrive:

1. "My Vehicle"
2. "iDrive settings"
3. "Date and time"
4. "Time format:"
5. Select the desired setting.

The setting is stored for the driver profile currently used.

### Automatic time setting

Depending on your vehicle's optional features, the time, date and, if needed, the time zone are updated automatically.

Via iDrive:

1. "My Vehicle"
2. "iDrive settings"

3. "Date and time"
4. "Automatic time setting"

The setting is stored for the driver profile currently used.

## Date

---

### Setting the date

Via iDrive:

1. "My Vehicle"
2. "iDrive settings"
3. "Date and time"
4. "Date:"
5. Turn the Controller until the desired day is displayed.
6. Press the Controller.
7. Make the settings for the month and year.

### Setting the date format

Via iDrive:

1. "My Vehicle"
2. "iDrive settings"
3. "Date and time"
4. "Date format:"
5. Select the desired setting.

The setting is stored for the driver profile currently used.

## Setting the units of measurement

---

You can set the units of measurement for some values, for example, consumption, distances and temperature.

Via iDrive:

1. "My Vehicle"
2. "iDrive settings"

3. "Units"
4. Select the desired menu item.
5. Select the desired setting.

The setting is stored for the driver profile currently used.

## Activating/deactivating the display of the current vehicle position

---

### Concept

If vehicle location has been activated, the current vehicle position can be displayed in the BMW Connected app or in the ConnectedDrive customer portal.

### Activating/deactivating

Via iDrive:

1. "My Vehicle"
2. "Vehicle settings"
3. "Vehicle tracking"
4. "Vehicle tracking"

## Activating/deactivating popup windows

---

For some functions, popup windows are displayed automatically on the Control Display. Some of these popup windows can be activated or deactivated.

Via iDrive:

1. "My Vehicle"
2. "iDrive settings"
3. "Pop-ups"
4. Select the desired setting.

The setting is stored for the driver profile currently used.

## Control Display

### Brightness

Via iDrive:

1. "My Vehicle"
2. "iDrive settings"
3. "Displays"
4. "Control display"
5. "Brightness"
6. Turn the Controller until the desired brightness is set.
7. Press the Controller.

The setting is stored for the driver profile currently used.

Depending on the light conditions, the brightness settings may not be clearly visible.

### Screensaver

If no settings are made via iDrive, a screensaver will be displayed after an adjustable time.

Via iDrive:

1. "My Vehicle"
2. "iDrive settings"
3. "Displays"
4. "Control display"
5. "Screensaver"
6. Select the desired setting.

The setting is stored for the driver profile currently used.

### Selecting the contents of the main menu

For some menu items of the main menu, the displayed contents can be selected.

1.  Press button.
2. "Contents of main menu"

3. Select the desired menu and the desired content.

The setting is stored for the driver profile currently used.

## Messages

### Concept

The menu centrally displays all messages arriving in the vehicle in list form.

### General information

The following messages can be displayed:

- ▶ Traffic messages.
- ▶ Check Control messages.
- ▶ Communication messages, for example e-mails, SMS text messages or reminders.
- ▶ Service requirements messages.

Messages are additionally displayed in the status field.

### Retrieving messages

Via iDrive:

1. "Notifications"
2. Select the desired message.

The respective menu is opened, where the message is displayed.

### Deleting messages

All messages, except Check Control messages, can be deleted from the list. Check Control messages are displayed as long as they are relevant.

Via iDrive:

1. "Notifications"
2. Select the desired message.
3.  Press button.
4. "Delete this notification" or "Delete all notifications"



## Settings

The following settings can be adjusted:

- ▶ Select the applications, from which messages will be permitted.
- ▶ Sort the messages according to date or priority.

Via iDrive:

1. "My Vehicle"
2. "iDrive settings"
3. "Notifications"
4. Select the desired setting.

## Data protection

### Data transfer

#### Concept

The vehicle offers different functions, whose use requires a data transfer to BMW or a service provider. The data transfer can be deactivated for some functions.

#### General information

With data transfer deactivated, the respective function cannot be used.

Only make these settings while stationary.

#### Activating/deactivating

Follow the instructions on the Control Display.

Via iDrive:

1. "My Vehicle"
2. "iDrive settings"
3. "Data privacy"
4. Select the desired setting.

## Deleting personal data in the vehicle

### Concept

Depending on the usage, the vehicle stores personal data, such as stored radio stations. This personal data can be permanently deleted using iDrive.

### General information

Depending on the equipment package, the following data can be deleted:

- ▶ Driver profile settings.
- ▶ Stored radio stations.
- ▶ Stored programmable memory buttons.
- ▶ Travel and Onboard Computer information.
- ▶ Music hard disk.
- ▶ Navigation, for instance stored destinations.
- ▶ Phone book.
- ▶ Online data, for instance Favorites, cookies.
- ▶ Office data, for instance voice notes.
- ▶ Login accounts.

Altogether, the deletion of the data can take up to 15 minutes.

### Functional requirement

Data can only be deleted while stationary.

### Deleting data

Heed and follow the instructions on the Control Display.

Via iDrive:

1. Switch on the ignition.
2. "My Vehicle"
3. "iDrive settings"
4. "Data privacy"
5. "Delete personal data"
6. "Delete personal data"

7. "OK"
8. Exit and lock the vehicle.

After 15 minutes, the deletion process is completed.

If not all of the data was deleted, repeat the deletion.

### Canceling deletion

Start the engine to cancel deletion of the data.

## Connections

### Concept

Various connection types are available for using mobile devices in the vehicle. The connection type to select depends on the mobile device and the desired function.

### General information

The following overview shows possible functions and the suitable connection types for them. The scope of functions depends on the mobile device.

Function	Connection type
Making calls via the hands-free system.	Bluetooth.
Using phone functions via iDrive.	
Using the smartphone Office functions.	
Playing music from the smartphone or the audio player.	Bluetooth or USB.
Using compatible apps via iDrive.	Bluetooth or USB.

Function	Connection type
USB storage device:	USB.
Exporting and importing driver profiles.	
Performing software updates.	
Exporting and importing stored trips.	
Playing music.	
Playing videos from the smartphone or the USB storage device.	USB.
Using the vehicle Internet access.	Internet hotspot.
Use Apple CarPlay apps via iDrive and voice operation.	Bluetooth and WiFi.

The following connection types require one-time pairing with the vehicle:

- ▷ Bluetooth.
- ▷ Internet hotspot.
- ▷ Apple CarPlay.

Paired devices are automatically recognized later on and connected to the vehicle.

## Safety information

### WARNING

Operating the integrated information systems and communication devices while driving can distract from traffic. It is possible to lose control of the vehicle. There is a risk of an accident. Only use the systems or devices when the traffic situation allows. As warranted, stop and use the systems and devices while the vehicle is stationary.

## Compatible devices

### General information

Information on mobile devices compatible with the vehicle can be found at [www.bmwusa.com/bluetooth](http://www.bmwusa.com/bluetooth).

Malfunctions may occur with devices not listed or deviating software versions.

### Displaying the vehicle identification number and software part number

When looking for compatible devices, you may have to state the vehicle identification number and the software part number. These numbers can be displayed in the vehicle.

Via iDrive:

1. "My Vehicle"
2. "iDrive settings"
3. "Mobile devices"
4. "Settings"
5. "Bluetooth@ info"
6. "System information"

A software update, refer to page [62](#), can be performed, if needed.

## Bluetooth connection

### Functional requirements

- ▷ Compatible device, refer to page [57](#), with Bluetooth interface.
- ▷ The remote control is in the vehicle.
- ▷ The device is ready for operation.
- ▷ Bluetooth is activated on the device and in the vehicle, refer to page [57](#).
- ▷ Bluetooth presets, such as visibility, may be required on the device; refer to the owner's manual of the device.

## Switching on Bluetooth

Via iDrive:

1. "My Vehicle"
2. "iDrive settings"
3. "Mobile devices"
4. "Settings"
5. "Bluetooth@"

## Activating/deactivating telephone functions

To use all supported functions of a mobile phone, the following functions must be activated prior to pairing.

Via iDrive:

1. "My Vehicle"
2. "iDrive settings"
3. "Mobile devices"
4. "Settings"
5. Select desired setting:
  - ▷ "Office"
 





Activate function to transmit short messages, e-mails, calendars, tasks, notes, and reminders to the vehicle. Costs can be incurred by transmitting all data to the vehicle.
  - ▷ "Contact images"
 

Activate function to show the contact pictures.
6. Move the Controller to the left.

## Pairing the mobile device with the vehicle

Via iDrive:

1. "My Vehicle"
2. "iDrive settings"
3. "Mobile devices"
4. "Connect new device"
5. Select the functions for which the device will be used:

- ▶  "Telephone"
- ▶  "Bluetooth® audio"
- ▶  "Apps"
- ▶  "Apple CarPlay"

The Bluetooth name of the vehicle is displayed on the Control Display.

6. Search for Bluetooth devices in the vicinity of the mobile device.

The Bluetooth name of the vehicle appears on the mobile device display.

Select the Bluetooth name of the vehicle.

7. Depending on the mobile device, a control number is displayed or the control number must be entered.

- ▶ Compare the control number displayed on the Control Display with the control number on the display of the device.

Confirm the control number on the device and on the Control Display.

- ▶ Enter and confirm the same control number on the device and via iDrive.

The device is connected and displayed in the device list, refer to page 61.

If connection was not successful: Frequently Asked Questions, refer to page 58.

### Frequently asked questions

All requirements are met and all required steps were completed in the specified order. Despite that, the mobile device does not function as expected.

In this case, the following explanations can help:

Why could the mobile phone not be paired or connected?

- ▶ There are too many Bluetooth devices connected to the mobile phone or vehicle.

In the vehicle, delete Bluetooth connections with other devices.

Delete all known Bluetooth connections from the device list on the mobile phone and start a new device search.

- ▶ The mobile phone is in power-save mode or has only a limited remaining battery life.  
Charge mobile phone.

Why does the mobile phone no longer react?

- ▶ The applications on the mobile phone do not function anymore.

Switch the mobile phone off and on again.

- ▶ Too high or too low ambient temperatures for mobile phone operation.

Do not subject the mobile phone to extreme ambient temperatures.

Why can phone functions not be used via iDrive?

- ▶ The mobile phone may not be properly configured, for instance as Bluetooth audio device.

Connect the mobile phone with the telephone or additional phone function.

Why are no or not all phone book entries displayed or why are they incomplete?

- ▶ Transmission of the phone book entries is not yet complete.

- ▶ It is possible that only the phone book entries of the mobile phone or the SIM card are transmitted.

- ▶ It may not be possible to display phone book entries with special characters.

- ▶ It may not be possible to transmit contacts from social networks.

- ▶ The number of phone book entries to be stored is too high.

- ▶ Data volume of the contact too large, for instance due to stored information such as notes.

Reduce the data volume of the contact.

- ▶ A mobile phone can only be connected as audio source or as telephone.

Configure the mobile phone and connect it with the telephone or additional phone function.

How can the phone connection quality be improved?

- ▶ The strength of the Bluetooth signal on the mobile phone can be adjusted, depending on the mobile phone.
- ▶ Insert the mobile phone into the snap-in adapter or place it in the area of the center console.
- ▶ Insert mobile phone into the wireless charging tray.
- ▶ Adjust the volume of the microphone and loudspeakers separately.

If all points in this list have been checked and the required function is still not available, contact the hotline, a dealer's service center or another qualified service center or repair shop.

## USB connection

### General information

Mobile devices with a USB port are connected to the USB interface.

- ▶ Mobile phones.

The snap-in adapter features a separate USB port that is automatically connected when a compatible mobile phone is inserted.

- ▶ Audio devices with USB port, for instance MP3 player.
- ▶ USB storage devices.

Common file systems are supported. FAT32 and exFAT are the recommended formats.

A connected USB storage device will be supplied with charging current via the USB interface if the device supports this. Observe the maximum charge current of the USB interface.

The following uses are possible on USB interfaces with data transfer:

- ▶ Exporting and importing driver profiles, refer to page 80.
- ▶ Playing music files via USB audio.
- ▶ Playing videos via USB video.
- ▶ Loading of software updates, refer to page 62.

Follow the following when connecting:

- ▶ Do not use force when plugging the connector into the USB interface.
- ▶ Use a flexible adapter cable.
- ▶ Protect the USB storage device against mechanical damage.
- ▶ Due to the large number of USB media available on the market, it cannot be guaranteed that every device is operable on the vehicle.
- ▶ Do not expose USB media to extreme environmental conditions, such as very high temperatures; refer to the owner's manual of the device.
- ▶ Due to the many different compression techniques, proper playback of the media stored on the USB storage device cannot be guaranteed in all cases.
- ▶ To ensure proper transmission of the stored data, do not charge a USB storage device via the onboard socket, when it is connected to the USB interface.
- ▶ Depending on how the USB storage device is being used, settings may be required on the USB storage device, refer to the owner's manual of the device.

Not compatible USB media:

- ▶ USB hard drives.
- ▶ USB hubs.
- ▶ USB memory card readers with multiple inserts.
- ▶ HFS-formatted USB media.
- ▶ Devices such as fans or lamps.

### Functional requirement

Compatible device, refer to page 57, with USB interface.

### Connecting the device

Connect the USB storage device using a suitable adapter cable to a USB interface, refer to page 211.

The USB storage device is displayed in the device list, refer to page 61.

## Internet connection

### General information

Up to 8 devices can be connected with the Internet hotspot.

### Functional requirements

- ▷ Compatible device, refer to page 57, with WiFi interface.
- ▷ ConnectedDrive contract.
- ▷ Data contract with a service provider.
- ▷ WiFi activated on the device.
- ▷ Internet hotspot activated in the vehicle.
- ▷ The ignition is switched on.

### Activating the Internet hotspot

Via iDrive:

1. "My Vehicle"
2. "iDrive settings"
3. "Mobile devices"
4. "Settings"
5. "Internet hotspot"

### Connecting device with Internet hotspot

Via iDrive:

1. "My Vehicle"
2. "iDrive settings"
3. "Mobile devices"
4. "Connect new device"
5.  "Internet hotspot"

Hotspot name and hotspot code are displayed on the Control Display.

6. Search for WiFi networks on the device. Select network name on the device.
7. Enter hotspot code on the device and connect.

With the first Internet usage via the Internet hotspot, data volume must be purchased from a service provider.

All devices connected via the Internet hotspot use this data volume.

If necessary, data volume can be purchased from the ConnectedDrive Store.

### Settings

The network name and hotspot code can be changed. In addition, the network name can be hidden so that it cannot be found by other devices.

Via iDrive:

1. "My Vehicle"
2. "iDrive settings"
3. "Mobile devices"
4.  Press button.
5. ▷ "Change hotspot key"  
Enter the desired hotspot code.  
▷ "Change hotspot name"  
Enter the desired network name.  
▷ "Hide hotspot"  
Activate or deactivate the function.
6. Confirm the entry of the hotspot code or network name:  
**OK** Select the symbol.

## Apple CarPlay preparation

### Concept

CarPlay allows certain functions of a compatible Apple iPhone to be used via Siri voice operation and iDrive.

## Functional requirements

- ▷ Compatible iPhone, refer to page 57.  
iPhone 5 or later with iOS 7.1 or later.
- ▷ Corresponding mobile wireless contract.
- ▷ Bluetooth, WiFi, and Siri voice operation are switched on on the iPhone.
- ▷ Booking the ConnectedDrive service: Apple CarPlay preparation.

## Switching on Bluetooth and CarPlay

Via iDrive:

1. "My Vehicle"
2. "iDrive settings"
3. "Mobile devices"
4. "Settings"
5. Select the following settings:
  - ▷ "Bluetooth®"
  - ▷ "Apple CarPlay"

## Pairing iPhone with CarPlay

Pair iPhone via Bluetooth with the vehicle, refer to page 57.

Select CarPlay as the function:

- ▶ "Apple CarPlay"

The iPhone is connected to the vehicle and displayed in the device list, refer to page 61.

## Operation

For more information, refer to the Integrated Owner's Manual or the Owner's Manual for navigation, entertainment, communication.

## Frequently asked questions

All requirements are met and all required steps were completed in the specified order. Despite that, the mobile device does not function as expected.

In this case, the following explanations can help:

The iPhone has already been paired with Apple CarPlay. When a new connection is established, CarPlay can no longer be selected.

- ▷ Delete the iPhone concerned from the device list.
- ▷ On the iPhone, delete the vehicle concerned from the list of stored vehicles under Bluetooth and under WiFi.
- ▷ Pair the iPhone as a new device.

If the steps listed have been carried out and the required function is still not available: contact the hotline, a dealer's service center or another qualified service center or repair shop.

## Managing mobile devices

### General information

- ▷ After one-time pairing, the devices are automatically recognized and reconnected when the ignition is switched on.
- ▷ The data stored on the SIM card or in the mobile phone are transferred to the vehicle after recognition.
- ▷ For some devices, certain settings may be necessary, for instance authorization, see owner's manual of the device.



### Displaying the device list

All devices paired or connected with the vehicle are displayed in the device list.



Via iDrive:

1. "My Vehicle"
2. "iDrive settings"
3. "Mobile devices"

A symbol indicates, for which function a device is used.

Symbol	Function
	"Telephone"
	"Additional telephone"
	"Bluetooth® audio"



Symbol	Function
	"Apps"
	"Internet hotspot"
	"Apple CarPlay"

## Configuring the device

Functions can be activated or deactivated for paired and connected devices.

Via iDrive:

1. "My Vehicle"
2. "iDrive settings"
3. "Mobile devices"
4. Select the desired device.
5. Select the desired setting.

If a function is assigned to a device, the function will be deactivated where appropriate for a device that is already connected and the device will be disconnected.

## Disconnecting the device

The connection of the device to the vehicle is disconnected.

The device remains paired and can be connected again, refer to page 62.

Via iDrive:

1. "My Vehicle"
2. "iDrive settings"
3. "Mobile devices"
4. Select device.
5. "Disconnect device"

## Connecting the device

A disconnected device can be reconnected.

Via iDrive:

1. "My Vehicle"
2. "iDrive settings"
3. "Mobile devices"

4. Select device.
5. "Connect device"

The functions that were assigned to the device before disconnecting are assigned to the device when it is reconnected. If the device is already connected, these functions are deactivated.

## Deleting the device

Via iDrive:

1. "My Vehicle"
2. "iDrive settings"
3. "Mobile devices"
4. Select device.
5. "Delete device"

The device is disconnected and removed from the device list.

## Swapping the telephone and additional phone

If two mobile phones are connected to the vehicle, the functions of the phone and additional phone can be switched.

Via iDrive:

1. "My Vehicle"
2. "iDrive settings"
3. "Mobile devices"
4. "Settings"
5. "Swap telephone/additional tel."

## Software update

### General information

The vehicle supports a large number of mobile devices, for instance mobile phones and MP3 players. Software updates are available for many of the supported devices. The vehicle is maintained up-to-date via regular vehicle software updates.

Updates and related current information is available at [www.bmw.com/update](http://www.bmw.com/update).

## Displaying the installed software version

The software version installed in the vehicle is displayed.

Via iDrive:

1. "My Vehicle"
2. "iDrive settings"
3. "Software update"
4. "Show current version"

If an update has been carried out before, select the desired version to display additional information.

## Updating software via USB

The software may only be updated when the vehicle is stationary.

Via iDrive:

1. Store the file for the software update in the main directory of a USB flash drive.
2. Connect the USB storage device to a USB interface, refer to page 211.
3. "My Vehicle"
4. "iDrive settings"
5. "Software update"
6. "Update software"
7. "USB"
8. "Install software"
9. "OK"
10. Wait for the update to complete.
11. Confirm system restart.

## Restoring the software version

The software version before the last software update and the version before the first software update can be restored.

The software may only be restored when the vehicle is stationary.

Via iDrive:

1. "My Vehicle"
2. "iDrive settings"
3. "Software update"
4. "Restore software"
5. ▷ "Previous version"
  - The previous software version is restored.
  - ▷ "Default software settings"
    - The first software version is restored.
6. "Remove software"
7. "OK"
8. Wait for restore.
9. Confirm system restart.

# Owner's Manual media

## Vehicle features and options

This chapter describes all standard, country-specific and optional features offered with the series. It also describes features that are not necessarily available in your vehicle, e. g., due to the selected options or country versions. This also applies to safety-related functions and systems. When using these functions and systems, the applicable laws and regulations must be observed.

## General information

You can use the following media formats to call up the content in the Owner's Manual:

- ▷ Printed Owner's Manual, refer to page 64.
- ▷ Integrated Owner's Manual in the vehicle, refer to page 64.

## Printed Owner's Manual

### Concept

The printed Owner's Manual describes all standard, country-specific, and optional features offered with the series.

### General information

The Owner's Manual for Navigation, Entertainment, and Communication can be obtained as printed book from the service center.

### Supplementary Owner's Manuals

Also follow the instructions of the Supplementary Owner's Manuals, which are included in addition to the onboard literature.

## Integrated Owner's Manual in the vehicle

### Concept

The Integrated Owner's Manual specifically describes features and functions found in the vehicle. The Integrated Owner's Manual can be displayed on the Control Display.

### Selecting the Owner's Manual

1.  Press button.
2. "My Vehicle"
3. "Owner's Manual"
4. Select the required method of accessing the contents.

### Scrolling through the owner's manual

Turn the Controller, until the next or previous contents are displayed.

### Context help

#### General information

The section of the Owner's Manual relating to the function that is currently selected can be displayed directly.

#### Opening via iDrive

Change directly to the Options menu from the function on the Control Display:

1.  Press button.
2. "Owner's Manual"



## Opening when a Check Control message is displayed

Directly from the Check Control message on the Control Display:

 "Owner's Manual"

## Changing between a function and the Owner's Manual

To switch from a function, for instance radio, to the Owner's Manual on the Control Display and to alternate between the two displays:

1.  Press the button.
2. "Owner's Manual"
3. Select the desired page in the Owner's Manual.
4.  Press the button again to return to last displayed function.
5.  Press the button to return to the page of the Owner's Manual displayed last.

To alternate continuously between the last displayed function and the last displayed page of the Owner's Manual, repeat steps 4 & 5. Opens a new display every time.



## Programmable memory buttons

### General information



The jumps into the Owner's Manual can be stored on the programmable memory buttons, refer to page 47, and called up directly.

### Storing

1. Select the desired entry point via iDrive:
  - ▷ "Quick reference"
  - ▷ "Search by pictures"
  - ▷ "Keyword search"
  - ▷ "Animations"

2. ... Press desired programmable memory button and hold for more than 2 seconds.

### Executing

1. ... Press the corresponding button. The owner's manual is directly displayed at the selected entry point.









## ↓ CONTROLS

Opening and closing .....	68
Seats, mirrors, and steering wheel .....	89
Transporting children safely .....	100
Driving .....	105
Displays .....	127
Lights .....	143
Safety .....	148
Driving stability control systems .....	169
Driving comfort .....	175
Climate control .....	195
Interior equipment .....	204
Storage compartments .....	217



# Opening and closing

## Vehicle features and options

This chapter describes all standard, country-specific and optional features offered with the series. It also describes features that are not necessarily available in your vehicle, e. g., due to the selected options or country versions. This also applies to safety-related functions and systems. When using these functions and systems, the applicable laws and regulations must be observed.

## Remote control

### General information

The vehicle is supplied with two remote controls with integrated key.

Each remote control contains a replaceable battery. Replacing the battery, refer to page 71.

You may set the button functions, depending on the vehicle equipment and country version. Settings, refer to page 82.

The vehicle stores personal settings for every remote control. Driver profile, refer to page 80.

The remote controls hold information about required maintenance. Service data in the remote control, refer to page 271.

To prevent possible locking in of the remote control, take the remote control with you when exiting the vehicle.

### Safety information

#### WARNING

People or animals in the vehicle can lock the doors from the inside and lock themselves in. In this case, the vehicle cannot be opened from the outside. There is a risk of injury. Take the

remote control with you so that the vehicle can be opened from the outside.

#### WARNING

Unlocking from the inside is only possible with special knowledge.

Persons who spend a lengthy time in the vehicle while being exposed to extreme temperatures are at risk of injury or death. Do not lock the vehicle from the outside when there are people in it.

#### WARNING

Unattended children or animals can cause the vehicle to move and endanger themselves and traffic, for instance due to the following actions:

- ▷ Pressing the Start/Stop button.
- ▷ Releasing the parking brake.
- ▷ Opening and closing the doors or windows.
- ▷ Engaging selector lever position N.
- ▷ Using vehicle equipment.

There is a risk of accidents or injuries. Do not leave children or animals unattended in the vehicle. Take the remote control with you when exiting and lock the vehicle.

## Overview

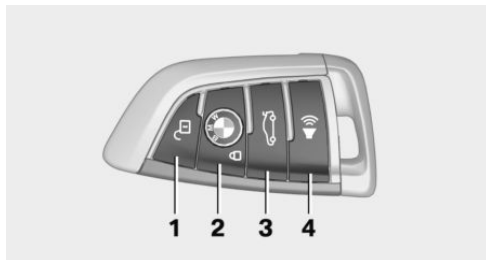

- 1 Unlocking
- 2 Locking
- 3 Unlocking the tailgate

With automatic tailgate operation: open the tailgate

- 4 Panic mode

## Unlocking



Press the button on the remote control.

Depending on the settings, refer to page 82, the following access points are unlocked:

- ▷ Driver's door and fuel filler flap.  
Press the button on the remote control again to unlock the other vehicle access points.
- ▷ All doors, tailgate, and fuel filler flap.

In addition, the following functions are executed:

- ▷ Unlocking is confirmed by the turn signals and the horn. This function must be activated in the settings, refer to page 82.
- ▷ The settings stored in the driver profile, refer to page 80, are applied.
- ▷ The driver's seat is set to the last position saved in the driver's profile. This function must be activated in the settings, refer to page 82.
- ▷ The interior lights, refer to page 147, are switched on, unless they were manually switched off.

- ▷ Depending on the settings, the welcome light and headlight courtesy delay feature, refer to page 144, are switched on.
- ▷ Exterior mirrors folded through convenient closing are folded open.
- ▷ The alarm system, refer to page 84, is switched off.

The light functions may depend on the ambient brightness.

## Convenient opening



Press and hold the button on the remote control after unlocking.

Pressing and holding the button on the remote control opens the windows and the glass sunroof.

## Locking

1. Close the driver's door.
2.  Press button on the remote control.

The following functions are executed:

- ▷ All doors, the tailgate, and the fuel filler flap are locked.
- ▷ Locking is confirmed by the turn signals and the horn. This function must be activated in the settings, refer to page 82.
- ▷ The alarm system, refer to page 84, is switched on.

If the engine or ignition is still switched on when you lock the vehicle, the vehicle horn honks twice. In this case, the engine or ignition must be switched off by means of the Start/Stop button.





## With Comfort Access: convenient closing

### Safety information

#### WARNING

With convenient closing, body parts can be jammed. There is a risk of injury. Make sure that the area of movement of the doors is clear during convenient closing.

### Closing



Press and hold the button on the remote control in the area close to the vehicle.

The windows and the glass sunroof are closed, as long as the button on the remote control is pressed.

The exterior mirrors are folded in.

The exterior mirrors are not folded in when the hazard warning flashers are switched on.

## Switching on interior lights and courtesy light



Press the button on the remote control with the vehicle locked.

This function is not available, if the interior lights were switched off manually.

The light functions may depend on the ambient brightness.

After locking, wait 10 seconds before pressing the button again.

### Panic mode

You can trigger the alarm system if you find yourself in a dangerous situation.



▶ Press the button on the remote control and hold for at least 3 seconds.

▶ Briefly press the button on the remote control three times in succession.

To switch off the alarm: press any button.

## Tailgate

### General information

To avoid locking it in the vehicle, do not place the remote control in the cargo area.

Depending on the vehicle equipment and country version, it is possible to specify whether the tailgate can be unlocked with the remote control and how the vehicle doors will respond to this. Adjusting the settings, refer to page 82.

### Safety information

#### WARNING

Body parts can be jammed when operating the tailgate. There is a risk of injury. Make sure that the area of movement of the tailgate is clear during opening and closing.

#### WARNING

The tailgate pivots out when it opens. There is a risk of injury or risk of damage to property. Make sure that the area of movement of the tailgate is clear during opening and closing.

#### NOTICE

Sharp-edged or pointed objects can hit the windows and heat conductors while driving. There is a risk of damage to property. Cover the edges and ensure that pointed objects do not hit the windows.

### Opening



Press the button on the remote control for approx. 1 second.

Without automatic tailgate operation:

The tailgate is unlocked and can be swung upward.

With automatic tailgate operation:

The tailgate opens automatically.

## Replacing the battery

1. Remove the integrated key from the remote control, refer to page 72.
2. Place the integrated key underneath the battery compartment cover, arrow 1, and lift the cover with a lever movement of the integrated key, arrow 2.

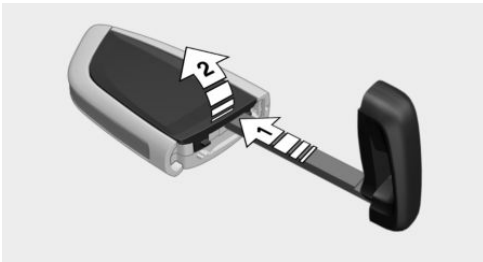

3. Push battery in the direction of the arrow using a pointed object and lift it out.

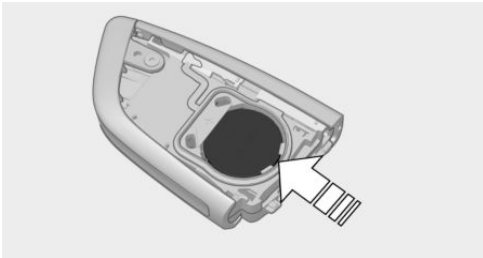

4. Insert a type CR 2032 battery with the positive side facing up.
5. Press the cover closed.
6. Push the integrated key into the remote control until it engages.



Have old batteries disposed of by a dealer's service center or another qualified service center or repair shop or take them to a collection point.

## Additional remote controls

Additional remote controls are available from a dealer's service center or another qualified service center or repair shop.

## Loss of the remote controls

A lost remote control can be blocked and replaced by a dealer's service center or another qualified service center or repair shop.

## Malfunction

### General information

A Check Control message is displayed.

Remote control detection by the vehicle may malfunction under the following circumstances:

- ▷ The battery of the remote control is discharged. Replacing the battery, refer to page 71.
- ▷ Interference of the radio connection from transmission towers or other equipment with high transmitting power.
- ▷ Shielding of the remote control due to metal objects.

Do not transport the remote control together with metal objects.

- ▷ Interference of the radio connection from mobile phones or other electronic devices in direct proximity to the remote control.

Do not transport the remote control together with electronic devices.

- ▷ Interference of radio transmission by a charging process of mobile devices, for instance charging of a mobile phone.

- ▷ The remote control is in direct proximity of the wireless charging tray.

Place the remote control down at a different location.

In the case of interference, the vehicle can be unlocked and locked from the outside with the integrated key, refer to page 72.

## Starting the engine via emergency detection of the remote control

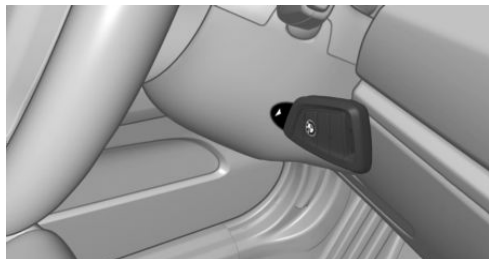

It is not possible to start the engine if the remote control has not been detected.

Proceed as follows in this case:

1. Hold the remote control with its tip against the marked area on the steering column. Pay attention to the display in the instrument cluster.
2. If the remote control is detected:  
Start the engine within 10 seconds.

If the remote control is not detected, slightly change the position of the remote control and repeat the procedure.

## Frequently asked questions

What precautions can be taken to be able to open a vehicle with an accidentally locked in remote control?

- ▷ The options provided by the Remote Services of the BMW Connected app include the ability to lock and unlock a vehicle.

This requires an active BMW ConnectedDrive contract and the BMW Connected app must be installed on a smartphone.

- ▷ Unlocking the vehicle can be requested via the BMW ConnectedDrive Call Center.  
An active BMW ConnectedDrive contract is required.

## Integrated key

### General information

The driver's door can be locked and unlocked without remote control using the integrated key.

### Safety information

#### **⚠ WARNING**

Unlocking from the inside is only possible with special knowledge.

Persons who spend a lengthy time in the vehicle while being exposed to extreme temperatures are at risk of injury or death. Do not lock the vehicle from the outside when there are people in it.

#### **⚠ NOTICE**

The door lock is permanently joined with the door. The door handle can be moved. When pulling the door handle with the integrated key inserted, paint or the integrated key can be damaged. There is a risk of damage to property. Remove the integrated key before pulling the outside door handle.

## Removing

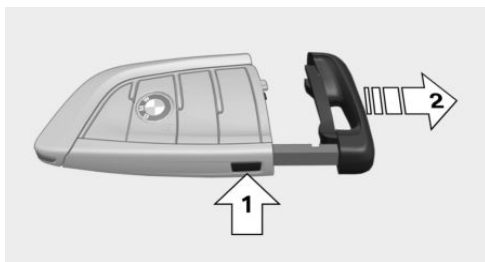

Press the button, arrow 1, and pull out the integrated key, arrow 2.

## Locking/unlocking via the door lock

1. Remove lid on the door lock.  
To do this, slide the integrated key into the opening from below and remove the lid.

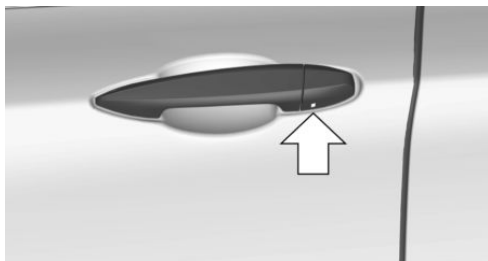

2. Unlock or lock the door lock using the integrated key.

The other doors must be unlocked or locked from the inside.

## Alarm system

The alarm system is not switched on if the vehicle is locked with the integrated key.

The alarm system is triggered when the door is opened, if the vehicle has been unlocked via the door lock.

In order to stop the alarm, unlock the vehicle with the remote control or switch on the ignition, if needed, through emergency detection of the remote control, refer to page 72.

## Buttons for the central locking system

### General information

In the event of a severe accident, the vehicle is automatically unlocked. The hazard warning system and interior lights come on.

## Overview



Buttons for the central locking system.

## Locking

 Press the button with the front doors closed.

The fuel filler flap remains unlocked.

The vehicle is not secured against theft when locking.

## Unlocking

 Press the button.

## Opening

- ▶  Press button to unlock the doors together, and then pull the door handle above the armrest.
- ▶ Front doors: pull the door handle on the door to open the door. The other doors remain locked.
- ▶ Back doors: pull twice on the door handle on the door to be opened; the first time unlocks the door, the second time opens it. The other doors remain locked.

## Comfort Access

### Concept

The vehicle can be accessed without activating the remote control.

All you need to do is to have the remote control with you, such as in your pants pocket.

The vehicle automatically detects the remote control when it is in close proximity or in the car's interior.

### General information

Comfort Access supports the following functions:

- ▷ Unlocking and locking the vehicle.
- ▷ Convenient closing.
- ▷ Open the tailgate.
- ▷ Opening/closing the tailgate with no-touch activation.

### Functional requirements

- ▷ To lock the vehicle, the remote control must be located outside of the vehicle near the doors.
- ▷ The next unlocking and locking cycle is not possible until after approx. 2 seconds.

### Unlocking



Grasp the door handle on the driver's or front passenger door completely.

This corresponds with pressing the button  on the remote control.

### Locking

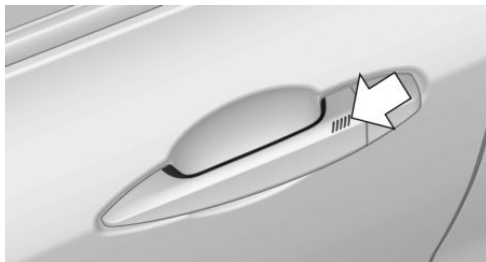

Touch the surface on the door handle of the driver's or front passenger door with your finger for approx. 1 second without grasping the door handle.

This corresponds with pressing the button  on the remote control.

### Convenient closing

#### Safety information

#### WARNING

With convenient closing, body parts can be jammed. There is a risk of injury. Make sure that the area of movement of the doors is clear during convenient closing.

### Closing

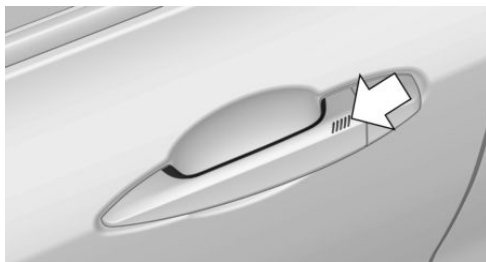

Touch the surface on the door handle of the driver's or front passenger door, arrow, with your finger and hold it there without grasping the door handle.

This corresponds with pressing and holding the button  on the remote control.

In addition to locking, the windows and the glass sunroof close. The exterior mirrors fold in, depending on the model.

## Opening the tailgate

### General information

To avoid locking it in the vehicle, do not place the remote control in the cargo area.

If the tailgate is opened via Comfort Access, locked doors are not unlocked.

### Safety information

#### **WARNING**

Body parts can be jammed when operating the tailgate. There is a risk of injury. Make sure that the area of movement of the tailgate is clear during opening and closing.

#### **WARNING**

The tailgate pivots out when it opens. There is a risk of injury or risk of damage to property. Make sure that the area of movement of the tailgate is clear during opening and closing.

#### **NOTICE**

Sharp-edged or pointed objects can hit the windows and heat conductors while driving. There is a risk of damage to property. Cover the edges and ensure that pointed objects do not hit the windows.

## Opening

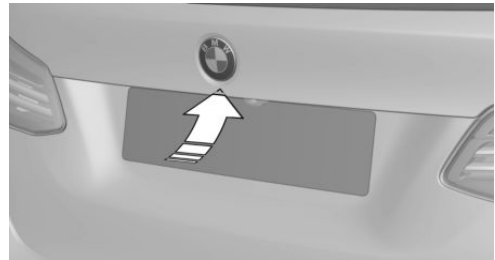

Press button next on tailgate.

This corresponds with pressing the button  on the remote control.

Without automatic tailgate operation:

The tailgate is unlocked and can be swung upward.

With automatic tailgate operation:

The tailgate opens automatically.

## With automatic tailgate operation: opening and closing the tailgate with no-touch activation

### Concept

The tailgate can be opened and closed with no-touch activation using the remote control you are carrying. Two sensors detect a forward-directed foot motion in the central rear area and the tailgate is opened or closed.

### General information

To avoid locking it in the vehicle, do not place the remote control in the cargo area.

If the remote control is in the sensor area, the tailgate can be opened or closed inadvertently by an unconscious or alleged recognized foot movement.

The sensor has an approximate range of 5 ft/1.50 m extending from the rear of the vehicle.

If the tailgate is opened with no-touch activation, locked doors are not unlocked.

Contactless opening and closing of the tailgate must be activated in the settings.

## Safety information

### **WARNING**

During no-touch activation, vehicle parts may be touched, such as the hot exhaust gas system. There is a risk of injury. When moving your foot, make sure you have a firm stance and do not touch the vehicle.

### **WARNING**

Body parts can be jammed when operating the tailgate. There is a risk of injury. Make sure that the area of movement of the tailgate is clear during opening and closing.

### **WARNING**

The tailgate pivots out when it opens. There is a risk of injury or risk of damage to property. Make sure that the area of movement of the tailgate is clear during opening and closing.

## Settings

1. "My Vehicle"
2. "Vehicle settings"
3. "Doors/Key"
4. "Tailgate"
5. Select desired setting:
  - ▷ "Open by foot movement"
 

Contactless opening of the tailgate is switched on or off.
  - ▷ "Close by foot movement"
 

Contactless closing of the tailgate is switched on or off.

## Performing the foot movement

1. Stand in the middle behind the vehicle at approx. one arm's length away from the rear of the vehicle.
2. Wave a foot under the vehicle in the direction of travel and immediately pull it back. With this movement, the leg must pass through the ranges of both sensors.

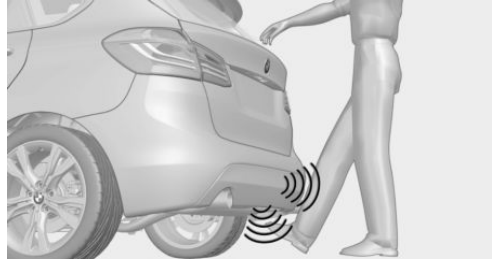

## Opening

Perform the foot movement described earlier.

Before the opening, the hazard warning system flashes.

When the touchless closing is switched on: Moving your foot again will stop the opening motion, and moving it one more time after that will close the tailgate.

## Closing

Perform the foot movement described earlier.

Before closing, the hazard warning system flashes and an acoustic signal sounds.

When the touchless opening is switched on: Moving your foot again will stop the closing motion, and moving it one more time after that will open the tailgate.

## Malfunction

Remote control detection by the vehicle may malfunction under the following circumstances:

- ▷ The battery of the remote control is discharged. Replace the battery, refer to page 71.



- ▷ Interference of the radio connection from transmission towers or other equipment with high transmitting power.
- ▷ Shielding of the remote control due to metal objects.  
Do not transport the remote control together with metal objects.
- ▷ Interference of the radio connection from mobile phones or other electronic devices in direct proximity to the remote control.  
Do not transport the remote control together with electronic devices.

Wet or snowy conditions may disrupt the locking request recognition function on the door handles.

In the case of a malfunction, unlock and lock the vehicle using the buttons of the remote control or using the integrated key, refer to page 72.

## Tailgate

### General information

To avoid locking it in the vehicle, do not place the remote control in the cargo area.

Depending on the vehicle equipment and country version, it is possible to specify whether the tailgate can be unlocked with the remote control and how the vehicle doors will respond to this. Adjusting the settings, refer to page 82.

### Safety information

#### WARNING

Body parts can be jammed when operating the tailgate. There is a risk of injury. Make sure that the area of movement of the tailgate is clear during opening and closing.

#### WARNING

The tailgate pivots out when it opens. There is a risk of injury or risk of damage to property. Make sure that the area of movement of the tailgate is clear during opening and closing.

#### NOTICE

Sharp-edged or pointed objects can hit the windows and heat conductors while driving. There is a risk of damage to property. Cover the edges and ensure that pointed objects do not hit the windows.

## Without automatic tailgate operation

### Opening from the outside

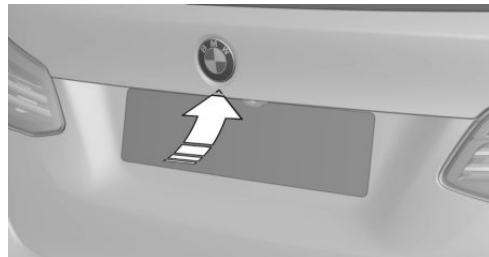

- ▷ Without Comfort Access: unlock vehicle.  
With Comfort Access: unlock the vehicle or have the remote control with you.  
Press button next on tailgate.
- ▷  Press the button on the remote control for approx. 1 second.  
Depending on the setting, the doors may also be unlocked. Unlocking with the remote control, refer to page 70.

The tailgate is opened slightly and can be swung upward.



## Opening from the inside



With Steptronic transmission:

With the vehicle stationary, pull the button in the storage compartment of the driver's door upwards.

If the vehicle is locked, selector lever position P must be engaged first.



With manual transmission:

With the vehicle stationary, pull the button in the storage compartment of the driver's door upwards twice in quick succession.

The tailgate is opened slightly and can be swung upward.

## Closing



Grasp the recess grip and pull tailgate down.

## With automatic tailgate operation

### Opening

#### General information

When the trailer socket is in use, the tailgate cannot be opened with the remote control or with the button in the car's interior.

#### Adjusting the opening height

You can set how far the tailgate should open.

When adjusting the opening height, ensure that there is a clearance of at least 4 in/10 cm above the tailgate.

1. "My Vehicle"
2. "Vehicle settings"
3. "Doors/Key"
4. "Tailgate"
5. Monitor the tailgate and set the desired opening height.

### From the outside

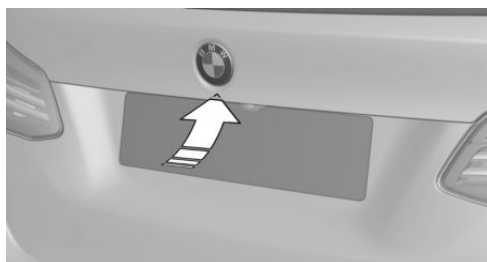

- ▶ Without Comfort Access: unlock vehicle.  
With Comfort Access: unlock the vehicle or have the remote control with you.  
Press the button on tailgate's exterior.
- ▶  Press the button on the remote control for approx. 1 second.  
Depending on the setting, the doors may also be unlocked. Opening with the remote control, refer to page 70.

If the vehicle is stationary, the tailgate opens automatically to the adjusted opening height.

### From the inside



With Steptronic transmission:

Pull button in the storage compartment of the driver's door upward.

If the vehicle is locked, selector lever position P must be engaged first.



With manual transmission:

With the vehicle stationary, pull the button in the storage compartment of the driver's door upwards twice in quick succession.

If the vehicle is stationary, the tailgate opens automatically to the adjusted opening height.

### Interruption of the opening procedure

The opening procedure is interrupted in the following situations:

- ▶ When the vehicle starts moving.
- ▶ By pressing the button on the outside of the tailgate. Pressing again closes the tailgate.
- ▶ By pressing the button on the inside of the tailgate. Pressing again closes the tailgate.
- ▶ By pressing the button on the remote control. Pressing again continues the opening motion.
- ▶ By pressing or pulling the button in the storage compartment. Pulling again continues the opening motion.

## Closing

### From the outside

Press the button on tailgate's exterior.

### From the inside

 Press button in the storage compartment of the driver's door and keep it pressed.

The remote control must be located in the car's interior for this function.

An acoustic signal sounds before the tailgate is closed.

### From inside the tailgate

Without Comfort Access:



Press the button on the inside of the tailgate.

With Comfort Access:



- ▶ Press button on the inside of the tailgate, arrow 1.
- ▶ Press button, arrow 2.

The vehicle will be locked after closing the tailgate. The driver's door must be closed for this purpose and the remote control must be outside of the vehicle in the area of the tailgate.

### Interruption of the closing procedure

The closing procedure is interrupted in the following situations:

- ▶ If the vehicle starts off with a jerky movement.
- ▶ By pressing the button on the outside of the tailgate. Pressing again re-opens the tailgate.
- ▶ By pressing the button on the inside of the tailgate. Pressing again re-opens the tailgate.
- ▶ By releasing the button in the storage compartment of the driver's door. Pulling again and holding continues the closing motion.



## Malfunction

### Safety information

#### WARNING

With manual operation of a blocked tailgate, it can release itself unexpectedly from the blockage. There is a risk of injury or risk of damage to property. Do not operate the tailgate manually if it is blocked. Have it checked by a dealer's service center or another qualified service center or repair shop.

### Manual operation

Operate the unlocked tailgate manually with a slow and smooth motion.

To close the tailgate fully, press down lightly only. Closing occurs automatically.

## Driver profile

### Concept

In the driver profiles, individual settings for several drivers can be stored and called up again when required.

### General information

There are three driver profiles with which personal vehicle settings can be stored. Every remote control has one of these driver profiles assigned.

If the vehicle is unlocked using a remote control, the assigned personal driver profile will be activated. All settings stored in the driver profile are automatically applied.

If several drivers use their own remote control, the vehicle will adjust the personal settings during unlocking. These settings are also restored, if the vehicle has been used in the meantime by a person with a different remote control.

Changes to the settings are automatically stored in the driver profile currently activated.

If another driver profile is selected via iDrive, the settings stored in it will be applied automatically. The new driver profile is assigned to the remote control currently used.

There is an additional guest profile available that is not assigned to any remote control. It can be used to apply settings in the vehicle without changing the personal driver profiles.

### Functional requirements

For the system to be able to identify the driver profile associated to a particular driver, the detected remote control must be clearly allocated to the driver.

This is the case when:

- ▷ The driver is only carrying his or her own remote control.
- ▷ The driver unlocks the vehicle.
- ▷ The driver gets into the vehicle through the driver's door.

### Settings

The settings for the following systems and functions are stored in the active profile. The scope of storable settings depends on country and equipment.

- ▷ Unlocking and locking.
- ▷ Lights.
- ▷ Climate control.
- ▷ Radio.
- ▷ Instrument cluster.
- ▷ Programmable memory buttons.
- ▷ Volumes, tone.
- ▷ Control Display.
- ▷ Navigation.
- ▷ PDC Park Distance Control.
- ▷ Rearview camera.
- ▷ Head-up Display.

- ▶ Driving Dynamics Control.
- ▶ Seat position, exterior mirror position, steering wheel position where applicable.  
Both the positions saved via the seat memory and the last position set are saved.
- ▶ Intelligent Safety.

## Profile management

### Selecting a driver profile

Regardless of the remote control in use, a different driver profile may be activated. This allows you to call up personal vehicle settings, even if you did not unlock the vehicle with your own remote control.

Via iDrive:

1. "My Vehicle"
  2. "Driver profiles"
  3. Select driver profile.
  4. "OK"
- ▶ All settings stored in the called-up driver profile are automatically applied.
  - ▶ The called-up driver profile is assigned to the remote control being used at the time.
  - ▶ If the driver profile is already assigned to a different remote control, this driver profile will apply to both remote controls.

### Using a guest profile

The guest profile is for individual settings that are stored in none of the three personal driver profiles.

Via iDrive:

1. "My Vehicle"
2. "Driver profiles"
3. "Drive off (guest)"
4. "OK"

The guest profile cannot be renamed. It is not assigned to the current remote control.

### Renaming a driver profile

A personal name can be assigned to the active driver profile to avoid confusion between the driver profiles.

Via iDrive:

1. "My Vehicle"
2. "Driver profiles"
3. Select driver profile.  
 The driver profile marked with this symbol can be renamed.
4. "Change driver profile name"
5. Enter profile name.
6. **OK** Select the symbol.

### Resetting a driver profile

The settings of the driver profile currently in use are reset to their factory settings.

Via iDrive:

1. "My Vehicle"
2. "Driver profiles"
3. Select driver profile.  
 The driver profile marked with this symbol can be reset.
4. "Reset driver profile"
5. "OK"

### Exporting driver profiles

Most settings of the active driver profile can be exported.

Exporting is helpful when storing and retrieving personal settings, for instance before delivering the vehicle to a workshop. The stored driver profiles can be taken into another vehicle.

Via iDrive:

1. "My Vehicle"
2. "Driver profiles"
3. Select driver profile.



 The driver profile marked with this symbol can be exported.

4. "Export driver profile"
5. Select a storage device for exporting the driver profile.
  - ▷ "USB device"  
Select USB storage device, as needed, refer to page 59.
  - ▷ Online.

## Importing driver profiles

The existing settings of the active driver profile are overwritten with the settings of the imported driver profile.

Via iDrive:

1. "My Vehicle"
2. "Driver profiles"
3. Select the driver profile to be overwritten.
  -  The driver profile marked with this symbol can be overwritten.
4. "Import driver profile"
5. Select a storage device for importing the driver profile.
  - ▷ USB storage device: "USB device"  
Select USB storage device as needed.
  - ▷ Online.
6. Select the driver profile to be imported.

## Displaying driver profiles during start

The driver profiles can be displayed during each start to select the desired profile.

Via iDrive:

1. "My Vehicle"
2. "Driver profiles"
3. "Show driver profiles at startup"

## System limits

A clear assignment between the remote control and driver may not be possible in the following cases, for example.

- ▷ The passenger unlocks the vehicle with his or her own remote control, but another person is driving.
- ▷ The driver unlocks the vehicle via Comfort Access and has multiple remote controls with him or her.
- ▷ The driver changes, but the vehicle is not locked and unlocked.
- ▷ Multiple remote controls are located outside of the vehicle.

## Settings

---

### General information



Depending on the package and country version, various settings are available for the remote control functions.

These settings are stored for the driver profile, refer to page 80, currently used.

## Unlocking

### Doors

Via iDrive:

1. "My Vehicle"
2. "Vehicle settings"
3. "Doors/Key"
4.  "Driver's door" or  "All doors"
5. Select desired setting:
  - ▷ "Driver's door only"  
Only the driver's door and the fuel filler flap are unlocked. Pressing again unlocks the entire vehicle.
  - ▷ "All doors"  
The entire vehicle is unlocked.

## Tailgate

Depending on the vehicle equipment and country version, this setting may not be offered.

Via iDrive:

1. "My Vehicle"
2. "Vehicle settings"
3. "Doors/Key"
4. 

The text next to the symbol indicates the current setting.

5. Select desired setting:
  - ▷ "Tailgate"
 

Depending on your vehicle's optional features, the tailgate is either unlocked or opened.
  - ▷ "Tailgate and door(s)"
 

Depending on your vehicle's optional features, the tailgate is either unlocked or opened and the doors unlocked.
  - ▷ "Tailgate opens after unlocking"
 

The vehicle must be unlocked before the tailgate can be used with the remote control.
  - ▷ "Button lock"
 

It is not possible to use the tailgate via the remote control.

## Adjusting the last seat and mirror position

Via iDrive:

1. "My Vehicle"
2. "Driver profiles"
3. Select driver profile.
  -  The setting can be made for the driver profile marked with this symbol.
4. "Last seat position automatic"

When the vehicle is unlocked, the driver's seat and exterior mirrors resume their last set positions.

The most recent position is independent of the positions saved via the seat memory.

## Confirmation signals from the vehicle

Via iDrive:

1. "My Vehicle"
2. "Vehicle settings"
3. "Doors/Key"
4. Deactivate or activate the desired confirmation signals.
  - ▷ "Flash for lock/unlock"
 

Unlocking is signaled by two flashes, locking by one.
  - ▷ With alarm system:
 

"Acoustic signal for lock/unlock"

Unlocking is signaled by one honk of the horn.

## Automatic locking

Via iDrive:

1. "My Vehicle"
2. "Vehicle settings"
3. "Doors/Key"
4. Select desired setting:
  - ▷ "Lock automatically"
 

The vehicle locks automatically after a short period of time if no door is opened after unlocking.
  - ▷ "Lock after starting to drive"
 

The vehicle locks automatically after you drive off.

## Automatic unlocking

Via iDrive:

1. "My Vehicle"
2. "Vehicle settings"

3. "Doors/Key"
4. "Unlock at end of trip"

After the engine is switched off by pressing the Start/Stop button, the locked vehicle is automatically unlocked.

## Alarm system

### General information

When the vehicle is locked, the vehicle alarm system reacts to the following changes:

- ▷ Unauthorized opening of a door, the hood or the tailgate.
- ▷ Movements in the car's interior.
- ▷ Changes in the vehicle tilt, e. g., during attempts at stealing a wheel or when towing the vehicle.
- ▷ Disconnected battery voltage.
- ▷ Improper use of the socket for Onboard Diagnosis.
- ▷ Locking the vehicle while a device is connected to the socket for the OBD Onboard Diagnosis. Socket for the OBD Onboard Diagnosis, refer to page 272.

The alarm system signals the following changes visually and acoustically:

- ▷ Acoustic alarm:  
Depending on local regulations, the acoustic alarm may be suppressed.
- ▷ Visual alarm:  
By flashing the exterior lighting.

### Switching on/off

When you lock and unlock the vehicle with the remote control or Comfort Access, the alarm system will also switch on or off at the same time.

### Opening the doors with the alarm system switched on

The alarm system is triggered when a door is opened if the door was unlocked using the integrated key in the door lock.

Switching off the alarm, refer to page 85.

### Opening the tailgate with the alarm system switched on

The tailgate can be opened even when the alarm system is switched on.

After the tailgate is closed, it is locked and monitored again provided the doors are locked. The hazard warning system flashes once.

### Panic mode

You can trigger the alarm system if you find yourself in a dangerous situation.



- ▷ Press the button on the remote control and hold for at least 3 seconds.
- ▷ Briefly press the button on the remote control three times in succession.

To switch off the alarm: press any button.

### Indicator light on the interior mirror

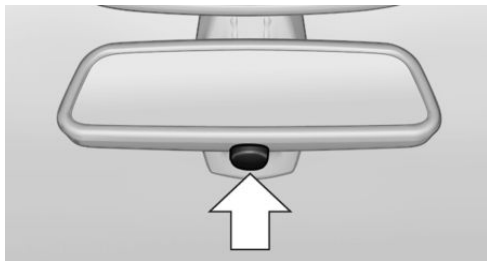

- ▷ The indicator light flashes briefly every 2 seconds:  
The alarm system is switched on.
- ▷ Indicator light flashes for approx. 10 seconds, then it flashes briefly every 2 seconds:

Interior motion sensor and tilt alarm sensor are not active, as doors, hood, or tailgate are not correctly closed. Correctly closed access points are secured.

When the still open access points are closed, interior motion sensor and tilt alarm sensor will be switched on.

- ▶ The indicator light goes out after unlocking: The vehicle has not been tampered with.
- ▶ The indicator light flashes after unlocking until the engine ignition is switched on, but no longer than approx. 5 minutes: An alarm has been triggered.

## Tilt alarm sensor

The tilt of the vehicle is monitored.

The alarm system responds in situations such as attempts to steal a wheel or when the vehicle is towed.

## Interior motion sensor

The windows and the glass sunroof must be closed for the system to function properly.

## Avoiding unintentional alarms

### General information

The tilt alarm sensor and interior motion sensor can trigger an alarm, although no unauthorized action occurred.

Possible situations for an unwanted alarm:

- ▶ In automatic vehicle washes.
- ▶ In duplex garages.
- ▶ During transport on trains carrying vehicles, at sea or on a trailer.
- ▶ With animals in the vehicle.
- ▶ When the vehicle is locked after start of fueling.

The tilt alarm sensor and the interior motion sensor can be switched off in such situations.

## Switching off the tilt alarm sensor and interior motion sensor



Press the button on the remote control within 10 seconds as soon as the vehicle is locked.

The indicator light lights up for approx. 2 seconds and then continues to flash.

The tilt alarm sensor and interior motion sensor are switched off until the vehicle is locked again.

## Switching off the alarm

- ▶ Unlock the vehicle with the remote control or switch on the ignition, if needed through emergency detection of remote control, refer to page 71.
- ▶ With Comfort Access: If you are carrying the remote control on your person, grasp the door handle on the driver's or front passenger door completely.

## Power windows

### General information

If an accident of a certain severity occurs, the windows are automatically closed except a gap.

### Safety information

#### **WARNING**

When operating the windows, body parts and objects can be jammed. There is a risk of injury or risk of damage to property. Make sure that the area of movement of the windows is clear during opening and closing.





## Overview



 Power windows



 Safety switch

## Opening

- ▷  Press the switch to the resistance point.  
The window opens while the switch is being held.
- ▷  Press the switch beyond the resistance point.  
The window opens automatically. Pressing the switch again stops the motion.

Convenient opening via the remote control, refer to page 69.

## Closing

- ▷  Pull the switch to the resistance point.  
The window closes while the switch is being held.
- ▷  Pull the switch beyond the resistance point.  
The window closes automatically if the door is closed. Pulling again stops the motion.

Closing via Comfort Access, refer to page 74.

## Jam protection system

### General information

If closing force exceeds a specific threshold as a window closes, closing is interrupted.

The window opens slightly.



### Safety information

#### **WARNING**

Accessories on the windows such as antennas can impact jam protection. There is a risk of injury. Do not install accessories in the area of movement of the windows.

### Closing without the jam protection system

In case of danger from the outside or if ice might prevent normal closing, proceed as follows:

1.  Pull the switch past the resistance point and hold it there.  
The window closes with limited jam protection. If the closing force exceeds a specific threshold, closing is interrupted.
2.  Pull the switch past the resistance point again within approx. 4 seconds and hold it there.  
The window closes without jam protection.

## Safety switch

### General information

The safety switch in the driver's door can be used to prevent children, for instance from opening and closing the rear windows using the switches in the rear.

If an accident of a certain severity occurs, the safety function is switched off automatically.

## Switching on/off



Press the button.

The LED lights up if the safety function is switched on.

## Panoramic glass sunroof

### General information

The glass sunroof is ready for operation when the ignition is switched on.

In the event of a severe accident, the glass sunroof is automatically closed.

### Safety information

#### WARNING

Body parts can be jammed when operating the glass sunroof. There is a risk of injury. Make sure that the area of movement of the glass sunroof is clear during opening and closing.

### Overview



### Tilting up and closing the tilted glass sunroof



Push switch briefly upward.

- ▶ The closed glass sunroof tilts and the sun protection opens slightly.

- ▶ The opened glass sunroof closes until it is in the tilted position. The sun protection does not move.
- ▶ The tilted glass sunroof closes.

### Opening/closing the glass sunroof and sun protection separately

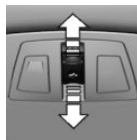

- ▶ Press the switch in the desired direction to the resistance point and hold it there.

Holding down the switch opens the sun protection. If the sun protection is already fully open, the glass sunroof opens.

The glass sunroof closes while the switch is being held. If the glass sunroof is already closed or in the tilted position, the sun protection closes.

- ▶ Press the switch in the desired direction past the resistance point.

The sun protection opens automatically. If the sun protection is already fully open, the glass sunroof opens automatically.

The glass sunroof closes automatically. If the glass sunroof is already closed or in the tilted position, the sun protection closes automatically.

Pressing the switch upward stops the motion.

### Opening/closing the glass sunroof and sun protection together

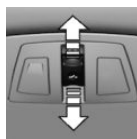

Briefly press the switch twice in succession in the desired direction past the resistance point.

The glass sunroof and sun protection move together. Pressing

the switch upward stops the motion.

Convenient opening via the remote control, refer to page 69.

Closing via Comfort Access, refer to page 74.

## Comfort position

In some models, the wind noises in the car's interior are lowest when the glass sunroof is not fully open. In these models, the automatic function initially only opens the glass sunroof up to this comfort position.

Pressing the switch again opens the glass sunroof fully.

## Jam protection system

### General information

If the closing force exceeds a certain value when closing the glass sunroof, the closing operation is interrupted once the roof reaches the half-open position, or it is stopped when closing from the tilted position. The glass sunroof opens slightly.

### Closing from the open position without jam protection

If there is an external danger, proceed as follows:

1. Push the switch forward past the resistance point and hold.  
The glass sunroof closes with limited jam protection. If the closing force exceeds a specific threshold, closing is interrupted.

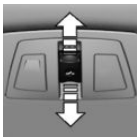

2. Push the switch forward again past the resistance point and hold until the glass sunroof closes without jam protection. Make sure that the closing area is clear.

### Closing from the raised position without jam protection

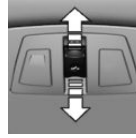

If there is an external danger, push the switch forward past the resistance point and hold it.

The glass sunroof closes without jam protection.

## Initializing after a power interruption

### General information

After a power failure during the opening or closing process, the glass sunroof can only be operated to a limited extent.

The system can be initialized under the following conditions.

- ▶ The vehicle is parked in a horizontal position.
- ▶ The engine is running.
- ▶ The external temperature is above 41 °F/5 °C.

During initialization, the glass sunroof closes without jam protection.

Make sure that the closing area is clear.

### Initializing the system

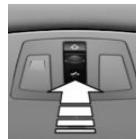

Press the switch up and hold it until initialization is complete.

Initialization begins within 15 seconds.

- ▶ If the glass sunroof is closed, it opens then closes again.
- ▶ If the glass sunroof is open, it first closes, then opens and closes again.

Initialization is complete once the glass sunroof and sun protection have opened then closed again.

# Seats, mirrors, and steering wheel

## Vehicle features and options

This chapter describes all standard, country-specific and optional features offered with the series. It also describes features that are not necessarily available in your vehicle, e. g., due to the selected options or country versions. This also applies to safety-related functions and systems. When using these functions and systems, the applicable laws and regulations must be observed.

## Sitting safely

An ideal seating position that meets the needs of the occupants can make a vital contribution to relaxed, fatigue-free driving.

In the event of an accident, the correct seating position plays an important role. Additionally, follow the following chapters for safe driving:

- ▶ Seats, refer to page [89](#).
- ▶ Safety belts, refer to page [92](#).
- ▶ Head restraints, refer to page [94](#).
- ▶ Airbags, refer to page [148](#).

## Front seats

### Safety information

#### **WARNING**

Seat adjustments while driving can lead to unexpected movements of the seat. Vehicle control could be lost. There is a risk of an accident. Only adjust the seat on the driver's side when the vehicle is stationary.

#### **WARNING**

With a backrest inclined too far to the rear, the efficacy of the safety belt can no longer be ensured. There is a risk of sliding under the safety belt in an accident. There is a risk of injuries or danger to life. Adjust the seat prior to starting the trip. Adjust the backrest so that it is in the most upright position as possible and do not adjust again while driving.

#### **WARNING**

There is a risk of jamming when moving the seats. There is a risk of injury or risk of damage to property. Make sure that the area of movement of the seat is clear prior to any adjustment.

## Electrically adjustable seats

### General information

The seat setting for the driver's seat is stored for the profile currently used. When the vehicle is unlocked via the remote control, the position is automatically retrieved if the function, refer to page [83](#), is activated for this purpose.

The current seat position can be stored using the memory function, refer to page [96](#).

## Overview

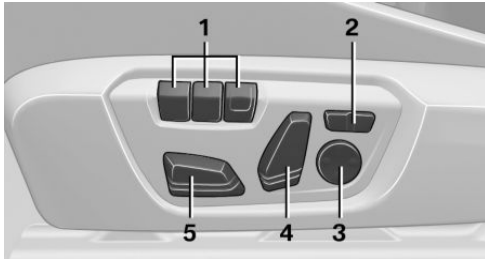

- 1 Memory function
- 2 Backrest width
- 3 Lumbar support
- 4 Backrest tilt
- 5 Forward/backward, height, seat tilt

## Forward/backward

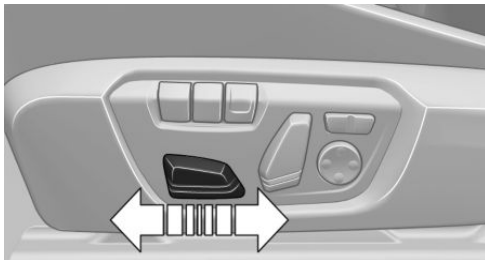

Push switch forward or backward.

## Height

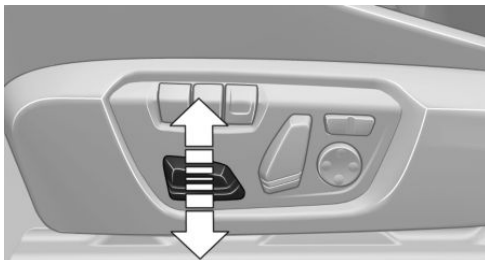

Push switch up or down.

## Seat tilt

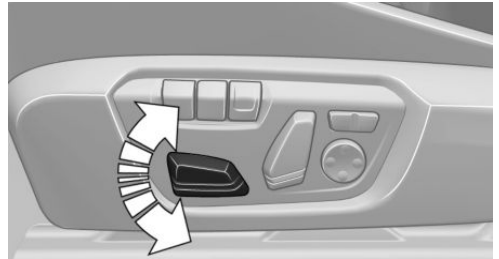

Move switch up or down.

## Backrest tilt

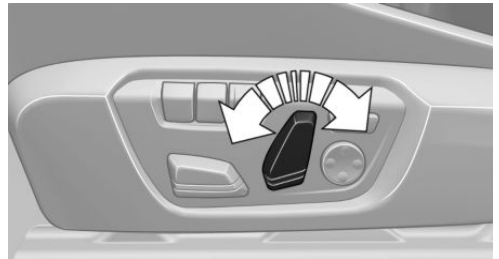

Move switch forward or backward.

## Thigh support

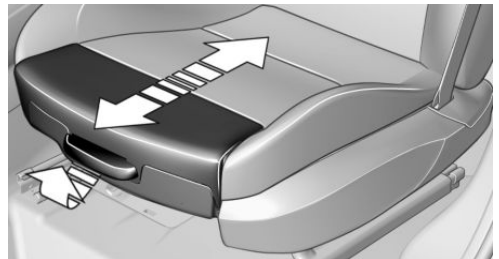

Pull the lever at the front of the seat and adjust the thigh support.

## Lumbar support

The curvature of the seat backrest can be adjusted in a way that it supports the lumbar region of the spine. The lower back and the spine are supported for upright posture.



- ▶ Press the front/rear section of the button:  
The curvature is increased/decreased.
- ▶ Press the upper/lower section of the button:  
The curvature is shifted up/down.

## Backrest width

### Concept

Adjusting the backrest width may improve lateral support when taking corners.

### General information

You can change the backrest width by adjusting the side wings of the backrest.

### Settings



- ▶ Press the front section of the button:  
The backrest width decreases.
- ▶ Press the rear section of the button:  
The backrest width increases.

## Front seat heating

### Overview



Seat heating

### Switching on



Press the button once for each temperature level.

The maximum temperature is reached when three LEDs are lit.

If the trip is continued within approx. 15 minutes after a stop, seat heating is activated automatically with the temperature selected last.

When ECO PRO is activated, refer to page 232, the heater output is reduced.

### Switching off



Press and hold the button until the LEDs go out.

## Rear seats

### Second row of seats

### Safety information

#### **WARNING**

There is a risk of jamming when folding down the center armrest in the rear. There is a risk of injury. Make sure that the area of movement of the center armrest is clear during folding down.

#### **WARNING**

Unexpected movements of the rear seat backrest while driving may occur due to unintentional unlocking of the rear seat backrests by the straps. There is a risk of injury. Do not fasten any objects to the straps for unlocking the rear backrests.

## Forward/backward

### General information

The rear seat is divided into two parts at a ratio of 60 – 40. The left seat is connected to the middle section.

### Settings

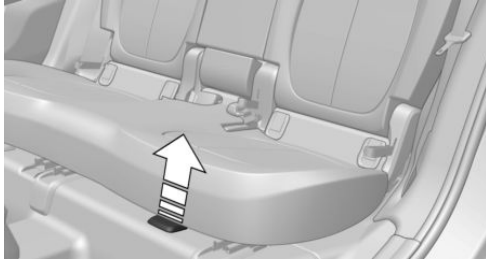

Pull the lever and slide the seat in the desired direction.

After releasing the lever, move the seat forward or back slightly making sure it engages properly.

### Backrest tilt

1. Pull loop to unlock the backrest.

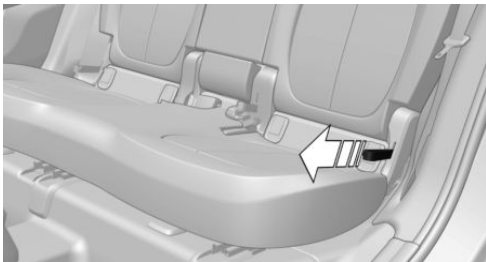

2. Apply or lift weight on the backrest as needed.

After the adjustment, move the backrest slightly forward or back to engage it correctly.

## Safety belts

### Number of safety belts and safety belt buckles

The vehicle is fitted with five safety belts to ensure occupant safety. However, they can only offer protection when adjusted correctly.

The two outer safety belt buckles of the rear seat are intended for the persons sitting on the left and right.

The center safety belt buckles of the rear seat are intended for the persons sitting in the middle.

### General information

Always make sure that safety belts are being worn by all occupants before driving off. Although airbags enhance safety by providing added protection, they are not a substitute for safety belts.

The upper shoulder strap's anchorage point will be correct for adult seat occupants of every build if the seat is correctly adjusted.

### Safety information

#### **⚠ WARNING**

Use of a safety belt to buckle more than one person will potentially defeat the ability of the safety belt to serve its protective function. There is a risk of injuries or danger to life. Do not allow more than one person to wear a single safety belt. Infants and children are not allowed on an occupant's lap, but must be transported and secured in designated child restraint systems.

#### **⚠ WARNING**

The efficacy of safety gear, including safety belts, can be limited or lost when safety belts are fastened incorrectly. An incorrectly fastened safety belt can cause additional injuries, for in-

stance in the event of an accident or during braking and evasive maneuvers. There is a risk of injuries or danger to life. Make sure that all occupants are wearing safety belts correctly.

### **WARNING**

With a rear backrest that is not locked, the protective function of the middle safety belt is not guaranteed. There is a risk of injuries or danger to life. If you are using the middle safety belt, lock the wider rear seat backrest.

### **WARNING**

The efficacy of safety gear, including safety belts, may not be fully functional or fail in the following situations:

- ▷ The safety belts or safety belt buckles are damaged, soiled, or changed in any other way.
- ▷ Belt tensioners or belt retractors were modified.

Safety belts can be imperceptibly damaged in the event of an accident. There is a risk of injuries or danger to life. Do not modify safety belts, safety belt buckles, belt tensioners, belt retractors or belt anchors and keep them clean. Have the safety belts checked after an accident at the dealer's service center or another qualified service center or repair shop.

## Correct use of safety belts

- ▷ Wear the safety belt twist-free and tight to your body over your lap and shoulders.
- ▷ Wear the safety belt deep on your hips over your lap. The safety belt may not press on your stomach.
- ▷ Do not rub the safety belt against sharp edges, or guide it or jam it in across hard or fragile objects.
- ▷ Avoid thick clothing.

- ▷ Re-tighten the safety belt frequently upward around your upper body.

## Buckling the safety belt

1. Guide the safety belt slowly over shoulder and hip to put it on.
2. Insert the tongue plate into the safety belt buckle. The safety belt buckle must engage audibly.

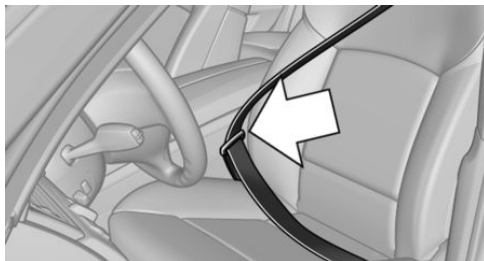

## Unbuckling the safety belt

1. Hold the safety belt firmly.
2. Press the red button in the belt buckle.
3. Guide the safety belt back into its roll-up mechanism.

## Middle safety belt in the rear

### Buckling the safety belt

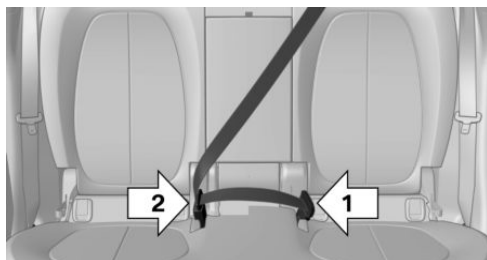

1. Pull the buckle tongues out of the mounts in the roof.
2. Insert the lower buckle tongue in the belt buckle, arrow 1.



3. Insert the upper buckle tongue in the belt buckle, arrow 2.

Safety belt buckles must audibly click into place.

### Unbuckling the safety belt

1. Hold the safety belt firmly.
2. Press the red button in the belt buckle.
3. Use the buckle tongue, arrow 1, to open the second safety belt buckle, arrow 2.

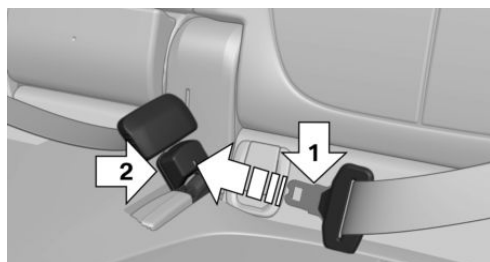

4. Guide the safety belt to the mount in the roofliner.

### Safety belt reminder for driver's and passenger's seat

#### Display in the instrument cluster



The indicator light lights up and a signal sounds. Make sure that the safety belts are positioned correctly. The safety belt reminder can also be activated if objects are placed on the front passenger seat.

The indicator light lights up and a signal sounds. Make sure that the safety belts are positioned correctly. The safety belt reminder can also be activated if objects are placed on the front passenger seat.

## Front head restraints

### Safety information

#### **WARNING**

A missing protective effect due to removed or not correctly adjusted head restraints can cause injuries in the head and neck area. There is a risk of injury.

- ▷ Before driving, install the removed head restraints on the occupied seats.
- ▷ Adjust the head restraint so its center supports the back of the head at as close to eye level as possible.
- ▷ Adjust the distance so that the head restraint is as close as possible to the back of the head. Adjust the distance via the backrest tilt as needed.

#### **WARNING**

Body parts can be jammed when moving the head restraint. There is a risk of injury. Make sure that the area of movement is clear when moving the head restraint.

#### **WARNING**

Objects on the head restraint reduce the protective effect in the head and neck area. There is a risk of injury.

- ▷ Do not use seat or head restraint covers.
- ▷ Do not hang objects, for instance clothes hangers, directly on the head restraint.
- ▷ Only use accessories that have been determined to be safe for attachment to a head restraint.
- ▷ Do not use any accessories, for instance pillows, while driving.

### Adjusting the height

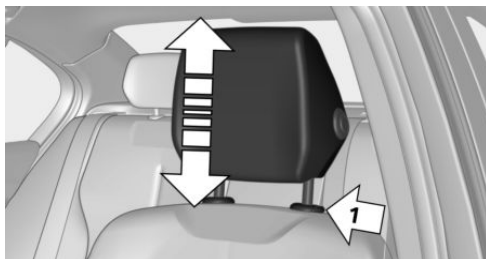

- ▷ To raise: push the head restraint up.

- ▷ To lower: press button, arrow 1, and push head restraint down.

After setting the height, move the head restraint up or down slightly, making sure it engages properly.

## Removing

Only remove the head restraint if no one will be sitting in the seat in question.

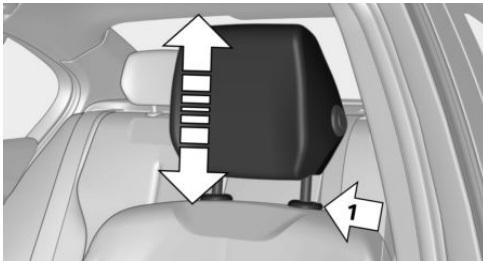

1. Raise the head restraint up against the resistance.
2. Press the button, arrow 1, and pull the head restraint out completely.

## Installing

Proceed in the reverse order to install the head restraint.

## Rear head restraints

### Safety information

#### WARNING

A missing protective effect due to removed or not correctly adjusted head restraints can cause injuries in the head and neck area. There is a risk of injury.

- ▷ Before driving, install the removed head restraints on the occupied seats.
- ▷ Adjust the head restraint so its center supports the back of the head at as close to eye level as possible.

- ▷ Adjust the distance so that the head restraint is as close as possible to the back of the head. Adjust the distance via the backrest tilt as needed.

#### WARNING

Body parts can be jammed when moving the head restraint. There is a risk of injury. Make sure that the area of movement is clear when moving the head restraint.

#### WARNING

Objects on the head restraint reduce the protective effect in the head and neck area. There is a risk of injury.

- ▷ Do not use seat or head restraint covers.
- ▷ Do not hang objects, for instance clothes hangers, directly on the head restraint.
- ▷ Only use accessories that have been determined to be safe for attachment to a head restraint.
- ▷ Do not use any accessories, for instance pillows, while driving.

## Height

### Settings

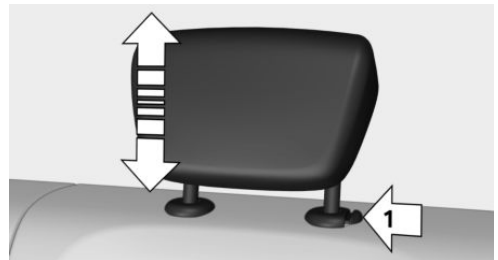

- ▷ To lower: press the button, arrow 1, and push the head restraint down.
- ▷ To raise: push the head restraint up.

After setting the height, move the head restraint up or down slightly, making sure it engages properly.

## Folding down the head restraint

Only fold the head restraint back if no one will be sitting in the seat in question.

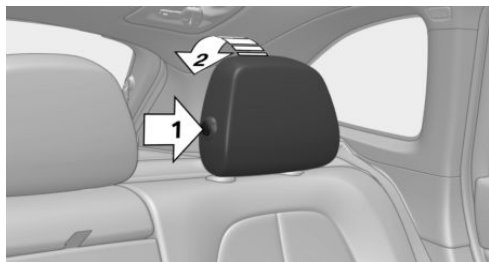

- ▷ To the back: press the button, arrow 1, and fold the head restraint back, arrow 2.
- ▷ Forward: fold the head restraint toward the front as far as it will go. Make sure that the head restraint engages correctly.

## Removing

The head restraints cannot be removed.

## Memory function

### Concept

The following settings can be stored and, if necessary, retrieved using the memory function:

- ▷ Seat position.
- ▷ Exterior mirror position.
- ▷ Height of the Head-up Display.

### General information

Different settings can be assigned to two memory locations.

Depending on the vehicle equipment, the following settings are not stored:

- ▷ Backrest width.

- ▷ Lumbar support.

## Safety information

### **! WARNING**

Using the memory function while driving can lead to unexpected movements of the seat. Vehicle control could be lost. There is a risk of an accident. Only retrieve the memory function when the vehicle is stationary.

### **! WARNING**

There is a risk of jamming when moving the seats. There is a risk of injury or risk of damage to property. Make sure that the area of movement of the seat is clear prior to any adjustment.

## Overview



### Storing

1. Switch on the ignition.
2. Set the desired position.
3. **SET** Press button. The LED in the button lights up.
4. Press selected button 1 or 2 while the LED is lit. The LED goes out.

**SET** Button was pressed inadvertently:  
Press the button again.

The LED goes out.

## Calling up settings

The stored position is called up automatically.

Press selected button 1 or 2.

The procedure stops when a switch for setting the seat or one of the memory buttons is pressed.

While driving, the seat position adjustment on the driver's side is interrupted after a short time.

## Calling up of a seat position deactivated

After a brief period, calling up stored seat positions is deactivated to save battery power.

To reactivate calling up of a seat position:

- ▶ Open or close the door or tailgate.
- ▶ Press a button on the remote control.
- ▶ Press the Start/Stop button.

## Mirrors

### Exterior mirrors

#### General information

The mirror on the front passenger side is more curved than the driver's side mirror.

The mirror setting is stored for the driver profile currently in use. When the vehicle is unlocked via the remote control, the position is automatically retrieved if the function, refer to page 83, is activated for this purpose.

The current exterior mirror position can be stored using the memory function, refer to page 96.

#### Safety information

##### WARNING

Objects reflected in the mirror are closer than they appear. The distance to the traffic behind could be incorrectly estimated, for instance while changing lanes. There is a risk of an acci-

dent. Estimate the distance to the traffic behind by looking over your shoulder.

### Overview



- 1 Settings
- 2 Selecting a mirror, Automatic Curb Monitor
- 3 Folding in and out

### Selecting a mirror



To change over to the other mirror:  
Slide the switch.

### Adjusting electrically



Press the button.

The mirror movement follows the button movement.

### Malfunction

In case of an electrical malfunction, adjust the mirror by pressing the edges of the mirror glass.

### Folding in and out

##### NOTICE

Depending on the vehicle width, the vehicle can be damaged in vehicle washes. There is a risk of damage to property. Before washing, fold in the mirrors by hand or with the button.



Press the button.

Folding is only possible up to a speed of approx. 15 mph/20 km/h.

Folding the mirrors in and out is helpful in the following situations:

- ▷ In vehicle washes.
- ▷ On narrow roads.

Mirrors that were folded in are folded out automatically at a speed of approx. 25 mph/40 km/h.

### Automatic heating

Both exterior mirrors are automatically heated as needed and when the ignition is switched on.

### Automatic dimming feature

The exterior mirror on the driver's side is automatically dimmed. Photocells in the interior mirror are used to control this.

### Automatic Curb Monitor, exterior mirror

#### Concept

If reverse gear is engaged, the mirror glass on the front passenger side is tilted downward. This improves your view of the curb and other low-lying obstacles when parking, for instance.

#### Activating

1.  Slide the switch to the driver's side mirror position.
2. Engage selector lever position R.

#### Deactivating

-  Slide the switch to the passenger's side mirror position.

### Interior mirror, manually dimmable

#### Turn knob

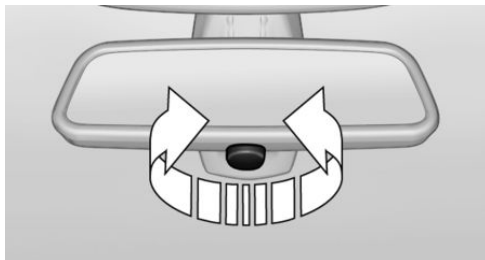

Turn the knob to reduce the blinding effect by the interior mirror.

### Interior mirror, automatic dimming feature

#### Overview

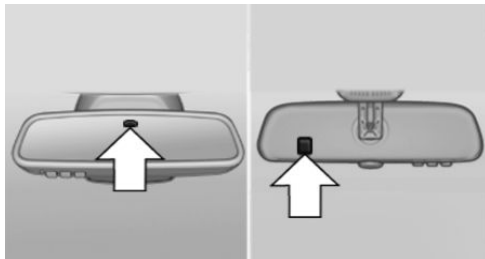

Photocells are used for control:

- ▷ In the mirror glass.
- ▷ On the back of the mirror.

#### Functional requirements

- ▷ Keep the photocells clean.
- ▷ Do not cover the area between the interior mirror and the windshield.

## Steering wheel

### Safety information

#### **WARNING**

Steering wheel adjustments while driving can lead to unexpected steering wheel movements. Vehicle control could be lost. There is a risk of an accident. Adjust the steering wheel while the vehicle is stationary only.

### Settings

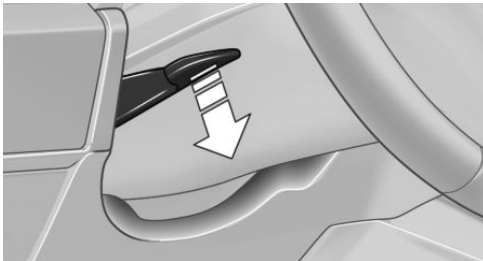

1. Fold the lever down.
2. Move the steering wheel to the preferred height and angle to suit your seating position.
3. Fold the lever back up.

## Heated steering wheel

### Overview



Heated steering wheel

### Switching on/off



Press the button.

- ▷ On: the LED lights up.
- ▷ Off: the LED goes out.

# Transporting children safely

## Vehicle features and options

This chapter describes all standard, country-specific and optional features offered with the series.

It also describes features that are not necessarily available in your vehicle, e. g., due to the selected options or country versions. This also applies to safety-related functions and systems. When using these functions and systems, the applicable laws and regulations must be observed.

## The right place for children

### Safety information

#### WARNING

Unattended children or animals can cause the vehicle to move and endanger themselves and traffic, for instance due to the following actions:

- ▷ Pressing the Start/Stop button.
- ▷ Releasing the parking brake.
- ▷ Opening and closing the doors or windows.
- ▷ Engaging selector lever position N.
- ▷ Using vehicle equipment.

There is a risk of accidents or injuries. Do not leave children or animals unattended in the vehicle. Take the remote control with you when exiting and lock the vehicle.

as soon as a suitable child restraint system can no longer be used due to their age, weight, and size.

### Safety information

#### WARNING

The safety belt cannot be fastened correctly on children shorter than 5 ft, 150 cm without suitable additional child restraint systems. The efficacy of safety gear, including safety belts, can be limited or lost when safety belts are fastened incorrectly. An incorrectly fastened safety belt can cause additional injuries, for instance in the event of an accident or during braking and evasive maneuvers. There is a risk of injuries or danger to life. Secure children shorter than 5 ft, 150 cm using suitable child restraint systems.

## Always transport children in the rear seat

### General information

Accident research shows that the safest place for children is in the rear seat.

Transport children younger than 13 years of age or shorter than 5 ft/150 cm only in the rear seat in suitable child restraint systems designed for the age, weight and size of the child. Children 13 years of age or older must wear a safety belt

## Children on the front passenger seat

### General information

Should it ever be necessary to use a child restraint system in the front passenger seat, make sure that the front, knee and side airbags on the front passenger side are deactivated. Automatic deactivation of front-seat passenger airbags, refer to page [150](#).



## Safety information

### WARNING

Active front-seat passenger airbags can injure a child in a child restraint system when the airbags are activated. There is a risk of injury. Make sure that the front-seat passenger airbags are deactivated and that the PASSENGER AIRBAG OFF indicator light lights up.

## Installing child restraint systems

### General information

Pay attention to the specifications of the child restraint system manufacturer when selecting, installing, and using child restraint systems.

### Safety information

#### WARNING

The stability of the child restraint system is limited or compromised with incorrect seat adjustment or improper installation of the child seat. There is a risk of injuries or danger to life. Make sure that the child restraint system fits securely against the backrest. If possible, adjust the backrest tilt for all affected backrests and correctly adjust the seats. Make sure that seats and backrests are securely engaged or locked. If possible, adjust the height of the head restraints or remove them.

#### WARNING

The protective effect of damaged child restraint systems or of child restraint systems exposed to an accident and their fastening systems can be limited or lost. A child can e.g., not sufficiently restrained, for instance in the event of an accident or braking and evasive maneuvers.

There is a risk of injuries or danger to life. Have damaged child restraint systems or of child restraint systems exposed to an accident and their fastening systems checked and possibly replaced by the dealer's service center or another qualified service center or repair shop.

### Before mounting

Before mounting child restraint systems, ensure that the rear seat backrests are locked.

Move the rear seats into the rearmost position to facilitate assembly of the child restraint system.

### On the front passenger seat

#### Deactivating airbags

#### WARNING

Active front-seat passenger airbags can injure a child in a child restraint system when the airbags are activated. There is a risk of injury. Make sure that the front-seat passenger airbags are deactivated and that the PASSENGER AIRBAG OFF indicator light lights up.

After installing a child restraint system in the front passenger seat, make sure that the front, knee and side airbags on the front passenger side are deactivated.

Deactivate the front-seat passenger airbags automatically, refer to page 150.

#### Seat position and height

Before installing a child restraint system, move the front passenger seat as far back as possible and bring it as far up as possible to obtain the best possible position for the belt and to offer optimal protection in the event of an accident.

If the upper anchorage of the safety belt is located in front of the belt guide of the child seat, move the front passenger seat carefully forward until the best possible belt guide position is reached.



## Backrest width

Adjustable backrest width: before installing a child restraint system in the front passenger seat, open the backrest width completely. Do not change the backrest width again and do not call up a memory position.

## Child seat security



The rear safety belts and the front passenger safety belt can be permanently locked to fasten child restraint systems.

## Locking the safety belt

1. Pull out the belt strap completely.
2. Secure the child restraint system with the safety belt.
3. Allow the belt strap to be pulled in and pull it tight against the child restraint system. The safety belt is locked.

## Unlocking the safety belt

1. Unbuckle the safety belt buckle.
2. Remove the child restraint system.
3. Allow the belt strap to be pulled in completely.

In some cases it may be necessary to separate the lower belt attachment. Safety belts, refer to page 93.

## LATCH child restraint fixing system

### General information

LATCH: Lower Anchors and Tether for Children.

Pay attention to the operating and safety information of the child restraint system manufacturer when installing and using LATCH child restraint fixing systems.

### Mounts for the lower LATCH anchors



The lower anchors may be used to attach the CRS to the vehicle seat up to a combined child and CRS weight of 65 lbs/30 kg when the child is restrained by the internal harnesses.

### Safety information

#### WARNING

If the LATCH child restraint fixing systems are not correctly engaged, the protective effect of the LATCH child restraint fixing system can be limited. There is a risk of injuries or danger to life. Make sure that the lower anchors are securely engaged and that the LATCH child restraint fixing system fits securely against the backrest.

## Position

Symbol	Meaning
	The corresponding symbol shows the mounts for the lower LATCH anchors.
	Seats equipped with lower anchors are marked with a pair, 2, of LATCH symbols. For vehicles equipped with a middle seat: It is not recommended to use the inner lower anchors of standard outer LATCH positions to fasten a child restraint system on the middle seat. Use the vehicle safety belt instead for the middle seat.

## Before installing LATCH child restraint fixing systems

Pull the safety belt away from the area of the child restraint system.

## Assembly of LATCH child restraint fixing systems

1. Install child restraint system, see manufacturer's information.
2. Ensure that both LATCH anchors are properly connected.

## Child restraint systems with tether strap

### Safety information

#### WARNING

If the upper retaining strap is incorrectly used for the child restraint system, the protective effect can be reduced. There is a risk of injury. Make sure that the upper retaining strap is not guided across sharp edges and without twisting to the upper retaining strap.

#### WARNING

If the rear backrest is not locked, the protective effect of the child restraint system is limited or there is none. In particular situations, for instance braking maneuvers or in case of an accident, the rear backrest can fold forward. There is a risk of injuries or danger to life. Make sure that the rear backrests are locked.

#### NOTICE

The anchors for the upper retaining straps of child restraint systems are only provided for these retaining straps. When other objects are mounted, the anchors can be damaged. There is a risk of damage to property. Only mount child restraint systems to the upper retaining straps.

## Anchors



The respective symbol shows the anchor for the upper retaining strap. Seats with an upper top tether are marked with this symbol. It can be found on the rear seat backrest or the rear window shelf.

## Routing the retaining strap

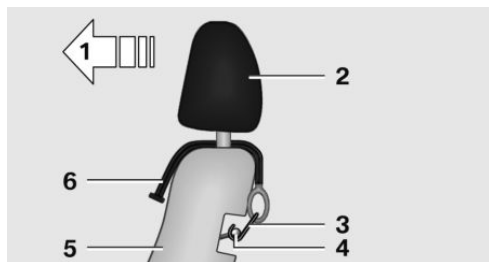

- 1 Direction of travel
- 2 Head restraint
- 3 Hook for upper retaining strap
- 4 Anchor
- 5 Seat backrest
- 6 Upper retaining strap

## Attaching the upper retaining strap to the anchor

1. Raise the head restraint, if needed.
2. Guide the upper retaining strap between or along both sides of the supports of the head restraint to the anchor.
3. If there is a retaining strap, run it between the backrest and the cargo cover.
4. Attach the hook of the retaining strap to the anchor.
5. Tighten the retaining strap by pulling it down.
6. Lower and lock head restraints as needed.

## Locking the doors and windows in the rear

### Rear doors

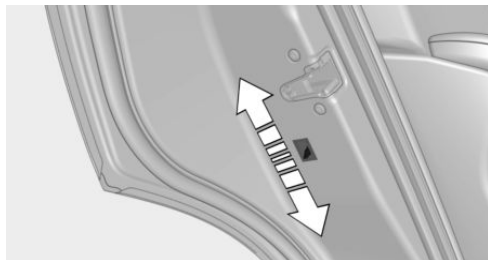

Push the locking lever on the rear doors up.

The door can now be opened from the outside only.

### Safety switch for the rear



Press the button on the driver's door.

The LED lights up if the safety function is switched on.

This locks various functions so that they cannot be operated from the rear.

# Driving

## Vehicle features and options

This chapter describes all standard, country-specific and optional features offered with the series. It also describes features that are not necessarily available in your vehicle, e. g., due to the selected options or country versions. This also applies to safety-related functions and systems. When using these functions and systems, the applicable laws and regulations must be observed.

## Start/Stop button

### Concept



Pressing the Start/Stop button switches the ignition on or off and starts the engine.

Steptronic transmission: the engine starts with the brake pedal pressed when you press the Start/Stop button.

### Ignition on

Steptronic transmission: press the Start/Stop button, and do not press on the brake pedal at the same time.

All vehicle systems are ready for operation.

Most of the indicator/warning lights in the instrument cluster light up for a varied length of time.

To save battery power when the engine is off, switch off the ignition and any unnecessary electronic systems/power consumers.

### Ignition off

Steptronic transmission: shift to selector lever position P, press the Start/Stop button again without stepping on the brake.

All indicator lights in the instrument cluster go out.

To save battery power when the engine is off, switch off the ignition and any unnecessary electronic systems/power consumers.

### Safety measures

The ignition is switched off automatically in the following situations while the vehicle is stationary and the engine is off:

- ▶ When locking the vehicle, and when the low beams are switched on.
- ▶ Shortly before the battery is discharged completely, so that the engine can still be started.
- ▶ When opening or closing the driver door, if the driver's safety belt is unbuckled and the low beams are switched off.
- ▶ While the driver's safety belt is unbuckled with driver's door open and low beams off.
- ▶ When the front doors are opened if there is no other person sitting in the front seats.

The low beams switch to parking lights after some minutes of no use.

Steptronic transmission with a tap-operated selector lever, refer to page 119: when switching off the ignition, the selector lever position P is engaged automatically if the selector lever position R, D or M/S is engaged.

### Radio-ready state

#### General information

In the radio-ready state, certain power consumers remain ready for operation.

#### Activating

With the engine running, press the Start/Stop button.



If the engine is not running and the ignition is switched on: the system automatically activates radio-ready state when the door is opened if the lights are switched off or the daytime running lights are switched on.

The radio-ready state remains active if, for instance the ignition is automatically switched off for the following reasons:

- ▷ Opening or closing the driver's door.
- ▷ Unfastening of the driver's safety belt.
- ▷ When automatically switching from low beams to parking lights.

## Switching off automatically

The radio-ready state is switched off automatically in the following situations:

- ▷ If the driver's or front passenger door is opened when exiting the vehicle, with the engine switched off manually.
- ▷ If the ignition is switched off manually with the Start/Stop button.
- ▷ After approx. 8 minutes.
- ▷ When the vehicle is locked using the central locking system.
- ▷ Shortly before the battery is discharged completely, so that the engine can still be started.

## Starting the engine

### Safety information

#### DANGER

If the exhaust pipe is blocked or ventilation is insufficient, harmful exhaust gases can enter into the vehicle. The exhaust gases contain pollutants which are colorless and odorless. In enclosed areas, exhaust gases can also accumulate outside of the vehicle. There is danger to life. Keep the exhaust pipe free and ensure sufficient ventilation.

#### WARNING

An unsecured vehicle can begin to move and possibly roll away. There is a risk of an accident. Before exiting, secure the vehicle against rolling.

In order to ensure that the vehicle is secured against rolling away, follow the following:

- ▷ Set the parking brake.
- ▷ On uphill grades or on a downhill slope, turn the front wheels in the direction of the curb.
- ▷ On uphill grades or on a downhill slope, also secure the vehicle, for instance with a wheel chock.

#### NOTICE

In the case of repeated starting attempts or repeated starting in quick succession, the fuel is not burned or is inadequately burned. The catalytic converter can overheat. There is a risk of damage to property. Avoid repeated starting in quick succession.

## Gasoline engine

Depending on the motorization, the full drive power may not be available for approximately 30 seconds after starting the engine. In this case, the vehicle will not accelerate as usual.

## Steptronic transmission

### Starting the engine

1. Depress the brake pedal.
2. Press the Start/Stop button.

The ignition is activated automatically for a brief time and is stopped as soon as the engine starts.

## Engine stop

### Safety information

#### WARNING

Unattended children or animals can cause the vehicle to move and endanger themselves and traffic, for instance due to the following actions:

- ▷ Pressing the Start/Stop button.
- ▷ Releasing the parking brake.
- ▷ Opening and closing the doors or windows.
- ▷ Engaging selector lever position N.
- ▷ Using vehicle equipment.

There is a risk of accidents or injuries. Do not leave children or animals unattended in the vehicle. Take the remote control with you when exiting and lock the vehicle.

#### WARNING

An unsecured vehicle can begin to move and possibly roll away. There is a risk of an accident. Before exiting, secure the vehicle against rolling.

In order to ensure that the vehicle is secured against rolling away, follow the following:

- ▷ Set the parking brake.
- ▷ On uphill grades or on a downhill slope, turn the front wheels in the direction of the curb.
- ▷ On uphill grades or on a downhill slope, also secure the vehicle, for instance with a wheel chock.

## Steptronic transmission

### Switching off the engine

1. When the vehicle is stationary, apply the parking brake.

2. Engage selector lever position P.

3. Press the Start/Stop button.

The engine is switched off.

The radio-ready state is switched on.

## Auto Start/Stop function

### Concept

The Auto Start/Stop function helps save fuel. The system switches off the engine during a stop, for instance in traffic congestion or at traffic lights. The ignition remains switched on. The engine starts automatically for driving off.

### General information

Depending on the selected driving mode, the system is automatically activated or deactivated.

After every start of the engine using the Start/Stop button, the Auto Start/Stop function is in the last selected state. When the Auto Start/Stop function is active, it is available when the vehicle is traveling faster than about 3 mph/5 km/h.

## Engine stop

### Functional requirements

The engine is switched off automatically during a stop under the following conditions:

Steptronic transmission:

- ▷ The selector lever is in selector lever position D.
- ▷ The brake pedal remains depressed while the vehicle is stopped.
- ▷ The driver's safety belt is buckled or the driver's door is closed.

In order to be able to release the brake pedal, engage the selector lever in position P. The engine remains off.

To continue driving depress the brake pedal. When a gear is engaged, the engine starts automatically.



The air flow from the air conditioner is reduced when the engine is switched off.

### Displays in the instrument cluster



The READY display in the tachometer signals that the Auto Start/Stop function is ready to start the engine automatically.



The display indicates that the conditions for an automatic engine stop have not been met.

### Functional limitations

The engine is not switched off automatically in situations such as the following:

- ▷ In case of a steep downhill grade.
- ▷ External temperature too low.
- ▷ The external temperature is high and automatic climate control is running.
- ▷ The car's interior has not yet been heated or cooled to the required level.
- ▷ The engine is not yet at operating temperature.
- ▷ The wheels are at a sharp angle or the steering wheel is being turned.
- ▷ After driving in reverse.
- ▷ Where there is a risk of window condensation when the automatic climate control is switched on.
- ▷ Vehicle battery is heavily discharged.
- ▷ At higher elevations.
- ▷ The hood is unlocked.
- ▷ HDC Hill Descent Control is activated.
- ▷ The parking assistant is activated.
- ▷ Stop-and-go traffic.
- ▷ Selector lever in selector lever position N, M/S or R.
- ▷ Use of fuel with high ethanol content.

### Starting the engine

The engine starts automatically under the following conditions:

- ▷ Steptronic transmission: by releasing the brake pedal.

After the engine starts, accelerate as usual.

### Safety mode

After the engine switches off automatically, it will not start again automatically if any one of the following conditions are met:

- ▷ The driver's safety belt is unbuckled and the driver's door is open.
- ▷ The hood was unlocked.

Some indicator lights light up for a varied length of time.

The engine can only be started via the Start/Stop button.

### Functional limitations

Even if driving off was not intended, the deactivated engine starts up automatically in the following situations:

- ▷ Excessive warming of the car's interior when the air conditioning is switched on.
- ▷ The steering wheel is turned.
- ▷ Steptronic transmission: change from selector lever position D to R, N or M/S.
- ▷ Steptronic transmission: change from selector lever position P to N, D, R or M/S.
- ▷ Where there is a risk of window condensation when the automatic climate control is switched on.
- ▷ Vehicle battery is heavily discharged.
- ▷ Excessive cooling of the car's interior when the heating is switched on.

## Activating/deactivating the system manually

### Using the button



Press the button.

- ▶ LED comes on: auto Start/Stop function is deactivated.  
The engine is started during an automatic engine stop.  
The engine can only be stopped or started via the Start/Stop button.
- ▶ LED goes out: auto Start/Stop function is activated.

### Switching off the vehicle during an automatic engine stop

During an automatic engine stop, the vehicle can be switched off permanently, for instance when leaving it.

Steptronic transmission:

1. Engage selector lever position P.
2. Press the Start/Stop button. The ignition is switched off. The Auto Start/Stop function is deactivated.
3. Set the parking brake.

Engine start as usual via Start/Stop button.

### Automatic deactivation

In certain situations, the Auto Start/Stop function is deactivated automatically for safety reasons, for instance if no driver is detected.

## Malfunction

The Auto Start/Stop function no longer switches off the engine automatically. A Check Control message is displayed. It is possible to continue driving. Have the system checked by a dealer's service center or another qualified service center or repair shop.

## Parking brake

### Concept

The parking brake is used to prevent the vehicle from rolling when it is parked.

### Safety information

#### WARNING

An unsecured vehicle can begin to move and possibly roll away. There is a risk of an accident. Before exiting, secure the vehicle against rolling.

In order to ensure that the vehicle is secured against rolling away, follow the following:

- ▶ Set the parking brake.
- ▶ On uphill grades or on a downhill slope, turn the front wheels in the direction of the curb.
- ▶ On uphill grades or on a downhill slope, also secure the vehicle, for instance with a wheel chock.

#### WARNING

Unattended children or animals can cause the vehicle to move and endanger themselves and traffic, for instance due to the following actions:

- ▶ Pressing the Start/Stop button.
- ▶ Releasing the parking brake.
- ▶ Opening and closing the doors or windows.
- ▶ Engaging selector lever position N.

▷ Using vehicle equipment.

There is a risk of accidents or injuries. Do not leave children or animals unattended in the vehicle. Take the remote control with you when exiting and lock the vehicle.

## Overview



Parking brake

## Setting

### With a stationary vehicle

Pull the switch.  
The LED lights up.

The indicator light lights up red. The parking brake is set.

Depending on the stopping situation, the parking brake is engaged automatically.

Steptronic transmission: in some parking situations, the parking brake is automatically engaged, when selector lever position P is engaged. In these cases, the parking brake is released automatically when you leave the selector lever position P.

### While driving

To use as emergency brake while driving: Pull the switch and hold it. The vehicle brakes hard while the switch is being pulled.

The indicator light lights up red, a signal sounds and the brake lights light up.

A Check Control message is displayed.

If the vehicle is decelerated to a complete stop, the parking brake is engaged.

## Releasing

### Releasing manually

1. Switch on the ignition.
2. Steptronic transmission: press the switch while the brake is pressed or selector lever position P is set.

The LED and indicator light go out.

The parking brake is released.

### Automatic release in cars with Steptronic transmission

For automatic release, step on the accelerator pedal.

The LED and indicator light go out.

The parking brake is automatically released when you step on the accelerator under the following conditions:

- ▷ Engine on.
- ▷ Drive mode engaged.
- ▷ Driver buckled in and doors closed.

## Malfunction

In the event of a failure or malfunction of the parking brake, secure the vehicle against rolling using a wheel chock, for instance when leaving it.

## After a power failure

### Putting the parking brake into operation

1. Switch on the ignition.

-  Press the switch while stepping on the brake pedal or selector lever position P is set.

It may take several seconds for the brake to be put into operation. Any sounds associated with this are normal.



The indicator light in the instrument cluster goes out as soon as the parking brake is ready for operation.

## Turn signal, high beams, headlight flasher

### Turn signal

#### Turn signal in exterior mirror

When driving and during operation of the turn signals or hazard warning system, do not fold in the exterior mirrors, so that the signal lights on the exterior mirror are easy to see.

#### Using turn signals

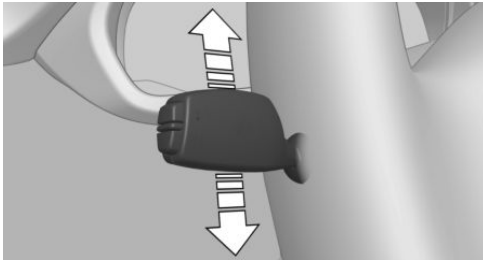

Press the lever past the resistance point.

Canada: the lever returns into its starting position after actuation. To switch off manually, slightly tap the lever to the resistance point.

#### Triple turn signal activation

Lightly tap the lever up or down.

The turn signal flashes three times.

The function can be activated or deactivated.

Via iDrive:

- "My Vehicle"
- "Vehicle settings"
- "Lighting"
- "Exterior lighting"
- "One-touch turn signal"
- Select the desired setting.

Settings are stored for the profile currently used.

#### Signaling briefly

Press the lever to the resistance point and hold it there for as long as you want the turn signal to flash.

#### Malfunction

Unusually rapid flashing of the indicator light indicates that a turn signal bulb has failed.

#### High beams, headlight flasher

Push the lever forward or pull it backward.

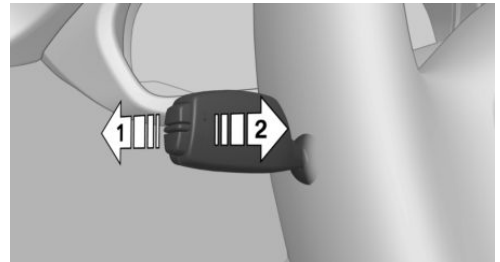

- ▷ High beams on, arrow 1.  
 The high beams light up when the low beams are switched on.
- ▷ High beams off/headlight flasher, arrow 2.

## Washer/wiper system

### General information

Do not use the wipers if the windshield is dry, as this may damage the wiper blades or cause them to become worn more quickly.

### Safety information

#### WARNING

If the wipers start moving in the folded away state, body parts can be jammed or damage may occur to parts of the vehicle. There is a risk of injury or risk of damage to property. Make sure that the vehicle is switched off when the wipers are in the folded away state and the wipers are folded in when switching on.

#### NOTICE

If the wipers are frozen to the windshield, the wiper blades can be torn off and the wiper motor can overheat when switching on. There is a risk of damage to property. Defrost the windshield prior to switching the wipers on.

### Switching on

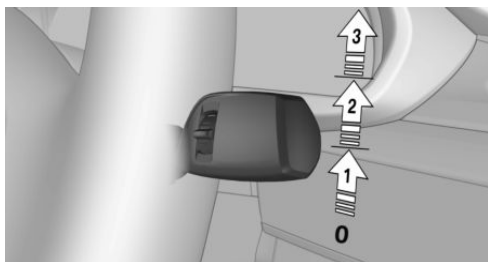

Press the lever up until the desired position is reached.

- ▷ Resting position of the wipers, position 0.
- ▷ Intermittent operation or rain sensor, position 1.

- ▷ Normal wiper speed, position 2.
- ▷ Fast wiper speed, position 3.

When travel is interrupted with the wiper system switched on: when travel continues, the wipers resume at their previous speed.

### Switching off and brief wipe

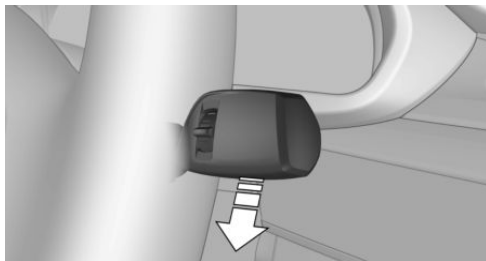

Press the lever down.

- ▷ Switching off: press the lever down until it reaches its standard position.
- ▷ Brief wipe: press the lever down from the standard position.

The lever automatically returns to its initial position when released.

### Interval mode or rain sensor

#### Concept

The rain sensor automatically controls the time between wipes depending on the intensity of the rainfall.

#### General information

The sensor is located on the windshield, directly in front of the interior mirror. Without the rain sensor, the frequency of the wiper operation is preset.

## Safety information

### NOTICE

If the rain sensor is activated, the wipers can accidentally start moving in vehicle washes. There is a risk of damage to property. Deactivate the rain sensor in vehicle washes.

## Activating

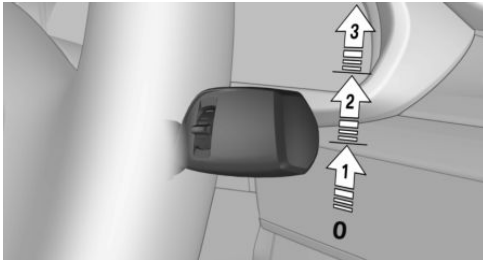

Press the lever up once from its standard position, arrow 1.

Wiping is started.

The LED in the wiper lever is illuminated.

If wipers are frozen to windshield, wiper operation is deactivated.

## Deactivating

Press the lever back into the standard position.

## Setting the frequency or sensitivity of the rain sensor

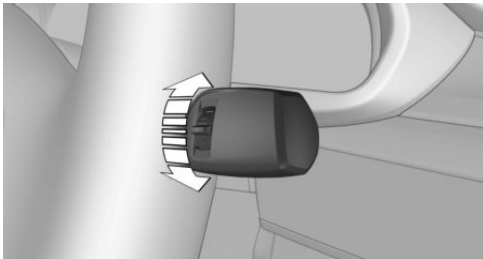

Turn the thumbwheel to adjust the frequency or sensitivity of the rain sensor.

Up: short interval or high sensitivity of the rain sensor.

Down: long interval or low sensitivity of the rain sensor.

## Windshield and headlight washer system

### Safety information

#### WARNING

The washer fluid can freeze onto the window at low temperatures and obstruct the view. There is a risk of an accident. Only use the washer systems, if the washer fluid cannot freeze. Use washer fluid with antifreeze, if needed.

#### NOTICE

When the washer fluid reservoir is empty, the wash pump cannot work as intended. There is a risk of damage to property. Do not use the washer system when the washer fluid reservoir is empty.

## Cleaning the windshield

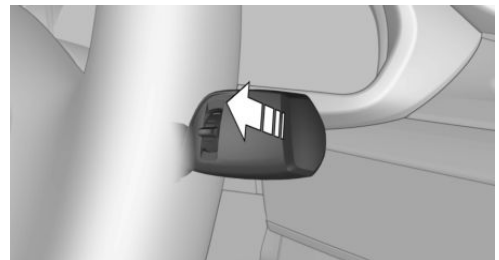

Pull the lever.

The system sprays washer fluid on the windshield and activates the wipers briefly.

In addition, the headlights are cleaned at regular intervals when the vehicle's lights are switched on.

## Windshield washer nozzles

The washer jets are automatically heated whenever the ignition is switched on.

## Rear window wiper

### Overview

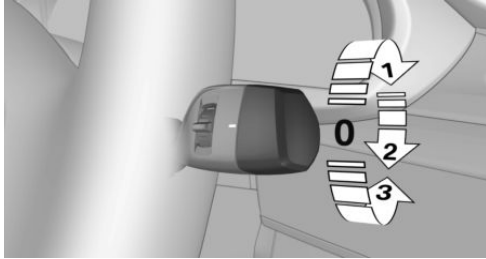

### Switching on

Turn the outer switch upward.

- ▶ Resting position of the wiper, position 0.
- ▶ Intermittent mode, arrow 1. When reverse gear is engaged, the system switches to continuous operation.

### Clean the rear window

Turn the outer switch in the desired direction.

- ▶ In resting position: turn the switch downward, arrow 3. The switch automatically returns to its resting position when released.
- ▶ In intermittent mode: turn the switch further, arrow 2. The switch automatically returns to its intermittent position when released.

## Fold-away position of the wipers

### Concept

The fold-out position enables the wipers to be folded away from the windshield.

## General information

Important, for instance when changing the wiper blades or when folding out under frosty conditions.

## Safety information

### **⚠ WARNING**

If the wipers start moving in the folded away state, body parts can be jammed or damage may occur to parts of the vehicle. There is a risk of injury or risk of damage to property. Make sure that the vehicle is switched off when the wipers are in the folded away state and the wipers are folded in when switching on.

### **⚠ NOTICE**

If the wipers are frozen to the windshield, the wiper blades can be torn off and the wiper motor can overheat when switching on. There is a risk of damage to property. Defrost the windshield prior to switching the wipers on.

## Folding away the wipers

1. Switch the ignition on and off again.
2. Press and hold the wiper level down, until the wipers stop in a close to vertical position.

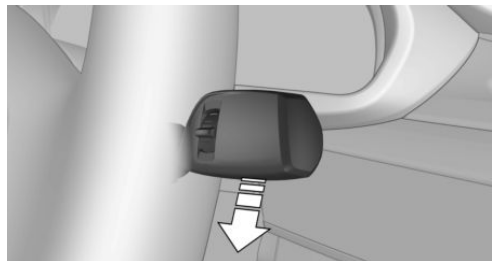



3. Fold the wipers all the way away from the windshield.

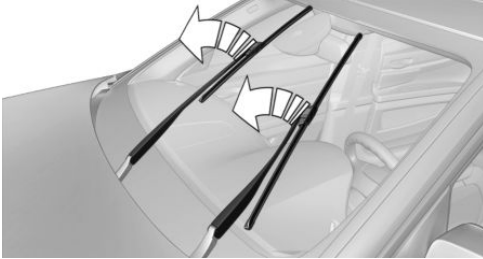

### Folding down the wipers

After the wipers are folded back down, the wiper system must be reactivated.

1. Fold the wipers back down onto the windshield.
2. Switch on the ignition.
3. Push wiper lever down. Wipers return to their resting position and are ready again for operation.

## Canada: wiper system

### General information

Do not use the wipers if the windshield is dry, as this may damage the wiper blades or cause them to become worn more quickly.

### Safety information

#### WARNING

If the wipers start moving in the folded away state, body parts can be jammed or damage may occur to parts of the vehicle. There is a risk of injury or risk of damage to property. Make sure that the vehicle is switched off when the wipers are in the folded away state and the wipers are folded in when switching on.

#### NOTICE

If the wipers are frozen to the windshield, the wiper blades can be torn off and the wiper motor can overheat when switching on. There is a risk of damage to property. Defrost the windshield prior to switching the wipers on.

### Switching on

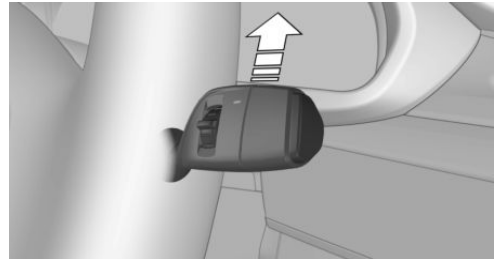

Tap up the lever or press it past the resistance point.

- ▷ Normal wiper speed: tap up once.
- ▷ Fast wiper speed: tap up twice or tap once beyond the resistance point.

The lever automatically returns to its initial position when released.

### Switching off and brief wipe

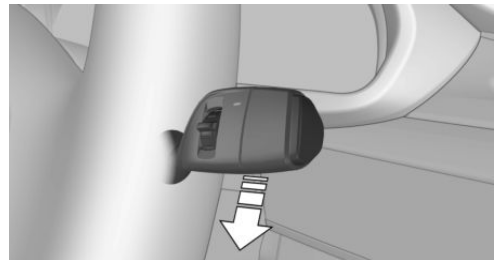

Press the lever down.

- ▷ To switch off from fast wiper speed: press down twice.
- ▷ To switch off from normal wiper speed: press down once.
- ▷ Brief wipe: press down once.

The lever automatically returns to its initial position when released.

## Interval mode or rain sensor

### Concept

The rain sensor automatically controls the time between wipes depending on the intensity of the rainfall.

### General information

The sensor is located on the windshield, directly in front of the interior mirror. Without the rain sensor, the frequency of the wiper operation is preset.

### Safety information

#### NOTICE

If the rain sensor is activated, the wipers can accidentally start moving in vehicle washes. There is a risk of damage to property. Deactivate the rain sensor in vehicle washes.

### Activating/deactivating

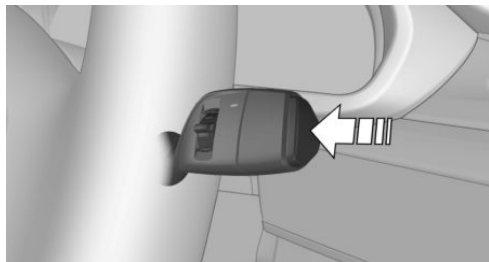

Press the button on the wiper lever.

Wiping is started.

If the vehicle is equipped with a rain sensor: the LED in the wiper lever is illuminated.

If wipers are frozen to windshield, wiper operation is deactivated.

During trip interruption with the rain sensor switched on: if the trip is resumed within approx.

15 minutes, the rain sensor is automatically activated again.

## Setting the frequency or sensitivity of the rain sensor

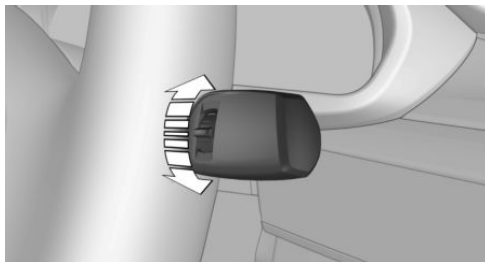

Turn the thumbwheel to adjust the frequency or sensitivity of the rain sensor.

Up: short interval or high sensitivity of the rain sensor.

Down: long interval or low sensitivity of the rain sensor.

## Windshield and headlight washer system

### Safety information

#### WARNING

The washer fluid can freeze onto the window at low temperatures and obstruct the view. There is a risk of an accident. Only use the washer systems, if the washer fluid cannot freeze. Use washer fluid with antifreeze, if needed.

#### NOTICE

When the washer fluid reservoir is empty, the wash pump cannot work as intended. There is a risk of damage to property. Do not use the washer system when the washer fluid reservoir is empty.

## Cleaning the windshield

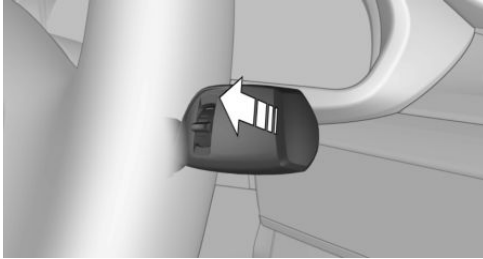

Pull the lever.

The system sprays washer fluid on the windshield and activates the wipers briefly.

In addition, the headlights are cleaned at regular intervals when the vehicle's lights are switched on.

### Windshield washer nozzles

The washer jets are automatically heated whenever the ignition is switched on.

## Rear window wiper

### Overview

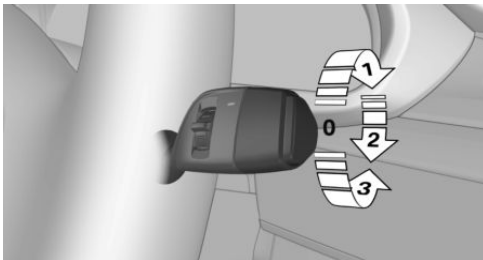

### Switching on

Turn the outer switch upward.

- ▶ Resting position of the wiper, position 0.
- ▶ Intermittent mode, arrow 1. When reverse gear is engaged, the system switches to continuous operation.

## Clean the rear window

Turn the outer switch in the desired direction.

- ▶ In resting position: turn the switch downward, arrow 3. The switch automatically returns to its resting position when released.
- ▶ In intermittent mode: turn the switch further, arrow 2. The switch automatically returns to its intermittent position when released.

## Fold-away position of the wipers

### Concept

The fold-out position enables the wipers to be folded away from the windshield.

### General information

Important, for instance when changing the wiper blades or when folding out under frosty conditions.

### Safety information

#### **WARNING**

If the wipers start moving in the folded away state, body parts can be jammed or damage may occur to parts of the vehicle. There is a risk of injury or risk of damage to property. Make sure that the vehicle is switched off when the wipers are in the folded away state and the wipers are folded in when switching on.

#### **NOTICE**

If the wipers are frozen to the windshield, the wiper blades can be torn off and the wiper motor can overheat when switching on. There is a risk of damage to property. Defrost the windshield prior to switching the wipers on.



## Folding away the wipers

1. Switch the ignition on and off again.
2. With frosty conditions, make sure that the blades are not frozen to the windshield.
3. Press the wiper lever up beyond the point of resistance and hold it for approx. 3 seconds, until the wipers remain in a nearly vertical position.
4. Fold the wipers all the way away from the windshield.

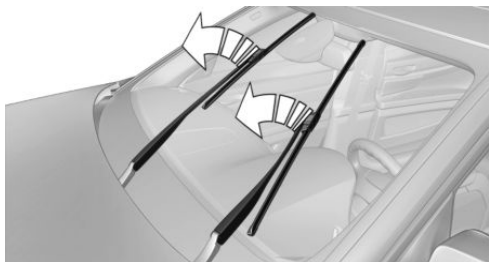

## Folding down the wipers

After the wipers are folded back down, the wiper system must be reactivated.

1. Fold the wipers back down onto the windshield.
2. Switch on the ignition.
3. Push wiper lever down. Wipers return to their resting position and are ready again for operation.

## Washer fluid

### General information

All washer nozzles are supplied from one reservoir.

Use a mixture of tap water and windshield washer concentrate. If desired, a windshield washer concentrate containing antifreeze can be used.

Recommended minimum fill quantity:  
0.2 US gal/1 liter.

## Safety information

### WARNING

Some antifreeze agents can contain harmful substances and are flammable. There is a risk of fire and a risk of injury. Follow the instructions on the containers. Keep antifreeze away from ignition sources. Do not refill operating materials into different bottles. Store operating materials out of reach of children.

United States: the washer fluid mixture ratio is regulated by the U.S. EPA and many individual states; do not exceed the allowable washer fluid dilution ratio limits that apply. Follow the usage instructions on the washer fluid container.

Use of BMW's Windshield Washer Concentrate or the equivalent is recommended.

### WARNING

Washer fluid can ignite and catch fire on contact with hot engine parts. There is a risk of injury or risk of damage to property. Only add washer fluid when the engine is cooled down. Next, fully close the lid of the washer fluid reservoir.

### NOTICE

Silicon-containing additives in the washer fluid for the water-repelling effect on the windows can lead to damage to the washing system. There is a risk of damage to property. Do not add silicon-containing additives to the washer fluid.

### NOTICE

Mixing different windshield washer concentrates or antifreeze can damage the washing system. There is a risk of damage to property. Do not mix different windshield washer concen-

trates or antifreeze. Follow the information and mixing ratios provided on the containers.

## Overview

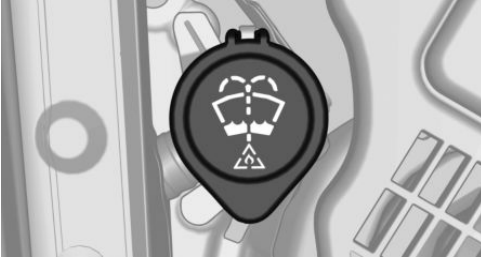

The washer fluid reservoir is located in the engine compartment.

## Malfuction

The use of undiluted windshield washer concentrate or alcohol-based antifreeze can lead to incorrect readings at temperatures below +5 °F/-15 °C.

## Steptronic transmission

### Concept

The Steptronic transmission combines the functions of an automatic transmission with the possibility of manual shifting, if needed.

### Safety information

#### **WARNING**

An unsecured vehicle can begin to move and possibly roll away. There is a risk of an accident. Before exiting, secure the vehicle against rolling.

In order to ensure that the vehicle is secured against rolling away, follow the following:

- ▷ Set the parking brake.

- ▷ On uphill grades or on a downhill slope, turn the front wheels in the direction of the curb.
- ▷ On uphill grades or on a downhill slope, also secure the vehicle, for instance with a wheel chock.

## Selector lever version

### General information

Depending on the vehicle equipment, a transmission with either a latching selector lever or a tap-operated selector lever is installed.

### Transmission with a latching selector lever



The selector lever positions P, R, N, and D are selected by moving the selector lever into the respective selector lever position. The selector lever engages in the selector lever positions.

### Transmission with a tap-operated selector lever



The selector lever positions P, R, N, and D are selected by tapping the selector lever forward or



back. The selector lever automatically returns to the center position when released.

Selector lever position P is engaged automatically, refer to page 120, in certain situations.

## Selector lever positions

### Drive mode D

Selector lever position for normal vehicle operation. All gears for forward travel are activated automatically.

### Reverse R

Engage selector lever position R only when the vehicle is stationary.

### Neutral N

The vehicle may be pushed or roll without power, for instance in vehicle washes, refer to page 122, in selector lever position N.

### Parking position P

#### General information

Selector lever position, for instance for parking the vehicle.

The transmission blocks the drive wheels in selector lever position P.

Engage selector lever position P only when the vehicle is stationary.

Before exiting the vehicle, make sure that selector lever position P is set. Otherwise, the vehicle may begin to move.

#### Automatic parking position for a transmission with a tap-operated selector lever

Selector lever position P is engaged automatically in situations such as the following:

- ▶ After the engine is switched off when the vehicle is in the radio-ready state, refer to page 105, or when the ignition is switched

off, refer to page 105, while selector lever position R, D or M/S is engaged.

- ▶ If the driver's safety belt is unbuckled, the driver's door is opened, and the brake pedal is not pressed while the vehicle is stationary and selector lever position D, M/S or R is engaged.
- ▶ After the ignition has been switched off while selector lever position N is engaged.

## Engaging selector lever positions: with a latching selector lever

### General information

To prevent the vehicle from creeping after you select a drive mode, maintain pressure on the brake pedal until you are ready to start.

### Functional requirements

The selector lever can only be taken out of selector lever position P if the ignition is on or the engine is running.

### Engaging selector lever position D, N, R, or P

With the vehicle stationary, depress the brake pedal before shifting out of selector lever position P or N; otherwise, the shift block will not be deactivated and the shift command will not be executed.

A selector lever lock prevents the following faulty operation:

- ▶ Unintentional shifting into selector lever position P or R.

- ▶ Unintentional shifting from selector lever position P into another selector lever position.
1. To release the selector lever lock: with the brake pedal depressed, press the button on the front of the selector lever.

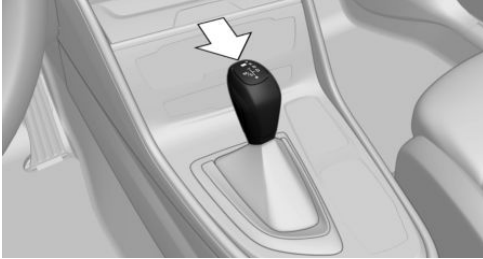

2. Move the selector lever into the desired position.

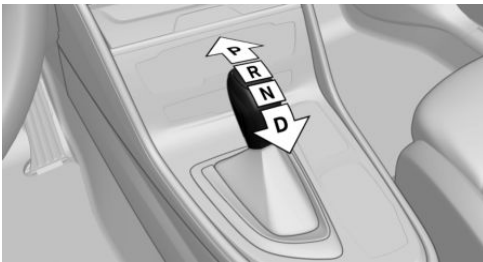

## Engaging selector lever positions: with a tap-operated selector lever

### General information

To prevent the vehicle from creeping after you select a drive mode, maintain pressure on the brake pedal until you are ready to start.

### Functional requirements

Only when the brake pedal is depressed is it possible to change from selector lever position P to another selector lever position.

Depending on the transmission version, the engine may have to be running too.

The selection lever position P cannot be engaged until all technical requirements are met.

## Engaging selector lever position D, N, R

A selector lever lock prevents the following faulty operation:

- ▶ Unintentional shifting into selector lever position R.
  - ▶ Unintentional shifting from selector lever position P into another selector lever position.
1. Fasten driver's safety belt.
  2. Press and hold the button to release the selector lever lock.

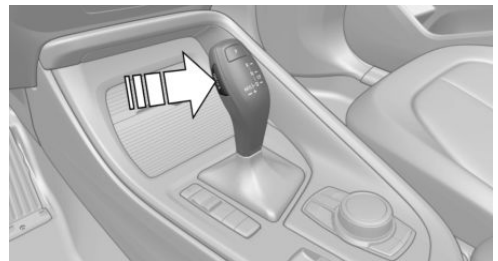

3. Push the selector lever in the desired direction, past a resistance point, if needed. The selector lever automatically returns to the center position when released.





## Engaging selector lever position P

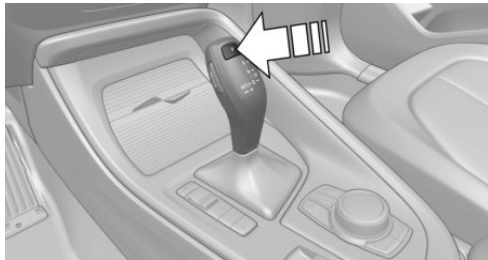

Press button P.

## Rolling or pushing the vehicle

### General information

In some situations, the vehicle is to roll without its own power for a short distance, for instance in a vehicle wash, or be pushed.

### Engaging selector lever position N: with a latching selector lever

1. Switch on the ignition.
2. If necessary, release the parking brake.
3. Depress the brake pedal.
4. Touch the selector lever lock and engage selector lever position N.
5. Release brake.  
The vehicle may roll.

If there is a malfunction, you may not be able to change the selector lever position.

Manually unlock the transmission lock, if needed, refer to page [124](#).

### Engaging selector lever position N: with a tap-operated selector lever

1. Start the engine while pressing on the brake pedal.
2. If necessary, release the parking brake.
3. Depress the brake pedal.

4. Touch the selector lever lock and engage selector lever position N.
5. Switch the engine off.

In this way, the ignition remains switched on, and a Check-Control message is displayed.

The vehicle may roll.

### NOTICE

Selector lever position P is automatically engaged when the ignition is switched off. There is a risk of damage to property. Do not switch ignition off in vehicle washes.

Irrespective of the ignition, the selector lever position P is automatically engaged after approx. 15 minutes.

If there is a malfunction, you may not be able to change the selector lever position.

Electronically unlock the transmission lock, if needed, refer to page [125](#).

## Kickdown

Kickdown is used to achieve maximum driving performance.

Step on the accelerator pedal beyond the resistance point at the full throttle position.

## Sport program M/S

### Concept

The shifting points and shifting times in the Sport program are designed for a sportier driving style. The transmission, for instance shifts up later and the shifting times are shorter.

## Activating the sport program

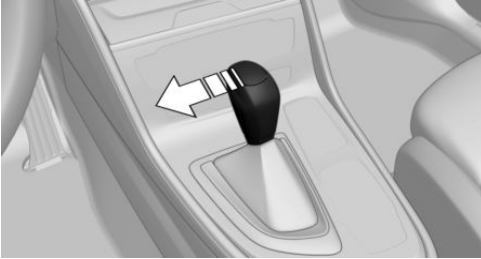

Press the selector lever to the left out of selector lever position D.

The engaged gear is displayed in the instrument cluster, for instance S1.

The sport program of the transmission is activated.

## Ending the Sport program

Push the selector lever to the right.

D is displayed in the instrument cluster.

## Manual mode M/S

### Concept

Manual gear-shifting is possible in manual mode.

### Activating manual mode

1. Press the selector lever to the left out of selector lever position D, arrow 1.

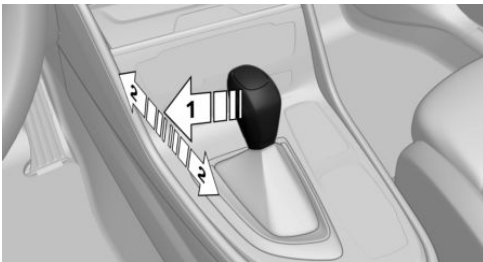

2. Push the selector lever forward or pull it backward, arrows 2.

Manual mode becomes active and the gear is changed.

The engaged gear is displayed in the instrument cluster, for instance M1.

### Shifting

- ▷ To shift down: press the selector lever forward.
- ▷ To shift up: pull the selector lever rearwards.

The transmission continues shifting automatically in certain situations, for instance when speed limits are reached.

With a tap-operated selector lever: when M2 is set manually while the vehicle is stationary, the transmission will no longer shift back to M1. This shifting behavior is retained until you engage M1 manually or exit M.

### Steptronic Sport transmission: prevent automatic upshifting in M/S manual mode

The Steptronic Sport transmission does not automatically upshift in M/S manual mode once the maximum speed is reached, if one of the following conditions is met:

- ▷ DSC Dynamic Stability Control deactivated.
- ▷ Dynamic Traction Control DTC activated.

In addition, there is no downshifting for kick-down.

With the appropriate transmission version, the lowest possible gear can be selected by simultaneously activating kickdown and operating the left shift paddles. This is not possible by switching briefly via the shift paddles from selector lever position D to manual mode M/S.

### Ending the manual mode

Push the selector lever to the right.

D is displayed in the instrument cluster.

## Shift paddles

### Concept

The shift paddles on the steering wheel allow you to shift gears quickly while keeping both hands on the steering wheel.

### General information

#### Shifting

The vehicle only shifts at suitable engine and road speeds.

#### Short-term manual mode

In selector lever position D, actuating a shift paddle switches into manual mode temporarily.

After conservative driving in manual mode without acceleration or shifting via the shift paddles for a certain amount of time, the transmission switches back to automatic mode.

It is possible to switch into automatic mode as follows:

- ▷ Pull and hold right shift paddle.
- ▷ In addition to the briefly pulled right shift paddle, briefly pull the left shift paddle.

#### Continuous manual mode

In selector lever position S, actuating a shift paddle switches into manual mode permanently.

### Shifting



- ▷ To shift up: briefly pull right shift paddle.
- ▷ To shift down: briefly pull left shift paddle.

- ▷ The lowest possible gear can be selected by pulling and holding the left shift paddle.

The selected gear is briefly displayed in the instrument cluster, followed by the current gear.

## Displays in the instrument cluster

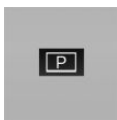

The selector lever position is displayed, for example P.

## Releasing the transmission lock manually: with a latching selector lever

If the selector lever is locked in selector lever position P despite the ignition being switched on, the brake pedal being depressed and the button on the selector lever being pressed, the transmission lock can be unlocked manually:

Before unlocking the transmission lock manually, set the parking brake to prevent the vehicle from rolling away.

1. Loosen the selector lever sleeve at the bottom from the center console.



2. Lift the sleeve. Unplug the cable connector, if needed.

- Using the screwdriver from the onboard vehicle tool kit, refer to page 273, press the yellow release lever downward, arrow.

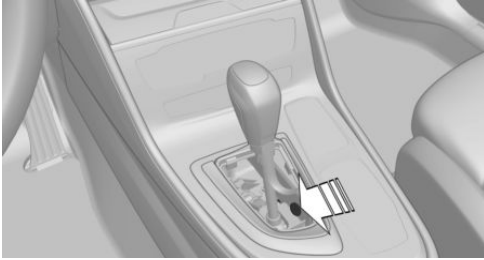

- Press the button on the front of the selector lever and move the selector lever back slightly.  
Release the release lever.
- Bring the selector lever into the desired position.

For additional information, see the chapter on tow-starting and towing.

## Releasing the transmission lock electronically: with a tap-operated selector lever

### General information

Electronically unlock the transmission lock to maneuver vehicle from a danger area.

Before unlocking the transmission lock, set the parking brake to prevent the vehicle from rolling away.

### Engaging selector lever position N

Unlocking is possible, if the starter can spin the engine.

- Press and hold down brake pedal.
- Press the Start/Stop button. The starter must audibly start.
- Press the button on the selector lever, arrow 1, and press and hold the selector lever into selector lever position N, arrow N, until

selector lever position N is displayed in the instrument cluster.

A Check Control message is displayed.

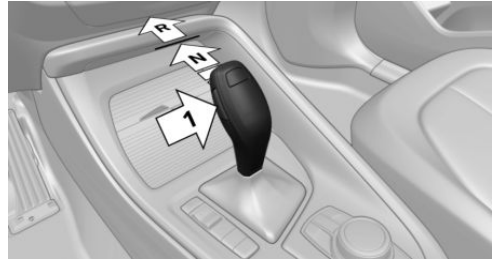

- Release the selector lever.
- Release brake, as soon as the starter stops.
- Maneuver the vehicle from the danger area and secure it against moving on its own.

For additional information, see the chapter on tow-starting and towing.

## Steptronic Sport transmission: Launch Control

### Concept

Launch Control enables optimum acceleration on surfaces with good traction under dry surrounding conditions.

### General information

The use of Launch Control causes premature component wear since this function represents a very heavy load for the vehicle.

Do not use Launch Control during the break-in, refer to page 224, period.

To start with Launch Control, point the front wheels straight forwards.

### Functional requirements

Launch Control is available as soon as the engine and transmission are at operating temperature.

Depending on the external temperature and driving style, the engine and transmission require an interrupted trip of up to 30 miles/50 km in order

to reach the operating temperature needed for Launch Control.

## Start with launch control

While the engine is running:

1.  Press the button and select SPORT with the Driving Dynamics Control. TRACTION is displayed in the instrument cluster in combination with SPORT and the DSC OFF indicator light lights up.
2. Engage selector lever position S.
3. With the left foot, forcefully press down on the brake.
4. Press and hold down the accelerator pedal beyond the resistance point at the full throttle position, kickdown.  
A flag symbol is displayed in the instrument cluster.
5. The starting engine speed adjusts. Within 3 seconds, release the brake.

## Repeated use during a trip

After Launch Control has been used, the transmission must cool down for approx. 5 minutes before Launch Control can be used again.

## After using Launch Control

To increase vehicle stability, activate DSC Dynamic Stability Control again.

## System limits

An experienced driver may be able to achieve better acceleration values in DSC OFF mode.

# Displays

## Vehicle features and options

This chapter describes all standard, country-specific and optional features offered with the series.

It also describes features that are not necessarily available in your vehicle, e. g., due to the selected options or country versions. This also applies to safety-related functions and systems. When using these functions and systems, the applicable laws and regulations must be observed.

## Overview, instrument cluster

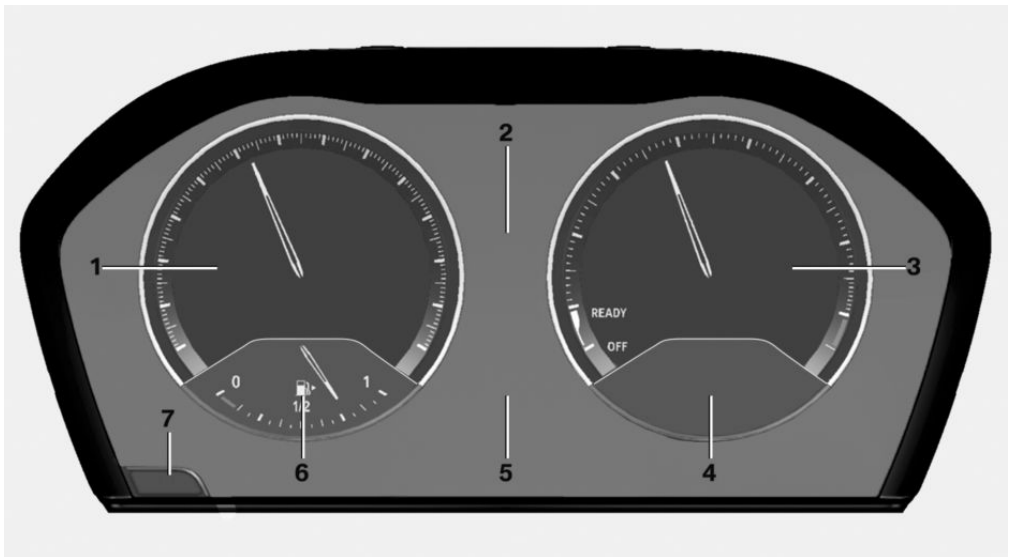

- 1 Speedometer
- 2 Messages, for instance Check Control
- 3 Tachometer [131](#)
- 4 Current consumption

- Driving dynamics systems
- 5 Electronic displays
- 6 Fuel gage [131](#)
- 7 Reset miles [131](#)

## Check Control

### Concept

The Check Control system monitors functions in the vehicle and notifies you of malfunctions in the monitored systems.

## General information

A Check Control message is displayed as a combination of indicator or warning lights and SMS text messages in the instrument cluster and in the Head-up Display.

In addition, an acoustic signal may sound and an SMS text message may appear on the Control Display.

## Indicator/warning lights

### General information

The indicator/warning lights in the instrument cluster can light up in a variety of combinations and colors.

Several of the lights are checked for proper functioning and light up temporarily when the engine is started or the ignition is switched on.

### Red lights

#### Safety belt reminder



Safety belt on the driver's side is not buckled. For some country versions: passenger belt is not worn or objects are detected on the front passenger seat.

Indicator light flashes or is illuminated: safety belt on the driver or passenger side is not buckled. The safety belt reminder can also be activated if objects are placed on the front passenger seat. Make sure that the safety belts are positioned correctly.

#### Airbag system



Airbag system and belt tensioner are not working. Have the vehicle checked immediately by a dealer's service center or another qualified service center or repair shop.

#### Parking brake



The parking brake is set. Release the parking brake, refer to page 110.

#### Brake system



Braking system impaired. Continue to drive moderately.

**BRAKE**

Have the vehicle checked immediately by a dealer's service center or another qualified service center or repair shop.

#### Approach control warning



Indicator light illuminates: advance warning is issued, for example when there is the impending danger of a collision or the distance to the vehicle ahead is too small. Increase distance.

Indicator light flashes: acute warning of the imminent danger of a collision when the vehicle approaches another vehicle at a relatively high differential speed.

Intervention by braking or make an evasive maneuver.

#### Person warning



Symbol in the instrument cluster. If a collision with a person detected in this way is imminent, the symbol lights up and a signal sounds.

### Orange lights

#### Active Cruise Control



The number bars shows the selected distance from the vehicle driving ahead. Camera-based cruise control with Stop&Go function, ACC, refer to page 175.

#### Vehicle detection, Active Cruise Control



Indicator light illuminates: a vehicle has been detected ahead of you. Indicator light flashes: the conditions are not adequate for the system to work.



The system was deactivated but applies the brakes until you actively resume control by pressing on the brake pedal or accelerator pedal.

## Yellow lights

### Anti-lock Braking System ABS



Braking force boost may not be working. Avoid abrupt braking. Take the longer braking distance into account.

**ABS** Have the system immediately checked by a dealer's service center or another qualified service center or repair shop.

### DSC Dynamic Stability Control



The indicator light flashes: DSC controls the drive and braking forces. The vehicle is stabilized. Reduce speed and modify your driving style to the driving circumstances.

The indicator light lights up: DSC has malfunctioned.

Have the system checked by a dealer's service center or another qualified service center or repair shop.

DSC, refer to page [169](#).

### DSC Dynamic Stability Control is deactivated or DTC Dynamic Traction Control is activated



DSC is deactivated or DTC is activated.

DSC, refer to page [169](#), and DTC, refer to page [171](#).

### Flat Tire Monitor FTM



The Flat Tire Monitor signals a loss of tire inflation pressure in a tire.

Reduce your speed and stop cautiously. Avoid sudden braking and steering maneuvers.

Flat Tire Monitor, refer to page [156](#).

### Tire Pressure Monitor TPM



The indicator light lights up: the Tire Pressure Monitor reports a low tire inflation pressure or a flat tire. Follow the information in the Check Control message.

The indicator light flashes and then continuously lights up: no flat tire or loss of tire inflation pressure can be detected.

- ▶ Interference caused by systems or devices with the same radio frequency: after leaving the area of the interference, the system automatically becomes active again.
- ▶ TPM was unable to complete the reset. Reset the system again.
- ▶ A wheel without TPM wheel electronics is mounted: have it checked by a dealer's service center or another qualified service center or repair shop as needed.
- ▶ Malfunction: have the system checked by a dealer's service center or another qualified service center or repair shop.

Tire Pressure Monitor, refer to page [151](#).

### Steering system



Steering system in some cases not working.

Have the system checked by a dealer's service center or another qualified service center or repair shop.

### Emissions



▶ The warning light lights up:

Emissions are deteriorating. Have the vehicle checked as soon as possible.

- ▶ The warning light flashes under certain circumstances:

This indicates that there is excessive misfiring in the engine.

Reduce the vehicle speed and have the system checked immediately; otherwise, serious engine misfiring within a brief period can seri-

ously damage emission control components, in particular the catalytic converter.

Socket for Onboard Diagnosis, refer to page [272](#).

**Lane departure warning**

 System is switched on and under certain circumstances warns if a detected lane is left without flashing beforehand.

Lane departure warning, refer to page [165](#).

**Green lights**

**Turn signal**

 Turn signal switched on.  
Unusually rapid flashing of the indicator light indicates that a turn signal bulb has failed.

Turn signal, refer to page [111](#).

**Parking lights, headlight**

 Parking lights or headlights are switched on.

Parking lights/low beams, headlight control, refer to page [143](#).

**Front fog lights**

 Front fog lights are switched on.  
Front fog lights, refer to page [146](#).

**High-beam Assistant**

 High-beam Assistant is switched on.  
High beams are switched on and off automatically depending on the traffic situation.

High-beam Assistant, refer to page [145](#).

**Cruise control**

 The system is switched on. It maintains the speed that was set using the control elements on the steering wheel.

**Blue lights**

**High beams**

 High beams are switched on.  
High beams, refer to page [111](#).

**Hiding Check Control messages**

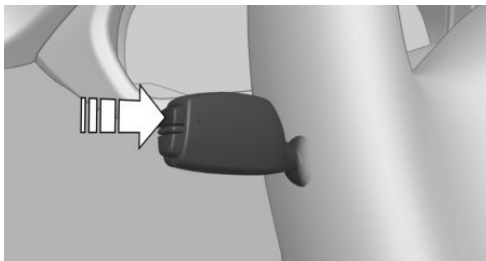

Press and hold the button on the turn signal lever.

**Continuous display**

Some Check Control messages are displayed continuously and are not cleared until the malfunction is eliminated. If several malfunctions occur at once, the messages are displayed consecutively.

The messages can be hidden for approx. 8 seconds. After this time, they are displayed again automatically.

**Temporary display**

Some Check Control messages are hidden automatically after approx. 20 seconds. The Check Control messages are stored and can be displayed again later.



## Displaying stored Check Control messages

Via iDrive:

1. "My Vehicle"
2. "Vehicle status"
3.  "Check Control"
4. Select the SMS text message.

## Display

### Check Control



At least one Check Control message is displayed or is stored.

### SMS text messages

SMS text messages in combination with a symbol in the instrument cluster explain a Check Control message and the meaning of the indicator/warning lights.

### Supplementary SMS text messages

Additional information, such as on the cause of an error or the required action, can be called up via Check Control.

With urgent messages the added text will be automatically displayed on the Control Display.

Depending on the Check Control message, the following functions can be selected.

- ▷ "Owner's Manual"  
Display additional information about the Check Control message in the Integrated Owner's Manual.
- ▷ "Service request"  
Contact a dealer's service center or another qualified service center or repair shop.
- ▷ "BMW Roadside Assistance"  
Contact Roadside Assistance.

## Messages after trip completion

Special messages displayed while driving are displayed again after the ignition is switched off.

## Fuel gage



An arrow beside the fuel pump symbol shows which side of the vehicle the fuel filler flap is on.

Vehicle tilt position may cause the display to vary.

Follow the information on refueling.



The yellow indicator light illuminates, once the fuel reserve is reached.

## Tachometer

Always avoid engine speeds in the red warning field. In this range, the fuel supply is reduced to protect the engine.

## Odometer and trip odometer

### Display

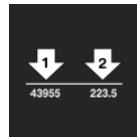

- ▷ Odometer, arrow 1.
- ▷ Trip odometer, arrow 2.

### Show/reset miles



Press the button.

- ▷ When the ignition is switched off, the time, the external temperature and the odometer are displayed.

- ▶ When the ignition is switched on, the trip odometer is reset.

## External temperature

### General information

If the indicator drops to +37 °F/+3 °C or lower, a signal sounds.

A Check Control message is displayed.

There is an increased risk of ice on roads.

### Safety information

#### WARNING

Even at temperatures above +37 °F/+3 °C there can be a risk of icy roads, for instance on bridges or shady sections of road. There is a risk of an accident. Modify your driving style to the weather conditions at low temperatures.

### Display



+74.0 °F

The external temperature is displayed in the instrument cluster.

### Time



11:35

The time is displayed in the instrument cluster.

The time can be set on the Control Display.

### Date



13/12/23

The date is displayed in the instrument cluster.

The date can be set on the Control Display.

### Range

#### General information

With a low remaining range:

- ▶ A Check Control message is displayed briefly.
- ▶ The remaining range is shown on the On-board Computer.
- ▶ With a dynamic driving style, for instance taking curves aggressively, the engine function is not always ensured.

The Check Control message appears continuously below a range of approx. 30 miles/50 km.

### Safety information

#### NOTICE

With a driving range of less than 30 miles/50 km the engine may no longer have sufficient fuel. Engine functions are not ensured anymore. There is a risk of damage to property. Refuel promptly.

### Display



79 mi

The current range is displayed in the instrument cluster.



## Current consumption

### Instrument cluster



Displays the current fuel consumption. Check whether you are currently driving in an efficient and environmentally-friendly manner.

### Instrument cluster with enhanced features

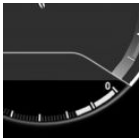

Displays the current fuel consumption. Check whether you are currently driving in an efficient and environmentally-friendly manner.

### Displaying the current consumption

Depending on your vehicle's optional features, the current consumption can also be displayed as bar in the instrument cluster.

Via iDrive:

1. "My Vehicle"
2. "iDrive settings"
3. "Displays"
4. "Instrument panel"
5. "Additional indicators"

## Energy recovery

### Display



In coasting overrun mode the kinetic energy of the vehicle is converted to electrical energy. The vehicle battery is partially charged and fuel consumption can be reduced.

## Service requirements

### Concept

The function displays the service requirements and the corresponding maintenance scopes.

### General information

After the ignition is switched on the instrument cluster briefly displays available driving distance or time to the next scheduled maintenance.

A service advisor can read out the current service requirements from your remote control.

### Display



#### Detailed information on service requirements

More information on the type of service required may be displayed on the Control Display.

Via iDrive:

1. "My Vehicle"
2. "Vehicle status"
3.  "Service required"  
Required maintenance procedures and legally mandated inspections are displayed.
4. Select an entry to call up detailed information.

### Symbols

Symbols	Description
	No service is currently required.
	The deadline for scheduled maintenance or a legally mandated inspection is approaching.
	The service deadline has already passed.

## Entering appointment dates

Enter the dates for the mandatory vehicle inspections.

Make sure that the vehicle's date and time are set correctly.

Via iDrive:

1. "My Vehicle"
2. "Vehicle status"
3.  "Service required"
4. "Vehicle inspection"
5. "Date:"
6. Select the desired setting.

## Automatic Service Request

Data regarding the service status or legally mandated vehicle inspections is automatically transmitted to your dealer's service center before your vehicle is due for service.

You can check when your dealer's service center was notified.

Via iDrive:

1. "My Vehicle"
2. "Vehicle status"
3.  "Teleservice Call"

## Gear shift indicator

### Concept

The system recommends the most efficient gear for the current driving situation.



### General information

Depending on the vehicle equipment and country version, the gear shift indicator is active in the manual mode of the Steptronic transmission and with manual transmission.

Suggestions to shift gear up or down are displayed in the instrument cluster.

On vehicles without a gear shift indicator, the engaged gear is displayed.

## Steptronic transmission: displaying

Example	Description
	Efficient gear is set.
	Shift into efficient gear.

## Speed Limit Info

### Speed Limit Info

#### Concept

Speed Limit Info shows the current maximum permitted speed in the instrument cluster.

#### General information

The camera in the area of the interior mirror detects traffic signs at the edge of the road as well as variable overhead sign posts. Traffic signs with extra symbols for wet road conditions, etc., are also detected and compared with the vehicle's onboard data, such as from the rain sensor, and will be displayed depending on the situation.

With the navigation system, the system takes into account the information stored in the navigation data and also displays speed limits present on routes without signs.

Without a navigation system, the system is subject to limitations imposed by technology. Traffic signs with speed limitations are detected and displayed only. Speed limitations due to entering or exiting towns, highway signs, etc. are not displayed. Speed limits with extra text characters are always displayed.

## Safety information

### WARNING

The system cannot serve as a substitute for the driver's personal judgment in assessing visibility and traffic situation. There is a risk of an accident. Adjust driving style to traffic conditions. Watch traffic closely and actively intervene where appropriate.

## Overview

### Camera

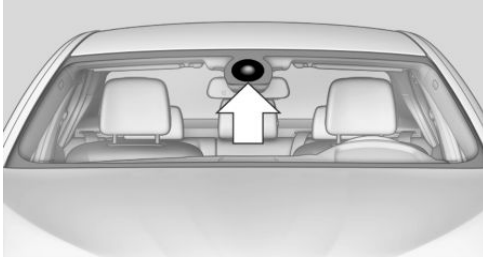

The camera is installed near the interior mirror. Keep the windshield in front of the interior mirror clean and clear.

## Display

### General information

Speed Limit Info is permanently displayed in the instrument cluster.

### Speed Limit Info



The last speed limit detected. Without a navigation system the traffic signals are grayed out after curves or longer stretches of roadway.



With navigation system:  
Speed Limit Info not available.

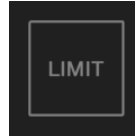

Without navigation system:  
No speed limit or cancellation detected.

Speed Limit Info can also be displayed in the Head-up Display.

## System limits

The system may not be fully functional and may provide incorrect information in the following situations:

- ▷ In heavy fog, rain or snowfall.
- ▷ When signs are fully or partially concealed by objects, stickers or paint.
- ▷ When driving very close to the vehicle in front of you.
- ▷ When driving toward bright lights or strong reflections.
- ▷ When the windshield in front of the interior mirror is fogged over, dirty or covered by a sticker, etc.
- ▷ In the event of incorrect detection by the camera.
- ▷ If the speed limits stored in the navigation system are incorrect.
- ▷ In areas not covered by the navigation system.
- ▷ When roads differ from the navigation, such as due to changes in road routing.
- ▷ When passing buses or trucks with a speed sticker.
- ▷ If the traffic signs are non-conforming.
- ▷ During calibration of the camera immediately after vehicle delivery.
- ▷ When signs that are valid for a parallel road are detected.



## Selection lists

### General information

Depending on your vehicle's equipment, the following can be displayed or operated using the buttons and the thumbwheel on the steering wheel as well as the displays in the instrument cluster and the Head-up Display:

- ▷ Current audio source.
- ▷ Redial phone feature.
- ▷ Turn on voice activation system.

### Activating a list and adjusting the setting

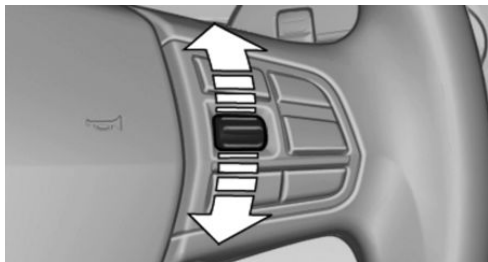

On the right side of the steering wheel, turn the thumbwheel to activate the corresponding list.

1. Turn the thumbwheel and select the desired setting.
2. Press the thumbwheel.

### Display

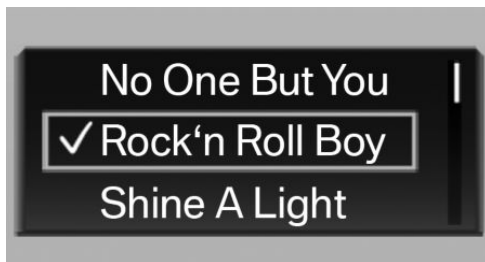

Depending on the equipment version, the list in the instrument cluster may differ from the illustration.

## Onboard Computer

### Concept

The Onboard Computer displays different vehicle data in the instrument cluster, such as average values.

### Calling up information on the Info Display

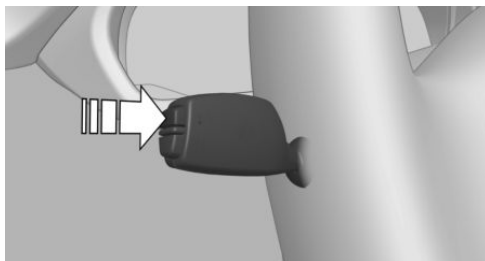

Press and hold the button on the turn signal lever.

Information is displayed in the Info Display of the instrument cluster. Pressing the button repeatedly displays additional information.

## Information at a glance

Repeatedly pressing the button on the turn signal lever calls up the following information in the Info Display:

- ▷ Range.
- ▷ Average consumption, fuel.
- ▷ Average consumption since delivery from the factory.
- ▷ Current consumption, fuel.
- ▷ Average speed.
- ▷ Date.
- ▷ Engine temperature display.
- ▷ Speed.
- ▷ Depending on the equipment, the time of arrival.

When destination guidance is activated in the navigation system.

- ▷ Depending on the equipment, the distance to destination.

When destination guidance is activated in the navigation system.

- ▷ ECO PRO bonus range.

## Selecting information

You can select what information from the On-board Computer is to be displayed on the Info Display of the instrument cluster.

Via iDrive:

1. "My Vehicle"
2. "iDrive settings"
3. "Displays"
4. "Instrument panel"
5. Select the desired setting.

## Indication in the Info Display

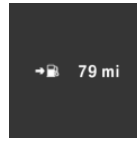

The information from the On-board Computer is shown in the Info Display in the instrument cluster.

## Information in detail

### Range

Displays the estimated cruising range available with the remaining fuel.

The range is calculated based on your driving style over the last 20 miles/30 km.

### Average consumption

The average consumption is calculated for the period while the engine is running.

The average consumption is calculated for the distance traveled since the last reset by the On-board Computer.

### Average speed

Periods in which the vehicle is parked with the engine manually stopped are not included in the calculation of the average speed.

## Resetting average values

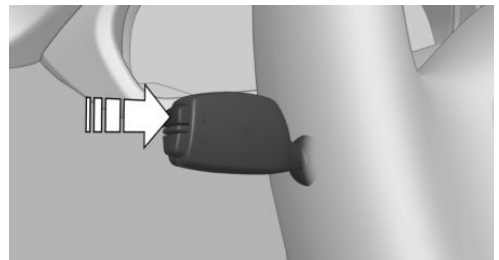

Press and hold the button on the turn signal lever.

The average consumption since delivery from the factory cannot be reset.

## Engine temperature display

### Concept

Depending on the vehicle equipment, the current engine temperature is displayed, based on a combination of the coolant temperature and engine oil temperature. As soon as the optimum operating temperature has been attained, the indicator is in the center position.

### General information

If the engine oil or coolant, and thus the engine, become too hot, a Check Control message is displayed too.

Check the coolant level, refer to page 269.

### Display



## Distance to destination

Depending on the vehicle equipment, the distance remaining to the destination is displayed if a destination is entered in the navigation system before the trip is started.

The distance to the destination is adopted automatically.

## Time of arrival

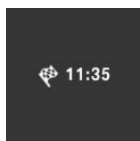

Depending on the vehicle equipment, the estimated time of arrival is displayed if a destination is entered in the navigation system before the trip is started.

The time must be correctly set.

## Onboard Computer on the Control Display

### Concept

The Onboard Computer displays different vehicle data on the Control Display, such as average values.

### General information

Two types of Onboard Computers are available on the Control Display:

- ▷ "Onboard info": average values, such as the consumption, are displayed. The values can be reset individually.
- ▷ "Trip computer": the values deliver an overview of a certain distance and can be reset as often as necessary.

## Calling up the Onboard Computer or trip computer

Via iDrive:

1. "My Vehicle"
2. "Driving information"
3. "Onboard info" or "Trip computer"

## Resetting the Onboard Computer



Via iDrive:

1. "My Vehicle"
2. "Driving information"
3. "Onboard info"
4. "Consumption" or "Speed"
5. "OK"

## Resetting the trip computer

Via iDrive:

1. "My Vehicle"
2. "Driving information"
3. "Trip computer"
4. Move the Controller to the left, if needed.

- ▶  "Reset": all values are reset.
  - ▶  "Automatic reset": all values are reset approx. 4 hours after the vehicle has come to a standstill.
5. If necessary, "OK"

## Sport displays

---

### Concept

On the Control Display, sport instruments can be displayed, and the vehicle state can be checked before the use of the SPORT program.

### Sport instruments

#### General information

On the Control Display, values for power and torque are displayed.

#### Displaying sport instruments

Via iDrive:

1. "My Vehicle"
2. "Technology in action"
3.  "Sports instruments"

Via the Driving Dynamics Control

1. Activate SPORT.
2. "Sport displays"

### Vehicle state

#### General information

The following vehicle and environment data is evaluated:

- ▶ Engine temperature.
- ▶ External temperature.
- ▶ Tire temperature and tire inflation pressure.

Tire temperature and tire filling pressure are determined while driving.

### Checking vehicle state

Via iDrive:

1. "My Vehicle"
2. "Technology in action"
3.  "Vehicle and surroundings"

Via the Driving Dynamics Control

1. Activate SPORT.
2. "Sport displays"

## Speed warning

---

### Concept

A speed limit can be set that when reached will cause a warning to be issued.

#### General information

The warning is repeated if the vehicle speed exceeds the set speed limit again, after it has dropped below it by 3 mph/5 km/h.

### Configuring the speed limit warning

Via iDrive:

1. "My Vehicle"
2. "Vehicle settings"
3. "Speed warning"
4. "Warning at:"
5. Turn the Controller until the desired speed is displayed.
6. Press the Controller.

### Activating/deactivating the speed warning

Via iDrive:

1. "My Vehicle"
2. "Vehicle settings"

3. "Speed warning"
4. "Speed warning"

## Setting your current speed as the speed warning

Via iDrive:

1. "My Vehicle"
2. "Vehicle settings"
3. "Speed warning"
4. "Select current speed"

## Head-up Display

### Concept

This system projects important information into the driver's field of vision, for instance the speed.

The driver can quickly absorb information and concentrate on the traffic situation.

### Overview

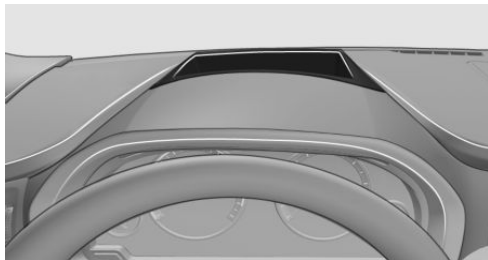

### Switching on/off

Via iDrive:

1. "My Vehicle"
2. "iDrive settings"
3. "Displays"
4. "Head-Up Display"
5. "Head-Up Display"

## Display

### Overview

The following information is displayed on the Head-up Display:

- ▷ Speed.
- ▷ Navigation instructions.
- ▷ Check Control messages.
- ▷ Selection list from the instrument cluster.
- ▷ Driver assistance systems.

Some of this information is only displayed briefly as needed.

### Selecting displays in the Head-up Display

Via iDrive:

1. "My Vehicle"
  2. "iDrive settings"
  3. "Displays"
  4. "Head-Up Display"
  5. "Displayed information"
  6. Select the desired setting.
- Settings are stored for the profile currently used.

### Setting the brightness

The brightness is automatically adjusted to the ambient brightness.

The basic setting can be adjusted manually.

Via iDrive:

1. "My Vehicle"
2. "iDrive settings"
3. "Displays"
4. "Head-Up Display"
5. "Brightness"
6. Turn the Controller until the desired brightness is set.
7. Press the Controller.

When the low beams are switched on, the brightness of the Head-up Display can be additionally influenced using the instrument lighting. Settings are stored for the profile currently used.

## Adjusting the height

Via iDrive:

1. "My Vehicle"
2. "iDrive settings"
3. "Displays"
4. "Head-Up Display"
5. "Height"
6. Turn the Controller until the desired height is reached.
7. Press the Controller.

Settings are stored for the profile currently used.

The height of the Head-up Display can also be stored using the memory function, refer to page [96](#).

## Setting the rotation

The screen of the Head-up Display can be rotated around its own axis.

Via iDrive:

1. "My Vehicle"
2. "iDrive settings"
3. "Displays"
4. "Head-Up Display"
5. "Rotation"
6. Turn the Controller until the desired setting is selected.
7. Press the Controller.

Settings are stored for the profile currently used.

## Display visibility

The visibility of the displays in the Head-up Display is influenced by the following factors:

- ▷ Seat position.
- ▷ Objects on the cover of the Head-up Display.

- ▷ Sunglasses with certain polarization filters.
- ▷ Wet roads.
- ▷ Unfavorable light conditions.

If the image is distorted, have the basic settings checked by a dealer's service center or another qualified service center or repair shop.

Follow the instructions for cleaning the Head-up Display, refer to page [293](#).

## Special windshield

The windshield is part of the system.

The shape of the windshield makes it possible to display a precise image.

A film in the windshield prevents double images from being displayed.

For this reason, it is strongly suggested to have the special windshield replaced by a dealer's service center or another qualified service center or repair shop, if necessary.

## Vehicle status

### General information





The status can be displayed and actions performed for several systems.

### Opening the vehicle status

Via iDrive:



1. "My Vehicle"
2. "Vehicle status"

### Information at a glance

- ▷  "Flat Tire Monitor": status of the Flat Tire Monitor, refer to page [156](#).
- ▷  "Tire Pressure Monitor": status of the Tire Pressure Monitor, refer to page [151](#).
- ▷  "Engine oil level": Electronic engine oil level check, refer to page [265](#).
- ▷  "Check Control": Check Control messages are stored in the background and can



be displayed on the Control Display. Displaying stored Check Control messages, refer to page [131](#).

- ▷  "Service required": Displaying service requirements, refer to page [133](#).
- ▷  "Teleservice Call": service request.

# Lights

## Vehicle features and options



This chapter describes all standard, country-specific and optional features offered with the series. It also describes features that are not necessarily available in your vehicle, e. g., due to the selected options or country versions. This also applies to safety-related functions and systems. When using these functions and systems, the applicable laws and regulations must be observed.



## Overview

### Switches in the vehicle



The light switch element is located next to the steering wheel.

Symbol	Function
	Front fog light.
	Automatic headlight control. Cornering light.
	Lights off. Daytime running lights.

Symbol	Function
	Parking lights.
	Low beams.
	Instrument lighting.

## Parking lights, low beams and roadside parking lights

### General information

Position of switch:  ,  , 

If the driver's door is opened when the ignition is switched off, the exterior lighting is automatically switched off.

### Parking lights

Position of switch: 

The vehicle is illuminated on all sides.

Do not use the parking lights for extended periods; otherwise, they might drain the battery and it would then be impossible to start the engine.

Canada: when parking, switch on the one-sided roadside parking light, refer to page [144](#).

### Low beams

Position of switch: 

The low beams light up when the ignition is switched on.



## Canada: roadside parking light

### Concept

The vehicle can be illuminated on one side.

### Switching on

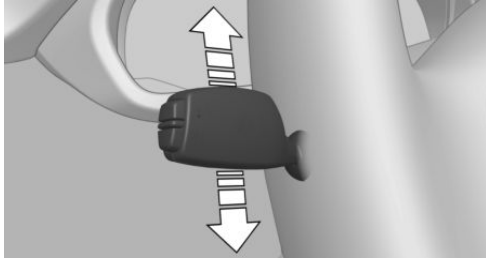

With radio-ready state switched off, press the lever either up or down past the resistance point for approx. 2 seconds.

### Switching off

Briefly press the lever to the resistance point in the opposite direction.

## Welcome lights and headlight courtesy delay feature

### Welcome lights

#### General information

Depending on the vehicle equipment and the ambient brightness, individual light functions may be switched on briefly when the vehicle is unlocked.

#### Activating/deactivating

Position of switch: ,

Via iDrive:

1. "My Vehicle"
2. "Vehicle settings"

3. "Lighting"
4. "Exterior lighting"
5. "Welcome lights"

The setting is stored for the driver profile currently used.

## Headlight courtesy delay feature

### General information

The low beams stay lit for a short while if the headlight flasher is switched on after the radio-ready state is switched off.

### Setting the duration

Via iDrive:

1. "My Vehicle"
2. "Vehicle settings"
3. "Lighting"
4. "Exterior lighting"
5. "Pathway lighting"
6. Set length of time.

The setting is stored for the driver profile currently used.

## Automatic headlight control

### Concept

The low beams are switched on and off automatically depending on the ambient brightness, for instance in tunnels, in twilight or if there is precipitation.

### General information

A blue sky with the sun low on the horizon can cause the lights to be switched on.

The low beams always stay on when the fog light is switched on.

## Activating

Position of switch: 

The indicator light in the instrument cluster is illuminated when the low beams are switched on.



## System limits

The automatic headlight control cannot serve as a substitute for your personal judgment of lighting conditions.

For example, the sensors are unable to detect fog or hazy weather. In these situations, switch the light on manually.

## Daytime running lights

### General information

Position of switch:  ,  , 

The daytime running lights light up when the ignition is switched on. After the ignition is switched off, the parking lights light up in position  .

## Cornering light

### General information

Position of switch: 

In tight curves, for instance on mountainous roads or when turning, an additional, cornering light is switched on that lights up the inside of the curve when the vehicle is moving below a certain speed.

The cornering light is automatically switched on depending on the steering angle or the use of turn signals.

## Adaptive headlight range control

The adaptive headlight range control compensates for acceleration and braking operations in order not to blind the oncoming traffic and to achieve optimum illumination of the roadway.

## High-beam Assistant

### Concept

The high-beam Assistant detects other traffic participants early on and automatically switches the high beams on or off depending on the traffic situation.

### General information

The high-beam Assistant ensures that the high beams are switched on, whenever the traffic situation allows. In the low speed range, the high beams are not switched on by the system.

The system responds to light from oncoming traffic and traffic driving ahead of you, and to ambient lighting, for instance in towns and cities.

The high beams can be switched on and off manually at any time.

### Activating/deactivating

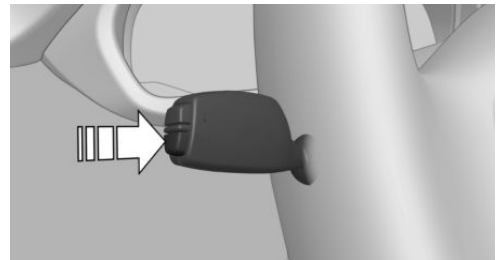

Position of switch, depending on the vehicle equipment:  , 

Press and hold the button on the turn signal lever.



The indicator light in the instrument cluster is illuminated when the low beams are switched on.

The headlights are automatically switched between low beams and high beams.



The blue indicator light in the instrument cluster lights up when the system switches on the high beams.

The high-beam Assistant is deactivated when manually switching the high beams on and off, refer to page 111.

To reactivate the high-beam Assistant, press the button on the turn signal lever.

## System limits

The high-beam Assistant cannot serve as a substitute for the driver's personal judgment of when to use the high beams. In situation that require this, therefore switch off manually.

The system is not fully functional in the following situations, and driver intervention may be necessary:

- ▶ In very unfavorable weather conditions, such as fog or heavy precipitation.
- ▶ When detecting poorly-lit road users such as pedestrians, cyclists, horseback riders and wagons; when driving close to train or ship traffic; and at animal crossings.
- ▶ In tight curves, on hilltops or in depressions, in cross traffic or half-observed oncoming traffic on highways.
- ▶ In poorly-lit towns and cities and in the presence of highly reflective signs.
- ▶ When the windshield in front of the interior mirror is fogged over, dirty or covered with stickers, etc.

## Fog lights

### Front fog lights

#### Concept

The front fog lights work alongside the low beams to illuminate a wider area of the roadway.

#### Functional requirement

The low beams must be switched on before switching on the front fog lights.

#### Switching on/off



Press the button.

The green indicator light lights up if the front fog lights are switched on.

If the automatic headlight control, refer to page 144, is activated, the low beams will come on automatically when you switch on the front fog lights.

When the high beams or headlight flasher are activated, the front fog lights are not switched on.

## Instrument lighting

### Functional requirement

The parking lights or low beams must be switched on to adjust the brightness.

### Settings



Adjust the brightness with the thumbwheel.

## Interior lights

### General information

Depending on the equipment, the interior lights, footwell lights, entry lights, and courtesy lights are controlled automatically.

Thumbwheel for the instrument lighting controls brightness of some of these features.

### Overview



- 1 Interior lights
- 2 Reading lights

### Switching the interior lights on/off



Press the button.

To switch off permanently: press the button and hold for approx. 3 seconds.

### Switching the reading lights on/off



Press the button.

Depending on the vehicle equipment, the reading lights are located next to the interior lights in the front and rear.

## Ambient light

### General information

Depending on the equipment version, lighting can be adjusted for some lights in the car's interior.

### Selecting color scheme

Via iDrive:

1. "My Vehicle"
2. "Vehicle settings"
3. "Lighting"
4. "Interior lighting"
5. "Lighting design"
6. Select the desired setting.

To deactivate the ambient light: "Off".

### Setting the brightness

Via iDrive:

1. "My Vehicle"
2. "Vehicle settings"
3. "Lighting"
4. "Interior lighting"
5. "Brightness"
6. Adjust the brightness.

# Safety

## Vehicle features and options

This chapter describes all standard, country-specific and optional features offered with the series.

It also describes features that are not necessarily available in your vehicle, e. g., due to the selected options or country versions. This also applies to safety-related functions and systems. When using these functions and systems, the applicable laws and regulations must be observed.

## Airbags

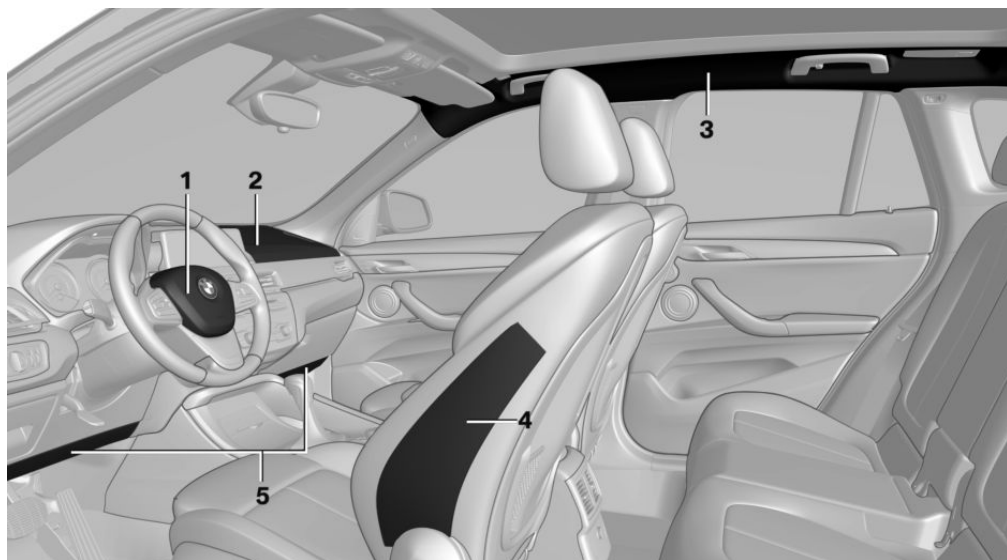

- 1 Front airbag, driver
- 2 Front airbag, front passenger
- 3 Head airbag
- 4 Side airbag
- 5 Knee airbag

### Front airbags

Front airbags help protect the driver and the front passenger by responding to frontal impacts in which safety belts alone would not provide adequate protection.

### Side airbag

In a lateral impact, the side airbag supports the side of the body in the chest and lap area.

### Head airbag

In a lateral impact, the head airbag supports the head.

## Ejection Mitigation

The head airbag system is designed as an ejection mitigation countermeasure to reduce the likelihood of ejections of vehicle occupants through side windows during rollovers or side impact events.

## Knee airbag

The knee airbag supports the legs in a frontal impact.

## Protective effect

Airbags are not triggered in every impact situation, for instance in less severe accidents or rear-end collisions.

## Information on optimum effect of the airbags

### WARNING

If the seat position is incorrect or the deployment area of the airbags is impaired, the airbag system cannot provide protection as intended and may cause additional injuries due to triggering. There is a risk of injuries or danger to life. Follow the information on achieving the optimum protective effect of the airbag system.

- ▷ Keep a distance from the airbags.
- ▷ Always grasp the steering wheel on the steering wheel rim. Hold your hands at the 3 o'clock and 9 o'clock positions, to keep the risk of injury to your hands or arms as low as possible when the airbag is triggered.
- ▷ Make sure that occupants keep their heads away from the side airbag.
- ▷ Make sure that the front passenger is sitting correctly, i.e., keeps his or her feet and legs in the floor area and does not support them on the dashboard.
- ▷ There should be no additional persons, animals or objects between an airbag and a person.

- ▷ Dashboard and windshield on the front passenger side must stay clear - do not attach adhesive labels or coverings and do not attach brackets or cables, for instance for GPS devices or mobile phones.
- ▷ Do not apply adhesive materials to the airbag cover panels, do not cover them or modify them in any way.
- ▷ Do not use the cover of the front airbag on the front passenger side as a storage area.
- ▷ Do not attach slip covers, seat cushions or other objects to the front passenger seat that are not specifically suited for seats with integrated side airbags.
- ▷ Do not hang pieces of clothing, such as jackets, over the backrests.
- ▷ Never modify either the individual components or the wiring in the airbag system. This also applies to steering wheel covers, the dashboard, and the seats.
- ▷ Do not remove the airbag system.

Even when you follow all instructions very closely, injury from contact with the airbags cannot be fully ruled out in certain situations.

The ignition and inflation noise may lead to short-term and, in most cases, temporary hearing impairment in sensitive occupants.

Vehicle modifications for a person with disabilities may affect the air bag system; contact BMW Customer Relations for further information.

Warnings and information on the airbags are also found on the sun visors.

## Functional readiness of the airbag system

### Safety information

#### WARNING

Individual components can be hot after triggering of the airbag system. There is a risk of injury. Do not touch individual components.

**⚠ WARNING**

Improperly executed work can lead to failure, malfunction or unintentional triggering of the airbag system. In the case of a malfunction, the airbag system might not trigger as intended despite the accident severity. There is a risk of injuries or danger to life. Have the airbag system checked, repaired, dismantled and scrapped by a dealer's service center or another qualified service center or repair shop.

**Correct function**

When the ignition is switched on, the warning light in the instrument cluster lights up briefly and thereby indicates the operational readiness of the entire airbag system and the belt tensioner.

**Airbag system malfunctioning**

- ▶ Warning light does not come on when the ignition is switched on.
- ▶ The warning light lights up continuously.

**Automatic deactivation of the front-seat passenger airbags****Concept**

The system reads if the front passenger seat is occupied by measuring the human body's resistance.

Front, knee, and side airbag on the front passenger's side are activated or deactivated.

**General information**

Before transporting a child on the front passenger seat, refer to the safety information and instructions for children on the front passenger seat, see Children.

**Safety information****⚠ WARNING**

To ensure the front-seat passenger airbag function, the system must be able to detect whether a person is sitting in the front passenger seat. The entire seat cushion area must be used for this purpose. There is a risk of injuries or danger to life. Make sure that the front passenger keeps his or her feet in the floor area.

**Malfunction of the automatic deactivation system**

When transporting older children and adults, the front-seat passenger airbags may be deactivated in certain sitting positions. In this case, the indicator light for the front-seat passenger airbags lights up.

In this case, change the sitting position so that the front-seat passenger airbags are activated and the indicator light goes out.

If it is not possible to activate the airbags, have the person sit in the rear.

To enable correct recognition of the occupied seat cushion.

- ▶ Do not attach covers, cushions, ball mats or other items to the front passenger seat unless they are specifically determined to be safe for use on the front passenger seat.
- ▶ Do not place any electronic devices on the front passenger seat if a child restraint system is to be installed on it.
- ▶ Do not place objects under the seat that could press against the seat from below.
- ▶ No moisture in or on the seat.

## Indicator light for the front-seat passenger airbags



The indicator light for the front-seat passenger airbags indicates the operating state of the front-seat passenger airbags.

The light indicates whether the airbags are either activated or deactivated.



- ▶ The indicator light lights up when a child is properly seated in a child restraint system or when the seat is empty. The airbags on the front passenger side are not activated.
- ▶ The indicator light does not light up when, for instance a correctly seated person of sufficient size is detected on the seat. The airbags on the front passenger side are activated.

## Detected child restraint systems

The system generally detects children seated in a child restraint system, particularly in child restraint systems required by NHTSA at the point in time when the vehicle was manufactured. After installing a child restraint system, make sure that the indicator light for the front-seat passenger airbags lights up. This indicates that the child restraint system has been detected and the front-seat passenger airbags are not activated.

## Strength of the driver's and front-seat passenger airbag

The explosive power that activates driver's/front-seat passenger airbags very much depends on the positions of the driver's/front passenger seat.

To maintain the accuracy of this function over the long term, calibrate the front seats as soon as a respective message appears on the Control Display.

## Calibrating the front seats

### **WARNING**

There is a risk of jamming when moving the seats. There is a risk of injury or risk of damage to property. Make sure that the area of movement of the seat is clear prior to any adjustment.

A corresponding message appears on the Control Display.

1. Press the switch and move the respective seat all the way forward, until it stops.
2. Press the switch forward again. The seat still moves forward slightly.
3. Readjust the seat to the desired position.

The calibration procedure is completed when the message on the Control Display disappears.

If the message continues to be displayed, repeat the calibration.

If the message does not disappear after a repeat calibration, have the system checked as soon as possible.

## Tire Pressure Monitor TPM

### Concept

The system monitors tire inflation pressure in the four mounted tires. The system warns you if there is a significant loss of pressure in one or more tires.





## General information

Sensors in the tire valves measure the tire inflation pressure and, depending on the model, the tire temperature.

With use of the system follow further information found under Tire inflation pressure, refer to page 244.

## Functional requirements

The following conditions must be met for the system; otherwise, reliable flagging of a loss of tire inflation pressure is not assured:

- ▷ After a tire or wheel replacement, a reset was performed with the correct tire inflation pressure.
- ▷ After the tire inflation pressure was adjusted to a new value, a reset was performed.
- ▷ Wheels with TPM wheel electronics.

## Status display

### Current status

The system status can be displayed on the Control Display, e.g., whether or not the system is active.

Via iDrive:

1. "My Vehicle"
2. "Vehicle status"
3.  "Tire Pressure Monitor"

The current status is displayed.

## Tire conditions

### General information

Tire and system status are indicated by the color of the wheels and a SMS text message on the Control Display.

## All wheels green

System is active and will issue a warning related to the tire inflation pressures stored during the last reset.

## One to four yellow wheels

A flat tire or major drop in the tire inflation pressure has occurred in the indicated tires.

## Gray wheels

It may not be possible to identify tire pressure losses.

Possible causes:

- ▷ Malfunction.
- ▷ The system is being reset.

## Additional information

The status control display additionally shows the current tire inflation pressures and, depending on the model, tire temperatures. It shows the actual values read; they may vary depending on driving style or weather conditions.

## Resetting the system

Via iDrive:

1. "My Vehicle"
2. "Vehicle status"
3.  "Tire Pressure Monitor"
4. Start the engine but do not drive off.
5. Reset tire inflation pressure: "Perform reset".
6. Drive away.

The wheels are displayed in gray and the following is displayed "Resetting Tire Pressure Monitor...".

After driving faster than 19 mph/30 km/h for a short period, the set tire inflation pressures are accepted as reference values. The reset is completed automatically while driving.

After a successfully completed reset, the wheels on the Control Display are shown in green and



"Tire Pressure Monitor active. See label for recommended pressures." is displayed.

You may interrupt this trip at any time. When you continue the reset resumes automatically.

## Messages

### General information

A low tire inflation pressure may cause the DSC Dynamic Stability Control to be switched on.

### Safety information

#### WARNING

A damaged regular tire with low or missing tire inflation pressure impacts handling, such as steering and braking response. Run-flat tires can maintain limited stability. There is a risk of an accident. Do not continue driving if the vehicle is equipped with normal tires. Follow the information on run-flat tires and continued driving with these tires.

### If a tire inflation pressure check is required

#### Message

A symbol with a Check Control message appears on the Control Display.

#### Symbol Possible cause



The system has detected a wheel change, but no reset was done.

No reset was performed for the system. The system issues a warning based on the tire inflation pressures stored during the last reset.

Inflation was not carried out according to specifications.



The tire inflation pressure has fallen below the level of the last reset.

#### Measure

1. Check the tire pressure and correct as needed.
2. Reset the system.

### If the tire inflation pressure is too low

#### Message



A yellow warning light is illuminated in the instrument cluster.

In addition, a symbol with a Check Control message appears on the Control Display.

#### Symbol Possible cause



There is a tire inflation pressure loss. No reset was performed for the system. The system issues a warning based on the tire inflation pressures stored during the last reset.

#### Measure

1. Reduce your speed and drive moderately. Do not exceed a speed of 80 mph/130 km/h.
2. At the next opportunity, for instance gas station, check and correct the tire inflation pressure in all four tires, if necessary.
3. Reset the system.

### If there is a significant loss of tire inflation pressure

#### Message



A yellow warning light is illuminated in the instrument cluster.

In addition, a symbol with the affected tire appears in a Check Control message on the Control Display.

**Symbol Possible cause**

There is a flat tire or a major loss in tire inflation pressure.

No reset was performed for the system. The system issues a warning based on the tire inflation pressures stored during the last reset.

**Measure**

1. Reduce your speed and stop cautiously. Avoid sudden braking and steering maneuvers.
2. Check whether the vehicle is fitted with normal tires or run-flat tires.

Run-flat tires, refer to page 251, are labeled with a circular symbol containing the letters RSC marked on the tire's sidewall.

**Actions in the event of a flat tire****Normal tires**

1. Identify the damaged tire.

To do this, check the air pressure in all four tires, for instance using the tire pressure gage of a flat tire kit.

If the tire inflation pressure in all four tires is correct, the Tire Pressure Monitor may not have been reset. In this case, perform the reset.

If identification of flat tire damage is not possible, please contact a dealer's service center or another qualified service center or repair shop.

2. Repair the flat tire, e.g., with a flat tire kit or by changing the wheel.

Use of sealant, for instance from the flat tire kit, may damage the TPM wheel electronics. In this case, have the electronics checked and replaced at the next opportunity.

**Run-flat tires****Safety information****⚠ WARNING**

Your vehicle handles differently with a run-flat with no or low inflation pressure; for instance, your lane stability when braking is reduced, braking distances are longer and the self-steering properties will change. There is a risk of an accident. Drive moderately and do not exceed a speed of 50 mph/80 km/h.

**Maximum speed**

You may continue driving with a damaged tire at speeds up to 50 mph/80 km/h.

**Continued driving with a flat tire**

If continuing to drive with a damaged tire:

1. Avoid sudden braking and steering maneuvers.
2. Do not exceed a speed of 50 mph/80 km/h.
3. Check the air pressure in all four tires at the next opportunity.

If the tire inflation pressure in all four tires is correct, the Tire Pressure Monitor may not have been reset. In this case, perform the reset.

**Possible driving range with a depressurized tire**

The distance for which it may be possible to drive safely varies depending on how the vehicle is loaded and used, e.g., speed, road conditions, external temperature. The driving range may be less but may also be more if an economical driving style is used.

If the vehicle is loaded with an average weight and used under favorable conditions, the distance for which it may be safe to drive may be up to 50 miles/80 km.

## Vehicle handling with damaged tires

Vehicles driven with a damaged tire will handle differently, potentially leading to conditions such as the following:

- ▷ Greater likelihood of swerving off course.
- ▷ Longer braking distances.
- ▷ Changed self-steering properties.

Modify your driving style. Avoid abrupt steering maneuvers or driving over obstacles, for instance curbs or potholes.

## Final tire failure

Vibrations or loud noises while driving can indicate the final failure of a tire.

Reduce speed and stop; otherwise, pieces of the tire could come loose and cause an accident.

Do not continue driving. Contact a dealer's service center or another qualified service center or repair shop.

## System limits

### Temperature

The tire inflation pressure depends on the tire's temperature.

Driving or exposure to the sun will increase the tire's temperature, thus increasing the tire inflation pressure.

The tire inflation pressure is reduced when the tire temperature falls again.

These circumstances may cause a warning when temperatures fall very sharply.

### Sudden tire pressure loss

The system cannot indicate sudden serious tire damage caused by external circumstances.

### Failure to perform a reset

The system does not function properly if a reset has not been carried out, for instance a flat tire is reported though tire inflation pressures are correct.

## Malfunction



The yellow warning light flashes and is then illuminated continuously. A Check Control message is displayed. It may not be possible to identify tire pressure losses.

Examples and recommendations in the following situations:

- ▷ A wheel without TPM wheel electronics is mounted: have it checked by a dealer's service center or another qualified service center or repair shop as needed.
- ▷ A wheel without TPM wheel electronics, for instance an emergency wheel, is mounted: have it checked by a dealer's service center or another qualified service center or repair shop as needed.
- ▷ Malfunction: have system checked by a dealer's service center or another qualified service center or repair shop.
- ▷ The system was unable to complete the reset. Perform a system reset again.
- ▷ Interference caused by systems or devices with the same radio frequency: after leaving the area of the interference, the system automatically becomes active again.

## Declaration according to NHTSA/ FMVSS 138 Tire Pressure Monitoring System

Each tire, including the spare (if provided) should be checked monthly when cold and inflated to the inflation pressure recommended by the vehicle manufacturer on the vehicle placard or tire inflation pressure label. (If your vehicle has tires of a different size than the size indicated on the vehicle placard or tire inflation pressure label, you should determine the proper tire inflation pressure for those tires.) As an added safety feature, your vehicle has been equipped with a tire pressure monitoring system (TPMS) that illuminates a low tire pressure telltale when one or more of your tires is significantly under-inflated. Accordingly, when the low tire pressure telltale illumi-



nates, you should stop and check your tires as soon as possible, and inflate them to the proper pressure. Driving on a significantly under-inflated tire causes the tire to overheat and can lead to tire failure. Under-inflation also reduces fuel efficiency and tire tread life, and may affect the vehicle's handling and stopping ability. Please note that the TPMS is not a substitute for proper tire maintenance, and it is the driver's responsibility to maintain correct tire pressure, even if under-inflation has not reached the level to trigger illumination of the TPMS low tire pressure telltale. Your vehicle has also been equipped with a TPMS malfunction indicator to indicate when the system is not operating properly. The TPMS malfunction indicator is combined with the low tire pressure telltale. When the system detects a malfunction, the telltale will flash for approximately one minute and then remain continuously illuminated. This sequence will continue upon subsequent vehicle start-ups as long as the malfunction exists. When the malfunction indicator is illuminated, the system may not be able to detect or signal low tire pressure as intended. TPMS malfunctions may occur for a variety of reasons, including the installation of replacement or alternate tires or wheels on the vehicle that prevent the TPMS from functioning properly. Always check the TPMS malfunction telltale after replacing one or more tires or wheels on your vehicle to ensure that the replacement or alternate tires and wheels allow the TPMS to continue to function properly.

## FTM Flat Tire Monitor

### Concept

The system detects tire inflation pressure loss on the basis of rotation speed differences between the individual wheels while driving.

In the event of a tire inflation pressure loss, the diameter and therefore the rotational speed of the corresponding wheel changes. The difference will be detected and reported as a flat tire.

The system does not measure the actual inflation pressure in the tires.

### Functional requirements

The following conditions must be met for the system; otherwise, reliable flagging of a loss of tire inflation pressure is not assured:

- ▶ After a tire or wheel replacement, an initialization was performed with the correct tire inflation pressure.
- ▶ After the tire inflation pressure was adjusted to a new value, an initialization was performed.

### Status display

The current status of the flat tire monitor can be displayed, for instance whether the RPA is active.

Via iDrive:

1. "My Vehicle"
2. "Vehicle status"
3. (📁) "Flat Tire Monitor"

The status is displayed.

### Initialization required

An initialization must be performed in the following situations:

- ▶ After the tire inflation pressure has been adjusted.
- ▶ After a tire or wheel replacement.

### Performing initialization

When initializing, the set tire inflation pressures serve as reference values in order to detect a flat tire. Initialization is started by confirming the tire inflation pressures.

Do not initialize the system when driving with snow chains.

Via iDrive:

1. "My Vehicle"
2. "Vehicle status"

3.  "Flat Tire Monitor"
4. Start the engine but do not drive off.
5. Start the initialization with: "Perform reset"
6. Drive away.

The initialization is completed while driving, which can be interrupted at any time.

The initialization automatically continues when driving resumes.

## Messages

### General information

When a flat tire is indicated, DSC Dynamic Stability Control is switched on, if needed.

### Safety information

#### **WARNING**

A damaged regular tire with low or missing tire inflation pressure impacts handling, such as steering and braking response. Run-flat tires can maintain limited stability. There is a risk of an accident. Do not continue driving if the vehicle is equipped with normal tires. Follow the information on run-flat tires and continued driving with these tires.

### Indication of a flat tire



A yellow warning light is illuminated in the instrument cluster.

In addition, a symbol with a Check Control message appears on the Control Display.

Symbol	Possible cause
	There is a flat tire or a major loss in tire inflation pressure.



There is a flat tire or a major loss in tire inflation pressure.

## Measure

1. Reduce your speed and stop cautiously. Avoid sudden braking and steering maneuvers.
2. Check whether the vehicle is fitted with normal tires or run-flat tires.

Run-flat tires, refer to page 251, are labeled with a circular symbol containing the letters RSC marked on the tire's sidewall.

## Actions in the event of a flat tire

### Normal tires

1. Identify the damaged tire.

To do this, check the air pressure in all four tires, for instance using the tire pressure gage of a flat tire kit.

If the tire inflation pressure in all four tires is correct, the Flat Tire Monitor may not have been initialized. In this case, initialize the system.

If identification of flat tire damage is not possible, please contact a dealer's service center or another qualified service center or repair shop.

2. Repair the flat tire, e.g., with a flat tire kit or by changing the wheel.

### Run-flat tires

#### Safety information

#### **WARNING**

Your vehicle handles differently with a run-flat with no or low inflation pressure; for instance, your lane stability when braking is reduced, braking distances are longer and the self-steering properties will change. There is a risk of an accident. Drive moderately and do not exceed a speed of 50 mph/80 km/h.



### Maximum speed

You may continue driving with a damaged tire at speeds up to 50 mph/80 km/h.

### Continued driving with a flat tire

If continuing to drive with a damaged tire:

1. Avoid sudden braking and steering maneuvers.
2. Do not exceed a speed of 50 mph/80 km/h.
3. Check the air pressure in all four tires at the next opportunity.

If the tire inflation pressure in all four tires is correct, the Flat Tire Monitor may not have been initialized. In this case, initialize the system.

### Possible driving range with a depressurized tire

The distance for which it may be possible to drive safely varies depending on how the vehicle is loaded and used, e.g., speed, road conditions, external temperature. The driving range may be less but may also be more if an economical driving style is used.

If the vehicle is loaded with an average weight and used under favorable conditions, the distance for which it may be safe to drive may be up to 50 miles/80 km.

### Vehicle handling with damaged tires

Vehicles driven with a damaged tire will handle differently, potentially leading to conditions such as the following:

- ▷ Greater likelihood of swerving off course.
- ▷ Longer braking distances.
- ▷ Changed self-steering properties.

Modify your driving style. Avoid abrupt steering maneuvers or driving over obstacles, for instance curbs or potholes.

### Final tire failure

Vibrations or loud noises while driving can indicate the final failure of a tire.

Reduce speed and stop; otherwise, pieces of the tire could come loose and cause an accident.

Do not continue driving. Contact a dealer's service center or another qualified service center or repair shop.

### System limits

The system could be delayed or malfunction in the following situations:

- ▷ A natural, even tire inflation pressure loss in all four tires will not be recognized. Therefore, check the tire inflation pressure regularly.
- ▷ Sudden serious tire damage caused by external circumstances cannot be recognized in advance.
- ▷ When the system has not been initialized.
- ▷ When driving on a snowy or slippery road surface.
- ▷ Sporty driving style: spinning traction wheels, high lateral acceleration (drifting).
- ▷ When driving with snow chains.

## Intelligent Safety

---

### Concept

Intelligent Safety enables central operation of the driver assistance system. Depending on how the vehicle is equipped, Intelligent Safety consists of one or more systems that can help prevent an imminent collision.

- ▷ Approach control warning with City light braking function, refer to page [159](#).
- ▷ Pedestrian warning, refer to page [162](#).
- ▷ Lane departure warning, refer to page [165](#).

## Safety information

### WARNING

The system cannot serve as a substitute for the driver's personal judgment in assessing visibility and traffic situation. There is a risk of an accident. Adjust driving style to traffic conditions. Watch traffic closely and actively intervene where appropriate.

### WARNING

Indicators and warnings cannot serve as a substitute for the driver's personal judgment. Due to its limits, the system might not output warnings or reactions or these might be output late, incorrectly, or without justification. There is a risk of an accident. Adjust driving style to traffic conditions. Watch traffic closely and actively intervene where appropriate.

### WARNING

Due to system limits, individual functions can malfunction during tow-starting/towing with the Intelligent Safety systems activated. There is a risk of an accident. Switch all Intelligent Safety systems off prior to tow-starting/towing.

## Overview

### Button in the vehicle



 Intelligent Safety button

## Switching on/off

Some Intelligent Safety systems are automatically active after every departure. Some Intelligent Safety systems activate according to the last setting.

 Press button briefly:

- ▶ The menu for the intelligent safety system is displayed. The systems are individually switched off according to their respective settings.
- ▶ LED lights up orange or goes out respective to their individual settings.

Adjust as needed. Individual settings are stored for the profile currently used.

 Press button again:

- ▶ All Intelligent Safety systems are switched on.
- ▶ The LED lights up green.

 Hold down button:

- ▶ All Intelligent Safety systems are switched off.
- ▶ The LED goes out.

## Approach control warning with city light braking function

### Concept

The system can help prevent accidents. If an accident cannot be prevented, the system will help reduce the impact speed.

The system sounds a warning before an imminent collision and activates brakes independently, if needed.



The automatic braking intervention is done with limited force and duration.

A camera in the area of the interior mirror controls the system.

The approach control warning is available even if cruise control has been deactivated.

With the vehicle approaching another vehicle intentionally, the approach control warning and braking are delayed in order to avoid false system reactions.

## General information

The system warns at two levels of an imminent danger of collision at speeds from approx. 3 mph/5 km/h. Time of warnings may vary with the current driving situation.

Appropriate braking kicks in at speeds of up to 35 mph/60 km/h.

## Detection range

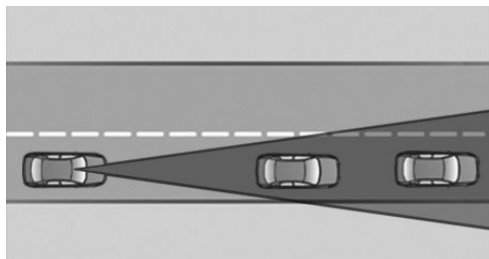

Objects that the system can detect are taken into account.

## Safety information

### **WARNING**

The system cannot serve as a substitute for the driver's personal judgment in assessing visibility and traffic situation. There is a risk of an accident. Adjust driving style to traffic conditions. Watch traffic closely and actively intervene where appropriate.

### **WARNING**

Indicators and warnings cannot serve as a substitute for the driver's personal judgment. Due to its limits, the system might not output warnings or reactions or these might be output late, incorrectly, or without justification. There is a risk of an accident. Adjust driving style to traffic conditions. Watch traffic closely and actively intervene where appropriate.

### **WARNING**

Due to system limits, individual functions can malfunction during tow-starting/towing with the Intelligent Safety systems activated. There is a risk of an accident. Switch all Intelligent Safety systems off prior to tow-starting/towing.

## Overview

### Button in the vehicle



Intelligent Safety button



## Camera

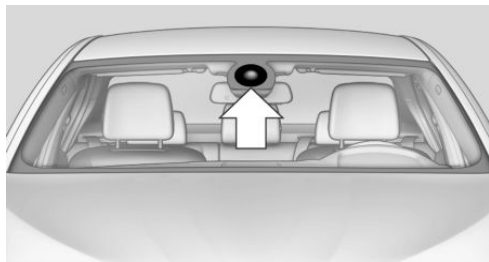

The camera is installed near the interior mirror. Keep the windshield in front of the interior mirror clean and clear.

## Switching on/off

### Switching on automatically

The system is automatically active after every driving off.

### Switching on/off manually



Press button briefly:

- ▶ The menu for the intelligent safety system is displayed. The systems are individually switched off according to their respective settings.
- ▶ LED lights up orange or goes out respective to their individual settings.

Adjust as needed. The individual settings are stored for the driver profile currently in use.



Press button again:

- ▶ All Intelligent Safety systems are switched on.
- ▶ The LED lights up green.



Hold down button:

- ▶ All Intelligent Safety systems are switched off.
- ▶ The LED goes out.

## Setting the warning time

The warning time can be set.

Via iDrive:

1. "My Vehicle"
2. "Vehicle settings"
3. "Intelligent Safety"
4. "Warning time"
5. Select the desired setting.

The selected time is stored for the profile currently used.

## Warning with braking function

### Display

A warning symbol appears in the instrument cluster and in the Head-up Display if a collision with a detected vehicle is imminent.

#### Symbol Measure



Symbol lights up red: prewarning. Brake and increase distance.



Symbol flashes red and an acoustic signal sounds: acute warning. Brake and make an evasive maneuver, if necessary.

### Prewarning

This warning is provided, for instance when there is impending danger of a collision or the distance to the vehicle ahead is too small.

If a prewarning is provided, respond by braking as warranted.

### Acute warning with braking function

Acute warning is displayed in case of the imminent danger of a collision when the vehicle approaches another object at a high differential speed.

The driver must intervene actively when there is an acute warning. If necessary, the driver is as-



sisted by a minor automatic braking intervention in a possible risk of collision.

Acute warnings can also be triggered without previous forewarning.

## Braking intervention

The warning prompts the driver to react. During a warning, the maximum braking force is used. Prerequisite for the brake booster is sufficiently quick and hard stepping on the brake pedal. If there is a risk of collision, the system may assist with braking. When the vehicle is traveling at a low speed, the vehicle may come to a complete stop.

The braking intervention occurs only if vehicle stability has not been restricted, for instance by deactivating the DSC Dynamic Stability Control.

The driver may cancel the braking intervention by stepping on the accelerator pedal or by actively moving the steering wheel.

Object detection can be restricted. Follow the limitations of the detection range and functional limitations.

## System limits

### Safety information



#### **WARNING**

The system can react not at all, too late, incorrectly, or without justification due to the system limits. There is a risk of accidents or risk of damage to property. Follow the information regarding the system limits and actively intervene if needed.

### Detection range

The system's detection potential is limited.

Thus, a system reaction might not come or might come late.

E.g., the following situations may not be detected:

- ▷ Slow moving vehicles when you approach them at high speed.
- ▷ Vehicles that suddenly swerve in front of you, or sharply decelerating vehicles.
- ▷ Vehicles with an unusual rear appearance.
- ▷ Two-wheeled vehicles ahead of you.

### Functional limitations

The system may not be fully functional in the following situations:

- ▷ In heavy fog, wet conditions, or snowfall.
- ▷ In tight curves.
- ▷ If the driving stability control systems are deactivated, for instance DSC OFF.
- ▷ If the field of view of the camera in the mirror is dirty or obscured.
- ▷ Up to 10 seconds after the start of the engine via the Start/Stop button.
- ▷ During calibration of the camera immediately after vehicle delivery.
- ▷ If there are constant blinding effects because of oncoming light, for instance from the sun low in the sky.

### Warning sensitivity

The more sensitive the warning settings are, for example the warning time, the more warnings are displayed. Therefore, there may also be an excess of premature or unjustified warnings and reactions.

## Person warning with City light braking function

### Concept

The system can help prevent accidents with pedestrians.

When driving at city speeds, the system will issue a warning if there is imminent risk of a collision with pedestrians, and support this with a light braking function.

The camera in the area of the interior mirror controls the system.

## General information

With sufficient brightness, the system warns about possible collision danger with pedestrians starting at approx. 6 mph/10 km/h to approx. 35 mph/60 km/h and assists with braking before a collision.

The system reacts to people who are within the detection range of the system.

## Detection range

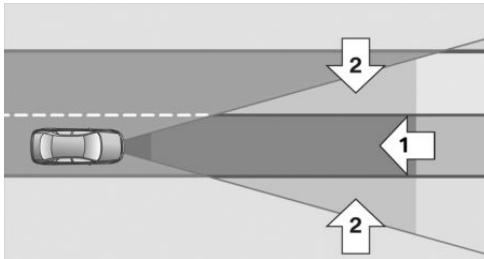

The detection area in front of the vehicle is divided into two areas:

- ▶ Central area, arrow 1, directly in front of the vehicle.
- ▶ Expanded area, arrow 2, to the right and left of the central area.

A collision is imminent if pedestrians are located within the central area. A warning is issued about pedestrians who are located within the extended area only if they are moving in the direction of the central area.

## Safety information

### WARNING

The system cannot serve as a substitute for the driver's personal judgment in assessing visibility and traffic situation. There is a risk of an accident. Adjust driving style to traffic conditions.

Watch traffic closely and actively intervene where appropriate.

### WARNING

Indicators and warnings cannot serve as a substitute for the driver's personal judgment. Due to its limits, the system might not output warnings or reactions or these might be output late, incorrectly, or without justification. There is a risk of an accident. Adjust driving style to traffic conditions. Watch traffic closely and actively intervene where appropriate.

### WARNING

Due to system limits, individual functions can malfunction during tow-starting/towing with the Intelligent Safety systems activated. There is a risk of an accident. Switch all Intelligent Safety systems off prior to tow-starting/towing.

## Overview

### Button in the vehicle



 Intelligent Safety button

## Camera

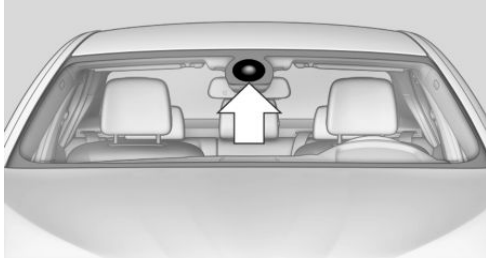

The camera is installed near the interior mirror. Keep the windshield in front of the interior mirror clean and clear.

## Switching on/off

### Switching on automatically

The system is automatically active after every driving off.

### Switching on/off manually



Press button briefly:

- ▶ The menu for the intelligent safety system is displayed. The systems are individually switched off according to their respective settings.
- ▶ LED lights up orange or goes out respective to their individual settings.

Adjust as needed. The individual settings are stored for the driver profile currently in use.



Press button again:

- ▶ All Intelligent Safety systems are switched on.
- ▶ The LED lights up green.



Hold down button:

- ▶ All Intelligent Safety systems are switched off.
- ▶ The LED goes out.

## Warning with braking function

### Display

If a collision with a person detected in this way is imminent, a warning symbol appears on the instrument cluster and in the Head-up Display.



The red symbol is displayed and a signal sounds.

Intervene immediately by braking or make an evasive maneuver.

### Braking intervention

The warning prompts the driver to react. During a warning, the maximum braking force is used. Prerequisite for the brake booster is sufficiently quick and hard stepping on the brake pedal. If there is a risk of collision, the system may assist with braking. When the vehicle is traveling at a low speed, the vehicle may come to a complete stop.

The braking intervention occurs only if vehicle stability has not been restricted, for instance by deactivating the DSC Dynamic Stability Control.

The driver may cancel the braking intervention by stepping on the accelerator pedal or by actively moving the steering wheel.

Object detection can be restricted. Follow the limitations of the detection range and functional limitations.

## System limits

### Safety information

#### **WARNING**

The system can react not at all, too late, incorrectly, or without justification due to the system limits. There is a risk of accidents or risk of damage to property. Follow the information regarding the system limits and actively intervene if needed.

## Detection range

The detection potential of the camera is limited. Thus, a warning might not be issued or be issued late.

E.g., the following situations may not be detected:

- ▶ Partially covered pedestrians.
- ▶ Pedestrians that are not detected as such because of the viewing angle or contour.
- ▶ Pedestrians outside of the detection range.
- ▶ Pedestrians having a body size less than 32 in/80 cm.

## Functional limitations

The system may not be fully functional or may not be available in the following situations:

- ▶ In heavy fog, wet conditions, or snowfall.
- ▶ In tight curves.
- ▶ If the driving stability control systems are deactivated, for instance DSC OFF.
- ▶ If the field of view of the camera or the windshield are dirty or covered.
- ▶ Up to 10 seconds after the start of the engine via the Start/Stop button.
- ▶ During calibration of the camera immediately after vehicle delivery.
- ▶ If there are constant blinding effects because of oncoming light, for instance from the sun low in the sky.
- ▶ When it is dark outside.

## Lane departure warning

### Concept

The lane departure warning alerts when the vehicle on roads with lane markings is about to leave the lane.

## General information

Depending on the country version, the system issues a warning at speeds between 35 mph/55 km/h and 45 mph/70 km/h.

When switching on the system below this speed, a message is displayed in the instrument cluster.

Warnings are issued by means of a steering wheel vibration. The time of the warning may vary depending on the current driving situation.

The system does not provide a warning if the turn signal is set before leaving the lane.

## Safety information

### **WARNING**

The system cannot serve as a substitute for the driver's personal judgment in assessing road and traffic safety. There is a risk of an accident. Adjust driving style to traffic conditions. Watch traffic closely and actively intervene where appropriate. Do not jerk the steering wheel in response to a warning.

### **WARNING**

Indicators and warnings cannot serve as a substitute for the driver's personal judgment. Due to its limits, the system might not output warnings or reactions or these might be output late, incorrectly, or without justification. There is a risk of an accident. Adjust driving style to traffic conditions. Watch traffic closely and actively intervene where appropriate.

## Overview

### Button in the vehicle



 Intelligent Safety button

### Camera

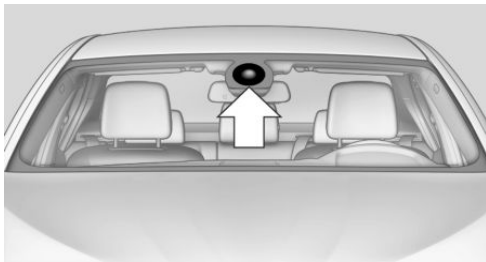

The camera is installed near the interior mirror. Keep the windshield in front of the interior mirror clean and clear.

## Switching on/off

### Switching on automatically

The lane departure warning is automatically activated after departure, if the function was switched on the last time the engine was stopped.

### Switching on/off manually

-  Press button briefly:
  - ▶ The menu for the intelligent safety system is displayed. The systems

are individually switched off according to their respective settings.



- ▶ LED lights up orange or goes out respective to their individual settings.

Adjust as needed. The individual settings are stored for the driver profile currently in use.

-  Press button again:
  - ▶ All Intelligent Safety systems are switched on.
  - ▶ The LED lights up green.

-  Hold down button:
  - ▶ All Intelligent Safety systems are switched off.
  - ▶ The LED goes out.

## Display in the instrument cluster

-  ▶ Yellow symbol: system is activated.
-  ▶ Green symbol: at least one lane marking was detected and warnings can be issued.

## Issued warning

### If you leave the lane

If you leave the lane and if a lane marking has been detected, the steering wheel vibrates.

If the turn signal is switched on before changing the lane, a warning is not issued.

### End of warning

The warning is canceled in the following situations:

- ▶ Automatically after approx. 3 seconds.
- ▶ When returning to your own lane.
- ▶ When braking hard.
- ▶ When using the turn signal.

## System limits

### Safety information

#### WARNING

The system can react not at all, too late, incorrectly, or without justification due to the system limits. There is a risk of accidents or risk of damage to property. Follow the information regarding the system limits and actively intervene if needed.

### Functional limitations

The system may not be fully functional in the following situations:

- ▶ In heavy fog, wet conditions, or snowfall.
- ▶ In the event of missing, worn, poorly visible, merging, diverging, or multiple lane markings such as in construction areas.
- ▶ When lane markings are covered in snow, ice, dirt or water.
- ▶ In tight curves or on narrow lanes.
- ▶ When lane markings are covered by objects.
- ▶ When driving very close to the vehicle in front of you.
- ▶ When driving toward bright lights.
- ▶ When the windshield in front of the interior mirror is fogged over, dirty or covered with stickers, etc.
- ▶ During calibration of the camera immediately after vehicle delivery.

## Brake force display

### Concept

Additional brake lights indicate emergency braking to the traffic behind. This can reduce the risk of a rear-end collision.

## General information



- ▶ During normal brake application, the outer brake lights light up.
- ▶ During heavy brake application, the inner brake lights additionally light up.

## Alertness assistant

### Concept

The system can detect decreasing alertness or fatigue of the driver during long, monotonous trips, for instance on highways. In this situation, it is recommended that the driver takes a break.

### Safety information

#### WARNING

The system cannot serve as a substitute for the driver's personal judgment in assessing one's physical state. An increasing lack of alertness or fatigue may not be detected or not be detected in time. There is a risk of an accident. Make sure that the driver is rested and alert. Adjust driving style to traffic conditions.

### Function

The system is switched on each time the engine is started and cannot be switched off.

After travel has begun, the system monitors certain aspects of the driver's behavior, so that decreasing alertness or fatigue can be detected.





This procedure takes the following criteria into account:

- ▷ Personal driving style, for instance steering behavior.
- ▷ Driving conditions, for instance length of trip.

Starting at approximately 43 mph/70 km/h, the system is active and can display a recommendation to take a break.

## Break recommendation

If the driver becomes less alert or fatigued, a message is displayed in the Control Display with the recommendation to take a break.

A recommendation to take a break is displayed only once during an uninterrupted trip.

After a break, another recommendation to take a break cannot be displayed until after approximately 45 minutes.

## System limits

The function may be limited in the following situations, for instance and will either output an incorrect warning or no warning at all:

- ▷ When the clock is set incorrectly.
- ▷ When the vehicle speed is mainly below about 43 mph/70 km/h.
- ▷ With a sporty driving style, such as during rapid acceleration or when cornering fast.
- ▷ In active driving situations, such as when changing lanes frequently.
- ▷ When the road surface is poor.
- ▷ In the event of strong side winds.

The system is reset approx. 45 minutes after parking the vehicle, for instance in the case of a break during longer trips on highways.

vention by the driver in certain situations. This can reduce the risk of a further collision and the consequences thereof.

## Harder vehicle braking

It can be necessary to bring the vehicle in certain situations to a halt quicker.

To do this, for a short time the braking pressure applied when stepping on the brake pedal must be higher than the braking pressure achieved by the automatic braking function. This interrupts automatic braking.

## Interrupting automatic braking

It can be necessary to interrupt automatic braking in certain situations, for example for an evasive maneuver.

Interrupt automatic braking:

- ▷ By pressing the brake pedal.
- ▷ By pressing the accelerator pedal.

## At standstill

After coming to a halt, the brake is released automatically.

# PostCrash – iBrake

---

## Concept

In the event of an accident, the system can bring the vehicle to a halt automatically without inter-

# Driving stability control systems

## Vehicle features and options

---

This chapter describes all standard, country-specific and optional features offered with the series. It also describes features that are not necessarily available in your vehicle, e. g., due to the selected options or country versions. This also applies to safety-related functions and systems. When using these functions and systems, the applicable laws and regulations must be observed.

## Anti-lock Braking System ABS

---

ABS prevents locking of the wheels during braking.

The vehicle maintains its steering power even during full brake applications, thus increasing active safety.

ABS is operational every time you start the engine.

## Brake assistant

---

When you apply the brakes rapidly, this system automatically boosts the vehicle braking capability to the furthest possible extent. It reduces the braking distance to a minimum during emergency stop. This system utilizes all of the capabilities provided by the Antilock Brake System ABS.

Do not reduce the pressure on the brake pedal for the duration of the emergency stop.

## Automatic Differential Brake

---

The system controls the driving force by automatic braking intervention on individual wheels. The function corresponds to a differential lock: the system detects if a wheel begins to spin, because of loose road surface, for instance and automatically brakes it.

The driving force is diverted to the wheel with better traction.

As a result, the engine force is transferred more efficiently to the wheels during accelerations.

## DSC Dynamic Stability Control

---

### Concept

Within the physical limits, the system helps to keep the vehicle on a steady course by reducing engine speed and by applying brakes to the individual wheels.

### General information

DSC detects the following unstable driving conditions, for instance:

- ▷ Fishtailing, which can lead to oversteering.
- ▷ Loss of traction of the front wheels, which can lead to understeering.

Dynamic Traction Control DTC, refer to page 171, is a version of the DSC where forward momentum is optimized.

## Safety information

### WARNING

The system cannot serve as a substitute for the driver's personal judgment in assessing the traffic situation. Based on the limits of the system, it cannot independently react to all traffic situations. There is a risk of an accident. Adjust driving style to traffic conditions. Watch traffic closely and actively intervene where appropriate.

### WARNING

When driving with a roof load, for instance with roof-mounted luggage rack, the vehicle's center of gravity is higher, which increases the risk of the vehicle tipping in critical driving situations. There is a risk of accidents or risk of damage to property. Do not deactivate DSC Dynamic Stability Control when driving with roof load.

## Overview

### Button in the vehicle



DSC OFF button

### Indicator/warning lights



The indicator light flashes: DSC controls the drive and braking forces.

The indicator light lights up: DSC has malfunctioned.

## Deactivating DSC: DSC OFF

### General information

When DSC is deactivated, driving stability is reduced during acceleration and when driving in curves.

To increase vehicle stability, activate DSC again as soon as possible.

### Deactivating DSC



Press and hold this button but not longer than approx. 10 seconds, until the indicator light for DSC OFF lights up in the instrument cluster and displays DSC OFF.

DSC is switched off.

### Activating DSC



Press the button.

DSC OFF and the DSC OFF indicator light go out.

### Indicator/warning lights

When DSC is deactivated, DSC OFF is displayed in the instrument cluster.



The indicator light lights up: DSC is deactivated.

### Automatic activation

When DSC is deactivated, automatic activation occurs in the following situations:

- ▶ The vehicle has a flat tire.
- ▶ When activating cruise control in TRACTION or DSC OFF mode.

## DTC Dynamic Traction Control

### Concept

DTC is a version of the DSC Dynamic Stability Control where forward momentum is optimized.

The system ensures maximum headway on special road conditions or loose road surfaces, for instance unplowed snowy roads, but with somewhat limited driving stability.

When DTC is activated, the vehicle has maximum traction. Driving stability is limited during acceleration and when driving in curves.

Drive carefully.

You may find it useful to briefly activate DTC under the following special circumstances:

- ▶ When driving in slush or on uncleared, snow-covered roads.
- ▶ When driving off from deep snow or loose ground.
- ▶ When driving with snow chains.

## Deactivating/activating DTC Dynamic Traction Control

### Activating DTC



Press the button.

TRACTION is displayed in the instrument cluster and the indicator light for DSC OFF lights up.

### Deactivating DTC



Press the button again.

TRACTION and the DSC OFF indicator light go out.

## Performance Control

Performance Control enhances the agility of the vehicle.

To increase maneuverability, wheels are braked individually when a sporty driving style is used.

## xDrive

xDrive is the all-wheel-drive system of your vehicle. Concerted action by the xDrive and DSC Dynamic Stability Control further optimizes traction and driving dynamics. The xDrive all-wheel-drive system variably distributes the drive forces to the front and rear axles as demanded by the driving situation and road surface.

## HDC Hill Descent Control

### Concept

Hill Descent Control, HDC, is a downhill control feature that controls the vehicle speed on steep downhill grades, for instance when driving on unpaved roads.

When the system is active, the vehicle moves at the speed set by the driver, without the driver having to depress the brake pedal.

While HTC is controlling the speed, the system automatically distributes the braking force to the individual wheels. This improves vehicle drivability and stability. If necessary, the Antilock Brake System prevents the wheels from locking.

### General information

Hill Descent Control can be activated at speeds below approx. 25 mph/40 km/h.

Speeds can be set between approx.

2 mph/3 km/h and approx. 20 mph/30 km/h.

When the vehicle is moving downhill, the system reduces the speed to the set value, within the physical limits.

Only use HDC in low gears or in selector lever position D or R.

## Overview

### Button in the vehicle



HDC

### Activating HDC

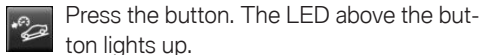

Press the button. The LED above the button lights up.

Speeds between approx. 2 mph/3 km/h and approx. 20 mph/30 km/h are adopted as the desired speed.

### Display in the instrument cluster



A symbol and the selected desired speed are displayed.

- ▶ Green display: HDC is active, the system is reducing the vehicle speed.

- ▶ Orange display: HDC is on standby.

### Display in the Head-up Display

The HDC status can also be displayed in the Head-up Display.

## Increasing or decreasing vehicle speed

### Using the cruise control rocker switch

The desired speed can be changed using the cruise control rocker switch on the steering wheel.

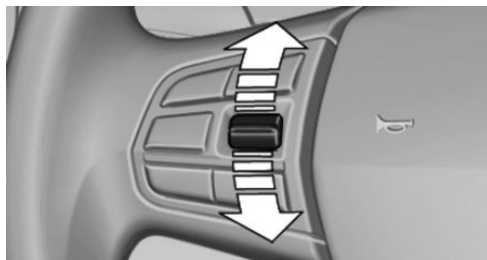

- ▶ Press the rocker switch up: the speed increases gradually.
- ▶ Press the rocker switch up and hold: the speed increases while the rocker switch is pressed.
- ▶ Press the rocker switch down: the speed decreases gradually.
- ▶ Press the rocker switch down and hold: the speed decreases while the rocker switch is pressed.

### Using the brake pedal

While HDC is controlling the speed, the set desired speed can be reduced by depressing the brake pedal.

### Deactivating HDC



Press the button again. The LED goes out.

HDC is automatically deactivated above approx. 25 mph/40 km/h.

### Malfunction

If a malfunction occurs, a message is displayed in the instrument cluster.

## Servotronic

### Concept

Servotronic is a speed-dependent power steering function.

The system provides the steering force with more support at low speeds than at higher ones. This makes it easier to park, for instance, and makes steering more direct when driving at faster speeds.

Furthermore, the steering force adapts according to the driving program, so that a direct, sporty feel or a comfortable steering response is conveyed.

## Driving Dynamics Control

### Concept

The Driving Dynamics Control helps to fine-tune the vehicle's settings and features. Various programs can be selected for this purpose.

### Overview

#### Button in the vehicle



## Operating the programs

### Button



### Program

SPORT  
COMFORT  
ECO PRO

## SPORT

### Concept

Consistently sporty tuning of the steering and drivetrain for greater driving agility.

With the appropriate equipment, the tuning of the suspension also changes and SPORT can be individually configured.

The configuration is stored for the profile currently used.

### Activating SPORT



Press the button repeatedly until SPORT is displayed in the instrument cluster.

### Configuring SPORT

Via iDrive:

1. "My Vehicle"
2. "Vehicle settings"
3. If necessary, "Driving mode"
4. "Configure SPORT"
5. Select the desired setting.

The setting is stored for the driver profile currently used.

This configuration is retrieved when the SPORT driving mode is activated.

## COMFORT

### Concept

For balanced tuning.

### Activating COMFORT



Press the button repeatedly until COMFORT is displayed in the instrument cluster.

## ECO PRO

### Concept

ECO PRO, refer to page 232, provides consistent tuning to maximize range.

### Activating ECO PRO



Press the button repeatedly until ECO PRO is displayed in the instrument cluster.

## Configuring ECO PRO

Via iDrive:

1. "My Vehicle"
2. "Vehicle settings"
3. If necessary, "Driving mode"
4. "Configure ECO PRO"
5. Select the desired setting.

The setting is stored for the driver profile currently used.

## Displays

### Program selection

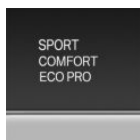

Pressing the button displays a list of the selectable programs. Depending on your vehicle's optional features, the list in the instrument cluster can differ from the illustration shown.

### Selected program

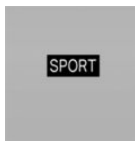

The instrument cluster displays the selected program.

## Drive-off assistant

### Concept

This system supports driving off on uphill grades. The parking brake is not required.

### Driving off with the drive-off assistant

1. Hold the vehicle in place with the foot brake.
2. Release the foot brake and drive off without delay.

After the foot brake is released, the vehicle is held in place for approx. 2 seconds.

Depending on the vehicle load or when a trailer is used, the vehicle may roll back slightly.

# Driving comfort

## Vehicle features and options

This chapter describes all standard, country-specific and optional features offered with the series. It also describes features that are not necessarily available in your vehicle, e. g., due to the selected options or country versions. This also applies to safety-related functions and systems. When using these functions and systems, the applicable laws and regulations must be observed.

## Camera-based cruise control with Stop&Go function, ACC

### Concept

Using this system, a desired speed and a distance to a vehicle ahead can be adjusted using the buttons on the steering wheel.

The system maintains the desired speed on clear roads. For this purpose, the vehicle accelerates or brakes automatically.

If a vehicle is driving ahead of you, the system adjusts the speed of your vehicle so that the set distance to the vehicle ahead is maintained. The speed is adjusted as far as the given situation allows.

The distance can be adjusted in several steps. For safety reasons, it depends on the respective speed.

If the vehicle ahead of you brakes to a halt, and then proceeds to drive again within a brief period, the system is able to detect this within the given system limits.

## General information

A camera on the interior mirror is used to detect vehicles driving ahead.

Depending on the driving settings, the features of the cruise control can change in certain areas.

## Safety information

### WARNING

The system cannot serve as a substitute for the driver's personal judgment in assessing the traffic situation. Based on the limits of the system, it cannot independently react to all traffic situations. There is a risk of an accident. Adjust driving style to traffic conditions. Watch traffic closely and actively intervene where appropriate.

### WARNING

An unsecured vehicle can begin to move and possibly roll away. There is a risk of an accident. Before exiting, secure the vehicle against rolling.

In order to ensure that the vehicle is secured against rolling away, follow the following:

- ▷ Set the parking brake.
- ▷ On uphill grades or on a downhill slope, turn the front wheels in the direction of the curb.
- ▷ On uphill grades or on a downhill slope, also secure the vehicle, for instance with a wheel chock.



**WARNING**

The desired speed can be incorrectly adjusted or called up by mistake. There is a risk of an accident. Adjust the desired speed to the traffic conditions. Watch traffic closely and actively intervene where appropriate.

**WARNING**

Risk of accident due to too high speed differences to other vehicles, for instance in the following situations:

- ▷ When fast approaching a slowly moving vehicle.
- ▷ Vehicle suddenly swerving into own lane.
- ▷ When fast approaching standing vehicles.

There is a risk of injuries or danger to life. Watch traffic closely and actively intervene where appropriate.

**Overview**

**Buttons on the steering wheel**

**Button Function**



Cruise control on/off, refer to page 176.



Store/maintain speed, refer to page 177.



Pause cruise control, refer to page 176.  
Continue cruise control with the last setting, refer to page 178.



Reduce distance, refer to page 178.

**Button Function**



Increase distance, refer to page 178.



Rocker switch.  
Set speed, refer to page 177.

**Camera**

A camera in the area of the interior mirror serves to detect vehicles.

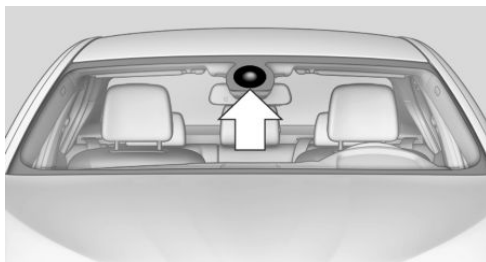

Keep the windshield in front of the interior mirror clean and clear.

**Functional requirements**

**Speed range**

The system is best used on well-constructed roads.

The desired speed can be set between 20 mph/30 km/h and 85 mph/140 km/h.

The system can also be activated when stationary.

**Switching on/off and interrupting cruise control**

**Switching on**



Press the button on the steering wheel.

The indicator lights in the instrument cluster light up and the mark in the speedometer is set to the current speed.

Cruise control is active and maintains the set speed.

DSC Dynamic Stability Control is switched on, if necessary.

## Switching off

To switch off the system while standing, step on brake pedal at the same time.



Press the button on the steering wheel.

The displays go out. The stored desired speed is deleted.

## Interrupting manually



Press the button on the steering wheel.

If interrupting the system while stationary, press on the brake pedal at the same time.

## Interrupting automatically

The system is automatically interrupted in the following situations:

- ▶ When the driver applies the brakes.
- ▶ When selector lever position D is disengaged.
- ▶ When Dynamic Traction Control DTC is activated.
- ▶ If DSC Dynamic Stability Control intervenes.
- ▶ If the safety belt is unbuckled and the driver's door is opened while the vehicle is standing still.
- ▶ If the detection range of the camera is impaired, for instance by soiling, heavy precipitation or glare effects from the sun.
- ▶ After a stationary period of approx. 3 seconds when the vehicle has been braked to a stop by the system.

## Setting the speed

### Maintaining/storing the speed

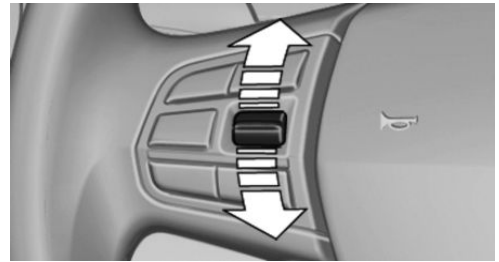

Press the rocker switch up or down once while the system is interrupted.

When the system is switched on, the current speed is maintained and stored as the desired speed.

The stored speed is displayed in the speedometer and briefly in the instrument cluster, refer to page 179.

DSC Dynamic Stability Control is switched on, if necessary.



The speed can also be stored by pressing a button.

Press the button.

### Changing the speed

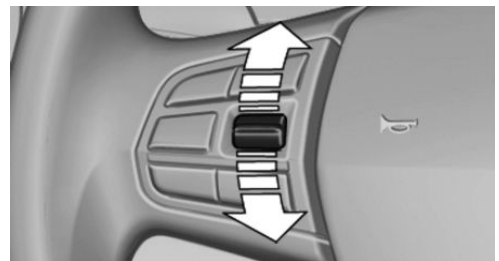

Press the rocker switch up or down repeatedly until the desired speed is set.

If active, the displayed speed is stored and the vehicle reaches the stored speed when the road is clear.



- ▷ Each time the rocker switch is pressed to the point of resistance, the desired speed increases or decreases by approx. 1 mph/1 km/h.
- ▷ Each time the rocker switch is pressed past the resistance point, the desired speed changes by a maximum of 5 mph/10 km/h.

Hold the rocker switch in position to repeat the action.

## Adjusting distance

### Safety information

#### WARNING

The system cannot serve as a substitute for the driver's personal judgment. Due to the system limits, braking can be late. There is a risk of accidents or risk of damage to property. Be aware to the traffic situation at all times. Adjust the distance to the traffic and weather conditions and maintain the prescribed safety distance, possibly by braking.

### Without Traffic Jam Assist: reducing distance



Press the button repeatedly until the desired distance is set.



The instrument cluster displays the set distance.

### Without Traffic Jam Assist: increasing distance



Press the button repeatedly until the desired distance is set.



The instrument cluster displays the set distance.

## Continuing cruise control

### General information

An interrupted cruise control can be continued by calling up the stored speed.

Make sure that the difference between current speed and stored speed is not too large before calling up the stored speed. Otherwise, unintentional braking or accelerating may occur.

In the following cases, the stored speed value is deleted and cannot be called up again:

- ▷ When the system is switched off.
- ▷ When the ignition is switched off.

### Calling up stored speed and distance



Press the button with the system interrupted. Cruise control is continued with the stored values. The selected speed is briefly displayed in the Info Display.

## Switching distance control on/off

### Safety information

#### WARNING

The system does not react to traffic driving ahead of you, but instead maintains the stored speed. There is a risk of accidents or risk of damage to property. Adjust the desired speed to the traffic conditions and brake as needed.

### Switching distance control off

Distance control can be switched off and on when driving with cruise control activated.



Press and hold this button, or



Press and hold this button.



The indicator light in the instrument cluster lights up.

To switch distance control back on, press button again briefly.

After changing over distance control, a Check Control message is displayed.

## Displays in the instrument cluster

### Desired speed and stored speed



- ▶ Marking lights up green: system is active, the marking indicates the desired speed.
- ▶ Marking lights up orange: system is interrupted, the marking indicates the stored speed.
- ▶ The marking does not light up: the system is switched off.

### Brief status display



Selected desired speed.

If no speed is indicated, it is possible that the conditions necessary for operation are not currently fulfilled.

### Distance to vehicle ahead of you

Selected distance to the vehicle ahead of you is shown.

#### Distance display



Distance 1



Distance 2

#### Distance display



Distance 3



Distance 4

This value is set automatically after the system is switched on.

### Detected vehicle



Symbol lights up orange:

A vehicle has been detected ahead of you.



Rolling bars: the detected vehicle has driven away.

ACC does not accelerate. To accelerate, activate ACC by briefly stepping on the accelerator pedal or pressing the RES CNCL button or the rocker switch.

### Indicator/warning lights



Symbol flashes orange:

The conditions are not adequate for the system to work.

The system was deactivated but applies the brakes until you actively resume control by pressing on the brake pedal or accelerator pedal.



Symbol flashes red and a signal sounds:

You are prompted to intervene by braking or making an evasive maneuver.



The system has been interrupted or distance control is temporarily suppressed because the accelerator pedal is being pressed; a vehicle was not detected.



Distance control is temporarily suppressed because the accelerator pedal is being pressed; a vehicle was detected.

## Displays in the Head-up Display

Some system information can also be displayed in the Head-up Display.

## System limits

### Detection range

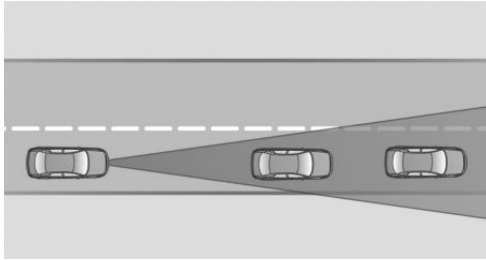

The detection capacity of the system and the automatic braking capacity are limited.

Two-wheeled vehicles for instance might not be detected.

### Deceleration

The system does not decelerate in the following situations:

- ▷ For pedestrians, cyclists or similarly slow-moving road users.
- ▷ For red traffic lights.
- ▷ For cross traffic.
- ▷ For oncoming traffic.
- ▷ Unlit vehicles or vehicles with nonworking lighting at night.

## Swerving vehicles

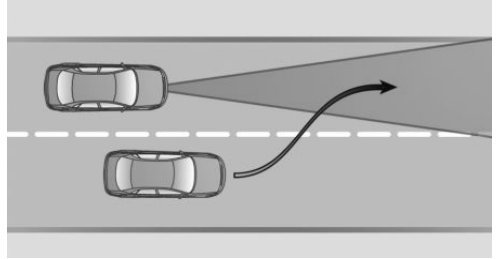

A vehicle driving in front of you is not detected until it is completely within the same lane as your vehicle.

If a vehicle driving ahead of you suddenly swerves into your lane, the system may not be able to automatically restore the selected distance. It may not be possible to restore the selected distance in certain situations, including if you are driving significantly faster than vehicles driving ahead of you, for instance when rapidly approaching a truck. When a vehicle driving ahead of you is reliably detected, the system requests that the driver intervene by braking and carrying out evasive maneuvers, if needed.

## Cornering

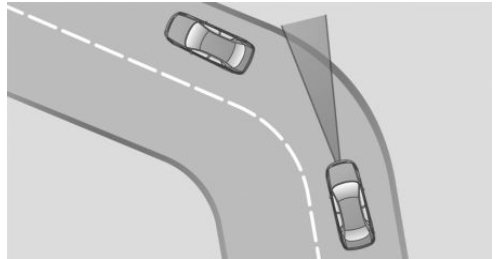

If the desired speed is too high for a curve, the speed is reduced slightly, although curves cannot be anticipated in advance. Therefore, drive into a curve at an appropriate speed.

The system has a limited detection range. Situations can arise in tight curves where a vehicle driving ahead will not be detected or will be detected very late.

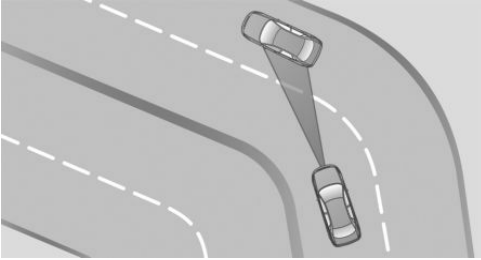

When you approach a curve the system may briefly report vehicles in the next lane due to the bend of the curve. If the system decelerates you may compensate it by briefly accelerating. After releasing the accelerator pedal the system is re-activated and controls speed independently.

### Driving off

In some situations, the vehicle cannot drive off automatically; for example:

- ▶ On steep uphill grades.
- ▶ From bumps in the road.

In these cases, press on the accelerator pedal.

### Weather

The following restrictions can occur under unfavorable weather or light conditions:

- ▶ Poorer vehicle recognition.
- ▶ Short-term interruptions for vehicles that are already recognized.

Examples of unfavorable weather or light conditions:

- ▶ Wet conditions.
- ▶ Snowfall.
- ▶ Slush.
- ▶ Fog.
- ▶ Glare.

Drive attentively, and react to the current traffic situation. If necessary, intervene actively, for instance by braking, steering or evading.

### Engine power

The desired speed may not be maintained on uphill grades if engine power is insufficient.

### Malfunction

A Check Control message is displayed if the system fails or was automatically deactivated.

The system may not be fully functional in the following situations:

- ▶ When an object was not correctly detected.
- ▶ In heavy fog, rain, sprayed water or snowfall.
- ▶ In tight curves.
- ▶ If the field of view of the camera or the windshield are dirty or covered.
- ▶ When driving toward bright lights.
- ▶ Up to 20 seconds after the start of the engine, via the Start/Stop button.
- ▶ During calibration of the camera immediately after vehicle delivery.

## Cruise control

### Concept

Using this system, a desired speed can be adjusted using the buttons on the steering wheel. The system maintains the desired speed. The system accelerates and brakes automatically as needed.

### General information

Depending on the driving settings, the features of the cruise control can change in certain areas.

### Safety information

#### **WARNING**

The system cannot serve as a substitute for the driver's personal judgment in assessing the traffic situation. Based on the limits of the system, it cannot independently react to all traffic

situations. There is a risk of an accident. Adjust driving style to traffic conditions. Watch traffic closely and actively intervene where appropriate.

**WARNING**

The use of the system can lead to an increased risk of accidents in the following situations, for instance:

- ▷ On winding roads.
- ▷ In heavy traffic.
- ▷ On slippery roads, in fog, snow, or wet conditions, or on a loose road surface.



There is a risk of accidents or risk of damage to property. Only use the system if driving at constant speed is possible.

**WARNING**



The desired speed can be incorrectly adjusted or called up by mistake. There is a risk of an accident. Adjust the desired speed to the traffic conditions. Watch traffic closely and actively intervene where appropriate.

**Overview**

**Buttons on the steering wheel**

Button	Function
	Cruise control on/off, refer to page 182.
	Store speed, refer to page 183.

**Button Function**

	Pause cruise control, refer to page 182. Continue cruise control with the last setting, refer to page 183.
	Rocker switch: Set speed, refer to page 183.

**Switching on/off and interrupting cruise control**

**Switching on**

 Press the button on the steering wheel.

The marking in the speedometer is set to the current speed.

Cruise control is active and maintains the set speed.

DSC Dynamic Stability Control is switched on, if necessary.

**Switching off**

 Press the button on the steering wheel.

The displays go out. The stored desired speed is deleted.

**Interrupting manually**

 When active, press the button on the steering wheel.

**Interrupting automatically**

The system is automatically interrupted in the following situations:

- ▷ When the driver applies the brakes.
- ▷ If the clutch pedal is depressed for a few seconds or released while a gear is not engaged.
- ▷ If the gear engaged is too high for the current speed.

- ▷ If selector lever position N is set.
- ▷ Dynamic Traction Control DTC is activated or DSC Dynamic Stability Control is deactivated.
- ▷ If DSC Dynamic Stability Control intervenes.

## Setting the speed

### Maintaining/storing the speed

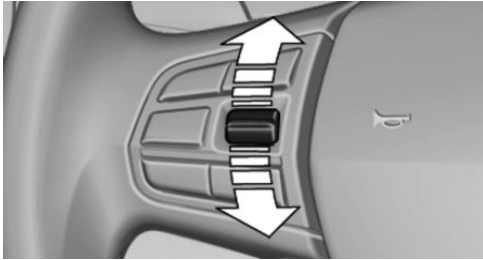

Press the rocker switch up or down once while the system is interrupted.

When the system is switched on, the current speed is maintained and stored as the desired speed.

The stored speed is displayed in the speedometer and in the instrument cluster, refer to page 184.

DSC Dynamic Stability Control is switched on, if necessary.

The speed can also be stored by pressing a button.



Press the button.

### Changing the speed

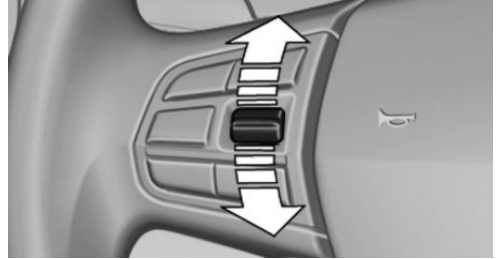

Press the rocker switch up or down repeatedly until the desired speed is set.

If active, the displayed speed is stored and the vehicle reaches the stored speed when the road is clear.

- ▷ Each time the rocker switch is pressed to the point of resistance, the desired speed increases or decreases by approx. 1 mph/1 km/h.
- ▷ Each time the rocker switch is pressed past the point of resistance, the desired speed increases or decreases by a maximum of 5 mph/10 km/h.
- ▷ Pressing the rocker switch to the resistance point and holding it accelerates or decelerates the vehicle without requiring pressure on the accelerator pedal.

After the rocker switch is released, the vehicle maintains its final speed. Pressing the switch beyond the resistance point causes the vehicle to accelerate more rapidly.

### Continuing cruise control

#### General information

An interrupted cruise control can be continued by calling up the stored speed.

Make sure that the difference between current speed and stored speed is not too large before calling up the stored speed. Otherwise, unintentional braking or accelerating may occur.

In the following cases, the stored speed value is deleted and cannot be called up again:





- ▷ When the system is switched off.
- ▷ When the ignition is switched off.

## Calling up stored speed



Press the button on the steering wheel.

The stored speed is reached again and maintained.

## Displays in the instrument cluster

### Indicator light



Depending on how the vehicle is equipped, the indicator light in the instrument cluster indicates whether the system is switched on.

### Desired speed and stored speed

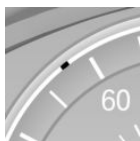

- ▷ Marking lights up green: system is active, the marking indicates the desired speed.
- ▷ Marking lights up orange: system is interrupted, the marking indicates the stored speed.

- ▷ The marking does not light up: the system is switched off.

### Status display



Selected desired speed.

If no speed is indicated, it is possible that the conditions necessary for operation are not currently fulfilled.

## Displays in the Head-up Display

Some system information can also be displayed in the Head-up Display.

## System limits

### Engine power

The desired speed is also maintained downhill, but may not be maintained on uphill grades if engine power is insufficient.

## PDC Park Distance Control

### Concept

PDC is a support when parking. The system detects objects behind the vehicle. If the vehicle is equipped with front PDC, objects in front of the vehicle are detected too. Objects that you are approaching slowly are indicated by signal tones and a display on the Control Display.

### General information

The ultrasound sensors for measuring the distances are located in the bumpers.

The maneuvering range, depending on the obstacle and environmental conditions, is approx. 6 ft/2 m.

An acoustic warning is first given in the following situations:

- ▷ By the front sensors and the two rear corner sensors at approx. 24 in/60 cm from the object.
- ▷ By the rear middle sensors at a distance to the object of approx. 5 ft/1.50 m.
- ▷ When a collision is imminent.

## Safety information

### WARNING

The system cannot serve as a substitute for the driver's personal judgment in assessing the traffic situation. Based on the limits of the system, it cannot independently react to all traffic situations. There is a risk of an accident. Adjust driving style to traffic conditions. Watch traffic

closely and actively intervene where appropriate.

### **WARNING**

Due to high speeds when PDC Park Distance Control is activated, the warning can be delayed due to physical circumstances. There is a risk of injury or risk of damage to property. Avoid approaching an object too fast. Avoid driving off fast while PDC Park Distance Control is not yet active.

## Overview

### With front PDC: button in vehicle



Park assistance button

### Ultrasound sensors



Ultrasound sensors of the PDC, for instance in the bumpers.

## Functional requirements

Ensure full functionality:

- ▶ Do not cover sensors, for instance with stickers, bicycle racks.
- ▶ Keep the sensors clean and unobstructed.

## Switching on/off

### Switching on automatically

The system switches on automatically in the following situations:

- ▶ If selector lever position R is engaged when the engine is running.  
The rearview camera also switches on.
- ▶ If equipped with front PDC: when obstacles are detected behind or in front of the vehicle by PDC and the speed is slower than approx. 2.5 mph/4 km/h.

You may switch automatic activation on and off when obstacles are detected. Via iDrive:

1. "My Vehicle"
2. "Vehicle settings"
3. "Parking"
4. "Automatic PDC activation": depending on the vehicle equipment.
5. "Automatic PDC activation"  
The setting is stored for the driver profile currently used.

If necessary, switch off automatic PDC activation on obstacle detection, for instance in vehicle washes, to reduce false alarms.

### Automatic deactivation during forward travel

The system switches off when a certain driving distance or speed is exceeded.

Switch the system back on, if needed.

### With front PDC: switching on/off manually



Press park assistance button.

- ▶ On: the LED lights up.
- ▶ Off: the LED goes out.

The rearview camera image is displayed if the reverse gear is engaged when pressing the park assistance button.

## WARNING

### Signal tones

An intermittent tone indicates when the vehicle is approaching an object. E.g., if an object is detected to the left rear of the vehicle, a signal tone sounds from the left rear speaker.

The shorter the distance to the object, the shorter the intervals.

If the distance to a detected object is less than approx. 10 inches/25 cm, a continuous tone is sounded.

With front PDC: if objects are simultaneously located both in front of and behind the vehicle, an alternating continuous signal is sounded.

The signal tone is switched off, when selector lever position P is engaged on vehicles with Steptronic transmission.

### Volume

The ratio of the PDC signal tone volume to the entertainment volume can be adjusted.

Via iDrive:

1. "My Vehicle"
2. "iDrive settings"
3. "Tone"
4. "Volume settings"
5. "PDC"
6. Set the desired value.

The setting is stored for the driver profile currently used.

## Visual warning



The approach of the vehicle to an object is shown on the Control Display. Objects that are farther away are already displayed on the Control Display before a signal sounds.

A display appears as soon as Park Distance Control (PDC) is activated.

The range of the sensors is represented in the colors green, yellow and red.

When the image of the rearview camera is displayed, the switch can be made to PDC:

1. Move the Controller to the left, if needed.
2.  "Rear view camera"

## System limits

### Safety information

#### **WARNING**

The system can react not at all, too late, incorrectly, or without justification due to the system limits. There is a risk of accidents or risk of damage to property. Follow the information regarding the system limits and actively intervene if needed.

### Limits of ultrasonic measurement

Ultrasonic measurements might not function in the following situations:

- ▶ For small children and animals.



- ▶ For persons with certain clothing, for instance coats.
- ▶ With external interference of the ultrasound, for instance from passing vehicles or loud machines.
- ▶ When sensors are dirty, iced over, damaged or out of position.
- ▶ Under certain weather conditions such as high relative humidity, wet conditions, snow-fall, extreme heat, or strong wind.
- ▶ With tow bars and trailer couplings of other vehicles.
- ▶ With thin or wedge-shaped objects.
- ▶ With moving objects.
- ▶ With elevated, protruding objects such as ledges or cargo.
- ▶ With objects with corners and sharp edges.
- ▶ With objects with a fine surface structure such as fences.
- ▶ For objects with porous surfaces.
- ▶ If cargo protrudes.
- ▶ Low objects already displayed, for instance curbs, can move into the blind area of the sensors before or after a continuous tone sounds.

## False warnings

The system may issue a warning under the following conditions even though there is no obstacle within the detection range:

- ▶ In heavy rain.
- ▶ When sensors are very dirty or covered with ice.
- ▶ When sensors are covered in snow.
- ▶ On rough road surfaces.
- ▶ On uneven surfaces, such as speed bumps.
- ▶ In large buildings with right angles and smooth walls, for instance in underground garages.
- ▶ In automatic vehicle washes.

- ▶ Due to heavy exhaust.
- ▶ Due to other ultrasound sources, for instance sweeping machines, high pressure steam cleaners or neon lights.

The malfunction is signaled by a continuous tone alternating between the front and rear speakers.

As soon as the malfunction due to other ultrasound sources is no longer present, the system is again fully functional.

To prevent false alarms, switch off automatic PDC activation on obstacle detection, for instance in automatic vehicle washes.

## Malfunction

A Check Control message is displayed.

The range of the sensors is shown as a shaded area on the Control Display.

PDC has failed. Have the system checked by a dealer's service center or another qualified service center or repair shop.

## Rearview camera

### Concept

The rearview camera provides assistance in parking and maneuvering backwards. The area behind the vehicle is shown on the Control Display.

### Safety information

#### WARNING

The system cannot serve as a substitute for the driver's personal judgment in assessing the traffic situation. There is a risk of an accident. Adjust driving style to traffic conditions. Watch traffic and vehicle surroundings closely and actively intervene where appropriate.

## Overview

### Depending on the vehicle equipment: button in the vehicle



 Park assistance button

## Camera

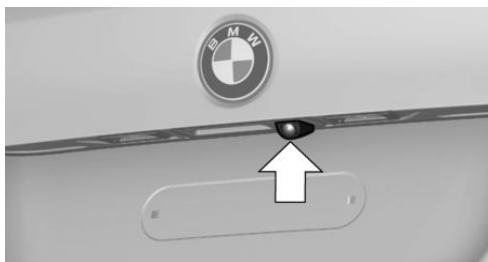

The camera lens is located in the handle of the tailgate.

The image quality may be impaired by dirt. If necessary, clean the camera lens.

## Switching on/off

### Switching on automatically

The system is switched on automatically if selector lever position R is engaged when the engine is running.

### Automatic deactivation during forward travel

The system switches off when a certain driving distance or speed is exceeded.

Switch the system back on, if needed.

### Depending on the vehicle equipment: switching on/off manually

 Press park assistance button.

- ▷ On: the LED lights up.
- ▷ Off: the LED goes out.

The parking assistance functions are shown on the Control Display.

### Switching the view via iDrive

If the rearview camera view is not displayed, change the view via iDrive:

1. Move the Controller to the left, if needed.
2.  "Rear view camera"

The rearview camera image is displayed.

## Display on the Control Display



### Functional requirement

- ▷ The rearview camera is switched on.
- ▷ The tailgate is fully closed.
- ▷ Keep the recording range of the camera clear. Protruding cargo or carrier systems and trailers that are not connected to a trailer power socket can lead to malfunctions.

### Activating assistance functions

More than one assistance function can be active at the same time.

Move the Controller to the left, if needed.

- ▷ Parking aid lines
  -  "Parking aid lines"  
Lanes and turning radius are indicated.
- ▷ Obstacle marking
  -  "Obstacle marking"  
Obstacles are marked, depending on the vehicle equipment.

## Pathway lines

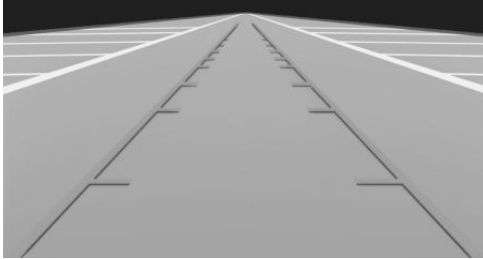

Pathway lines can be superimposed on the image of the rearview camera.

Pathway lines help you to estimate the space required when parking and maneuvering on level roads.

Pathway lines depend on the current steering angle and are continuously adjusted to the steering wheel movements.

## Turning radius lines

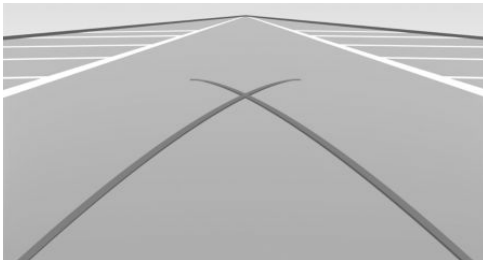

Turning radius lines can only be superimposed on the rearview camera image together with pathway lines.

Turning radius lines show the course of the smallest possible turning radius on a level road.

Only one turning radius line is displayed after the steering wheel is turned past a certain angle.

## Obstacle marking

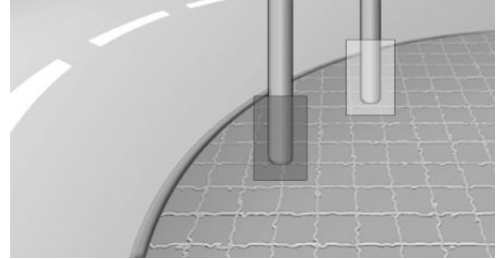

Depending on the vehicle equipment, obstacle markings can be faded into the image of the rearview camera.

The colored thresholds of the obstacle markings match the markings of the PDC Park Distance Control.

## Parking using pathway and turning radius lines

1. Position the vehicle so that the turning radius lines lead to within the limits of the parking space.

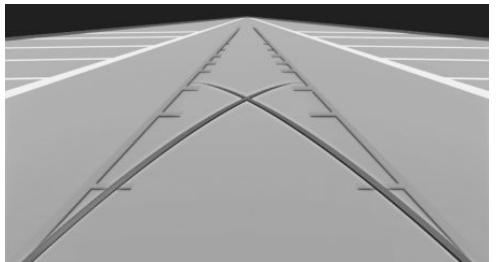

2. Turn the steering wheel to the point where the pathway line covers the corresponding turning radius line.

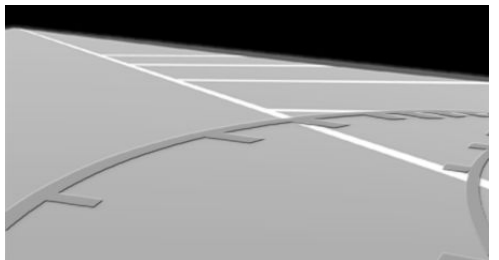

## Display settings

### Brightness

With the rearview camera switched on:

1. Move the Controller to the left, if needed.
2. ☀️: Select the symbol.
3. Turn the Controller until the desired setting is reached, and press the Controller.

### Contrast

With the rearview camera switched on:

1. Move the Controller to the left, if needed.
2. 🗨️: Select the symbol.
3. Turn the Controller until the desired setting is reached, and press the Controller.

## System limits

### Detection of objects

Very low obstacles as well as high, protruding objects such as ledges may not be detected by the system.

Depending on the vehicle equipment, some assistance functions also consider data from the PDC Park Distance Control.

Follow the notes in the PDC Park Distance Control chapter.

The objects displayed on the Control Display may be closer than they appear. Do not estimate the distance from the objects on the display.

## Parking assistant

### Concept

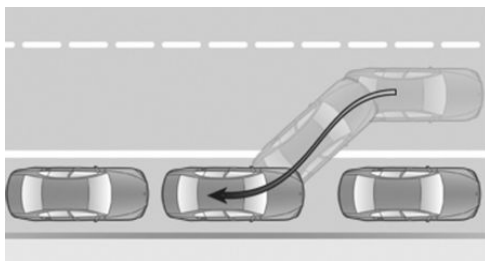

This system assists the driver in parking parallel to the road.

### General information

Parking assistant handling is divided into three steps:

- ▷ Switching on and activating.
- ▷ Parking space search.
- ▷ Parking.

System status and instructions on required actions are displayed on the Control Display.

Ultrasound sensors measure parking spaces on both sides of the vehicle.

The parking assistant calculates the best possible parking line and takes control of steering during the parking procedure.

The parking assistant uses the sensors of PDC Park Distance Control. Also follow the safety information for PDC Park Distance Control.

### Safety information

#### ⚠️ WARNING

The system cannot serve as a substitute for the driver's personal judgment in assessing the traffic situation. Based on the limits of the system, it cannot independently react to all traffic situations. There is a risk of an accident. Adjust driving style to traffic conditions. Watch traffic

closely and actively intervene where appropriate.

### NOTICE

The parking assistant can steer the vehicle over or onto curbs. There is a risk of damage to property. Watch traffic closely and actively intervene where appropriate.

Also follow the safety information for PDC Park Distance Control.

## Overview

### Button in the vehicle



 Park assistance button

### Ultrasound sensors

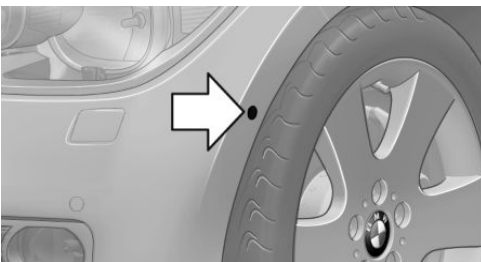

The ultrasound sensors for measuring parking spaces are located on the side of the vehicle.

## Functional requirements

### Ultrasound sensors

Ensure full functionality:

- ▷ Do not cover sensors, for instance with stickers.
- ▷ Keep the sensors clean and unobstructed.

### For measuring parking spaces

- ▷ Maximum speed while driving forward approx. 22 mph/35 km/h.
- ▷ Maximum distance to row of parked vehicles: 5 ft/1.5 m.

### Suitable parking space

- ▷ Gaps behind an object that has a min. length of 5 ft/1.5 m.
- ▷ Gap between two objects with a minimum length of approx. 5 ft/1.5 m.
- ▷ Min. length of gap between two objects: your vehicle's length plus approx. 3.3 ft/1.0 m.
- ▷ Minimum depth: approx. 5 ft/1.5 m.

### For parking

- ▷ Doors and tailgate closed.
- ▷ Parking brake released.
- ▷ When parking in parking spaces on the driver's side, the corresponding turn signal must be switched on.

## Switching on and activating

### Switching on with the button

-  Press park assistance button.  
The LED lights up.

The current status of the parking space search is indicated on the Control Display.

-  Parking assistant is activated automatically.



## Switching on with reverse gear



Shift into reverse.

The current status of the parking space search is indicated on the Control Display.

To activate:  "Parking Assistant"

## Display on the Control Display

### System activated/deactivated

Symbol	Meaning
	Gray: the system is not available. White: the system is available but not activated.
	The system is activated.



## Parking space search and system status



- ▷ Symbol P on the vehicle image: the parking assistant is activated and the parking space search is active.
- ▷ Control Display shows suitable parking spaces at the edge of the road next to the vehicle symbol. When the parking assistant is active, suitable parking spaces are highlighted.
- ▷  The parking procedure is active. Steering control has been taken over by system.
- ▷ Parking space search is always active whenever the vehicle is moving forward slow and

straight, even if the system is deactivated. When the system is deactivated, the displays on the Control Display are shown in gray.

## Parking using the parking assistant

1.  Press the park assistance button or shift into reverse gear to switch on the parking assistant, refer to page 191. Activate the parking assistant, if needed.
  -  Parking assistant is activated.
2. Pass the row of parked vehicles at a speed of up to approx. 22 mph/35 km/h and at a distance of maximum 5 ft/1.5 m.
 



The status of the parking space search and possible parking spaces are displayed, refer to page 192, on the Control Display.
3. Follow the instructions on the display.
 

The best possible parking position will come after gear change on the stationary vehicle - wait for the automatic steering wheel move.

The end of the parking procedure is indicated on the display.
4. Adjust the parking position yourself, if needed.

## Interrupting manually

The parking assistant can be interrupted at any time:

- ▷  "Parking Assistant" Select the symbol on the Control Display.
- ▷  Press park assistance button.

## Interrupting automatically

The system is interrupted automatically in the following situations:

- ▷ If the driver grasps the steering wheel or takes over steering.
- ▷ If a gear is selected that does not match the instruction on the display.

- ▷ If the vehicle speed exceeds approx. 6 mph/10 km/h.
- ▷ Possibly on snow-covered or slippery road surfaces.
- ▷ If a maximum number of parking attempts or the time taken for parking is exceeded.
- ▷ If the PDC Park Distance Control displays clearances that are too small.
- ▷ When switching to another function on the Control Display.

A Check Control message is displayed.

## Resuming

An interrupted parking procedure can be continued, if needed.

Reactivate the parking assistant, refer to page 191, and follow the instructions on the display.

## Switching off

The system can be switched off as follows:

- ▷  Press park assistance button.
- ▷ Switching off the ignition.

## System limits

### Safety information

#### **WARNING**

The system can react not at all, too late, incorrectly, or without justification due to the system limits. There is a risk of accidents or risk of damage to property. Follow the information regarding the system limits and actively intervene if needed.

### No parking assistance

The parking assistant does not offer assistance in the following situations:

- ▷ In tight curves.

## Functional limitations

The system may not be fully functional in the following situations:

- ▷ On bumpy road surfaces such as gravel roads.
- ▷ On slippery ground.
- ▷ On steep uphill or downhill grades.
- ▷ With accumulations of leaves/snow in the parking space.
- ▷ With a mounted emergency wheel.
- ▷ With ditches or edges, for instance an edge of a port.

## Limits of ultrasonic measurement

Ultrasonic measurements might not function in the following situations:

- ▷ For small children and animals.
- ▷ For persons with certain clothing, for instance coats.
- ▷ With external interference of the ultrasound, for instance from passing vehicles or loud machines.
- ▷ When sensors are dirty, iced over, damaged or out of position.
- ▷ Under certain weather conditions such as high relative humidity, wet conditions, snow-fall, extreme heat, or strong wind.
- ▷ With tow bars and trailer couplings of other vehicles.
- ▷ With thin or wedge-shaped objects.
- ▷ With moving objects.
- ▷ With elevated, protruding objects such as ledges or cargo.
- ▷ With objects with corners and sharp edges.
- ▷ With objects with a fine surface structure such as fences.
- ▷ For objects with porous surfaces.
- ▷ If cargo protrudes.
- ▷ Low objects already displayed, for instance curbs, can move into the blind area of the



sensors before or after a continuous tone sounds.

Parking spaces that are not suitable may be detected or suitable parking spaces may not be detected at all.

## Tire size

The parking position may vary depending on the tire size.

## Malfunction

A Check Control message is displayed.

The parking assistant failed. Have the system checked by a dealer's service center or another qualified service center or repair shop.

# Climate control

## Vehicle features and options

This chapter describes all standard, country-specific and optional features offered with the series. It also describes features that are not necessarily available in your vehicle, e. g., due to the selected options or country versions. This also applies to safety-related functions and systems. When using these functions and systems, the applicable laws and regulations must be observed.

- ▷ Emission tested car's interior.
- ▷ Microfilter.
- ▷ Air conditioning system to control the temperature, air flow and recirculated-air mode.

Depending on the equipment specification:

- ▷ Microfilter/activated-charcoal filter.
- ▷ Automatic recirculated-air control AUC.
- ▷ Parked-car ventilation.

## Interior air quality

The air quality in the vehicle is improved by the following components:

## Air conditioner

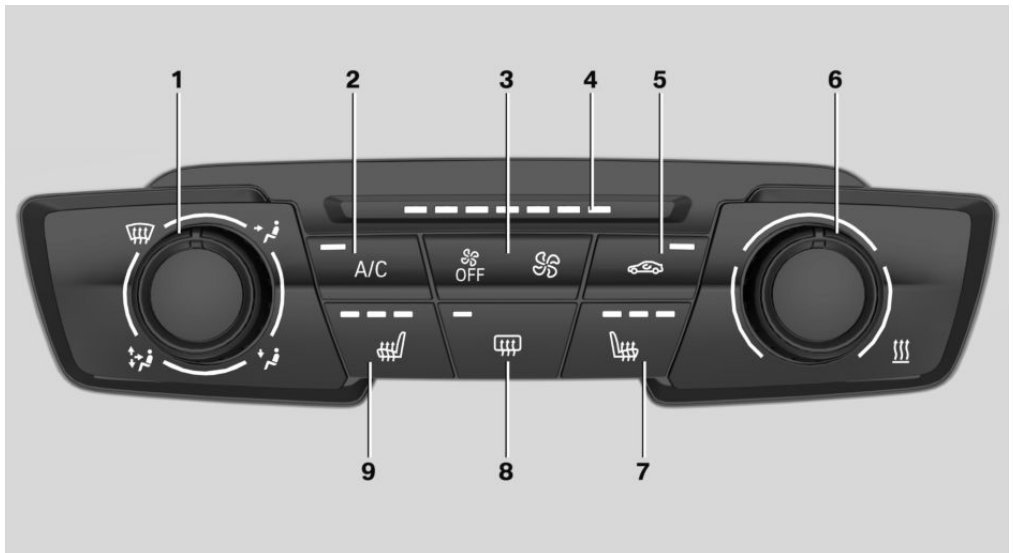

1 Air distribution settings

2 Air conditioning

- 3 Air flow
- 4 Air flow display
- 5 Recirculated-air mode
- 6 Temperature

- 7 Seat heating, right 91
- 8 Rear window defroster
- 9 Seat heating, left 91

## Climate control functions in detail

### Switching the system on/off

#### Switching on

Press any button except for the following:

- ▷ Rear window defroster.
- ▷ Seat heating.

#### Switching off



Press and hold the left button until the control switches off.

## Temperature

#### Concept

The system heats or cools, depending on the set temperature.

#### Settings



Turn the ring to set the desired temperature.

Do not rapidly switch between different temperature settings. Otherwise, the automatic climate control will not have sufficient time to adjust the set temperature.

## Air conditioning

#### Concept

The air in the car's interior will be cooled and dehumidified and, depending on the temperature setting, warmed again.

The car's interior can only be cooled with the engine running.

#### Switching on/off



Press the button.

The LED is illuminated with air conditioning switched on.

Depending on the weather, the windshield and side windows may fog up briefly when the engine is started.

The air conditioner produces condensation water, refer to page 227, that will exit from below the vehicle.

## Recirculated-air mode

#### Concept

You may react to unpleasant odors or pollutants in the immediate environment by temporarily suspending the supply of outside air. The system then recirculates the air flow within the vehicle.

#### Operation



Press button repeatedly to select an operating mode:

- ▷ LED off: outside air flows in continuously.
- ▷ LED on, recirculated-air mode: the supply of outside air into the vehicle is permanently blocked.

To prevent window fogging, recirculated-air mode switches off automatically after a certain amount of time, depending on the environmental conditions.

With constant recirculated-air mode, the air quality in the car's interior deteriorates and the fogging of the windows increases.

If the windows fog over, switch off recirculated-air mode and increase the air flow, if needed.

## Controlling the air flow manually

### Concept

The air flow for climate control can be adjusted manually.

### Operation



Press the left or right side of the button: decrease or increase air flow.

The intensity is indicated by LEDs. The highest level is active when seven LEDs are lit.

The air flow from the air conditioner may be reduced automatically to save battery power.

## Controlling the air distribution manually





### Concept

The air distribution for climate control can be adjusted manually.

### Operation



Turn the wheel to select the desired program or the desired intermediate setting.

- ▷  Windows.
- ▷  Upper body region.
- ▷  Floor area.
- ▷  Windows, upper body region, and floor area.

## Defrosting windows and removing condensation

Make the following settings to defrost the windows and remove condensation:

- ▷ Direct the air distribution onto the windows.
- ▷ Increasing the air flow.
- ▷ Increase the temperature.
- ▷ Switch on the air conditioning if needed.

## Rear window defroster



Press the button. The LED lights up.

The rear window defroster switches off automatically after a certain period of time.

For permanent activation, press the button for longer than 3 seconds. To deactivate, press the button again.

The rear window defroster can only be activated continuously at an external temperature below approx. 23 °F/-5 °C.

## Microfilter

In external and recirculated-air mode the microfilter filters dust and pollen from the air.

Have this filter changed during vehicle maintenance, refer to page 271.

## Automatic climate control

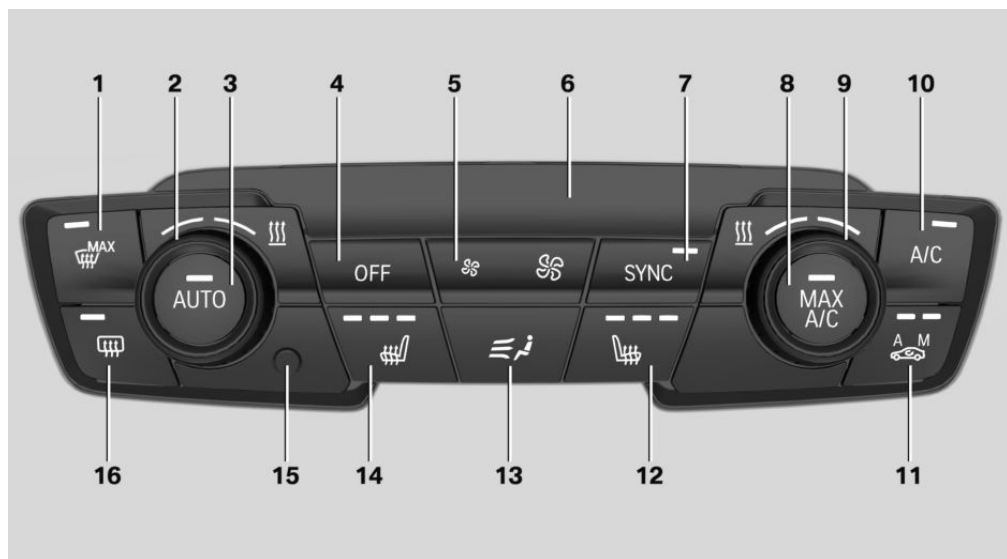

- |   |   |
|---|---|
| <ul style="list-style-type: none"> <li>1 Defrosting windows and removing condensation</li> <li>2 Temperature, left</li> <li>3 AUTO program</li> <li>4 Switching off the system</li> <li>5 Air flow, AUTO intensity</li> <li>6 Display</li> <li>7 SYNC program</li> <li>8 Maximum cooling</li> <li>9 Temperature, right</li> </ul> | <ul style="list-style-type: none"> <li>10 Air conditioning</li> <li>11 Automatic recirculated-air control/recirculated-air mode</li> <li>12 Seat heating, right <a href="#">91</a></li> <li>13 Air distribution settings</li> <li>14 Seat heating, left <a href="#">91</a></li> <li>15 Interior temperature sensor — always keep clear</li> <li>16 Rear window defroster</li> </ul> |
|---|---|

## Climate control functions in detail

### Switching the system on/off

#### Switching on

Press any button except for the following:

- ▷ SYNC program.
- ▷ Rear window defroster.

- ▷ Seat heating.

#### Switching off

 Press the button.

## Temperature

### Concept

The automatic climate control achieves the set temperature as quickly as possible, if necessary by using the maximum cooling or heating power, and then keeps it constant.

### Settings



Turn the ring to set the desired temperature.

The selected temperature is shown on the display of the automatic climate control.

The automatic climate control reaches this temperature as quickly as possible, if needed, by increasing the cooling or heating output, and then keeps it constant.

Do not rapidly switch between different temperature settings. Otherwise, the automatic climate control will not have sufficient time to adjust the set temperature.

## Air conditioning

### Concept

The air in the car's interior will be cooled and dehumidified and, depending on the temperature setting, warmed again.

The car's interior can only be cooled with the engine running.

### Switching on/off



Press the button.

The LED is illuminated with air conditioning switched on.

Depending on the weather, the windshield and side windows may fog up briefly when the engine is started.

The air conditioning is switched on automatically with the AUTO program.

When using the automatic climate control, condensation water, refer to page 227, develops and drains underneath the vehicle. This is normal.

## Maximum cooling

### Concept

The system is set to the lowest temperature, optimum air flow and recirculated-air mode.

### General information

The function is available above an external temperature of approx. 32 °F/0 °C And with the engine running.

### Switching on/off



Press the button.

The LED is illuminated with the system switched on.

Air flows out of the vents to the upper body region. The vents need to be open for this.

The air flow can be adjusted with the air flow active.

## AUTO program

### Concept

The AUTO program cools, ventilates or heats the car's interior automatically.

The air distribution and temperature are controlled automatically depending on the temperature in the car's interior and the desired temperature setting including the selected intensity of the air flow.

### Switching on/off



Press the button.

The LED is illuminated with the AUTO program switched on.



Depending on the selected temperature, the intensity of the AUTO program, and outside influences, the air is directed to the windshield, side windows, upper body, and into the floor area.

The air conditioning, refer to page 199, is switched on automatically with the AUTO program.

At the same time, a condensation sensor controls the program so as to prevent window condensation as much as possible.

**Intensity**

With the AUTO program switched on, the intensity can be set. This changes the automatic control for the air flow and air distribution.



Press the left or right side of the button: decrease or increase intensity.

The selected intensity is shown on the display of the automatic climate control.

**Automatic recirculated-air control/ recirculated-air mode**

**Concept**

The automatic recirculated-air control AUC recognizes odors or pollutants in the outside air. The outside air supply is shut off and the interior air is recirculated.

**General information**

If the system is activated, a sensor detects pollutants in the outside air and controls the shut-off automatically.

If the system is deactivated, outside air continuously flows into the car's interior.

With constant recirculated-air mode, the air quality in the car's interior deteriorates and the fogging of the windows increases.

**Switching on/off**



Press button repeatedly to select an operating mode:

- ▶ LEDs off: outside air flows in continuously.
- ▶ Left LED on, automatic recirculated-air control: a sensor detects pollutants in the outside air and shuts off automatically.
- ▶ Right LED on, recirculated-air mode: the supply of outside air into the vehicle is permanently blocked.

Recirculated-air mode switches off automatically at low external temperatures after a certain amount of time in order to avoid window fogging.

If the windows are fogged over, switch off the recirculated-air mode and press the AUTO button to utilize the condensation sensor. Make sure that air can flow to the windshield.

**Controlling the air flow manually**

**Concept**

The air flow for climate control can be adjusted manually.

**General information**

To manually adjust air flow switch off AUTO program first.

**Operation**



Press the left or right side of the button: decrease or increase air flow.

The selected air flow is shown on the display of the automatic climate control.

The air flow of the automatic climate control may be reduced automatically to save battery power.

**Controlling the air distribution manually**

**Concept**

The air distribution for climate control can be adjusted manually.

## Operation



Press the button repeatedly to select a program:

- ▶ Upper body region and floor area.
- ▶ Floor area.
- ▶ Windows and floor area.
- ▶ Windows.
- ▶ Windows and upper body region.
- ▶ Upper body region.
- ▶ Windows, upper body region, and floor area.

If the windows are fogged over, press the AUTO button to utilize the condensation sensor.

## SYNC program

### Concept

The system enables the transfer of current settings on the driver's side for temperature, air flow, air distribution, and the AUTO program to the front passenger side and to the left and right rear.

### Switching on/off



Press the button.

The current setting of the temperature on the driver's side is transferred to the front passenger side.

The program is switched off if the setting on the front passenger side is changed.

## Defrosting windows and removing condensation

### Concept

Ice and condensation are quickly removed from the windshield and the front side windows.

### Switching on/off



Press the button.

The LED is illuminated with the system switched on.

For this purpose, point the side vents towards the side windows as needed.

The air flow can be adjusted with the air flow active.

If the windows are fogged over, you can also switch on the air conditioning or press the AUTO button to utilize the condensation sensor.

## Rear window defroster



Press the button. The LED lights up.

The rear window defroster switches off automatically after a certain period of time.

For permanent activation, press the button for longer than 3 seconds. To deactivate, press the button again.

The rear window defroster can only be activated continuously at an external temperature below approx. 23 °F/-5 °C.

## Microfilter/activated-charcoal filter

In external and recirculated-air mode the microfilter/activated charcoal filter filters dust, pollen, and gaseous pollutants out of the air.

Have this filter changed during vehicle maintenance, refer to page [271](#).

## Ventilation

### Front ventilation

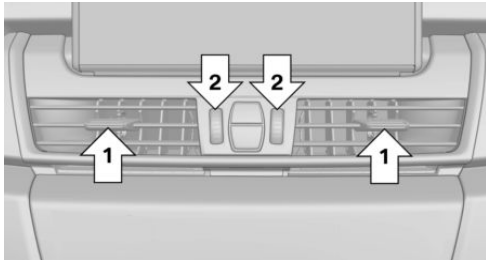

- ▷ Lever for changing the air flow direction, arrow 1.
- ▷ Thumbwheels for opening and closing the vents continuously, arrows 2.

### Settings

- ▷ Ventilation for cooling:  
Direct vent in your direction when car's interior is too hot.
- ▷ Draft-free ventilation:  
Adjust the vent to let the air flow past you.

### Ventilation in the rear

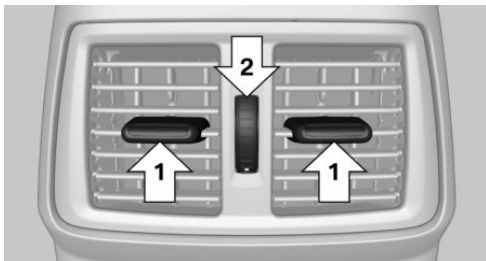

- ▷ Lever for changing the air flow direction, arrow 1.
- ▷ Thumbwheel for variable opening and closing of the vents, arrow 2.

## Parked-car ventilation

### Concept

The parked-car ventilation ventilates the car's interior and lowers its temperature, if needed.

### General information

The parked-car ventilation can be switched on and off directly or by using two preset activation times. The system remains switched on for 30 minutes.

The parked-car ventilation system is operated via iDrive.

### Functional requirements

- ▷ Direct operation: vehicle is in radio-ready state.
- ▷ Direct operation or preset activation time: does not depend on external temperature.
- ▷ Battery is sufficiently charged.

If parked-car ventilation is switched on, the vehicle battery will be discharged. Thus, limit the maximum activation time to save the vehicle battery. The system will be available again after the engine is started or after a short trip.

- ▷ Make sure that the vehicle's date and time are set correctly.
- ▷ Open the vents to allow air to flow out.

### Switching on/off directly

Via iDrive:

1. "My Vehicle"
  2. "Vehicle settings"
  3. If necessary, "Climate functions"
  4. "Activate comfort ventilation now"
- ⚡ The symbol on the automatic climate control flashes if the system is switched on.

## Preselecting the activation time

Via iDrive:

1. "My Vehicle"
2. "Vehicle settings"
3. If necessary, "Climate functions"
4. "Comfort ventilation"
5. Select the desired activation time.
6. Set the desired time.

## Activating the activation time

Via iDrive:

1. "My Vehicle"
2. "Vehicle settings"
3. If necessary, "Climate functions"
4. "For start time at:"

Activate the desired activation time.

 The symbol on the automatic climate control lights up when the activation time is activated.

 The symbol on the automatic climate control flashes when the system has been switched on.

The system will only be switched on within the next 24 hours. After that, it needs to be reactivated.

# Interior equipment

## Vehicle features and options

This chapter describes all standard, country-specific and optional features offered with the series. It also describes features that are not necessarily available in your vehicle, e. g., due to the selected options or country versions. This also applies to safety-related functions and systems. When using these functions and systems, the applicable laws and regulations must be observed.

## Integrated Universal Remote Control

### Concept

The integrated Universal Remote Control in the interior mirror can operate up to 3 functions of remote-controlled systems, such as garage door drives, barriers or lighting systems.

### General information

The Integrated Universal Remote Control replaces up to 3 different hand-held transmitters. To operate the remote control, the buttons on the interior mirror must be programmed with the desired functions. The hand-held transmitter for the particular system is required in order to program the remote control.

Before selling the vehicle, delete the stored functions for the sake of security.

If possible, do not install the antenna of the remote-controlled system, e.g. the garage gate drive, near metal objects to ensure the best possible operation.

## Safety information

### WARNING

The operation of remote-controlled systems with the integrated universal remote control, such as the garage door, may result in pinched body parts. There is a risk of injury or risk of damage to property. Make sure that the area of movement of the respective system is clear during programming and operation. Also follow the safety information of the hand-held transmitter.

## Compatibility



If this symbol is printed on the packaging or in the owner's manual of the system to be controlled, the system is generally compatible with the integrated Universal Remote Control.

Additional questions are answered by:

- ▶ A dealer's service center or another qualified service center or repair shop.
- ▶ [www.homelink.com](http://www.homelink.com) on the Internet.

HomeLink is a registered trademark of Gentex Corporation.

## Control elements on the interior mirror

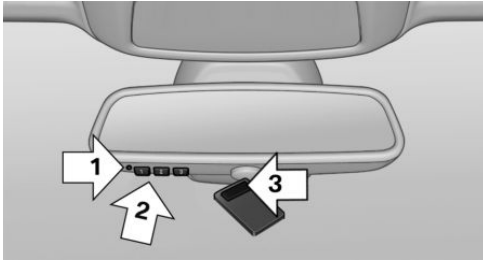

- ▶ LED, arrow 1.
- ▶ Buttons, arrow 2.
- ▶ The hand-held transmitter, arrow 3, is required for programming.

## Programming

### General information

The battery of the hand-held transmitter must be fully charged at the time of programming to ensure an optimal range of the integrated universal remote control.

1. Switch on the ignition.
2. Initial setup:
 

Press and hold the two outer buttons on the interior mirror simultaneously for approximately 10 seconds until the LED flashes green rapidly. This erases all programming of the buttons on the interior mirror.
3. Press the interior mirror button to be programmed. The LED on the interior mirror will slowly begin flashing orange.
4. Hold the hand-held transmitter for the system to be used approx. 1 to 12 in/2.5 to 30 cm away from the buttons on the interior mirror. The required distance depends on the hand-held transmitter.
5. Press and hold the button of the desired function on the hand-held transmitter.

Canada: if programming with the hand-held transmitter was interrupted, hold down the interior mirror button and repeatedly press and release the hand-held transmitter button for 2 seconds.

6. ▶ The LED lights up green: programming completed.
 

Release the button.
- ▶ The LED flashes fast: programming is not complete.

Press the button on the interior mirror for 2 seconds and release. Perform this procedure three times to complete the programming procedure.

If the integrated universal remote control remains nonoperational, continue with the special features for change code wireless systems.

- ▶ LED does not flash green after 60 seconds: programming not completed.

Repeat steps 3 to 6.

To program other functions on other buttons, repeat steps 3 to 5.

### Special feature of the rolling code wireless system

If you are unable to operate the system after repeated programming, please check if the system to be controlled features a rolling code radio system.

Refer to the owner's manual for the system.

For systems with a rolling code radio system, the integrated Universal Remote Control and the system also have to be synchronized.

Please read the owner's manual to find out how to synchronize the system.

Synchronizing is easier with the aid of a second person.



Synchronizing the universal remote control with the system:

1. Park the vehicle within range of the remote-controlled system.
2. Program the desired button on the interior mirror as described.
3. Locate and press the synchronizing button on the system being programmed, e.g. at the garage gate. You have approx. 30 seconds for the next step.
4. Hold down the programmed button on the interior mirror for approximately 3 seconds and then release it. If necessary, repeat this step up to three times in order to finish synchronization. Once synchronization is complete, the programmed function will be carried out.

## Reprogramming individual buttons

1. Switch on the ignition.
2. Press and hold the interior mirror button to be programmed.
3. As soon as the LED on the interior mirror flashes orange after approx. 20 seconds, release the button.
4. Hold the hand-held transmitter for the system to be used approx. 1 to 12 in/2.5 to 30 cm away from the buttons on the interior mirror. The required distance depends on the hand-held transmitter.
5. Press and hold the button of the desired function on the hand-held transmitter.  
Canada: if programming with the hand-held transmitter was interrupted, hold down the interior mirror button and repeatedly press and release the hand-held transmitter button for 2 seconds.
6. The LED can light up in different ways.
  - ▶ The LED lights up green: the programming procedure is completed.  
Release the button.

- ▶ The LED flashes fast: the hand-held transmitter was detected but programming is not complete.

Press the button on the interior mirror for 2 seconds and release. Perform this procedure three times to complete the programming procedure.

If the universal remote control remains nonoperational, continue with the special features for change code wireless systems.

- ▶ LED does not flash green after 60 seconds: programming not completed.

Repeat steps 3 to 6.

If the programming procedure is not completed, the previous programming will remain unchanged.

## Operation

### WARNING

The operation of remote-controlled systems with the integrated universal remote control, such as the garage door, may result in pinched body parts. There is a risk of injury or risk of damage to property. Make sure that the area of movement of the respective system is clear during programming and operation. Also follow the safety information of the hand-held transmitter.

The system, such as the garage door, can be operated using the button on the interior mirror while the engine is running or when the ignition is started. To do this, hold down the button within receiving range of the system until the function is activated. The interior mirror LED stays lit while the wireless signal is being transmitted.

## Deleting stored functions

All stored functions will be deleted. The functions cannot be deleted individually.

Press and hold the two outer buttons on the interior mirror simultaneously for approximately 10 seconds until the LED on the interior mirror flashes green rapidly.

## Digital compass

### Overview

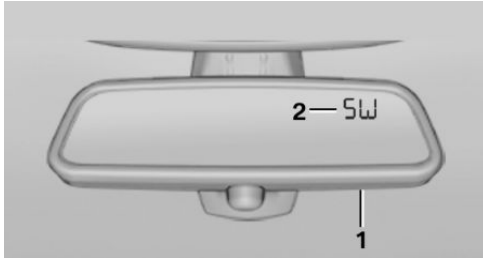

- 1 Control button
- 2 Mirror display

### Mirror display

The point of the compass in the mirror indicates the direction in which you are driving.

### Operating concept

Various functions can be called up by pressing the control button with a pointed object, such as the tip of a ballpoint pen or similar object. The following setting options are displayed in succession, depending on how long the control button is pressed:

- ▷ Pressed briefly: turns display on/off.
- ▷ 3 to 6 seconds: compass zone setting.
- ▷ 6 to 9 seconds: compass calibration.
- ▷ 9 to 12 seconds: left/right-hand steering setting.
- ▷ 12 to 15 seconds: language setting.

### Setting the compass zones

Sets the particular compass zones on the vehicle so that the compass operates correctly; refer to World map with compass zones.



## World map with magnetic zones

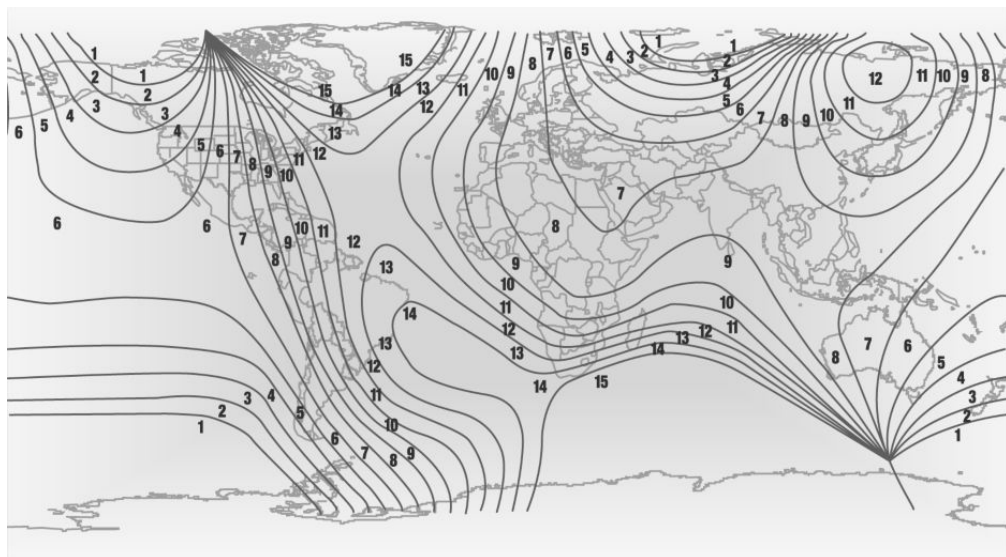

### Procedure

1. Press and hold the control button for approx. 3 to 4 seconds. The number of the set compass zone appears in the mirror.
2. To change the zone setting, press the control button quickly and repeatedly until the number of the compass zone that corresponds with your location appears in the mirror.

The set zone is stored automatically. The compass is ready for use again after approximately 10 seconds.

### Calibrating the digital compass

The digital compass must be calibrated in the event of the following:

- ▷ The wrong compass point is displayed.
- ▷ The point of the compass displayed does not change despite changing the direction of travel.
- ▷ Not all points of the compass are displayed.

### Procedure

1. Make sure that there are no large metallic objects or overhead power lines near the vehicle and that there is sufficient room to drive around in a circle.
2. Set the currently applicable compass zone.
3. Press and hold the control button for approx. 6 to 7 seconds so that "C" appears on the display. Next, drive in a complete circle at least once at a speed of no more than 4 mph/7 km/h. If calibration is successful, the "C" is replaced by the points of the compass.

### Left/right-hand steering

The digital compass is already set for right or left-hand steering at the factory.

### Setting the language

Press and hold the control button for approx. 12 to 13 seconds. Briefly press the control button again to switch between English "E" and German "O".

Settings are stored automatically after approximately 10 seconds.

## Sun visor

### Glare shield

Fold the sun visor down or up.

### Glare shield from the side

#### Folding out

1. Fold the sun visor down.
2. Unhook it from the holder and swing it to the side.
3. Move it back to the desired position.

#### Folding up

Proceed in the reverse order to close the sun visor.

### Vanity mirror

A vanity mirror is located in the sun visor behind a cover. When the cover is opened, the interior lighting switches on.

## Ashtray/cigarette lighter

### Ashtray

#### Opening

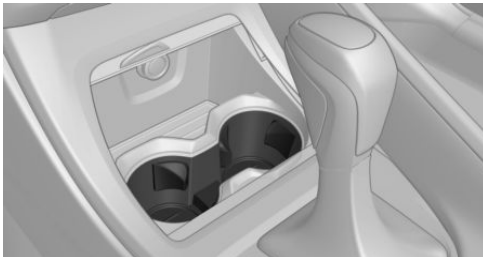

The ashtray can be inserted in the cup holder.

### Emptying

Take out the insert.

### Cigarette lighter

#### WARNING

Contact with the hot heating element or the hot socket of the cigarette lighter can cause burns. Flammable materials can ignite if the cigarette lighter falls down or is held against the respective objects. There is a risk of fire and injuries. Take hold of the cigarette lighter by its handle. Make sure that children do not use the cigarette lighter and burn themselves.

#### NOTICE

If metal objects fall into the socket, they can cause a short circuit. There is a risk of damage to property. Replace the cigarette lighter or socket cover again after using the socket.



The cigarette lighter is located in the center console.



Push in the cigarette lighter. The cigarette lighter can be removed as soon as it pops back out.

## Sockets

### General information

The lighter socket can be used as a socket for electrical equipment while the engine is running or when the ignition is switched on.

The total load of all sockets must not exceed 140 watts at 12 volts.

Do not damage the socket by using non-compatible connectors.

### Safety information

#### **WARNING**

Devices and cables in the unfolding area of the airbags, such as portable navigation devices, can hinder the unfolding of the airbag or be thrown around in the car's interior during unfolding. There is a risk of injury. Make sure that devices and cables are not in the airbag's area of unfolding.

#### **NOTICE**

Battery chargers for the vehicle battery can work with high voltages and currents, which means that the 12 volt on-board network can be overloaded or damaged. There is a risk of damage to property. Only connect battery chargers for the vehicle battery to the starting aid terminals in the engine compartment.

#### **NOTICE**

If metal objects fall into the socket, they can cause a short circuit. There is a risk of damage to property. Replace the cigarette lighter or socket cover again after using the socket.

### Front center console

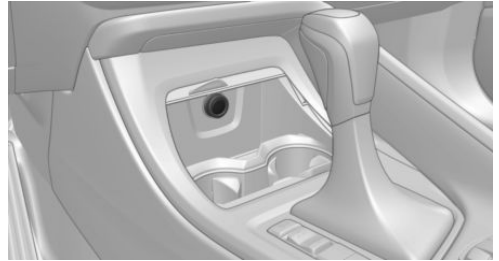

Remove the cover or cigarette lighter.

### In the front passenger floor area



The socket is located below the glove compartment.

### Rear center console



Remove the cover.

## In the cargo area

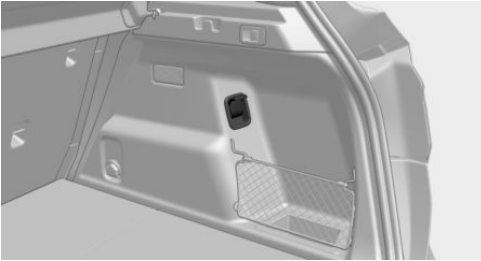

The socket is located on the right side in the cargo area.

## USB interface

### Concept

Mobile devices with USB port can be connected to the USB interface.

### General information

Follow the information regarding the connection of mobile devices to the USB interface in the section on USB connections, refer to page 59.

### USB interface, front

#### In the center console

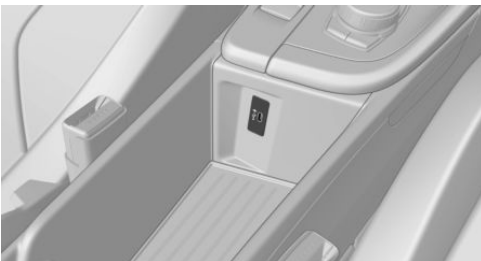

The USB interface is located in the center console.

Properties:

- ▶ USB port Type C.

- ▶ With Wireless Charging: for charging mobile devices and for data transfer.
- ▶ Without Wireless Charging: for charging of mobile devices.
- ▶ Charge current: max. 3 A.

#### In the front center console

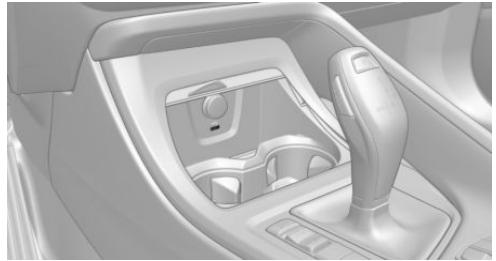

The USB interface is located in the front center console.

- ▶ USB port Type A.
- ▶ For charging mobile devices and for data transfer.
- ▶ Charge current: max. 1.5 A.

#### In the rear center console



One USB dual charge socket is located in the rear center console.

Properties:

- ▶ USB port Type C.
- ▶ For charging of mobile devices.
- ▶ Charge current: max. 3 A per connection.

## Connecting an external device

Follow the following when connecting:

- ▶ Do not use force when plugging the connector into the USB interface.
- ▶ Use a flexible adapter cable.
- ▶ Protect the USB storage device against mechanical damage.
- ▶ Due to the large number of USB media available on the market, it cannot be guaranteed that every device is operable on the vehicle.
- ▶ Do not expose USB media to extreme environmental conditions, such as very high temperatures; refer to the owner's manual of the device.
- ▶ Due to the many different compression techniques, proper playback of the media stored on the USB storage device cannot be guaranteed in all cases.
- ▶ A connected USB storage device will be supplied with charging current via the USB interface if the device supports this. At higher temperatures, the USB storage device may cause a reduction in the charging current.
- ▶ To ensure proper transmission of the stored data, do not charge a USB storage device via the onboard socket, when it is connected to the USB interface.
- ▶ Depending on how the USB storage device is being used, settings may be required on the USB storage device, refer to the owner's manual of the device.

Non-compatible USB media:

- ▶ USB hard drives.
- ▶ USB hubs.
- ▶ USB memory card readers with multiple inserts.
- ▶ HFS-formatted USB media.
- ▶ Devices such as fans or lamps.

## Cargo area

### Cargo cover

#### Safety information

**⚠ WARNING**

Loose objects or devices with a cable connection to the vehicle, for instance mobile phones, can be thrown into the car's interior while driving, for instance in the event of an accident or during braking and evasive maneuvers. There is a risk of injury. Secure loose objects or devices with a cable connection to the vehicle in the car's interior.

#### General information

The cargo cover is in two parts. This can be removed to load bulky luggage.

#### Removing

##### Rear cover

1. Detach the retaining straps at the tailgate.
2. Pry cover up a bit, arrow 1, and pull out of the brackets toward the back, arrow 2.

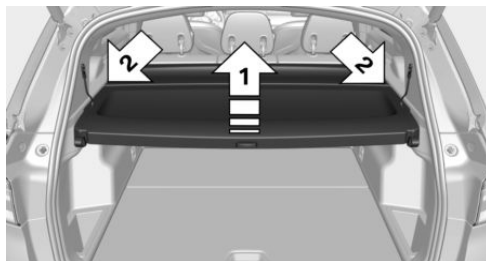

## Front cover

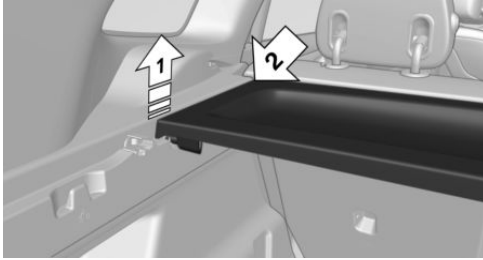

1. Push cover out of the bracket upward on both sides, arrow 1.
2. Pull cover out of the bracket toward the rear on both sides, arrow 2.

## Installing

Proceed in the reverse order to reinstall. The cargo covers must snap audibly into place on their respective holders.

## Enlarging the cargo area

### Concept

Depending on the vehicle equipment, the cargo area can be enlarged as follows:

- ▶ The rear seat backrests can be folded down.
- ▶ The rear seat backrests can be moved into an upright loading position using the cargo setting.

### General information

The rear seat backrest is divided at a ratio of 40–20–40. The side rear seat backrests and the center section can be folded down separately.

Depending on the vehicle equipment, the rear seat backrests can be folded down from the rear or from the cargo area.

## Safety information

### WARNING

Danger of jamming with folding down the backrests. There is a risk of injury or risk of damage to property. Make sure that the area of movement of the rear backrest and the of the head restraint is clear prior to folding down.

### WARNING

If a rear seat backrest is not locked, unsecured cargo can be thrown about the car's interior; for instance, in the event of an accident, braking or an evasive maneuver. There is a risk of injury. Make sure that the rear seat backrest is locked after folding it back.

### WARNING

Unexpected movements of the rear seat backrest while driving may occur due to unintentional unlocking of the rear seat backrests by the straps. There is a risk of injury. Do not fasten any objects to the straps for unlocking the rear backrests.

### WARNING

With a rear backrest that is not locked, the protective function of the middle safety belt is not guaranteed. There is a risk of injuries or danger to life. If you are using the middle safety belt, lock the wider rear seat backrest.

### WARNING

The stability of the child restraint system is limited or compromised with incorrect seat adjustment or improper installation of the child seat. There is a risk of injuries or danger to life. Make sure that the child restraint system fits securely against the backrest. If possible, adjust the

backrest tilt for all affected backrests and correctly adjust the seats. Make sure that seats and backrests are securely engaged or locked. If possible, adjust the height of the head restraints or remove them.

**NOTICE**

Vehicle parts can be damaged when folding down the rear backrest. There is a risk of damage to property. Make sure that the area of movement of the rear backrest including head restraint is clear when folding down.

**Folding down the rear seat backrest from the rear**

1. Pull loop to unlock the rear seat backrest.

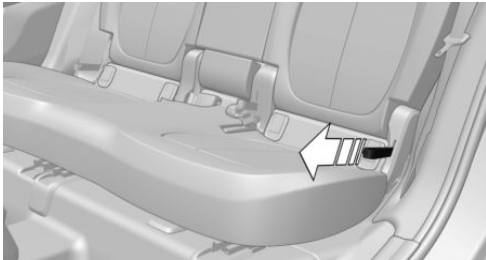

2. The rear seat backrest folds forward.

**Folding down the rear seat backrest from the cargo area**



Pull the switch inside the cargo area.

Left switch: the left and center rear seat backrests fold forward.

Right switch: the right rear seat backrest folds forward.

**Cargo position**

**Concept**

The rear seat backrests can be moved into an upright loading position individually. An adjustment in several tilt stages is possible as needed.

**Settings**

1. Pull the strap.

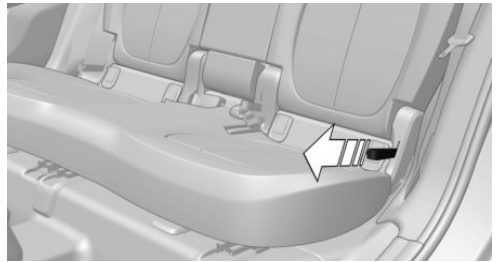

2. Set the loading position of the rear seat backrest as required.
3. Engage the rear seat backrest.

**Folding back the backrest**

Without a cargo position:

1. Pull the strap.

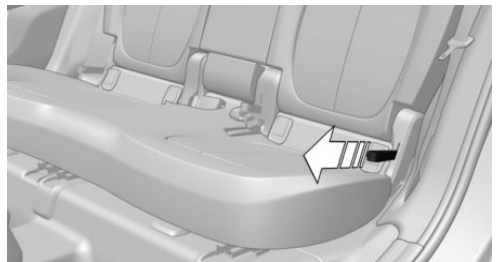

2. Return the rear seat backrest to the upright seating position and engage it.



With a cargo position:

1. Pull the strap.

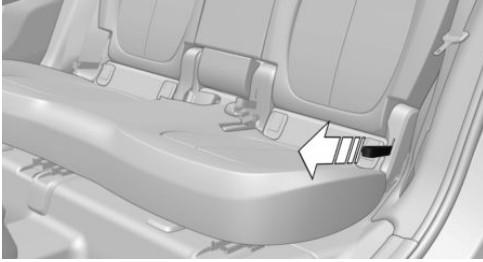

2. Fold the rear seat backrest rearward. The rear seat backrest first engages in the loading position.
3. Pull the strap again.
4. Return the rear seat backrest to the upright seating position and engage it.

## Cargo area partition net

### Cargo area partition net, large

When the rear seat backrest is folded down, install the large cargo area partition net behind the front seats.

1. Fold down the rear seat backrests, refer to page 213.
2. Open the lids above on the roof frame until they engage.

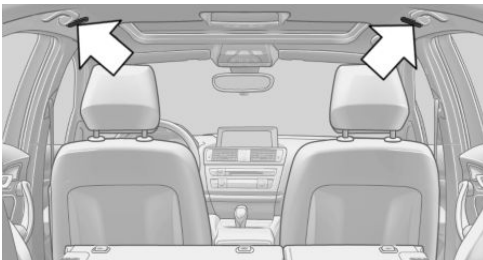

3. Insert each of the two top retaining pins of the cargo area partition net into the recepta-

cles until they reach the stop, arrow 1, and push them forward.

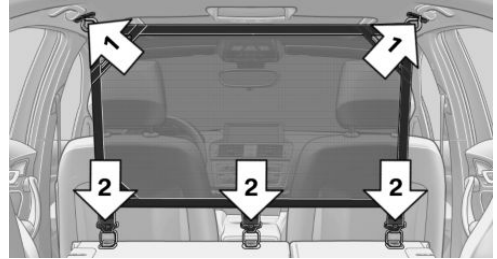

4. Hook the lower three hooks of the cargo area partition net into the three eyes of the folded down rear backrest, arrow 2, raising the backrests slightly, if needed.

Make sure that the lower hooks are hooked into the eyes from behind.



### Cargo area partition net, small

With upright rear backrests, install the small cargo area partition net behind the second row of seats.

1. Remove the cargo cover.
2. Insert each of the two top retaining pins of the cargo area partition net into the recepta-





cles until they reach the stop, arrow 1, and push them forward.

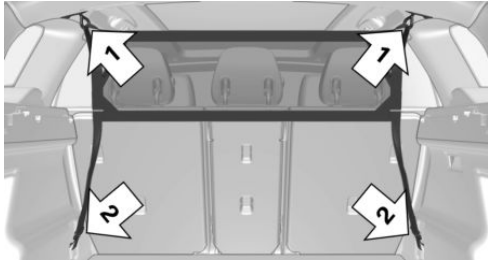

3. Use the two lower hooks to hook the cargo area partition net into the upper eyes in the cargo area, arrow 2.

## **Ski and snowboard bag**

The ski and snowboard bag is contained in a protective jacket in the cargo area.

Follow the installation and owner's manual included in the protective jacket.

# Storage compartments

## Vehicle features and options

This chapter describes all standard, country-specific and optional features offered with the series. It also describes features that are not necessarily available in your vehicle, e. g., due to the selected options or country versions. This also applies to safety-related functions and systems. When using these functions and systems, the applicable laws and regulations must be observed.

## Safety information

### WARNING

Loose objects or devices with a cable connection to the vehicle, for instance mobile phones, can be thrown into the car's interior while driving, for instance in the event of an accident or during braking and evasive maneuvers. There is a risk of injury. Secure loose objects or devices with a cable connection to the vehicle in the car's interior.

### NOTICE

Anti-slip pads such as anti-slip mats can damage the dashboard. There is a risk of damage to property. Do not use anti-slip pads.

## Storage compartments in the car's interior

The following storage compartments are available in the car's interior:

- ▷ Storage compartment up front in the center console, refer to page 217.
- ▷ Glove compartment on the front passenger side, refer to page 218.
- ▷ Glove compartment on the driver's side, refer to page 218.
- ▷ Compartments in the doors, refer to page 218.
- ▷ Storage compartment in the center armrest, refer to page 219.
- ▷ Cup holder, refer to page 219.
- ▷ Storage compartment in the rear center console, refer to page 219.
- ▷ Clothes hooks, refer to page 220
- ▷ Storage compartments in the cargo area, refer to page 220.
- ▷ Additional storage compartments in the car's interior, refer to page 220

## Storage compartment up front in the center console

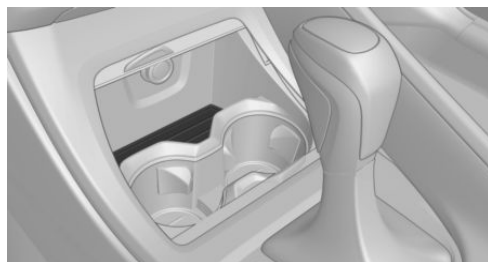

There is a storage compartment in the center console.

## Glove compartment

### Front passenger side

#### Safety information

**⚠️ WARNING**

Folded open, the glove compartment protrudes in the car's interior. Objects in the glove compartment can be thrown into the car's interior while driving, for instance in the event of an accident or during braking and evasive maneuvers. There is a risk of injury. Always close the glove compartment immediately after using it.

#### Opening



Pull the handle.

The light in the glove compartment switches on.

#### Closing

Fold cover closed.

### Driver's side

#### Safety information

**⚠️ WARNING**

Folded open, the glove compartment protrudes in the car's interior. Objects in the glove compartment can be thrown into the car's interior while driving, for instance in the event of an accident or during braking and evasive maneu-

vers. There is a risk of injury. Always close the glove compartment immediately after using it.

#### Opening

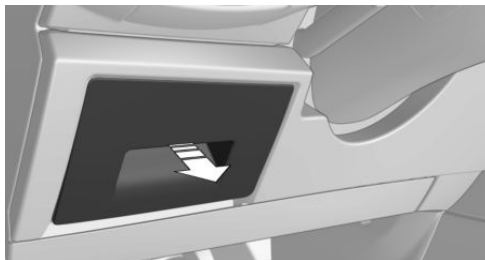

Pull the handle.

#### Closing

Fold cover closed.

## Compartments in the doors

### General information

There are storage compartments in the doors.

#### Safety information

**⚠️ WARNING**

Breakable objects, such as glass bottles or glasses, can break in the event of an accident or a braking or evasive maneuver. Broken glass can be scattered in the car's interior. There is a risk of injury or risk of damage to property. Do not use any breakable objects while driving. Only stow breakable objects in closed storage compartments.

## Center armrest

### Front

A storage compartment is located in the center armrest between the front seats.

### Opening



Pull the lever, arrow 1, and fold the center armrest up, arrow 2.

### Settings

The center armrest can be adjusted in several tilt settings.

## Storage compartment in the rear center console

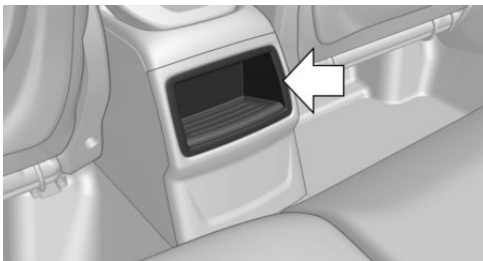

A storage compartment is located in the center console.

## Cup holders

### Safety information

#### **WARNING**

Unsuitable containers in the cup holder may damage the cup holders or be thrown into the car's interior, such as in the event of an accident, braking or evasive maneuver. Spilled liquids can distract from the traffic conditions and lead to an accident. Hot drinks can damage the cup holder or lead to scalding. There is a risk of injury or risk of damage to property. Do not force objects into the cup holder. Use lightweight, unbreakable, and sealable containers. Do not transport hot beverages.

### Front

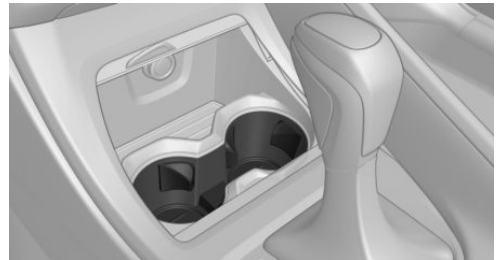

Two cup holders are located in the front center console.

### Rear

#### **NOTICE**

With an open cup holder, the center armrest cannot be folded back up. There is a risk of damage to property. Press back the covers before the center armrest is folded up.

In the center armrest.

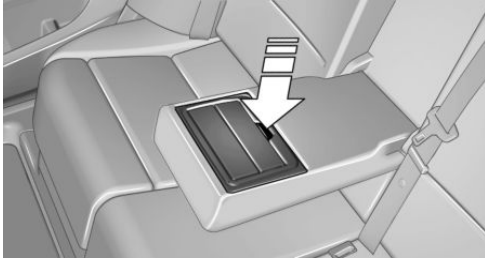

Pull the center armrest forward at the strap.

To open: press the button.

To close: push both covers back in, one after the other.

## Additional storage compartments in the car's interior

### Nets on the backrests of the front seats

The nets on the backrests of the front seats can also be used to store small parts.

## Clothes hooks

### Safety information

#### WARNING

Clothing articles on the clothes hooks can obstruct the view while driving. There is a risk of an accident. When suspending clothing articles from the clothes hooks, ensure that they will not obstruct the driver's view.

#### WARNING

Improper use of the clothes hooks can lead to a risk of objects flying about during braking and evasive maneuvers. There is a risk of injury and risk of damage to property. Only hang lightweight objects, for instance clothing articles, from the clothes hooks.

### General information

The clothes hooks are located in the grab handles in the rear.

## Storage compartments in the cargo area

### Side storage compartments, left and right

Storage compartments are located on the right and left sides.

### Net for storage compartment

Smaller objects can be stored in the net of right storage compartment.

### Multi-function hook

#### WARNING

Improper use of the multi-function hooks can lead to a risk of objects flying about during braking and evasive maneuvers, for example. There is a risk of injury and risk of damage to property. Only hang lightweight objects, such as shopping bags, from the multi-function hooks. Only transport heavy luggage in the cargo area if it has been appropriately secured.

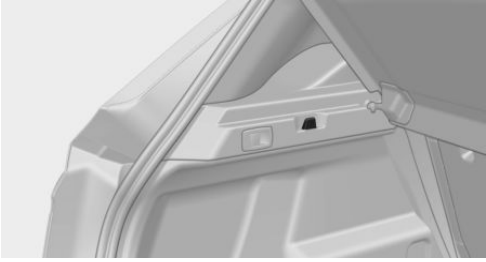

A multi-function hook is located on each side of the cargo area.

### Lashing eyes in the cargo area

To secure the cargo, refer to page [229](#), there are lashing eyes in the cargo area.

### Storage space under cargo floor panel

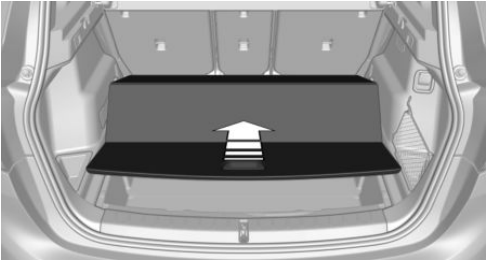

The cargo floor panel can be folded. To open the cargo floor panel, lift slightly and push toward the front.









## ① DRIVING TIPS

Things to remember when driving .....	224
Loading .....	228
Saving fuel .....	231



# Things to remember when driving

## Vehicle features and options

This chapter describes all standard, country-specific and optional features offered with the series. It also describes features that are not necessarily available in your vehicle, e. g., due to the selected options or country versions. This also applies to safety-related functions and systems. When using these functions and systems, the applicable laws and regulations must be observed.

## Breaking-in period

### General information

Moving parts need to begin working together smoothly.

The following instructions will help you to achieve a long vehicle life and good efficiency.

During break-in, do not use the Launch Control.

### Safety information

#### **WARNING**

Due to new parts and components, safety and driver assistance systems can react with a delay. There is a risk of an accident. After installing new parts or with a new vehicle, drive conservatively and intervene early if necessary. Observe the break-in procedures of the respective parts and components.

## Engine, transmission, and axle drive

### Up to 1,200 miles/2,000 km

Do not exceed the maximum engine and road speed:

- ▶ For gasoline engine 4,500 rpm and 100 mph/160 km/h.

Avoid full load or kickdown under all circumstances.

### From 1,200 miles/2,000 km

The engine and vehicle speed can gradually be increased.

### Tires

Tire traction is not optimal due to manufacturing circumstances when tires are brand-new; they achieve their full traction potential after a break-in time.

Drive conservatively for the first 200 miles/300 km.

### Brake system

Brake discs and brake pads only reach their full effectiveness after approx. 300 miles/500 km. Drive moderately during this break-in period.

### Following part replacement

The same break-in procedures should be observed if any of the components above-mentioned have to be renewed in the course of the vehicle's operating life.

## Driving on poor roads

### Concept

Because of its greater ground clearance, the vehicle can be driven on a variety of road types and qualities.

All-wheel drive can help improve forward momentum.

### Safety information

#### NOTICE

Objects in unpaved areas, for instance stones or branches, can damage the vehicle. There is a risk of damage to property. Do not drive on unpaved terrain.

### When driving on poor roads

For your own safety, for the safety of passengers and of the vehicle, heed the following points:

- ▶ Familiarize yourself with the vehicle before driving.
- ▶ Do not take risks when driving.
- ▶ Adjust the speed to the road surface conditions. The steeper and more uneven the road surface, the slower the speed should be.
- ▶ When driving on steep uphill or downhill grades: add engine oil and coolant up to near the MAX mark.
- ▶ On steep downhill grades, use Hill Descent Control HDC.
- ▶ Avoid that the chassis bottom coming in contact with the ground.  
The ground clearance is no more than 7.8 inches/20 cm and can vary according to the vehicle's load.
- ▶ When wheels continue to spin, depress the accelerator so that driving stability control systems can distribute the driving force to the wheels. Activate DTC Dynamic Traction Control if available.

## After a trip on poor roads

After a trip on poor roads, check wheels and tires for damage to maintain driving safety. Clear heavy soiling from the body.

## General driving notes

### Closing the tailgate

#### Safety information

#### WARNING

An open tailgate protrudes from the vehicle and can endanger occupants and other traffic participants or damage the vehicle in the event of an accident, braking or evasive maneuvers. In addition, exhaust fumes may enter the car's interior. There is a risk of injury or risk of damage to property. Do not drive with the tailgate open.

### Driving with the tailgate open

If driving with the tailgate open cannot be avoided:

- ▶ Close all windows and the glass sunroof.
- ▶ Greatly increase the air flow from the vents.
- ▶ Drive moderately.

### Hot exhaust gas system

#### WARNING

During driving operation, high temperatures can occur underneath the vehicle body, for instance caused by the exhaust gas system. If combustible materials, such as leaves or grass, come in contact with hot parts of the exhaust gas system, these materials can ignite. There is a risk of injury or risk of damage to property. Do not remove the heat shields installed and never apply undercoating to them. Make sure that no combustible materials can come in contact with hot vehicle parts in driving operation, idle or

during parking. Do not touch the hot exhaust gas system.

## Mobile communication devices in the vehicle

### **WARNING**

Vehicle electronics and mobile phones can influence one another. There is radiation due to the transmission operations of mobile phones. There is a risk of injury or risk of damage to property. If possible, in the car's interior use only mobile phones with direct connections to an exterior antenna in order to exclude mutual interference and deflect the radiation from the car's interior.

## Hydroplaning

On wet or slushy roads, a wedge of water can form between the tires and road surface.

This phenomenon is referred to as hydroplaning. It is characterized by a partial or complete loss of contact between the tires and the road surface, ultimately undermining your ability to steer and brake the vehicle.

## Driving through water

### General information

When driving through water, follow the following:

- ▶ Drive through calm water only.
- ▶ Drive through water only if it is not deeper than maximum 9.8 in/25 cm.
- ▶ Drive through water no faster than walking speed, up to 3 mph/5 km/h.

## Safety information

### **NOTICE**

When driving too quickly through too deep water, water can enter into the engine compartment, the electrical system or the transmission. There is a risk of damage to property. When driving through water, do not exceed the maximum indicated water level and the maximum speed for driving through water.

## Braking safely

### General information

The vehicle is equipped with ABS as a standard feature.

Perform an emergency stop in situations that require such.

Steering is still responsive. You can still avoid any obstacles with a minimum of steering effort.

Pulsation of the brake pedal and sounds from the hydraulic circuits indicate that ABS is in its active mode.

## Objects in the movement area around pedals and floor area

### **WARNING**

Objects in the driver's floor area can limit the pedal distance or block a depressed pedal. There is a risk of an accident. Stow objects in the vehicle such that they are secured and cannot enter into the driver's floor area. Use floor mats that are suitable for the vehicle and can be safely attached to the floor. Do not use loose floor mats and do not layer several floor mats. Make sure that there is sufficient clearance for the pedals. Ensure that the floor mats are securely fastened again after they were removed, for instance for cleaning.

## Driving in wet conditions

When roads are wet, salted, or in heavy rain, gently press the brake pedal every few miles.

Ensure that this action does not endanger other traffic.

The heat generated during braking dries brake discs and brake pads and protects them against corrosion.

In this way braking efficiency will be available when you need it.

## Hills

### General information

Drive long or steep downhill gradients in the gear that requires least braking effort. Otherwise, the brakes may overheat and reduce brake efficiency.

You can increase the engine's braking effect by shifting down, going all the way to first gear, if needed.

### Safety information

#### **WARNING**

Light but consistent brake pressure can lead to high temperatures, brakes wearing out and possibly even brake failure. There is a risk of an accident. Avoid placing excessive stress on the brake system.

#### **WARNING**

In idle state or with the engine switched off, safety-relevant functions, for instance engine braking effect, braking force boost and steering assistance, are restricted or not available at all. There is a risk of an accident. Do not drive in idle state or with the engine switched off.

## Brake disc corrosion

Corrosion on the brake discs and contamination on the brake pads are increased by the following circumstances:

- ▷ Low mileage.
- ▷ Extended periods when the vehicle is not used at all.
- ▷ Infrequent use of the brakes.
- ▷ Aggressive, acidic, or alkaline cleaning agents.

Corrosion buildup on the brake discs will cause a pulsating effect on the brakes in their response - generally this cannot be corrected.

## Condensation water under the parked vehicle

When using the automatic climate control, condensation water develops and collects underneath the vehicle.

## Driving on racetracks

Higher mechanical and thermal loads during racetrack operation lead to increased wear. This wear is not covered by the warranty. The vehicle is not designed for use in motor sports competition.

# Loading

## Vehicle features and options

This chapter describes all standard, country-specific and optional features offered with the series. It also describes features that are not necessarily available in your vehicle, e. g., due to the selected options or country versions. This also applies to safety-related functions and systems. When using these functions and systems, the applicable laws and regulations must be observed.

## Safety information

### WARNING

High gross weight can overheat the tires, damage them internally and cause a sudden drop in tire inflation pressure. Driving characteristics may be negatively impacted, reducing lane stability, lengthening the braking distances and changing the steering response. There is a risk of an accident. Pay attention to the permitted load capacity of the tires and never exceed the permitted gross weight.

### WARNING

Loose objects or devices with a cable connection to the vehicle, for instance mobile phones, can be thrown into the car's interior while driving, for instance in the event of an accident or during braking and evasive maneuvers. There is a risk of injury. Secure loose objects or devices with a cable connection to the vehicle in the car's interior.

### WARNING

Unexpected movements of the rear seat backrest while driving may occur due to unintentional unlocking of the rear seat backrests by the straps. There is a risk of injury. Do not fasten any objects to the straps for unlocking the rear backrests.

### WARNING

Improperly stowed objects can shift and be thrown into the car's interior, for instance in the event of an accident or during braking and evasive maneuvers. Vehicle occupants can be hit and injured. There is a risk of injury. Stow and secure objects and cargo properly.

### NOTICE

Fluids in the cargo area can cause damage. There is a risk of damage to property. Make sure that no fluids leak in the cargo area.

## Steps for Determining Correct Load Limit

1. Locate the statement "The combined weight of occupants and cargo should never exceed XXX kg or XXX lbs" on your vehicle's placard.
2. Determine the combined weight of the driver and passengers that will be riding in your vehicle.
3. Subtract the combined weight of the driver and passengers from XXX kg or XXX lbs
4. The resulting figure equals the available amount of cargo and luggage load capacity.

For example, if the “XXX” amount equals 1,400 lbs and there will be five 150 lbs passengers in your vehicle, the amount of available cargo and luggage load capacity is 650 lbs (1,400–750 (5 x 150) = 650 lbs)

5. Determine the combined weight of luggage and cargo being loaded on the vehicle. That weight may not safely exceed the available cargo and luggage load capacity calculated in Step 4.
6. If your vehicle will be towing a trailer, load from your trailer will be transferred to your vehicle. Consult this manual to determine how this reduces the available cargo and luggage load capacity of your vehicle.

## Load

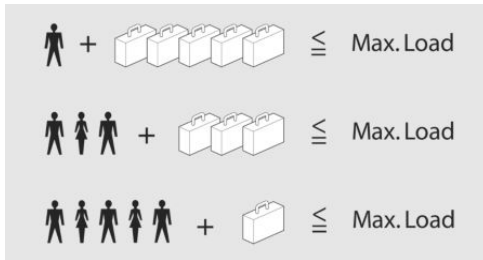

The maximum load is the sum of the weight of the occupants and the cargo.

The greater the weight of the occupants, the less cargo that can be transported.

## Stowing and securing cargo

- ▶ Cover sharp edges and corners on the cargo.
- ▶ Heavy cargo: stow as far forward as possible, directly behind and at the bottom of the rear passenger seat backrests.
- ▶ Very heavy cargo: when the rear seat is not occupied, secure each of the outer safety belts in the opposite buckle.

- ▶ The cargo area can be expanded to transport large or bulky cargo, refer to page 212.
- ▶ Do not stack cargo above the top edge of the backrests.
- ▶ Use the cargo area partition net, refer to page 215, to protect occupants. Make sure that objects cannot penetrate the cargo area partition net.
- ▶ Smaller and light cargo: secure with ratchet straps or draw straps.
- ▶ Larger and heavy cargo: secure with cargo straps.

## Lashing eyes in the cargo area

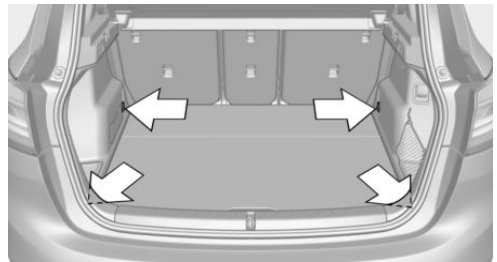

There are four lashing eyes in the cargo area for securing cargo.

Attach load securing aids, such as lashing straps, tensioning straps, draw straps or cargo nets, to the lashing eyes in the cargo area.

Only use the lower lashing eyes to secure the cargo with the cargo area partition net.

## Roof-mounted luggage rack

### General information

Installation only possible with roof rack.

Roof racks are available as special accessories.

## Safety information

### WARNING

When driving with a roof load, for instance with roof-mounted luggage rack, the vehicle's center of gravity is higher, which increases the risk of the vehicle tipping in critical driving situations. There is a risk of accidents or risk of damage to property. Do not deactivate DSC Dynamic Stability Control when driving with roof load.

## Securing

Follow the installation instructions of the roof rack.

## Loading

Because roof-mounted luggage racks raise the vehicle's center of gravity when loaded, they have a major effect on vehicle handling and steering response.

Therefore, note the following when loading and driving:

- ▶ Do not exceed the approved roof/axle loads and the approved gross vehicle weight.
- ▶ Be sure that adequate clearance is maintained for tilting and opening the glass sunroof.
- ▶ Distribute the roof load uniformly.
- ▶ The roof load should not extend past the loading area.
- ▶ Always place the heaviest pieces on the bottom.
- ▶ Secure the roof luggage firmly, for instance using ratchet straps.
- ▶ Do not let objects project into the opening path of the tailgate.
- ▶ Drive cautiously and avoid sudden acceleration and braking maneuvers. Take corners gently.

# Saving fuel

## Vehicle features and options

---

This chapter describes all standard, country-specific and optional features offered with the series. It also describes features that are not necessarily available in your vehicle, e. g., due to the selected options or country versions. This also applies to safety-related functions and systems. When using these functions and systems, the applicable laws and regulations must be observed.

## General information

---

The vehicle contains advanced technologies for the reduction of consumption and emission values.

Fuel consumption depends on a number of different factors.

Carrying out certain measures, such as a moderate driving style and regular maintenance, can influence fuel consumption and the environmental impact.

## Remove unnecessary cargo

---

Additional weight increases fuel consumption.

## Remove attached parts following use

---

Remove roof-mounted luggage racks which are no longer required following use.

Attached parts on the vehicle impair the aerodynamics and increase the fuel consumption.

## Close the windows and glass sunroof

---

Driving with the glass sunroof and windows open results in increased air resistance and thereby reduces the range.

## Tires

---

### General information

Tires can affect consumption in various ways, for instance tire size may influence consumption.

### Check the tire inflation pressure regularly

Check and, if needed, correct the tire inflation pressure at least twice a month and before starting on a long trip.

Low tire inflation pressure increases rolling resistance and thus raises fuel consumption and tire wear.

### Drive away immediately

---

Do not wait for the engine to warm-up while the vehicle remains stationary. Start driving right away, but at moderate engine speeds.

This is the quickest way of warming the cold engine up to operating temperature.

### Look well ahead when driving

---

Driving smoothly and proactively reduces fuel consumption.

Avoid unnecessary acceleration and braking.



By maintaining a suitable distance to the vehicle driving ahead of you.

## Avoid high engine speeds

---

Driving at low engine speeds lowers fuel consumption and reduces wear.

If necessary, observe the vehicle's gear shift indicator, refer to page [134](#).

## Use coasting

---

When approaching a red light, take your foot off the accelerator and let the vehicle coast to a halt.

For going downhill take your foot off the accelerator and let the vehicle roll.

The flow of fuel is interrupted while coasting.

## Switch off the engine during longer stops

---

### Switching off the engine

Switch off the engine during longer stops, for instance at traffic lights, railroad crossings or in traffic congestion.

### Auto Start/Stop function

The Auto Start/Stop function of the vehicle automatically switches off the engine during a stop.

If the engine is switched off and then restarted rather than leaving the engine running constantly, fuel consumption and emissions are reduced. Savings can begin within a few seconds of switching off the engine.

In addition, fuel consumption is also determined by other factors, such as driving style, road conditions, maintenance or environmental factors.

## Switch off any functions that are not currently needed

---

Functions such as seat heating and the rear window defroster require a lot of energy and reduce the range, especially in city and stop-and-go traffic.

Switch off these functions if they are not needed.

The ECO PRO driving mode supports the energy conserving use of comfort features. These functions are automatically deactivated partially or completely.

## Have maintenance carried out

---

Have the vehicle maintained regularly to achieve optimal vehicle efficiency and service life. BMW recommends that maintenance work be performed by a BMW dealer's service center.

For information on the BMW Maintenance System, refer to page [271](#).

## ECO PRO

---

### Concept

ECO PRO supports a driving style that saves on consumption. For this purpose, the engine control and comfort features, for instance the climate control output, are adjusted.

In addition, context-sensitive instructions are displayed to assist with an efficient driving style.

The achieved extended range is displayed in the instrument cluster as bonus range.

### General information

The system includes the following EfficientDynamics functions and EfficientDynamics displays:

- ▷ ECO PRO bonus range, refer to page 234.
- ▷ Activate/deactivate the display, refer to page 234.
- ▷ ECO PRO climate control, refer to page 233.
- ▷ Coasting driving condition, refer to page 235.
- ▷ Driving style analysis, refer to page 236.

## Overview



Driving Dynamics Control

## Activating ECO PRO



Press the button repeatedly until ECO PRO is displayed in the instrument cluster.

## Configuring ECO PRO

### Via the Driving Dynamics Control

1. Activate ECO PRO.
2. "Configure ECO PRO"
3. Select the desired setting.

### Via iDrive

1. "My Vehicle"
2. "Vehicle settings"
3. If necessary, "Driving mode"
4. "Configure ECO PRO"
5. Select the desired setting.

Settings are stored for the profile currently used.

## Activating/deactivating the functions

The following functions can be activated/deactivated:

- ▷ "ECO PRO speed warning"
- ▷ "ECO PRO climate control"
- ▷ "Coasting"

Settings are stored for the driver profile currently used.

## ECO PRO limit

- ▷ Activate the ECO PRO limit:  
"ECO PRO speed warning":

An ECO PRO tip is displayed if the speed of the set ECO PRO limit is exceeded.

- ▷ Adjust the ECO PRO limit speed:  
"Tip at:"  
Select the desired speed.

## ECO PRO climate control

"ECO PRO climate control"

Climate control is set to be efficient.

That is, it is possible to deviate slightly from the set temperature or to heat or cool the car's interior more slowly, to economize on consumption.

In addition, the power output to the seat and mirror heating is reduced.

## Coasting

Efficiency can be optimized by disengaging the engine and coasting with the engine idling.

Deactivate the function to use the braking effect of the engine when traveling downhill.

## ECO PRO potential savings

Shows potential savings with the current settings in percentages.

## Display in the instrument cluster

### ECO PRO bonus range

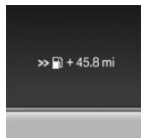

A modified driving style helps you extend your driving range.

The range extension can be displayed as the bonus range in the instrument cluster.

The bonus range is shown in the range display.

The bonus range is automatically reset every time the vehicle is refueled.

### ECO PRO efficiency display

The color of the ECO PRO displays in the instrument cluster tell you how efficiently you are driving:

- ▷ Blue display: efficient driving style.
- ▷ Gray display: modify driving style, for example by backing off the accelerator pedal.

The display switches to blue as soon as all conditions for efficient driving are met.

Depending on your vehicle's equipment, the ECO PRO displays also inform you about your current driving style. This is indicated by a pointer which moves along a scale. The pointer tells you whether energy is being consumed to accelerate the vehicle or whether energy is being recovered through coasting or braking. If the pointer remains in the blue range on the scale, you are driving efficiently.

### ECO PRO tip, driving tip



The ECO PRO tip indicates that your driving style can be modified to be more efficient, for example by backing off the accelerator.

### Activating/deactivating the display

1. "My Vehicle"
2. "iDrive settings"
3. "Displays"

4. "Instrument panel"
5. "ECO PRO info"

### ECO PRO tip, symbols

An additional symbol and text instructions are displayed.

Symbol	Measure
	For efficient driving back off the accelerator or delay accelerating to allow time to assess road conditions.
	Reduce speed to the selected ECO PRO speed.
	Steptronic transmission: Switch from M/S to D and avoid manual shift interventions.





## Indications on the Control Display

### Displaying EfficientDynamics information

The current efficiency of the ECO PRO functions can be displayed on the Control Display.

Via iDrive:

1. "My Vehicle"
2. "Technology in action"
3. "EfficientDynamics"
4.  Select the symbol.

The following functions are displayed:

- ▷ Auto Start/Stop function.
- ▷ Energy recovery.
- ▷ Coasting.

### Displaying consumption history



The average consumption can be displayed on the Control Display.

Via iDrive:



1. "My Vehicle"
2. "Technology in action"
3. "EfficientDynamics"
4.  Select the symbol.

Vertical bars show consumption for the selected time frame.

## Adjusting the consumption history time frame

1. "My Vehicle"
2. "Technology in action"
3. "EfficientDynamics"
4.  Select the symbol.
5.  Press button.
6. Adjust the time frame.

## Resetting consumption history

1. "My Vehicle"
2. "Technology in action"
3. "EfficientDynamics"
4.  Select the symbol.
5.  Press button.
6. "Reset consumption history"

## Coasting

### Concept

This function helps to save fuel.

To do this, under certain conditions the engine is automatically decoupled from the transmission when selector lever position D is set. The vehicle continues traveling with the engine idling to reduce consumption. Selector lever position D remains engaged.

This driving condition is referred to as coasting.

As soon as you step on the brake or accelerator pedal, the engine is automatically coupled again.

## General information

Coasting is a component of the ECO PRO driving mode.

Coasting is automatically activated when ECO PRO mode is called via the Driving Dynamics Control.

A proactive driving style helps the driver to use the function as often as possible and supports the efficient effect of coasting.

## Functional requirements

The function is available in the speed range from approx. 15 mph/25 km/h up to 100 mph/160 km/h.

The function is active if the following conditions are met:

- ▶ Accelerator pedal and brake pedal not depressed.
- ▶ The selector lever is in selector lever position D.
- ▶ Engine and transmission are at operating temperature.
- ▶ With a camera in the area of the interior mirror: the system does not detect any vehicles ahead of you.
- ▶ With the route-ahead assistant: the system does not detect any obstructive traffic situations or routes.

## Operation via shift paddles

### Concept

Depending on your vehicle's equipment, the coasting mode can be influenced with the shift paddles.

### Activating/deactivating coasting via shift paddles

1. Shift to the highest gear by pulling the right shift paddle.
2. To activate coasting mode, actuate the right shift paddle again.

To deactivate, actuate the left shift paddle.

## Display

### Display in the instrument cluster

The mark in the efficiency display is backlit in blue and is located at the zero point. The tachometer shows the idle speed.

The coasting point indicator is illuminated at the zero point during coasting.

### Indications on the Control Display

The coasting mode is displayed in EfficientDynamics while driving.

The distance traveled in coasting mode is shown in the consumption history. The counter is reset prior to every departure.

### Displaying EfficientDynamics information

Via iDrive:

1. "My Vehicle"
2. "Technology in action"
3. "EfficientDynamics"
4.  Select the symbol.

## System limits

The function is not available if one of the following conditions applies:

- ▶ DSC OFF or TRACTION activated.
- ▶ If cruise control is activated.
- ▶ If driving in the dynamic limit range.
- ▶ If driving on steep uphill or downhill grades.
- ▶ If the battery charge state is temporarily too low.
- ▶ If the vehicle electrical system is drawing excessive current.

## Driving style analysis

### Concept

The function helps develop an especially efficient driving style and to conserve fuel.

For this purpose, the driving style is analyzed. The assessment is done in various categories and is displayed on the Control Display.

This display will help you adjust your driving style and save some fuel.

The last 15 minutes of a trip are evaluated.

The range of the vehicle can be extended by adopting an efficient driving style.

This gain in range is displayed as a bonus range in the instrument cluster and on the Control Display.

### Functional requirement

This function is available in ECO PRO mode.

### Calling up ECO PRO driving style analysis

Via iDrive:

1. "My Vehicle"
2. "Technology in action"
3. "Driving style analysis"

### Display on the Control Display

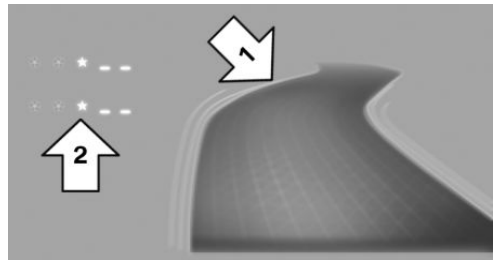

The display of the ECO PRO driving style analysis consists of a symbolized route and a lookup table.

The road symbolizes the efficiency of the driving style. The more efficient your driving style, the smoother the depicted route becomes, arrow 1.

The table of values contains stars. The more efficient the driving style, the more stars are included in the table and the faster the bonus range increases, arrow 2.

If, on the other hand, the driving style is inefficient, a more wavy road and a reduced number of stars are displayed.

To assist with an efficient driving style, ECO PRO tips are displayed during driving.

Tips for an energy-saving driving style, Saving fuel, refer to page [231](#).



 **MOBILITY**

Refueling .....	240
Fuel .....	242
Wheels and tires .....	244
Engine compartment .....	262
Engine oil .....	265
Coolant .....	269
Maintenance .....	271
Replacing components .....	273
Breakdown assistance .....	283
Care .....	290



# Refueling

## Vehicle features and options

This chapter describes all standard, country-specific and optional features offered with the series. It also describes features that are not necessarily available in your vehicle, e. g., due to the selected options or country versions. This also applies to safety-related functions and systems. When using these functions and systems, the applicable laws and regulations must be observed.

## General information

Follow the fuel recommendation, refer to page 242, prior to refueling.

## Safety information

### NOTICE

With a driving range of less than 30 miles/50 km the engine may no longer have sufficient fuel. Engine functions are not ensured anymore. There is a risk of damage to property. Refuel promptly.

## Fuel cap

### Opening

1. Briefly press the rear edge of the fuel filler flap.



2. Turn the fuel cap counterclockwise.

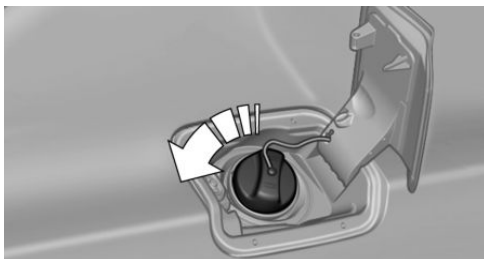

3. Place the fuel cap in the bracket attached to the fuel filler flap.

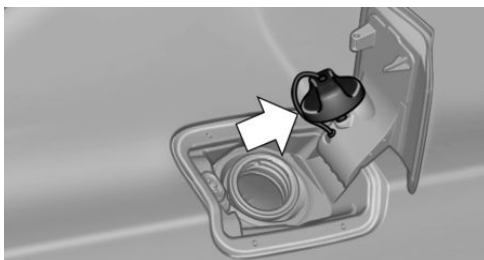

## Closing

### **WARNING**

The retaining strap of the fuel cap can be jammed and crushed during closing. The cap cannot be correctly closed. Fuel or fuel vapors can escape. There is a risk of injury or risk of damage to property. Pay attention that the retaining strap is not jammed or crushed when closing the cap.

1. Fit the cap and turn it clockwise until you clearly hear a click.
2. Close the fuel filler flap.

## Manually unlocking fuel filler flap

It may be necessary in certain situations to unlock the fuel filler flap manually, e.g. with an electrical fault.

Have fuel filler flap unlocked by a dealer's service center or another qualified service center or repair shop.

## Follow the following when refueling

### General information

When refueling, insert the filler nozzle completely into the filler pipe. Lifting up the fuel pump nozzle during refueling causes:

- Premature switching off.
- Reduced return of the fuel vapors.

The fuel tank is full when the filler nozzle clicks off the first time.

Make sure that the fuel cap is closed properly after refueling, otherwise the emissions warning light may light up.

Follow safety regulations posted at the gas station.

## Safety information

### **NOTICE**

Fuels are toxic and aggressive. Overfilling of the fuel tank can damage the fuel system. Painted surfaces may be damaged by contact with fuel. Escaping fuel can harm the environment. There is a risk of damage to property. Avoid overfilling.

# Fuel

## Vehicle features and options

This chapter describes all standard, country-specific and optional features offered with the series. It also describes features that are not necessarily available in your vehicle, e. g., due to the selected options or country versions. This also applies to safety-related functions and systems. When using these functions and systems, the applicable laws and regulations must be observed.

## Fuel recommendation

### General information

Depending on the region, many gas stations sell fuel that has been customized to winter or summer conditions. Fuel that is available in winter, for instance helps make a cold start easier.

### Gasoline

#### General information

For the best fuel efficiency, the gasoline should be sulfur-free or very low in sulfur content.

Fuels that are marked on the gas pump as containing metal must not be used.

Fuels with a maximum ethanol content of 25 %, i. e. E10 or E25, may be used for refueling.

Ethanol should meet the following quality standards:

US: ASTM 4806–xx

CAN: CGSB-3.511–xx

xx: comply with the current standard in each case.

## Safety information

### NOTICE

Even small quantities of the wrong fuel or wrong fuel additives can damage the fuel system and engine. Furthermore, the catalytic converter is permanently damaged. There is a risk of damage to property. Do not refuel or add the following in the case of gasoline engines:

- ▷ Leaded gasoline.
- ▷ Metallic additives, for instance manganese or iron.

Do not press the Start/Stop button after refueling with the wrong fuel. Contact a dealer's service center or another qualified service center or repair shop.

### NOTICE

Incorrect fuels can damage the fuel system and the engine. There is a risk of damage to property. Do not use fuels with a higher percentage of ethanol than recommended. Do not refuel with fuels containing methanol, e.g. M5 to M100.

### NOTICE

Fuel that does not comply with the minimum quality can compromise engine function or cause engine damage. There is a risk of damage to property. Do not fill with fuel that does not comply with the minimum quality.

**⚠ CAUTION**

The use of poor-quality fuels may result in harmful engine deposits or damage. Additionally, problems relating to drivability, starting and stalling, especially under certain environmental conditions such as high ambient temperature and high altitude, may occur.

If drivability problems are encountered, we recommend switching to a high quality gasoline brand and a higher octane grade — AKI number — for a few tank fills. To avoid harmful engine deposits, it is highly recommended to purchase gasoline from Top Tier retailers.

Failure to comply with these recommendations may result in the need for unscheduled maintenance.

**Recommended fuel grade**

BMW recommends AKI 91.

**Minimum fuel grade**

BMW recommends AKI 89.

If you use gasoline with this minimum AKI Rating, the engine may produce knocking sounds when starting at high external temperatures. This has no effect on the engine life.

**BMW recommends**  
**Shell Quality Fuels** 

# Wheels and tires

## Vehicle features and options

This chapter describes all standard, country-specific and optional features offered with the series. It also describes features that are not necessarily available in your vehicle, e. g., due to the selected options or country versions. This also applies to safety-related functions and systems. When using these functions and systems, the applicable laws and regulations must be observed.

## Tire inflation pressure

### General information

The tire inflation pressure and tire characteristics influence the following:

- ▷ The service life of the tires.
- ▷ Road safety.
- ▷ Driving comfort.
- ▷ Driving dynamics.
- ▷ Fuel consumption.

### Safety information

#### WARNING

A tire with too little or no tire inflation pressure may heat up significantly and sustain damage. This will have a negative impact on aspects of handling, such as steering and braking response. There is a risk of an accident. Regularly check the tire inflation pressure, and correct it as needed, for instance twice a month and before a long trip.

## Tire inflation pressure specifications

### In the tire inflation pressure table

The tire inflation pressure table, refer to page 245, contains all tire inflation pressure specifications for the specified tire sizes at the ambient temperature. The tire inflation pressure values apply to tire sizes approved by the manufacturer of the vehicle for the vehicle type.

To identify the correct tire inflation pressure, please note the following:

- ▷ Tire sizes of your vehicle.
- ▷ Maximum permitted driving speed.

## Checking the tire inflation pressure

### General information

Tires heat up while driving. The tire inflation pressure increases with the tire temperature.

Tires have a natural, consistent loss of tire inflation pressure.

The displays of inflation devices may under-read by up to 0.1 bar/2 psi.

## Checking using tire inflation pressure specifications in the tire inflation pressure table

The tire inflation pressure specifications in the tire inflation pressure table only relate to cold tires or tires at the same temperature as the ambient temperature.

Only check the tire inflation pressure levels when the tires are cold, i.e.:

- ▷ Driving range of max. 1.25 miles/2 km has not been exceeded.
- ▷ If the vehicle has not moved again for at least 2 hours after a trip.

Also check the tire inflation pressure of the emergency wheel in the cargo area regularly, and correct it as needed.

1. Determine, refer to page 244, the intended tire inflation pressure levels for the mounted tires.
2. Check the tire inflation pressure in all four tires, using a pressure gage, for example.
3. Correct the tire inflation pressure if the current tire inflation pressure value deviates from the specified value.
4. Check whether all valve caps are screwed onto the tire valves.

### After correcting the tire inflation pressure

For run-flat tires: reinitialize run-flat tires.

For the Tire Pressure Monitor TPM: reset the Tire Pressure Monitor TPM.

### Tire inflation pressures up to 100 mph/160 km/h

For speeds of up to 100 mph/160 km/h and for optimum driving comfort, note the tire inflation pressure values in the tire inflation pressure table, refer to page 245, and adjust as necessary.



These tire inflation pressure values can also be found on the tire inflation pressure label on the driver's door pillar.

Do not exceed a speed of 100 mph/160 km/h.

### Tire inflation pressure values up to 100 mph/160 km/h

#### X1 sDrive28i, X1 xDrive28i

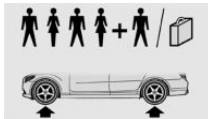
Tire size	Pressure specifications in bar/PSI	
Specifications in bar/PSI with cold tires		
225/50 R 18 95 V M+S A/S Std/RSC	2.2 / 32	2.2 / 32
225/50 R 18 95 W RSC		
225/50 R 18 95 H M+S RSC		
225/45 R 19 92 W RSC	2.5 / 36	2.5 / 36
Emergency wheel:	Speed up to a max. of 50 mph / 80 km/h	
T 135/90 R 17 104 M	4.2 / 60	

### Tire inflation pressures at max. speeds above 100 mph/160 km/h

#### WARNING

In order to drive at maximum speeds in excess of 100 mph/160 km/h, please observe, and, if necessary, adjust tire pressures for speeds exceeding 100 mph/160 km/h from the relevant table on the following pages. Otherwise, tire damage and accidents could occur.

For speeds over 100 mph/160 km/h and for optimum driving comfort, note the pressure values in the tire inflation pressure table, refer to page 246, and adjust as necessary.

## Tire inflation pressure values over 100 mph/160 km/h

### X1 sDrive28i, X1 xDrive28i

Without high-speed tuning feature

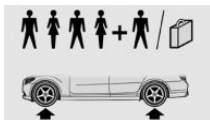
Tire size	Pressure specifications in bar/PSI	
Specifications in bar/PSI with cold tires		
225/50 R 18 95 V M+S A/S Std/RSC	2.5 / 36	2.5 / 36
225/50 R 18 95 H M+S RSC		
225/50 R 18 95 W RSC		
225/45 R 19 92 W RSC	2.7 / 39	2.7 / 39
Emergency wheel:	Speed up to a max. of 50 mph / 80 km/h	
T 135/90 R 17 104 M	4.2 / 60	

With high-speed tuning feature

## Tire size Pressure specifications in bar/PSI

Specifications in bar/PSI with cold tires

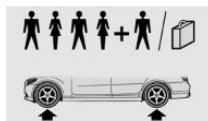

225/50 R 18 95 V M+S A/S Std/RSC	2.8 / 41	2.8 / 41
225/50 R 18 95 H M+S RSC		
225/50 R 18 95 W RSC		
225/45 R 19 92 W RSC	3.0 / 44	3.0 / 44
Emergency wheel:	Speed up to a max. of 50 mph / 80 km/h	
T 135/90 R 17 104 M	4.2 / 60	

## Tire identification marks

### Tire size

245/45 R 18 96 Y

245: nominal width in mm

45: aspect ratio in %

R: radial tire code

18: rim diameter in inches

96: load rating, not for ZR tires

Y: speed rating, before the R on ZR tires

### Maximum tire load

Maximum tire load is the maximum permissible weight for which the tire is approved.

Locate the maximum tire load on the tire sidewall and the Gross Axle Weight Rating – GAWR – on the certification label on the driver's door pillar.

Divide the tire load by 1.1. It must be greater than one-half of the vehicle's Gross Axle Weight Rating – GAWR. Note, front vs. rear GAWR and tire loads, respectively.

## Speed letter

Q = up to 100 mph/160 km/h

R = up to 106 mph/170 km/h

S = up to 112 mph/180 km/h

T = up to 118 mph/190 km/h

H = up to 131 mph/210 km/h

V = up to 150 mph/240 km/h

W = up to 167 mph/270 km/h

Y = up to 186 mph/300 km/h

## Tire Identification Number

DOT code: DOT xxxx xxx 3818

xxxx: manufacturer code for the tire brand

xxx: tire size and tire design

3818: tire age

Tires with DOT codes meet the guidelines of the U.S. Department of Transportation.

## Tire age

## Recommendation

Regardless of the tire tread, replace tires at least every 6 years.

## Manufacture date

You can find the manufacture date of the tire on the tire's sidewall.

Designation	Manufacture date
DOT ... 3818	38th week, 2018

## Uniform Tire Quality Grading

Quality grades can be found where applicable on the tire sidewall between tread shoulder and maximum section width.

E.g.: Treadwear 200; Traction AA; Temperature A

## DOT Quality Grades

Treadwear

Traction AA A B C

Temperature A B C

All passenger vehicle tires must conform to Federal Safety Requirements in addition to these grades.

## Treadwear

The treadwear grade is a comparative rating based on the wear rate of the tire when tested under controlled conditions on a specified government test course. E.g., a tire graded 150 would wear one and one-half, 1 g, times as well on the government course as a tire graded 100. The relative performance of tires depends upon the actual conditions of their use, however, and may depart significantly from the norm due to variations in driving habits, service practices and differences in road characteristics and climate.

## Traction

The traction grades, from highest to lowest, are AA, A, B, and C.

Those grades represent the tire's ability to stop on wet pavement as measured under controlled conditions on specified government test surfaces of asphalt and concrete. A tire marked C may have poor traction performance.

The traction grade assigned to this tire is based on straight-ahead braking traction tests, and does not include acceleration, cornering, hydroplaning, or peak traction characteristics.

## Temperature

The temperature grades are A, the highest, B, and C, representing the tire's resistance to the generation of heat and its ability to dissipate heat when tested under controlled conditions on a specified indoor laboratory test wheel. Sustained



high temperature can cause the material of the tire to degenerate and reduce tire life, and excessive temperature can lead to sudden tire failure. The grade C corresponds to a level of performance which all passenger vehicle tires must meet under the Federal Motor Vehicle Safety Standard No. 109. Grades Band A represent higher levels of performance on the laboratory test wheel than the minimum required by law.

### **⚠ WARNING**

The temperature grade for this tire is established for a tire that is properly inflated and not overloaded. Excessive speed, underinflation, or excessive loading, either separately or in combination, can cause heat buildup and possible tire failure.

## RSC – Run-flat tires

Run-flat tires, refer to page 251, are labeled with a circular symbol containing the letters RSC marked on the sidewall.

## M+S

Winter and all-season tires with better cold weather performance than summer tires.

## Tire tread

### Summer tires

Do not drive with a tire tread of less than 0.12 in/3 mm, otherwise there is an increased risk of hydroplaning.

### Winter tires

Do not drive with a tire tread of less than 0.16 in/4 mm, as such tires are less suitable for winter operation.

## Minimum tread depth

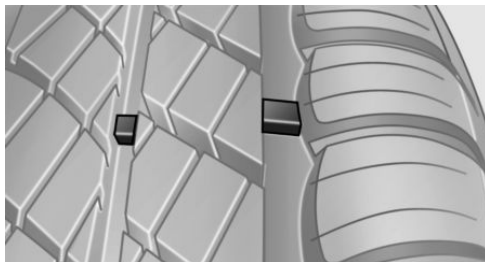

Wear indicators are distributed around the tire's circumference and have the legally required minimum height of 0.063 inches/1.6 mm.

The positions of the wear indicators are marked on the tire sidewall with TWI, Tread Wear Indicator.

## Tire damage

### General information

Inspect your tires regularly for damage, foreign objects lodged in the tread, and tread wear.

Driving over rough or damaged road surfaces, as well as debris, curbs and other obstacles can cause serious damage to wheels, tires and suspension parts. This is more likely to occur with low-profile tires, which provide less cushioning between the wheel and the road. Be careful to avoid road hazards and reduce your speed, especially if your vehicle is equipped with low-profile tires.

Indications of tire damage or other vehicle malfunctions:

- ▷ Unusual vibrations.
- ▷ Unusual tire or running noises.
- ▷ Unusual handling such as a strong tendency to pull to the left or right.

Damage can be caused by the following situations, for instance:

- ▷ Driving over curbs.
- ▷ Road damage.

- ▷ Tire inflation pressure too low.
- ▷ Vehicle overloading.
- ▷ Incorrect tire storage.

## Safety information

### WARNING

Damaged tires can lose tire inflation pressure, which can lead to loss of vehicle control. There is a risk of an accident. If tire damage is suspected while driving, immediately reduce speed and stop. Have wheels and tires checked. For this purpose, drive carefully to the nearest dealer's service center or another qualified service center or repair shop. Have vehicle towed or transported as needed. Do not repair damaged tires, but have them replaced.

### WARNING

Tires can become damaged by driving over obstacles, e.g., curbs or road damage, at high speed. Larger wheels have a smaller tire cross-section. The smaller the tire cross-section, the higher the risk of tire damage. There is a danger of accidents and property damage. If possible, drive around obstacles, or drive over them slowly and carefully.

## Changing wheels and tires

### Mounting

Have mounting and wheel balancing carried out by a dealer's service center or another qualified service center or repair shop.

### Wheel and tire combination

#### General information

You can ask the dealer's service center or another qualified service center or repair shop

about the correct wheel/tire combination and wheel rim versions for the vehicle.

## Safety information

### WARNING

Wheels and tires which are not suitable for your vehicle can damage parts of the vehicle, for instance due to contact with the body due to tolerances despite the same official size rating. There is a risk of an accident. The manufacturer of your vehicle strongly suggests that you use wheels and tires that have been recommended by the vehicle manufacturer for your vehicle type.

### WARNING

Incorrect wheel/tire combinations will have a negative impact on the vehicle's handling and on the function of a variety of systems, such as the Anti-lock Brake System or Dynamic Stability Control. There is a risk of an accident. To maintain good handling and vehicle response, use only tires with a single tread configuration from a single manufacturer. The manufacturer of the vehicle recommends that you use wheels and tires that have been recommended by the vehicle manufacturer for your vehicle type. Following tire damage, have the original wheel/tire combination remounted on the vehicle as soon as possible.

## Recommended tire brands



For each tire size, the manufacturer of the vehicle recommends certain tire brands. The tire brands can be identified by a star on the tire sidewall.

## New tires

Tire traction is not optimal due to manufacturing circumstances when tires are brand-new; they achieve their full traction potential after a break-in time.

Drive conservatively for the first 200 miles/300 km.

## Retreaded tires

### WARNING

Retreaded tires can have different tire casing structures. With advanced age the service life can be limited. There is a risk of an accident. The manufacturer of your vehicle does not recommend the use of retreaded tires.

The manufacturer of your vehicle does not recommend the use of retreaded tires.

## Winter tires

Winter tires are recommended for operating on winter roads.

Although so-called all-season M+S tires provide better winter traction than summer tires, they usually do not provide the same level of performance as winter tires.

## Maximum speed of winter tires

If the maximum speed of the vehicle is higher than the permissible speed for the winter tires, then attach a label showing the permissible maximum speed in the field of view. The label is available from a dealer's service center or another qualified service center or repair shop.

With winter tires mounted, observe and do not exceed the permissible maximum speed.

## Changing runflat tires

For your own safety, use only runflat tires. No spare tire is available in the case of a flat tire. Further information is available from a dealer's service center or another qualified service center or repair shop.

## Rotating wheels between axles

Different wear patterns can occur on the front and rear axles depending on individual driving conditions. The tires can be rotated in pairs between the axles to achieve even wear. Further information is available from a dealer's service center or another qualified service center or repair shop. After rotating, check the tire pressure and correct, if needed.

## Storing tires

### Tire inflation pressure

Do not exceed the maximum tire inflation pressure indicated on the side wall of the tire.

### Storage

Store wheels and tires in a cool, dry and dark place.

Always protect tires against all contact with oil, grease, and solvents.

Do not leave tires in plastic bags.

Remove dirt from wheels or tires.

## Run-flat tires

### Concept

Run-flat tires permit continued driving under restricted conditions even in the event of a complete loss of tire inflation pressure.

### General information

The wheels consist of tires that are self-supporting, to a limited degree, and possibly special rims.

The support of the sidewall allows the tire to remain drivable to a restricted degree in the event of a tire inflation pressure loss.

Follow the instructions for continued driving with a flat tire.

### Safety information

#### WARNING

Your vehicle handles differently with a run-flat with no or low inflation pressure; for instance, your lane stability when braking is reduced, braking distances are longer and the self-steering properties will change. There is a risk of an accident. Drive moderately and do not exceed a speed of 50 mph/80 km/h.

### Label



The tires are marked on the tire sidewall with RSC Run-flat System Component.

## Repairing a flat tire

### Safety measures

- ▶ Park the vehicle as far away as possible from passing traffic and on solid ground.
- ▶ Switch on the hazard warning system.
- ▶ Secure the vehicle against rolling away by setting the parking brake.
- ▶ Turn the steering wheel until the front wheels are in the straight-ahead position and engage the steering wheel lock.
- ▶ Have all vehicle occupants get out of the vehicle and ensure that they remain outside the immediate area in a safe place, such as behind a guardrail.
- ▶ If necessary, set up a warning triangle at an appropriate distance.

## Mobility System

### Concept

With the Mobility System, minor tire damage can be sealed temporarily to enable continued travel. To accomplish this, sealant is pumped into the tires, which seals the damage from the inside.

### General information

- ▶ Follow the instructions on using the Mobility System found on the compressor and sealant container.
- ▶ Use of the Mobility System may be ineffective if the tire puncture measures approx. 1/8 inches/4 mm or more.
- ▶ Contact a dealer's service center or another qualified service center or repair shop if the tire cannot be made drivable.
- ▶ If possible, do not remove foreign bodies that have penetrated the tire. Only remove foreign objects if they are visibly protruding from the tire.

- ▷ Pull the speed limit sticker off the sealant container and apply it to the steering wheel.
- ▷ The use of a sealant can damage the TPM wheel electronics. In this case, have the TPM wheel electronics replaced at the next opportunity.
- ▷ The compressor can be used to check the tire inflation pressure.

## Overview

### Storage

The Mobility System is located under the cargo floor panel.

### Sealant container

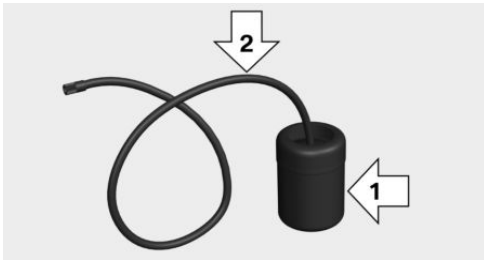

- ▷ Sealant container, arrow 1.
- ▷ Filling hose, arrow 2.

Observe use-by date on the sealant container.

### Compressor

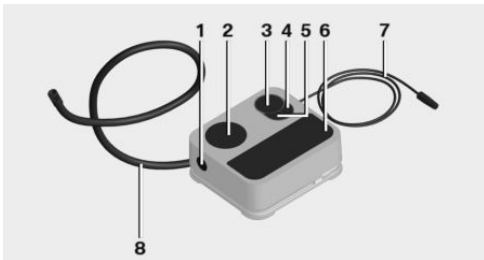

- 1 Sealant container unlocking
- 2 Sealant container holder
- 3 Tire pressure gage

- 4 Reduce tire inflation pressure button
- 5 On/off switch
- 6 Compressor
- 7 Connector/cable for socket
- 8 Connection hose

## Filling the tire with sealant

### Safety information

#### **⚠ DANGER**

If the exhaust pipe is blocked or ventilation is insufficient, harmful exhaust gases can enter into the vehicle. The exhaust gases contain pollutants which are colorless and odorless. In enclosed areas, exhaust gases can also accumulate outside of the vehicle. There is danger to life. Keep the exhaust pipe free and ensure sufficient ventilation.

#### **⚠ NOTICE**

The compressor can overheat during extended operation. There is a risk of damage to property. Do not run the compressor for more than 10 minutes.

### Filling

1. Shake the sealant container.

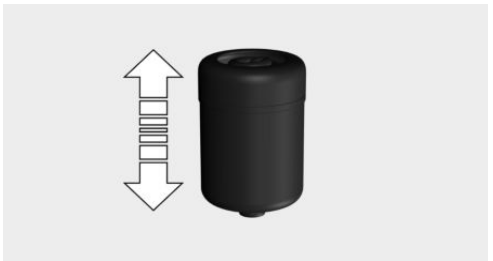

- Pull filling hose completely out of the cover of the sealant container. Do not kink the hose.
- With the compressor switched off, insert the plug into the power socket inside the vehicle.

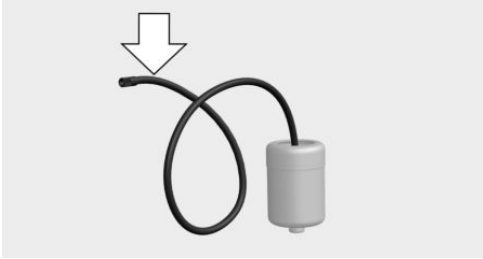

- Slide the sealant container into the holder on the compressor housing, ensuring that it engages audibly.

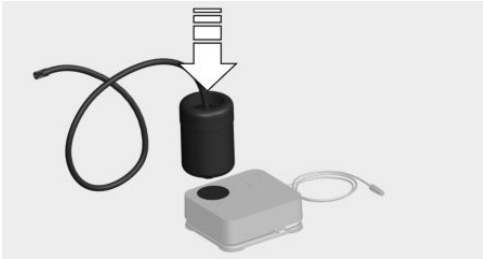

- Screw the filling hose of the sealant container onto the tire valve of the nonworking wheel.

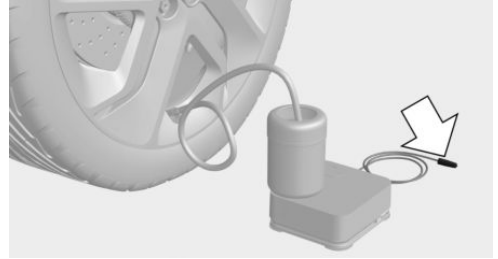
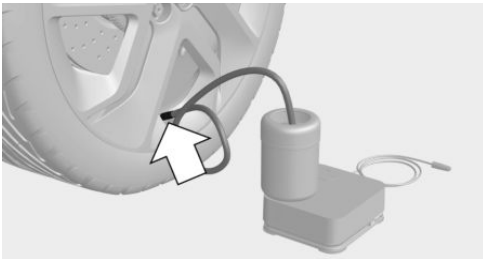

- With the ignition switched on or the engine running, switch on the compressor.

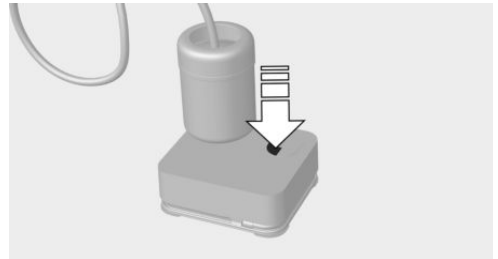

Let the compressor run for max. 10 minutes to fill the tire with sealant and achieve a tire inflation pressure of approx. 2.0 bar.

While the tire is being filled with sealant, the tire inflation pressure may sporadically reach approx. 5 bar. Do not switch off the compressor at this point.

## Checking and adjusting the tire inflation pressure

### Checking

- Switch off the compressor.
- Read the tire inflation pressure on the tire pressure gage.

To continue the trip, a tire inflation pressure of at least 2 bar must be reached.

## Removing and stowing the sealant container

1. Unscrew the filling hose of the sealant container from the tire valve.
2. Press the red unlocking device.
3. Remove the sealant container from the compressor.
4. Wrap and store the sealant container in suitable material to avoid dirtying the cargo area.

## Minimum tire inflation pressure is not reached

1. Pull the connector out of the power socket inside the vehicle.
2. Drive 33 ft/10 m forward and back to distribute the sealant in the tire.
3. Screw the connection hose of the compressor directly onto the tire valve stem.

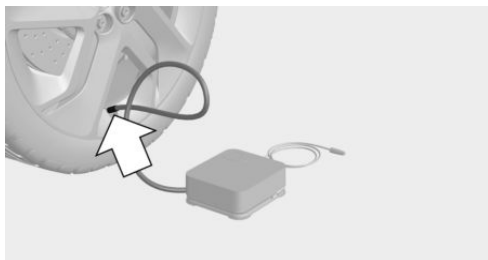

4. Insert the connector into the power socket inside the vehicle.

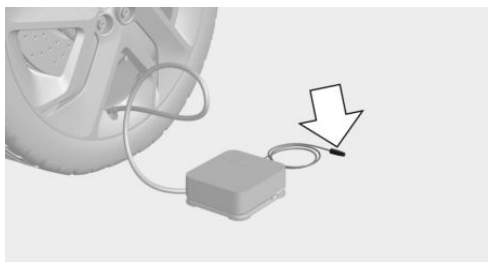

5. With the ignition switched on or the engine running, switch on the compressor.

If a tire inflation pressure of at least 2 bar cannot be reached, contact your dealer's service

center or another qualified service center or repair shop.

If a tire inflation pressure of at least 2 bar is reached, see Minimum tire inflation pressure is reached.

6. Unscrew the connection hose of the compressor from the tire valve.
7. Pull the connector out of the power socket inside the vehicle.
8. Stow the Mobility System in the vehicle.

## Minimum tire inflation pressure is reached

1. Unscrew the connection hose of the compressor from the tire valve.
2. Pull the connector out of the power socket inside the vehicle.
3. Stow the Mobility System in the vehicle.
4. Immediately drive approx. 5 miles/10 km to ensure that the sealant is evenly distributed in the tire.

Do not exceed a speed of 50 mph/80 km/h.

If possible, do not drive at speeds less than 12 mph/20 km/h.

## Adjustment

1. Stop at a suitable location.
2. Screw the connection hose of the compressor directly onto the tire valve stem.

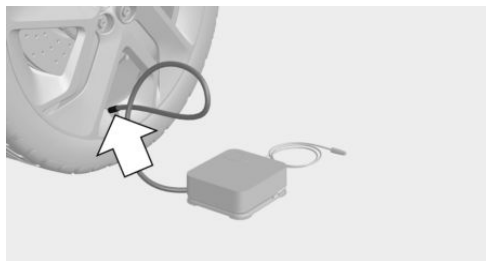

3. Insert the connector into the power socket inside the vehicle.

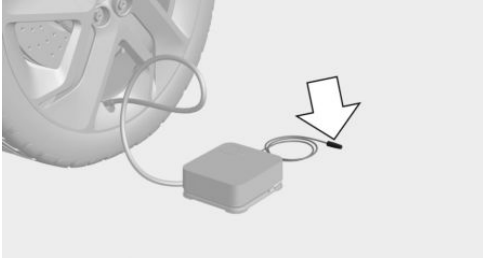

4. Correct the tire inflation pressure to at least 2.0 bar.
  - ▶ Increase tire inflation pressure: with the ignition switched on or the engine running, switch on the compressor.
  - ▶ To reduce the pressure: press the button on the compressor.
5. Unscrew the connection hose of the compressor from the tire valve.
6. Pull the connector out of the power socket inside the vehicle.
7. Stow the Mobility System in the vehicle.

## Continuing the trip

Do not exceed the maximum permissible speed of 50 mph/80 km/h.

Reinitialize the run-flat tires.

Reset the Tire Pressure Monitor TPM.

Replace the nonworking tire and the sealant container of the Mobility System at the next opportunity.

## Snow chains

### Safety information

#### **WARNING**

With the mounting of snow chains on unsuitable tires, the snow chains can come into contact with vehicle parts. There is a risk of accidents or risk of damage to property. Only mount snow chains on tires that are designated by their manufacturer as suitable for the use of snow chains.

#### **WARNING**

Insufficiently tight snow chains may damage tires and vehicle components. There is a risk of accidents or risk of damage to property. Make sure that the snow chains are always sufficiently tight. Re-tighten as needed according to the snow chain manufacturer's instructions.

### Fine-link snow chains

The manufacturer of your vehicle recommends use of fine-link snow chains. Certain types of fine-link snow chains have been tested by the manufacturer of the vehicle and recommended as road-safe and suitable.

Information regarding suitable snow chains is available from a dealer's service center or another qualified service center or repair shop.

### Use

Use only in pairs on the front wheels, equipped with the tires of the following size:

- ▶ 205/60 R 17.

Follow the snow chain manufacturer's instructions.

Do not initialize the run-flat tires after mounting snow chains, as doing so may result in incorrect readings.



Do not reset the Tire Pressure Monitor TPM after mounting snow chains, as doing so may result in incorrect readings.

When driving with snow chains, briefly activate Dynamic Traction Control DTC, if needed.

## Maximum speed with snow chains

Do not exceed a speed of 30 mph/50 km/h when using snow chains.

## Changing wheels/tires

### General information

When using run-flat tires or a flat tire kit, a wheel does not always need to be changed immediately when there is a loss of tire inflation pressure due to a flat tire.

If needed, the tools for changing wheels are available as accessories from a dealer's service center or another qualified service center or repair shop.

### Safety information

#### DANGER

The vehicle jack is only provided for short-term lifting of the vehicle for wheel changes. Even if all safety measures are observed, there is a risk of the raised vehicle falling, if the vehicle jack tips over. There is a risk of injuries or danger to life. If the vehicle is raised, do not lie under the vehicle and do not start the engine.

#### DANGER

Supports such as wooden blocks under the vehicle jack reduce the capacity of the vehicle jack to bear weight. They have the potential to exert too much strain on the vehicle jack, causing it to tip over and the vehicle to fall. There is

a risk of injuries or danger to life. Do not place supports under the vehicle jack.

#### WARNING

The jack, issued by the vehicle manufacturer, is provided in order to perform a wheel change in the event of a breakdown. The jack is not designed for frequent use; for example, changing from summer to winter tires. Using the jack frequently may cause it to become jammed or damaged. There is a risk of injury and risk of damage to property. Only use the jack to attach an emergency or spare wheel in the event of a breakdown.

#### WARNING

On soft, uneven or slippery ground, for example snow, ice, tiles, etc., the vehicle jack can slip away. There is a risk of injury. If possible, change the wheel on a flat, solid, and slip-resistant surface.

#### WARNING

The vehicle jack is optimized for lifting the vehicle and for the jacking points on the vehicle only. There is a risk of injury. Do not lift any other vehicle or cargo using the vehicle jack.

#### WARNING

If the vehicle jack is not inserted into the jacking point provided for this purpose, the vehicle may be damaged or the vehicle jack may slip when it is being cranked up. There is a risk of injury or risk of damage to property. When cranking up the vehicle jack, ensure that it is inserted in the jacking point next to the wheel housing.

**⚠ WARNING**

A vehicle that is raised on a vehicle jack may fall off of the jack if lateral forces are exerted on it. There is a risk of injury and risk of damage to property. While the vehicle is raised, do not exert lateral forces on the vehicle or pull abruptly on the vehicle. Have a stuck wheel removed by a dealer's service center or another qualified service center or repair shop.

## Securing the vehicle against rolling

### General information

The vehicle manufacturer recommends to additionally secure the vehicle against rolling away when changing a wheel.

### On a level surface



Place chocks or other suitable objects, for example a rock, in front of and behind the wheel that is diagonally opposite to the wheel that you wish to change.

## On a slight downhill gradient

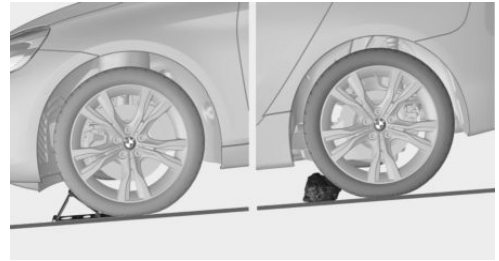

If you need to change a wheel on a slight downhill grade, place chocks and other suitable objects, for instance a rock, under the wheels of both the front and rear axles against the rolling direction.

## Lug bolt lock

### Concept

The wheel lug bolts have a special coding. The lug bolts can only be released with the adapter which matches the coding.

### Overview

The adapter of the lug bolt lock is in the onboard vehicle tool kit or in a storage compartment close to the onboard vehicle tool kit.

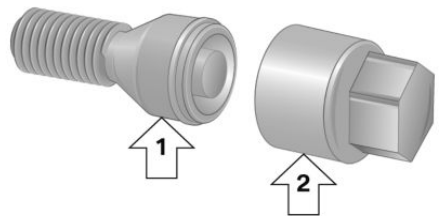

- ▷ Lug bolt, arrow 1.
- ▷ Adapter, arrow 2.

### Unscrewing

1. Attach the adapter to the lug bolt.
2. Unscrew the lug bolt.

3. Remove the adapter after unscrewing the lug bolt.

### Screwing on

1. Attach the adapter to the lug bolt. If necessary, turn the adapter until it fits on the lug bolt.
2. Screw on the lug bolt. The tightening torque is 140 Nm.
3. Remove the adapter and stow it after screwing on the lug bolt.

### Preparing the vehicle

- ▷ Park the vehicle on solid and non-slip ground at a safe distance from traffic.
- ▷ Switch on the hazard warning system.
- ▷ Set the parking brake.
- ▷ Engage a gear or move the selector lever to position P.
- ▷ As soon as permitted by the traffic flow, have all vehicle occupants get out of the vehicle and ensure that they remain outside the immediate area in a safe place, such as behind a guardrail.
- ▷ Depending on the vehicle equipment, get wheel change tools and, if necessary, the emergency wheel from the vehicle.
- ▷ If necessary, set up a warning triangle or portable hazard warning light at an appropriate distance.
- ▷ Secure the vehicle additionally against rolling.
- ▷ Loosen the lug bolts a half turn.

### Jacking points for the vehicle jack

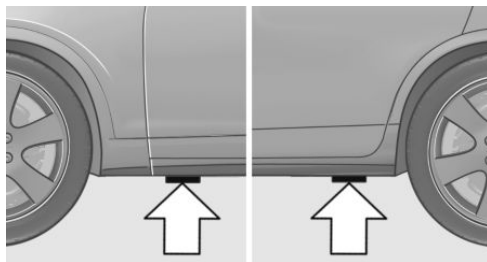

The jacking points for the vehicle jack are located at the indicated positions.

## Jacking up the vehicle

### WARNING

Hands and fingers can be jammed when using the vehicle jack. There is a risk of injury. Comply with the described hand position and do not change this position while using the vehicle jack.

1. Hold the vehicle jack with one hand, arrow 1, and grasp the vehicle jack crank with your other hand, arrow 2.

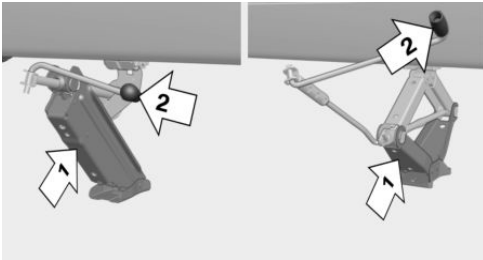

2. Insert the vehicle jack into the rectangular recess of the jacking point closest to the wheel to be changed.

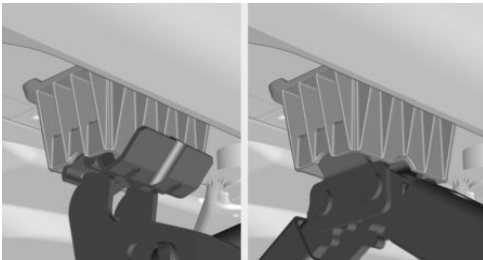

3. Extend the vehicle jack by turning the vehicle jack crank or lever clockwise.

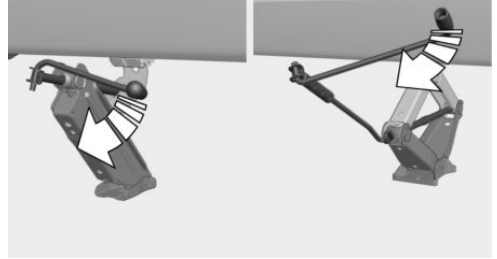

4. Take your hand away from the vehicle jack as soon as the vehicle jack is under load and continue turning the vehicle jack crank or lever with one hand.
5. Make sure that the vehicle jack foot stands vertically and at a right angle beneath the jacking point.

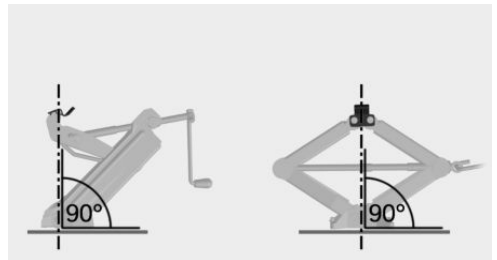

6. Make sure that the vehicle jack foot stands vertically and perpendicularly beneath the jacking point after extending the vehicle jack.

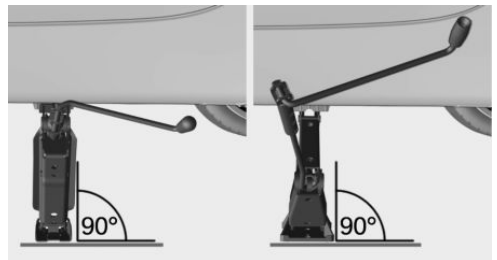

7. Crank up the vehicle jack until the entire surface of the jack is in contact with the ground and the wheel in question is raised a maximum of 1.2 inches/3 cm off the ground.

## Mounting a wheel

Mount one emergency wheel only, as required.

1. Unscrew the lug bolts.
2. Remove the wheel.
3. Put the new wheel or emergency wheel on and screw in at least two lug bolts in a cross-wise pattern until hand-tight.  
If non-original light-alloy wheels of the vehicle manufacturer are mounted, the accompanying lug bolts may have to be used as well.
4. Hand-tighten the remaining lug bolts and tighten all lug bolts well in a crosswise pattern.
5. Turn the vehicle jack crank counterclockwise to retract the vehicle jack and lower the vehicle.
6. Remove the vehicle jack and stow it securely.

## After the wheel change

1. Tighten the lug bolts crosswise. The tightening torque is 101 lb ft/140 Nm.
2. Stow the nonworking wheel in the cargo area, if necessary.  
The nonworking wheel cannot be stored under the cargo floor panel because of its size.
3. Check tire inflation pressure at the next opportunity and correct as needed.
4. Reinitialize the run-flat tires.  
Reset the Tire Pressure Monitor TPM.
5. Check to make sure the lug bolts are tight with a calibrated torque wrench.
6. Have the damaged tire replaced at the nearest dealer's service center or another qualified service center or repair shop.

## Emergency wheel

### Concept

In the event of a flat tire, the emergency wheel can be used in place of the wheel with the defec-

tive tire. The emergency wheel is only intended for temporary use until the defective tire/wheel has been replaced.

## General information

Mount one emergency wheel only.

Also check the tire inflation pressure of the emergency wheel in the cargo area regularly, and correct it as needed.

## Safety information

### WARNING

The emergency wheel has particular dimensions. When driving with an emergency wheel, changed driving properties may occur, for instance reduced lane stability when braking, longer braking distance, and changed self-steering properties in the limit area. There is a risk of an accident. Drive moderately and do not exceed a speed of 50 mph/80 km/h.

## Overview

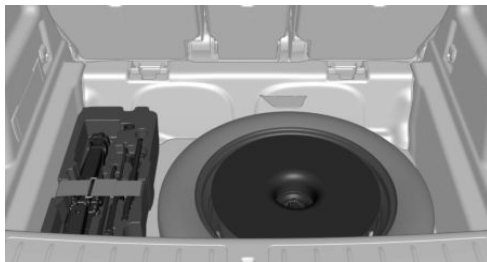

The emergency wheel and the wheel change tools are located in the cargo area under the cargo floor panel.

## Removing the emergency wheel

1. Pull up and remove the cargo floor panel.
2. Unscrew the butterfly screw.
3. Remove the retaining plate or the cover.

4. Where applicable, remove the holder and the trailer hitch.
5. Remove the jacking point and the tool holder on the left next to the emergency wheel.
6. Slide the emergency wheel to the left and remove it.

## Inserting the emergency wheel

1. Insert the emergency wheel on the left and slide it to the right.
2. Where applicable, mount the holder and the trailer hitch.
3. Attach the retaining plate or the cover.
4. Screw on and tighten the butterfly screw.
5. Insert and secure the jacking point and the tool holder on the left next to the emergency wheel.
6. Insert the cargo floor panel.

# Engine compartment

## Vehicle features and options

This chapter describes all standard, country-specific and optional features offered with the series.

It also describes features that are not necessarily available in your vehicle, e. g., due to the selected options or country versions. This also applies to safety-related functions and systems. When using these functions and systems, the applicable laws and regulations must be observed.

## Overview

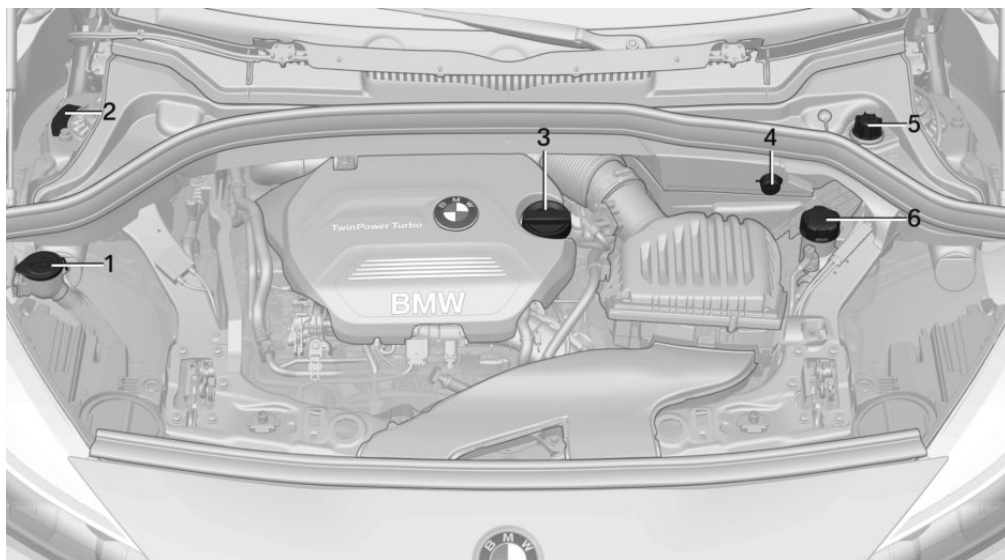

- |   |                               |   |  |
|---|-------------------------------|---|--|
| 1 | Filler neck for washer fluid  | 4 | Jump-starting, positive battery terminal |
| 2 | Vehicle identification number | 5 | Jump-starting, negative battery terminal |
| 3 | Oil filler neck               | 6 | Coolant reservoir                        |

# Hood

## Safety information

### WARNING

Improperly executed work in the engine compartment can damage vehicle components and impair vehicle functions. There is a risk of personal and property damage. The manufacturer of your vehicle recommends that, in the effort to avoid such risks, work in the engine compartment be performed by a dealer's service center or another qualified service center or repair shop.

### WARNING

The engine compartment accommodates moving components. Certain components in the engine compartment can also move with the vehicle switched off, for instance the radiator fan. There is a risk of injury. Do not reach into the area of moving parts. Keep articles of clothing and hair away from moving parts.

### WARNING

There are protruding parts, for instance locking hook, on the inside of the hood. There is a risk of injury. If the hood is open, pay attention to protruding parts and keep clear of these areas.

### WARNING

An incorrectly locked hood can open while driving and restrict visibility. There is a risk of an accident. Stop immediately and correctly close the hood.

### WARNING

Body parts can be jammed when opening and closing the hood. There is a risk of injury. Make sure that the area of movement of the hood is clear during opening and closing.

### NOTICE

Folded-away wipers can be jammed when the hood is opened. There is a risk of damage to property. Make sure that the wipers with the wiper blades mounted are folded down onto the windshield before opening the hood.

### NOTICE

When the hood is closed, it must engage on both sides. Pressing again can damage the hood. There is a risk of damage to property. Open the hood again and then close it energetically. Avoid pressing again.

## Opening the hood

1. Pull lever, arrow 1.  
Hood is unlocked.

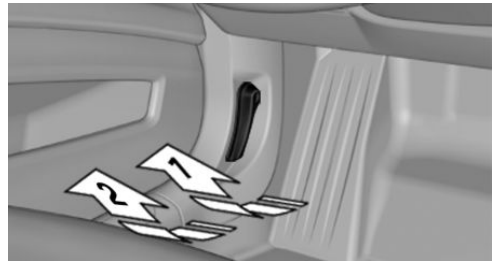

2. After the lever is released, pull the lever again, arrow 2.  
Hood can be opened.

## Indicator/warning lights

When the hood is unlocked, a Check Control message is displayed.



## Closing the hood

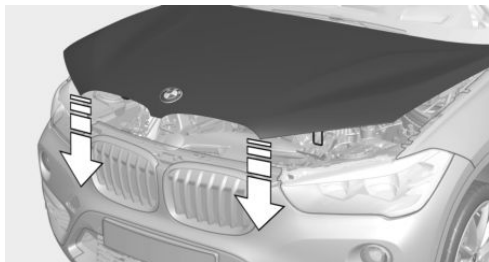

Energetically close the hood from approx.  
20 in/50 cm.

The hood must engage on both sides.

# Engine oil

## Vehicle features and options

This chapter describes all standard, country-specific and optional features offered with the series. It also describes features that are not necessarily available in your vehicle, e. g., due to the selected options or country versions. This also applies to safety-related functions and systems. When using these functions and systems, the applicable laws and regulations must be observed.

## General information

The engine oil consumption is dependent on your driving style and driving conditions.

Therefore, regularly check the engine oil level after refueling by taking a detailed measurement.

The engine oil consumption can increase in the following situations, for example:

- ▷ Sporty driving style.
- ▷ Break-in of the engine.
- ▷ Idling of the engine.
- ▷ With use of engine oil types that are classified as not suitable.

Different Check Control messages appear on the Control Display depending on the engine oil level.

## Safety information

### NOTICE

An engine oil level that is too low causes engine damage. There is a risk of damage to property. Immediately add engine oil.

### NOTICE

Too much engine oil can damage the engine or the catalytic converter. There is a risk of damage to property. Do not add too much engine oil. When too much engine oil is added, have the engine oil level corrected by a dealer's service center or another qualified service center or repair shop.

## Electronic oil measurement

### General information

The electronic oil measurement has two measuring principles:

- ▷ Monitoring.
- ▷ Detailed measurement.

When making frequent short-distance trips or using a dynamic driving style, for instance when taking curves aggressively, regularly perform a detailed measurement.

### Monitoring

#### Concept

The engine oil level is monitored electronically while driving and can be shown on the Control Display.

If the engine oil level is outside its permissible operating range, a Check Control message is displayed.



A red indicator light indicates that the engine oil pressure is too low.

### Functional requirements

A current measured value is available after approx. 30 minutes of normal driving.

## Displaying the engine oil level

Via iDrive:

1. "My Vehicle"
2. "Vehicle status"
3.  "Engine oil level"

The engine oil level is displayed.

## System limits

When making frequent short-distance trips or using a dynamic driving style, it may not be possible to calculate a measured value. In this case, the measured value for the last, sufficiently long trip is displayed.

## Detailed measurement

### Concept

The engine oil level is checked when the vehicle is stationary and displayed via a scale.

If the engine oil level is outside its permissible operating range, a Check Control message is displayed.

### General information

During the measurement, the idle speed is increased somewhat.

### Functional requirements

- ▷ Vehicle is parked in a horizontal position.
- ▷ Steptronic transmission: selector lever in selector lever position N or P and accelerator pedal not depressed.
- ▷ Engine is running and is at operating temperature.

## Performing a detailed measurement

Via iDrive:

1. "My Vehicle"
2. "Vehicle status"
3.  "Engine oil level"

4. "Measure engine oil level"

5. "Start measurement"

The engine oil level is checked and displayed via a scale.

## Adding engine oil

### General information

Only add engine oil when the message is displayed in the instrument cluster. The quantity to be added is indicated in the message displayed in the instrument cluster.

Only add suitable types of engine oil, refer to page 267.

Safely park the vehicle and switch off the ignition before adding engine oil.

Take care not to add too much engine oil.

### Safety information

#### **WARNING**

Operating materials, for instance oils, greases, coolants, fuels, can contain harmful ingredients. There is a risk of injuries or danger to life. Follow the instructions on the containers. Avoid the contact of articles of clothing, skin or eyes with operating materials. Do not refill operating materials into different bottles. Store operating materials out of reach of children.

#### **NOTICE**

An engine oil level that is too low causes engine damage. There is a risk of damage to property. Immediately add engine oil.

**⚠ NOTICE**

Too much engine oil can damage the engine or the catalytic converter. There is a risk of damage to property. Do not add too much engine oil. When too much engine oil is added, have the engine oil level corrected by a dealer's service center or another qualified service center or repair shop.

**Overview**

The oil filler neck is located in the engine compartment, refer to page [262](#).

**Adding engine oil**

1. Open the hood, refer to page [263](#).
2. Open the lid counterclockwise.

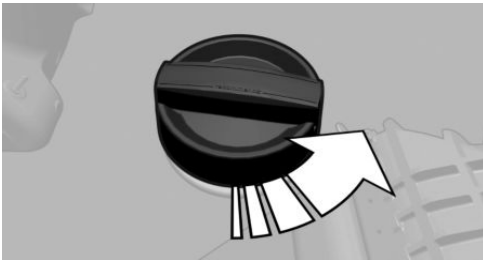

3. Add engine oil.
4. Close the cap.

**Engine oil types to add****General information**

The engine oil quality is critical for the life of the engine.

Only add the types of engine oil which are listed.

**Safety information****⚠ NOTICE**

Oil additives can damage the engine. There is a risk of damage to property. Do not use oil additives.

**⚠ NOTICE**

Incorrect engine oil can cause malfunctions in the engine or damage it. There is a risk of damage to property. When selecting an engine oil, make sure that the engine oil has the correct oil rating.

**Suitable engine oil types**

Add engine oils that meet the following oil rating standards:

**Gasoline engine**

BMW Longlife-01 FE.

BMW Longlife-14 FE+.

BMW Longlife-17 FE+.

**Alternative engine oil types**

If an engine oil suitable for continuous use is not available, up to 1 US quart/liter of an engine oil with the following oil rating can be added:

**Oil rating**

API SL.

API SM.

API SN.



## Viscosity grades

### Viscosity grades

SAE 0W-20.

---

SAE 0W-30.

---

More information about suitable oil ratings and viscosity grades of engine oils can be requested from a dealer's service center or another qualified service center or repair shop.

## Engine oil change

---

### NOTICE

Engine oil that is not changed in timely fashion can cause increased engine wear and thus engine damage. There is a risk of damage to property. Do not exceed the service data indicated in the vehicle.

The vehicle manufacturer recommends that you have a dealer's service center or another qualified service center or repair shop change the engine oil.

**BMW recommends  
Original BMW Engine Oil.**

# Coolant

## Vehicle features and options

This chapter describes all standard, country-specific and optional features offered with the series. It also describes features that are not necessarily available in your vehicle, e. g., due to the selected options or country versions. This also applies to safety-related functions and systems. When using these functions and systems, the applicable laws and regulations must be observed.

## General information

Not all commercially available additives are suitable for the vehicle. Information about suitable additives is available from a dealer's service center or another qualified service center or repair shop.

## Safety information

### **WARNING**

With the engine hot and the cooling system open, coolant can escape and lead to scalding. There is a risk of injury. Only open the cooling system with the engine cooled down.

### **WARNING**

Additives are harmful and incorrect additives can damage the engine. There is a risk of injury and risk of damage to property. Do not allow additives to come into contact with skin, eyes or articles of clothing. Use suitable additives only.

## Coolant level

### Checking

There are yellow Min and Max marks in the coolant reservoir.

1. Let the engine cool.
2. Open the hood.
3. Turn the lid of the coolant reservoir slightly counterclockwise to allow any excess pressure to dissipate, then open it.

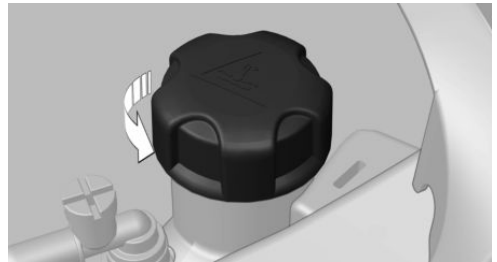

4. Open the coolant reservoir lid.
5. The coolant level is correct if it lies between the minimum and maximum marks in the filler neck.
6. Close the cap.

### Adding

1. Let the engine cool.
2. Open the hood.

3. Turn the lid of the coolant reservoir slightly counterclockwise to allow any excess pressure to dissipate, then open it.

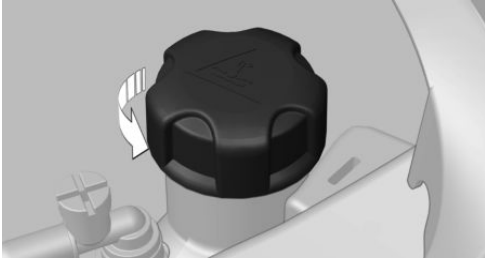

4. If the coolant is low, slowly add coolant up to the specified level; do not overfill.
5. Close the cap.
6. Have the cause of the coolant loss eliminated as soon as possible.

## Disposal

---



Comply with the relevant environmental protection regulations when disposing of coolant and coolant additives.

# Maintenance

## Vehicle features and options

---

This chapter describes all standard, country-specific and optional features offered with the series. It also describes features that are not necessarily available in your vehicle, e. g., due to the selected options or country versions. This also applies to safety-related functions and systems. When using these functions and systems, the applicable laws and regulations must be observed.

## BMW maintenance system

---

The maintenance system indicates required maintenance measures, and thereby provides support in maintaining road safety and the operational reliability of the vehicle.

In some cases, scopes and intervals of the maintenance system may vary according to the country version. Replacement work, spare parts, fuels and lubricants, and wear materials are calculated separately. Further information is available from a dealer's service center or another qualified service center or repair shop.

## Condition Based Service CBS

---

### Concept

Sensors and special algorithms take into account the driving conditions of the vehicle. CBS uses these to calculate the need for maintenance.

The system makes it possible to adapt the amount of maintenance corresponding to your user profile.

## General information

Information on service requirements, refer to page 133, can be displayed on the Control Display.

## Service data in the remote control

Information on the required maintenance is continuously stored in the remote control. The dealer's service center can read this data out and suggest a maintenance scope for the vehicle.

Therefore, hand the service advisor the remote control with which the vehicle was driven most recently.

## Storage periods

Storage periods during which the vehicle battery was disconnected are not taken into account.

If this occurs, have a dealer's service center or another qualified service center or repair shop update the time-dependent maintenance procedures, such as checking brake fluid and, if necessary, changing the engine oil and the microfilter/activated-charcoal filter.

## Service and Warranty Information Booklet for US models and Warranty and Service Guide Booklet for Canadian models

---

Please consult your Service and Warranty Information Booklet for US models and Warranty and Service Guide Booklet for Canadian models for additional information on service requirements.

The manufacturer of your vehicle recommends that maintenance and repair be performed by a dealer's service center or another qualified serv-



ice center or repair shop. Records of regular maintenance and repair work should be retained.

## Socket for OBD Onboard Diagnosis

### General information

Devices connected to the OBD socket trigger the alarm system when the vehicle is locked. Remove any devices connected at the OBD socket before locking the vehicle.

### Safety information

#### NOTICE

The socket for Onboard Diagnosis is an intricate component intended to be used in conjunction with specialized equipment to check the vehicle's primary emissions system. Improper use of the socket for Onboard Diagnosis, or contact with the socket for Onboard Diagnosis for other than its intended purpose, can cause vehicle malfunctions and creates risks of personal and property damage. Given the foregoing, the manufacture of your vehicle strongly recommends that access to the socket for Onboard Diagnosis be limited to a dealer's service center or another qualified service center or repair shop or other persons that have the specialized training and equipment for purposes of properly utilizing the socket for Onboard Diagnosis.

### Position

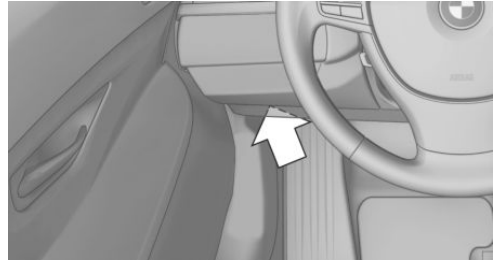

There is an OBD socket on the driver's side for checking the primary components in the vehicle's emissions.

### Emissions



- ▶ The warning light lights up: Emissions are deteriorating. Have the vehicle checked as soon as possible.
- ▶ The warning light flashes under certain circumstances: This indicates that there is excessive misfiring in the engine. Reduce the vehicle speed and have the system checked immediately; otherwise, serious engine misfiring within a brief period can seriously damage emission control components, in particular the catalytic converter.

# Replacing components

## Vehicle features and options

This chapter describes all standard, country-specific and optional features offered with the series. It also describes features that are not necessarily available in your vehicle, e. g., due to the selected options or country versions. This also applies to safety-related functions and systems. When using these functions and systems, the applicable laws and regulations must be observed.

## Onboard vehicle tool kit

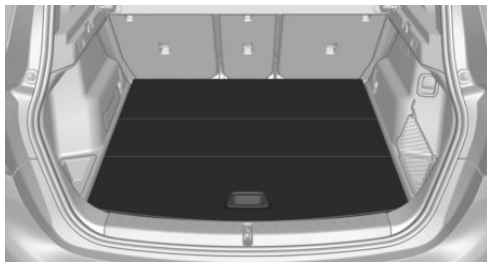

The onboard vehicle tool kit is located under the cargo floor panel.

## Wiper blades

### Safety information

#### NOTICE

The window may sustain damage if the wiper falls onto it without the wiper blade installed. There is a risk of damage to property. Hold the wiper firmly when changing the wiper blade. Do not fold or switch on the wiper without a wiper blade installed.

#### NOTICE

Folded-away wipers can be jammed when the hood is opened. There is a risk of damage to property. Make sure that the wipers with the wiper blades mounted are folded down onto the windshield before opening the hood.

## Replacing the front wiper blades

1. To change the wiper blades, move the wipers into their fold-away position, refer to page 114.
2. Fold up and hold the wiper arm firmly.
3. Press button, arrow 1, and pull out the wiper blade.

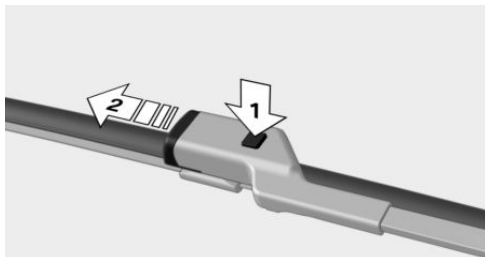

4. Insert the new wiper blade in reverse order of removal until it locks in place.
5. Fold down the wipers.

## Replacing the rear wiper blade

1. Lift the wiper up fully and pull off the wiper blade, arrow.

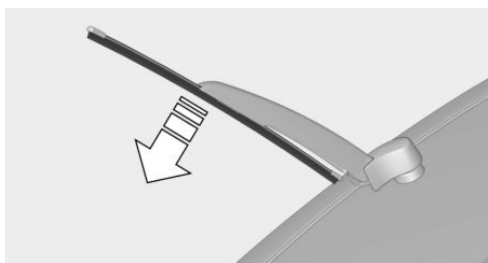

2. Position the new wiper blade and press it on until it you hear it snap into place.
3. Fold the wipers in.

## Light and bulb replacement

### General information

#### Lights and bulbs

Lights and bulbs make an essential contribution to vehicle safety.

The vehicle manufacturer recommends that you have the relevant work carried out a dealer's service center or another qualified service center or repair shop.

A spare light box is available from a dealer's service center or another qualified service center or repair shop.

Follow the safety information, refer to page 274.

#### Light-emitting diodes (LEDs)

Some items of equipment use light-emitting diodes installed behind a cover as a light source. These light-emitting diodes are related to conventional lasers and are officially designated as Class 1 light-emitting diodes.

Follow the safety information, refer to page 274.

## Safety information

### Lights and bulbs

#### **⚠ WARNING**

Bulbs can get hot during operation. Contact with the bulbs can cause burns. There is a risk of injury. Only change bulbs after they have cooled off.

#### **⚠ WARNING**

Work on switched-on lighting systems can cause short circuits. There is a risk of injury or risk of damage to property. When working on the lighting system, switch off the lights in question. If necessary, heed the bulb manufacturer's instructions.

#### **⚠ NOTICE**

Dirty bulbs have a reduced service life. There is a risk of damage to property. Do not hold new bulbs with your bare hands. Use a clean cloth or something similar, or hold the bulb by its base.

### Light-emitting diodes (LEDs)

#### **⚠ WARNING**

Intensive brightness can irritate or damage the retina of the eye. There is a risk of injury. Do not look directly into the headlights or other light sources. Do not remove the LED covers.

### Headlight glass

Condensation can form on the inside of the headlight glass in cool or humid weather. When driving with the lights switched on, the condensation evaporates after a short time. The headlight glass does not need to be changed.

If despite driving with the headlights switched on, increasing humidity forms, for instance water droplets in the light, have the headlights checked.

## Headlight setting

The headlight adjustments can be affected by changing lights and bulbs. After the headlight adjustment was changed, have it checked and, if necessary, corrected by a dealer's service center or another qualified service center or repair shop.

## Front lights, bulb replacement

### Halogen headlights

#### Overview

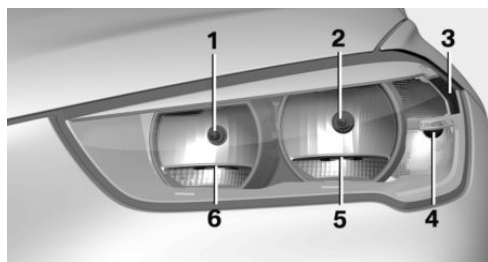

- 1 High beams, headlight flasher
- 2 Low beams
- 3 Side marker lights
- 4 Turn signal
- 5 Parking lights / daytime running lights
- 6 Parking lights / daytime running lights

#### Parking lights, daytime running lights

The parking lights and daytime running lights are made using LED technology.

In the case of a malfunction, contact a dealer's service center or another qualified service center or repair shop.

### Accessing the turn signals, low beams, high beams/headlight flasher

Follow the safety information, refer to page 274.

Open the hood, refer to page 263.

#### Turn signal

Bulb A2357

1. Access to the turn signal on the right side: unhook and fold away the filler neck for the wiper fluid with the screwdriver from the on-board vehicle tool kit.

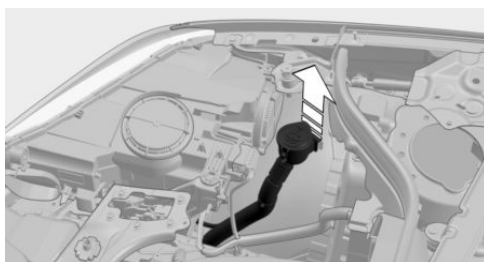

2. Turn the bulb socket counterclockwise and remove.

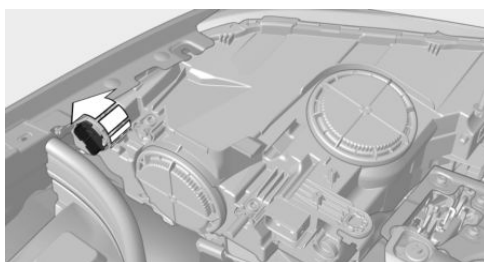

3. Press the bulb gently into the socket, turn counterclockwise and remove.
4. Install the new bulb and bulb holder in reverse order of removal.

#### Low beams

55 watt bulb, H7LL.

1. Access to the low beams on the right side: unhook and fold away the filler neck for the

wiper fluid with the screwdriver from the on-board vehicle tool kit.

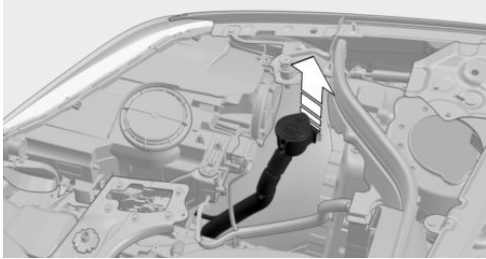

2. Turn the cover counterclockwise and remove.

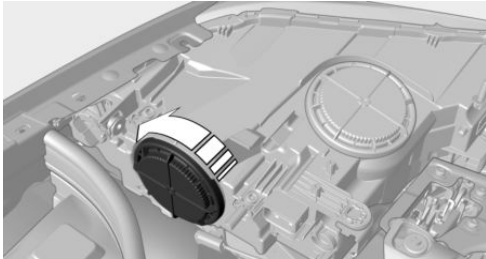

3. Pull the bulb holder directly to the rear, arrow 1, and remove.

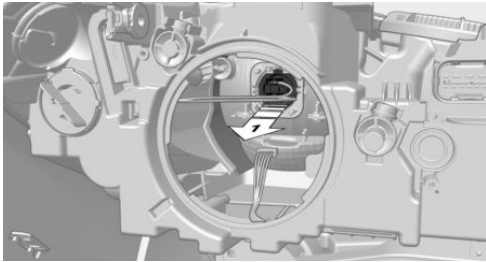

4. Remove the bulb from the bulb holder.
5. Install the new bulb with bulb holder in reverse order of removal.

In doing so, ensure that the bulb tab is correctly positioned in the headlight housing and the bulb holder perceptibly engages.

6. Close the headlight housing with the lid. Make sure that the lid engages.

## High beams/headlight flasher

55-watt bulb, H7.

1. Turn the cover counterclockwise and remove.

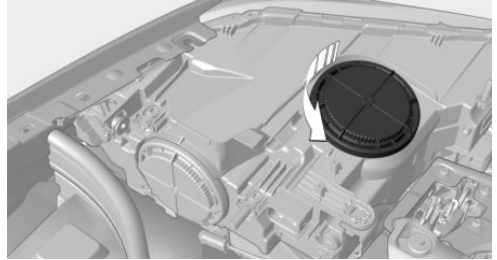

2. Pull the bulb holder directly to the rear, arrow 1, and remove.

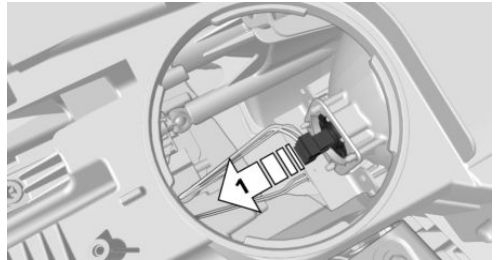

3. Remove the bulb from the bulb holder.
4. Install the new bulb with bulb holder in reverse order of removal.

In doing so, ensure that the bulb tab is correctly positioned in the headlight housing and the bulb holder perceptibly engages.

5. Close the headlight housing with the lid. Make sure that the lid engages.

## LED headlights

### Overview

#### Front lights

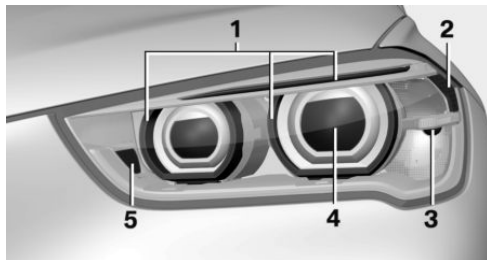

- 1 Parking lights / daytime running lights
- 2 Side marker lights
- 3 Turn signal
- 4 Low beams, high beams/headlight flasher
- 5 Cornering light

#### Front lights

The following lights feature LED technology:

- ▶ High beams
- ▶ Parking lights / daytime running lights
- ▶ Low beams
- ▶ Cornering light

In the case of a malfunction, contact a dealer's service center or another qualified service center or repair shop.

#### Turn signal

Bulb A2357

#### Accessing the turn signals

Follow the safety information, refer to page [274](#).

Open the hood.

1. Access to the turn signal on the right side: unhook and fold away the filler neck for the

wiper fluid with the screwdriver from the on-board vehicle tool kit.

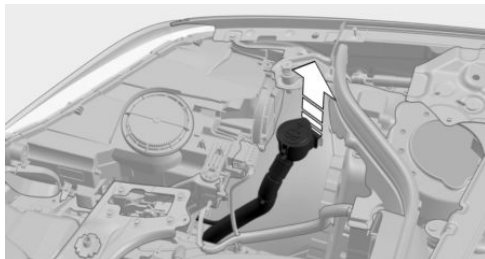

2. Turn the bulb socket counterclockwise and remove.

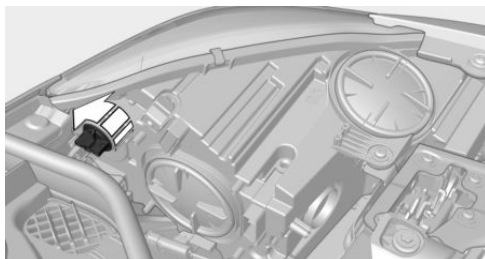

3. Press the bulb gently into the socket, turn counterclockwise and remove.
4. Install the new bulb and bulb holder in reverse order of removal.

#### Halogen front fog lights

Follow the safety information, refer to page [274](#).

35-watt bulb, H8.

1. Insert the screwdriver from the onboard vehicle tool kit, with the flat side on the clip, arrow 1.

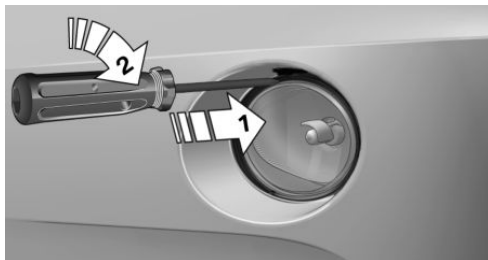

2. Turn the screwdriver by 90°, arrow 2.
3. Remove the front fog light toward the front.
4. Detach the connector.

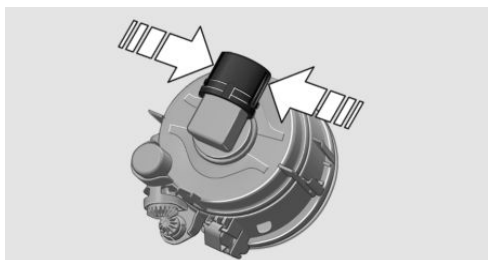

5. Turn the bulb bracket and remove it.

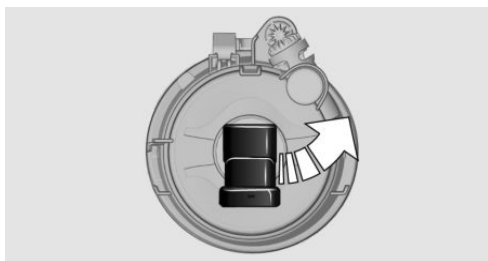

6. Remove the bulb and replace it.
7. Proceed in reverse order to insert the front fog light. Note the guide rails in doing so.

### Turn signal in exterior mirror

The turn signals in the exterior mirrors feature LED technology. In the case of a malfunction,

contact a dealer's service center or another qualified service center or repair shop.

## Tail lights, bulb replacement

### Vehicles with halogen headlights

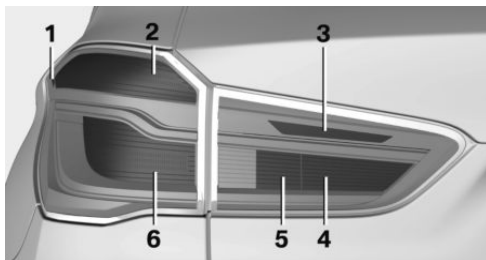

- 1 Side marker lights
- 2 Turn signal
- 3 Reversing light
- 4 Inside brake light
- 5 Tail lights
- 6 Brake lights/tail lights

### Vehicles featuring LED headlights

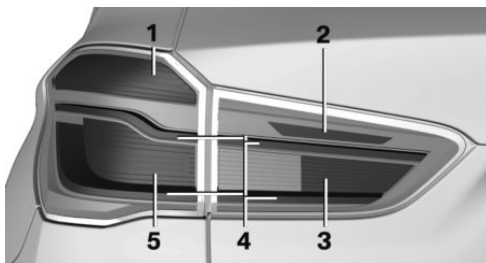

- 1 Turn signal
- 2 Reversing light
- 3 Inside brake light
- 4 Tail lights
- 5 Brake light

The tail lights feature LED technology. In the case of a malfunction, contact a dealer's service center or another qualified service center or repair shop.



## Bulb replacement, exterior tail lights

### General information

Follow the safety information, refer to page 274.

Turn signal: 21-watt bulb, P21WLL.

Outer brake light: 21 watt bulb, P21WLL.

### Removing the exterior tail light

1. Open the tailgate.
2. Remove the fastening using the screw driver from the onboard vehicle tool kit, arrow 1.  
Remove cover, arrow 2.

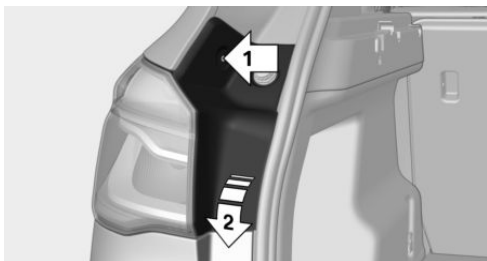

3. Loosen both nuts, arrow 1, of the outer tail light. Use the handle of the screwdriver from the onboard vehicle tool kit to loosen.

Carefully pull out the tail light from the body toward the front, arrow 2. Ensure that the wiring is not damaged.

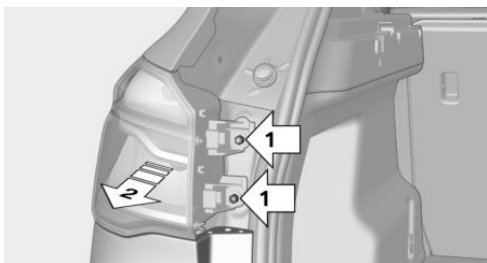

4. Pull the plug out of the bulb holder and have the tail light wiring hang outside.

### Replacing the bulbs

1. Loosen the three fasteners, arrow 1, on the bulb holder.

Remove the bulb holder from the tail light, arrow 2.

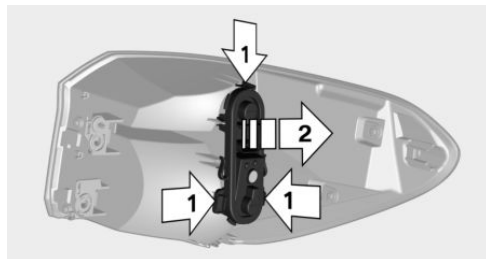

2. Press the nonworking bulb gently into the socket, turn counterclockwise and remove.
  - ▶ Upper bulb: turn signal.
  - ▶ Lower bulb: brake light.
3. Proceed in the reverse order to insert the new bulb and attach the bulb holder. Make sure that the bulb holder engages in all fasteners.

### Installing the tail light

1. Connect the plug and mount the wiring on the tail light, arrow 1.
2. Place the tail light with the tab, arrow 2, on the anchor of the body and push onto both of the threaded bolt.

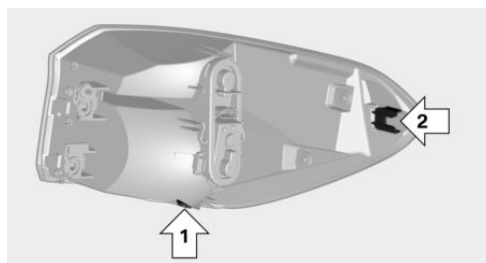

3. Press on the tail lights until flush and tighten both of the nuts.
4. Mount the cover. Make sure that the plastic tabs of the cover are correctly seated in the corresponding recesses of the body.



## Lights in the tailgate

### Vehicles with halogen headlights

Follow the safety information, refer to page 274.

Reversing light: 21-watt bulb, P21WLL

Inner brake light: 21-watt bulb, H21WLL

Tail light: 5-watt bulb, P21WLL

### Vehicles featuring LED headlights

Follow the safety information, refer to page 274.

Reversing light: 21-watt bulb, P21WLL

Inner brake light: 21-watt bulb, H21WLL

### Accessing the lights

1. Open the tailgate.
2. Pull out the cover at the recessed grip.



3. Remove the plug from the bulb holder.

### Replacing reversing light and inner brake light

1. Loosen the fasteners, arrow 1, on the bulb holder.

Remove the bulb holder from the tail light, arrow 2.

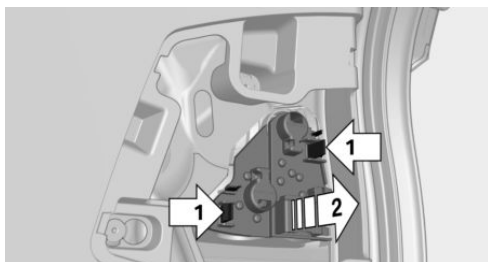

2. Press the nonworking bulb gently into the socket, turn counterclockwise and remove.

- ▷ Upper bulb: reversing light
- ▷ Lower bulb: inner brake light

Only vehicles with halogen headlights:

- ▷ Lower bulb, 5-watt: tail light

### Installing the bulb holder

1. Proceed in the reverse order to insert the new bulb and attach the bulb holder. Connect the plug to the bulb holder.
2. Make sure that the bulb holder is correctly and firmly seated.

## Central brake light and license plate lights

Follow the safety information, refer to page 274.

These lights are made using LED technology. In the case of a malfunction, contact a dealer's service center or another qualified service center or repair shop.

## Vehicle battery

### Maintenance

The battery is maintenance-free.

More information about the battery can be requested from a dealer's service center or another qualified service center or repair shop.

## Replacing the vehicle battery

### General information

The manufacturer of your vehicle recommends that you have a dealer's service center or another qualified service center or repair shop register the vehicle battery to the vehicle after the battery has been replaced. Once the battery has been registered again, all comfort features will be available without restriction and any Check Control

messages displayed which relate to comfort features will disappear.

## Safety information

### **WARNING**

Vehicle batteries that are not compatible can damage vehicle systems and impair vehicle functions. There is a risk of personal and property damage. Only vehicle batteries that are compatible with your vehicle type should be installed in your vehicle. Information on compatible vehicle batteries is available at your dealer's service center.

## Charging the battery

### General information

Make sure that the battery is always sufficiently charged to guarantee that the battery remains usable for its full service life.



A discharged battery is indicated by a red indicator light.

The battery may need to be charged in the following cases:

- ▶ When making frequent short-distance drives.
- ▶ If the vehicle is not used for more than a month.
- ▶ Steptronic transmission: when parked for long periods of time in selector lever position D, R or N.

## Safety information

### **NOTICE**

Battery chargers for the vehicle battery can work with high voltages and currents, which means that the 12 volt on-board network can be overloaded or damaged. There is a risk of damage to property. Only connect battery

chargers for the vehicle battery to the starting aid terminals in the engine compartment.

## Starting aid terminals

In the vehicle, only charge the battery via the starting aid terminals, refer to page 286, in the engine compartment with the engine off.

## Power failure

After a power loss, some equipment needs to be newly initialized or individual settings updated, for example:

- ▶ Seat and mirror memory: store the positions again.
- ▶ Time: update.
- ▶ Date: update.
- ▶ Glass sunroof: initialize the system.

## Disposing of old batteries



Have old batteries disposed of by a dealer's service center or another qualified service center or repair shop or take

them to a collection point.

Maintain the battery in an upright position for transport and storage. Secure the battery so that it does not tip over during transport.

## Fuses

## Safety information

### **WARNING**

Incorrect and repaired fuses can overload electrical lines and components. There is a risk of fire. Never attempt to repair a blown fuse. Do not replace a nonworking fuse with a substitute of another color or amperage rating.

## Accessing the fuses

The fuses are located in the glove compartment.

1. Open the glove compartment.
2. Swing the cover down, arrow.

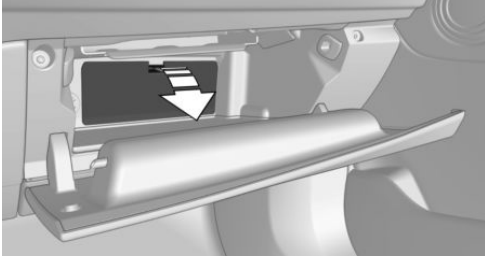

Information on the fuse types and locations, as well as the positions of any other fuse boxes, is found on a separate sheet in the fuse box.

## Replacing fuses

The vehicle manufacturer recommends that you have a dealer's service center or another qualified service center or repair shop replace the fuses.

# Breakdown assistance

## Vehicle features and options

This chapter describes all standard, country-specific and optional features offered with the series. It also describes features that are not necessarily available in your vehicle, e. g., due to the selected options or country versions. This also applies to safety-related functions and systems. When using these functions and systems, the applicable laws and regulations must be observed.

## Hazard warning flashers



The button is located in the center console.

The red light in the button flashes when the hazard warning flashers are activated.

## Warning triangle



The warning triangle is located on the inside of the tailgate.

Move the warning triangle sideways and remove it.

## First-aid kit

### General information

Some of the articles have a limited service life.

Check the expiration dates of the contents regularly and replace any expired items promptly.

### Storage

The first-aid kit is located in the cargo area on the left in the storage compartment.

## BMW Roadside Assistance

### Concept

Contact the BMW Group Roadside Assistance if assistance is needed in the event of a breakdown.

## General information

In the event of a breakdown, data on the vehicle's condition is sent directly to the manufacturer of your vehicle.

Contact can also be made via a Check Control message, refer to page 131.

## Requirements

- ▷ Active ConnectedDrive contract, equipment version with Intelligent emergency call or BMW ConnectedDrive services.
- ▷ Cellular network reception.
- ▷ The ignition is switched on.

## Starting Roadside Assistance

If the vehicle is equipped with Teleservices, support is offered through Teleservice Diagnosis.

Via iDrive:

1. "ConnectedDrive"
2. "BMW Assist"
3. "BMW Roadside Assistance"

The contact to the Roadside Assistance of the manufacture is established.

A telephone number is displayed, if needed. Select to dial the telephone number on a connected mobile phone.

## Teleservice Diagnosis

Teleservice Diagnosis enables the wireless transmission of detailed vehicle data that is important for vehicle diagnosis. This data is transmitted automatically.

## Starting Teleservice Help

Depending on the country, the Teleservice Help enables a more in-depth diagnosis of the vehicle via wireless transmission.

You can launch Teleservice Help by requesting it through the Service Specialist.

1. Park the vehicle in a safe place.
2. Set the parking brake.
3. Control Display is switched on.
4. "Teleservice Help"

The driving ability of the vehicle can be restored for specific functions.

If this is not possible, further measures will be initiated, for instance Roadside Assistance will be informed.

## Emergency Request

### Intelligent emergency call

#### Concept

In case of an emergency, an Emergency Request can be triggered automatically by the system or manually.

#### General information

Only press the SOS button in an emergency.

Intelligent emergency call establishes a connection with the BMW Response Center.

For technical reasons, the Emergency Request cannot be guaranteed under unfavorable conditions.

#### Overview



SOS button in the roofliner.

## Functional requirements

- ▶ The Assist system is functional.
- ▶ The ignition is switched on.
- ▶ If the vehicle is equipped with intelligent emergency call: the SIM card integrated in the vehicle has been activated.

## Automatic triggering

Under certain conditions, for instance if the air-bags trigger, an Emergency Request is automatically initiated immediately after an accident of corresponding severity. Automatic Collision Notification is not affected by pressing the SOS button.

## Manual triggering

1. Touch the cover.
  2. Press and hold the SOS button until the LED on the button illuminates green.
- ▶ The LED is illuminated green when an Emergency Request has been initiated.

If a cancel prompt appears on the Control Display, the Emergency Request can be aborted.

If the situation allows, wait in your vehicle until the voice connection has been established.

- ▶ The LED flashes green when a connection to the BMW Response Center has been established.

The BMW Response Center then makes contact with you and takes further steps to help you.

Even if you are unable to respond, the BMW Response Center can take further steps to help you under certain circumstances.

For this, data is transmitted to the BMW Response Center which serves to determine the necessary rescue measures. E.g., the current position of the vehicle, if it can be established.

Even if you can no longer hear the BMW Response Center through the loudspeakers, the

BMW Response Center may still be able to hear you.

The BMW Response Center ends the Emergency Request.

## Jump-starting

### General information

If the battery is discharged, the engine can be started using the battery of another vehicle and two jumper cables. Only use jumper cables with fully insulated clamp handles.

### Safety information

#### DANGER

Contact with live components can lead to an electric shock. There is a risk of injuries or danger to life. Do not touch any components that are under voltage.

#### WARNING

If the jumper cables are connected in the incorrect order, sparking may occur. There is a risk of injury. Pay attention to the correct order during connection.

#### NOTICE

In the case of body contact between the two vehicles, a short circuit can occur during jump-starting. There is a risk of damage to property. Make sure that no body contact occurs.

### Preparation

1. Check whether the battery of the other vehicle has a voltage of 12 volts. The voltage information can be found on the battery.
2. Switch off the engine of the assisting vehicle.

- Switch off any electronic systems/power consumers in both vehicles.

## Starting aid terminals

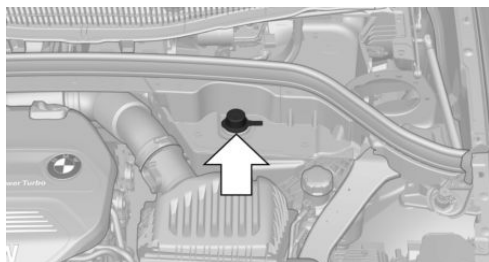

The starting aid terminal in the engine compartment acts as the battery's positive terminal. Open the cover of the starting aid terminal.

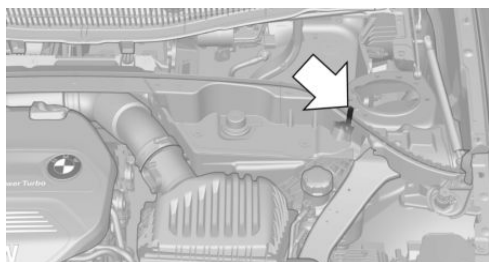

A special connection on the body acts as the battery negative terminal.

## Connecting the cables

To prevent personal injury or damage to both vehicles, adhere strictly to the following procedure.

- Open the cover of the BMW starting aid terminal.
- Attach one terminal clamp of the positive jumper cable to the positive terminal of the battery, or to the corresponding starting aid terminal of the vehicle providing assistance.
- Attach the terminal clamp on the other end of the cable to the positive terminal of the battery, or to the corresponding starting aid terminal of the vehicle to be started.

- Attach one terminal clamp of the negative jumper cable to the negative terminal of the battery, or to the corresponding engine or body ground of assisting vehicle.
- Attach the second terminal clamp to the negative terminal of the battery, or to the corresponding engine or body ground of the vehicle to be started.

## Starting the engine

Never use spray fluids to start the engine.

- Start the engine of the assisting vehicle and let it run for several minutes at an increased idle speed.
- Start the engine of the vehicle that is to be started in the usual way.

If the first starting attempt is not successful, wait a few minutes before making another attempt in order to allow the discharged battery to recharge.

- Let both engines run for several minutes.
- Disconnect the jumper cables in the reverse order.

Check the battery and recharge, if needed.

## Tow-starting and towing

### Safety information

#### WARNING

Due to system limits, individual functions can malfunction during tow-starting/towing with the Intelligent Safety systems activated. There is a risk of an accident. Switch all Intelligent Safety systems off prior to tow-starting/towing.

## Steptronic transmission without xDrive: transporting the vehicle

### General information

The vehicle must not be towed if the front wheels are touching the ground.

### Safety information

#### NOTICE

The vehicle can be damaged when towing the vehicle with a lifted rear axle. There is a risk of damage to property. Have vehicle transported only with lifted front axle or on a loading platform.

### Pushing the vehicle

To remove a broken-down vehicle from the danger area, it can be pushed for a short distance.

Roll or push, refer to page 122, the vehicle.

### Tow truck

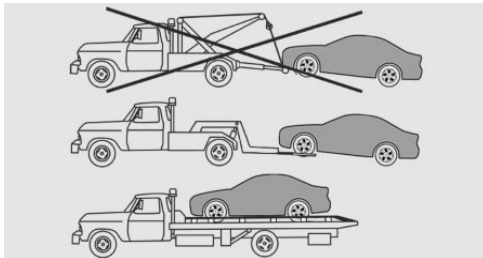

Your vehicle should be transported with a tow truck with a so-called lift bar or on a flat bed.

#### NOTICE

The vehicle can become damaged when lifting and securing it.

There is a risk of damage to property.

- ▷ Lift the vehicle using suitable means.

- ▷ Do not lift or secure the vehicle by its tow fitting, body parts, or suspension parts.

## Steptronic transmission with xDrive: transporting the vehicle

### General information

The vehicle is not permitted to be towed.

### Pushing the vehicle

To remove a broken-down vehicle from the danger area, it can be pushed for a short distance.

Roll or push, refer to page 122, the vehicle.

### Tow truck

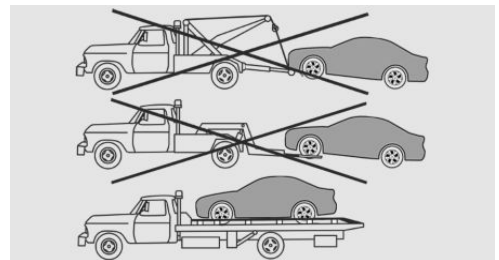

The vehicle should only be transported on a loading platform.

#### NOTICE

The vehicle can become damaged when lifting and securing it.

There is a risk of damage to property.

- ▷ Lift the vehicle using suitable means.
- ▷ Do not lift or secure the vehicle by its tow fitting, body parts, or suspension parts.

## Towing other vehicles

### General information

Switch on the hazard warning system, depending on local regulations.



If the electrical system has failed, clearly identify the vehicle being towed by placing a sign or a warning triangle in the rear window.

## Safety information

### **⚠ WARNING**

If the approved gross vehicle weight of the towing vehicle is lighter than the vehicle to be towed, the tow fitting can tear off or it will not be possible to control the vehicle's response. There is a risk of an accident. Make sure that the gross vehicle weight of the towing vehicle is heavier than the vehicle to be towed.

### **⚠ NOTICE**

If the tow bar or tow rope is attached incorrectly, damage to other vehicle parts can occur. There is a risk of damage to property. Correctly attach the tow bar or tow rope to the tow fitting.

## Tow bar

The tow fittings used should be on the same side on both vehicles.

Should it prove impossible to avoid mounting the tow bar at an offset angle, please follow the following:

- ▶ Maneuvering capability is limited going around corners.
- ▶ The tow bar will generate lateral forces if it is secured with an offset.

## Tow rope

When starting to tow the vehicle, make sure that the tow rope is taut.

Use nylon ropes or straps, which will enable the vehicle to be towed without jerking.

## Tow fitting

### General information

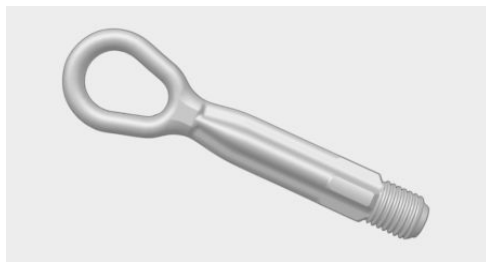

The screw-in tow fitting should always be carried in the vehicle.

The tow fitting can be screwed in at the front or rear of the vehicle.

The tow fitting and the onboard vehicle tool kit, refer to page 273, are together in the cargo area.

Use of the tow fitting:

- ▶ Use only the tow fitting provided with the vehicle and screw it all the way in.
- ▶ Use the tow fitting for towing on paved roads only.
- ▶ Avoid lateral loading of the tow fitting, for instance do not lift the vehicle by the tow fitting.

### Safety information

#### **⚠ NOTICE**

If the tow fitting is not used as intended, there may be damage to the vehicle or to the tow fitting. There is a risk of damage to property. Follow the notes on using the tow fitting.

## Screw thread for tow fitting

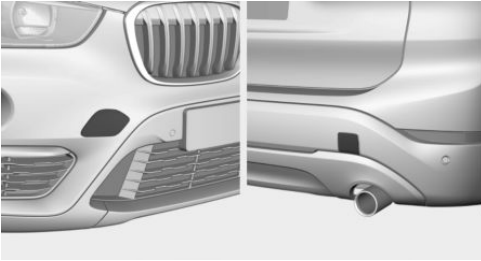

Press on the mark on the edge of the cover to push it out.

## Tow-starting

### Steptronic transmission

Do not tow-start the vehicle.

Tow-starting the engine is not possible due to the Steptronic transmission.

Have the reasons for the starting difficulties corrected by a dealer's service center or another qualified service center or repair shop.

# Care

## Vehicle features and options

This chapter describes all standard, country-specific and optional features offered with the series. It also describes features that are not necessarily available in your vehicle, e. g., due to the selected options or country versions. This also applies to safety-related functions and systems. When using these functions and systems, the applicable laws and regulations must be observed.

## Washing the vehicle

### General information

Regularly remove foreign objects such as leaves in the area below the windshield when the hood is raised.

Wash your vehicle frequently, particularly in winter. Intense soiling and road salt can damage the vehicle.

### Steam blaster and high-pressure washer

#### Safety information

##### NOTICE

When cleaning with high-pressure washers, components can be damaged due to the pressure or temperatures being too high. There is a risk of damage to property. Maintain sufficient distance and do not spray too long continuously. Follow the operating instructions for the high-pressure washer.

### Distances and temperature

- ▷ Maximum temperature: 140 °F/60 °C.
- ▷ Minimum distance from sensors, cameras, seals: 12 inches/30 cm.
- ▷ Minimum distance from glass sunroof: 31.5 in/80 cm.

### Automatic vehicle washes

#### Safety information

##### NOTICE

Improper use of automatic vehicle washes can cause damage to the vehicle. There is a risk of damage to property. Follow the following instructions:

- ▷ Give preference to cloth vehicle washes or those that use soft brushes in order to avoid paint damage.
- ▷ Avoid vehicle washes with guide rails higher than 4 in/10 cm to avoid damage to the chassis.
- ▷ Observe the tire width of the guide rail to avoid damage to tires and rims.
- ▷ Fold in exterior mirrors to avoid damage to the exterior mirrors.
- ▷ Deactivate the wiper and, if necessary, rain sensor to avoid damage to the wiper system.

### Driving into a vehicle wash with a Steptronic transmission

#### General information

In a vehicle wash, the vehicle must be able to roll freely.

Roll or push the vehicle, refer to page [122](#).

Some vehicle washes do not permit persons in the vehicle. The vehicle cannot be locked from the outside when in selector lever position N. A signal sounds when an attempt is made to lock the vehicle.

## Driving out of a vehicle wash

Make sure that the remote control is in the vehicle.

Start the engine. Starting the engine, refer to page 106.

## Headlights

Do not rub wet headlights dry and do not use abrasive or acidic cleaning agents.

Soak areas that have been dirtied, for instance from insects, with shampoo and wash off with water.

Thaw ice with de-icing spray; do not use an ice scraper.

## After washing the vehicle

After washing the vehicle, apply the brakes briefly to dry them; otherwise, braking action can be reduced. The heat generated during braking dries brake discs and brake pads and protects them against corrosion.

Completely remove all residues on the windows, to minimize loss of visibility due to smearing and to reduce wiper noises and wiper blade wear.

# Vehicle care

## Vehicle care products

### General information

BMW recommends using vehicle care and cleaning products from BMW. Suitable care products are available from a dealer's service center or another qualified service center or repair shop.

## Safety information

### WARNING

Cleanders can contain substances that are dangerous and harmful to your health. There is a risk of injury. When cleaning the interior, open the doors or windows. Only use products intended for cleaning vehicles. Follow the instructions on the container.

## Vehicle paint

### General information

Regular care contributes to driving safety and value retention. Environmental influences in areas with elevated air pollution or natural contaminants, such as tree resin or pollen can affect the vehicle's paintwork. Tailor the frequency and extent of your vehicle care to these influences.

Aggressive substances such as spilled fuel, oil, grease or bird droppings, must be removed immediately to prevent the finish from being altered or discolored.

## Safety information

### WARNING

Improperly performed work on the vehicle paint can lead to a failure or malfunction of the radar sensors and thereby result in a safety risk. There is a risk of accidents or risk of damage to property. Have paintwork or paintwork repairs on bumpers of vehicles with radar sensors performed by a dealer's service center or another qualified service center or repair shop only.

### Matte finish

Only use cleaning and care products suitable for vehicles with matte finish.

## Leather care

Remove dust from the leather regularly, using a cloth or vacuum cleaner.

Otherwise, particles of dust and road grime chafe in pores and folds, and lead to increased wear and premature degradation of the leather surface.

To guard against discoloration, such as from clothing, clean leather and provide leather care roughly every two months.

Clean light-colored leather more frequently because soiling on such surfaces is substantially more visible.

Use leather care products; otherwise, dirt and grease will gradually break down the protective layer of the leather surface.

## Upholstery material care

### General information

Vacuum the upholstery regularly with a vacuum cleaner.

If upholstery is very dirty, for instance with beverage stains, use a soft sponge or microfiber cloth with a suitable interior cleaner.

Clean the upholstery down to the seams using large sweeping motions. Avoid rubbing the material vigorously.

### Safety information

#### NOTICE

Open Velcro® fasteners on articles of clothing can damage the seat covers. There is a risk of damage to property. Ensure that any Velcro® fasteners are closed.

## Caring for special components

### Light-alloy wheels

When cleaning the vehicle, use only neutral wheel cleaners having a pH value from 5 to 9. Do

not use abrasive cleaning agents or steam jets above 140 °F/60 °C. Follow the manufacturer's instructions.

Aggressive, acidic or alkaline cleaning agents can destroy the protective layer of adjacent components, such as the brake disc.

After cleaning, apply the brakes briefly to dry them. The heat generated during braking dries brake discs and brake pads and protects them against corrosion.

### Chrome surfaces

Carefully clean components such as the radiator grille or door handles with an ample supply of water, possibly with shampoo added, particularly when they have been exposed to road salt.

### Rubber components

Environmental influences can cause surface soiling of rubber parts and a loss of gloss. Use only water and suitable cleaning agents for cleaning.

Treat especially worn rubber parts with rubber care agents at regular intervals. When cleaning rubber seals, do not use any silicon-containing vehicle care products in order to avoid damage or noises.

### Fine wood parts

Clean fine wood facing and fine wood components only with a moist rag. Then dry with a soft cloth.

### Plastic components

#### NOTICE

Cleansers that contain alcohol or solvents, such as lacquer thinners, heavy-duty grease removers, fuel, or such, can damage plastic parts. There is a risk of damage to property. Clean with a microfiber cloth. Dampen cloth lightly with water.

Plastic components are e.g.:

- ▷ Imitation leather surfaces.
- ▷ Roofliner.
- ▷ Light lenses.
- ▷ Instrument cluster cover.
- ▷ Matt black spray-coated components.
- ▷ Painted parts in the car's interior.

Clean with a microfiber cloth.

Dampen cloth lightly with water.

Do not soak the roofliner.

## Safety belts

### WARNING

Chemical cleansers can destroy the safety belt webbing. Missing protective effect of the safety belts. There is a risk of injuries or danger to life. Use only a mild soapy solution for cleaning the safety belts.

Dirty belt straps impede the reeling action and thus have a negative impact on safety.

Use only a mild soapy solution, with the safety belts clipped into their buckles.

Safety belts should only be allowed to retract if they are dry.

## Carpets and floor mats

### WARNING

Objects in the driver's floor area can limit the pedal distance or block a depressed pedal. There is a risk of an accident. Stow objects in the vehicle such that they are secured and cannot enter into the driver's floor area. Use floor mats that are suitable for the vehicle and can be safely attached to the floor. Do not use loose floor mats and do not layer several floor mats. Make sure that there is sufficient clearance for the pedals. Ensure that the floor mats are securely fastened again after they were removed, for instance for cleaning.

Floor mats can be removed from the car's interior for cleaning.

If the floor carpets are very dirty, clean with a microfiber cloth and water or a textile cleaner. To prevent matting of the carpet, rub back and forth in the direction of travel only.

## Sensor/camera lenses

To clean sensors and camera lenses, use a cloth moistened with a small amount of glass detergent.

## Displays/Screens/protective glass of the Head-up Display

### NOTICE

Chemical cleansers, moisture or fluids of any kind can damage the surface of displays and screens. There is a risk of damage to property. Clean with a clean, antistatic microfiber cloth.

### NOTICE

The surface of displays can be damaged with improper cleaning. There is a risk of damage to property. Avoid pressure that is too high and do not use any scratching materials.

Clean with a clean, antistatic microfiber cloth.

Clean the protective glass of the Head-up Display using a microfiber cloth and commercially available dish-washing soap.

## Long-term vehicle storage

When the vehicle is shut down for longer than three months, special measures must be taken. Further information is available from a dealer's service center or another qualified service center or repair shop.





## 🔍 REFERENCE

Technical data .....	296
Appendix .....	298
Everything from A to Z .....	300



# Technical data

## Vehicle features and options

This chapter describes all standard, country-specific and optional features offered with the series.

It also describes features that are not necessarily available in your vehicle, e. g., due to the selected options or country versions. This also applies to safety-related functions and systems. When using these functions and systems, the applicable laws and regulations must be observed.

## General information

The technical data and specifications in this Owner's Manual are used as guidance values. The vehicle-specific data can deviate from this, for instance due to the selected special equipment, country version or country-specific meas-

urement method. Detailed values can be found in the approval documents, on labels on the vehicle or can be obtained from a dealer's service center or another qualified service center or repair shop.

## Dimensions

The dimensions can vary depending on the model version, equipment or country-specific measurement method.

racks or spoiler. The heights can deviate, for instance due to the selected special equipment, tires, load and chassis version.

The specified heights do not take into account attached parts, for instance a roof antenna, roof

### BMW X1

Width with mirrors	in/mm	81.1/2,060
Width without mirrors	in/mm	71.7/1,821
Height	in/mm	62.9/1,598
Length	in/mm	175.4/4,455
Wheelbase	in/mm	105.1/2,670
Smallest turning radius diam.	ft/m	37.4/11.4

## Weights

### X1 sDrive28i

Approved gross vehicle weight	lbs/kg	4,575/2,075
Load	lbs/kg	899/408
Approved front axle load	lbs/kg	2,403/1,090
Approved rear axle load	lbs/kg	2,282/1,035
Approved roof load capacity	lbs/kg	165/75

### X1 xDrive28i

Approved gross vehicle weight	lbs/kg	4,729/2,145
Load	lbs/kg	899/408
Approved front axle load	lbs/kg	2,469/1,120
Approved rear axle load	lbs/kg	2,381/1,080
Approved roof load capacity	lbs/kg	165/75

## Capacities

### BMW X1

Fuel tank, approx.	US gal/liters	16.1/61.0
--------------------	---------------	-----------

Observe further information on fuel quality, refer to page [242](#).

# Appendix

Any updates to the Owner's Manual of the vehicle are listed here.



# Everything from A to Z

## Index

### A

A/C button, see Air conditioning 199  
 ABS, Antilock Brake System 169  
 ACC, Active Cruise Control 175  
 Acceleration Assistant, see Launch Control 125  
 Accessories and parts 10  
 Activated-charcoal filter 201  
 Activation times, parked-car ventilation 203  
 Active Cruise Control, ACC 175  
 Adaptive brake lights, see Brake force display 167  
 Additives, engine oil types 267  
 After washing vehicle 291  
 Airbags 148  
 Airbags, indicator and warning light 149  
 Air circulation, see Recirculated-air mode 196, 200  
 Air conditioner 195  
 Air conditioning 196, 199  
 Air distribution, manual 197, 200  
 Air flow, air conditioner 197  
 Air flow, automatic climate control 200  
 Air pressure, tires 244  
 Air vents, see Ventilation 202  
 Alarm system 84  
 Alarm, unintentional 85  
 Alertness Assistant 167  
 All-season tires, see Winter tires 250  
 All-wheel-drive 171  
 Ambient light 147  
 Antifreeze, washer fluid 118  
 Antilock Brake System, ABS 169  
 Anti-slip control, see DSC 169  
 Anti-theft protection, lug bolts 257  
 Approach control warning with city light braking function 159  
 Approved axle load 297  
 Apps, see Owner's Handbook for Navigation, Entertainment, Communication 8

Arrival time 138  
 Ash tray 209  
 Assistance when driving off 174  
 AUTO intensity 200  
 Automatic climate control 198  
 Automatic cruise control with Stop&Go function 175  
 Automatic Curb Monitor 98  
 Automatic deactivation, front-seat passenger airbags 150  
 Automatic headlight control 144  
 Automatic locking 83  
 Automatic recirculated-air control 200  
 Automatic tailgate 78  
 Automatic transmission, see Steptronic transmission 119  
 Automatic unlocking 83  
 Automatic vehicle wash 290  
 AUTO program, automatic climate control 199  
 AUTO program, intensity 200  
 Auto Start/Stop function 107  
 Auto washing 290  
 Average consumption 137  
 Average speed 137  
 Axle loads, weights 297

### B

Backrest curvature, see Lumbar support 90  
 Backrest, seats 89  
 Backrest, width 91  
 Bad road trips 225  
 Band-aids, see First-aid kit 283  
 Battery replacement, vehicle battery 280  
 Battery replacement, vehicle remote control 71  
 Battery, vehicle 280  
 Being towed, see Tow-starting and towing 286  
 Belts, safety belts 92  
 Beverage holder, cup holder 219  
 Blocking, power window 86

- Bluetooth connection [57](#)
- Blu-ray, see *Owner's Handbook for Navigation, Entertainment, Communication* [8](#)
- BMW Assist, see *Owner's Manual for Navigation, Entertainment and Communication* [8](#)
- BMW Homepage [8](#)
- BMW Internet page [8](#)
- BMW maintenance system [271](#)
- Bonus range, ECO PRO [234](#)
- Bottle holder, see *Cup holder* [219](#)
- Brake assistant [169](#)
- Brake discs, break-in [224](#)
- Brake force display [167](#)
- Brake lights, brake force display [167](#)
- Brake pads, break-in [224](#)
- Braking, information [226](#)
- Breakdown assistance [283](#)
- Break-in [224](#)
- Break recommendation, see *Alertness Assistant* [167](#)
- Brightness of Control Display [54](#)
- Bulb replacement [274](#)
- Bulb replacement, front [275](#)
- Bulb replacement, rear [278](#)
- Bulbs and lights [274](#)
- Button, Start/Stop [105](#)
- Bypassing, see *Jump-starting* [285](#)
- C**
- Calendar, see *Owner's Handbook for Navigation, Entertainment, Communication* [8](#)
- California Proposition 65 Warning [10](#)
- Calling up mirror adjustment [83](#)
- Calling up seat adjustment [83](#)
- Camera-based assistance systems, see *Intelligent Safety* [158](#)
- Camera-based cruise control, ACC [175](#)
- Camera lenses, care [293](#)
- Camera, rearview camera [188](#)
- Can holder, see *Cup holder* [219](#)
- Care, displays [293](#)
- Care, vehicle [291](#)
- Care, washing the vehicle [290](#)
- Cargo [228](#)
- Cargo area [212](#)
- Cargo area, enlarging [213](#)
- Cargo area, loading [229](#)
- Cargo area partition net [215](#)
- Cargo area, storage compartments [220](#)
- Cargo position, rear seat backrest [213](#)
- Cargo, stowing and securing [229](#)
- Carpet, care [293](#)
- Catalytic converter, see *Hot exhaust gas system* [225](#)
- CBS Condition Based Service [271](#)
- Center armrest [219](#)
- Center console [38](#)
- Central Information Display (CID), see *Control Display* [42](#)
- Central locking system [73](#)
- Central screen, see *Control Display* [42](#)
- Changes, technical, see *For Your Own Safety* [9](#)
- Changing parts [273](#)
- Changing wheels [256](#)
- Changing wheels/tires [249](#)
- Chassis number, see *Vehicle identification number* [14](#)
- Check Control [127](#)
- Checking the oil level electronically [265](#)
- Children, seating position [100](#)
- Children, transporting safely [100](#)
- Child restraint system [100](#)
- Child restraint system LATCH [102](#)
- Child restraint systems, mounting [101](#)
- Child safety locks [104](#)
- Child seat, mounting [101](#)
- Child seats [100](#)
- Chrome parts, care [292](#)
- Cigarette lighter [209](#)
- Cleaning, displays [293](#)
- Climate control [195](#), [198](#)
- Closing the tailgate with no-touch activation [75](#)
- Clothes hooks [220](#)
- Coasting [235](#)
- Coasting with engine decoupled, coasting [235](#)
- Coasting with idling engine [235](#)
- Cockpit [36](#)
- Combination switch, see *Turn signals* [111](#)
- Combination switch, see *Wiper system* [112](#), [115](#)
- Comfort Access [74](#)

COMFORT program, driving dynamics 174  
 Compact wheel, see Emergency wheel 260  
 Compartments in the doors 218  
 Compass 207  
 Compatible devices, see Suitable devices 57  
 Compressor 251  
 Computer, see Onboard Computer 136  
 Concierge Service, see Owner's Handbook for Navigation, Entertainment, Communication 8  
 Condensation on windows 201  
 Condensation under the vehicle 227  
 Condition Based Service CBS 271  
 Confirmation signal 83  
 Connect device 56  
 ConnectedDrive, see Owner's Manual for Navigation, Entertainment and Communication 8  
 Connecting mobile phone 56  
 Connecting smartphone 56  
 Connecting telephone 56  
 Connections 56  
 Consumption history 234  
 Consumption, see Average consumption 137  
 Consumption, see Current consumption 133  
 Contacts, see Owner's Handbook for Navigation, Entertainment, Communication 8  
 Container for washer fluid 118  
 Continued driving with a flat tire 154, 158  
 Control Display 42  
 Control Display, settings 52  
 Controller 42, 43  
 Control systems, driving stability 169  
 Convenient closing with the remote control 70  
 Convenient opening with the remote control 69  
 Coolant 269  
 Cooling, maximum 199  
 Cooling system 269  
 Cornering light 145  
 Corrosion on brake discs 227  
 Cosmetic mirror 209  
 Couple device, see Pair device 56  
 Courtesy lights during unlocking 69  
 Courtesy lights with the vehicle locked 70  
 Cruise control 181  
 Cruise control, active 175  
 Cruise control with distance control, see Camera-based cruise control, ACC 175

Cruise control without distance control, see Cruise control 181  
 Cruising range 132  
 Cup holder 219  
 Current consumption 133

## D

Damage, tires 248  
 Data protection, settings 55  
 Data, technical 296  
 Date 53  
 Date display 132  
 Daytime running lights 145  
 DCC, see Cruise control 181  
 Defrosting, see Defrosting the windows 197  
 Defrosting, see Windows, defrosting 201  
 Defrosting the windows 197  
 Deleting personal data 55  
 Deletion of personal data 55  
 Destination distance 138  
 Device list 56  
 Digital clock 132  
 Digital compass 207  
 Dimensions 296  
 Dimmable exterior mirrors 98  
 Dimmable interior mirror 98  
 Direction indicator, see Turn signals 111  
 Display, engine temperature 138  
 Display lighting, see Instrument lighting 146  
 Displays, care 293  
 Disposal, coolant 270  
 Disposal, vehicle battery 281  
 Distance control, see PDC 184  
 Distance to destination 138  
 Divided screen view, split screen 41  
 Door key, see Remote control 72  
 Downhill control, see HDC Hill Descent Control 171  
 Drive-off assistant 174  
 Drive-off assistant, see DSC 169  
 Driver assistance, see Intelligent Safety 158  
 Driver profiles 80  
 Driver profiles, exporting profiles 81  
 Driver profiles, importing profiles 82  
 Driving Dynamics Control 173

Driving Excitement, SPORT [139](#)  
Driving instructions, break-in [224](#)  
Driving instructions, ECO PRO [234](#)  
Driving mode [173](#)  
Driving notes, general [225](#)  
Driving on bad roads [225](#)  
Driving on racetracks [227](#)  
Driving stability control systems [169](#)  
Driving style analysis [236](#)  
Driving tips [225](#)  
Drying air, see Air conditioning [196](#), [199](#)  
DSC Dynamic Stability Control [169](#)  
DTC Dynamic Traction Control [171](#)  
DVD, Video, see Owner's Handbook for Navigation, Entertainment, Communication [8](#)  
Dynamic Stability Control DSC [169](#)  
Dynamic Traction Control DTC [171](#)

## E

ECO PRO [232](#)  
ECO PRO bonus range [234](#)  
ECO PRO display [232](#)  
ECO PRO driving mode [232](#)  
ECO PRO driving style analysis [236](#)  
ECO PRO mode [232](#)  
ECO PRO program, driving dynamics [174](#)  
ECO PRO tips [234](#)  
Efficiency display, ECO PRO [234](#)  
Efficient driving [234](#)  
EfficientDynamics information [234](#)  
Electronic oil measurement [265](#)  
Electronic Stability Program ESP, see DSC [169](#)  
E-mail, see Owner's Handbook for Navigation, Entertainment, Communication [8](#)  
Emergency release, fuel filler flap [241](#)  
Emergency Request [284](#)  
Emergency service, see Breakdown assistance [283](#)  
Emergency unlocking, transmission lock [125](#)  
Emergency wheel [260](#)  
Energy control [133](#)  
Energy recovery [133](#)  
Engine, automatic Start/Stop function [107](#)  
Engine, automatic switch-off [107](#)  
Engine compartment [262](#)

Engine compartment, working in [263](#)  
Engine coolant [269](#)  
Engine idling when driving, coasting [235](#)  
Engine oil [265](#)  
Engine oil, adding [266](#)  
Engine oil change [268](#)  
Engine oil filler neck [266](#)  
Engine oil types to add [267](#)  
Engine start, jump-starting [285](#)  
Engine start, see Starting the engine [106](#)  
Engine stop [107](#)  
Engine temperature, display [138](#)  
Entering a destination, see Owner's Handbook for Navigation, Entertainment, Communication [8](#)  
Entering an address, navigation, see Owner's Manual for Navigation, Entertainment and Communication [8](#)  
Entering a vehicle wash [290](#)  
Equipment, interior [204](#)  
Error displays, see Check Control [127](#)  
ESP Electronic Stability Program, see DSC [169](#)  
Exchanging wheels/tires [249](#)  
Exhaust gas system [225](#)  
Exhaust, see Exhaust gas system [225](#)  
Exiting a vehicle wash [290](#)  
Exterior mirror, automatic dimming feature [98](#)  
Exterior mirrors [97](#)  
Exterior mirrors, malfunction [97](#)  
External start [285](#)  
External temperature display [132](#)  
External temperature warning [132](#)

## F

Failure message, see Check Control [127](#)  
False alarm, see Unintentional alarm [85](#)  
Fan, see Air flow [197](#), [200](#)  
Fastening safety belts, see Safety belts [92](#)  
Filler neck for engine oil [266](#)  
Filter, see Microfilter [197](#)  
Filter, see Microfilter/activated-charcoal filter [201](#)  
Finding charging stations, see Charging stations and points of interest, see Owner's Handbook



for Navigation, Entertainment, Communication [8](#)  
 Fine wood, care [292](#)  
 First-aid kit [283](#)  
 Flat tire, changing wheels [256](#)  
 Flat tire message, FTM [157](#)  
 Flat tire message, TPM [153](#)  
 Flat Tire Monitor FTM [156](#)  
 Flat tire, repairing [251](#)  
 Flat tire, Tire Pressure Monitor TPM [151](#)  
 Flat tire warning light, FTM [157](#)  
 Flat tire warning light, TPM [153](#)  
 Flooding [226](#)  
 Floor carpet, care [293](#)  
 Floor mats, care [293](#)  
 Fogged up windows [197](#)  
 Fold-away position, wiper [114](#), [117](#)  
 Fold back rear seat backrests [213](#)  
 Foot brake [226](#)  
 For Your Own Safety [9](#)  
 Front airbags [148](#)  
 Front fog lights [146](#)  
 Front fog lights, halogen, bulb replacement [277](#)  
 Front lights [275](#)  
 Front-seat passenger airbags, automatic deactivation [150](#)  
 Front-seat passenger airbags, indicator light [151](#)  
 Front seats [89](#)  
 FTM Flat Tire Monitor [156](#)  
 Fuel [242](#)  
 Fuel cap [240](#)  
 Fuel filler flap [240](#)  
 Fuel gage [131](#)  
 Fuel quality [242](#)  
 Fuel recommendation [242](#)  
 Fuel, tank capacity [297](#)  
 Fuse [281](#)

## G

Garage door opener, see Integrated Universal Remote Control [204](#)  
 Gasoline [242](#)  
 Gear shift indicator [134](#)  
 General driving notes [225](#)  
 General settings [52](#)

Glare shield [209](#)  
 Glass sunroof, initialize the system [88](#)  
 Glass sunroof, see Panoramic glass sunroof [87](#)  
 Glove compartment [218](#)  
 GPS geolocation, vehicle position [53](#)  
 GPS, navigation, see Owner's Handbook for Navigation, Entertainment, Communication [8](#)  
 Gross vehicle weight, approved [297](#)

## H

Halogen headlights [275](#)  
 Handbrake, see Parking brake [109](#)  
 Hand-held transmitter, alternating code [205](#)  
 Hands-free device, see Owner's Handbook for Navigation, Entertainment, Communication [8](#)  
 Hazard warning flashers [283](#)  
 HDC Hill Descent Control [171](#)  
 Head airbags [148](#)  
 Headlight control, automatic [144](#)  
 Headlight courtesy delay feature [144](#)  
 Headlight flasher [111](#)  
 Headlight flasher, bulb replacement [276](#)  
 Headlight glass [274](#)  
 Headlights [275](#)  
 Headlights, care [291](#)  
 Head restraints, front [94](#)  
 Head restraints, rear [95](#)  
 Head-up Display [140](#)  
 Head-up Display, care [293](#)  
 Head-up Display, see Memory function [96](#)  
 Heated steering wheel [99](#)  
 Heavy cargo, stowing cargo [229](#)  
 High-beam Assistant [145](#)  
 High beams [111](#)  
 High beams/low beams, see High-beam Assistant [145](#)  
 High beams, bulb replacement [276](#)  
 Hill Descent Control HDC [171](#)  
 Hills [227](#)  
 Hill start assistant, see Drive-off assistant [174](#)  
 Holder for beverages [219](#)  
 Homepage [8](#)  
 Hood [263](#)  
 Horn [36](#)  
 Hot exhaust gas system [225](#)

Hotline, see Owner's Handbook for Navigation, Entertainment, Communication [8](#)  
HUD Head-up Display [140](#)  
Hydroplaning [226](#)

**I**

Ice warning, see External temperature warning [132](#)  
Icy roads, see External temperature warning [132](#)  
Identification marks, tires [246](#)  
Identification number, see Vehicle identification number [14](#)  
iDrive [40](#)  
Ignition key, see Remote control [72](#)  
Ignition off [105](#)  
Ignition on [105](#)  
Indicator and warning lights, see Check Control [127](#)  
Indicator light, see Check Control [127](#)  
Individual air distribution [197](#), [200](#)  
Individual settings, see Driver profiles [80](#)  
Inductive charging of a smartphone, see Wireless charging tray, see Owner's Manual for Navigation, Entertainment, Communication [8](#)  
Inflation pressure, tires [244](#)  
Inflation pressure warning FTM, tires [156](#)  
Info Display, see Onboard Computer [136](#)  
Information [8](#)  
Initialize, Tire Pressure Monitor TPM [152](#)  
Initializing, Flat Tire Monitor FTM [156](#)  
Instrument cluster [127](#)  
Instrument lighting [146](#)  
Integrated key [72](#)  
Integrated Owner's Manual in the vehicle [64](#)  
Intelligent emergency call [284](#)  
Intelligent Safety [158](#)  
Intended use [9](#)  
Intensity, AUTO program [200](#)  
Interior equipment [204](#)  
Interior lights [147](#)  
Interior lights during unlocking [69](#)  
Interior lights with the vehicle locked [70](#)  
Interior mirror [97](#)  
Interior mirror, automatic dimming feature [98](#)  
Interior mirror, compass [207](#)

Interior mirror, manually dimmable [98](#)  
Interior motion sensor [85](#)  
Internet connection [60](#)  
Internet hotspot [60](#)  
Internet page [8](#)  
Interval display, service requirements [133](#)  
Interval mode [112](#), [116](#)  
In the vicinity of the center console [38](#)  
In the vicinity of the roofliner [39](#)  
In the vicinity of the steering wheel [36](#)  
IOM, see Integrated Owner's Manual in the vehicle [64](#)

**J**

Jacking points for the vehicle jack [258](#)  
Jam protection system, glass sunroof [88](#)  
Jam protection system, windows [86](#)  
Jump-starting [285](#)

**K**

Key/remote control [72](#)  
Keyless Go, see Comfort Access [74](#)  
Key, see Remote control [68](#)  
Kickdown, Steptronic transmission [122](#)  
Knee airbag [149](#)

**L**

Label on recommended tires [250](#)  
Label, runflat tires [251](#)  
Lane departure warning [165](#)  
Lane threshold, warning [165](#)  
Language, on the Control Display [52](#)  
LATCH child restraint fixing system [102](#)  
Launch Control [125](#)  
Leather, care [292](#)  
LED headlights [277](#)  
LEDs, light-emitting diodes [274](#)  
Light [143](#)  
Light-alloy wheels, care [292](#)  
Light-emitting diodes, LEDs [274](#)  
Lighter [209](#)  
Lighting [143](#)  
Light replacement [274](#)

Light replacement, front [275](#)  
 Light replacement, rear [278](#)  
 Lights and bulbs [274](#)  
 Light switch [143](#)  
 List of all messages [54](#)  
 Load [229](#)  
 Loading [228](#)  
 Loading position [213](#)  
 Location, vehicle position [53](#)  
 Locking, automatic [83](#)  
 Locking, see Opening and Closing [68](#)  
 Locking, settings [82](#)  
 Low beams [143](#)  
 Low beams, automatic, see High-beam Assistant [145](#)  
 Low beams, bulb replacement [275](#)  
 Lower back support [90](#)  
 Lug bolt lock [257](#)  
 Luggage rack, see Roof-mounted luggage rack [229](#)  
 Lumbar support [90](#)

## M

Maintenance [271](#)  
 Maintenance requirements [271](#)  
 Maintenance, service requirements [133](#)  
 Maintenance system, BMW [271](#)  
 Make-up mirror [209](#)  
 Malfunction displays, see Check Control [127](#)  
 Manual air distribution [197](#), [200](#)  
 Manual air flow [197](#), [200](#)  
 Manual brake, see Parking brake [109](#)  
 Manual operation, fuel filler flap [241](#)  
 Manual operation, PDC Park Distance Control [185](#)  
 Manual operation, rearview camera [188](#)  
 Map update, see Owner's Handbook for Navigation, Entertainment, Communication [8](#)  
 Master key, see Remote control [72](#)  
 Matte finish [291](#)  
 Maximum cooling [199](#)  
 Maximum speed, display [134](#)  
 Maximum speed, winter tires [250](#)  
 Measurement, units of [53](#)  
 Medical kit [283](#)

Memory function [96](#)  
 Menu in instrument cluster [136](#)  
 Menus [44](#)  
 Menus, operating, iDrive [40](#)  
 Messages [54](#)  
 Messages, see Check Control [127](#)  
 Microfilter [197](#), [201](#)  
 Minimum tread, tires [248](#)  
 Mirror [97](#)  
 Mirror, see Memory function [96](#)  
 Mobile communication devices in the vehicle [226](#)  
 Mobility System [251](#)  
 Modifications, technical, see For Your Own Safety [9](#)  
 Moisture in headlight [274](#)  
 Monitor, see Control Display [42](#)  
 Mounting of child restraint systems [101](#)  
 Moving sun visor [209](#)  
 MP3 player, see Audio, see Owner's Handbook for Navigation, Entertainment, Communication [8](#)  
 Multifunction steering wheel, buttons [36](#)  
 Multimedia, see Owner's Manual for Navigation, Entertainment and Communication [8](#)  
 Music hard disk, see Owner's Handbook for Navigation, Entertainment, Communication [8](#)

## N

Navigation, see Owner's Manual for Navigation, Entertainment and Communication [8](#)  
 Neck restraints, front, see Head restraints [94](#)  
 Neck restraints, rear, see Head restraints [95](#)  
 Neutral cleaner, see Wheel cleaner [292](#)  
 New wheels and tires [249](#)  
 Notes, see Owner's Handbook for Navigation, Entertainment, Communication [8](#)

## O

OBD Onboard Diagnosis [272](#)  
 OBD, see OBD Onboard Diagnosis [272](#)  
 Obstacle marking, rearview camera [189](#)  
 Octane rating, see Recommended fuel grade [243](#)

Odometer [131](#)  
 Office, see Owner's Manual for Navigation, Entertainment and Communication [8](#)  
 Oil [265](#)  
 Oil, adding [266](#)  
 Oil change [268](#)  
 Oil change interval, service requirements [133](#)  
 Oil filler neck [266](#)  
 Oil types to add, engine [267](#)  
 Old batteries, disposal [281](#)  
 Onboard Computer [136](#)  
 Onboard literature, printed [64](#)  
 Onboard vehicle tool kit [273](#)  
 On-call service, see Breakdown assistance [283](#)  
 Online Entertainment, see Owner's Handbook for Navigation, Entertainment, Communication [8](#)  
 Opening and closing [68](#)  
 Opening the tailgate with no-touch activation [75](#)  
 Operating concept, iDrive [40](#)  
 Operating via iDrive [44](#)  
 Operating with the Controller [44](#)  
 Operation via touchscreen [45](#)  
 Optional equipment [9](#)  
 Outside air, see Automatic recirculated-air control [200](#)  
 Owner's Manual media [64](#)  
 Owner's Manual, printed [64](#)

## P

Paint, vehicle [291](#)  
 Pair device [56](#)  
 Panic alarm, see Panic mode [84](#)  
 Panic mode [84](#)  
 Panoramic glass sunroof [87](#)  
 Parallel parking assistant [190](#)  
 Park Distance Control PDC [184](#)  
 Parked-car ventilation [202](#)  
 Parked vehicle, condensation [227](#)  
 Parking aid, see PDC [184](#)  
 Parking assistant [190](#)  
 Parking brake [109](#)  
 Parking lights [143](#)  
 Partition net [215](#)  
 Parts and accessories [10](#)

Passenger's side mirror, tilting downward [98](#)  
 Pathway lines, rearview camera [189](#)  
 PDC Park Distance Control [184](#)  
 Performance Control [171](#)  
 Personal profile, see Driver profiles [80](#)  
 Person warning with City light braking function [162](#)  
 Plastic, care [292](#)  
 PostCrash [168](#)  
 Power failure [281](#)  
 Power windows [85](#)  
 Pressure, tires [244](#)  
 Pressure warning FTM, tires [156](#)  
 Printed onboard literature [64](#)  
 Profiles, see Driver profiles [80](#)  
 Programmable memory buttons, iDrive [47](#)  
 Protective function, glass sunroof [88](#)  
 Protective function, windows [86](#)  
 Push-and-turn reel, see Controller [42, 43](#)

## R

Racetrack operation [227](#)  
 Radiator fluid [269](#)  
 Radio-operated key, see Remote control [72](#)  
 Radio-operated remote control, see Remote control [68](#)  
 Radio-ready state [105](#)  
 Radio, see Owner's Manual for Navigation, Entertainment and Communication [8](#)  
 Rain sensor [112, 116](#)  
 Rear lights [278](#)  
 Rear seats [91](#)  
 Rear socket [210](#)  
 Rearview camera [187](#)  
 Rear window defroster [197, 201](#)  
 Rear window wiper, operation [114, 117](#)  
 Recirculated-air filter [201](#)  
 Recirculated-air mode [196, 200](#)  
 Recommended fuel grade [243](#)  
 Recommended tire brands [250](#)  
 Refueling [240](#)  
 Remaining range [132](#)  
 Remote control/key [72](#)  
 Remote control, additional [71](#)

Remote control for audio, see Owner's Handbook for Navigation, Entertainment, Communication [8](#)

Remote control, loss [71](#)

Remote control, malfunction [71](#)

Remote control, opening/closing [68](#)

Remote control, universal [204](#)

Remote services, app, see Owner's Handbook for Navigation, Entertainment, Communication [8](#)

Replacing parts [273](#)

Replacing wheels/tires [249](#)

Reporting safety malfunctions [15](#)

RES CNCL button, see Camera-based cruise control, ACC [175](#)

RES CNCL button, see Cruise control [181](#)

Reserve warning, see Range [132](#)

Reset, Tire Pressure Monitor TPM [152](#)

Retreaded tires [250](#)

Roadside Assistance, see Breakdown assistance [283](#)

Roadside parking lights [144](#)

Rolling code hand-held transmitter [205](#)

RON recommended fuel grade [243](#)

Roofliner [39](#)

Roof load capacity [297](#)

Roof-mounted luggage rack [229](#)

Route, navigation, see Owner's Handbook for Navigation, Entertainment, Communication [8](#)

RSC Runflat System Component, see Runflat tires [251](#)

RTTI, see Owner's Handbook for Navigation, Entertainment, Communication [8](#)

Rubber components, care [292](#)

Runflat tires [251](#)

## S

Safe braking [226](#)

Safety belt reminder for driver's seat and front passenger seat [94](#)

Safety belts [92](#)

Safety belts, care [293](#)

Safety locks, doors, and windows [104](#)

Safety switch, windows [86](#)

Safety systems, airbags [148](#)

Saving fuel [231](#)

Screen, see Control Display [42](#)

Screwdriver, see Onboard vehicle tool kit [273](#)

Sealant [251](#)

Seat heating, front [91](#)

Seating position for children [100](#)

Seat, see Memory function [96](#)

Seats, front [89](#)

Seats, rear [91](#)

Securing cargo [229](#)

Selection list in instrument cluster [136](#)

Selector lever, see Steptronic transmission [119](#)

Sensors, care [293](#)

Service and warranty [11](#)

Service requirements, Condition Based Service CBS [271](#)

Service requirements, display [133](#)

Services, ConnectedDrive, see Owner's Manual for Navigation, Entertainment and Communication [8](#)

Servotronic [173](#)

SET button, see Camera-based cruise control, ACC [175](#)

SET button, see Cruise control [181](#)

Settings, locking/unlocking [82](#)

Settings on the Control Display [52](#)

Shifting, Steptronic transmission [119](#)

Shift paddles on the steering wheel [124](#)

Side airbags [148](#)

Signaling, horn [36](#)

Signals when unlocking [83](#)

Sitting safely [89](#)

Size [296](#)

Ski and snowboard bag [216](#)

Slide/tilt glass roof [87](#)

SMS, see Short messages, see Owner's Handbook for Navigation, Entertainment, Communication [8](#)

SMS text message, supplementary [131](#)

Snow chains [255](#)

Socket, OBD Onboard Diagnosis [272](#)

Sockets [210](#)

Software update [62](#)

SOS button [284](#)

Sound output, see Owner's Handbook for Navigation, Entertainment, Communication [8](#)

Spare tire, see Emergency wheel [260](#)  
Speed, average [137](#)  
Speed Limit Info [134](#)  
Speed limits, display [134](#)  
Speed warning [139](#)  
Split screen [41](#)  
Sport displays [139](#)  
SPORT program, driving dynamics [173](#)  
Stability control systems [169](#)  
Standard equipment [9](#)  
Start/stop, automatic function [107](#)  
Start/Stop button [105](#)  
Starting the engine [106](#)  
Stations, AM/FM, see Owner's Handbook for Navigation, Entertainment, Communication [8](#)  
Status control display, tires [152](#)  
Status information, iDrive [41](#)  
Status of Owner's Manual [9](#)  
Status, vehicle [141](#)  
Steering assistance [173](#)  
Steering wheel, adjusting [99](#)  
Steptronic Sport transmission, see Steptronic transmission [119](#)  
Steptronic Sport transmission with double clutch, see Steptronic transmission [119](#)  
Steptronic transmission [119](#)  
Steptronic transmission with double clutch, see Steptronic transmission [119](#)  
Stopping the engine [107](#)  
Storage compartment in the rear [219](#)  
Storage compartments [217](#)  
Storage compartments, locations [217](#)  
Storage, tires [250](#)  
Storing the vehicle [293](#)  
Stowing and securing cargo [229](#)  
Suitable devices [57](#)  
Suitable mobile phones [57](#)  
Summer tires, tread [248](#)  
Sun visor [209](#)  
Supplementary Owner's Manuals [64](#)  
Supplementary SMS text message [131](#)  
Switch for driving dynamics [173](#)  
Switch, see Cockpit [36](#)  
Symbols [8](#)  
SYNC program, automatic climate control [201](#)

## T

Tachometer [131](#)  
Tailgate, automatic [78](#)  
Tailgate, closing with no-touch activation [75](#)  
Tailgate opening [77](#)  
Tailgate, opening with no-touch activation [75](#)  
Tailgate via remote control [70](#)  
Tail lights [278](#)  
Technical changes, see For Your Own Safety [9](#)  
Technical data [296](#)  
Telephone, see Owner's Manual for Navigation, Entertainment and Communication [8](#)  
Teleservices, see Owner's Handbook for Navigation, Entertainment, Communication [8](#)  
Television, TV, see Owner's Handbook for Navigation, Entertainment, Communication [8](#)  
Temperature, air conditioner [196](#)  
Temperature, automatic climate control [199](#)  
Temperature display for external temperature [132](#)  
Temperature, engine [138](#)  
Terminal, starting aid [286](#)  
Theft alarm system, see Alarm system [84](#)  
Thigh support [90](#)  
Tilt alarm sensor [85](#)  
Time [52](#)  
Time of arrival [138](#)  
Tire damage [248](#)  
Tire identification marks [246](#)  
Tire inflation pressure [244](#)  
Tire inflation pressure monitor, see FTM [156](#)  
Tire pressure [244](#)  
Tire Pressure Monitor TPM [151](#)  
Tire repair kit, see Mobility System [251](#)  
Tires, changing [249](#)  
Tire sealant, see Mobility System [251](#)  
Tires, everything on wheels and tires [244](#)  
Tires, runflat [251](#)  
Tire tread [248](#)  
Tone, see Owner's Manual for Navigation, Entertainment and Communication [8](#)  
Tool [273](#)  
Total vehicle weight [297](#)  
Touchpad [47](#)  
Touchscreen [45](#)

Towing [286](#)  
 Tow-starting [286](#)  
 TPM Tire Pressure Monitor [151](#)  
 Traction control [171](#)  
 TRACTION, driving dynamics [171](#)  
 Traffic bulletins, see Owner's Handbook for Navigation, Entertainment, Communication [8](#)  
 Transmission lock, electronic unlocking [125](#)  
 Transmission lock, releasing manually [124](#)  
 Transmission, Steptronic transmission [119](#)  
 Transporting children safely [100](#)  
 Tread, tires [248](#)  
 Trip computer [138](#)  
 Triple turn signal activation [111](#)  
 Trip odometer [131](#)  
 Trip recorder, see Trip odometer [131](#)  
 Turning radius lines, rearview camera [189](#)  
 Turn signal, bulb replacement, halogen headlights [275](#)  
 Turn signal, bulb replacement, LED headlights [277](#)  
 Turn signal, indicator light [130](#)  
 Turn signals, operation [111](#)  
 Turn signals, rear, bulb replacement [278](#)  
 TV, see Owner's Handbook for Navigation, Entertainment, Communication [8](#)

## U

Unintentional alarm [85](#)  
 Units of measurement [53](#)  
 Universal remote control [204](#)  
 Unlock button, see Steptronic transmission [119](#)  
 Unlocking, automatic [83](#)  
 Unlocking, see Opening and Closing [68](#)  
 Unlocking, settings [82](#)  
 Unpaved roads, cross-country trips [225](#)  
 Updates made after the editorial deadline [9](#)  
 Upholstery care [292](#)  
 USB connection [59](#)  
 USB interface, general information [211](#)  
 USB port, see USB interface [211](#)  
 Use, intended [9](#)  
 Using a smartphone via voice activation [49](#)

## V

Vanity mirror [209](#)  
 Vehicle battery [280](#)  
 Vehicle battery, replacing [280](#)  
 Vehicle, break-in [224](#)  
 Vehicle care [291](#)  
 Vehicle care products [291](#)  
 Vehicle features and options [9](#)  
 Vehicle identification number [14](#)  
 Vehicle jack [258](#)  
 Vehicle key, see Remote control [68, 72](#)  
 Vehicle paint [291](#)  
 Vehicle position, vehicle location [53](#)  
 Vehicle status [141](#)  
 Vehicle storage [293](#)  
 Vehicle wash [290](#)  
 Vehicle, washing [290](#)  
 Ventilation [202](#)  
 Ventilation, see Parked-car ventilation [202](#)  
 VIN, see Vehicle identification number [14](#)  
 Voice activation system [49](#)  
 Voice command response, see Owner's Handbook for Navigation, Entertainment, Communication [8](#)

## W

Warning and indicator lights, see Check Control [127](#)  
 Warning displays, see Check Control [127](#)  
 Warning messages, see Check Control [127](#)  
 Warning triangle [283](#)  
 Warranty [10](#)  
 Washer fluid [118](#)  
 Washer nozzles, windshield [114, 117](#)  
 Washer system [112, 115](#)  
 Washing the vehicle [290](#)  
 Water on roads [226](#)  
 Weights [297](#)  
 Welcome lights [144](#)  
 Welcome lights during unlocking [69](#)  
 Wheel cleaner [292](#)  
 Wheels, changing [249](#)  
 Wheels, everything on wheels and tires [244](#)  
 Wheels, Flat Tire Monitor FTM [156](#)

Wheels, Tire Pressure Monitor TPM [151](#)  
WiFi connection [60](#)  
Window defroster, rear [197](#)  
Windows, powered [85](#)  
Windshield washer fluid [118](#)  
Windshield washer nozzles [114](#), [117](#)  
Windshield washer system [112](#), [115](#)  
Windshield washer system, see Washer/wiper system [112](#), [115](#)  
Windshield wiper, see Wiper system [112](#), [115](#)  
Winter storage, care [293](#)  
Winter tires, suitable tires [250](#)  
Winter tires, tread [248](#)  
Wiper [112](#), [115](#)  
Wiper blades, replacing [273](#)  
Wiper fluid [118](#)  
Wiper, fold-away position [114](#), [117](#)  
Wiper system [112](#), [115](#)  
Wireless charging of a smartphone, see Wireless charging tray, see Owner's Manual for Navigation, Entertainment, Communication [8](#)  
Wireless charging tray, see Owner's Manual for Navigation, Entertainment, Communication [8](#)  
Wood, care [292](#)  
Word match concept, navigation [40](#)  
Wrench, see Onboard vehicle tool kit [273](#)

## X

xDrive [171](#)





01402896498 ue

## California Proposition 65 Warning

---

For vehicles sold in California:

### California Proposition 65 Warning



#### **WARNING**

Operating, servicing and maintaining a passenger vehicle or off-highway motor vehicle can expose you to chemicals including engine exhaust, carbon monoxide, phthalates, and lead, which are known to the State of California to cause cancer and birth defects or other reproductive harm. To minimize exposure, avoid breathing exhaust, do not idle the engine except as necessary, service your vehicle in a well-ventilated area and wear gloves or wash your hands frequently when servicing your vehicle. For more information go to [www.P65Warnings.ca.gov/passenger-vehicle](http://www.P65Warnings.ca.gov/passenger-vehicle).



The Ultimate  
Driving Machine®



# BMW DRIVER'S GUIDE APP.

Your customized information about the vehicle in an app.  
Optimized for smartphones & tablets. Can be used offline.



Download on the  
**App Store**



GET IT ON  
**Google Play**



01402896498 ue

Online Edition for Part no. 01402896498 - X/18