

GRAND CHEROKEE/GRAND CHEROKEE L

OWNER'S MANUAL

Jeep®



This Owner's Manual illustrates and describes the operation of features and equipment that are either standard or optional on this vehicle. This manual may also include a description of features and equipment that are no longer available or were not ordered on this vehicle. Please disregard any features and equipment described in this manual that are not on this vehicle. FCA US LLC reserves the right to make changes in design and specifications, and/or make additions to or improvements to its products without imposing any obligation upon itself to install them on products previously manufactured.

With respect to any vehicles sold in Canada, the name FCA US LLC shall be deemed to be deleted and the name FCA Canada Inc. used in substitution therefore.

This Owner's Manual is intended to familiarize you with the important features of your vehicle. Your most up-to-date Owner's Manual, Radio Instruction Manual and Warranty Booklet can be found by visiting the website on the back cover.

ROADSIDE ASSISTANCE

24 HOURS, 7 DAYS A WEEK AT YOUR SERVICE.

CALL 1-800-521-2779 OR VISIT CHRYSLER.RSAHELP.COM (USA)

CALL 1-800-363-4869 OR VISIT FCA.ROADSIDEAID.COM (CANADA)

SERVICES: Flat Tire Service, Out Of Gas/Fuel Delivery, Battery Jump Assistance, Lockout Service and Towing Service

Please see the Customer Assistance chapter in this Owner's Manual for further information.

FCA US LLC reserves the right to modify the terms or discontinue the Roadside Assistance Program at any time. The Roadside Assistance Program is subject to restrictions and conditions of use, that are determined solely by FCA US LLC.

 **WARNING:** Operating, servicing and maintaining a passenger vehicle or off-highway motor vehicle can expose you to chemicals including engine exhaust, carbon monoxide, phthalates, and lead, which are known to the State of California to cause cancer and birth defects or other reproductive harm. To minimize exposure, avoid breathing exhaust, do not idle the engine except as necessary, service your vehicle in a well-ventilated area and wear gloves or wash your hands frequently when servicing your vehicle. For more information go to www.P65Warnings.ca.gov/passenger-vehicle.



TABLE OF CONTENTS

1	INTRODUCTION	8
2	GETTING TO KNOW YOUR VEHICLE.....	17
3	GETTING TO KNOW YOUR INSTRUMENT PANEL	82
4	STARTING AND OPERATING	103
5	MULTIMEDIA	169
6	SAFETY	205
7	IN CASE OF EMERGENCY	252
8	SERVICING AND MAINTENANCE	270
9	TECHNICAL SPECIFICATIONS.....	321
10	CUSTOMER ASSISTANCE.....	327
11	INDEX	332

1

2

3

4

5

6

7

8

9

10

11

INTRODUCTION

SYMBOLS KEY	9
ROLLOVER WARNING	9
VEHICLE MODIFICATIONS/ALTERATIONS	10
SYMBOL GLOSSARY	10

GETTING TO KNOW YOUR VEHICLE

KEYS	17
Key Fob	17
SENTRY KEY	20
IGNITION SWITCH	21
Keyless Enter 'n Go™ Ignition	21
REMOTE START — IF EQUIPPED	22
How To Use Remote Start	22
To Exit Remote Start Mode	23
Remote Start Front Defrost Activation — If Equipped	23
Remote Start Comfort Systems — If Equipped	23
Remote Start Windshield Wiper De-Icer Activation — If Equipped	23
Remote Start Abort Message	23
VEHICLE SECURITY SYSTEM — IF EQUIPPED	24
To Arm The System	24
To Disarm The System	24
Rearming Of The System	24
Security System Manual Override	24
Tamper Alert	24

DELUXE VEHICLE SECURITY SYSTEM — IF EQUIPPED	25
To Arm The System	25
To Disarm The System	25
Security System Manual Override	26
DOORS	26
Manual Door Locks	26
Power Door Locks	26
Keyless Enter 'n Go™ — Passive Entry	27
Automatic Unlock Doors On Exit	29
Automatic Door Locks — If Equipped	29
Child-Protection Door Lock System — Rear Doors	29
STEERING WHEEL	29
Manual Tilt/Telescoping Steering Column — If Equipped	29
Power Tilt/Telescoping Steering Column — If Equipped	30
Heated Steering Wheel — If Equipped	30
UNCONNECT VOICE RECOGNITION QUICK TIPS — IF EQUIPPED	31
Introducing Voice Recognition	31
Basic Voice Commands	31
Get Started	31
Additional Information	31
DRIVER AND PASSENGER MEMORY SETTINGS — IF EQUIPPED	31
Programming The Memory Feature	32
Linking And Unlinking The Key Fob To Memory	32
Memory Position Recall	32

SEATS	33
Manual Adjustment Front Seats — If Equipped	33
Manual Adjustment Rear Seats	34
Power Adjustment Front Seats — If Equipped	37
Power Adjustment Rear Seats — If Equipped	39
Power Seatback Massage — If Equipped	40
Heated Seats — If Equipped	40
Ventilated Seats — If Equipped	41
Head Restraints	42
MIRRORS	44
Inside Rearview Mirror	44
Illuminated Vanity Mirrors	45
Outside Mirrors	45
Outside Automatic Dimming Mirror — If Equipped	46
Power Mirrors	46
Automatic Power Folding Mirrors — If Equipped	47
Heated Mirrors — If Equipped	47
Tilt Side Mirrors In Reverse — If Equipped	47
UNIVERSAL GARAGE DOOR OPENER (HOMELINK®) — IF EQUIPPED	47
Before You Begin Programming HomeLink®	47
Erasing All The HomeLink® Channels	48
Identifying Whether You Have A Rolling Code Or Non-Rolling Code Device	48
Programming HomeLink® To A Garage Door Opener	48
Programming HomeLink® To A Miscellaneous Device	49
Reprogramming A Single HomeLink® Button	49
Canadian/Gate Operator Programming	49
Security	50
Troubleshooting Tips	50

EXTERIOR LIGHTS	50	INTERIOR STORAGE AND EQUIPMENT	65	INSTRUMENT CLUSTER DISPLAY	85
Headlight Switch	50	Storage	65	Location And Controls	85
Multifunction Lever	51	Lighted Cupholders — If Equipped	66	Engine Oil Life Reset	87
Daytime Running Lights (DRLs) — If Equipped	51	Sun Screens — If Equipped	67	Display And Messages	88
High/Low Beam Switch	51	USB/AUX Control	67	Instrument Cluster Display Menu Items	89
Automatic High Beams — If Equipped	52	Electrical Power Outlets	69	Head Up Display (HUD) — If Equipped	91
Flash-To-Pass	52	Power Inverter — If Equipped	70	Battery Saver On/Battery Saver Mode Message — Electrical Load Reduction Actions — If Equipped	92
Automatic Headlights	52	Wireless Charging Pad — If Equipped	70		
Parking Lights And Panel Lights	52	WINDOWS	71	WARNING LIGHTS AND MESSAGES	93
Headlights On Automatically With Wipers	52	Power Window Controls	71	Red Warning Lights	93
Headlight Illumination On Approach	52	Wind Buffeting	72	Yellow Warning Lights	96
Headlight Delay	53	POWER SUNROOF — IF EQUIPPED	73	Yellow Indicator Lights	98
Lights-On Reminder	53	Single Pane Power Sunroof — If Equipped	73	Green Indicator Lights	99
Front Fog Lights — If Equipped	53	Dual Pane Power Sunroof — If Equipped	74	White Indicator Lights	100
Turn Signals	54	HOOD	75	Blue Indicator Lights	101
Lane Change Assist — If Equipped	54	Opening The Hood	75	Gray Indicator Lights	101
Automatic Headlight Leveling — If Equipped	54	Closing The Hood	76	ONBOARD DIAGNOSTIC SYSTEM — OBD II	101
Battery Saver	54	LIFTGATE	76	Onboard Diagnostic System (OBD II) Cybersecurity	101
INTERIOR LIGHTS	54	To Unlock/Open The Liftgate	76	EMISSIONS INSPECTION AND MAINTENANCE PROGRAMS	102
Courtesy Lights	54	To Lock/Close The Liftgate	76		
WINDSHIELD WIPERS AND WASHERS	56	Adjustable Power Liftgate Height	77	STARTING AND OPERATING	
Windshield Wiper Operation	56	Hands-Free Liftgate — If Equipped	77	STARTING THE ENGINE — GRAND CHEROKEE	103
Rain Sensing Wipers — If Equipped	57	Cargo Area Features	78	Automatic Transmission	103
Rear Wiper And Washer	57	ROOF LUGGAGE RACK — IF EQUIPPED	81	Keyless Enter 'n Go™ — Ignition	103
Windshield Wiper De-Icer — If Equipped	57	GETTING TO KNOW YOUR INSTRUMENT PANEL		Normal Starting	103
CLIMATE CONTROLS	57	DIGITAL INSTRUMENT CLUSTER	82	AutoPark	104
Automatic Climate Control Descriptions And Functions	58	Digital Instrument Cluster Descriptions	83	Extended Park Starting	105
Automatic Temperature Control (ATC)	63	ANALOG INSTRUMENT CLUSTER	84	If Engine Fails To Start	105
Climate Voice Recognition	63	Analog Instrument Cluster Descriptions	85		
Operating Tips	64				

Cold Weather Operation (Below -22°F Or -30°C)	105		
After Starting	105		
ENGINE BREAK-IN RECOMMENDATIONS	105		
PARKING BRAKE	106		
Electric Park Brake (EPB)	106		
Auto Park Brake	107		
SafeHold	107		
Hold 'N Go — If Equipped	108		
Brake Maintenance Mode	108		
AUTOMATIC TRANSMISSION	108		
Ignition Park Interlock	109		
Brake/Transmission Shift Interlock (BTSI) System	109		
8-Speed Automatic Transmission	109		
SPORT MODE — IF EQUIPPED	112		
FOUR-WHEEL DRIVE OPERATION	112		
Quadra-Trac I Operating Instructions/ Precautions — If Equipped	113		
Quadra-Trac II Operating Instructions/ Precautions — If Equipped	113		
Shift Positions	113		
Shifting Procedures	113		
Quadra-Trac II System — If Equipped	114		
Electronic Sway Bar Disconnect — If Equipped	114		
SELEC-TERRAIN — IF EQUIPPED	115		
Selec-Terrain Mode Selection	115		
Instrument Cluster Display Messages	116		
QUADRA-LIFT — IF EQUIPPED	116		
Description	116		
Air Suspension Modes	118		
Instrument Cluster Display Messages	118		
Operation	118		
		FUEL SAVER TECHNOLOGY 5.7L ONLY	119
		POWER STEERING	119
		STOP/START SYSTEM — IF EQUIPPED	119
		Autostop Mode	119
		Possible Reasons The Engine Does Not Autostop	119
		To Start The Engine While In Autostop Mode	120
		To Manually Turn Off The Stop/Start System	120
		To Manually Turn On The Stop/Start System	120
		System Malfunction	120
		CRUISE CONTROL SYSTEMS	120
		Adaptive Cruise Control (ACC)	121
		TRAFFIC SIGN ASSIST SYSTEM — IF EQUIPPED	128
		Activation/Deactivation	128
		Traffic Sign Assist Modes	128
		Indications On The Display	128
		ACTIVE DRIVING ASSIST SYSTEM — IF EQUIPPED	129
		Operation	129
		Turning Active Driving Assist On Or Off	131
		Indications On The Display	132
		System Status	133
		System Operation/Limitations	133
		PARKSENSE FRONT/REAR PARK ASSIST SYSTEM — IF EQUIPPED	134
		ParkSense Sensors	135
		ParkSense Display	135
		ParkSense Warning Display	138
		Enabling And Disabling ParkSense	138
		Service The ParkSense Park Assist System	138
		Cleaning The ParkSense System	138
		ParkSense System Usage Precautions	138
		Side Distance Warning System	139
		PARKSENSE ACTIVE PARK ASSIST SYSTEM — IF EQUIPPED	141
		Enabling And Disabling The ParkSense Active Park Assist System	141
		Parallel/Perpendicular Parking Space Assistance Operation	142
		Exiting The Parking Space	144
		ACTIVE LANE MANAGEMENT SYSTEM — IF EQUIPPED	144
		Active Lane Management Operation	144
		Turning Active Lane Management On Or Off	145
		Active Lane Management Warning Message	145
		Changing Active Lane Management Status	147
		PARKVIEW REAR BACK UP CAMERA	147
		Zoom View	148
		Viewing At Speed	148
		TRAILCAM SYSTEM — IF EQUIPPED	148
		FAMCAM SYSTEM — IF EQUIPPED	149
		NIGHT VISION CAMERA SYSTEM — IF EQUIPPED	150
		Detection Range	151
		Service The Night Vision System	151
		Night Vision System Limitations	152
		SURROUND VIEW CAMERA SYSTEM — IF EQUIPPED	152
		Zoom View	154
		REFUELING THE VEHICLE	154
		VEHICLE LOADING	155
		Gross Vehicle Weight Rating (GVWR)	155
		Payload	155
		Gross Axle Weight Rating (GAWR)	155
		Tire Size	155
		Rim Size	155
		Inflation Pressure	155

Curb Weight	155	PASSENGER SCREEN — IF EQUIPPED	189	Replacing the Voice Remote with Alexa	
Loading	155	Passenger Screen Permissions	189	Batteries	198
TRAILER TOWING	156	Home Screen	190	Rear Seat Entertainment with Fire TV built-in	
Common Towing Definitions	156	Audio And Video	191	streaming (Using the Front Radio and Rear	
Trailer Hitch Classification	158	Rear Seat Entertainment With Amazon Fire TV		Screens)	198
Trailer Towing Weights		Built-In — If Equipped	192	Fire TV Apps/Games (Using the Rear Screens)	199
(Maximum Trailer Weight Ratings)	158	HDMI Projecting	192	Are We There Yet?	199
Trailer Hitch Receiver Cover Removal —		Device Manager	192	Using The Video USB Port	199
If Equipped	160	Navigation	192	Play Video Games	199
Trailer And Tongue Weight	160	Camera	193	Headphones Operation	200
Towing Requirements	160	3RD PARTY APPS	193	Rear Climate Controls	200
Towing Tips	162	REAR SEAT ENTERTAINMENT (RSE) WITH		Legal & Compliance	202
RECREATIONAL TOWING (BEHIND MOTORHOME)	163	AMAZON FIRE TV BUILT-IN — IF EQUIPPED	194	OFF-ROAD PAGES — IF EQUIPPED	202
Towing This Vehicle Behind Another Vehicle	163	Overview	194	Off-Road Pages Status Bar	202
Recreational Towing — Two-Wheel Drive		Getting Started	194	Vehicle Dynamics	203
Models	163	Accessing Rear Seat Entertainment with Fire TV		Accessory Gauges	203
Recreational Towing — Quadra-Trac I		built-in from the Front Radio Screen	195	Pitch & Roll	203
(Single-Speed Transfer Case without 4WD LOW		Accessing Rear Seat Entertainment with Fire TV		Selec-Terrain — If Equipped	204
Range) Four-Wheel Drive Models	164	built-in from the Rear Screens	195	Suspension — If Equipped	204
Recreational Towing — Quadra-Trac II with		Accessing Rear Seat Entertainment with Fire TV		RADIO OPERATION AND MOBILE PHONES	204
4WD LOW Range	164	built-in from the Passenger Screen —		Regulatory And Safety Information	204
DRIVING TIPS	166	If Equipped	195	SAFETY	
On-Road Driving Tips	166	First Time Starting Up (Using the Rear		SAFETY FEATURES	205
Off-Road Driving Tips	167	Screens)	195	Anti-Lock Brake System (ABS)	205
MULTIMEDIA		Alexa Voice Control	196	Drowsy Driver Detection (DDD) — If Equipped	205
UCONNECT SYSTEMS	169	Listen Via Vehicle Speakers	196	Rear Seat Reminder Alert (RSRA)	206
CYBERSECURITY	169	Quick Menu	196	Electronic Brake Control (EBC) System	206
UCONNECT SETTINGS	169	Parental Controls (Using the Rear Screens)	196	AUXILIARY DRIVING SYSTEMS	212
Customer Programmable Features	170	Voice Remote with Alexa Pairing		Blind Spot Monitoring (BSM)	212
STEERING WHEEL AUDIO CONTROLS	189	(Using the Rear Screens)	196	Forward Collision Warning (FCW)	
Radio Operation	189	Media Sources Input		With Mitigation	215
Media Mode	189	(Using the Front Radio and Rear Screens)	197	Tire Pressure Monitoring System (TPMS)	218
		Voice Remote with Alexa	197		

OCCUPANT RESTRAINT SYSTEMS	222	REFUELING IN EMERGENCY	264	Cooling System	284
Occupant Restraint Systems Features	222	IF YOUR ENGINE OVERHEATS	265	Brake System	286
Important Safety Precautions	222	MANUAL PARK RELEASE	266	Automatic Transmission	287
Seat Belt Systems	222	FREEING A STUCK VEHICLE	267	Front/Rear Axle Fluid	288
Supplemental Restraint Systems (SRS)	228	TOWING A DISABLED VEHICLE	267	Transfer Case	288
Child Restraints	237	Rear-Wheel Drive Models	268	Fuses	288
SAFETY TIPS	248	Four-Wheel Drive Models	268	Bulb Replacement	304
Transporting Passengers	248	Emergency Tow Hooks — If Equipped	269	TIRES	304
Transporting Pets	248	ENHANCED ACCIDENT RESPONSE SYSTEM (EARS)	269	Tire Safety Information	304
Connected Vehicles	249	EVENT DATA RECORDER (EDR)	269	Tires — General Information	310
Safety Checks You Should Make Inside				Tire Types	313
The Vehicle	249			Spare Tires — If Equipped	313
Periodic Safety Checks You Should Make				Wheel And Wheel Trim Care	315
Outside The Vehicle	250			Snow Traction Devices	316
Exhaust Gas	250			Tire Rotation Recommendations	317
Carbon Monoxide Warnings	251			DEPARTMENT OF TRANSPORTATION UNIFORM	
				TIRE QUALITY GRADES	317
IN CASE OF EMERGENCY		SERVICING AND MAINTENANCE		Treadwear	318
HAZARD WARNING FLASHERS	252	SCHEDULED SERVICING	270	Traction Grades	318
ASSIST AND SOS SYSTEM — IF EQUIPPED	252	Maintenance Plan — Gasoline Engines	270	Temperature Grades	318
JACKING AND TIRE CHANGING	255	ENGINE COMPARTMENT	273	STORING THE VEHICLE — GRAND CHEROKEE	318
Preparations For Jacking	255	2.0L Engine	273	BODYWORK	319
Jack Location	255	3.6L Engine	274	Protection From Atmospheric Agents	319
Spare Tire Stowage	257	5.7L Engine	275	Body And Underbody Maintenance	319
Spare Tire Removal	257	Checking Oil Level	276	Preserving The Bodywork	319
Jacking Instructions	259	Adding Washer Fluid	276	INTERIORS	320
JUMP STARTING	263	Maintenance-Free Battery	276	Seats And Fabric Parts	320
Preparations For Jump Start	263	Pressure Washing	277	Plastic And Coated Parts	320
Jump Starting Procedure	264	VEHICLE MAINTENANCE	277	Leather Surfaces	320
		Engine Oil	277	Glass Surfaces	320
		Engine Oil Filter	278		
		Engine Air Cleaner Filter	278		
		Air Conditioner Maintenance	278		
		Accessory Drive Belt Inspection	280		
		Body Lubrication	281		
		Windshield Wiper Blades	281		
		Exhaust System	283		

TECHNICAL SPECIFICATIONS

VEHICLE IDENTIFICATION NUMBER (VIN)	321
BRAKE SYSTEM	321
WHEEL AND TIRE TORQUE SPECIFICATIONS	321
Torque Specifications	321
FUEL REQUIREMENTS	322
2.0L Engine — Grand Cherokee	322
3.6L Engine	322
5.7L Engine	322
Reformulated Gasoline	322
Materials Added To Fuel	322
Gasoline/Oxygenate Blends	323
Do Not Use E-85 In Non-Flex Fuel Vehicles	323
CNG And LP Fuel System Modifications	323
Methylcyclopentadienyl Manganese Tricarbonyl (MMT) In Gasoline	323
Fuel System Cautions	323
FLUID CAPACITIES — GRAND CHEROKEE	324
ENGINE FLUIDS AND LUBRICANTS — GRAND CHEROKEE	324
ENGINE FLUIDS AND LUBRICANTS — GRAND CHEROKEE 4XE	325
CHASSIS FLUIDS AND LUBRICANTS	326

CUSTOMER ASSISTANCE

SUGGESTIONS FOR OBTAINING SERVICE FOR YOUR VEHICLE	327
Prepare For The Appointment	327
Prepare A List	327
Be Reasonable With Requests	327
IF YOU NEED ASSISTANCE	327
Roadside Assistance	327
FCA US LLC Customer Center	328
FCA Canada Customer Care	328
Mexico	328
Puerto Rico And US Virgin Islands	328
Customer Assistance For The Hearing Or Speech Impaired (TDD/TTY)	328
Service Contract	329
WARRANTY INFORMATION	329
MOPAR® PARTS	329
REPORTING SAFETY DEFECTS	329
In The 50 United States And Washington, D.C.	329
In Canada	330
PUBLICATION ORDER FORMS	330
Change Of Ownership Or Address	330
GENERAL INFORMATION	331

INTRODUCTION

Dear Customer,

Congratulations on the purchase of your new Jeep® vehicle. Be assured that it represents precision workmanship, distinctive styling, and high quality. The all-new Jeep® Grand Cherokee/Grand Cherokee L continues to build on its proud legacy as the most celebrated SUV ever, while raising the bar in luxury and performance. With legendary 4x4 capability, this vehicle breaks new ground in exceptional performance, comfort, and functionality. We have improved on-road refinement and premium styling and craftsmanship inside and out. With an unsurpassed blend of refined sophistication, dynamic performance, cutting edge technologies, and levels of elegance, the new Jeep® Grand Cherokee/Grand Cherokee L carries an attractive presence and capability that is uncommon in its class, unquestionably Jeep® brand, and unmistakably world class.



The all-new Jeep® Grand Cherokee/Grand Cherokee L is a specialized utility vehicle and can go places and perform tasks that are not intended for conventional passenger vehicles. It handles and maneuvers differently from many passenger vehicles both on-road and off-road, so take time to become familiar with your vehicle. If equipped, the two-wheel drive version of this vehicle was designed for on-road use only. It is not intended for off-road driving or use in other severe conditions suited for a four-wheel drive vehicle. Be sure you are familiar with all vehicle controls, particularly those used for braking, steering, transmission, and transfer case shifting. Always observe federal, state, provincial and local laws wherever you drive. As with other vehicles of this type, failure to operate this vehicle correctly may result in loss of control or a collision → page 166.

Please take the time to read all of these publications carefully before driving your vehicle for the first time. Following the instructions, recommendations, tips, and important warnings in this manual will help ensure safe and enjoyable operation of your vehicle.

This Owner's Manual describes all versions of this vehicle. Options and equipment dedicated to specific markets or versions are not expressly indicated in the text. Therefore, you should only consider the information that is related to the trim level, engine, and version that you have purchased. Any content introduced throughout the Owner's Information, which may or may not be applicable to your vehicle, will be identified with the wording "If Equipped". All data contained in this publication are intended to help you use your vehicle in the best possible way. FCA US LLC aims at a constant improvement of the vehicles produced. For this reason, it reserves the right to make changes to the model described for technical and/or commercial reasons. For further information, contact an authorized dealer.

When it comes to service, remember that authorized dealers know your Jeep® best, have factory-trained technicians, genuine Mopar® parts, and care about your satisfaction.

SYMBOLS KEY

WARNING!	These statements apply to operating procedures that could result in a collision, bodily injury and/or death.
CAUTION!	These statements apply to procedures that could result in damage to your vehicle.
NOTE:	A suggestion which will improve installation, operation, and reliability. If not followed, may result in damage.
TIP:	General ideas/solutions/suggestions on easier use of the product or functionality.
PAGE REFERENCE ARROW 	Follow this reference for additional information on a particular feature.
FOOTNOTE 	Supplementary and relevant information pertaining to the topic.

If you do not read the entire Owner's Manual, you may miss important information. Observe all Cautions and Warnings.

ROLLOVER WARNING

Utility vehicles have a significantly higher rollover rate than other types of vehicles. This vehicle has a higher ground clearance and a higher center of gravity than many passenger vehicles. It is capable of performing better in a wide variety of off-road applications. Driven in an unsafe manner, all vehicles can go out of control. Because of the higher center of gravity, if this vehicle is out of control, it may roll over while some other vehicles may not.

Do not attempt sharp turns, abrupt maneuvers, or other unsafe driving actions that can cause loss of vehicle control. Failure to operate this vehicle safely may result in a collision, rollover of the vehicle, and severe or fatal injury. Drive carefully.



90064090

Rollover Warning Label

Failure to use the driver and passenger seat belts provided is a major cause of severe or fatal injury. In fact, the US government notes that the universal use of existing seat belts could cut the highway death toll by 10,000 or more each year and could reduce disabling injuries by two million annually. In a rollover crash, an unbelted person is significantly more likely to die than a person wearing a seat belt. Always buckle up.

VEHICLE MODIFICATIONS/ALTERATIONS

WARNING!



Any modifications or alterations to this vehicle could seriously affect its roadworthiness and safety and may lead to a collision resulting in serious injury or death.







SYMBOL GLOSSARY







Some car components have colored labels with symbols indicating precautions to be observed when using this component. It is important to follow all warnings when operating your vehicle. See below for the definition of each symbol ⇨ page 93.



NOTE:



Warning and Indicator lights are different based upon equipment options and current vehicle status. Some telltales are optional and may not appear.







Red Warning Lights	
	Active Driving Assist - Driver Inattentiveness Warning Light ⇨ page 93
	Air Bag Warning Light ⇨ page 93
	Brake Warning Light ⇨ page 93







Red Warning Lights	
	Battery Charge Warning Light ⇨ page 94
	Door Open Warning Light ⇨ page 94
	Electric Power Steering (EPS) Fault Warning Light ⇨ page 94
	Electronic Throttle Control (ETC) Warning Light ⇨ page 94
	Engine Coolant Temperature Warning Light ⇨ page 94
	Hood Open Warning Light ⇨ page 94







Red Warning Lights	
	Liftgate Open Warning Light ↔ page 94
	Night Vision Animal Warning Light ↔ page 95
	Night Vision Pedestrian Warning Light ↔ page 95
	Oil Pressure Warning Light ↔ page 95
	Oil Temperature Warning Light ↔ page 95
	Rear Seat Belt Reminder Warning Light ↔ page 95







Red Warning Lights	
	Seat Belt Reminder Warning Light ↔ page 95
	Transmission Temperature Warning Light ↔ page 95
	Vehicle Security Warning Light ↔ page 95





Yellow Warning Lights	
	Active Driving Assist - Driver Inattentiveness Warning Light ↔ page 96
	Active Driving Assist Fault Warning Light ↔ page 96
	Active Lane Management Warning Light ↔ page 96







Yellow Warning Lights	
	Air Suspension Fault Warning Light ↪ page 96
	Anti-Lock Brake System (ABS) Warning Light ↪ page 96
	Electric Park Brake Fault Warning Light ↪ page 96
	Electronic Stability Control (ESC) Active Warning Light ↪ page 96
	Electronic Stability Control (ESC) OFF Warning Light ↪ page 96
	Engine Check/Malfunction Indicator Warning Light (MIL) ↪ page 97







Yellow Warning Lights	
	Fuel Level Sensor Failure Warning Light ↪ page 96
	Low Fuel Warning Light ↪ page 96
	Low Washer Fluid Warning Light ↪ page 97
	Night Vision Animal Warning Light ↪ page 95
	Night Vision Pedestrian Warning Light ↪ page 95
	Service 4WD Warning Light ↪ page 97



Yellow Warning Lights	
	Service Active Lane Management Warning Light ↔ page 96
	Service Adaptive Cruise Control (ACC) Warning Light ↔ page 97
	Service Forward Collision Warning (FCW) Or Pedestrian Emergency Braking (PEB) Warning Light ↔ page 97
	Service Stop/Start System Warning Light ↔ page 97
	Sway Bar Fault Warning Light ↔ page 98
	Tire Pressure Monitoring System (TPMS) Warning Light ↔ page 98





Yellow Indicator Lights	
	4WD Low Indicator Light ↔ page 98
	Air Suspension Active Indicator Light ↔ page 98
	Air Suspension Aerodynamic Height Indicator Light ↔ page 99
	Air Suspension Entry/Exit Indicator Light ↔ page 99
	Air Suspension Off-Road 1 Indicator Light ↔ page 99
	Air Suspension Off-Road 2 Indicator Light ↔ page 99

Yellow Indicator Lights	
	Auto HOLD! Fault Indicator Light ↔ page 99
	Forward Collision Warning (FCW) Or Pedestrian Emergency Braking (PEB) OFF Indicator Light ↔ page 99
	Max Payload Exceeded Indicator Light ↔ page 99
	NEUTRAL Indicator Light ↔ page 99
	Sway Bar Indicator Light ↔ page 99

Green Indicator Lights	
	Active Driving Assist - Driver Attentive Indicator Light ↔ page 99
	Active Lane Management Indicator Light ↔ page 100
	Adaptive Cruise Control (ACC) Set With Target Indicator Light ↔ page 99
	Adaptive Cruise Control (ACC) Set With No Target Detected Indicator Light ↔ page 99
	Auto HOLD Indicator Light ↔ page 99
	Cruise Control SET Indicator Light ↔ page 100

Green Indicator Lights	
	Front Fog Indicator Light ⇨ page 100
	Night Vision Active Indicator Light ⇨ page 100
	Parking/Headlights On Indicator Light ⇨ page 100
	Rear Seat Belt Fastened Indicator Light ⇨ page 100
	Selec-Speed Control Indicator Light ⇨ page 101
	Sport Mode Indicator Light ⇨ page 100

Green Indicator Lights	
	Stop/Start Active Indicator Light ⇨ page 100
	Turn Signal/Hazard Indicator Lights ⇨ page 100

White Indicator Lights	
	Active Driving Assist On Indicator Light ⇨ page 100
	Adaptive Cruise Control (ACC) Ready Indicator Light ⇨ page 100
	Cruise Control Ready Indicator Light ⇨ page 100
	Hill Descent Control (HDC) Indicator Light ⇨ page 100

White Indicator Lights

Rear Seat Unoccupied Indicator Light
⇨ page 101

Blue Indicator Lights

High Beam Indicator Light
⇨ page 101

Gray Indicator Lights

Night Vision Suppressed Indicator Light
⇨ page 101

GETTING TO KNOW YOUR VEHICLE

KEYS

KEY FOB

Your vehicle is equipped with a key fob which supports Passive Entry, Remote Keyless Entry (RKE), Keyless Enter 'n Go™ (if equipped), Remote Start (if equipped), and remote power liftgate (if equipped) operation. The key fob allows you to lock or unlock all doors and liftgate, as well as activate the Panic Alarm from distances up to approximately 66 ft (20 m). The key fob does not need to be pointed at the vehicle to activate the system. The key fob also contains an emergency key, which is stored in the rear of the key fob.

NOTE:

In vehicles equipped with Remote Start, the key fob will operate at distances up to 328 ft (100 m).

NOTE:

- The key fob's wireless signal may be blocked if the key fob is located next to a mobile phone, laptop, or other electronic device. This may result in poor performance.
- If your vehicle is equipped with a Wireless Charging Pad, the key fob may not be detected if it is placed within 6 inches (15 cm) of the pad → page 70.
- With the ignition in the ON position and the vehicle moving at 2 mph (4 km/h), all RKE commands are disabled.

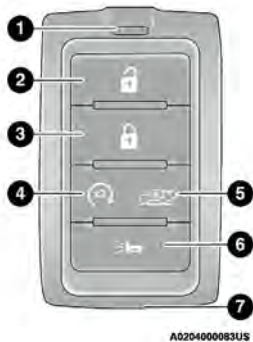

Key Fob

- 1 – LED Indicator
- 2 – Unlock
- 3 – Lock
- 4 – Remote Start
- 5 – Power Liftgate
- 6 – Panic
- 7 – Emergency Key

In case the ignition switch does not change positions with the push of a button, the key fob may have a low or fully depleted battery. A low key fob battery can be verified by referring to the instrument cluster, which will display directions to follow.

For more information on ignition positions, see → page 21.

NOTE:

A low key fob battery condition may be indicated by a message in the instrument cluster display, or by the LED light on the key fob. If the LED key fob light no longer illuminates after a key fob button is pushed, then the key fob battery requires replacement → page 331.

2

To Lock/Unlock The Doors And Liftgate

Push and release the unlock button on the key fob once to unlock the driver's door, or twice within five seconds to unlock all the doors and the liftgate. To lock all the doors and the liftgate, push the lock button once.

If enabled within the Uconnect system, the turn signals will flash and other illuminated entry features will be activated when the doors are unlocked. When the doors are locked, the turn signals will flash and the horn will chirp.

NOTE:

- If the vehicle is equipped with the Auto Relock feature, and is unlocked with the key fob, and no door is opened within 60 seconds, the vehicle will relock and the Vehicle Security system will arm (if equipped). This feature can be enabled/disabled within Uconnect Settings.
- If one or more doors are open, or the liftgate is open, the doors will lock. The doors will unlock again automatically if the key fob is left inside the passenger compartment, otherwise the doors will stay locked.

All doors can be programmed to unlock on the first push of the unlock button through Uconnect Settings → page 169.

Using The Panic Feature

To turn the Panic feature on or off, push the Panic button on the key fob. When the Panic feature is activated, the turn signals will flash, the horn may pulse on and off (if equipped with horn alarm), and the interior lights will turn on.

The Panic feature will stay on for three minutes unless you turn it off by either pushing the Panic button a second time or drive the vehicle at a speed of 15 mph (24 km/h) or greater.

NOTE:

- The interior lights will turn off if you place the ignition in the ON/RUN position while the Panic feature is activated. However, the exterior lights and horn (if equipped with horn alarm) will remain on.
- You may need to be closer than 66 ft (20 m) from the vehicle when using the key fob to turn off the Panic feature due to the radio frequency noises emitted by the system.

Key Left Vehicle Feature

If a valid key fob is no longer detected inside the vehicle while the vehicle's ignition system is in the ON/RUN or START position, the message "Key Fob Has Left The Vehicle" will be shown in the instrument cluster display along with an interior chime. An exterior audible and visual alert will also be activated to warn the driver.

The vehicle's horn will rapidly chirp three times along with a single flash of the vehicle's exterior lights.

NOTE:

- The doors have to be open and then closed in order for the vehicle to check for the presence of a key fob; the Key Left Vehicle feature will not activate until all of the doors are closed.
- These alerts will not be activated in situations where the vehicle's engine is left running with the key fob inside.

Using The Key Fob To Open Vehicle Windows — If Equipped

From outside of the vehicle, push and release the unlock button on the key fob, and within five seconds push and hold the unlock button for up to seven seconds. All vehicle door windows will open.

NOTE:

- This feature is enabled through Uconnect Settings  page 169.
- Vehicle must be equipped with front and rear auto up/down windows.

Replacing The Battery In The Key Fob

The replacement battery model is one CR2450 battery.

NOTE:

- Customers are recommended to use a battery obtained from Mopar®. Aftermarket coin battery specifications may not meet the original OEM coin battery specifications.
- Perchlorate Material — special handling may apply. See www.dtsc.ca.gov/hazardouswaste/perchlorate for further information.

- Do not touch the battery terminals that are on the back housing or the printed circuit board.
 - Do not replace the coin battery if the LED on the key fob above the top row buttons blinks when a button is pressed. The coin battery should last a minimum of three years with normal vehicle usage.
1. Remove the emergency key (2) by pushing the emergency key release button (1) on the side of the key fob, and pulling the emergency key out with the other hand.



A0204000060US

Emergency Key Removal

- 1 — Emergency Key Release Button
- 2 — Emergency Key



A0204000063US

Emergency Key Removed

2. Hold the key fob with the button side facing down, and locate the small rectangular gap on the left side between the housing and the back cover of the key fob. Use a small flat-bladed tool to pry apart the two halves of the key fob. Make sure not to damage the seal during removal.



A0204000061US

Pry Apart Key Fob Halves

3. Next, locate the gap on the right side of the key fob, which is positioned farther to the edge than the left side gap. Pry open the right side, and remove the back cover.
4. Remove the battery by using your thumb to slide the battery downward and back toward the key ring.

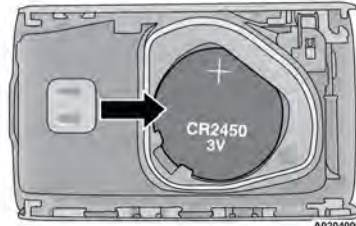

A0204000062US

Key Fob Battery Location

NOTE:

You can also insert a screwdriver or similar tool into the battery removal pocket to pry the battery out.

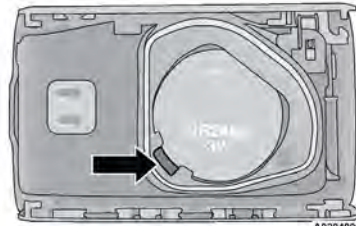

A0204000066US

Battery Removal Pocket

NOTE:

When replacing the battery, ensure the (+) sign on the battery is facing upward. Avoid touching the new battery with your fingers. Skin oils may cause battery deterioration. If you touch a battery, clean it with rubbing alcohol.

5. Replace the battery by using your thumb to push down and slide the battery under the small lip on the top edge of the opening.

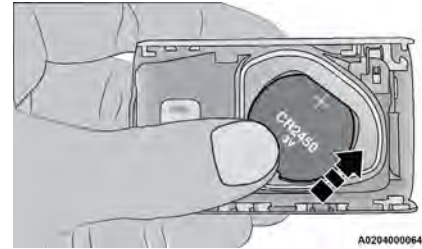

A0204000064US

Key Fob Battery Replacement

6. To assemble the key fob case, line up the top edge of the back cover with the top of the fob, and press the edges into the interlocking hinges until all edges snap together with no large visual gaps.
7. Reinsert the emergency key until it locks into place.

NOTE:

The key fob battery should only be replaced by qualified technicians. If the battery requires replacement, see an authorized dealer.

WARNING!

- The integrated key fob contains a coin cell battery. Do not ingest the battery; there is a chemical burn hazard. If the coin cell battery is swallowed, it can cause severe internal burns in just two hours and can lead to death.
- If you think a battery may have been swallowed or placed inside any part of the body, seek immediate medical attention.
- Keep new and used batteries away from children. If the battery compartment does not close securely, stop using the product and keep it away from children.

Programming And Requesting Additional Key Fobs

Programming the key fob may be performed by an authorized dealer.

NOTE:

- Once a key fob is programmed to a vehicle, it cannot be repurposed and reprogrammed to another vehicle.
- Only key fobs that are programmed to the vehicle electronics can be used to start and operate the vehicle. Once a key fob is programmed to a vehicle, it cannot be programmed to any other vehicle.

WARNING!

- Always remove the key fobs from the vehicle and lock all doors when leaving the vehicle unattended.
- Always remember to place the Keyless Enter 'n Go™ Ignition in the OFF position when exiting the vehicle.

Duplication of key fobs may be performed at an authorized dealer. This procedure consists of programming a blank key fob to the vehicle electronics. A blank key fob is one that has never been programmed.

NOTE:

- When having the Sentry Key Immobilizer system serviced, bring all vehicle keys with you to an authorized dealer.
- Keys must be ordered to the correct key cut to match the vehicle locks.

SENTRY KEY

The Sentry Key Immobilizer system prevents unauthorized vehicle operation by disabling the engine. The system does not need to be armed or activated. Operation is automatic, regardless of whether the vehicle is locked or unlocked.

The system uses a key fob, keyless push button ignition and a Radio Frequency (RF) receiver to prevent unauthorized vehicle operation. Therefore, only key fobs that are programmed to the vehicle can be used to start and operate the vehicle. The system cannot reprogram a key fob obtained from another vehicle.

After placing the ignition in the ON/RUN position, the Vehicle Security Light will turn on for three seconds for a bulb check. If the light remains on after the bulb check, it indicates that there is a problem with the electronics. In addition, if the light begins to flash after the bulb check, it indicates that someone attempted to start the engine with an invalid key fob. In the event that a valid key fob is used to start the engine but there is an issue with the vehicle electronics, the engine will start and shut off after two seconds.

If the Vehicle Security Light turns on during normal vehicle operation (vehicle running for longer than 10 seconds), it indicates that there is a fault in the electronics. Should this occur, have the vehicle serviced as soon as possible by an authorized dealer.

CAUTION!

The Sentry Key Immobilizer system is not compatible with some aftermarket Remote Start systems. Use of these systems may result in vehicle starting problems and loss of security protection.

All of the key fobs provided with your new vehicle have been programmed to the vehicle electronics
 page 331.

NOTE:

A key fob that has not been programmed is also considered an invalid key.

IGNITION SWITCH

KEYLESS ENTER 'N GO™ IGNITION

This feature allows the driver to operate the ignition switch with the push of a button as long as the key fob is in the passenger compartment.

The START/STOP ignition button has several operating modes that are labeled and will illuminate when in position. These modes are OFF, ON/RUN, and START.

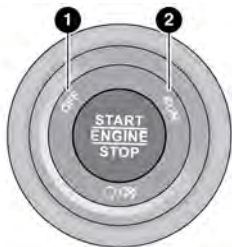

A0205000029US

START/STOP Ignition Button

- 1 — OFF
2 — ON/RUN

The push button ignition can be placed in the following modes:

OFF

- The engine is stopped
- Some electrical devices (e.g. power locks, alarm, etc.) are still available

ON/RUN

- Driving position
- All electrical devices are available (e.g. climate controls, heated seats, etc.)

START

- The engine will start (when foot is on the brake pedal)

NOTE:

- If the ignition position does not change with a push of the ignition button, and the instrument cluster displays a message such as "Key Fob Not Detected", the key fob may have a low or depleted battery. In this situation, a backup method can be used to operate the ignition switch. Put the nose side of the key fob (side opposite of the emergency key) against the START/STOP ignition button and push to operate the ignition switch.
- Replacement of the key fob battery is recommended.



A0205000016US

Depleted Key Fob Battery Procedure

WARNING!

- When exiting the vehicle, always place the ignition in the OFF position, remove the key fob from the vehicle, and lock your vehicle.
- Never leave children alone in a vehicle, or with access to an unlocked vehicle.
- Allowing children to be in a vehicle unattended is dangerous for a number of reasons. A child or others could be seriously or fatally injured. Children should be warned not to touch the parking brake, brake pedal or the gear selector.
- Do not leave the key fob in or near the vehicle, or in a location accessible to children, and do not leave Keyless Enter 'n Go™ Ignition in the ON/RUN position. A child could operate power windows, other controls, or move the vehicle.
- Do not leave children or animals inside parked vehicles in hot weather. Interior heat buildup may cause serious injury or death.

2

CAUTION!

An unlocked vehicle is an invitation for thieves. Always remove key fob from the vehicle and lock all doors when leaving the vehicle unattended.

NOTE:

- The key fob may not be detected by the vehicle Keyless Enter 'n Go™ system if it is located next to a mobile phone, laptop or other electronic device, or in the cupholders near aluminum cans; these devices may block the key fob's wireless signal and prevent the Keyless Enter 'n Go™ system from starting the vehicle.
- For more information on the engine starting procedure, see  page 103.
- When opening the driver's door and the ignition is in the ON/RUN position (engine not running), a chime will sound to remind you to place the ignition in the OFF position. In addition to the chime, the message "Ignition ON" will display in the cluster.

REMOTE START — IF EQUIPPED

This system uses the key fob to start the engine conveniently from outside the vehicle while still maintaining security. The system has a range of approximately 328 ft (100 m).

Remote Start is used to defrost windows in cold weather, and to reach a comfortable climate in all ambient conditions before the driver enters the vehicle.

NOTE:

Obstructions between the vehicle and key fob may reduce this range  page 331.

WARNING!

- Do not start or run an engine in a closed garage or confined area. Exhaust gas contains carbon monoxide which is odorless and colorless. Carbon monoxide is poisonous and can cause serious injury or death when inhaled.
- Keep key fobs away from children. Operation of the Remote Start system, windows, door locks or other controls could cause serious injury or death.

HOW TO USE REMOTE START

Push and release the Remote Start button on the key fob twice within five seconds. The vehicle doors will lock, the parking lights will flash, and the horn will chirp twice (if programmed). Then, the engine will start, and the vehicle will remain in the Remote Start mode for a 15 minute cycle. Pushing the Remote Start button a third time shuts the engine off.

NOTE:

- If the Remote Start button on the key fob is pushed too rapidly during activation, the vehicle may not start.
- With Remote Start, the engine will only run for 15 minutes.
- Remote Start can only be used twice.
- If an engine fault is present or fuel level is low, the vehicle will start and then shut down in 10 seconds.
- The parking lights will turn on and remain on during Remote Start mode.

- Headlight animation (if equipped) will occur when Remote Start is activated, if "Headlight Illumination On Approach" is enabled within Uconnect Settings.
- For security, power window and power sunroof operation (if equipped) are disabled when the vehicle is in the Remote Start mode.
- The ignition must be placed in the ON/RUN position before the Remote Start sequence can be repeated for a third cycle.

All of the following conditions must be met before the engine will remote start:

- Gear selector in PARK
- Doors closed
- Hood closed
- Liftgate closed
- Hazard switch off
- Brake switch inactive (brake pedal not pressed)
- Battery at an acceptable charge level
- System not disabled from previous Remote Start event
- Vehicle Security Light is flashing
- Ignition in OFF position
- Fuel level meets minimum requirement
- Vehicle Security system is not signaling an intrusion
- Malfunction Indicator Light is not illuminated

WARNING!

- Do not start or run an engine in a closed garage or confined area. Exhaust gas contains carbon monoxide (CO) which is odorless and colorless. Carbon monoxide is poisonous and can cause serious injury or death when inhaled.
- Keep key fobs away from children. Operation of the Remote Start system, windows, door locks or other controls could cause serious injury or death.

TO EXIT REMOTE START MODE

To drive the vehicle after starting the Remote Start system, either push and release the unlock button on the key fob to unlock the doors, or unlock the vehicle using Keyless Enter 'n Go™ — Passive Entry via the door handles, and disarm the Vehicle Security system (if equipped). Then, prior to the end of the 15 minute cycle, push and release the START/STOP ignition button.

The Remote Start system will turn the engine off if the Remote Start button on the key fob is pushed again, or if the engine is allowed to run for the entire 15 minute cycle. Once the ignition is placed in the ON/RUN position, the climate controls will resume the previously set operations (temperature, blower control, etc.).

NOTE:

- To avoid unintentional shutdowns, the system will disable for two seconds after receiving a valid Remote Start request.
- For vehicles equipped with the Keyless Enter 'n Go™ — Passive Entry feature, the message “Remote Start Active — Push Start Button” will display in the instrument cluster display until you push the START/STOP ignition button.

REMOTE START FRONT DEFROST ACTIVATION — IF EQUIPPED

When Remote Start is active, and the outside ambient temperature is 40°F (4.5°C) or below, the system will automatically activate front defrost for 15 minutes or less. The timing is dependent on the ambient temperature. Once the timer expires, the system will automatically adjust the settings depending on ambient conditions. See “Remote Start Comfort Systems — If Equipped” in the next section for detailed operation.

REMOTE START COMFORT SYSTEMS — IF EQUIPPED

When Remote Start is activated, the front and rear defrost will automatically turn on in cold weather. The heated steering wheel and driver heated seat feature will turn on if selected in the Comfort menu screen within Uconnect Settings ↪ page 169. In warm weather, the driver vented seat feature will automatically turn on when Remote Start is activated, if programmed in the Comfort menu screen. The vehicle will adjust the climate control settings depending on the outside ambient temperature.

Automatic Temperature Control (ATC)

The climate controls will automatically adjust to the optimal temperature and mode settings depending on the outside ambient temperature. This will occur until the ignition is placed in the ON/RUN position where the climate controls will resume their previous settings.

For more information on ATC and climate control settings, see ↪ page 57.

NOTE:

These features will stay on through the duration of Remote Start until the ignition is placed in the ON/RUN position. The climate control setting will change, and exit automatic operation, if manually adjusted by the driver while the vehicle is in Remote Start mode. This includes the OFF button on the climate controls, which will turn the system off.

REMOTE START WINDSHIELD WIPER DE-ICER ACTIVATION — IF EQUIPPED

When Remote Start is active and the outside ambient temperature is less than 33°F (0.6°C), the Windshield Wiper De-Icer will activate. Exiting Remote Start will resume its previous operation. If the Windshield Wiper De-Icer was active, the timer and operation will continue ↪ page 169.

REMOTE START ABORT MESSAGE

One of the following messages will display in the instrument cluster display if the vehicle fails to remote start or exits Remote Start prematurely:

- Remote Start Canceled — Door Open
- Remote Start Canceled — Hood Open
- Remote Start Canceled — Liftgate Open
- Remote Start Canceled — Fuel Low
- Remote Start Canceled — Time Expired
- Remote Start Canceled — System Fault
- Remote Start Disabled — Start Vehicle to Reset

The instrument cluster display message stays active until the ignition is placed in the ON/RUN position.

VEHICLE SECURITY SYSTEM — IF EQUIPPED

The Vehicle Security system monitors the vehicle doors, hood, liftgate, and the Keyless Enter 'n Go™ Ignition for unauthorized operation. While the Vehicle Security system is armed, interior switches for door locks and liftgate release handle are disabled. If something triggers the alarm, the Vehicle Security system will provide the following audible and visible signals:

- The horn will pulse
- The turn signals will flash
- The Vehicle Security Light in the instrument cluster will flash

TO ARM THE SYSTEM

Follow these steps to arm the Vehicle Security system:

1. If any doors, windows, or the sunroof are open, close them.
2. Make sure the vehicle's ignition is placed in the OFF position.
 - Make sure the vehicle's keyless ignition system is OFF.
3. Perform one of the following methods to lock the vehicle:
 - Push lock on the interior power door lock switch with the driver and/or passenger door open.
 - Push the lock button on the exterior Passive Entry door handle with a valid key fob available in the same exterior zone ↪ page 27.
 - Push the lock button on the key fob.

When the Vehicle Security system is armed, the Vehicle Security Light (located in the lower right portion of the instrument cluster display) will begin to flash every two seconds until it is disarmed.

NOTE:

If the system is armed by pushing the lock button on the interior door panel, the Vehicle Security Light will flash rapidly for about 15 seconds once the door is closed, then slow down to every two seconds.

TO DISARM THE SYSTEM

The Vehicle Security system can be disarmed using any of the following methods:

- Push the unlock button on the key fob.
- Grab the Passive Entry door handle to unlock the door ↪ page 27.
- Cycle the ignition out of the OFF position to disarm the system.

NOTE:

- The driver's door key cylinder cannot arm or disarm the Vehicle Security system. Use of the door key cylinder when the alarm is armed will sound the alarm when the door is opened.
- The Vehicle Security system remains armed when the power liftgate is opened using the liftgate button on the key fob. If someone enters the vehicle through the opened liftgate, then opens any door from the inside, the alarm will sound.
- If Passive Entry (if equipped) is used to unlock the liftgate, the Vehicle Security system is disarmed and the rest of the vehicle doors will remain locked unless all doors are set to unlock on first press within Uconnect Settings.

- When the Vehicle Security system is armed, the interior power door lock switches will not unlock the doors.

The Vehicle Security system is designed to protect your vehicle. However, you can create conditions where the system will give you a false alarm. If one of the previously described arming sequences has occurred, the Vehicle Security system will arm regardless of whether you are in the vehicle or not. If you remain in the vehicle and open a door, the alarm will sound. If this occurs, disarm the Vehicle Security system.

If the Vehicle Security system is armed and the battery becomes disconnected, the Vehicle Security system will remain armed when the battery is reconnected; the exterior lights will flash, and the horn will sound. If this occurs, disarm the Vehicle Security system.

REARMING OF THE SYSTEM

If something triggers the alarm and no action is taken to disarm it, the Vehicle Security system will turn the horn off after a 29 second cycle (with five seconds between cycles and up to eight cycles if the trigger remains active) and then rearm itself.

SECURITY SYSTEM MANUAL OVERRIDE

The Vehicle Security system will not arm if you lock the doors using the emergency lock lever ↪ page 26.

TAMPER ALERT

If something has triggered the Vehicle Security system in your absence, the horn will sound three times and the exterior lights will blink three times when you disarm the Vehicle Security system.

DELUXE VEHICLE SECURITY SYSTEM — IF EQUIPPED

The Deluxe Vehicle Security system monitors the doors, hood latch, and liftgate for unauthorized entry and the ignition switch for unauthorized operation. The system also includes a dual function intrusion sensor and vehicle tilt sensor. The intrusion sensor monitors the vehicle interior for motion. The vehicle tilt sensor monitors the vehicle for any tilting actions (tow away, tire removal, ferry transport, etc.).

If a perimeter violation triggers the security system, the horn will sound for 29 seconds, and the exterior lights will flash followed by approximately five seconds of no activity. This will continue for eight cycles if no action is taken to disarm the system.

TO ARM THE SYSTEM

Follow these steps to arm the security system:

1. If any doors, windows, or the sunroof (if equipped) are open, close them.
2. Make sure the vehicle ignition system is OFF.
3. Perform one of the following methods to lock the vehicle:
 - Push lock on the interior power door lock switch with the driver and/or passenger door open.
 - Push the lock button on the exterior Passive Entry door handle with a key fob available in the same exterior zone ↩ page 27.
 - Push the lock button on the key fob.

NOTE:

- When armed, the interior motion sensor detects movement within the vehicle's interior, including moving objects (i.e., people and pets) and air currents through open windows or the sunroof. The windows and sunroof should be closed, and moving objects should not be left in the vehicle when the intrusion detection is armed, otherwise false alarms can occur.
- Once the security system is armed, it remains in that state until you disarm it by following either of the disarming procedures described. If a power loss occurs after arming the system, you must disarm the system after restoring power to prevent alarm activation.
- The ultrasonic intrusion sensor (motion detector) actively monitors your vehicle every time you arm the Vehicle Security system. If you prefer, you can turn off the ultrasonic intrusion sensor when arming the Vehicle Security system. To do so, push the lock button on the key fob three times within 15 seconds of arming the system (while the Vehicle Security Light is flashing rapidly). The vehicle will remain locked but will disable the alarm in the case of repeated false alarms due to ambient conditions.

TO DISARM THE SYSTEM

The Vehicle Security system can be disarmed using any of the following methods:

- Push the unlock button on the key fob.
- Grab the Passive Entry door handle to unlock the door ↩ page 27.
- Cycle the vehicle ignition system out of the OFF position by pushing the START/STOP ignition button (requires at least one valid key fob in the vehicle).

NOTE:

- The driver's door key cylinder and the liftgate button on the key fob cannot arm or disarm the Vehicle Security system.
- The Vehicle Security system remains armed during power liftgate entry. Pushing the liftgate button will not disarm the Vehicle Security system. If someone enters the vehicle through the opened liftgate, then opens any door, the alarm will sound.
- When the Vehicle Security system is armed, the interior power door lock switches will not unlock the doors.
- The ultrasonic intrusion sensor (motion detector) actively monitors your vehicle every time you arm the Vehicle Security system. If you prefer, you can turn off the ultrasonic intrusion sensor when arming the Vehicle Security system. To do so, push the lock button on the key fob three times within 15 seconds of arming the system (while the Vehicle Security Light is flashing rapidly). The vehicle will remain locked but will disable the alarm in the case of repeated false alarms due to ambient conditions.

The Vehicle Security system is designed to protect your vehicle; however, you can create conditions where the system will give you a false alarm. If one of the previously described arming sequences has occurred, the Vehicle Security system will arm regardless of whether you are in the vehicle or not. If you remain in the vehicle and open a door, the alarm will sound. If this occurs, disarm the Vehicle Security system.

If the Vehicle Security system is armed and the battery becomes disconnected, the Vehicle Security system will remain armed when the battery is reconnected; the exterior lights will flash and the horn will sound. If this occurs, disarm the Vehicle Security system.

SECURITY SYSTEM MANUAL OVERRIDE

The Vehicle Security system will not arm if you lock the doors using the emergency lock lever → page 25.

DOORS

MANUAL DOOR LOCKS

The front doors can be manually unlocked with a single pull of the inside door handle. The driver's door can also be manually unlocked by inserting the emergency key into the lock cylinder on the outside door handle.

NOTE:

When using the emergency key to unlock the outside door handle, make sure the handle of the emergency key is pointing toward the rear of the vehicle. This will ensure the handle can be pulled all the way out while the key is in the lock cylinder.

The rear doors can be manually unlocked with a double pull of the inside door handle.

Each door can be manually locked by inserting the emergency key into the emergency lock lever and sliding the lever upward. The emergency lock lever is located on the door latch face of each door.

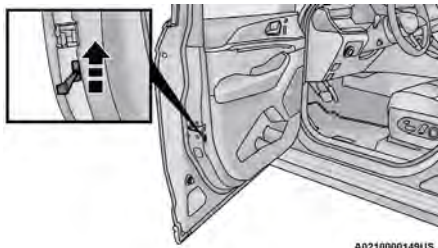

Emergency Lock Lever (Driver's Door Shown)

NOTE:

- The emergency lock lever is only accessible when the door is open.
- Manually locking the vehicle will not arm the Vehicle Security system.

WARNING!

- For personal security and safety in the event of a collision, lock the vehicle doors before you drive as well as when you park and leave the vehicle.
- When exiting the vehicle, always make sure the ignition is in the OFF position, remove the key fob from the vehicle and lock your vehicle.
- Never leave children alone in a vehicle, or with access to an unlocked vehicle. Allowing children to be in a vehicle unattended is dangerous for a number of reasons. A child or others could be seriously or fatally injured. Children should be warned not to touch the parking brake, brake pedal or the gear selector.

(Continued)

WARNING!

- Do not leave the key fob in or near the vehicle, or in a location accessible to children, and do not leave the Keyless Enter 'n Go™ Ignition in the ON/RUN position. A child could operate power windows, other controls, or move the vehicle.

POWER DOOR LOCKS

The power door lock buttons are located on each front door panel. Push the lock button to lock all doors and liftgate, or the unlock button to unlock all doors and liftgate.

When the doors are locked, an indicator light in the lock button will illuminate.

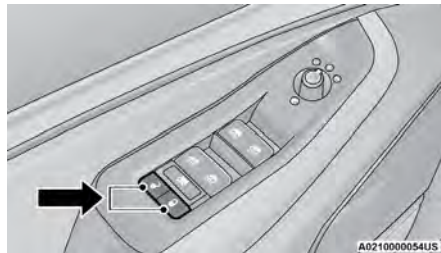

Power Door Lock Switches

The driver's door will unlock automatically if the key fob is detected inside the vehicle when the door lock button on the front door panel is used to lock the door, then the door is closed. The horn will also chirp to alert the driver. This will occur for two attempts. On the third attempt, the doors will lock even if the key fob is inside.

NOTE:

If the key fob is located next to a mobile phone, laptop, or other electronic device, the wireless signal may get blocked, and the driver's door may not unlock automatically.

If the door lock button is pushed while the ignition is in the ON/RUN position and the driver's door is open, the doors will not lock.

Rear Passenger Power Door Locks

Power door lock buttons are located on each rear door trim panel. Push the lock button to lock the rear door or push the unlock button to unlock the rear door.

**KEYLESS ENTER 'N GO™ —
PASSIVE ENTRY**

The Passive Entry system is an enhancement to the vehicle's Remote Keyless Entry (RKE) system and a feature of Keyless Enter 'n Go™. This feature allows you to lock and unlock the vehicle's door(s) without having to push the key fob lock or unlock buttons.

If equipped, the rear doors will also have Passive Entry capabilities.

NOTE:

- Passive Entry may be programmed on/off through Uconnect Settings → page 169.
- The key fob may not be detected by the vehicle Passive Entry system if it is located next to a mobile phone, laptop or other electronic device; these devices may block the key fob's wireless signal and prevent the Passive Entry handle from locking/unlocking the vehicle.

- Passive Entry unlock initiates illuminated approach (low beams, license plate lamp, parking lights, door handle pocket lights [if equipped]) for a preset duration of 0, 30, 60 or 90 seconds. Passive Entry unlock also initiates two flashes of the turn signal lights.
- If wearing gloves, if it has been raining/snowing, or there is salt/dirt covering the Passive Entry door handle, the unlock and lock sensitivity can be affected, resulting in a slower response time.
- The doors may lock and unlock when water is sprayed on the Passive Entry door handles, if the key fob is located outside of the vehicle within 5 ft (1.5 m) of the handle.
- Passive Entry lock initiates one horn chirp and one flash of turn signal lights. These settings can be programmed on/off within Uconnect Settings → page 169.
- If the vehicle is unlocked by Passive Entry and no door is opened within 60 seconds, the vehicle will relock and will rearm the Vehicle Security system (if equipped).

To Unlock From The Driver Or Passenger Side

With a valid Passive Entry key fob within 5 ft (1.5 m) of the door handle, grab the handle to unlock the vehicle. Grabbing the driver's door handle will unlock the driver door automatically. Grabbing the front passenger door handle (or a rear handle when equipped with four-door Passive Entry) will unlock all doors and the liftgate automatically.

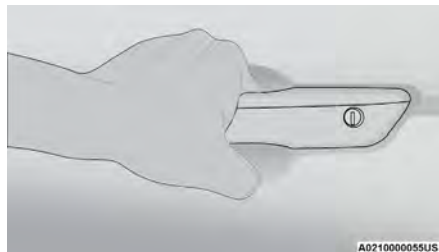
**Grab The Door Handle To Unlock****NOTE:**

- Either the driver door only or all doors will unlock when you grab hold of the front driver's door handle, depending on the selected setting in the Uconnect system → page 169.
- All doors will unlock when the front passenger (or a rear door when equipped with four-door Passive Entry) door handle is grabbed regardless of the driver's door unlock preference setting.

Frequency Operated Button Integrated Key (FOBIK-Safe)

To minimize the possibility of unintentionally locking a Passive Entry key fob inside your vehicle, the Passive Entry system is equipped with an automatic door unlock feature which will function if the ignition switch is in the OFF position.

There are five situations that trigger a FOBIK-Safe search in any Passive Entry vehicle:

- A lock request is made by a valid Passive Entry key fob while a door is open.
- A lock request is made by the Passive Entry door handle while a door is open.
- A lock request is made by the door panel switch while the door is open.
- When the Vehicle Security system is in pre-arm or armed status and the liftgate transitions from opened to closed.
- When the liftgate transitions from open to closed and Remote Start is active.

When any of these situations occur, after all open doors are shut, the FOBIK-Safe search will be executed. If it detects a Passive Entry key fob inside the vehicle, the vehicle will unlock and alert the customer.

NOTE:

The vehicle will only unlock the doors when a valid Passive Entry key fob is detected inside the vehicle. The vehicle will not unlock the doors when any of the following conditions are true:

- The doors are manually locked using the emergency lock lever.
- Three attempts are made to lock the doors using the door panel switch and then the doors are closed.
- There is a valid Passive Entry key fob outside the vehicle within 5 ft (1.5 m) of a Passive Entry door handle.

To Lock The Vehicle's Doors And Liftgate

With one of the vehicle's Passive Entry key fobs within 5 ft (1.5 m) of a Passive Entry door handle, touch the lock icon on the door handle to lock all four doors and liftgate.

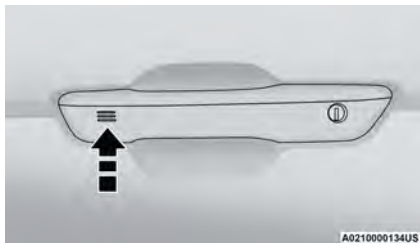

Touch The Door Handle Lock Icon To Lock

NOTE:

Do NOT grab the door handle when touching the lock icon. This could unlock the door(s).



Do NOT Grab The Door Handle When Locking

NOTE:

- After touching the door handle lock icon, you must wait two seconds before you can lock or unlock the doors using any Passive Entry door handle. This is done to allow you to check if the vehicle is locked by pulling the door handle, without the vehicle unlocking.
- If Passive Entry is disabled using the Uconnect Settings, the key fob protection described in "Frequency Operated Button Integrated Key (FOBIK-Safe)" remains active/functional.
- The Passive Entry system will not operate if the key fob battery is depleted.

To Unlock/Enter The Liftgate

The liftgate Passive Entry unlock feature is built into the electronic liftgate release button. With a valid Passive Entry key fob within 5 ft (1.5 m) of the liftgate, push the electronic liftgate release button for a power open on vehicles equipped with Power Liftgate. Pull the electronic liftgate handle and lift for Manual Liftgate vehicles.

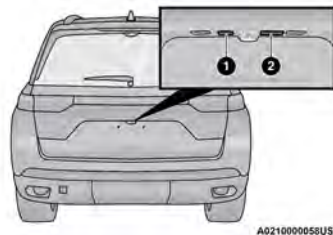

Electronic Liftgate Handle

- 1 — Passive Entry Lock Button
2 — Electronic Liftgate Release Button

To Lock The Liftgate

With a valid Passive Entry key fob within 5 ft (1.5 m) of the liftgate, push the Passive Entry lock button located on the outside liftgate door handle.

NOTE:

The liftgate Passive Entry lock button will lock all doors and the liftgate ↪ page 331.

AUTOMATIC UNLOCK DOORS ON EXIT

The doors will unlock automatically on vehicles with power door locks after the following sequence of actions:

1. The Automatic Unlock Doors On Exit feature is enabled within Uconnect Settings ↪ page 169.
2. All doors are closed.
3. The gear selector was not in PARK, then is placed in PARK.
4. Any door is opened.

AUTOMATIC DOOR LOCKS — IF EQUIPPED

The auto door lock feature default condition is enabled. When enabled, the door locks will lock automatically when the vehicle speed exceeds 15 mph (24 km/h). The auto door lock feature is enabled or disabled by an authorized dealer per written request of the customer. Please see an authorized dealer for service.

CHILD-PROTECTION DOOR LOCK SYSTEM — REAR DOORS

To provide a safer environment for small children riding in the rear seats, the rear doors are equipped with a Child-Protection Door Lock system.

To use the system, open each rear door, use a flat-blade screwdriver (or emergency key) and rotate the dial to the lock or unlock position. When the system on a door is engaged, that door can only be opened by using the outside door handle even if the inside door lock is in the unlocked position.

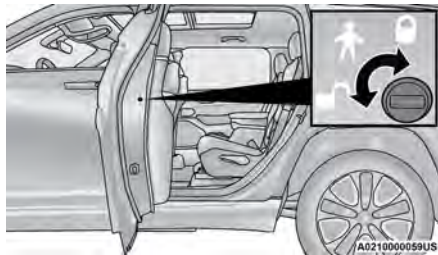

Child-Protection Door Lock Function

NOTE:

- When the Child-Protection Door Lock system is engaged, the door can be opened only by using the outside door handle even though the inside door lock is in the unlocked position.
- After disengaging the Child-Protection Door Lock system, always test the door from the inside to make certain it is in the unlocked position.

- After engaging the Child-Protection Door Lock system, always test the door from the inside to make certain it is in the locked position.

WARNING!

Avoid trapping anyone in a vehicle in a collision. Remember that the rear doors can only be opened from the outside with the Child-Protection locks engaged (locked).

2

NOTE:

Always use this device when carrying children. After engaging the child lock on both rear doors, check for effective engagement by trying to open a door with the internal handle. Once the Child-Protection Door Lock system is engaged, it is impossible to open the doors from inside the vehicle. Before getting out of the vehicle, be sure to check that there is no one left inside.

STEERING WHEEL

MANUAL TILT/TELESCOPING STEERING COLUMN — IF EQUIPPED

This feature allows you to tilt the steering column upward or downward. It also allows you to lengthen or shorten the steering column. The tilt/telescoping lever is located below the steering wheel at the end of the steering column.

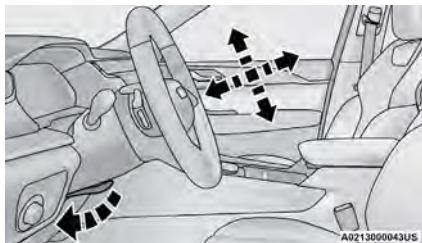

Manual Tilt/Telescoping Steering Column Handle

To unlock the steering column, push the lever downward (toward the floor). To tilt the steering column, move the steering wheel upward or downward as desired. To lengthen or shorten the steering column, pull the steering wheel outward or push it inward as desired. To lock the steering column in position, push the lever upward until fully engaged.

WARNING!

Do not adjust the steering column while driving. Adjusting the steering column while driving or driving with the steering column unlocked, could cause the driver to lose control of the vehicle. Failure to follow this warning may result in serious injury or death.

WARNING!

Do not adjust the steering column while driving. Adjusting the steering column while driving or driving with the steering column unlocked, could cause the driver to lose control of the vehicle. Failure to follow this warning may result in serious injury or death.

POWER TILT/TELESCOPING STEERING COLUMN — IF EQUIPPED

This feature allows you to tilt the steering column upward or downward. It also allows you to lengthen or shorten the steering column. The power tilt/telescoping steering column control is located below the multifunction lever on the steering column.

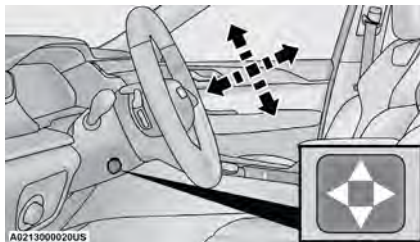

Power Tilt/Telescoping Steering Control Location

Use the four-way control to adjust the steering column.

NOTE:

For vehicles equipped with Driver Memory Settings, use the key fob or the memory switch on the driver's door trim panel to return the tilt/telescoping steering column to saved positions ↩ page 31.

HEATED STEERING WHEEL — IF EQUIPPED



The steering wheel contains a heating element that helps warm your hands in cold weather. The heated steering wheel has only one temperature setting. Once the heated steering wheel has been turned on, it will stay on until the operator turns it off. The heated steering wheel may not turn on when it is already warm.

The heated steering wheel button is located on the center of the instrument panel below the radio screen, and within the Comfort screen of the touchscreen.

- Press the heated steering wheel button once to turn the heating element on.
- Press the heated steering wheel button a second time to turn the heating element off.

NOTE:

The engine must be running for the heated steering wheel to operate.

For information on use with the Remote Start system, see ↩ page 23.

WARNING!

- Persons who are unable to feel pain to the skin because of advanced age, chronic illness, diabetes, spinal cord injury, medication, alcohol use, exhaustion, or other physical conditions must exercise care when using the steering wheel heater. It may cause burns even at low temperatures, especially if used for long periods.
- Do not place anything on the steering wheel that insulates against heat, such as a blanket or steering wheel covers of any type and material. This may cause the steering wheel heater to overheat.

UNCONNECT VOICE RECOGNITION QUICK TIPS — IF EQUIPPED

INTRODUCING VOICE RECOGNITION

Start using Uconnect Voice Recognition with these helpful quick tips. These key Voice Commands and tips will help you control your vehicle's Voice Recognition (VR) system.

BASIC VOICE COMMANDS



The following basic Voice Commands can be given at any point while using your Uconnect system.

Push the VR button on the steering wheel or say the vehicle's Wake Up word, "Hey Uconnect" or "Hey Jeep®". The factory default Wake Up word is set to "Hey Uconnect" and can be reprogrammed through the Uconnect Settings. After the beep, say:

- " **Cancel**" to stop a current voice session.
- " **Help**" to hear a list of suggested Voice Commands.
- " **Repeat**" to listen to the system prompts again.



Notice the visual cues that inform you of your Voice Recognition system's status.

GET STARTED

The VR button  is used to activate/deactivate your Voice Recognition system. You can also use the system's "Wake Up" word to activate voice recognition. The "Wake Up" word can be set through the Uconnect Settings  page 169.

Helpful hints for using Voice Recognition:

- Reduce background noise. Wind noise and passenger conversations are examples of noise that may impact recognition.

- Speak clearly at a normal pace and volume while facing straight ahead.
- Each time you give a Voice Command, first push the VR button  or say the "Wake Up" word, wait until after the beep, then say your Voice Command.
- You can interrupt the help message or system prompts by pushing the VR button and saying a Voice Command from the current category.
- You can also interrupt the help message or system prompts by speaking. This feature is called "bargain-in" and can be set through the Uconnect Settings  page 169.

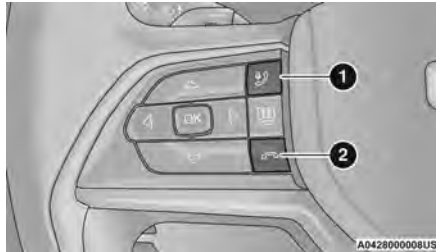

Uconnect Voice Command Buttons

1 — For Vehicles Equipped With Navigation: Push The Voice Recognition Button To Begin Radio, Media, Navigation, Climate, Start Or Answer A Phone Call, And Send Or Receive A Text

1 — For Vehicles Not Equipped With Navigation: Push The Phone Button To Answer An Incoming Phone Call
2 — Push The Hang Up Button To End A Call Currently In Progress

ADDITIONAL INFORMATION

© 2023 FCA US LLC. All rights reserved. Mopar and Uconnect are registered trademarks and Mopar Owner Connect is a trademark of FCA US LLC. SiriusXM® and all related marks and logos are trademarks of SiriusXM® Radio Inc.  page 331.

For Uconnect system support, call 1-877-855-8400 (24 hours a day 7 days a week) or visit DriveUconnect.com (US) or DriveUconnect.ca (Canada).

DRIVER AND PASSENGER MEMORY SETTINGS — IF EQUIPPED

This feature allows the driver, and if equipped, also the front passenger to save up to two different memory profiles for easy recall through a memory switch. Each memory profile saves desired position settings for the following features:

Driver's Side

- Seat position
- Easy Entry/Exit seat (if equipped)
- Side mirrors
- Power tilt and telescopic steering column (if equipped)
- A set of desired radio station presets

Passenger's Side (If Equipped)

- Seat Position

The memory settings switches are located on the front door panels, next to the door handle, and consists of three buttons:

- The set (S) button, which is used to activate the memory save function.
- The (1) and (2) buttons which are used to recall either of two saved memory profiles.

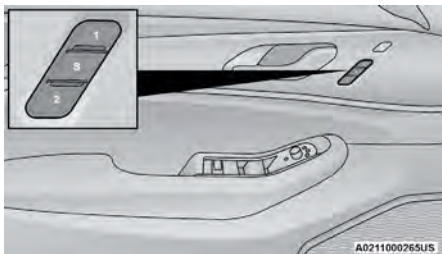

Memory Setting Buttons

NOTE:

- Your vehicle is equipped with two key fobs, each can be linked to either driver's side memory position 1 or 2.
- Front passenger memory settings cannot be linked to a key fob.

PROGRAMMING THE MEMORY FEATURE

To create a new memory profile, perform the following:

NOTE:

Saving a new memory profile will erase the selected profile from memory.

1. Place the vehicle's ignition in the ON/RUN position (do not start the engine).
2. Adjust all memory profile settings to desired preferences (i.e., seat, side mirror, power tilt/telescopic steering column [if equipped], and radio station presets).
3. Push and release the set (S) button on the memory switch.
4. Within five seconds, push and release either of the memory buttons (1) or (2). The instrument cluster display will indicate which memory position has been set.

NOTE:

Memory profiles can be set without the vehicle in PARK, but the vehicle must be below 5 mph (8 km/h) to recall a memory profile.

LINKING AND UNLINKING THE KEY FOB TO MEMORY

Your key fobs can be programmed to recall one of two saved driver's side memory profiles.

NOTE:

Before programming your key fobs you must select the "Personal Settings Linked To Key Fob" feature through the Uconnect Settings  page 169.

To program your key fobs, perform the following:

1. Place the vehicle's ignition in the OFF position.
2. Select a desired driver's side memory profile, 1 or 2.
3. Once the profile has been recalled, push and release the set (S) button on the memory switch.
4. Within five seconds, push and release button (1) or (2) accordingly. "Memory Profile Set" (1 or 2) will display in the instrument cluster.
5. Push and release the lock button on the key fob within 10 seconds.

NOTE:

Your key fobs can be unlinked from your driver's side memory settings by pushing the set (S) button, and within 10 seconds, pushing the unlock button on the key fob.

MEMORY POSITION RECALL

NOTE:

Memory Recall is available when not in PARK, if the vehicle speed is below 5 mph (8 km/h).

- To recall a memory settings profile using the memory switches, push memory button (1) or (2) on the memory switch.
- To recall the driver's side memory settings using the key fob, push the unlock button on the key fob linked to memory position 1 or 2.

A recall can be canceled by pushing any of the memory buttons during a recall (S, 1, or 2), or by pushing any of the seat adjustment switches. When a recall is canceled, the seat and power tilt/telescopic steering column (if equipped) will stop moving. A delay of one second will occur before another recall can be selected.

SEATS

Seats are a part of the Occupant Restraint system of the vehicle.

WARNING!

- It is dangerous to ride in a cargo area, inside or outside of a vehicle. In a collision, people riding in these areas are more likely to be seriously injured or killed.
- Do not allow people to ride in any area of your vehicle that is not equipped with seats and seat belts. In a collision, people riding in these areas are more likely to be seriously injured or killed.
- Be sure everyone in your vehicle is in a seat and using a seat belt properly.

MANUAL ADJUSTMENT FRONT SEATS — IF EQUIPPED

WARNING!

- Adjusting a seat while the vehicle is moving is dangerous. The sudden movement of the seat could cause you to lose control. The seat belt might not be adjusted properly and you could be injured. Adjust the seat only while the vehicle is parked.
- Do not ride with the seatback reclined so that the shoulder belt is no longer resting against your chest. In a collision you could slide under the seat belt and be seriously or even fatally injured. Use the recliner only when the vehicle is parked.

Manual Front Passenger Seat Forward/Rearward Adjustment

Some models may be equipped with a manual front passenger seat. The passenger seat can be adjusted forward or rearward by using a bar located by the front of the seat cushion, near the floor.

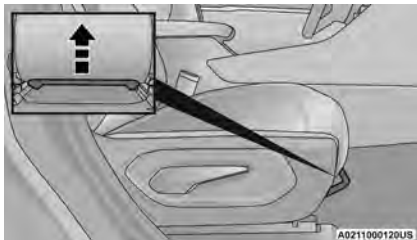

Adjustment Bar

While sitting in the seat, lift up on the bar located under the seat cushion and move the seat forward or rearward. Release the bar once you have reached the desired position. Then, using body pressure, move forward and rearward on the seat to be sure that the seat adjusters have latched.

WARNING!

- Adjusting a seat while driving may be dangerous. Moving a seat while driving could result in loss of control which could cause a collision and serious injury or death.
- Seats should be adjusted before fastening the seat belts and while the vehicle is parked. Serious injury or death could result from a poorly adjusted seat belt.

Manual Front Passenger Seatback Adjustment — Recline

To recline, lean forward slightly and lift the lever located on the outboard side of the seat. Then, push the seat rearward to the desired position and release the lever. To return the seatback to its normal position, lean forward and lift the lever. To ensure the seatback is latched, use body pressure to lean forward and rearward.

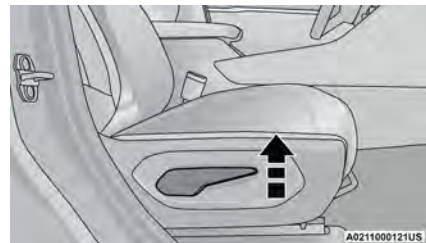

Recline Lever

WARNING!

Do not ride with the seatback reclined so that the shoulder belt is no longer resting against your chest. In a collision you could slide under the seat belt, which could result in serious injury or death.

MANUAL ADJUSTMENT REAR SEATS

Vehicles equipped with third row seating may have a second row bench seat, or second row captain's chairs. Vehicles equipped with only second row seating, will have a second row bench seat.

WARNING!

Do not pile luggage or cargo higher than the top of the seatback. This could impair visibility or become a dangerous projectile in a sudden stop or collision.

NOTE:

You may experience deformation in the seat cushion from the seat belt buckles if the seats are left folded for an extended period of time. This is normal and by simply unfolding the seats to the open position, over time the seat cushion will return to its normal shape.

Second Row Bench Seat — If Equipped

SECOND ROW BENCH SEAT FORWARD/REARWARD ADJUSTMENT — IF EQUIPPED

Lift up on the adjusting bar located at the front of the seat near the floor and release it when the seat is at the desired position. Then, using body pressure, move forward and rearward on the seat to be sure that the seat adjusters have latched.



Rear Seat Adjustment Bar

SECOND ROW BENCH SEAT RECLINE ADJUSTMENT

To recline, lean forward slightly and lift the lever located on the outboard side of the seat. Then, push the seat rearward to the desired position and release the lever. To return the seatback to its normal position, lean forward and lift the lever. To ensure the seatback is latched, use body pressure to lean forward and rearward.



Rear Seat Recline Lever

WARNING!

Do not ride with the seatback reclined so that the shoulder belt is no longer resting against your chest. In a collision you could slide under the seat belt, which could result in serious injury or death.

SECOND ROW BENCH FOLD FLAT SEAT

To provide additional storage area, each rear seat can be folded flat. This allows for extended cargo space and still maintains some rear seating room.

NOTE:

Prior to folding the rear seat, it may be necessary to position the front seat to its mid-track position. Also, be sure that the front seats are fully upright and positioned forward. This will allow the rear seat to fold down easily.

To lower the seatback, pull upward on the recline lever located on the outboard side of the seat, and let the seatback fold forward automatically.



Second Row Bench Seat Folded Flat

To raise the seatback, fold the seatback up into its original position and lock it into place.

WARNING!

Be certain that the seatback is securely locked into position. If the seatback is not securely locked into position the seat will not provide the proper stability for child seats and/or passengers. An improperly latched seat could cause serious injury.

SECOND ROW BENCH SEAT EASY ACCESS FOR THIRD ROW — IF EQUIPPED

If the vehicle is equipped with third row seating, the second row seats can tip forward to allow passengers to easily access the third row seats.

Pull upward on the easy entry lever located on the outboard side of the seatback, then tip and slide the entire seat forward.



Easy Entry Lever Location



Access To Third Row Seats

To return the seat to a sitting position, unfold the seatback upright until it locks and push the seat rearward until the track locks.

Second Row Captain's Chairs — If Equipped

Vehicles equipped with third row seating may be equipped with second row captain's chairs.

SECOND ROW CAPTAIN'S CHAIRS FORWARD/REARWARD ADJUSTMENT

Lift up on the adjusting bar located at the front of the seat near the floor and release it when the seat is at the desired position. Then, using body pressure, move forward and rearward on the seat to be sure that the seat adjusters have latched.

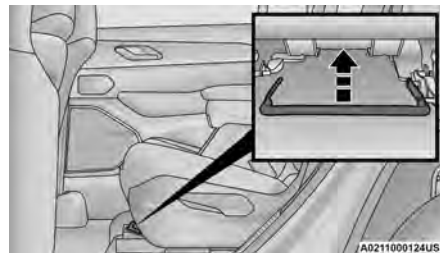

Rear Seat Adjustment Bar

SECOND ROW CAPTAIN'S CHAIRS RECLINE ADJUSTMENT

To recline, lean forward slightly and lift the lever located on the outboard side of the seat. Then, push the seat rearward to the desired position and release the lever. To return the seatback to its normal position, lean forward and lift the lever. To ensure the seatback is latched, use body pressure to lean forward and rearward.

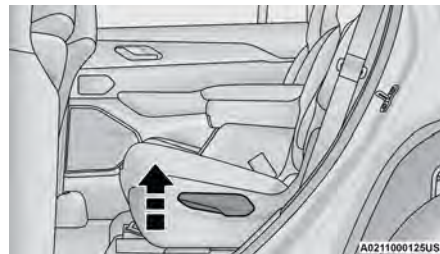

Rear Seat Recline Lever

WARNING!

Do not ride with the seatback reclined so that the shoulder belt is no longer resting against your chest. In a collision you could slide under the seat belt, which could result in serious injury or death.

SECOND ROW CAPTAIN'S CHAIRS FOLD FLAT SEATS

The second row seatbacks can be folded flat to carry cargo.

Pull upward on the recline lever located on the outboard side of each second row seat, and guide the seatback down into the folded position.



Second Row Captain's Chairs Folded Flat

To Raise The Rear Seats

Fold the seatbacks upward to their original position, and lock them into place.

WARNING!

Be certain that the seatback is securely locked into position. If the seatback is not securely locked into position the seat will not provide the proper stability for child seats and/or passengers. An improperly latched seat could cause serious injury.

SECOND ROW CAPTAIN'S CHAIR EASY ACCESS FOR THIRD ROW

The second row seats can tip forward to allow passengers to easily access the third row seats.

Pull upward on the easy entry lever located on the outboard side of the seatback, then tip and slide the entire seat forward.



Easy Entry Lever Location



Access To Third Row Seats

To return the seat to a sitting position, unfold the seatback upright until it locks and push the seat rearward until the track locks.

Manual Folding Third Row — If Equipped

Both third row seats can be folded forward to increase the cargo area. To lower either seat, pull on the release handle located on the back of the seat and lower the seat using the pull strap located next to the release handle.

NOTE:

The second row seats must be in their full upright position or folded flat when folding the third row seats.

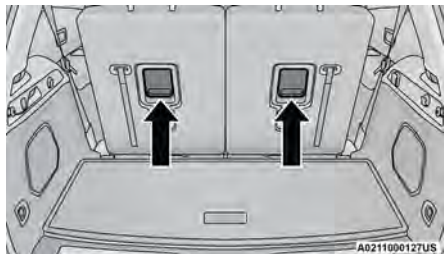
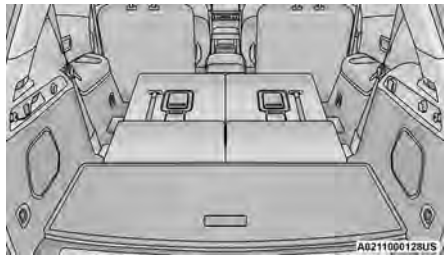
**Release Handles****Third Row Folded**

To raise the seat, pull the seat toward you using the strap located on the back of the seat.

WARNING!

Be certain that the seatback is securely locked into position. If the seatback is not securely locked into position the seat will not provide the proper stability for child seats and/or passengers. An improperly latched seat could cause serious injury.

POWER ADJUSTMENT FRONT SEATS — IF EQUIPPED

Some models may be equipped with 12-way power driver and front passenger seats. The power seat switches are located on the outboard side of the seat. There are three switches that control the movement of the seat cushion and the seatback.

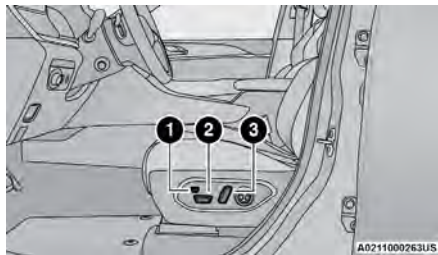
**Power Seat Switches**

- 1 — Cushion Extender Switch (If Equipped)
- 2 — Seat Switch
- 3 — Seatback And Bolster Adjustment Switch

Adjusting The Seat Forward Or Rearward

The seat can be adjusted both forward and rearward. Push the seat switch forward or rearward. The seat will move in the direction of the switch. Release the switch when the desired position has been reached.

Adjusting The Seat Up Or Down

The height of the seats can be adjusted up or down. Pull upward or push downward on the rear of seat switch, the seat will move in the direction of the switch. Release the switch when the desired position has been reached.

Tilting The Seat Up Or Down

The angle of the seat cushion can be adjusted in two directions. Pull upward or push downward on the front of the seat switch, the front of the seat cushion will move in the direction of the switch. Release the switch when the desired position has been reached.

Reclining The Seatback

The angle of the seatback can be adjusted forward or rearward. Push the seatback switch forward or rearward, the seat will move in the direction of the switch. Release the switch when the desired position is reached.

WARNING!

- Adjusting a seat while driving may be dangerous. Moving a seat while driving could result in loss of control which could cause a collision and serious injury or death.
- Seats should be adjusted before fastening the seat belts and while the vehicle is parked. Serious injury or death could result from a poorly adjusted seat belt.
- Do not ride with the seatback reclined so that the shoulder belt is no longer resting against your chest. In a collision you could slide under the seat belt, which could result in serious injury or death.

CAUTION!

Do not place any article under a power seat or impede its ability to move as it may cause damage to the seat controls. Seat travel may become limited if movement is stopped by an obstruction in the seat's path.

Seatback Bolster Adjustment — If Equipped

The front driver and passenger seatback bolsters can be extended outward, or retracted inward by pushing the bolster adjustment button located in the center of the seatback switch.

Push the top of the button to extend the bolsters, or push the bottom of the button to retract the bolsters.

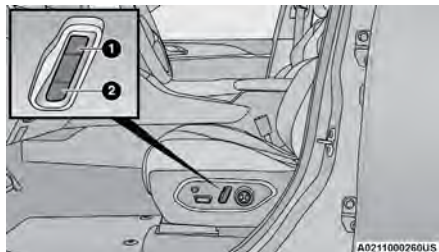

Seatback Bolster Adjustment Button

- 1 — Extend Seatback Bolsters
2 — Retract Seatback Bolsters

Cushion Extender

The cushion can be extended forward a few inches (centimeters) to increase thigh support. Push the cushion extender switch forward or rearward to extend or retract the cushion. Release the switch when the desired position has been reached.

Power Lumbar — If Equipped

Vehicles equipped with power driver or passenger seats may also be equipped with power lumbar. The power lumbar switch is located on the outboard side of the power seat. Push the switch forward to increase the lumbar support. Push the switch rearward to decrease the lumbar support. Pushing upward or downward on the switch will raise and lower the position of the support.

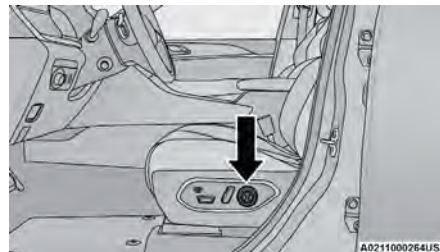

Power Lumbar Switch

Easy Entry/Exit Seat — If Equipped

This feature provides automatic driver seat positioning to enhance driver mobility when entering and exiting the vehicle.

The distance the driver seat moves depends on where you have the driver seat positioned when you place the vehicle's ignition in the OFF position.

- When you place the vehicle's ignition in the OFF position, the driver seat will move about 2.4 inches (6 cm) rearward if the driver seat position is greater than or equal to 2.7 inches (6.8 cm) forward of the rear stop. The seat will return to its previously set position when you place the vehicle's ignition in the ON/RUN position.
- The Easy Entry/Easy Exit feature is disabled when the driver seat position is less than 0.9 of an inch (2.3 cm) forward of the rear stop. At this position, there is no benefit to the driver by moving the seat for Easy Exit or Easy Entry.

When enabled in Uconnect Settings, Easy Entry and Easy Exit positions are stored in each memory setting profile ↪ page 31.

NOTE:

The Easy Entry/Exit feature is enabled or disabled within the Uconnect system ↪ page 169.

POWER ADJUSTMENT REAR SEATS — IF EQUIPPED

WARNING!

- Adjusting a seat while driving may be dangerous. Moving a seat while driving could result in loss of control which could cause a collision and serious injury or death.
- Seats should be adjusted before fastening the seat belts and while the vehicle is parked. Serious injury or death could result from a poorly adjusted seat belt.
- Do not ride with the seatback reclined so that the shoulder belt is no longer resting against your chest. In a collision you could slide under the seat belt, which could result in serious injury or death.
- Do not place the seat belt webbing behind the third row stow clip when using the seat belt to restrain an occupant. The seat belt will not be positioned properly on the occupant and they could be more seriously injured in an accident as a result.

CAUTION!

Do not place any article under a power seat or impede its ability to move as it may cause damage to the seat controls. Seat travel may become limited if movement is stopped by an obstruction in the seat's path.

Rear Seat Power Folding Seatbacks — If Equipped

If the vehicle is equipped with third row seating, the second and third rows may be equipped with power folding seatbacks.

A one-touch power folding seat switch is located in the right rear trim panel inside the cargo area, as part of a switch bank.

NOTE:

- You may need to move the front seats forward to allow the second row seats to fold properly, as they may bump into the Rear Seat Entertainment touchscreens (if equipped).
- The third row seat belts may interfere with the power folding of the seat. Place the seat belt webbing behind the stow clip before stowing or opening the seat. When the seat is in the desired position, remove the webbing from the stow clip so that it is ready for use. Never leave the seat belt in the stow clip when it is used to restrain an occupant.
- The head restraints will lower automatically as necessary when the power seat begins to move when the vehicle is in PARK, and a rear door or the liftgate is open.

The rear switch bank allows multiple power folding positions for the second and third row seats. The second row seats can be folded using these switches, while the third row can be folded or unfolded.

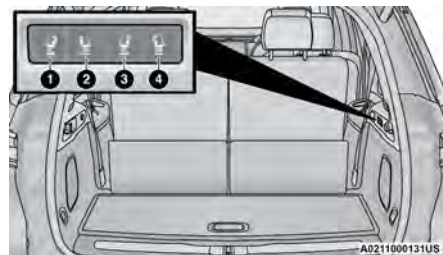

Rear Panel Power Switch Bank

- 1 — Second Row Left Side Fold
- 2 — Second Row Right Side Fold
- 3 — Third Row Left Side Fold/Unfold
- 4 — Third Row Right Side Fold/Unfold

There are also power folding switches for the third row seats located on the C-pillar (just behind the rear doors on the trim panels).



C-Pillar Power Folding Switches (Left Side Shown)

- 1 – Third Row Left Side Fold/Unfold
2 – Third Row Right Side Fold/Unfold

POWER SEATBACK MASSAGE — IF EQUIPPED

The driver's and front passenger's seatbacks may be equipped with power massage.

The massage feature can be turned on/off through the massage button located on the door panel near the handle, or through the Comfort screen on the radio.

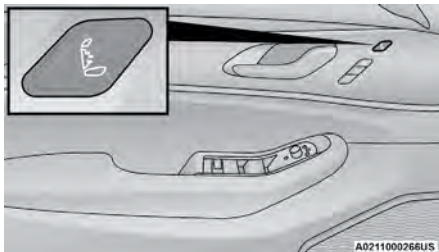

Door Panel Massage Button

Once activated by either method, the massage controls will display on the radio screen, and "Massage Type" and "Intensity Level" can be selected for the activated seat.

There are four intensity levels and five massage types that can be selected.

Intensity Levels:

- High
- Med
- Low
- Off

Massage Types:

- Waterfall
- Lower Back
- Extend
- Low Extend
- Rock Climb

The selected settings will save in the system's memory when turned off, and will resume the next time the system is turned on.

NOTE:

- The engine must be running for the power seatback massage to operate.
- The massage feature will turn off after 20 minutes of use. However, if the massage type or intensity level is changed, the timer then resets.

HEATED SEATS — IF EQUIPPED

WARNING!

- Persons who are unable to feel pain to the skin because of advanced age, chronic illness, diabetes, spinal cord injury, medication, alcohol use, exhaustion or other physical condition must exercise care when using the seat heater. It may cause burns even at low temperatures, especially if used for long periods of time.
- Do not place anything on the seat or seatback that insulates against heat, such as a blanket or cushion. This may cause the seat heater to overheat. Sitting in a seat that has been overheated could cause serious burns due to the increased surface temperature of the seat.

Front Heated Seats



The front heated seats control buttons are located on the center stack below the radio screen or within the Uconnect system. You can gain access to the control buttons through the Comfort screen.

- Press the heated seat switch once to turn the HI setting on.
- Press the heated seat switch a second time to turn the MED setting on.
- Press the heated seat switch a third time to turn the LO setting on.
- Press the heated seat switch a fourth time to turn the heating elements off.

NOTE:

- Once a heat setting is selected, heat will be felt within two to five minutes.
- The engine must be running for the heated seats to operate.
- The level of heat selected will stay on until the operator changes it.

For information on use with the Remote Start system, see [page 23](#).

Rear Heated Seats — If Equipped



The two second row outboard seats may be equipped with heated seats. There are two heated seat switches that allow the rear passengers to operate the seats independently. The heated seat switches for each heater are located on the rear of the center console.

You can choose from HI, MED, LO, or OFF heat settings. Indicator lights in each switch illuminate indicating the level of heat in use.

- Push the heated seat switch once to turn the HI setting on.
- Push the heated seat switch a second time to turn the MED setting on.
- Push the heated seat switch a third time to turn the LO setting on.
- Push the heated seat switch a fourth time to turn the heating elements off.

The level of heat selected will stay on until the operator changes it.

NOTE:

The engine must be running for the heated seats to operate.

VENTILATED SEATS — IF EQUIPPED

Located in the seat cushion and seatback are fans that draw the air from the passenger compartment and move air through fine perforations in the seat cover to help keep the occupant cooler in higher ambient temperatures.

Front Ventilated Seats



The ventilated seats control buttons are located on the center stack below the radio screen or within the Uconnect system. The fans operate at three speeds: HI, MED and LO.

- Press the ventilated seat switch once to choose HI.
- Press the ventilated seat switch a second time to choose MED.

- Press the ventilated seat switch a third time to choose LO.
- Press the ventilated seat switch a fourth time to turn the ventilation off.

NOTE:

The engine must be running for the ventilated seats to operate.

For information on use with the Remote Start system, see [page 23](#).

Rear Ventilated Seats — If Equipped



The two second row outboard seats may be equipped with ventilated seats. The rear ventilated seat control switches are located on the rear of the center console and allow the rear passengers to operate the seats independently. The fans operate at three speeds: HI, MED, and LO. Push the ventilated seat switches to toggle through the speeds, or to turn the feature off.

There are two ventilated seat switches

- Push the ventilated seat switch once to choose HI.
- Push the ventilated seat switch a second time to choose MED.
- Push the ventilated seat switch a third time to choose LO.
- Push the ventilated seat switch a fourth time to turn the ventilation off.

NOTE:

The engine must be running for the ventilated seats to operate.

HEAD RESTRAINTS

Head restraints are designed to reduce the risk of injury by restricting head movement in the event of a rear impact. Head restraints should be adjusted so that the top of the head restraint is located above the top of your ear.

WARNING!

- All occupants, including the driver, should not operate a vehicle or sit in a vehicle's seat until the head restraints are placed in their proper positions in order to minimize the risk of neck injury in the event of a crash.
- Head restraints should never be adjusted while the vehicle is in motion. Driving a vehicle with the head restraints improperly adjusted or removed could cause serious injury or death in the event of a collision.

Front Head Restraints

Your vehicle is equipped with front four-way driver and passenger head restraints.

To raise the head restraint, pull upward on the head restraint. To lower the head restraint, push the adjustment button, located at the base of the head restraint, and push downward on the head restraint.

NOTE:

The head restraints should only be removed by qualified technicians, for service purposes only. If either of the head restraints require removal, see an authorized dealer.

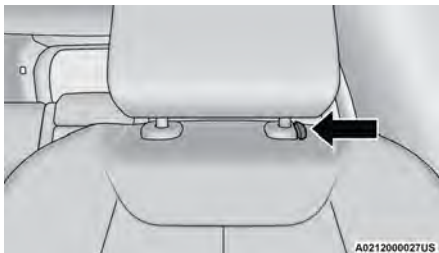

Head Restraint Adjustment Button

To adjust the head restraint forward, pull the top of the head restraint toward the front of the vehicle as desired and release. To adjust the head restraint rearward, pull the top of the head restraint to the forward most position and release. The head restraint will return to the rear most position.

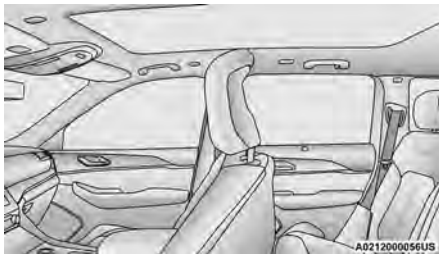

Upright Position

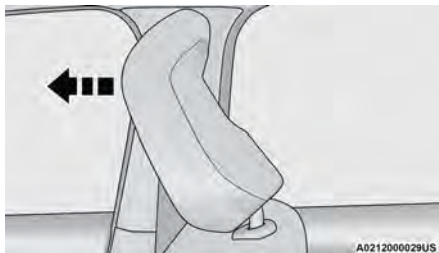

Forward Adjustment

WARNING!

- All occupants, including the driver, should not operate a vehicle or sit in a vehicle's seat until the head restraints are placed in their proper positions in order to minimize the risk of neck injury in the event of a crash.
- Head restraints should never be adjusted while the vehicle is in motion. Driving a vehicle with the head restraints improperly adjusted or removed could cause serious injury or death in the event of a collision.

Head Restraints — Second Row Captain's Chairs (If Equipped)

If the second row is equipped with captain's chairs, the head restraints are not adjustable or removable. They automatically fold forward when the seatback is folded, and do not return to their normal position when the seatback is raised. After returning the seatback to its upright position after a folding operation, raise the head restraint until it locks into place.

WARNING!

- All occupants, including the driver, should not operate a vehicle or sit in a vehicle's seat until the head restraints are placed in their proper positions in order to minimize the risk of neck injury in the event of a crash.
- Head restraints should never be adjusted while the vehicle is in motion. Driving a vehicle with the head restraints improperly adjusted or removed could cause serious injury or death in the event of a collision.

Head Restraints — Second Row Bench (If Equipped)

If the second row is equipped with a bench seat, the head restraints on the outboard seats are not adjustable or removable. They automatically fold forward when the seatback is folded, and do not return to their normal position when the seatback is raised. After returning the seatback to its upright position after a folding operation, raise the head restraint until it locks into place.

The center head restraint has one adjustment position, and can be adjusted up or down when the seat is occupied. Pull up on the head restraint to raise it. To lower the head restraint, push the adjustment button located on the base of the head restraint, and push downward on the head restraint until it locks into place.

NOTE:

The center head restraint is not removable.

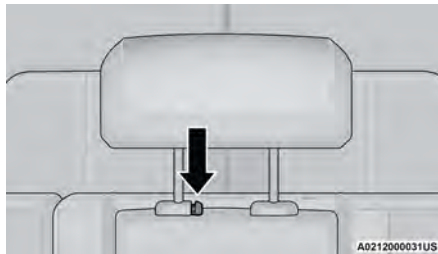

Center Seat Head Restraint Adjustment Button

NOTE:

For information on child restraint tethering, see [page 222](#).

WARNING!

- All occupants, including the driver, should not operate a vehicle or sit in a vehicle's seat until the head restraints are placed in their proper positions in order to minimize the risk of neck injury in the event of a crash.

(Continued)

WARNING!

- Head restraints should never be adjusted while the vehicle is in motion. Driving a vehicle with the head restraints improperly adjusted or removed could cause serious injury or death in the event of a collision.

2

Third Row Head Restraints — If Equipped

The third row head restraints are not adjustable or removable, but can be folded for improved visibility when the vehicle is in REVERSE, and there are no occupants in the seats.



Press the Headrest Fold button within the Controls menu of the Uconnect system to power fold the third row head restraints.

The head restraints will also automatically fold when the seatbacks are folded forward using the release handles on the backs of the seats from the cargo area.

NOTE:

- The head restraints must be raised manually when occupying the third row.
- Do not fold if there are passengers seated in the third row seats.

WARNING!

- All occupants, including the driver, should not operate a vehicle or sit in a vehicle's seat until the head restraints are placed in their proper positions in order to minimize the risk of neck injury in the event of a crash.
- Head restraints should never be adjusted while the vehicle is in motion. Driving a vehicle with the head restraints improperly adjusted or removed could cause serious injury or death in the event of a collision.

MIRRORS**INSIDE REARVIEW MIRROR****Manual Mirror — If Equipped**

The mirror head can be adjusted up, down, left, and right. The mirror should be adjusted to center on the view through the rear window.

Headlight glare from vehicles behind you can be reduced by moving the small control under the mirror to the night position (toward the rear of the vehicle). The mirror should be adjusted while set in the day position (small control forward toward the windshield).

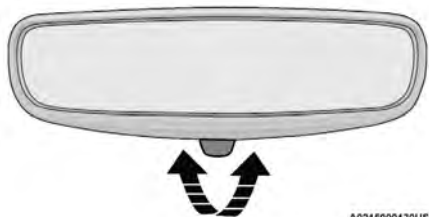
**Adjusting Rearview Mirror****Automatic Dimming Mirror — If Equipped**

The mirror head can be adjusted up, down, left, and right. The mirror should be adjusted to center on the view through the rear window.

This mirror automatically adjusts for headlight glare from vehicles behind you.

NOTE:

The Automatic Dimming Mirror feature is disabled when the vehicle is in REVERSE to improve the driver's view.

You can turn the feature on or off through the Uconnect system → page 169.

**Automatic Dimming Mirror****Digital Rearview Mirror — If Equipped**

The Digital Rearview Mirror provides a high definition, wide and unobstructed view of the road behind while driving.

Position the mirror in the regular Automatic Dimming Mirror mode, then activate the Digital Rearview Mirror mode.

To activate the Digital Rearview Mirror, pull the on/off control lever on the bottom of the mirror rearward toward the driver.

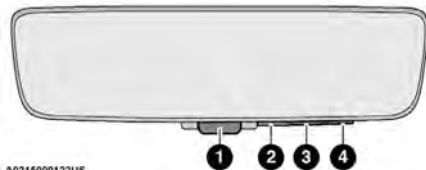
**Digital Rearview Mirror**

- 1 — On/Off Control/Toggle
- 2 — Menu Button
- 3 — Left Scroll Button
- 4 — Right Scroll Button

Push the menu button next to the on/off control/toggle to access the following mirror options:

- Brightness
- Tilt

Use the menu button to scroll through the feature options, and the left and right scroll buttons to adjust the feature content (brightness or tilt) higher/lower or up/down.

When not in use, push the on/off forward toward the windshield to return the mirror to the regular Automatic Dimming Mirror.

NOTE:

- The Digital Rearview Mirror is not as effective during nighttime driving in low light applications due to low ambient light levels. In the event that it provides the user with less than expected vision, the mirror can be reverted to a normal reflective electrochromatic mirror by pushing the control/toggle forward in the vehicle and putting the mirror into Automatic Dimming Mirror mode.
- When the rear window washer is activated by pushing the windshield wiper/washer lever forward, the Rear Back Up and Digital Rearview Mirror (if equipped) cameras are also washed. For more information, see [page 57](#).

ILLUMINATED VANITY MIRRORS

To access an illuminated vanity mirror, flip down one of the visors.

Lift the cover to reveal the mirror. The light will turn on automatically.

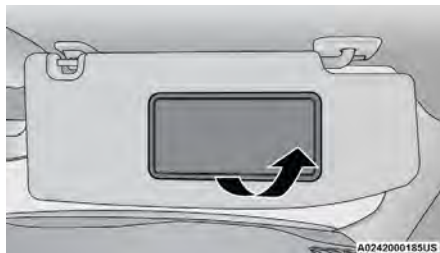

Lift Cover On Vanity Mirror

Sun Visor Slide-On-Rod Feature – If Equipped

The sun visor Slide-On-Rod feature allows for additional flexibility in positioning the sun visor to block out the sun.

1. Fold down the sun visor.
2. Unclip the visor from the center clip.
3. Pivot the sun visor toward the side window.
4. Extend the sun visor blade for additional sun blockage.

NOTE:

The sun visor blade can also be extended while the sun visor is against the windshield for additional sun blockage through the front of the vehicle.

OUTSIDE MIRRORS

To receive maximum benefit, adjust the outside mirror(s) to center on the adjacent lane of traffic with a slight overlap of the view obtained on the inside mirror.

WARNING!

Vehicles and other objects seen in an outside convex mirror will look smaller and farther away than they really are. Relying too much on side convex mirrors could cause you to collide with another vehicle or other object. Use your inside mirror when judging the size or distance of a vehicle seen in a side convex mirror.

Outside Mirrors Folding Feature

All outside mirrors are hinged and may be moved either forward or rearward to resist damage. The hinges have three detent positions:

- Full forward position
- Full rearward position
- Normal position

Outside Mirrors With Turn Signal And Approach Lighting — If Equipped

Driver and passenger outside mirrors with turn signal and approach lighting contain four LEDs, which are located in the upper outer corner of each mirror.

Three of the LEDs are turn signal indicators, which flash with the corresponding turn signal lights in the front and rear of the vehicle. Turning on the Hazard Warning flashers will also activate these LEDs.

The fourth LED supplies illuminated entry lighting, which turns on in both mirrors when you use the key fob or open any door. This LED shines outward to illuminate the front and rear door handles. It also shines downward to illuminate the area in front of the doors.

The illuminated entry lighting fades to off after about 30 seconds or it will fade to off immediately once the ignition is placed in the ON/RUN position.

NOTE:

The approach lighting will not function when the gear selector is moved out of the PARK position.

OUTSIDE AUTOMATIC DIMMING MIRROR — IF EQUIPPED

The outside driver side mirror will automatically adjust for glare from vehicles behind you. This feature is controlled by the inside automatic dimming mirror. The mirror will automatically adjust for headlight glare when the inside mirror adjusts.

POWER MIRRORS

The power mirror control switch is located on the driver's side door trim panel.

To adjust a mirror, rotate the control switch to the mirror you want to adjust (L) or (R). Then push the switch in the direction that you want the mirror to move.

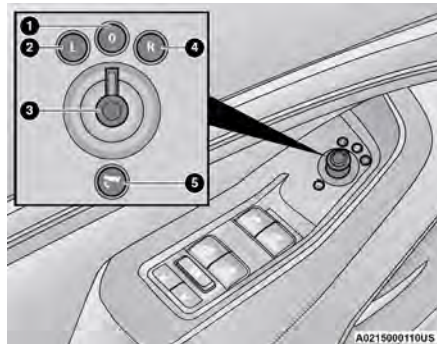

Power Mirror Switch

- 1 — Neutral Position
- 2 — Left Mirror
- 3 — Control Switch
- 4 — Right Mirror
- 5 — Power Folding Position

NOTE:

Once adjustment is complete, rotate the knob to the neutral position to prevent accidental movements.

Power Folding — If Equipped

To fold the door mirrors in using the Power Folding Mirror function, rotate the control switch to the power folding position. Rotating the control to the left, right, or neutral position will return the mirrors to the driving position.

If the power mirror control switch is moved again during door mirror folding (from closed to open position and vice versa), the movement direction is reversed.

Resetting The Power Folding Outside Mirrors

You may need to reset the power folding mirrors if the following occurs:

- The mirrors are accidentally blocked while folding.
- The mirrors are accidentally manually folded/unfolded (by hand or by pushing the power folding mirror switch).
- The mirrors come out of the unfolded position.
- The mirrors shake and vibrate at normal driving speeds.

To reset the power folding mirrors: Fold and unfold them by turning the switch (this may require multiple switch activations to synchronize the driver and passenger mirror). This resets them to their normal position.

Power mirror position can be saved as part of the Driver Memory Settings (if equipped) ↪ page 31.

AUTOMATIC POWER FOLDING MIRRORS — IF EQUIPPED

When enabled within Uconnect Settings ↗ page 169, the exterior mirrors will automatically fold when the vehicle's ignition is placed in the OFF position, and after the doors are locked and closed.

The exterior mirrors will auto-fold in the following situations after the ignition is placed in the OFF position:

- Pushing the lock button on the door panel before the door is opened.

NOTE:

If the doors are already locked, push the lock button again.

- Opening the door, then pushing the lock button on the door panel, followed by closing the door.
- After exiting the vehicle, close the doors then push the lock button on the key fob.
- After exiting the vehicle, close the doors then touch the lock icon on the Passive Entry door handle.

If the exterior mirrors were folded automatically, they will unfold when the ignition is placed in the ON/RUN position.

NOTE:

If the mirrors were folded manually, by using the power folding mirror switch on the driver's door panel, they will not automatically unfold.

HEATED MIRRORS — IF EQUIPPED



These mirrors are heated to melt frost or ice. This feature will be activated whenever you turn on the rear window defroster (if equipped) ↗ page 57.

TILT SIDE MIRRORS IN REVERSE — IF EQUIPPED

Tilt Side Mirrors In Reverse provides automatic outside mirror positioning which will aid the driver's view of the ground rearward of the front doors. Outside mirrors will move slightly downward from the present position when the vehicle is shifted into REVERSE. Outside mirrors will then return to the original position when the vehicle is shifted out of REVERSE position. Each stored memory setting will have an associated Tilt Side Mirrors In Reverse position.

NOTE:

The Tilt Side Mirrors In Reverse feature can be turned on and off using the Uconnect system ↗ page 169.

UNIVERSAL GARAGE DOOR OPENER (HOMELINK®) — IF EQUIPPED

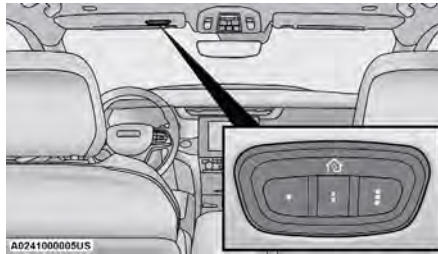

HomeLink® Buttons And Indicator Light

Use this QR code to access your digital experience.



2

- HomeLink® replaces up to three hand-held transmitters that operate devices such as garage door openers, motorized gates, lighting or home security systems. The HomeLink® unit is powered by your vehicle's 12 Volt battery.
- The HomeLink® buttons that are located in the overhead console or sun visor designate the three different HomeLink® channels.
- To operate HomeLink®, push and release any of the programmed HomeLink® buttons. These buttons will activate the devices they are programmed to with each press of the corresponding HomeLink® button.
- The HomeLink® indicator light is located above the center button.

NOTE:

HomeLink® is disabled when the Vehicle Security system is active ↗ page 331.

BEFORE YOU BEGIN PROGRAMMING HOMELINK®

For efficient programming and accurate transmission of the Radio Frequency (RF) signal, it is recommended that a new battery be placed in the hand-held transmitter of the device that is being programmed to the HomeLink® system. Make sure your hand-held transmitter is programmed to activate the device you are trying to program your HomeLink® button to.

Ensure that your vehicle is parked outside of the garage before you begin programming.

It is recommended that you erase all the channels of your HomeLink® before you use it for the first time.

If you require assistance, please call toll-free 1-800-355-3515 or visit HomeLink.com.

ERASING ALL THE HOMELINK® CHANNELS

To erase the channels, follow this procedure:

1. Place the ignition switch into the ON/RUN position.
2. Push and hold the two outside HomeLink® buttons (I and III) for up to 20 seconds, or until the HomeLink® indicator light flashes.

NOTE:

Erasing all channels should only be performed when programming HomeLink® for the first time. Do not erase channels when programming additional buttons.

IDENTIFYING WHETHER YOU HAVE A ROLLING CODE OR NON-ROLLING CODE DEVICE

Before programming a device to one of your HomeLink® buttons, you must determine whether the device has a rolling code or non-rolling code.

Rolling Code Devices

To determine if your device has a rolling code, a good indicator is its manufacturing date. Typically, devices manufactured after 1995 have rolling codes. A device with a rolling code will also have a “LEARN” or “TRAIN” button located where the antenna is attached to the device. The button may not be immediately visible when looking at the device. The name and color of the button may vary slightly by manufacturer.

NOTE:

The “LEARN” or “TRAIN” button is not the button you normally use to operate the device.

Non-rolling Code Devices

Most devices manufactured before 1995 will not have a rolling code. These devices will also not have a “LEARN” or “TRAIN” button.

PROGRAMMING HOMELINK® TO A GARAGE DOOR OPENER

To program any of the HomeLink® buttons to activate your garage door opener motor, proceed as follows:

NOTE:

All HomeLink® buttons are programmed using this procedure. You do not need to erase all channels when programming additional buttons.

1. Place the ignition switch into the ON/RUN position.
2. Place the garage door opener transmitter 1 to 3 inches (3 to 8 cm) away from the HomeLink® button you wish to program, while keeping the HomeLink® indicator light in view.
3. Push and hold the HomeLink® button you want to program while you push and hold the garage door opener transmitter button you are trying to replicate.
4. Continue to hold both buttons and observe the HomeLink® indicator light. The HomeLink® indicator light will flash slowly and then rapidly. Once this happens, release both buttons.

NOTE:

Make sure the garage door opener motor is plugged in before moving on to the rolling code/non-rolling code final steps.

Rolling Code Garage Door Opener Final Steps

NOTE:

You have 30 seconds in which to initiate rolling code final step 2, after completing rolling code final step 1.

1. At the garage door opener motor (in the garage), locate the “LEARN” or “TRAIN” button. This can usually be found where the hanging antenna wire is attached to the garage door opener motor. Firmly push and release the “LEARN” or “TRAIN” button.
2. Return to the vehicle and push the programmed HomeLink® button three times (holding the button for two seconds each time). If the garage door opener motor operates, programming is complete.
3. Push the programmed HomeLink® button to confirm that the garage door opener motor operates. If the garage door opener motor does not operate, repeat the final steps for the rolling code procedure.

Non-Rolling Code Garage Door Opener Final Steps

1. Push and hold the programmed HomeLink® button and observe the HomeLink® indicator light. If the HomeLink® indicator light stays on constantly, programming is complete.
2. Push the programmed HomeLink® button to confirm that the garage door opener motor operates. If the garage door opener motor does not operate, repeat the steps from the beginning.

WARNING!

- Your motorized door or gate will open and close while you are programming the universal transceiver. Do not program the transceiver if people or pets are in the path of the door or gate.
- Do not run your vehicle in a closed garage or confined area while programming the transceiver. Exhaust gas from your vehicle contains carbon monoxide (CO) which is odorless and colorless. Carbon monoxide is poisonous when inhaled and can cause you and others to be severely injured or killed.

PROGRAMMING HOMELINK® TO A MISCELLANEOUS DEVICE

The procedure on how to program HomeLink® to a miscellaneous device follows the same procedure as programming to a garage door opener ↪ page 48. Be sure to determine if the device has a rolling code, or non-rolling code before beginning the programming process.

NOTE:

Canadian Radio Frequency (RF) laws require transmitter signals to time-out (or quit) after several seconds of transmission, which may not be long enough for HomeLink® to pick up the signal during programming. Similar to this Canadian law, some U.S. gate operators are designed to time-out in the same manner. The procedure may need to be performed multiple times to successfully pair the device to your HomeLink® buttons.

REPROGRAMMING A SINGLE HOMELINK® BUTTON

To reprogram a single HomeLink® button that has been previously trained, without erasing all the channels, proceed as follows. Be sure to determine whether the new device you want to program the HomeLink® button to has a rolling code, or non-rolling code.

1. Place the ignition to the ON/RUN position, without starting the engine.
2. Push and hold the desired HomeLink® button until the HomeLink® indicator light begins to flash after 20 seconds. **Do not release the button.**
3. **Without releasing the button**, proceed with Step 2 in "Programming HomeLink® To A Garage Door Opener" and follow all remaining steps.

CANADIAN/GATE OPERATOR PROGRAMMING

For programming transmitters in Canada/United States that require the transmitter signals to "time-out" after several seconds of transmission:

Canadian Radio Frequency (RF) laws require transmitter signals to time-out (or quit) after several seconds of transmission, which may not be long enough for HomeLink® to pick up the signal during programming. Similar to this Canadian law, some U.S. gate operators are designed to time-out in the same manner.

It may be helpful to unplug the device during the cycling process to prevent possible overheating of the garage door or gate motor.

1. Place the ignition in the ON/RUN position.

NOTE:

For vehicles equipped with Keyless Enter 'n Go™, place the ignition in the ON/RUN position. Make sure while programming HomeLink® with the engine on that your vehicle is outside of your garage, or that the garage door remains open at all times.

2. Place the hand-held transmitter 1 to 3 inches (3 to 8 cm) away from the HomeLink® button you wish to program while keeping the HomeLink® indicator light in view.
3. Continue to push and hold the HomeLink® button while you push and release (cycle) your hand-held transmitter every two seconds until HomeLink® has successfully accepted the frequency signal. The indicator light will flash slowly and then rapidly when fully trained.
4. Watch for the HomeLink® indicator to change flash rates. When it changes, it is programmed. It may take up to 30 seconds or longer in rare cases. The garage door may open and close while you are programming.
5. Push and hold the programmed HomeLink® button and observe the indicator light.

NOTE:

- If the indicator light stays on constantly, programming is complete and the garage door/device should activate when the HomeLink® button is pushed.
- To program the two remaining HomeLink® buttons, repeat each step for each remaining button. **DO NOT** erase the channels.

If you unplugged the garage door opener/device for programming, plug it back in at this time.

Reprogramming A Single HomeLink® Button (Canadian/Gate Operator)

To reprogram a channel that has been previously trained, follow these steps:

1. Place the ignition in the ON/RUN position.
2. Press and hold the desired HomeLink® button until the indicator light begins to flash after 20 seconds. Do not release the button.
3. Without releasing the button, proceed with “Canadian/Gate Operator Programming” Step 2 and follow all remaining steps.

SECURITY

It is advised to erase all channels before you sell or turn in your vehicle.

To do this, push and hold the two outside buttons for 20 seconds until the indicator flashes. Note that all channels will be erased. Individual channels cannot be erased.

The HomeLink® Universal Transceiver is disabled when the Vehicle Security system is active.

TROUBLESHOOTING TIPS

If you are having trouble programming HomeLink®, here are some of the most common solutions:

- Replace the battery in the garage door opener hand-held transmitter.
- Push the LEARN button on the garage door opener to complete the training for a rolling code.
- Did you unplug the device for programming and remember to plug it back in?

If you have any problems, or require assistance, please call toll-free 1-800-355-3515 or on the Internet at HomeLink.com for information or assistance.

WARNING!

- Vehicle exhaust contains carbon monoxide, a dangerous gas. Do not run your vehicle in the garage while programming the transceiver. Exhaust gas can cause serious injury or death.
- Your motorized door or gate will open and close while you are programming the universal transceiver. Do not program the transceiver if people, pets or other objects are in the path of the door or gate. Only use this transceiver with a garage door opener that has a “stop and reverse” feature as required by Federal safety standards. This includes most garage door opener models manufactured after 1982. Do not use a garage door opener without these safety features.

EXTERIOR LIGHTS

HEADLIGHT SWITCH

The headlight switch is located on the left side of the instrument panel, next to the steering wheel. The headlight switch controls the operation of the headlights, parking lights, instrument panel lights, and fog lights (if equipped).

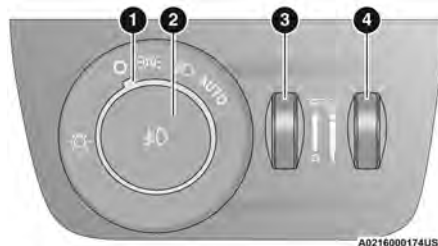

Headlight Switch

- 1 — Rotate Headlight Control
- 2 — Push Front Fog Light Control
- 3 — Ambient Light Dimmer Control
- 4 — Instrument Panel Dimmer Control

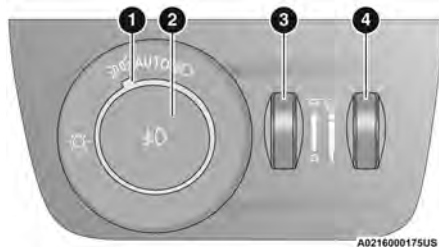

Headlight Switch (Vehicles Sold In Canada Only)

- 1 – Rotate Headlight Control
- 2 – Push Front Fog Light Control
- 3 – Ambient Light Dimmer Control
- 4 – Instrument Panel Dimmer Control

NOTE:

Vehicles sold in Canada are equipped with a headlight switch with an AUTO and ON detent but without an OFF detent. Headlights will be deactivated when the headlight switch is placed in the parking lights position. However, the Daytime Running Lights (DRLs) will be activated along with the front and rear marker lights. The DRLs may be deactivated when the parking brake is engaged.

To turn on the headlights, rotate the headlight switch clockwise. When the headlight switch is on, the parking lights, taillights, license plate light and instrument panel lights are also turned on. To turn off the headlights, rotate the headlight switch back to the O (off) position.

For vehicles sold in Canada, rotate the headlight switch clockwise from the parking lights and instrument panel lights position to the AUTO position for automatic headlights. Rotate to the second detent to turn on headlights, parking lights, and instrument panel lights operation.

NOTE:

- Your vehicle is equipped with plastic headlight and fog light (if equipped) lenses that are lighter and less susceptible to stone breakage than glass lights. Plastic is not as scratch resistant as glass and therefore different lens cleaning procedures must be followed.
- To minimize the possibility of scratching the lenses and reducing light output, avoid wiping with a dry cloth. To remove road dirt, wash with a mild soap solution followed by rinsing.

CAUTION!

Do not use abrasive cleaning components, solvents, steel wool or other abrasive materials to clean the lenses.

MULTIFUNCTION LEVER

The multifunction lever is located on the left side of the steering column.



Multifunction Lever

**DAYTIME RUNNING LIGHTS (DRLS)
– IF EQUIPPED**

The Daytime Running Lights (DRLs) come on whenever the engine is running, and the low beams are not on. The lights will remain on until the ignition is placed in the OFF or ON/RUN position, or the parking brake is engaged. The low beams must be used for normal nighttime driving.

NOTE:

- For vehicles sold in Canada, the Daytime Running Lights will automatically deactivate when the front fog lights are turned on.
- If allowed by law in the country in which the vehicle was purchased the Daytime Running Lights can be turned on and off using the Uconnect system [↔](#) page 169.
- On some vehicles, the Daytime Running Lights may deactivate, or reduce intensity, on one side of the vehicle (when a turn signal is activated on that side), or on both sides of the vehicle (when the hazard warning lights are activated).

HIGH/LOW BEAM SWITCH

Push the multifunction lever toward the instrument panel to switch the headlights to high beams. Pulling the multifunction back toward the steering wheel will turn the low beams back on, or shut the high beams off.

AUTOMATIC HIGH BEAMS — IF EQUIPPED

The Automatic High Beam Headlight system provides increased forward lighting at night by automating high beam control through the use of a digital camera mounted on the inside rearview mirror. This camera detects vehicle specific light and automatically switches from high beams to low beams until the approaching vehicle is out of view.

NOTE:

- The Automatic High Beam Headlight system can be turned on or off by selecting or deselecting “Auto Dim High Beams” within Uconnect Settings  page 169.
- The headlight switch must also be turned to the AUTO position after Automatic High Beams is enabled within Uconnect Settings for the feature to activate.
- Automatic High Beams will only activate when the vehicle speed is above 22 mph (35 km/h).
- Broken, muddy, or obstructed headlights and tail-lights of vehicles in the field of view will cause headlights to remain on longer (closer to the vehicle). Also, dirt, film, and other obstructions on the windshield or camera lens will cause the system to function improperly.

If the windshield or Automatic High Beam Headlight Control mirror is replaced, the mirror must be re-aimed to ensure proper performance. See a local authorized dealer.

FLASH-TO-PASS

You can signal another vehicle with your headlights by lightly pulling the multifunction lever toward you. This will cause the high beam headlights to turn on, and remain on, until the lever is released.

AUTOMATIC HEADLIGHTS

This system automatically turns the headlights on or off according to ambient light levels. To turn the system on, rotate the headlight switch counterclockwise to the AUTO position. When the system is on, the headlight time delay feature is also on. This means the headlights will stay on for up to 90 seconds after you place the ignition into the OFF position. The headlight time delay can be programmed to 0/30/60/90 seconds within the Uconnect system  page 169.

To turn the automatic system off, move the headlight switch out of the AUTO position.

NOTE:

The engine must be running before the headlights will come on in the automatic mode.

PARKING LIGHTS AND PANEL LIGHTS

To turn on the parking lights and instrument panel lights, rotate the headlight switch clockwise. To turn off the parking lights, rotate the headlight switch back to the O (off) position.

NOTE:

Vehicles sold in Canada are equipped with a headlight switch with an AUTO and ON detent but without an OFF detent. Headlights will be deactivated when the headlight switch is placed in the parking lights position. However, the Daytime Running Lights (DRLs) will be activated along with the front and rear marker lights. The DRLs may be deactivated when the parking brake is engaged.

HEADLIGHTS ON AUTOMATICALLY WITH WIPERS

If your vehicle is equipped with Automatic Headlights, it also has this customer-programmable feature. When your headlights are in the automatic mode and the engine is running, they will automatically turn on when the wiper system is on. This feature is programmable through the Uconnect system  page 169.

NOTE:

When your headlights come on during the daytime, the vehicle will monitor outside brightness and decide if the instrument panel needs to be dimmed  page 54.

HEADLIGHT ILLUMINATION ON APPROACH

When enabled, the headlights, exterior door handle pocket lights (if equipped), and interior lights will illuminate when the unlock button on the key fob is pushed as the operator is approaching the vehicle. This feature can be turned on/off, and the length of time the headlights stay on can be programmed for up to 90 seconds within Uconnect Settings  page 169.

Proximity Wake-Up — If Equipped

This feature is enabled/disabled within the Uconnect system, and is activated when the operator approaches the driver's door, passenger's door, or liftgate with a valid key fob on their person. Some exterior and interior lights will illuminate in order to provide an increased sense of welcome and security as the operator approaches the vehicle in the dark. "Headlight Illumination On Approach" must be selected and set to a time value other than zero within Uconnect Settings for Proximity Wake-Up to activate.

The doors may be locked or unlocked for this feature to activate, as long as the ignition is in the OFF position, or during a Remote Start event. It will not activate if the doors are locked and the ignition was placed in the ON/RUN position.

NOTE:

Proximity Wake-Up may not activate under the following conditions:

- After numerous consecutive activations, in order to conserve the vehicle's battery
- After the vehicle's engine has been off for several days

Headlight Animation — If Equipped

When "Headlight Illumination On Approach" is turned on, and set to a time value above zero, the exterior lights illuminate in a theatrical manner during approach to the vehicle. This feature is activated in the following situations:

- Proximity Wake-Up (if equipped) is activated
- Remote Start is activated
- The unlock button on the key fob is pushed

NOTE:

For Headlight Animation to activate with Remote Start or with the push of the unlock button, "Greeting Lights" must also be selected within the Uconnect system.

HEADLIGHT DELAY

To aid in your exit, your vehicle is equipped with a headlight delay that will leave the headlights on for approximately 90 seconds. This delay is initiated when the ignition is placed in the OFF position while the headlight switch is on, and then the headlight switch is cycled off. Headlight delay can be canceled by either turning the headlight switch on then off, or by placing the ignition in the ON/RUN position.

NOTE:

The headlight delay time is programmable through Uconnect Settings ➔ page 169.

LIGHTS-ON REMINDER

If the headlights or parking lights are left on after the ignition is placed in the OFF position, a chime will sound when the driver's door is opened.

FRONT FOG LIGHTS — IF EQUIPPED

To activate the front fog lights, turn on the parking lights or the low beam headlights, and push the fog light button on the headlight switch.

**Fog Light Button****Fog Light Button (Vehicles Sold In Canada Only)**

The fog lights will operate only when the parking lights are on, or when the vehicle headlights are on low beam. An indicator light located in the instrument cluster display will illuminate when the fog lights are on. The fog lights will turn off when the button is pushed a second time, when the headlight switch is rotated to the off position, or the high beam is selected.

Cornering Lights

The cornering lights are a feature to improve visibility at night while turning the vehicle. When activated, a light incorporated in the front fog light will illuminate on the side of the vehicle the steering wheel is rotated or the turn signal indicator is on. It can be activated through the Uconnect system → page 169.

TURN SIGNALS

Move the multifunction lever up or down and the arrows on each side of the instrument cluster will flash to show proper operation of the front and rear turn signal lights.

NOTE:

If either light remains on and does not flash, or there is a very fast cluster turn indicator flash rate, check for a defective outside light bulb.

LANE CHANGE ASSIST — IF EQUIPPED

Tap the multifunction lever up or down once, without moving beyond the detent, and the turn signal (right or left) will flash three times then automatically turn off.

AUTOMATIC HEADLIGHT LEVELING — IF EQUIPPED

This feature prevents the headlights from interfering with the vision of oncoming drivers. Headlight leveling automatically adjusts the height of the headlight beam in reaction to changes in vehicle pitch.

BATTERY SAVER

To protect the life of your vehicle's battery, load shedding is provided for both the interior and exterior lights. If the ignition is placed in the OFF position and any door is left ajar for 10 minutes or the overhead console Dome On switch is left on for 10 minutes, the interior lights will automatically turn off.

NOTE:

Battery saver mode is canceled if the ignition is in the ON/RUN position.

If the headlights remain on while the ignition is placed in the OFF position, the exterior lights will automatically turn off after eight minutes. If the headlights are turned on and left on for eight minutes while the ignition is in the OFF position, the exterior lights will automatically turn off.

INTERIOR LIGHTS

COURTESY LIGHTS

Courtesy and dome lights are turned on when the front doors are opened or the Dome ON button is pushed on the overhead console. If your vehicle is equipped with Remote Keyless Entry and the unlock button is pushed on the key fob, the courtesy and dome lights will turn on. When a door is open and the interior lights are on, pressing the Dome Defeat button on the overhead console will cause all of the interior lights to turn off.

Front Map/Reading Lights — If Equipped

The overhead console lights can also be operated individually as reading lights by pushing the corresponding buttons.



Courtesy Lights

- 1 — Reading Light On/Off Buttons
- 2 — Dome Defeat Button
- 3 — Ambient Light
- 4 — Dome ON Button

Rear Courtesy/Reading Lights

Located above the rear passenger seating in both second and third rows, along the trim, are courtesy/reading lights. The courtesy lights turn on when a door or the liftgate is opened. The lights will also turn on when the unlock button on the key fob is pushed.

The courtesy lights also function as reading lights. Push the reading light button to turn these lights on while inside the vehicle. Push the reading light button a second time to turn each light off.

Dimmer Controls

The dimmer controls are inboard and adjacent to the headlight switch located on the left side of the instrument panel.

With the parking lights or headlights on, rotating the right dimmer control upward will increase the brightness of the instrument cluster lights. Rotating the left dimmer control will adjust the interior light levels of the ambient lighting on the instrument panel and doors.

Certain ambient lights may be color customizable
 ↪ page 55.

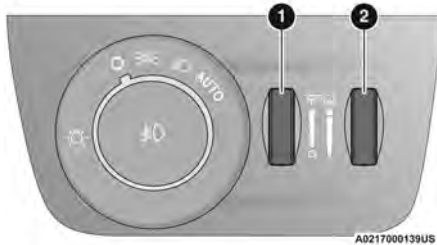

Dimmer Controls

- 1 – Ambient Light Dimmer Control
- 2 – Instrument Panel Dimmer Control

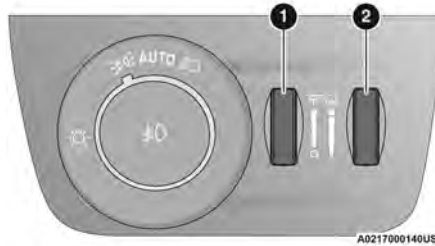

Dimmer Controls (Vehicles Sold In Canada Only)

- 1 – Ambient Light Dimmer Control
- 2 – Instrument Panel Dimmer Control

NOTE:

- Multicolor ambient lighting for first and second rows, and overhead white ambient lighting in the second and third row (if equipped) seating areas, may not be equipped in the vehicle.
- Adjusting the right dimmer control all the way upward will switch the radio screen to Light theme, while moving the control all the way down will switch the radio screen to the Dark theme.
- The dimming of lighting linked to the headlight status (i.e. radio screen brightness) is programmable through the Uconnect system ↪ page 169.

Multicolor Ambient Lighting – If Equipped

The color of certain ambient lighting inside of the vehicle can be selected within the Apps menu on the radio screen, or within Uconnect Settings
 ↪ page 169. Brightness is adjusted using the ambient light dimmer control on the headlight switch.

Five colors can be selected for the following two zones inside of the vehicle:

- Zone 1:
 - Instrument panel decorative ambient lights
- Zone 2:
 - Front seat footwell areas below the instrument panel
 - Lighting below the second row seats
 - Map pocket lighting on all four door panels

These areas can be set to different colors, or if the SYNC button is selected within the settings menu, all colored lights will be set to the same color automatically.

NOTE:

All other ambient lighting inside of the vehicle will remain white, and the ambient light dimmer control switch will adjust all ambient lighting at the same time.

WINDSHIELD WIPERS AND WASHERS

The windshield wiper/washer lever is located on the right side of the steering column. The front wipers are operated by rotating a switch, located on the end of the lever.

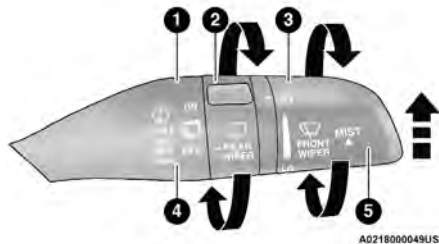

Multifunction Lever

- 1 — Pull For Front Washer
- 2 — Rotate For Rear Wiper Operation
- 3 — Rotate For Front Wiper Operation
- 4 — Push Forward For Rear Washer
- 5 — Push Up For Mist

WINDSHIELD WIPER OPERATION

The wipers and washers are operated by a switch within the wiper lever. Rotate the switch at the end of the lever upward, to the first detent past the intermittent settings for low-speed wiper operation. Rotate the switch at the end of the lever upward to the second detent past the intermittent settings for high-speed wiper operation. To turn the windshield wipers off, rotate the switch within the lever all the way down to OFF.

CAUTION!

Always remove any buildup of snow that prevents the windshield wiper blades from returning to the parked position. If the windshield wiper switch is turned off, and the blades cannot return to the parked position, damage to the wiper motor may occur.

Intermittent Wiper System

Use the intermittent wiper when weather conditions make a single wiping cycle with a variable pause between cycles desirable. Rotate the switch at the end of the wiper lever to the first detent position, and then turn the switch at the end of the lever to select the desired delay interval. There are four delay settings, which allow you to regulate the wipe interval from a minimum of one cycle every second to a maximum of approximately 36 seconds between cycles. The delay intervals will double in duration when the vehicle speed is 10 mph (16 km/h) or less.

NOTE:

If the vehicle is moving less than 10 mph (16 km/h), delay times will be doubled.

Windshield Washer Operation

To use the washer, pull the lever rearward toward you and hold. If the lever is pulled while on the intermittent setting, the wipers will turn on and operate for several wipe cycles after the lever is released, and then resume the intermittent interval previously selected. If the lever is pulled while the wipers are in the off position, the wipers will operate several cycles, then turn off.

NOTE:

- As a protective measure, the pump will stop if the switch is held for more than 20 seconds. Once the switch is released the pump will resume normal operation.
- If the front window washer feature is activated, all of the front cameras (if equipped) on the vehicle will be washed as well.

WARNING!

Sudden loss of visibility through the windshield could lead to a collision. You might not see other vehicles or other obstacles. To avoid sudden icing of the windshield during freezing weather, warm the windshield with the defroster before and during windshield washer use.

Mist

Use the Mist feature when weather conditions make occasional usage of the wipers necessary. Push the lever upward to the MIST position and release for a single wiping cycle.

NOTE:

The Mist feature does not activate the washer pump; therefore, no washer fluid will be sprayed on the windshield. The washer function must be used in order to spray the windshield with washer fluid.

For information on wiper care and replacement, see [page 281](#).

RAIN SENSING WIPERS — IF EQUIPPED

This feature senses rain or snowfall on the windshield and automatically activates the wipers. Rotate the end of the windshield wiper lever to one of the four detent positions to activate this feature.

The sensitivity of the system is adjustable from the windshield wiper lever. Wiper sensitivity position 1 is the least sensitive, and wiper sensitivity position 4 is the most sensitive.

NOTE:

- The Rain Sensing feature will not operate when the wiper switch is in the low, high, or OFF position. Only in one of the intermittent positions.
- The Rain Sensing feature may not function properly when ice or dried saltwater is present on the windshield.
- Use of products containing wax or silicone may reduce rain sensor performance.
- The Rain Sensing feature can be turned on and off through the Uconnect system → page 169.

The Rain Sensing system has protective features for the wiper blades and arms. It will not operate under the following conditions:

- **Low Temperature Wipe Inhibit** — The Rain Sensing feature will not operate when the ignition is first placed in the ON/RUN position, when the vehicle is stationary and the outside temperature is below 32°F (0°C), unless the wiper control on the windshield wiper lever is moved, the vehicle speed becomes greater than 3 mph (5 km/h) or the outside temperature rises above freezing.

- **Neutral Wipe Inhibit** — The Rain Sensing feature will not operate when the ignition is placed in the ON/RUN position, when the transmission gear selector is in the NEUTRAL position and the vehicle speed is less than 3 mph (5 km/h), unless the wiper control on the windshield wiper lever is moved, the vehicle speed is greater than 3 mph (5 km/h) or the gear selector is moved out of the NEUTRAL position.
- **Remote Start Mode Inhibit** — On vehicles equipped with the Remote Start system, Rain Sensing wipers are not operational when the vehicle is in the Remote Start mode. Once the operator is in the vehicle and has placed the ignition switch in the ON/RUN position, rain sensing wiper operation can resume, if it has been selected, and no other inhibit conditions (mentioned previously) exist.

REAR WIPER AND WASHER

The rear wiper/washer is operated by rotating a switch, located at the middle of the lever.



Rotate the center portion of the lever upward to the first detent for intermittent operation and to the second detent for continuous rear wiper operation.

Rear Window Washer Operation



Pushing the windshield wiper lever forward activates the rear window washer. If the lever is pushed while on the intermittent setting, the wiper will turn on and operate for several wipe cycles after the lever is released, and then resume the intermittent interval previously selected. If the lever is pushed while the wiper is in the off position, the wiper will operate several wipe cycles, then turn off.

NOTE:

If equipped with a Back Up camera washer, when the rear window washer is activated, the Rear Back Up camera and Digital Rearview Mirror (if equipped) cameras are also washed.

WINDSHIELD WIPER DE-ICER — IF EQUIPPED

Your vehicle may be equipped with a Windshield Wiper De-Icer feature that may be activated under the following conditions:

- **Activation By Front Defrost** — The Windshield Wiper De-Icer shall be activated automatically in the case of a cold weather manual start with full front defrost, and when the ambient temperature is below 33°F (0.6°C).
- **Activation By Rear Defrost** — The Windshield Wiper De-Icer shall be activated automatically when the rear defrost is turned on and when the ambient temperature is below 33°F (0.6°C).
- **Activation By Remote Start Operation** — When Remote Start is active and the outside ambient temperature is less than 33°F (0.6°C), the Windshield Wiper De-Icer will activate. Exiting Remote Start will resume its previous operation. If the Windshield Wiper De-Icer was active, the timer and operation will continue.

CLIMATE CONTROLS

The Climate Control system allows you to regulate the temperature, air flow, and direction of air circulating throughout the vehicle. The controls are located on the touchscreen and on the instrument panel below the radio.

AUTOMATIC CLIMATE CONTROL DESCRIPTIONS AND FUNCTIONS



Uconnect 5 NAV With 10.1-inch Display Temperature Controls



Uconnect 5/5 NAV With 8.4-inch Display Temperature Controls

Max A/C Button



Press and release to change the current setting. The MAX A/C indicator illuminates when MAX A/C is ON. Performing this function again will cause the MAX A/C operation to switch into manual mode and the MAX A/C indicator will turn off. Pressing other setting buttons will also cause the MAX A/C to turn off.

MAX A/C sets the control for maximum cooling performance.

NOTE:

The MAX A/C button is only available on the touchscreen.

A/C Button



Press and release the button on the touchscreen or push and release the button on the faceplate to change the current setting. The A/C indicator illuminates when A/C is on.

Recirculation Button



Press and release the Recirculation button on the touchscreen or push and release the button on the faceplate to change the system between recirculation mode and outside air mode. Recirculation can be used when outside conditions such as smoke, odors, dust, or high humidity are present. Recirculation can be used in all modes. Recirculation may be unavailable if conditions exist that could create fogging on the inside of the windshield.

The A/C can be deselected manually without disturbing the mode control selection. Continuous use of Recirculation mode may make the inside air stuffy and window fogging may occur. Extended use of this mode is not

recommended. Recirculation mode may automatically adjust to optimize customer experience for warming, cooling, dehumidification, etc.

In cold weather, use of Recirculation mode may lead to excessive window fogging. The Recirculation feature may be unavailable if conditions exist that could create fogging on the inside of the windshield.

AUTO Button



The AUTO button automatically controls the interior cabin temperature by adjusting distribution and amount of airflow. Air Conditioning (A/C) may be active during AUTO operation to improve performance. Performing this function will cause the system to switch between manual mode and automatic modes → page 63. AUTO mode is highly recommended for efficiency.

MAX Defrost Button



Push the MAX Defrost button to change the current airflow setting to Defrost mode. The indicator illuminates when this feature is on. Performing this function will cause the automatic climate controls to change to manual mode, and the following settings will occur:

- The blower speed increases to full (all LEDs on)
- The rear blower is off
- The air conditioning compressor is turned on (A/C LED off)
- Both driver and passenger temperature controls are set to HI
- Defrost mode is selected (LED on)
- Rear defroster is turned on (LED on)
- The air recirculation is turned off (LED off)

If MAX Defrost mode is turned off, the Climate Control system will return to the previous setting. MAX Defrost automatically turns off after 20 minutes.

Rear Defrost Button



Press and release the button on the touchscreen, or push and release the button on the faceplate, to turn on the rear window defroster and the heated outside mirrors (if equipped). The Rear Defrost indicator illuminates when the rear window defroster is on. The rear window defroster automatically turns off after 10 minutes.

CAUTION!

Failure to follow these cautions can cause damage to the heating elements:

- Use care when washing the inside of the rear window. Do not use abrasive window cleaners on the interior surface of the window. Use a soft cloth and a mild washing solution, wiping parallel to the heating elements. Labels can be peeled off after soaking with warm water.
- Do not use scrapers, sharp instruments, or abrasive window cleaners on the interior surface of the window.
- Keep all objects a safe distance from the window.

Rear Climate Control Button



Press and release this button on the climate control touchscreen to access the rear climate controls. The Rear Climate indicator will illuminate when the rear climate controls are ON.

Driver And Passenger Temperature Switches

These switches provide the driver and passenger with independent temperature control.



Lift the driver's or passenger's side toggle switch on the faceplate upward, or press and slide the temperature bar towards the red arrow button on the touchscreen for warmer temperature settings.



Depress the driver's or passenger's side toggle switch on the faceplate downward, or press and slide the temperature bar towards the blue arrow button on the touchscreen for cooler temperature settings.

SYNC Button



Press the SYNC button on the touchscreen to toggle the SYNC feature on/off. The SYNC indicator illuminates when SYNC is on. SYNC is used to synchronize the front passenger temperature and rear passenger temperature, mode, and blower settings with the driver temperature, mode, and blower settings. Changing the front passenger temperature or rear passenger temperature, mode, and blower settings while in SYNC will automatically exit this feature.

NOTE:

- The SYNC setting is only available on the touchscreen.
- For vehicles equipped with the Four-Zone ATC system, the rear climate control settings (temperature, blower speed, and mode) will change to match the driver's settings when the vehicle is first started, without changing the SYNC status.

- When SYNC is not active, the rear passenger climate control settings will need to be adjusted manually to achieve desired comfort. See [↔](#) page 60 or [↔](#) page 62 for more information.

Blower Control



Blower Control is used to regulate the amount of air forced through the Climate Control system. There are several blower speeds available.

Blower speed can be controlled by lifting blower toggle on the instrument panel to increase blower speed, or depress the toggle for lower blower speed.

The speed can also be selected using the blower control buttons on the touchscreen. Press the blower bar area between the icons on the touchscreen.

Mode Control



Select Mode by pressing one of the Mode buttons on the touchscreen, or the faceplate, to change the airflow distribution mode. The airflow distribution mode can be adjusted so air comes from the instrument panel outlets, floor outlets, defrost outlets and demist outlets.

Panel Mode



Air comes from the outlets in the instrument panel. Each of these outlets can be individually adjusted to direct the flow of air. The air vanes of the center outlets and outboard outlets can be moved up and down or side to side to regulate airflow direction. There is a shut-off wheel located next to the air vanes to shut off or adjust the amount of airflow from these outlets.

Bi-Level Mode



Air comes from the instrument panel outlets and floor outlets. A slight amount of air is directed through the defrost and side window demister outlets.

NOTE:

Bi-Level mode is designed under comfort conditions to provide cooler air out of the panel outlets and warmer air from the floor outlets.

For more information on selecting modes, see [page 60](#).

Floor Mode



Air comes from the floor outlets. A slight amount of air is directed through the defrost and side window demister outlets.

Mix Mode



Air is directed through the floor, defrost, and side window demister outlets. This setting works best in cold or snowy conditions that require extra heat to the windshield. This setting is good for maintaining comfort while reducing moisture on the windshield.

Combine Modes

Dual Level Combination

Front Defrost and Panel Mode

Tri-Level Combination

Front Defrost, Panel Mode, and Floor Mode



The driver or front passenger can combine two or three of the modes described by selecting them individually on their side of climate control screen. Combine modes by pressing each icon on the touchscreen.

Climate Control OFF Button



Press and release this button to turn the Climate Control ON/OFF.

Controlling The Rear Climate Controls From The Front ATC Panel



Front ATC Panel Uconnect 5 NAV With 10.1-inch Display
Rear Controls



Front ATC Panel Uconnect 5/5 NAV With 8.4-inch Display
Rear Controls

The Three-Zone and Four-Zone ATC system allows for adjustment of the rear climate controls from the front ATC panel.



To change the rear system settings:

- Press the Rear button on the touchscreen to display the rear climate controls. The control functions now operate the rear system.
- Press the Front button on the touchscreen to return to the front climate controls.

NOTE:

If equipped with a Four-Zone ATC system, the left and right sides of the rear passenger zones can be adjusted separately from the front or rear ATC panel.

REAR AUTO BUTTON

 Press and release this button on the touchscreen to change the current setting. The REAR AUTO indicator will illuminate when REAR AUTO is on. This feature automatically controls the rear interior cabin temperature by adjusting airflow distribution and amount. Toggling this function will cause the rear system to switch between manual mode and automatic modes  page 63.

REAR LOCK BUTTON

 Press and release this button to lock out the rear manual temperature controls from adjusting the rear temperature and blower settings. The LOCK REAR indicator will illuminate when LOCK REAR is on.



FRONT CLIMATE BUTTON

 Press and release to return to the Front Climate Control Screen.

SYNC BUTTON

 Press the SYNC button on the touchscreen to toggle the SYNC feature on/off. The SYNC indicator will illuminate when SYNC is on. SYNC is used to synchronize the front passenger temperature and rear passenger temperature, mode, and blower settings with the driver temperature, mode, and blower settings. Changing the front passenger temperature or rear passenger temperature, mode, or blower settings while in SYNC will automatically exit this feature.

NOTE:

- The SYNC setting is only available on the touchscreen.
- For vehicles equipped with the Four-Zone ATC system, the rear climate control settings (temperature, blower speed, and mode) will change to match the driver's settings when the vehicle is first started, without changing the SYNC status.
- When SYNC is not active, the rear passenger climate control settings will need to be adjusted manually to achieve desired comfort. See  page 60 or  page 62 for more information.

REAR BLOWER CONTROL

 Rear Blower Control is used to regulate the amount of air forced through the rear climate system. There are several blower speeds available. The speeds can be selected using the blower bar area between the icons on the touchscreen.

REAR MODE CONTROL



The rear airflow distribution modes can be adjusted so air comes from the headliner outlets, the floor outlets, or both. Select the arrow icons individually on the front climate control screen. Combine modes by pressing both icons.

2

HEADLINER MODE



Air comes from the outlets in the headliner. Each of these outlets can be individually adjusted to direct the flow of air. Moving the air vanes of the outlets to one side shuts off the airflow.

BI-LEVEL MODE



Press this button on the touchscreen to change the air distribution mode to Bi-Level Mode. In Bi-Level Mode, air comes from both the headliner outlets and the floor outlets.

NOTE:

In many temperature positions, the Bi-Level mode is designed to provide cooler air out of the headliner outlets and warmer air from the floor outlets.

FLOOR MODE

Press this button on the touchscreen to change the air distribution mode to Floor Mode. In Floor Mode, air comes from the floor outlets.

REAR CLIMATE CONTROL OFF BUTTON

To manually set the rear blower controls to off, press the Rear Climate Control/Blower Off button.

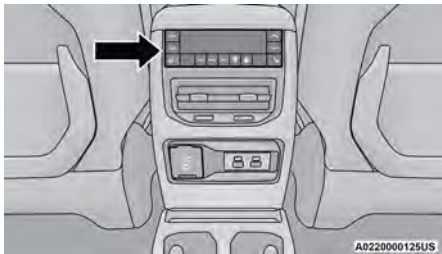
REAR AUTOMATIC TEMPERATURE CONTROL**Rear Automatic Climate Controls**

The rear ATC system has floor air outlets at the rear right side of the third row seats and overhead outlets at each outboard rear seating position. The system provides heated air through the floor outlets or cool, dehumidified air through the headliner outlets.

The rear system temperature control buttons are located on rear of the front center console.

NOTE:

If equipped with a Four-Zone ATC system, the left and right sides of the rear passenger zones can be adjusted separately from the front or rear ATC panel.

AUTO Button

The AUTO button automatically controls the interior cabin temperature by adjusting distribution and amount of airflow. Performing this function will cause the system to switch between manual mode and automatic modes
↩ page 63.

Rear Temperature Control

These buttons provide the left and right side of the rear seating area with independent temperature control.



Push the Up button on the faceplate for warmer temperature settings.



Push the Down button on the faceplate for cooler temperature settings.

Rear Blower Control

Use the blower button with the down arrow to reduce the blower setting, and the blower button with the up arrow to increase the blower setting. The rear blower setting is shown in the display.

Rear Mode Control

Push the rear mode button to adjust airflow distribution. The rear mode settings are shown in the rear display. The rear airflow distribution mode can be adjusted so air comes from the headliner outlets, the floor outlets, or both.

Panel Mode

Air comes from the outlets in the headliner. Each of these outlets can be individually adjusted to direct the flow of air. Moving the air vanes of the outlets to one side will shut off the airflow.

Bi-Level Mode

Air comes from both the headliner outlets and the floor outlets.

NOTE:

In many temperature positions, the Bi-Level mode is designed to provide cooler air out of the headliner outlets and warmer air from the floor outlets.

Floor Mode

Air comes from the floor outlets.

Rear Temperature Lock

The Rear Temperature Lock symbol on the rear display is illuminated when the rear controls are locked by the front system.

REAR LOCK

Pressing the Rear Temperature Lock button on the Uconnect touchscreen will illuminate a lock symbol in the rear display. The rear temperature and air source are then controlled from the front Uconnect system.

Rear seat occupants can only adjust the rear ATC control when the Rear Temperature Lock button is turned off.

The rear ATC is located on the rear of the front center console.

- Press the Rear Temperature Lock button on the front Uconnect touchscreen a second time to turn the Rear Temperature Lock icon off in the rear display.
- Push a rear blower button, adjust the temperature using the rear up and down arrows, and select a control mode to suit the rear occupant's needs.
- ATC is selected by pushing the AUTO button on the rear climate control faceplate.

Once the desired temperature is shown on the rear display, the ATC System will automatically achieve and maintain that comfort level. When the system is set up for your comfort level, it is not necessary to change the settings. You will experience the greatest efficiency by simply allowing the system to function automatically.

AUTOMATIC TEMPERATURE CONTROL (ATC)

Automatic Operation

1. Push the AUTO button on the front Automatic Temperature Control (ATC) Panel and the word "AUTO" will illuminate in the front ATC display, along with two temperatures for the driver and front passenger. The system will then automatically regulate the amount of airflow.
2. Adjust the temperature you would like the system to maintain, by adjusting the driver, passenger, and rear temperatures. Once the desired temperature is displayed, the system will achieve and automatically maintain that comfort level.
3. When the system is set up for your comfort level, it is not necessary to change the settings. You will experience the greatest efficiency by simply allowing the system to function automatically.

NOTE:

It is not necessary to move the temperature settings. The system automatically adjusts the temperature, mode and fan speed to provide comfort as quickly as possible.

To provide you with maximum comfort in the automatic mode, during cold start-ups, the blower fan will remain on low until the engine warms up. The fan will engage immediately if the Defrost mode is selected, or by changing the front blower knob setting.

Manual Operation Override

This system offers a full complement of manual override features. The AUTO symbol in the front ATC display will be turned off when the system is being used in the manual mode.

NOTE:

The system will not automatically sense the presence of fog, mist or ice on the windshield. Defrost mode must be manually selected to clear the windshield and side glass.

CLIMATE VOICE RECOGNITION

Adjust vehicle temperatures hands-free and keep everyone comfortable while you keep moving ahead (if vehicle is equipped with climate controls).

Push the VR button. After the beep, say one of the following commands:

- "Set the driver temperature to 70 degrees"
- "Set the passenger temperature to 70 degrees"

Did You Know: Voice Command for Climate may only be used to adjust the interior temperature of your vehicle. Voice Command will not work to adjust the heated seats or steering wheel if equipped.

OPERATING TIPS

CAUTION!

Interior air enters the Rear Automatic Temperature Control system through an intake grille, located in the right side trim panel behind the third row seats. The heater outlets are located in the right side trim panel, just behind the rear doors. Do not block or place objects directly in front of the inlet grille or heater outlets. The electrical system could overload causing damage to the blower motor.

NOTE:

Refer to the chart at the end of this section for suggested control settings for various weather conditions.

Summer Operation

The engine cooling system must be protected with a high-quality antifreeze coolant to provide proper corrosion protection and to protect against engine overheating. OAT coolant (conforming to MS.90032) is recommended. For more information, see [page 324](#).

Winter Operation

To ensure the best possible heater and defroster performance, make sure the engine cooling system is functioning properly and the proper amount, type, and concentration of coolant is used. Use of the Air Recirculation mode during Winter months is not recommended, because it may cause window fogging.

Vacation/Storage

For information on maintaining the Climate Control system when the vehicle is being stored for an extended period of time, see [page 318](#).

Window Fogging

Vehicle windows tend to fog on the inside in mild, rainy, and/or humid weather. To clear the windows, select Defrost or Mix mode and increase the front blower speed. Do not use the Recirculation mode without A/C for long periods, as fogging may occur.

Outside Air Intake

Make sure the air intake, located directly in front of the windshield, is free of obstructions, such as leaves. Leaves collected in the air intake may reduce airflow, and if they enter the air distribution box, they could plug the water drains. In Winter months, make sure the air intake is clear of ice, slush, and snow.

Cabin Air Filter

The Climate Control system filters out dust and pollen from the air. Contact an authorized dealer to service your cabin air filter, and to have it replaced when needed.

Stop/Start System — If Equipped

While in an Autostop, the Climate Control system may automatically adjust airflow to maintain cabin comfort. Customer settings will be maintained upon return to an engine running condition.

Windshield Wiper De-Icer — If Equipped

The Windshield Wiper De-Icer is a heating element located at the base of the windshield.

It operates automatically once the following conditions are met:

- **Activation By Front Defrost**

The Windshield Wiper De-Icer activates automatically during a cold weather manual start with **full defrost**, and when the **ambient temperature is below 33°F (0.6°C)**.









- **Activation By Rear Defrost**

The Windshield Wiper De-Icer activates automatically when the Rear Defrost is operating and the **ambient temperature is below 33°F (0.6°C)**.

- **Activation By Remote Start Operation**

When the Remote Start is activated and the **outside ambient temperature is less than 33°F (0.6°C)** the Windshield Wiper De-Icer will activate. Exiting Remote Start will resume its previous operation. If the Windshield Wiper De-Icer was active, the timer and operation will continue.

Operating Tips Chart

WEATHER	CONTROL SETTINGS
Hot Weather And Vehicle Interior Is Very Hot	Set the mode control to  (Panel Mode),  (MAX A/C) on, and blower on high. Roll down the windows for a minute to flush out the hot air. Adjust the controls as needed to achieve comfort.
Warm Weather	Turn  (A/C) on and set the mode control to  .
Cool Sunny	Operate in  (Bi-Level Mode).
Cool & Humid Conditions	Set the mode control to  (Floor Mode) and turn  (A/C) on to keep windows clear.
Cold Weather	Set the mode control to  (Floor Mode). If windshield fogging starts to occur, move the control to  (Mix Mode).

INTERIOR STORAGE AND EQUIPMENT

STORAGE

Glove Compartment

The glove compartment is located on the passenger side of the instrument panel.

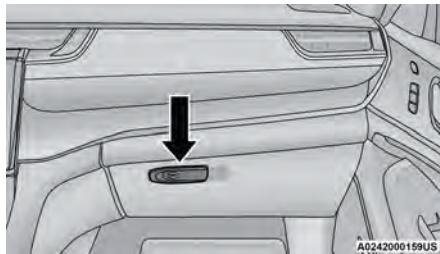

Glove Compartment Release Handle

To open the glove compartment, pull the release handle.

Front Center Console

The front center console contains both an upper and a lower storage area.

To open the upper storage compartment, pull the upper paddle release lever.

To open the lower storage compartment, pull the lower paddle release lever.

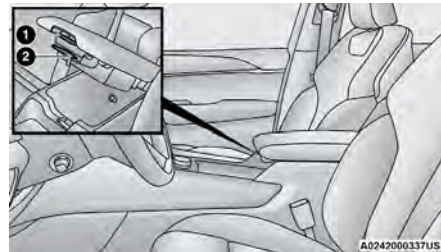

Storage Compartment Release Levers

- 1 — Upper Compartment Release Lever
- 2 — Lower Compartment Release Lever

Lift upward on the larger of the release levers to access the lower storage compartment.

Sunglasses Bin Door

At the front of the console a compartment is provided for the storage of a pair of sunglasses. The storage compartment access is a push/push design. Push the chrome pad on the door to open. Push the chrome pad on the door to close.

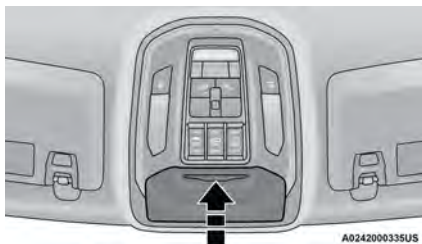

Sunglasses Bin Door

Rear Full Center Console — If Equipped

The rear full center console contains both an upper and a lower storage area.

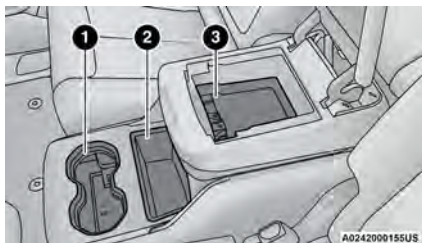

Rear Center Console

- 1 — Console Cupholders
- 2 — Open Lower Storage Area
- 3 — Covered Storage Compartment

To open the covered storage compartment, pull the upper paddle release lever on the front of the lid.

The storage compartment may also be lifted forward. Pull the paddle release lever located on the back of the console lid.

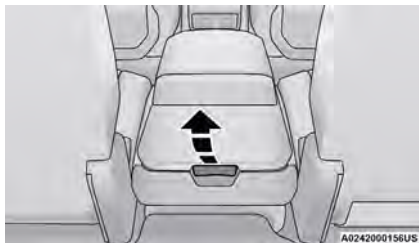

Rear Paddle Release Lever

When the second row seats are folded flat, lifting the console forward provides a flat load floor surface from the cargo area. There is also access to the storage compartment from the third row.

CAUTION!

Remove any items stored in the console cupholders or devices with cords routing through upper storage area. Damage may occur to upper console lid and device cables when upper storage compartment is lifted forward.

LIGHTED CUPHOLDERS — IF EQUIPPED

On some vehicles, the front cupholders are equipped with a light ring that illuminates the cupholders for the front passengers.

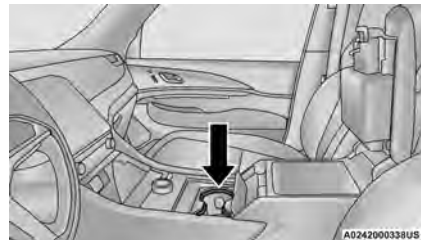

Light Ring In Front Cupholder

The rear cupholders may also be equipped with a light ring that illuminates the cupholders for the rear passengers. The light ring is controlled by the Dimmer Controls [page 55](#).



Light Ring In Rear Cupholder (If Equipped)

SUN SCREENS — IF EQUIPPED

Sun screens are available for the second row seating windows. The screens store in the sill trim panels, and the tops of the windows are equipped with hooks that the sun screens attach to when pulled up.

Gently pull up on the tab to raise the sun screen. Continue pulling the sun screen until the tab is near the top of the window.

Once the screen is completely to the top of the window, extend the top bar of the sun screen over the two hooks attached to the top of the window.

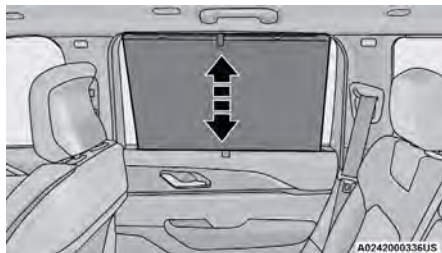

Sun Screen Extended

To lower the sun screen, gently lift the tab upward to disengage the hooks, and feed the screen back into the base sill.

USB/AUX CONTROL

This feature allows an external USB device to be plugged into one of the USB ports, located in the center stack of the instrument panel.

Plugging in a smartphone device to a USB port will activate Android Auto™ or Apple CarPlay® features, if equipped. For further information, refer to “Android Auto™” or “Apple CarPlay®” in the Uconnect Radio Instruction Manual.

NOTE:

Two devices can be plugged in at the same time, and both ports will provide charging capabilities. Only one port can transfer data to the system at a time.

For example, if a device is plugged into the Type A USB port and another device is plugged into the Type C USB port, a message will appear and allow you to select which device to use.

The following messages will appear when a non-phone device is plugged into the smaller and larger USB ports, and when a phone device is plugged into the smaller and larger USB ports:

- “A new device is now connected. Previous connection was lost.”
- “(Phone Name) now connected. Previous connection was lost.”
- “Another device is in use through the same USB port. Please disconnect the first device to use the second device.”

Plugging in a phone or another USB device may cause the connection to a previous device to be lost.

Connecting AUX Or The External USB Device

Use a connection cable to connect an external USB device to the vehicle’s USB port, or use an auxiliary cable to connect a device to the vehicle’s AUX port. Both are located below the climate controls.

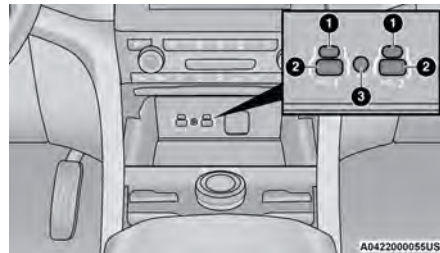

USB/AUX Ports

- 1 — USB C Port
- 2 — USB A Port (Standard USB)
- 3 — AUX Port

Once a device is connected to the USB port, it will begin charging and is ready for use with the system. Type C and Type A charge-only USB ports can be used at the same time but cannot be used simultaneously while playing media. When both Type C and Type A charge-only USB ports are in use they will be charged at a reduced rate.

If equipped, in the center arm rest are USB ports for Rear Seat Entertainment. Both the USB A (Standard USB) and USB C port can be used as a media source for the rear screens.

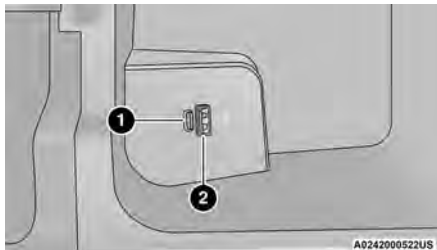

Center Arm Rest Rear Seat Entertainment USB Ports – If Equipped

- 1 – USB C Port
- 2 – USB A Port (Standard USB)

NOTE:

If the device's battery completely discharges, it may not communicate with the Uconnect system until a minimum charge is attained. Leaving the device connected to the USB port may charge it to the required level.

Using This Feature

By using a USB cable to connect an external device:

- The device can be played on the vehicle's sound system, and provides the artist, track title, and album information on the radio display.

NOTE:

Depending on track configuration, track information may not be present on the radio display.

- The device can be controlled using the radio buttons to play and browse the contents of the device.
- The audio device battery charges when plugged into the USB port.

By using an auxiliary cable to connect an external device:

- The audio device can be played on the vehicle's sound system. The Uconnect system will not display information related to the artist, track title, and album information.

NOTE:

When using the AUX port, the external device cannot be controlled using the radio buttons. The device will not charge.

For further information, refer to the Uconnect Radio Instruction Manual.

Second And Third Row USB Ports

The second row USB ports can be used to charge an external device.



Center Console Rear USB Ports

In the third row, a set of two USB ports can be used to charge a device. These ports are charge only.

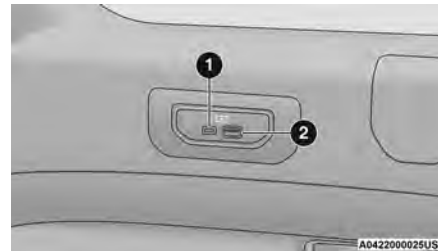

Third Row USB Ports

- 1 – Charge Only Type C USB Port
- 2 – Charge Only Type A USB Port

NOTE:

Charge unsupported devices with the Charge Only USB ports. If an unsupported device is plugged into a Media USB port, a message will display on the touchscreen that the device is not supported by the system.

ELECTRICAL POWER OUTLETS

Your vehicle is equipped with 12 Volt (13 Amp) power outlets that can be used to power cellular phones, small electronics and other low powered electrical accessories. The power outlets are labeled with either a “key” or a “battery” symbol to indicate how the outlet is powered. Power outlets labeled with a key symbol are powered when the ignition switch is in the ON/RUN position, while the outlets labeled with a battery symbol are connected directly to the battery and powered at all times.

NOTE:

- All accessories connected to the battery powered outlets should be removed or turned off when the vehicle is not in use to protect the battery against discharge.
- Do not exceed the maximum power of 160 W (13 Amp) at 12 Volt. If the 160 W (13 Amp) power rating is exceeded the fuse protecting the system needs to be replaced.
- Power outlets are designed for accessory plugs only. Do not insert any other object in the power outlets as this will damage the outlet and blow the fuse. Improper use of the power outlet can cause damage not covered by your New Vehicle Limited Warranty.

The front power outlet is located inside the storage area on the center stack of the instrument panel, below the climate controls.

**Front Power Outlet**

The rear cargo power outlet is located in the right rear cargo area when the vehicle is equipped with third row seating. When the vehicle is equipped with only two row seating, the cargo area outlet is located on the left side trim panel.

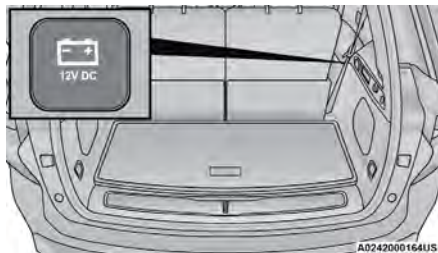
**Rear Cargo Power Outlet (Third Row Seating)****NOTE:**

The rear cargo power outlet can be changed from battery powered to powered by ignition in the ON/RUN position by switching the cargo area power outlet fuse from F44B to F44A in the rear power distribution center  page 288.

WARNING!

To avoid serious injury or death:

- Only devices designed for use in this type of outlet should be inserted into any 12 Volt outlet.
- Do not touch with wet hands.
- Close the lid when not in use and while driving the vehicle.
- If this outlet is mishandled, it may cause an electric shock and failure.

CAUTION!

- Many accessories that can be plugged in draw power from the vehicle's battery, even when not in use (i.e., cellular phones, etc.). Eventually, if plugged in long enough, the vehicle's battery will discharge sufficiently to degrade battery life and/or prevent the engine from starting.
- Accessories that draw higher power (i.e., coolers, vacuum cleaners, lights, etc.) will degrade the battery even more quickly. Only use these intermittently and with greater caution.
- After the use of high power draw accessories, or long periods of the vehicle not being started (with accessories still plugged in), the vehicle must be driven a sufficient length of time to allow the generator to recharge the vehicle's battery.

POWER INVERTER — IF EQUIPPED

There is a 115 Volt, 150 W inverter outlet located on the back of the center console to convert DC current to AC current. This outlet can power cellular phones, electronics and other low power devices requiring power up to 150 W. Certain video game consoles exceed this power limit, as will most power tools.



Power Inverter

The power inverter is designed with built-in overload protection. If the power rating of 150 W is exceeded, the power inverter automatically shuts down. Once the electrical device has been removed from the outlet the inverter should automatically reset. To avoid overloading the circuit, check the power ratings on electrical devices prior to using the inverter.

WARNING!

To avoid serious injury or death:

- Do not insert any objects into the receptacles.
- Do not touch with wet hands.
- Close the lid when not in use.
- If this outlet is mishandled, it may cause an electric shock and failure.

WIRELESS CHARGING PAD — IF EQUIPPED



Wireless Charging Pad

Your vehicle may be equipped with a 15W 3A Qi® wireless charging pad located below the center stack, within the storage compartment. This charging pad is designed to wirelessly charge your Qi® enabled mobile phone. Qi® is a standard that allows wireless charging of your mobile phone.

Your mobile phone must be designed for Qi® wireless charging. If the phone is not equipped with Qi® wireless charging functionality, an aftermarket sleeve or a specialized back plate can be purchased from your mobile phone provider or a local electronics retailer. Please see your phone's Owner's Manual for further information.

The wireless charging pad is equipped with an anti-slip mat to hold your mobile phone in place, and an LED indicator light.

Place the device inside the prepared area delimited in the mat as shown in the image. Incorrect positioning will prevent the phone from charging.

LED Indicator Status:

- No Light: Charging pad is idle or searching for a device. Device may not be compatible with the Qi® standard.
- Blue Light: Device is detected and is charging.
- Red Light/Flashing: Internal error or foreign object is detected.
- Green Light: Device has completed battery charging (if device is equipped to transmit this information).

Important Notes Regarding This Vehicle's Wireless Charging Pad:

- The presence of the Near-Field Communication (NFC) function active on a smartphone could signal malfunction anomalies.
- The ignition must be in the ON/RUN position in order for the phone to charge.
- To avoid interference with the key fob search, the wireless charging pad will stop charging when any door or liftgate is opened, even if the engine is running.
- Be sure to place the mobile device correctly (display facing upward, and phone not covering the LED) on the wireless charging pad.
- If the phone moves on the pad causing the red light to illuminate, the phone will have to be picked up and placed back on the charging pad to resume charging.
- Wireless charging is not as fast as when the phone is connected to a wired charger.

- If the phone moves on the pad causing the red light to illuminate, the phone will have to be picked up and placed back on the charging pad to resume charging.
- Wireless charging is not as fast as when the phone is connected to a wired charger.
- The phone's protective case must be removed when placed on the wireless charging pad.
- iPhone® 12 (including iPod®) is equipped with software to protect the device from overheating. When the software is active, the rate of charge is slowed down to protect the device.
- Phones must always be placed on the wireless charging pad within the outline shown on the pad so that its charging parts connect with the charging coils of the system. Movement of the phone during charging may prevent or slow the rate of charge.
- Having multiple applications open on the phone while charging will reduce the charging efficiency, and may even shut down an application that is actively running (i.e. Apple CarPlay®). This may also cause the phone to overheat.
- Wireless chargers may implement certain methods to prevent the phone from overheating during charging such as slowing down the rate of charge. In certain instances, the device may shut down for a brief period of time (when the device reaches a certain temperature). If this happens, it does not mean there is a fault with the wireless charging pad. This may just be a protective measure to prevent damage to the phone.

- The use of multiple wireless functions at the same time (wireless charging, Apple CarPlay®, Android Auto™) could cause the device to overheat, resulting in limitation of the functions or it turning off. In this case, it is recommended to connect the system using the USB port.
- Do not place the key fob or any other type of metal/magnetized object inside the mobile phone housing or near the wireless charging pad.
- With a compatible device placed on the charging pad, and the ignition is cycled to the OFF position, a reminder message may appear on the instrument cluster display to warn the driver.

CAUTION!

The key fob should not be placed on the charging pad or within 6 inches (15 cm) of it. Doing so can cause excessive heat buildup and damage to the fob. Placing the fob in close proximity of the charging pad blocks the fob from being detected by the vehicle and prevents the vehicle from starting.

WINDOWS

POWER WINDOW CONTROLS

The power window controls, located on the driver's door trim panel, operate the window movement for all four power windows.

There is a single switch on the front passenger door and rear passenger doors which operates the windows for only that door.

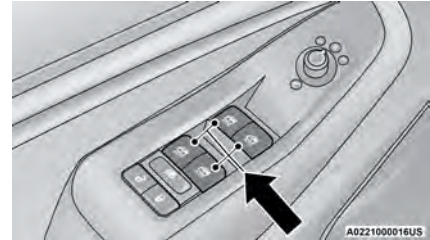

Driver's Door Power Window Switches

2

NOTE:

- The power window switches remain active for up to 10 minutes after the ignition has been placed in the OFF position. Opening a vehicle front door will cancel this feature.
- The window controls will operate only when the vehicle's ignition is placed in the ON/RUN position.
- The power windows may be operated from outside of the vehicle by using the key fob. For more information, see  page 18.

WARNING!

Never leave children unattended in a vehicle, and do not let children play with power windows. Do not leave the key fob in or near the vehicle, or in a location accessible to children, and do not leave the Keyless Enter 'n Go™ Ignition in the ON/RUN position. Occupants, particularly unattended children, can become entrapped by the windows while operating the power window switches. Such entrapment may result in serious injury or death.

Automatic Window Features

Both the driver and front passenger windows, and if equipped, both rear windows, may have Auto-Down and Auto-Up operations.

Auto-Down Feature

For windows equipped with the AUTO feature, push the window switch down to the second detent, release, and the window will go down automatically.

To stop the window from going all the way down during the Auto-Down operation, pull up or push down on the switch briefly.

Auto-Up Feature With Anti-Pinch Protection

For windows equipped with the AUTO feature, lift the window switch up to the second detent, and release; the window will go up automatically.

To stop the window from going all the way up during the Auto-Up operation, push down on the switch briefly.

To close the window part way, lift the window switch briefly and release it when you want the window to stop.

For vehicles equipped with anti-pinch protection, if the window runs into any obstacle during auto-closure, it will reverse direction and then go back down. Remove the obstacle and use the window switch again to close the window.

NOTE:

Any impact due to rough road conditions may trigger the auto-reverse function unexpectedly during auto-closure. If this happens, pull the switch lightly and hold to close the window manually.

WARNING!

There is no anti-pinch protection when the window is almost closed. To avoid personal injury be sure to clear your arms, hands, fingers and all objects from the window path before closing.

Reset Auto-Up

Should the Auto-Up feature stop working, the window may need to be reset. To reset Auto-Up:

Front Doors

1. Pull the window switch up to close the window completely and continue to hold the switch up for an additional two seconds after the window is closed.

Rear Doors

1. Pull the window switch up to close the window completely and continue to hold the switch up for an additional two seconds after the window is closed.
2. Release the window switch, and within five seconds, pull the window switch up again for an additional two seconds.

Window Lockout Switch

The window lockout switch on the driver's door trim panel allows you to disable the window controls on the rear passenger doors. To disable the window controls, push and release the window lockout button (the indicator light on the button will turn on). To enable the window controls, push and release the window lockout button again (the indicator light on the button will turn off).

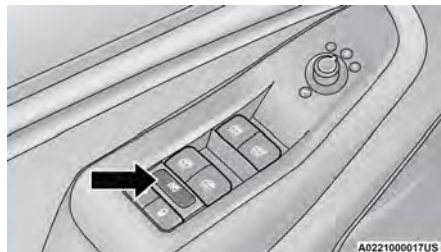

Power Window Lockout Switch

WIND BUFFETING

Wind buffeting can be described as the perception of pressure on the ears or a helicopter-type sound in the ears. Your vehicle may exhibit wind buffeting with the windows down, or the sunroof (if equipped) in certain open or partially open positions. This is a normal occurrence and can be minimized. If the buffeting occurs with the rear windows open, open the front and rear windows together to minimize the buffeting. If the buffeting occurs with the sunroof open, adjust the sunroof opening to minimize the buffeting or open any window.

POWER SUNROOF — IF EQUIPPED

SINGLE PANE POWER SUNROOF — IF EQUIPPED

The power sunroof switches are located on the overhead console between the courtesy/reading lights.

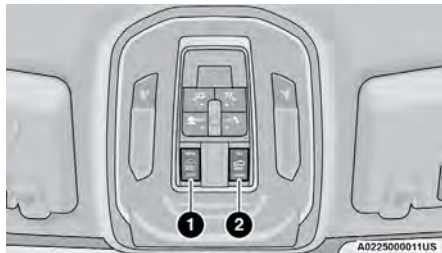

Power Sunroof Switches

- 1 — Opening/Closing Sunroof
2 — Venting Sunroof

WARNING!

- Never leave children unattended in a vehicle, or with access to an unlocked vehicle. Never leave the key fob in or near the vehicle, or in a location accessible to children. Do not leave the Keyless Enter 'n Go™ Ignition in the ON/RUN position. Occupants, particularly unattended children, can become entrapped by the power sunroof while operating the power sunroof switch. Such entrapment may result in serious injury or death.

(Continued)

WARNING!

- In a collision, there is a greater risk of being thrown from a vehicle with an open sunroof. You could also be seriously injured or killed. Always fasten your seat belt properly and make sure all passengers are also properly secured.
- Do not allow small children to operate the sunroof. Never allow your fingers, other body parts, or any object, to project through the sunroof opening. Injury may result.

Opening And Closing The Sunroof

Express Open/Close

To open the sunroof, push OPEN on the sunroof switch and release it within one-half second and the sunroof will open automatically from any position.

To close the sunroof, push CLOSE on the sunroof switch and release it within one-half second and the sunroof will close automatically from any position.

During Express Open or Express Close operation, any other actuation of the sunroof switch will stop the sunroof.

Manual Open/Close

To open the sunroof, push and hold OPEN on the sunroof switch.

To close the sunroof, push and hold CLOSE on the sunroof switch.

Any release of the switch during open or close operation will stop the sunroof movement in a partially open position. The sunroof will remain in a partially opened position until the switch is operated and held again.

Express Venting The Sunroof

To vent the sunroof, push TILT on the vent switch and release within one half second. The sunroof will open to the vent position regardless of its initial position. During Express Vent operation, any other actuation of the switch will stop the sunroof.

NOTE:

If the sunshade is in the closed position when Express/Manual Open or Vent operation is initiated, the sunshade will automatically open with the sunroof glass.

Pinch Protect Feature

This feature will detect an obstruction in the opening of the sunroof during Express Close operation. If an obstruction in the path of the sunroof is detected, the sunroof will automatically retract. Remove the obstruction if this occurs.

NOTE:

If three consecutive sunroof close attempts result in Pinch Protect reversals, Pinch Protect will disable and the sunroof must be closed in Manual Mode.

Sunshade Operation

The sunshade can be opened manually. However, the sunshade will open automatically as the sunroof opens.

NOTE:

The sunshade cannot be closed if the sunroof is open.

Ignition Off Operation

The power sunroof switch will remain active for up to approximately 10 minutes after the ignition switch is placed in the OFF position. Opening either front door will cancel this feature.

NOTE:

Ignition Off timing is programmable through the Uconnect system → page 169.

Sunroof Maintenance

Use only a non-abrasive cleaner and a soft cloth to clean the glass panel. Periodically check for and clear out any debris that may have collected in the tracks.

DUAL PANE POWER SUNROOF — IF EQUIPPED

The power sunroof switches are located on the overhead console between the courtesy/reading lights.



Power Sunroof Switches

- 1 — Opening/Closing Sunroof
- 2 — Venting Sunroof
- 3 — Opening/Closing Sunshade

WARNING!

- Never leave children unattended in a vehicle, or with access to an unlocked vehicle. Never leave the key fob in or near the vehicle, or in a location accessible to children. Do not leave the Keyless Enter 'n Go™ Ignition in the ON/RUN position. Occupants, particularly unattended children, can become entrapped by the power sunroof while operating the power sunroof switch. Such entrapment may result in serious injury or death.
- In a collision, there is a greater risk of being thrown from a vehicle with an open sunroof. You could also be seriously injured or killed. Always fasten your seat belt properly and make sure all passengers are also properly secured.
- Do not allow small children to operate the sunroof. Never allow your fingers, other body parts, or any object, to project through the sunroof opening. Injury may result.

Opening And Closing The Sunroof

The sunroof has two programmed automatic stops for the sunroof open position: a comfort stop position and a full open position. The comfort stop position will minimize wind buffeting in the interior.

Express Open/Close

To open the sunroof, push OPEN on the sunroof switch and release it within one-half second. The sunroof will open to the comfort stop position and stop automatically. Push and release OPEN again to continue to the full open position.

To close the sunroof, push CLOSE on the sunroof switch and release it within one-half second. The sunroof will close automatically from any position.

During Express Open or Express Close operation, any other actuation of the sunroof switch will stop the sunroof.

Manual Open/Close

To open the sunroof, push and hold OPEN on the sunroof switch. The sunroof will open to the comfort stop position, then automatically stop. Release the switch then push and hold again to continue to the full open position.

To close the sunroof, push and hold CLOSE on the sunroof switch.

Any release of the switch during open or close operation will stop the sunroof movement in a partially open position.

Express Venting The Sunroof

To vent the sunroof, push TILT on the vent switch and release within one half second. The sunroof will open to the vent position regardless of its initial position. During Express Vent operation, any other actuation of the switch will stop the sunroof.

NOTE:

If the sunshade is in the closed position when Express/Manual Open or Vent operation is initiated, the sunshade will automatically open to the half open position prior to the sunroof opening.

Opening And Closing The Power Sunshade

The sunshade has two programmed open positions: half open and full open positions. When operating the sunshade from the closed position, the sunshade will always stop at the half open position regardless of express or manual open operation. The switch must be pushed again to continue on to full open position.

If the sunroof is open or vented, the sunshade cannot be closed beyond the half open position. Pushing the sunshade close switch when the sunroof is open/vented and the sunshade is at half open position will first automatically close the sunroof prior to the sunshade closing.

Express Open/Close

To open the sunshade, push OPEN on the sunshade switch and release it within one-half second, the sunshade will open to the half open position and stop automatically. Push and release OPEN again to continue to open the sunshade to the full open position.

To close the sunshade, push CLOSE on the sunshade switch and release it within one-half second.

During Express Open or Express Close operation, any other actuation of the sunroof switches will stop the sunshade in a partially open position.

Manual Open/Close

To open the sunshade, push and hold OPEN on the sunshade switch, the sunshade will open to the half open position and stop automatically. Push and hold OPEN again to continue to open the sunshade to the full open position.

To close the sunshade, push and hold CLOSE on the sunshade switch.

Releasing the switch while the sunshade is in motion will stop the sunshade in a partially open position.

Pinch Protect Feature

This feature will detect an obstruction in the opening of the sunroof during Express Close operation. If an obstruction in the path of the sunroof is detected, the sunroof will automatically retract. Remove the obstruction if this occurs.

NOTE:

If three consecutive sunroof close attempts result in Pinch Protect reversals, Pinch Protect will disable and the sunroof must be closed in Manual Mode.

Ignition Off Operation

The power sunroof switch will remain active for up to approximately 10 minutes after the ignition switch is placed in the OFF position. Opening either front door will cancel this feature.

NOTE:

Ignition Off timing is programmable through the Uconnect system  page 169.

Sunroof Maintenance

Use only a non-abrasive cleaner and a soft cloth to clean the glass panel. Periodically check for and clear out any debris that may have collected in the tracks.

HOOD

OPENING THE HOOD

To open the hood, two latches must be released.

1. Pull the release lever located at the bottom of the driver's side of the instrument panel.



Hood Release

- Reach under the hood from outside the vehicle, move the safety latch to the left and lift the hood.

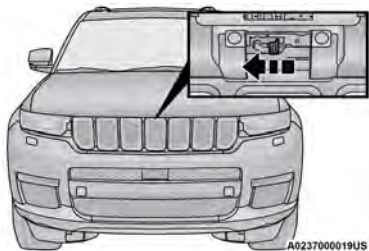

Safety Latch Location

NOTE:

- Vehicle must be at a stop and the gear selector must be in PARK.
- While lifting the hood, use both hands.
- Before lifting the hood, check that the wiper arms are not in motion and not in the lifted position.

CLOSING THE HOOD

In one continuous motion, pull down on the front edge of the hood with moderate force until the angle is below the crossover point (where the gas props are no longer resisting) and let the hood continue to fall closed from its own inertia.

WARNING!

Be sure the hood is fully latched before driving your vehicle. If the hood is not fully latched, it could open when the vehicle is in motion and block your vision. Failure to follow this warning could result in serious injury or death.

**LIFTGATE
TO UNLOCK/OPEN THE LIFTGATE**

The power liftgate may be opened by pushing the liftgate button on the key fob or by pushing the electronic liftgate release button.

Push the liftgate button on the key fob twice within five seconds to open the power liftgate. Once the liftgate is open, pushing the button twice within five seconds a second time will close the liftgate.

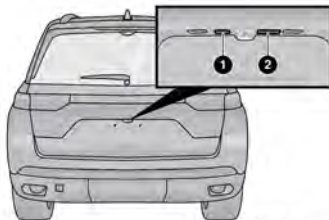

Liftgate Entry

- Passive Entry Button
- Electronic Liftgate Release Button

NOTE:

When you push the electronic liftgate release button, either only the liftgate will unlock, or all the doors and the liftgate will unlock, depending on the selected setting in the Uconnect system → page 169.

NOTE:

- Use the power door lock switch on either front door trim panel or the key fob to lock and unlock the liftgate.
- The driver's door lock cylinder will not lock or unlock the liftgate.

WARNING!

Driving with the liftgate open can allow poisonous exhaust gases into your vehicle. You and your passengers could be injured by these fumes. Keep the liftgate closed when you are operating the vehicle.

NOTE:

The liftgate can also be opened manually by pushing the electronic liftgate release button and pulling upward in one fluid motion.

TO LOCK/CLOSE THE LIFTGATE

There are several different ways to close the liftgate:

- Manually (grab the liftgate closing handle and pull in a downward motion)
- Key fob
- Hands-free (if equipped)
- Liftgate close button in the cargo area

With a valid Passive Entry key fob within 5 ft (1.5 m) of the liftgate, pushing the Passive Entry button located to the left of the electronic liftgate release button, will lock the vehicle only.

If the liftgate is fully open, the liftgate can be closed by pushing the liftgate close button located in the cargo area on the left rear trim panel, near the liftgate opening. If the liftgate is in motion, pushing the liftgate close button a second time will reverse the liftgate operation.

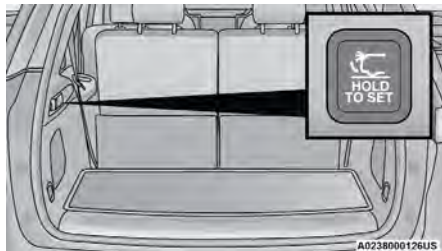

Liftgate Close Button

ADJUSTABLE POWER LIFTGATE HEIGHT

The maximum height that the liftgate will open can be adjusted and saved so that the liftgate will only open to the desired height. To set a desired height, proceed as follows:

1. Open the liftgate fully, then manually pull down on the liftgate to the desired height.
2. Push and hold the liftgate close button, located on the left side trim panel inside the cargo area, for three seconds. An audible chime will be emitted to let you know the height has been saved.

To set the saved height setting to a new setting, proceed as follows:

1. Open the liftgate, then manually push the liftgate upward to its full open position.
2. Manually pull the liftgate down to the new desired height and hold the liftgate close button for three seconds until the audible chime is emitted.

Power Liftgate Malfunction Procedure:

1. In the event of a power malfunction to the liftgate, the liftgate can be released by accessing the service release feature in the latch. This can be done using a 3 mm diameter screwdriver.

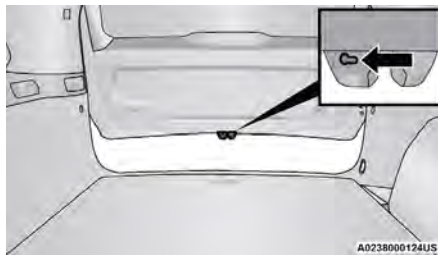

Liftgate Service Release

2. From inside the gate, an eyelet can be seen. Place the screwdriver in the eyelet.
3. Rotate the screwdriver handle to actuate the lever and release the latch.
4. If liftgate is left open for an extended period of time, the liftgate may need to be closed manually to reset power liftgate functionality.

HANDS-FREE LIFTGATE — IF EQUIPPED



A023800065US

Hands-Free Liftgate Activation Zone

To open or close the liftgate using hands-free activation, use a straight in and out kicking motion under the vehicle activation zone in the general location below the rear license plate. The activation zone is about 1.8 ft (0.5 m) from side to side. Do not move your foot sideways or in a sweeping motion or the sensors may not detect the motion.

NOTE:

The activation zone is the same for vehicles equipped with or without a trailer tow package.

When a valid kicking motion is completed, the liftgate will chime, the hazard lights will flash and the liftgate will open after approximately one second, or close after approximately three seconds. These settings can be enabled or disabled through Uconnect Settings

➔ page 169.

NOTE:

- Opening or closing the Hands-Free Liftgate requires a valid Passive Entry key fob within 5 ft (1.5 m) of the liftgate handle. If a valid Passive Entry key fob is not within 5 ft (1.5 m), the liftgate will not respond to any kicks.
- The Hands-Free Liftgate feature may be turned on or off through the Uconnect system ↗ page 169.
- The Hands-Free Liftgate feature should be turned off during jacking, tire changing, manual car wash, and vehicle service.
- The Hands-Free Liftgate feature can be activated by any metallic object making a similar in-and-out motion under the rear fascia/bumper, such as cleaning using a metal broom.
- The Hands-Free Liftgate will only operate when the transmission is in PARK.
- If anything obstructs the Hands-Free Liftgate while it is opening or closing, the liftgate will automatically reverse to the closed/open position, provided it meets sufficient resistance.
- There are pinch sensors attached to the side of the liftgate opening. Light pressure anywhere along these strips will cause the liftgate to return to the open position.
- If the power liftgate encounters multiple obstructions within the same cycle, the system will automatically stop. If this occurs, the liftgate must be operated manually.
- The power liftgate will release, but not power open, in temperatures below -12°F (-24°C). Be sure to remove any buildup of snow or ice from the liftgate before opening the liftgate.

- If the liftgate is left open for an extended period of time (approximately one hour), the liftgate may need to be closed manually to reset power liftgate functionality.

WARNING!

- Driving with the liftgate open can allow poisonous exhaust gases into your vehicle. You and your passengers could be injured by these fumes. Keep the liftgate closed when you are operating the vehicle.
- If you are required to drive with the liftgate open, make sure that all windows are closed, and the climate control blower switch is set at high speed. Do not use the recirculation mode.

Gas props support the liftgate in the open position. However, because the gas pressure drops with temperature, it may be necessary to assist the props when opening the liftgate in cold weather.

NOTE:

Allow the power system to open the liftgate. Manually pushing or pulling the liftgate may activate the liftgate obstacle detection feature and stop the power operation or reverse its direction.

WARNING!

During power operation, personal injury or cargo damage may occur. Ensure the liftgate travel path is clear. Make sure the liftgate is closed and latched before driving away.

CARGO AREA FEATURES**Cargo Storage**

The load floor is designed for a maximum load of 300 lb (136 kg).

If equipped, there may be a removable storage bin located on the left side of the rear cargo area.

Additional storage can be found under the storage lid. To access the lower storage, lift the handle and raise the storage lid.



Lift Storage Lid Handle

Cargo Tie-Down Hooks

The cargo tie-downs, located on the cargo area sides, should be used to safely secure loads when the vehicle is moving.

NOTE:

The cargo tie-downs are designed for a maximum load of 300 lb (136 kg).

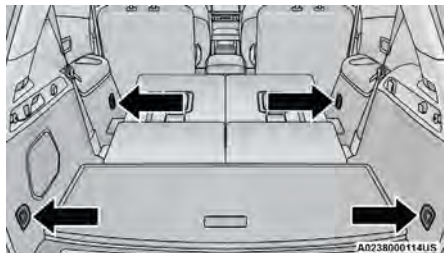

Tie-Down Hooks (Vehicles With Third Row Seating)

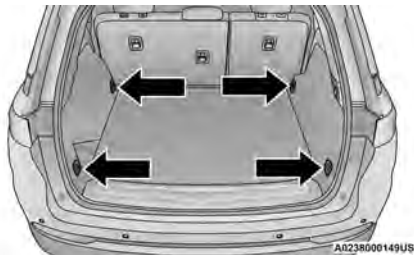

Tie-Down Hooks (Vehicles Without Third Row Seating)

WARNING!

- Cargo tie-downs are not safe anchors for a child seat tether strap. In a sudden stop or accident, a tie-down could pull loose and allow the child seat to come loose. A child could be badly injured. Use only the anchors provided for child seat tethers.
- To help protect against personal injury, passengers should not be seated in the rear cargo area. The rear cargo space is intended for load carrying purposes only, not for passengers, who should sit in seats and use seat belts.

The weight and position of cargo and passengers can change the vehicle center of gravity and vehicle handling. To avoid loss of control resulting in personal injury, follow these guidelines for loading your vehicle:

- Do not carry loads that exceed the load limits described on the label attached to the left door or left door center pillar.
- Always place cargo evenly on the cargo floor. Put heavier objects as low and as far forward as possible.
- Place as much cargo as possible in front of the rear axle. Too much weight or improperly placed weight over or behind the rear axle can cause the vehicle to sway.
- Do not pile luggage or cargo higher than the top of the seatback. This could impair visibility or become a dangerous projectile in a sudden stop or accident.

Retractable Cargo Area Cover — If Equipped

The purpose of this cover is for privacy, not to secure loads. It will not prevent cargo from shifting or protect passengers from loose cargo.

To cover the cargo area:

1. Grab the cover at the center handle and pull over the cargo area.
2. Insert the pins on the ends of the cover into the slots in the pillar trim cover.
3. The liftgate may be opened with the cargo cover in place.

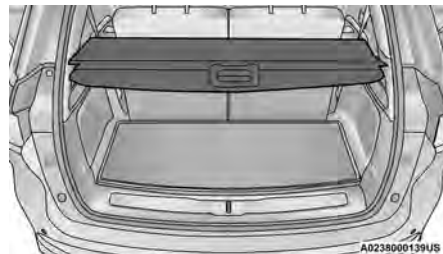

Rear Cargo Cover

WARNING!

In a collision, a loose cargo cover in the vehicle could cause injury. It could fly around in a sudden stop and strike someone in the vehicle. Do not store the cargo cover on the cargo floor or in the passenger compartment. Remove the cover from the vehicle when taken from its mounting. Do not store it in the vehicle.

Foldable Cargo Area Cover — If Equipped

The purpose of this cover is for privacy, not to secure loads. It will not prevent cargo from shifting or protect passengers from loose cargo.

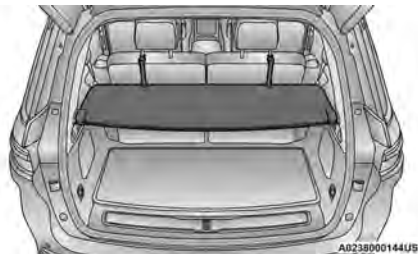
**Foldable Cargo Area Cover**

To cover the cargo area:

1. Remove the folded cover from the storage pouch, and unfold using a twisting motion.
2. Insert the pins on the ends of the cover into the slots on each side of the pillar trim.

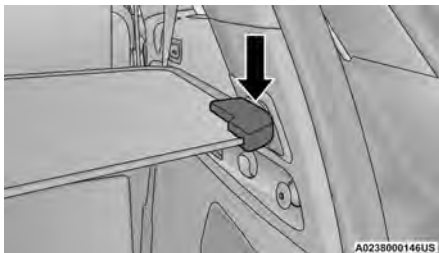
**Step 2**

3. Hook the straps to the outside post of the rear head restraint on each side.

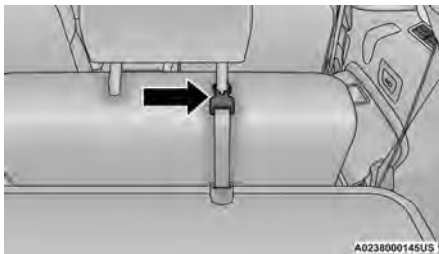
**Step 3****NOTE:**

The liftgate may be opened with the cargo cover in place.

To store the foldable cargo area cover, reverse the installation steps and replace the cover into its storage pouch.

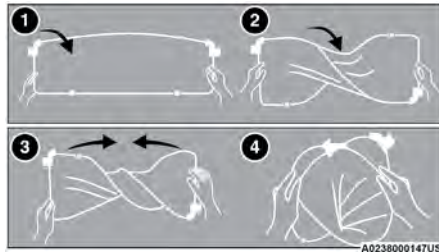
**Folding The Cargo Cover**

- 1 — Remove Cover From Vehicle
- 2 — Twist Cover
- 3 — Push Twisted Cover Inward
- 4 — Place Folded Cover In Pouch

WARNING!

In a collision, a loose cargo cover in the vehicle could cause injury. It could fly around in a sudden stop and strike someone in the vehicle. Do not store the cargo cover on the cargo floor or in the passenger compartment. Remove the cover from the vehicle when taken from its mounting. Do not store it in the vehicle.

ROOF LUGGAGE RACK — IF EQUIPPED

The crossbars and siderails are designed to carry loads on vehicles equipped with a luggage rack. The load must not exceed 150 lb (68 kg), and should be uniformly distributed over the luggage rack crossbars.

NOTE:

See an authorized dealer to order and install Mopar® crossbars built specifically for this roof rack system.

Distribute cargo weight evenly on the roof rack crossbars. The roof rack does not increase the total load carrying capacity of the vehicle. Be sure the total load of cargo inside the vehicle plus that on the external rack does not exceed the maximum vehicle load capacity. Place one crossbar in the forward position. Place the rear crossbar in one of the two rear optional positions based on the load being secured.

To move the crossbars, loosen the attachments, located at the upper edge of each crossbar, approximately eight turns using the anti-theft wrench provided with the Mopar® crossbars. Then, move the crossbar to the desired position, keeping the crossbars parallel to the rack frame. Once the crossbar is in the desired position, retighten with the wrench to lock the crossbar into position.

NOTE:

If any cargo (or any metallic object) is placed over the satellite radio antenna (if equipped), you may experience interruption of satellite radio reception. For improved satellite radio reception, place the rear crossbar in the forward of the two rear crossbar positions.

WARNING!

Cargo must be securely tied down before driving your vehicle. Improperly secured loads can fly off the vehicle, particularly at high speeds, resulting in personal injury or property damage. Follow the roof rack cautions when carrying cargo on your roof rack.

CAUTION!

- To prevent damage to the roof of your vehicle, do not carry any loads on the roof rack without the crossbars installed. The load should be secured and placed on top of the crossbars, not directly on the roof. If it is necessary to place the load on the roof, place a blanket or some other protection between the load and the roof surface.
- To avoid damage to the roof rack and vehicle, do not exceed the maximum roof rack load capacity of 150 lb (68 kg). Always distribute heavy loads as evenly as possible and secure the load appropriately.
- Long loads which extend over the windshield, such as wood panels or surfboards, or loads with large frontal area should be secured to both the front and rear of the vehicle.
- Travel at reduced speeds and turn corners carefully when carrying large or heavy loads on the roof rack. Wind forces, due to natural causes or nearby truck traffic, can add sudden upward lift to a load. This is especially true on large flat loads and may result in damage to the cargo or your vehicle.

(Continued)

CAUTION!

- The use of vehicle systems that would adjust the ride heights (such as Selec-Terrain modes Rock or Sand/Mud) is not recommended when using the Roof Luggage Rack to carry a load.

GETTING TO KNOW YOUR INSTRUMENT PANEL

DIGITAL INSTRUMENT CLUSTER



Holding the **OK** button on the Instrument Cluster Display controls located on the steering wheel will allow you to change your display from Digital to Analog.

Use this QR code to access your digital experience.



DIGITAL INSTRUMENT CLUSTER DESCRIPTIONS

1. Speedometer

- Indicates vehicle speed.

2. Temperature Gauge

- The temperature gauge shows engine coolant temperature. Any reading within the normal range indicates that the engine cooling system is operating satisfactorily.
- The pointer will likely indicate a higher temperature when driving in hot weather, up mountain grades, or when towing a trailer. It should not be allowed to exceed the upper limits of the normal operating range.

WARNING!

A hot engine cooling system is dangerous. You or others could be badly burned by steam or boiling coolant. It is recommended to call an authorized dealer for service if your vehicle overheats ↪ page 284.

CAUTION!

Driving with a hot engine cooling system could damage your vehicle. If the temperature gauge reads "H" pull over and stop the vehicle. Idle the vehicle with the air conditioner turned off until the pointer drops back into the normal range. If the pointer remains on the "H", turn the engine off immediately and call an authorized dealer for service.

3. Tachometer

- Indicates the engine speed in revolutions per minute (RPM x 1000).

4. Fuel Gauge

- The pointer shows the level of fuel in the fuel tank when the Keyless Push Button Ignition is in the ON/RUN position.
- The fuel pump symbol points to the side of the vehicle where the fuel door is located.



NOTE:

The Instrument Cluster Warning Indicators will illuminate briefly for a bulb check when the ignition is first cycled.

ANALOG INSTRUMENT CLUSTER



Holding the **OK** button on the Instrument Cluster Display controls located on the steering wheel will allow you to change your display from Analog to Digital.

ANALOG INSTRUMENT CLUSTER DESCRIPTIONS

1. Tachometer
 - Indicates the engine speed in revolutions per minute (RPM x 1000).
2. Speedometer
 - Indicates vehicle speed.
3. Temperature Gauge
 - The temperature gauge shows engine coolant temperature. Any reading within the normal range indicates that the engine cooling system is operating satisfactorily.
 - The pointer will likely indicate a higher temperature when driving in hot weather, up mountain grades, or when towing a trailer. It should not be allowed to exceed the upper limits of the normal operating range.

WARNING!

A hot engine cooling system is dangerous. You or others could be badly burned by steam or boiling coolant. It is recommended to call an authorized dealer for service if your vehicle overheats → page 284.

CAUTION!

Driving with a hot engine cooling system could damage your vehicle. If the temperature gauge reads "H" pull over and stop the vehicle. Idle the vehicle with the air conditioner turned off until the pointer drops back into the normal range. If the pointer remains on the "H", turn the engine off immediately and call an authorized dealer for service.

4. Fuel Gauge
 - The pointer shows the level of fuel in the fuel tank when the Keyless Push Button Ignition is in the ON/RUN position.
 - The fuel pump symbol points to the side of the vehicle where the fuel door is located.



NOTE:

The Instrument Cluster Warning Indicators will illuminate briefly for a bulb check when the ignition is first cycled.

INSTRUMENT CLUSTER DISPLAY

Depending on your vehicles trim level, features and options may vary.

Your vehicle will be equipped with an instrument cluster display, which offers useful information to the driver. With the ignition in the OFF mode, opening/closing of a door will activate the display for viewing, and display the total miles, or kilometers, in the odometer. Your instrument cluster display is designed to display important information about your vehicle's systems and features. Using a driver interactive display located on the instrument panel, your instrument cluster display can show

you how systems are working and give you warnings when they are not. The steering wheel mounted controls allow you to scroll through the main menus and submenus. You can access the specific information you want and make selections and adjustments.

LOCATION AND CONTROLS

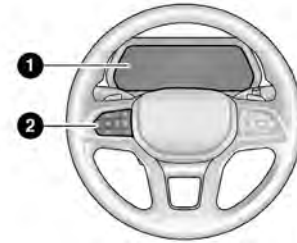

A0392000170US

Instrument Cluster Display/ Controls Location

- 1 - Instrument Cluster Display Screen
- 2 - Instrument Cluster Display Controls

The system allows the driver to select information by pushing the following buttons mounted on the steering wheel:

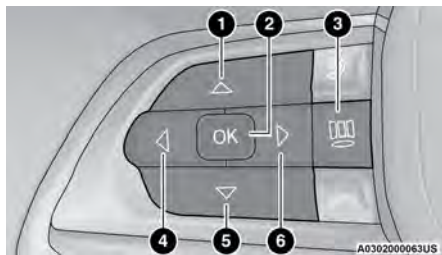

Instrument Cluster Display Control Buttons

- 1 – Up Arrow Button
- 2 – OK Button
- 3 – Menu Button
- 4 – Left Arrow Button
- 5 – Down Arrow Button
- 6 – Right Arrow Button

1. Up Arrow Button

Push and release the **up** \triangle arrow button to scroll upward through the main menu.

2. OK Button

Push the **OK** button to access/select the information screens or submenu screens of a main menu item. Push and hold the **OK** button for one second to reset displayed/selected features that can be reset.

3. Menu Button

Push the **Menu** button to access/select the information screens or submenu screens of the Home Screen display. Push and hold the **OK** button to enter edit mode.

4. Left Arrow Button

Push the **left** \triangleleft arrow button to return to the main menu from an info screen or submenu item.

5. Down Arrow Button

Push and release the **down** ∇ arrow button to scroll downward through the main menu.

6. Right Arrow Button

Push and release the **right** \triangleright arrow button to access the information screens or submenu screens of a main menu item.

Display Options

Holding **OK** will also allow you to change your display to Digital or Analog.

- Digital theme will be the default theme
- Menu screen times out after 10 seconds. Press **OK** to reactivate
- Speedometer must always be present
- Relevant warning notifications and other pop-up info will still be displayed in the main screen area (in this case the speed moves to the top)

Custom Tile Configuration

To customize the instrument cluster further, you are able to select up to five tiles to display information based on your needs.

- Press the **Menu** button for the Home Screen display.



Menu Button

- Navigate **Left** \triangleleft or **Right** \triangleright to highlight desired Tile.
- Press **OK** to select the tile and navigate to the selected submenu and press **OK** again to add your selection to your tile view.
- The Home Screen options are Driver Info, Vehicle Info, Navigation, Audio, and Off Road.

Home Screen

Press the **Menu** button to display the Home Screen.

Push and release the **left** ◀ or **right** ▶ arrow button to highlight the desired selection. Push and release the **OK** button to select. Press the **up** ▲ or **down** ▼ arrow button to select a different screen within the selected category. If the **Menu** button is pressed in this view, the instrument cluster will return to the previously displayed screen.

Home Screen Options

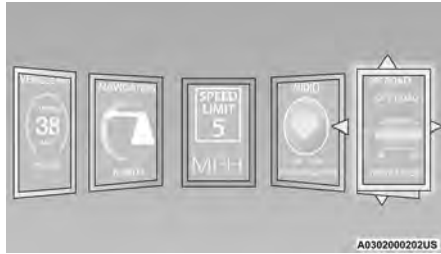

Custom Tile Screen

NOTE:

These options may vary based on your vehicle trim level.

- **Navigation — If Equipped**
 - Map Display
 - Trip A/B
- **Vehicle Info**
 - Coolant Temp
 - Trans Temp
 - Oil Temp
 - Oil Pressure

- Battery Voltage
- Oil Life
- Tire Pressure
- Fuel Economy
- **Driver Info — If Equipped**
 - Posted Speed Limit Sign
 - Driver Assist
- **Audio**
 - Audio Info
- **Off Road**
 - Selec-Terrain Status/ Air Suspension Status — If Equipped
 - Steering Angle
 - Pitch & Roll

ENGINE OIL LIFE RESET

Use this QR code to access your digital experience.

Oil Change Required

Your vehicle is equipped with an engine oil change indicator system. The “Oil Change Required” message will display in the instrument cluster display for five seconds after a single chime has sounded, to indicate the next scheduled oil change interval. The engine oil change indicator system is duty cycle based, which means the engine oil change interval may fluctuate, dependent upon your personal driving style.

Unless reset, this message will continue to display each time the ignition is placed in the ON/RUN position. To turn off the message temporarily, push and release the **OK** or arrow buttons. To reset the oil change indicator system (after performing the scheduled maintenance), refer to the following procedure.



Vehicles Equipped With Keyless Enter 'n Go™ Ignition

Use the steering wheel instrument cluster display controls for the following procedure(s):

1. Without pressing the brake pedal, push the ENGINE START/STOP button and place the ignition in the ON/RUN position (do not start the engine).
2. Push and release the **down** ▼ arrow button to scroll downward through the main menu to “Vehicle Info”.
3. Push and release the **right** ▶ arrow button to access the “Oil Life” screen.
4. Push and hold the **OK** button to reset oil life. If conditions are met, the gauge and numeric display will update to show 100%. If conditions are not met a pop-up message of “To reset oil life engine must be off with ignition in run” will be displayed (for five seconds), and the user will remain at the Oil Life screen.
5. Push and release the **up** ▲ or **down** ▼ arrow button to exit the submenu screen.

NOTE:

If the indicator message illuminates when you start the vehicle, the oil change indicator system did not reset. If necessary, repeat this procedure.

Secondary Method Of Resetting Engine Oil Life

1. Without pressing the brake pedal, push the ENGINE START/STOP button and place the ignition to the ON/RUN position (do not start the engine).
2. Fully press the accelerator pedal, slowly, three times within 10 seconds.
3. Without pushing the brake pedal, push the ENGINE START/STOP button once to return the ignition to the OFF position.

NOTE:

If the indicator message illuminates when you start the vehicle, the oil change indicator system did not reset. If necessary, repeat this procedure.

DISPLAY AND MESSAGES

The instrument cluster display is located in the center portion of the cluster and consist of multiple sections:

- Main Screen — The inner ring of the display will illuminate in black under normal conditions, yellow for noncritical warnings and red for critical warnings
- Submenu Dots — Whenever there are submenus available, the position within the submenus is shown here
- Reconfigurable Telltales/Information
- Gear Selector Status (PRND)

Includes the following, but not limited to:

Vehicle Speed is Too High to Shift to R	Front Seat Belts Unbuckled	Driver Seat Belt Unbuckled
Doors Open	Passenger Seat Belt Unbuckled	Traction Control Off
Vehicle Speed Too High To Shift to D	Washer Fluid Low	Oil Pressure Low
Hood Open	Oil Change Due	Fuel Low
Shift Not Allowed	Service Anti-lock Brake System	Service Electronic Throttle Control
Service Shifter	Service Power Steering	Cruise Off
Vehicle Speed is Too High to Shift to P	Cruise Ready	ACC Override
Service Transmission	Cruise Set To XXX mph or km/h	Close Fuel Door
Liftgate Open	Vehicle Not In Park	Service Tire Pressure System
Door Open	Park Brake Engaged	Brake Fluid Low

- Driver Interactive Display (Compass, Temp, Range to Empty, Trip A, Trip B, Average Fuel Economy, Current Fuel Economy and Time)

- Air Suspension Status — If Equipped
- Four-Wheel Drive (4WD) Status — If Equipped

The instrument cluster display will normally display the main menu or the screens of a selected feature of the main menu. The main display area also displays pop-up messages and warning or information messages. These pop-up messages fall into several categories:

- **Five Second Stored Messages**

When the appropriate conditions occur, this type of message takes control of the main display area for five seconds and then returns to the previous screen. Most of the messages of this type are then stored (as long as the condition that activated it remains active) and can be reviewed from the "Messages" main menu item. Examples of this message type are "Right Front Turn Signal Lamp Out" and "Low Tire Pressure".

- **Unstored Messages**

This message type is displayed indefinitely or until the condition that activated the message is cleared. Examples of this message type are "Turn Signal On" (if a turn signal is left on) and "Lights On" (if driver leaves the vehicle with the lights on).

- **Unstored Messages Until RUN**

These messages deal primarily with the Remote Start feature. This message type is displayed until the ignition is in the RUN state. Examples of this message type are "Remote Start Canceled - Door Ajar" and "Press Brake Pedal and Push Button to Start".

- **Five Second Unstored Messages**

When the appropriate conditions occur, this type of message takes control of the main display area for five seconds and then returns to the previous screen. An example of this message type is "Automatic High Beams On".

Service Air Bag Warning Light	Lights On	Engine Temperature Hot
Remote Start Disabled Start To Reset	Right Front Turn Signal Light Out	Right Rear Turn Signal Light Out
Service Air Bag System	Left Front Turn Signal Light Out	Left Rear Turn Signal Light Out
Remote Start Canceled Liftgate Open	Ignition On	Check The Rear Seat
Remote Start Canceled Time Expired	Remote Start Active Push Start Button	Remote Start Canceled Fuel Low
Remote Start Canceled Hood Open	Remote Start Canceled Door Open	

The Reconfigurable Telltales section is divided into the white or yellow telltales area on the left, and the green or red telltales area on the right.

INSTRUMENT CLUSTER DISPLAY MENU ITEMS

The instrument cluster display can be used to view the main menu items for several features. Use the **up** Δ and **down** ∇ arrow buttons to scroll through the driver interactive display menu options until the desired menu is reached.

NOTE:

Depending on the vehicle's options, feature settings may vary.

Main Menu

DRIVER INFO

Push and release the **up** Δ or **down** ∇ arrow button until the Drive menu title is displayed in the instrument cluster display.

Speedometer

Push and release the **up** Δ or **down** ∇ arrow button until the Speedometer menu title is displayed in the instrument cluster display. Push and release the **OK** button to toggle units (mph or km/h) of the speedometer. Hold the **OK** button to toggle between Analog and Digital speedometer.

Night Vision — If Equipped



While viewing the Speedometer menu title, push and release the **left** \triangleleft or **right** \triangleright arrow button until the Night Vision menu title is displayed in the instrument cluster display.

Pedestrian/Animal icons will be displayed in the top left location \rightarrow page 150.

Driver Assist — If Equipped

While viewing the Speedometer menu title, push and release the **left** \triangleleft or **right** \triangleright arrow button until the Driver Assist menu title is displayed in the instrument cluster display. The Driver Assist screen indicates the current status of ACC, Active Lane Management and Active Driving Assist/Assist+/Pilot. Push and release the **OK** button again to change between Zoomed In and Zoomed Out view ("Press OK to Zoom In" will display when in Zoomed Out view/"Press OK to Zoom Out" will display when in Zoomed In view).

VEHICLE INFO

Push and release the **up** Δ or **down** ∇ arrow button until the Vehicle Info title is highlighted in the instrument cluster display. Push the **left** \triangleleft or **right** \triangleright arrow button to scroll through the information submenus.

Fuel Economy

- Average Fuel Economy
- Current Fuel Economy
- Range To Empty
- Press the **OK** button to reset the average fuel economy

NOTE:

The Range feature is not able to be reset through the instrument cluster display controls.

Gauge Summary

- **Coolant Temperature — If Equipped**
Displays the current temperature of the coolant.
- **Transmission Temperature**
Displays the actual transmission temperature.
- **Oil Temperature**
Displays the actual oil temperature.
- **Oil Pressure**
Displays the actual oil pressure.
- **Battery Voltage**
Displays the current voltage level of the battery.

Oil Life

- Displays the current oil life of the vehicle.

Tire Pressure Monitor System

- If tire pressure is **OK** for all tires a vehicle icon is displayed with tire pressure values in each corner of the icon.
- If one or more tires have low pressure, “Inflate Tire To XX” is displayed with the vehicle icon and the tire pressure values in each corner of the icon with the pressure value of the low tire are displayed in a different color than the other tire pressure value.
- If the Tire Pressure system requires service, “Service Tire Pressure System” is displayed.

Tire Pressure is an information only function, and cannot be reset → page 218.

Stop/Start Status — If Equipped

- Display current status of Stop/Start system.

TRIP

Push and release the **up** ▲ or **down** ▼ arrow button until the Trip menu title is displayed in the instrument cluster display. Toggle the **left** ◀ or **right** ▶ arrow button to select Trip A or Trip B. The Trip information will display the following:

- **Distance** – Shows the total distance (mi or km) traveled for Trip A or Trip B since the last reset.
- **Average Fuel Economy** – Shows the average fuel economy (MPG or L/100 km or km/L) of Trip A or Trip B since the last reset.
- **Elapsed Time** – Shows the total elapsed time of travel since Trip A or Trip B has been reset.

Hold the **OK** button to reset feature information.

NAVIGATION — IF EQUIPPED

Push and release the **up** ▲ or **down** ▼ arrow button until the Navigation display title is highlighted in the instrument cluster display.

OFF ROAD — IF EQUIPPED

Push and release the **up** ▲ or **down** ▼ arrow button until the Off Road Menu title is highlighted. Push the **left** ◀ or **right** ▶ arrow button to scroll the submenus.

- **Terrain Status — If Equipped**
 - Selec-Terrain Status
 - Air Suspension Status
- **Vehicle Dynamics**
 - Wheel Articulation
 - Transfer Case Status — If Equipped
 - Steering Angle
 - Sway Bar Status — If Equipped
 - Axle Lock Status — If Equipped
- **Pitch And Roll**
 - Vehicle Pitch
 - Vehicle Roll

AUDIO

Push and release the **up** ▲ or **down** ▼ arrow button until the Audio Menu title is highlighted in the instrument cluster display. This menu will display the audio source information, including the Song name, Artist name, and audio source with an accompanying graphic.

STORED MESSAGES

Push and release the **up** ▲ or **down** ▼ arrow button until the Messages Menu item is highlighted. This feature shows the number of stored warning messages. Pushing the **left** ◀ or **right** ▶ arrow button will allow you to see what the stored messages are.

SETTINGS

NOTE:

The Head Up Display (HUD) – If Equipped feature Settings are available at any vehicle speed → page 91.

Screen Setup

Push and release the **up** ▲ or **down** ▼ arrow button until the Settings Menu title is highlighted in the instrument cluster display. Push and release the **OK** button to enter the submenus and follow the prompts on the screen as needed. The Settings feature allows you to change what information is displayed in the instrument cluster as well as the location that information is displayed.

Upper Left or Upper Right		
None	Fuel Economy Current	Time
Outside Temp	Trip B Distance	Fuel Economy Average
Range To Empty (RTE)	Compass	Trip A Distance

Current Gear

- On
- Off

Odometer

- Show
- Hide

Favorite Menus		
Driver Info	Trip (Show/Hide)	Off Road (Show/Hide)
Vehicle Info	Navigation (Show/Hide) — If Equipped	Messages
Audio (Show/Hide)	Settings	HUD

NOTE:

Menus with (show/hide) can push the **OK** button to choose whether to show or hide this menu on the instrument cluster display.

Defaults (Restores All Settings To Default Settings)

- Restore
- Cancel

HEAD UP DISPLAY (HUD) — IF EQUIPPED

Use this QR code to access your digital experience.

**NOTE:**

The HUD feature Settings are available at any vehicle speed. Some information like speed limit or Driver Assist may not appear on the HUD unless your vehicle is equipped Traffic Sign Assist or Driver Assist systems.

Push and release the **up** Δ or **down** ∇ arrow button until the Settings Menu icon/title is highlighted in the instrument cluster display. Push and release the **left** \triangleleft or **right** \triangleright arrow button until the HUD Menu icon/title is highlighted in the instrument cluster display. Push and release the **OK** button to enter HUD. Use the **up** Δ or **down** ∇ arrow button to select a setting, then push and release the **OK** button to adjust the setting.

- ON/OFF

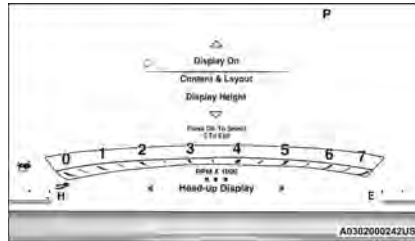
**HUD ON/OFF**

When “Display On” is selected, the HUD will display on the windshield. When it is not selected, it will not display on the windshield.

- Content and Layout
 - **Simple:** Speed, Speed Limit
 - **Standard:** Speed, Speed Limit, Navigation

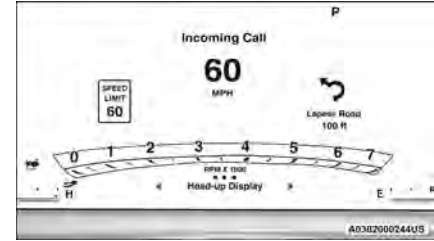
**Standard Mode**

When “Standard” mode is selected, the HUD image is split into thirds with the speed limit indicator shown to the left, vehicle speed in the center, and turn-by-turn navigation to the right.

- **Advanced:** Speed, Speed Limit, Navigation, Driver Assist (ACC/Cruise, Active Lane Management, Active Driving Assist), Gear (available in Sport mode)



Advanced Mode

When “Advanced” mode is selected, the HUD displays the vehicle speed, turn-by-turn navigation, speed limit, driver assist function(s), and current gear.

- **Custom 1:** Speed, Speed Limit
- **Custom 2:** Speed, Speed Limit, Navigation
- **Custom 3:** Speed, Speed Limit, Navigation, Driver Assist (ACC/Cruise, Active Lane Management, Active Driving Assist)
- **Custom 4:** Speed, Speed Limit, Navigation, Driver Assist (ACC/Cruise, Active Lane Management, Active Driving Assist), Gear (available in Sport mode)
- Display Height
- Brightness

NOTE:

- The HUD basic settings (Brightness, Display Height and Non Custom layouts), are controlled through the Settings Screen in the Instrument Cluster
➔ page 85.

NOTE:

If current theme is set to Digital, tachometer will not display while in the Settings menu.

BATTERY SAVER ON/BATTERY SAVER MODE MESSAGE – ELECTRICAL LOAD REDUCTION ACTIONS – IF EQUIPPED

This vehicle is equipped with an Intelligent Battery Sensor (IBS) to perform additional monitoring of the electrical system and status of the vehicle battery.

In cases when the IBS detects charging system failure, or the vehicle battery conditions are deteriorating, electrical load reduction actions will take place to extend the driving time and distance of the vehicle. This is done by reducing power to or turning off non-essential electrical loads.

Load reduction is only active when the engine is running. It will display a message if there is a risk of battery depletion to the point where the vehicle may stall due to lack of electrical supply, or will not restart after the current drive cycle.

When load reduction is activated, the message “Battery Saver On” or “Battery Saver Mode” will appear in the instrument cluster.

These messages indicate the vehicle battery has a low state of charge and continues to lose electrical charge at a rate that the charging system cannot sustain.

NOTE:

- The charging system is independent from load reduction. The charging system performs a diagnostic on the charging system continuously.
- If the Battery Charge Warning Light is on it may indicate a problem with the charging system
➔ page 94.

The electrical loads that may be switched off (if equipped), and vehicle functions which can be affected by load reduction:

- Heated Seat/Vented Seats/Heated Wheel
- Rear Defroster And Heated Mirrors
- HVAC System
- 115 Volt AC Power Inverter System
- Audio and Telematics System

Loss of the battery charge may indicate one or more of the following conditions:

- The charging system cannot deliver enough electrical power to the vehicle system because the electrical loads are larger than the capability of the charging system. The charging system is still functioning properly.
- Turning on all possible vehicle electrical loads (e.g. HVAC to max settings, exterior and interior lights, overloaded power outlets +12 Volt, 115 Volt AC, USB ports) during certain driving conditions (city driving, towing, frequent stopping, etc.).
- Installing options like additional lights, upfitter electrical accessories, audio systems, alarms and similar devices.
- Unusual driving cycles (short trips separated by long parking periods).
- The vehicle was parked for an extended period of time (weeks, months).
- The battery was recently replaced and was not charged completely.
- The battery was discharged by an electrical load left on when the vehicle was parked.
- The battery was used for an extended period with the engine not running to supply radio, lights, chargers, +12 Volt portable appliances like vacuum cleaners, game consoles and similar devices.

What to do when an electrical load reduction action message is present (“Battery Saver On” or “Battery Saver Mode”)

During a trip:

- Reduce power to unnecessary loads if possible:
 - Turn off redundant lights (interior or exterior)
 - Check what may be plugged in to power outlets +12 Volt, 115 Volt AC, USB ports
 - Check HVAC settings (blower, temperature)
 - Check the audio settings (volume)

After a trip:

- Check if any aftermarket equipment was installed (additional lights, upfitter electrical accessories, audio systems, alarms) and review specifications if any (load and Ignition Off Draw currents).
- Evaluate the latest driving cycles (distance, driving time and parking time).
- The vehicle should have service performed if the message is still present during consecutive trips, and if the evaluation and driving pattern of the vehicle did not help to identify the cause.

WARNING LIGHTS AND MESSAGES

The warning/indicator lights will illuminate in the instrument panel together with a dedicated message and/or acoustic signal when applicable. These indications are indicative and precautionary and as such must not be considered as exhaustive and/or alternative to the information contained in the Owner’s Manual, which you are advised to read carefully in all cases. Always refer to the information in this chapter in the event of a failure indication. All active telltales will display first if applicable. The system check menu may appear different based upon equipment options and current vehicle status. Some telltales are optional and may not appear

RED WARNING LIGHTS

Active Driving Assist - Driver Inattentiveness Warning Light



This light illuminates when driver inattentiveness has been continually detected, warning the driver to place their hands on the steering wheel.

Air Bag Warning Light



This warning light will illuminate to indicate a fault with the air bag, and will turn on for four to eight seconds as a bulb check when the ignition is placed in the ON/RUN position. This light will illuminate with a single chime when a fault with the air bag has been detected, it will stay on until the fault is cleared. If the light is either not on during startup, stays on, or turns on while driving, have the system inspected at an authorized dealer as soon as possible.

Brake Warning Light



This warning light monitors various brake functions, including brake fluid level and parking brake application. If the brake light turns on it may indicate that the parking brake is applied, that the brake fluid level is low, or that there is a problem with the Anti-Lock Brake System reservoir.

If the light remains on when the parking brake has been disengaged, and the fluid level is at the full mark on the master cylinder reservoir, it indicates a possible brake hydraulic system malfunction or that a problem with the Brake Booster has been detected by the Anti-Lock Brake System (ABS) / Electronic Stability Control (ESC) system. In this case, the light will remain on until

the condition has been corrected. If the problem is related to the brake booster, the ABS pump will run when applying the brake, and a brake pedal pulsation may be felt during each stop.

The dual brake system provides a reserve braking capacity in the event of a failure to a portion of the hydraulic system. A leak in either half of the dual brake system is indicated by the Brake Warning Light, which will turn on when the brake fluid level in the master cylinder has dropped below a specified level.

The light will remain on until the cause is corrected.

NOTE:

The light may flash momentarily during sharp cornering maneuvers, which change fluid level conditions. The vehicle should have service performed, and the brake fluid level checked.

If brake failure is indicated, immediate repair is necessary.

WARNING!

Driving a vehicle with the red brake light on is dangerous. Part of the brake system may have failed. It will take longer to stop the vehicle. You could have a collision. Have the vehicle checked immediately.

Vehicles equipped with the Anti-Lock Brake System (ABS) are also equipped with Electronic Brake Force Distribution (EBD). In the event of an EBD failure, the Brake Warning Light will turn on along with the ABS Light. Immediate repair to the ABS system is required.

Operation of the Brake Warning Light can be checked by turning the ignition switch from the OFF position to the ON/RUN position. The light should illuminate for approximately two seconds. The light should then turn

off unless the parking brake is applied or a brake fault is detected. If the light does not illuminate, have the light inspected by an authorized dealer.

The light also will turn on when the parking brake is applied with the ignition switch in the ON/RUN position.

NOTE:

This light shows only that the parking brake is applied. It does not show the degree of brake application.

Battery Charge Warning Light



This warning light will illuminate when the battery is not charging properly. If it stays on while the engine is running, there may be a malfunction with the charging system. Contact an authorized dealer as soon as possible.

This indicates a possible problem with the electrical system or a related component.

Door Open Warning Light



This indicator will illuminate when a door is ajar/open and not fully closed.

NOTE:

If the vehicle is moving, there will also be a single chime.

Electric Power Steering (EPS) Fault Warning Light



This warning light will turn on when there's a fault with the EPS system → page 119.

WARNING!

Continued operation with reduced assist could pose a safety risk to yourself and others. Service should be obtained as soon as possible.

Electronic Throttle Control (ETC) Warning Light



This warning light will illuminate to indicate a problem with the ETC system. If a problem is detected while the vehicle is running, the light will either stay on or flash depending on the nature of the problem. Cycle the ignition when the vehicle is safely and completely stopped and the transmission is placed in the PARK position. The light should turn off. If the light remains on with the vehicle running, your vehicle will usually be drivable; however, see an authorized dealer for service as soon as possible.

NOTE:

This light may turn on if the accelerator and brake pedals are pressed at the same time.

If the light continues to flash when the vehicle is running, immediate service is required and you may experience reduced performance, an elevated/rough idle, or engine stall and your vehicle may require towing. The light will come on when the ignition is placed in the ON/RUN position and remain on briefly as a bulb check. If the light does not come on during starting, have the system checked by an authorized dealer.

Engine Coolant Temperature Warning Light



This warning light warns of an overheated engine condition. If the engine coolant temperature is too high, this indicator will illuminate and a single chime will sound. If the temperature reaches the upper limit, a continuous chime will sound for four minutes or until the engine is able to cool; whichever comes first.

If the light turns on while driving, safely pull over and stop the vehicle. If the Air Conditioning (A/C) system is on, turn it off. Also, shift the transmission into NEUTRAL (N) and idle the vehicle. If the temperature reading does not return to normal, turn the engine off immediately and call for service → page 265.

Hood Open Warning Light



This warning light will illuminate when the hood is left open and not fully closed.

NOTE:

If the vehicle is moving, there will also be a single chime.

Liftgate Open Warning Light



This warning light will illuminate when the liftgate is open.

NOTE:

If the vehicle is moving, there will also be a single chime.

Night Vision Animal Warning Light



The Night Vision Animal Warning Light will illuminate in red when an animal is detected directly in the vehicle's path, near the headlights, and a collision is possible

➞ page 150.

If enabled, a chime will sound and a video pop-up may display when a detection occurs.

Night Vision Pedestrian Warning Light



The Night Vision Pedestrian Warning Light will illuminate in red when a pedestrian is detected directly in the vehicle's path, near the headlights, and a collision is possible

➞ page 150.

If enabled, a chime will sound and a video pop-up may display when a detection occurs.

Oil Pressure Warning Light



This warning light will illuminate to indicate low engine oil pressure. If the light turns on while driving, stop the vehicle, shut off the engine as soon as possible, and contact an authorized dealer. A chime will sound when this light turns on.

Do not operate the vehicle until the cause is corrected. This light does not indicate how much oil is in the engine. The engine oil level must be checked under the hood.

Oil Temperature Warning Light



This warning light will illuminate to indicate the engine oil temperature is high. If the light turns on while driving, stop the vehicle and shut off the engine as soon as possible. Wait for oil temperature to return to normal levels.

Rear Seat Belt Reminder Warning Light — If Equipped



This light indicates when a rear seat belt is unbuckled in the second row. When the ignition is first placed in the ON/RUN position, and if a seat belt in the second row is

unbuckled, a light corresponding to the specific seat will turn on in the upper right portion of the instrument cluster display, momentarily replacing the configurable corner information. If a second row seat belt that was buckled at the start of the trip is unbuckled, the Rear Seat Belt Reminder Light will change from the buckled to the unbuckled symbol, and a chime will sound

➞ page 222.

Seat Belt Reminder Warning Light



This warning light indicates when the driver or passenger seat belt is unbuckled. When the ignition is first placed in the ON/RUN position and if the driver's seat belt is

unbuckled, a chime will sound and the light will turn on. When driving, if the driver or front passenger seat belt remains unbuckled, the Seat Belt Reminder Light will flash or remain on continuously and a chime will sound

➞ page 222.

Transmission Temperature Warning Light — If Equipped



This warning light will illuminate to warn of a high transmission fluid temperature. This may occur with strenuous usage such as trailer towing. If this light turns on, stop the vehicle and run the engine at idle or slightly faster, with the transmission in PARK (P) or NEUTRAL (N), until the light turns off. Once the light turns off, you may continue to drive normally.

WARNING!

If you continue operating the vehicle when the Transmission Temperature Warning Light is illuminated you could cause the fluid to boil over, come in contact with hot engine or exhaust components and cause a fire.

CAUTION!

Continuous driving with the Transmission Temperature Warning Light illuminated will eventually cause severe transmission damage or transmission failure.

Vehicle Security Warning Light — If Equipped



This light will flash at a fast rate for approximately 15 seconds when the vehicle security system is arming, and then will flash slowly until the vehicle is disarmed.

YELLOW WARNING LIGHTS

Active Driving Assist - Driver Inattentiveness Warning Light



This light illuminates when driver inattentiveness has been detected, warning the driver to place their hands on the steering wheel.

Active Driving Assist Fault Warning Light



This light will turn on when the Active Driving Assist system has detected a fault.

Air Suspension Fault Warning Light



This light will illuminate when there is a fault detected in the air suspension system.

Anti-Lock Brake System (ABS) Warning Light



This warning light monitors the ABS. The light will turn on when the ignition is placed in the ON/RUN or position and may stay on for as long as four seconds.

If the ABS light remains on or turns on while driving, then the Anti-Lock portion of the brake system is not functioning and service is required as soon as possible. However, the conventional brake system will continue to operate normally, assuming the Brake Warning Light is not also on.

If the ABS light does not turn on when the ignition is placed in the ON/RUN position, have the brake system inspected by an authorized dealer.

Electric Park Brake Fault Warning Light



This warning light will illuminate to indicate the Electric Park Brake is not functioning properly and service is required. Contact an authorized dealer.

Electronic Stability Control (ESC) Active Warning Light — If Equipped



This warning light will indicate when the ESC system is Active. The ESC Indicator Light in the instrument cluster will come on when the ignition is placed in the ON/RUN position, and when ESC is activated. It should go out with the engine running. If the ESC Indicator Light comes on continuously with the engine running, a malfunction has been detected in the ESC system. If this warning light remains on after several ignition cycles, and the vehicle has been driven several miles (kilometers) at speeds greater than 30 mph (48 km/h), see an authorized dealer as soon as possible to have the problem diagnosed and corrected.

- The ESC OFF Indicator Light and the ESC Indicator Light come on momentarily each time the ignition is placed in the ON/RUN position.
- The ESC system will make buzzing or clicking sounds when it is active. This is normal; the sounds will stop when ESC becomes inactive.
- This light will come on when the vehicle is in an ESC event.

Electronic Stability Control (ESC) OFF Warning Light — If Equipped



This warning light indicates the ESC is off. Each time the ignition is turned to ON/RUN, the ESC system will be on, even if it was turned off previously.

Service Active Lane Management Warning Light — If Equipped



This warning light will illuminate when the Active Lane Management system is not operating and requires service. Please see an authorized dealer.

Active Lane Management Warning Light — If Equipped



The Active Lane Management Warning Light will be solid yellow when the vehicle is approaching a lane marker. The warning light will flash when the vehicle is crossing the lane marker → page 144.

Fuel Level Sensor Failure Warning Light



This warning light will illuminate along with a dedicated message on the display if a problem is detected with the Fuel Level Sensor. If this light comes on see an authorized dealer immediately.

Low Fuel Warning Light



When the fuel level reaches approximately 2 gal (7.5 L), this light will turn on and a chime will sound. The light will remain on until fuel is added.

Low Washer Fluid Warning Light — If Equipped



This warning light will illuminate when the windshield washer fluid is low → page 276.

Engine Check/Malfunction Indicator Warning Light (MIL)



The Engine Check/Malfunction Indicator Light (MIL) is a part of an Onboard Diagnostic System called OBD II that monitors engine and automatic transmission control systems. This warning light will illuminate when the ignition is in the ON/RUN position before engine start. If the bulb does not come on when turning the ignition switch from OFF to ON/RUN, have the condition checked promptly.

Certain conditions, such as a loose or missing gas cap, poor quality fuel, etc., may illuminate the light after engine start. The vehicle should be serviced if the light stays on through several typical driving styles. In most situations, the vehicle will drive normally and will not require towing.

When the engine is running, the MIL may flash to alert serious conditions that could lead to immediate loss of power or severe catalytic converter damage. The vehicle should be serviced by an authorized dealer as soon as possible if this occurs.

WARNING!

A malfunctioning catalytic converter, as previously referenced, can reach higher temperatures than in normal operating conditions. This can cause a fire if you drive slowly or park over flammable substances such as dry plants, wood, cardboard, etc. This could result in death or serious injury to the driver, occupants or others.

CAUTION!

Prolonged driving with the Malfunction Indicator Light (MIL) on could cause damage to the vehicle control system. It also could affect fuel economy and driveability. If the MIL is flashing, severe catalytic converter damage and power loss will soon occur. Immediate service is required.

Night Vision Animal Warning Light



The Night Vision Animal Warning Light will illuminate in yellow when an animal is approaching or is in the vehicle's path → page 150.

Night Vision Pedestrian Warning Light



The Night Vision Pedestrian Warning Light will illuminate in yellow when a pedestrian is approaching or is in the vehicle's path → page 150.

Service 4WD Warning Light — If Equipped



This warning light will illuminate to signal a fault with the 4WD system. If the light stays on or comes on during driving, it means that the 4WD system is not functioning properly and that service is required. We recommend you drive to the nearest authorized dealer and have the vehicle serviced immediately.

Service Adaptive Cruise Control (ACC) Warning Light



This light will turn on when the ACC is not operating and needs service → page 121.

Service Forward Collision Warning (FCW) Or Pedestrian Emergency Braking (PEB) Warning Light — If Equipped



This warning light will illuminate to indicate a fault in the FCW or PEB System. Contact an authorized dealer for service → page 215.

Service Stop/Start System Warning Light — If Equipped



This warning light will illuminate when the Stop/Start system is not functioning properly and service is required. Contact an authorized dealer for service.

Sway Bar Fault Warning Light



This light will illuminate when there is a fault in the sway bar disconnect system
 ➔ page 114.

Tire Pressure Monitoring System (TPMS) Warning Light



The warning light switches on and a message is displayed to indicate that the tire pressure is lower than the recommended value and/or that slow pressure loss is occurring. In these cases, optimal tire duration and fuel consumption may not be guaranteed.

Should one or more tires be in the condition previously mentioned, the display will show the indications corresponding to each tire.

WARNING!

Do not continue driving with one or more flat tires as handling may be compromised. Stop the vehicle, avoiding sharp braking and steering. If a tire puncture occurs, repair immediately using the dedicated tire repair kit and contact an authorized dealer as soon as possible.

Each tire, including the spare (if provided), should be checked monthly when cold and inflated to the inflation pressure recommended by the vehicle manufacturer on the vehicle placard or tire inflation pressure label. If your vehicle has tires of a different size than the size indicated on the vehicle placard or tire inflation pressure label, you should determine the proper tire inflation pressure for those tires.

As an added safety feature, your vehicle has been equipped with a TPMS that illuminates a low tire pressure telltale when one or more of your tires is significantly underinflated. Accordingly, when the low tire pressure telltale illuminates, you should stop and check your tires as soon as possible, and inflate them to the proper pressure. Driving on a significantly underinflated tire causes the tire to overheat and can lead to tire failure. Underinflation also reduces fuel efficiency and tire tread life, and may affect the vehicle's handling and stopping ability.

Please note that the TPMS is not a substitute for proper tire maintenance, and it is the driver's responsibility to maintain correct tire pressure, even if underinflation has not reached the level to trigger illumination of the TPMS low tire pressure telltale.

Your vehicle has also been equipped with a TPMS malfunction indicator to indicate when the system is not operating properly. The TPMS malfunction indicator is combined with the low tire pressure telltale. When the system detects a malfunction, the telltale will flash for approximately one minute and then remain continuously illuminated. This sequence will continue upon subsequent vehicle start-ups as long as the malfunction exists. When the malfunction indicator is illuminated, the system may not be able to detect or signal low tire pressure as intended. TPMS malfunctions may occur for a variety of reasons, including the installation of replacement or alternate tires or wheels on the vehicle that prevent the TPMS from functioning properly. Always check the TPMS malfunction telltale after replacing one or more tires or wheels on your vehicle to ensure that the replacement or alternate tires and wheels allow the TPMS to continue to function properly.

CAUTION!

The TPMS has been optimized for the original equipment tires and wheels. TPMS pressures and warning have been established for the tire size equipped on your vehicle. Undesirable system operation or sensor damage may result when using replacement equipment that is not of the same size, type, and/or style. Aftermarket wheels can cause sensor damage. Using aftermarket tire sealants may cause the Tire Pressure Monitoring System (TPMS) sensor to become inoperable. After using an aftermarket tire sealant it is recommended that you take your vehicle to an authorized dealer to have your sensor function checked.

YELLOW INDICATOR LIGHTS

4WD Low Indicator Light — If Equipped



This light alerts the driver that the vehicle is in the 4WD Low mode. The front and rear driveshafts are mechanically locked together forcing the front and rear wheels to rotate at the same speed. Low range provides a greater gear reduction ratio to provide increased torque at the wheels ➔ page 112.

Air Suspension Active Indicator Light — If Equipped



This light will illuminate when the air suspension system is actively adjusting the ride height ➔ page 116.

Air Suspension Aerodynamic Height Indicator Light— If Equipped



This light will illuminate when the air suspension system is set to the Aerodynamic setting ↪ page 116.

Air Suspension Entry/Exit Indicator Light— If Equipped



This light will illuminate when the vehicle is automatically lowered from ride height position downward for easy entry and exit of the vehicle.

Air Suspension Off-Road 1 Indicator Light — If Equipped



This light will illuminate when the air suspension system is set to the Off-Road 1 setting ↪ page 116.

Air Suspension Off-Road 2 Indicator Light — If Equipped



This light will illuminate when the air suspension system is set to the Off-Road 2 setting ↪ page 116.

Auto HOLD! Fault Indicator Light — If Equipped



The Auto HOLD! Fault Indicator light will illuminate if a fault is detected, it will be indicated by a yellow 'HOLD!' indicator light that will stay on as long as the fault condition exists.

Forward Collision Warning (FCW) Or Pedestrian Emergency Braking (PEB) OFF Indicator Light — If Equipped



This indicator light illuminates to indicate that FCW or PEB is off ↪ page 215.

Max Payload Exceeded Indicator Light



This light indicates that the maximum payload may have been exceeded or load leveling cannot be achieved at its current ride height.

NEUTRAL Indicator Light — If Equipped



This light alerts the driver that the 4WD power transfer case is in the NEUTRAL mode and the front and rear driveshafts are disengaged from the powertrain.

Sway Bar Indicator Light — If Equipped



This indicator light will illuminate when the front sway bar is disconnected ↪ page 114.

GREEN INDICATOR LIGHTS

Active Driving Assist - Driver Attentive Indicator Light



This light will turn on when the system detects that the driver is attentive and is actively steering the vehicle.

Adaptive Cruise Control (ACC) Set With Target Indicator Light — If Equipped



This will display when the ACC is set and the vehicle in front is detected ↪ page 121.

Adaptive Cruise Control (ACC) Set With No Target Detected Indicator Light — If Equipped



This will display when the ACC is set and the vehicle in front is not detected ↪ page 121.

Auto HOLD Indicator Light — If Equipped



Auto HOLD keeps your vehicle at a complete stop without you having to keep your foot on the brake pedal. Once engaged a green "HOLD" indicator will appear in the Instrument Cluster Display.

Cruise Control SET Indicator Light — If Equipped



This indicator light will illuminate when the cruise control is set to the desired speed
 ⇨ page 120.

Front Fog Indicator Light — If Equipped



This indicator light will illuminate when the front fog lights are on ⇨ page 50.

Active Lane Management Indicator Light — If Equipped



The Active Lane Management indicator light illuminates solid green when both lane markings have been detected and the system is armed and ready to provide visual and torque warnings if an unintentional lane departure occurs ⇨ page 144.

Night Vision Active Indicator Light — If Equipped



This light alerts the driver that the Night Vision Warning System status is Active
 ⇨ page 150.

Parking/Headlights On Indicator Light



This indicator light will illuminate when the parking lights or headlights are turned on
 ⇨ page 50.

Rear Seat Belt Fastened Indicator Light — If Equipped



This light indicates when a rear seat belt has been buckled in the second row. A telltale will display in the upper right corner of the instrument cluster display to correspond to the specific seating position once the seat belt has been buckled ⇨ page 222.

Sport Mode Indicator Light



This light will turn on when Sport mode is active.

Stop/Start Active Indicator Light — If Equipped



This indicator light will illuminate when the Stop/Start function is in "Autostop" mode
 ⇨ page 119.

Turn Signal/Hazard Indicator Lights



When the left or right turn signal is activated, the turn signal indicator will flash independently and the corresponding exterior turn signal lamps will flash. Turn signals can be activated when the multifunction lever is moved down (left) or up (right).

NOTE:

- A continuous chime will sound if the vehicle is driven more than 1 mile (1.6 km) with either turn signal on.
- Check for an inoperative outside light bulb if either indicator flashes at a rapid rate.

WHITE INDICATOR LIGHTS

Active Driving Assist On Indicator Light



This light will turn on when the system is turned on, but is not actively providing steering to the vehicle.

Adaptive Cruise Control (ACC) Ready Indicator Light — If Equipped



This light will turn on when ACC has been turned on, but is not set ⇨ page 121.

Cruise Control Ready Indicator Light



This indicator light will illuminate when the cruise control is ready, but not set
 ⇨ page 120.

Hill Descent Control (HDC) Indicator Light — If Equipped



This indicator shows when the HDC feature is turned on. The light will be on solid when HDC is armed. HDC can only be armed when the transfer case is in the 4WD Low position and the vehicle speed is less than 30 mph (48 km/h). If these conditions are not met while attempting to use the HDC feature, the HDC indicator light will flash on/off.

Rear Seat Unoccupied Indicator Light — If Equipped



This light indicates when the rear passenger seats are unoccupied, and will illuminate in the upper right portion of the instrument cluster display, momentarily replacing the configurable corner information ↪ page 206.

Selec-Speed Control Indicator Light — If Equipped



This light will turn on when Selec-Speed Control is activated.

To activate Selec-Speed Control, ensure the vehicle is in 4WD Low and push the button on the Instrument Panel ↪ page 115.

NOTE:

If the vehicle is not in 4WD Low, "To Enter Selec-Speed Shift to 4WD Low" will appear in the instrument cluster display.

BLUE INDICATOR LIGHTS

High Beam Indicator Light



This indicator light will illuminate to indicate that the high beam headlights are on. With the low beams activated, push the multifunction lever forward (toward the front of the vehicle) to turn on the high beams. Pull the multifunction lever rearward (toward the rear of the vehicle) to turn off the high beams. If the high beams are off, pull the lever toward you for a temporary high beam on, "flash to pass" scenario.

GRAY INDICATOR LIGHTS

Night Vision Suppressed Indicator Light — If Equipped



This light alerts the driver that the Night Vision Warning System status is Suppressed ↪ page 150.

ONBOARD DIAGNOSTIC SYSTEM — OBD II

Your vehicle is equipped with a sophisticated Onboard Diagnostic system called OBD II. This system monitors the performance of the emissions, engine, and transmission control systems. When these systems are operating properly, your vehicle will provide excellent performance and fuel economy, as well as engine emissions well within current government regulations.

If any of these systems require service, the OBD II system will turn on the Malfunction Indicator Light (MIL). It will also store diagnostic codes and other information to assist your service technician in making repairs. Although your vehicle will usually be driveable and not need towing, see an authorized dealer for service as soon as possible.

CAUTION!

- Prolonged driving with the MIL on could cause further damage to the emission control system. It could also affect fuel economy and driveability. The vehicle must be serviced before any emissions tests can be performed.
- If the MIL is flashing while the vehicle is running, severe catalytic converter damage and power loss will soon occur. Immediate service is required.

ONBOARD DIAGNOSTIC SYSTEM (OBD II) CYBERSECURITY

Your vehicle is required to have OBD II and a connection port to allow access to information related to the performance of your emissions controls. Authorized service technicians may need to access this information to assist with the diagnosis and service of your vehicle and emissions system ↪ page 169.

WARNING!

- ONLY an authorized service technician should connect equipment to the OBD II connection port in order to read the VIN, diagnose, or service your vehicle.
- If unauthorized equipment is connected to the OBD II connection port, such as a driver-behavior tracking device, it may:
 - Be possible that vehicle systems, including safety related systems, could be impaired or a loss of vehicle control could occur that may result in an accident involving serious injury or death.
 - Access, or allow others to access, information stored in your vehicle systems, including personal information.

EMISSIONS INSPECTION AND MAINTENANCE PROGRAMS

In some localities, it may be a legal requirement to pass an inspection of your vehicle's emissions control system. Failure to pass could prevent vehicle registration.



For states that require an Inspection and Maintenance (I/M), this check verifies the Malfunction Indicator Light (MIL) is functioning and is not on when the engine is running, and that the OBD II system is ready for testing.

Normally, the OBD II system will be ready. The OBD II system may **not** be ready if your vehicle was recently serviced, or had a depleted battery or a battery replacement. If the OBD II system should be determined not ready for the I/M test, your vehicle may fail the test.

Your vehicle has a simple ignition actuated test, which you can use prior to going to the test station. To check if your vehicle's OBD II system is ready, you must do the following:

1. Cycle the ignition switch to the ON position, but do not crank or start the engine.

NOTE:

If you crank or start the engine, you will have to start this test over.

2. As soon as you cycle the ignition switch to the ON position, you will see the Malfunction Indicator Light (MIL) symbol come on as part of a normal bulb check.

3. Approximately 15 seconds later, one of two things will happen:
 - The MIL will flash for about 10 seconds and then return to being fully illuminated until you turn OFF the ignition or start the engine. This means that your vehicle's OBD II system is **not ready** and you should **not** proceed to the I/M station.
 - The MIL will not flash at all and will remain fully illuminated until you place the ignition in the off position or start the engine. This means that your vehicle's OBD II system is **ready** and you can proceed to the I/M station.

If your OBD II system is **not ready**, you should see an authorized dealer or repair facility. If your vehicle was recently serviced or had a battery failure or replacement, you may need to do nothing more than drive your vehicle as you normally would in order for your OBD II system to update. A recheck with the previously mentioned test routine may then indicate that the system is **now ready**.

Regardless of whether your vehicle's OBD II system is ready or not, if the MIL is illuminated during normal vehicle operation you should have your vehicle serviced before going to the I/M station. The I/M station can fail your vehicle because the MIL is on with the engine running.

STARTING AND OPERATING

STARTING THE ENGINE — GRAND CHEROKEE

Before starting your vehicle, adjust your seat, adjust the inside and outside mirrors, fasten your seat belt, and if present, instruct all other occupants to buckle their seat belts.

WARNING!

- Before exiting a vehicle, always come to a complete stop, then shift the automatic transmission into PARK and apply the parking brake.
- Always make sure the keyless ignition node is in the OFF position, key fob is removed from the vehicle and vehicle is locked.
- Never leave children alone in a vehicle, or with access to an unlocked vehicle. Leaving children in a vehicle unattended is dangerous for a number of reasons. A child or others could be seriously or fatally injured. Children should be warned not to touch the parking brake, brake pedal or the gear selector.
- Do not leave the key fob in or near the vehicle, or in a location accessible to children, and do not leave the ignition of a vehicle equipped with Keyless Enter 'n Go™ in the ON/RUN position. A child could operate power windows, other controls, or move the vehicle.
- Do not leave children or animals inside parked vehicles in hot weather. Interior heat buildup may cause serious injury or death.

AUTOMATIC TRANSMISSION

The gear selector must be in the NEUTRAL (N) or PARK (P) position before you can start the engine. Apply the brakes before shifting into any driving gear.

CAUTION!

Damage to the transmission may occur if the following precautions are not observed:

- Do not shift from REVERSE (R), PARK, or NEUTRAL into any forward gear when the engine is above idle speed.
- Shift into PARK only after the vehicle has come to a complete stop.
- Shift into or out of REVERSE only after the vehicle has come to a complete stop and the engine is at idle speed.
- Before shifting into any gear, make sure your foot is firmly on the brake pedal.

KEYLESS ENTER 'N GO™ — IGNITION

This feature allows the driver to operate the ignition switch with the push of a button, as long as the Remote Start/Keyless Enter 'n Go™ key fob is in the passenger compartment.

NORMAL STARTING

To Turn On The Engine Using The ENGINE START/STOP Button

1. The transmission must be in PARK (P).
2. Press and hold the brake pedal while pushing the ENGINE START/STOP button once.
3. The system takes over and attempts to start the vehicle. If the vehicle fails to start, the starter will disengage automatically after 10 seconds.
4. If you wish to stop the cranking of the engine prior to the engine starting, push the ENGINE START/STOP button again.

To Turn Off The Engine Using The ENGINE START/STOP Button

1. Place the gear selector in PARK, then push and release the ENGINE START/STOP button.
2. The ignition will return to the OFF position.
3. If the gear selector is not in PARK, the ENGINE START/STOP button must be held for two seconds or three short pushes in a row with the vehicle speed above 5 mph (8 km/h) before the engine will shut off. The ignition will remain in the ON/RUN position until the gear selector is in PARK and the button is pushed twice to the OFF position.
4. If the gear selector is not in PARK and the ENGINE START/STOP button is pushed once with the vehicle speed above 5 mph (8 km/h), the instrument cluster will display a " **Vehicle Not In Park**" message and the engine will remain running. Never leave a vehicle out of the PARK position, or it could roll.

NOTE:

If the gear selector is not in PARK, and the ENGINE START/STOP button is pushed once with the vehicle speed below 5 mph (8 km/h), the engine will shut off and the ignition will remain in the ON/RUN position. If vehicle speed drops below 1.2 mph (1.9 km/h), the vehicle may AutoPark ↪ page 104.

ENGINE START/STOP Button Functions — With Driver's Foot Off The Brake Pedal (In PARK Or NEUTRAL Position)

The ENGINE START/STOP button operates similar to an ignition switch. It has three positions: OFF, ON/RUN, and START. To change the ignition positions without starting the vehicle and use the accessories, follow these directions:

1. Start with the ignition in the OFF position.
2. Push the ENGINE START/STOP button once to place the ignition in the ON/RUN position.
3. Push the ENGINE START/STOP button a second time to return the ignition to the OFF position.

NOTE:

Only press one pedal at a time while driving the vehicle. Torque performance of the vehicle could be reduced if both pedals are pressed at the same time. If pressure is detected on both pedals simultaneously, a warning message will display in the instrument cluster ↪ page 82.

AUTOPARK

AutoPark is a supplemental feature to assist with placing the vehicle in PARK (P) should the situations on the following pages occur. It is a back-up system and should not be relied upon as the primary method by which the driver shifts the vehicle into PARK.

The conditions under which AutoPark will engage are outlined on the following pages.

WARNING!

- Driver inattention could lead to failure to place the vehicle in PARK. ALWAYS DO A VISUAL CHECK that your vehicle is in PARK by verifying that a solid (not blinking) "P" is indicated in the instrument cluster display and on the gear selector. If the "P" indicator is blinking, your vehicle is not in PARK. As an added precaution, always apply the parking brake when exiting the vehicle.
- AutoPark is a supplemental feature. It is not designed to replace the need to shift your vehicle into PARK. It is a back-up system and should not be relied upon as the primary method by which the driver shifts the vehicle into PARK.

If the vehicle is not in PARK and the driver turns off the engine, the vehicle may AutoPark.

AutoPark will engage when all of these conditions are met:

- Vehicle is equipped with an 8-speed transmission
- Vehicle is not in PARK
- Vehicle speed is 1.2 mph (1.9 km/h) or less

NOTE:

For Keyless Enter 'n Go™ equipped vehicles, the engine will turn off and the ignition switch will change to the ON/RUN position. After 30 minutes the ignition switches to OFF automatically, unless the driver turns the ignition switch OFF.

If the vehicle is not in PARK and the driver exits the vehicle with the engine running, the vehicle may AutoPark.

AutoPark will engage when all of these conditions are met:

- Vehicle is equipped with an 8-speed transmission
- Vehicle is not in PARK
- Vehicle speed is 1.2 mph (1.9 km/h) or less
- Driver's seat belt is unbuckled
- Driver's door is ajar
- Brake pedal is not pressed

The message "AutoPark Engaged Shift To P Then Shift To Gear" will display in the instrument cluster.

NOTE:

In some cases the ParkSense graphic will be displayed in the instrument cluster. In these cases, the gear selector must be returned to "P" to select desired gear.

If the driver shifts into PARK while moving, the vehicle may AutoPark.

AutoPark will engage **ONLY** when vehicle speed is 1.2 mph (1.9 km/h) or less.

The message "Vehicle Speed Is Too High To Shift To P" will be displayed in the instrument cluster if vehicle speed is above 1.2 mph (1.9 km/h).

WARNING!

If vehicle speed is above 1.2 mph (1.9 km/h), the transmission will default to NEUTRAL until the vehicle speed drops below 1.2 mph (1.9 km/h). A vehicle left in the NEUTRAL position can roll. As an added precaution, always apply the parking brake when exiting the vehicle.

4WD LOW — If Equipped

AutoPark will be disabled when operating the vehicle in 4WD LOW.

The message “**AutoPark Disabled**” will be displayed in the instrument cluster.

Additional customer warnings will be given when both of these conditions are met:

- Vehicle is not in PARK
- Driver's door is ajar

The message “**AutoPark Not Engaged**” will be displayed in the instrument cluster. A warning chime will continue until you shift the vehicle into PARK or the driver's door is closed.

ALWAYS DO A VISUAL CHECK that your vehicle is in PARK by looking for the "P" in the instrument cluster display and on the gear selector. As an added precaution, always apply the parking brake when exiting the vehicle.

EXTENDED PARK STARTING**NOTE:**

Extended Park condition occurs when the vehicle has not been started or driven for at least 30 days.

1. Install a battery charger or jumper cables to the battery to ensure a full battery charge during the crank cycle.
2. Press and hold the brake pedal while pushing the ENGINE START/STOP button once.
3. If the engine fails to start within 10 seconds, wait 10 to 15 seconds to allow the starter to cool, then repeat the Extended Park Starting procedure.

4. If the engine fails to start after eight attempts, allow the starter to cool for at least 10 minutes, then repeat the Extended Park Starting procedure.

CAUTION!

To prevent damage to the starter, do not crank continuously for more than 10 seconds at a time. Wait 10 to 15 seconds before trying again.

IF ENGINE FAILS TO START

If the engine fails to start after you have followed the “Normal Starting” procedure and has not experienced an Extended Park condition as defined previously, it may be flooded. Push the accelerator pedal all the way to the floor and hold it there while the engine is cranking. This should clear any excess fuel in case the engine is flooded. The starter motor will engage automatically, run for 10 seconds, and then disengage. Once this occurs, release the accelerator pedal and brake pedal, wait 10 to 15 seconds, then repeat the “Normal Starting” procedure.

WARNING!

- Never pour fuel or other flammable liquid into the throttle body air inlet opening in an attempt to start the vehicle. This could result in flash fire causing serious personal injury.
- Do not attempt to push or tow your vehicle to get it started. Vehicles equipped with an automatic transmission cannot be started this way. Unburned fuel could enter the catalytic converter and once the engine has started, ignite and damage the converter and vehicle.

(Continued)

WARNING!

- If the vehicle has a discharged battery, booster cables may be used to obtain a start from a booster battery or the battery in another vehicle. This type of start can be dangerous if done improperly → page 264.

CAUTION!

To prevent damage to the starter, do not continuously crank the engine for more than 10 seconds at a time. Wait 10 to 15 seconds before trying again.

4**COLD WEATHER OPERATION
(BELOW -22°F OR -30°C)**

To ensure reliable starting at these temperatures, use of an externally powered electric engine block heater (available from an authorized dealer) is recommended.

AFTER STARTING

The idle speed is controlled automatically, and it will decrease as the engine warms up.

ENGINE BREAK-IN RECOMMENDATIONS

A long break-in period is not required for the engine and drivetrain (transmission and axle) in your vehicle.

Drive moderately during the first 300 miles (500 km). After the initial 60 miles (100 km), speeds up to 50 or 55 mph (80 or 90 km/h) are desirable.

Brief full-throttle acceleration within the limits of local traffic laws contributes to a good break-in. Wide-open throttle acceleration in low gear can be detrimental and should be avoided.

The engine oil installed in the engine at the factory is a high-quality energy conserving type lubricant. Oil changes should be consistent with anticipated climate conditions under which vehicle operations will occur
 ➔ page 277.

CAUTION!

Never use non-detergent oil or straight mineral oil in the engine or damage may result.

NOTE:

A new engine may consume some oil during its first few thousand miles (kilometers) of operation. This should be considered a normal part of the break-in and not interpreted as a problem. Please check your oil level with the engine oil indicator often during the break-in period. Add oil as required.

PARKING BRAKE

ELECTRIC PARK BRAKE (EPB)

Your vehicle is equipped with an EPB that offers simple operation, and some additional features that make the parking brake more convenient and useful.

The parking brake is primarily intended to prevent the vehicle from rolling while parked. Before leaving the vehicle, make sure the parking brake is applied. Also, be certain to leave the transmission in PARK.

You can engage the parking brake in two ways:

- Manually, by applying the parking brake switch.
- Automatically, by enabling the Auto Park Brake feature in the Customer Programmable Features section of the Uconnect settings.

The parking brake switch is located on the instrument panel to the left of the steering wheel (below the headlamp switch).

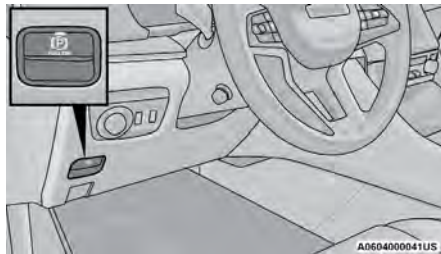

Electric Park Brake Switch

To apply the parking brake manually, pull up on the switch momentarily. You may hear a sound from the back of the vehicle while the parking brake engages. Once the parking brake is fully engaged, the BRAKE Warning Light in the instrument cluster and an indicator on the switch will illuminate. If your foot is on the brake pedal while you apply the parking brake, you may notice a small amount of brake pedal movement. The parking brake can be applied even when the ignition switch is OFF but the BRAKE Warning Light will not illuminate, however, it can only be released when the ignition is in the ON/RUN position.

NOTE:

The EPB Warning Light will illuminate if the EPB switch is held for longer than 20 seconds in either the released or applied position. The light will extinguish upon releasing the switch.

If the Auto Park Brake feature is enabled, the parking brake will automatically engage whenever the transmission is placed into PARK. If your foot is on the brake pedal, you may notice a small amount of brake pedal movement while the parking brake is engaging.

The parking brake will release automatically when the ignition is ON, the transmission is in DRIVE or REVERSE, the driver seat belt is buckled, and an attempt is made to drive away.

To release the parking brake manually, the ignition switch must be in the ON/RUN position. Put your foot on the brake pedal, then push the EPB switch down momentarily. You may hear a sound from the back of the vehicle while the parking brake disengages. You may also notice a small amount of movement in the brake pedal. Once the parking brake is fully disengaged, the BRAKE Warning Light in the instrument cluster and the LED indicator on the switch will extinguish.

NOTE:

When parking on a hill, it is important to turn the front wheels toward the curb on a downhill grade and away from the curb on an uphill grade. Apply the parking brake before placing the gear selector in PARK, otherwise the load on the transmission locking mechanism may make it difficult to move the gear selector out of PARK.

WARNING!

- Never use the PARK position as a substitute for the parking brake. Always apply the parking brake fully when parked to guard against vehicle movement and possible injury or damage.
- When exiting the vehicle, always turn the ignition OFF, secure the key fob, and lock your vehicle.
- Never leave children alone in a vehicle, or with access to an unlocked vehicle. Allowing children to be in a vehicle unattended is dangerous for a number of reasons. A child or others could be seriously or fatally injured. Children should be warned not to touch the parking brake, brake pedal or the gear selector.
- Do not leave the key fob in or near the vehicle, or in a location accessible to children, and do not leave a vehicle equipped with Keyless Enter 'n Go™ in the ON/RUN position. A child could operate power windows, other controls, or move the vehicle.
- Be sure the parking brake is fully disengaged before driving; failure to do so can lead to brake failure and a collision.
- Always fully apply the parking brake when leaving your vehicle, or it may roll and cause damage or injury. Also be certain to leave the transmission in PARK. Failure to do so may allow the vehicle to roll and cause damage or injury.

CAUTION!

If the Brake System Warning Light remains on with the parking brake released, a brake system malfunction is indicated. Have the brake system serviced by an authorized dealer immediately.

If exceptional circumstances should make it necessary to engage the parking brake while the vehicle is in motion, maintain upward pressure on the EPB switch for as long as engagement is desired. The BRAKE Warning Light will illuminate, and a continuous chime will sound. The rear stop lamps will also be illuminated automatically while the vehicle remains in motion.

To disengage the parking brake while the vehicle is in motion, release the switch. If the vehicle is brought to a complete stop using the parking brake, when the vehicle reaches approximately 3 mph, (5 km/h) the parking brake will remain engaged.

WARNING!

Driving the vehicle with the parking brake engaged, or repeated use of the parking brake to slow the vehicle may cause serious damage to the brake system. Be sure the parking brake is fully disengaged before driving; failure to do so can lead to brake failure and a collision.

In the unlikely event of a malfunction of the EPB system, a yellow EPB Warning Light will illuminate. This may be accompanied by the BRAKE Warning Light flashing. In this event, urgent service of the EPB system is required. Do not rely on the parking brake to hold the vehicle stationary.

AUTO PARK BRAKE

The EPB can be programmed to be applied automatically whenever the vehicle is at a standstill and the transmission is placed in PARK. Auto Park Brake is enabled and disabled by customer selection through the customer programmable features section of the Uconnect Settings  page 181.

Any single Auto Park Brake application can be bypassed by pushing the EPB switch to the release position while the transmission is placed in PARK.

SAFEHOLD

SafeHold is a safety feature of the EPB system that will place the transmission in PARK, and engage the parking brake automatically if the vehicle is left unsecured while the ignition is in ON/RUN.

The parking brake will automatically engage if all of the following conditions are met:

- The vehicle is at a standstill.
- There is no attempt to press the brake pedal or accelerator pedal.
- The seat belt is unbuckled.
- The driver door is open.

SafeHold can be temporarily bypassed by pushing the EPB switch while the driver door is open. Once manually bypassed, SafeHold will be enabled again once the vehicle reaches 12 mph (20 km/h) or the ignition is turned to the OFF position and back to ON again.

HOLD 'N GO — IF EQUIPPED

Hold 'N Go is a comfort feature that allows the driver to remove their foot from the brake pedal once the vehicle has come to a stop. The vehicle must be held at a standstill for a predetermined amount of time by hydraulic braking. The EPB will then engage and continue to hold the vehicle at a stop until the driver applies the accelerator pedal. Hold 'N Go can be activated or deactivated by pushing the HOLD button located on the switch bank.



HOLD Switch

The following conditions must be met for Hold 'N Go to activate:

- Driver's door is closed
- Driver's seat belt is fastened
- Vehicle is at a standstill
- Forward gear is selected
- ACC is not engaged
- EPB is not applied
- ParkSense Active Park Assist System auto parking maneuver is not activated

BRAKE MAINTENANCE MODE

We recommend having your brakes serviced by an authorized dealer. You should only make repairs for which you have the knowledge and the right equipment. You should only enter Brake Maintenance mode during brake service.

When servicing your rear brakes, it may be necessary for you or your technician to push the rear piston into the rear caliper bore. With the EPB system, this can only be done after retracting the EPB actuator. Fortunately, actuator retraction can be done easily by entering the Brake Maintenance mode through the Uconnect Settings in your vehicle. This menu-based system will guide you through the steps necessary to retract the EPB actuator in order to perform rear brake service.

Maintenance mode has requirements that must be met in order to be activated:

- The vehicle must be at a standstill.
- The parking brake must be unapplied.
- The transmission must be in PARK or NEUTRAL.

While in Maintenance mode, the EPB Warning Light will flash continuously while the ignition is ON.

When brake maintenance work is complete, the following steps must be followed to reset the parking brake system to normal operation:

- Ensure the vehicle is at a standstill.
- Press the brake pedal with moderate force.
- Apply the EPB Switch.

WARNING!

You can be badly injured working on or around a motor vehicle. Do only that service work for which you have the knowledge and the right equipment. If you have any doubt about your ability to perform a service job, take your vehicle to a competent mechanic.

AUTOMATIC TRANSMISSION

You must press and hold the brake pedal while shifting out of PARK.

WARNING!

- Never use the PARK (P) position as a substitute for the parking brake. Always apply the parking brake fully when exiting the vehicle to guard against vehicle movement and possible injury or damage.
- Your vehicle could move and injure you and others if it is not in PARK. Check by trying to move the transmission gear selector out of PARK with the brake pedal released. Make sure the transmission is in PARK before exiting the vehicle.
- The transmission may not engage PARK if the vehicle is moving. Always bring the vehicle to a complete stop before shifting to PARK, and verify that the transmission gear position indicator solidly indicates PARK without blinking. Ensure that the vehicle is completely stopped, and the PARK position is properly indicated, before exiting the vehicle.

(Continued)

WARNING!

- It is dangerous to shift out of PARK or NEUTRAL (N) if the engine speed is higher than idle speed. If your foot is not firmly pressing the brake pedal, the vehicle could accelerate quickly forward or in reverse. You could lose control of the vehicle and hit someone or something. Only shift into gear when the engine is idling normally and your foot is firmly pressing the brake pedal.
- Unintended movement of a vehicle could injure those in or near the vehicle. As with all vehicles, you should never exit a vehicle while the engine is running. Before exiting a vehicle, always come to a complete stop, then apply the parking brake, shift the transmission into PARK, and turn the ignition OFF. When the ignition is in the OFF position, the transmission is locked in PARK, securing the vehicle against unwanted movement.
- When exiting the vehicle, always make sure the ignition is in the OFF position, remove the key fob from the vehicle, and lock the vehicle.
- Never leave children alone in a vehicle, or with access to an unlocked vehicle. Allowing children to be in a vehicle unattended is dangerous for a number of reasons. A child or others could be seriously or fatally injured. Children should be warned not to touch the parking brake, brake pedal or the transmission gear selector.
- Do not leave the key fob in or near the vehicle (or in a location accessible to children), and do not leave the ignition in the ON/RUN position. A child could operate power windows, other controls, or move the vehicle.

CAUTION!

Damage to the transmission may occur if the following precautions are not observed:

- Shift into or out of PARK or REVERSE (R) only after the vehicle has come to a complete stop.
- Do not shift between PARK, REVERSE, NEUTRAL, or DRIVE (D) when the engine is above idle speed.
- Before shifting into any gear, make sure your foot is firmly pressing the brake pedal.

IGNITION PARK INTERLOCK

This vehicle is equipped with an Ignition Park Interlock which requires the transmission to be in PARK (P) before the ignition can be turned to the OFF position. This helps the driver avoid inadvertently leaving the vehicle without placing the transmission in PARK. This system also locks the transmission in PARK whenever the ignition is in the OFF position.

NOTE:

The transmission will NOT shift out of the PARK position if the engine is not running even when the brakes are applied. Ensure that the transmission is in PARK, and the ignition is **OFF** (not in the ON/RUN position) before exiting the vehicle.

BRAKE/TRANSMISSION SHIFT INTERLOCK (BTSI) SYSTEM

This vehicle is equipped with a BTSI system that holds the transmission gear selector in PARK unless the brakes are applied. To shift the transmission out of PARK, the engine must be running and the brake pedal must be pressed. The brake pedal must also be pressed to shift from NEUTRAL into DRIVE or REVERSE when the vehicle is stopped or moving at low speeds.

8-SPEED AUTOMATIC TRANSMISSION

The transmission is controlled using a rotary electronic gear selector located on the center console. The transmission gear range (PRND) is displayed both above the gear selector and in the instrument cluster. To select a gear range, simply rotate the gear selector. You must press the brake pedal to shift the transmission out of PARK (or NEUTRAL, when the vehicle is stopped or moving at low speeds). To shift past multiple gear ranges at once (such as PARK to DRIVE), simply rotate the gear selector to the appropriate detent. Select the DRIVE range for normal driving.

NOTE:

In the event of a mismatch between the gear selector position and the actual transmission gear (for example, driver selects PARK while driving), the position indicator will blink continuously until the selector is returned to the proper position, or the requested shift can be completed.

The electronically controlled transmission adapts its shift schedule based on driver inputs, along with environmental and road conditions. The transmission electronics are self-calibrating; therefore, the first few shifts on a new vehicle may be somewhat abrupt. This is a normal condition, and precision shifts will develop within a few hundred miles (kilometers).

Only shift from DRIVE to PARK or REVERSE when the accelerator pedal is released and the vehicle is stopped. Be sure to keep your foot on the brake pedal when shifting between these gears.

The transmission gear selector has only PARK, REVERSE, NEUTRAL, and DRIVE positions. Manual downshifts can be made using the steering wheel mounted paddle shifters. Pulling the $-/+$ switches (on the steering wheel) while in the DRIVE position will select the highest available transmission gear, and will display that gear limit in the instrument cluster as 1, 2, 3, etc. Some models will display both the selected gear limit, and the actual current gear, while in AutoStick mode.

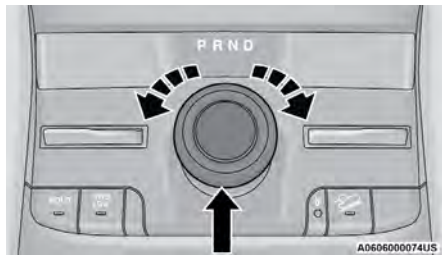

Transmission Gear Selector

Gear Ranges

Do not press the accelerator pedal when shifting from PARK (P) or NEUTRAL (N) into another gear range.

NOTE:

After selecting any gear range, wait a moment to allow the selected gear to engage before accelerating. This is especially important when the engine is cold.

PARK (P)

This range supplements the parking brake by locking the transmission. The engine can be started in this range. Never attempt to use PARK while the vehicle is in motion. Apply the parking brake when exiting the vehicle in this range.

When parking on a hill, apply the parking brake before shifting the transmission to PARK. As an added precaution, turn the front wheels toward the curb on a downhill grade and away from the curb on an uphill grade.

When exiting the vehicle, always:

- Apply the parking brake.
- Shift the transmission into PARK.
- Turn the ignition OFF.
- Remove the key fob from the vehicle.

NOTE:

On four-wheel drive vehicles be sure that the transfer case is in a drive position.

CAUTION!

- Before moving the transmission gear selector out of PARK, you must start the engine, and also press the brake pedal. Otherwise, damage to the gear selector could result.
- DO NOT race the engine when shifting from PARK or NEUTRAL into another gear range, as this can damage the drivetrain.

The following indicators should be used to ensure that you have properly engaged the transmission into the PARK position:

- When shifting into PARK, rotate the shifter all the way counterclockwise until the indicator displays PARK.
- Look at the transmission gear position display and verify that it indicates the PARK position (P), and is not blinking.
- With the brake pedal released, verify that the gear selector will not move out of PARK.

REVERSE (R)

This range is for moving the vehicle backward. Shift into REVERSE only after the vehicle has come to a complete stop.

NEUTRAL (N)

Use this range when the vehicle is standing for prolonged periods with the engine running. Apply the parking brake and shift the transmission into PARK (P) if you must exit the vehicle.

WARNING!

Do not coast in NEUTRAL and never turn off the ignition to coast down a hill. These are unsafe practices that limit your response to changing traffic or road conditions. You might lose control of the vehicle and have a collision.

CAUTION!

Towing the vehicle, coasting, or driving for any other reason with the transmission in NEUTRAL can cause severe transmission damage.

For Recreational Towing see ↗ page 163.

For Towing A Disabled Vehicle see ↗ page 267.

DRIVE (D)

This range should be used for most city and highway driving. It provides the smoothest upshifts and downshifts, and the best fuel economy. The transmission automatically upshifts through all forward gears.

When frequent transmission shifting occurs (such as when operating the vehicle under heavy loading conditions, in hilly terrain, traveling into strong head winds, or while towing a heavy trailer), use the AutoStick shift control to select a lower gear ↗ page 111. Under these conditions, using a lower gear will improve performance and extend transmission life by reducing excessive shifting and heat buildup.

During cold temperatures, transmission operation may be modified depending on engine and transmission temperature as well as vehicle speed. This feature improves warm-up time of the engine and transmission to achieve maximum efficiency. Engagement of the

torque converter clutch is inhibited until the transmission fluid is warm. Normal operation will resume once the transmission temperature has risen to a suitable level.

Transmission Limp Home Mode

Transmission function is monitored electronically for abnormal conditions. If a condition is detected that could result in transmission damage, Transmission Limp Home Mode is activated. In this mode, the transmission may operate only in certain gears, or may not shift at all. Vehicle performance may be severely degraded and the engine may stall. In some situations, the transmission may not re-engage if the engine is turned off and restarted. The Malfunction Indicator Light (MIL) may be illuminated. A message in the instrument cluster will inform the driver of the more serious conditions, and indicate what actions may be necessary.

In the event of a momentary problem, the transmission can be reset to regain all forward gears by performing the following steps:

NOTE:

In cases where the instrument cluster message indicates the transmission may not re-engage after engine shutdown, perform this procedure only in a desired location (preferably, at an authorized dealer).

1. Stop the vehicle.
2. Shift the transmission into PARK (P), if possible. If not, shift the transmission to NEUTRAL (N).
3. Push and hold the ignition switch until the engine turns off.
4. Wait approximately 30 seconds.
5. Restart the engine.

6. Shift into the desired gear range. If the problem is no longer detected, the transmission will return to normal operation.

NOTE:

Even if the transmission can be reset, we recommend that you visit an authorized dealer at your earliest possible convenience. An authorized dealer has diagnostic equipment to assess the condition of your transmission.

If the transmission cannot be reset, authorized dealer service is required.

AutoStick — If Equipped

AutoStick is a driver-interactive transmission feature providing manual shift control, giving you more control of the vehicle. AutoStick allows you to maximize engine braking, eliminate undesirable upshifts and downshifts, and improve overall vehicle performance. This feature can also provide you with more control during passing, city driving, cold slippery conditions, mountain driving, trailer towing, and many other situations.

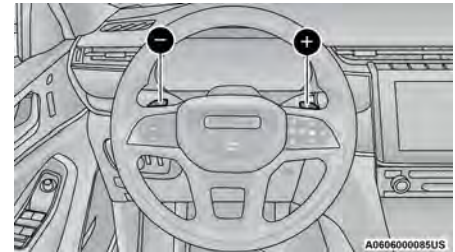
**AutoStick Paddle Shifters**

Operation

To activate AutoStick mode, tap one of the paddle shifters on the steering wheel. Tapping the (-) paddle shifters to enter AutoStick mode will downshift the transmission to the next lower gear, while tapping (+) to enter AutoStick mode will retain the current gear. The current transmission gear will be displayed in the instrument cluster. In AutoStick mode, you can use the paddle shifters, to manually shift the transmission. Tapping the (-) paddle shifters, will downshift the transmission to the next lower gear. Tapping the (+) paddle shifters, will upshift the transmission to the next highest gear.

In AutoStick mode, the transmission will shift up or down when (+/-) is manually selected by the driver, unless an engine lugging or overspeed condition would result. It will remain in the selected gear until another upshift or downshift is chosen, except as follows.

- The transmission will automatically downshift as the vehicle slows (to prevent engine lugging) and will display the current gear.
- The transmission will automatically downshift to FIRST gear when coming to a stop. After a stop, the driver should manually upshift (+) the transmission as the vehicle is accelerated.
- You can start out, from a stop, in FIRST or SECOND gear. Tapping (+) at a stop will allow starting in SECOND gear. Starting out in SECOND gear can be helpful in snowy or icy conditions.
- If a requested downshift would cause the engine to overspeed, that shift will not occur.
- The system will ignore attempts to upshift at too low of a vehicle speed.
- Holding the (-) paddle pressed, will downshift the transmission to the lowest gear possible at the current speed.

- Transmission shifting will be more noticeable when AutoStick is enabled.
- The system may revert to automatic shift mode if a fault or overheat condition is detected. The vehicle will force an upshift, but it will stay in AutoStick mode.

To disengage AutoStick mode, push and hold the (+) paddle shifters until "D" is once again indicated in the instrument cluster. You can shift in or out of AutoStick mode at any time without taking your foot off the accelerator pedal.

WARNING!

Do not downshift for additional engine braking on a slippery surface. The drive wheels could lose their grip and the vehicle could skid, causing a collision or personal injury.

SPORT MODE — IF EQUIPPED



SPORT Mode

Your vehicle is equipped with a Sport Mode feature. When activated, the engine and transmission, steering and suspension (if equipped with air suspension) are all set to their SPORT settings. Sport Mode will provide improved throttle response and modified transmission shift points as well as firmer suspension and steering for an enhanced driving experience. This mode may be activated and deactivated by pushing the SPORT ON button on the instrument panel switch bank or by selecting SPORT Mode using the Selec-Terrain switch (if equipped). When Sport Mode has been activated an indicator light will illuminate in the instrument cluster.

FOUR-WHEEL DRIVE OPERATION

The driveline is equipped with a Front Axle Disconnect (FAD) for the one-speed and two-speed drivelines. The FAD operation is fully automated and controlled by the Drivetrain Control Module (DTCM). It does not require any customer input to engage. The FAD is set to connect, disconnect and provide 4WD function based on certain set conditions detected by the DTCM, including but not limited to the following:

- Ambient temperature
- Wipers
- Selec-Terrain mode selection
- Wheel-slip detection

The FAD is actuated only in 4WD HI range and stays connected for 4WD LOW.

QUADRA-TRAC I OPERATING INSTRUCTIONS/PRECAUTIONS — IF EQUIPPED

The Quadra-Trac I is a single-speed (HI range only) transfer case, which enables on-demand four-wheel drive with active torque management. No driver interaction is required. The Brake Traction Control (BTC) system, which combines standard ABS and Traction Control, provides resistance to any wheel that is slipping to allow additional torque transfer to wheels with traction.

NOTE:

The Quadra-Trac I system is not appropriate for conditions where 4WD LOW range is recommended  page 167.

QUADRA-TRAC II OPERATING INSTRUCTIONS/PRECAUTIONS — IF EQUIPPED

The Quadra-Trac II system comes equipped with a customer-selectable electronically operated on-demand transfer case with active torque management in all driveable ranges. This transfer case provides the following operating range positions:

- 4WD HI
- N (NEUTRAL)
- 4WD LOW

When additional tractive effort and torque are required, the 4WD LOW position can be used. The 4WD LOW position is intended for loose, slippery road surfaces only. Driving in the 4WD LOW position on dry, hard-surfaced roads may cause increased tire wear and damage to driveline components.

When operating your vehicle in 4WD LOW, the engine speed is approximately three times that of the normal 4WD HI position at a given road speed. Take care not to overspeed the engine and do not exceed 25 mph (40 km/h).

Proper operation of four-wheel drive vehicles depends on tires of equal size, type, and circumference on each wheel. Any difference will adversely affect performance and function of the transfer case.

Because four-wheel drive provides improved traction, there is a tendency to exceed safe turning and stopping speeds. Do not go faster than road conditions permit.

WARNING!

You or others could be injured or killed if you leave the vehicle unattended with the transfer case in the N (NEUTRAL) position without first fully engaging the parking brake. The transfer case N (NEUTRAL) position disengages both the front and rear drive shafts from the powertrain and will allow the vehicle to roll, even if the transmission is in PARK. The parking brake should always be applied when the driver is not in the vehicle.

SHIFT POSITIONS

For additional information on the appropriate use of each four-wheel drive system mode position, see the following:

4WD HI

This is the default operating range for daily use.

N (NEUTRAL)

This range disengages the driveline from the powertrain. It is used for towing your vehicle behind another vehicle  page 163.

WARNING!

You or others could be injured or killed if you leave the vehicle unattended with the transfer case in the N (NEUTRAL) position without first fully engaging the parking brake. The transfer case N (NEUTRAL) position disengages both the front and rear drive shafts from the powertrain and will allow the vehicle to roll, even if the transmission is in PARK. The parking brake should always be applied when the driver is not in the vehicle.

4WD LOW

This range is for low speed four-wheel drive. It provides an additional gear reduction which allows for increased torque to be delivered to both the front and rear wheels while providing maximum pulling power for loose, slippery road surfaces only. Do not exceed 25 mph (40 km/h).

SHIFTING PROCEDURES

4WD HI To 4WD LOW

With the vehicle at speeds of 0 to 3 mph (0 to 5 km/h), the ignition switch in the ON/RUN position and the engine running, shift the transmission into NEUTRAL (N), push and hold the 4WD LOW button until the 4WD LOW Indicator Light begins to flash in the instrument cluster. When the shift is complete, the 4WD LOW Indicator Light will remain on solid.

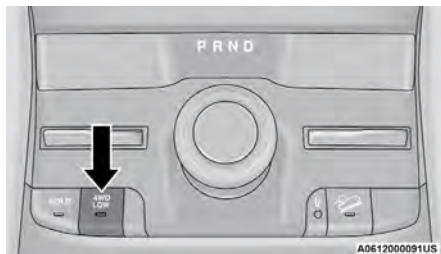

4WD LOW Button

NOTE:

If shift conditions/interlocks are not met, a “To Complete 4WD Shift Put Transmission In Neutral” or a “To Complete 4WD Shift Speed Must Be Below 3 MPH” or a “To Complete 4WD Shift Allow Engine To Return To Idle” message will flash from the instrument cluster display → page 85.

4WD LOW To 4WD HI

With the vehicle at speeds of 0 to 3 mph (0 to 5 km/h), the ignition switch in the ON position or the engine running, shift the transmission into NEUTRAL (N), push and hold the 4WD LOW button until the 4WD LOW Indicator Light begins to flash in the instrument cluster. When the shift is complete, the 4WD LOW Indicator Light will remain off.

NOTE:

- If shift conditions/interlocks are not met — “4WD Shift Canceled” or “4WD Shift Aborted/ Retry Shift” message will be displayed on the instrument cluster. To reattempt shift, put the transmission in NEUTRAL (N) and push and hold the 4WD LOW button.
- If shift conditions/interlocks are not met, a “To Complete 4WD Shift Put Transmission In Neutral” or a “To Complete 4WD Shift Speed Must Be Below 3 MPH” or a “To Complete 4WD Shift Allow Engine To Return To Idle” message will flash from the instrument cluster display → page 85.
- Shifting into or out of 4WD LOW is possible with the vehicle completely stopped; however, difficulty may occur due to the mating clutch teeth not being properly aligned. Several attempts may be required for clutch teeth alignment and shift completion to occur. The preferred method is with the vehicle rolling 0 to 3 mph (0 to 5 km/h). If the vehicle is moving faster than 3 mph (5 km/h), the transfer case will not allow the shift.

QUADRA-TRAC II SYSTEM — IF EQUIPPED

The Quadra-Trac II System features two torque transfer couplings. The couplings include an Electronic Limited-Slip Differential (ELSD) rear axle and the Quadra-Trac II transfer case. The ELSD axle is fully automatic and requires no driver input to operate. Under normal driving conditions, the unit functions as a standard axle, balancing torque evenly between left and right wheels. With a traction difference between left and right wheels, the coupling will sense a speed difference. As one wheel begins to spin faster than the other, torque will automatically transfer from the wheel that has less

traction, to the wheel that has traction. While the transfer case and axle coupling differ in design, their operation is similar. Follow the Quadra-Trac II transfer case shifting information, preceding this section, for shifting this system.

ELECTRONIC SWAY BAR DISCONNECT — IF EQUIPPED

Your vehicle may be equipped with an electronic disconnecting stabilizer/sway bar. This system allows greater front suspension travel in off-road situations.

This system is controlled by the SWAY BAR switch located on the instrument panel (to the right of the gear selector).



SWAY BAR Switch

Push the SWAY BAR switch to activate the system. Push the switch again to deactivate the system. The Sway Bar Indicator Light (located in the instrument cluster) will illuminate when the bar is disconnected. The Sway Bar Indicator Light will flash during activation transition, or when activation conditions are not met. The stabilizer/sway bar should remain in on-road mode during normal driving conditions.

NOTE:

If the electronic disconnecting stabilizer/sway bar is disconnected and then driven at speeds above 18 mph (29 km/h), the system will reconnect for driver safety. The Sway Bar Indicator Light will continue to flash as the system waits for the driver to slow the vehicle and will automatically disconnect again unless the driver cancels the request with the SWAY BAR switch. The system can cancel the pending disconnect request if drive-train changes are made (e.g. 4WD HI to 4WD LOW) based on road conditions.

WARNING!

Ensure the stabilizer/sway bar is reconnected before driving on hard surfaced roads or at speeds above 18 mph (29 km/h); a disconnected stabilizer/sway bar may contribute to the loss of vehicle control, which could result in serious injury. Under certain circumstances, the front stabilizer/sway bar enhances vehicle stability and assists with vehicle control. The system monitors vehicle speed and will attempt to reconnect the stabilizer/sway bar at speeds over 18 mph (29 km/h). This is indicated by a flashing or solid Sway Bar Indicator Light. Once vehicle speed is reduced below 14 mph (22 km/h), the system will once again attempt to return to off-road mode.

To disconnect the stabilizer/sway bar, shift to 4WD LOW and push the SWAY BAR switch to obtain the off-road position ↔ page 112. The Sway Bar Indicator Light will flash until the stabilizer/sway bar has been fully disconnected.

NOTE:

The stabilizer/sway bar may be torque locked due to left and right suspension height differences. This condition is due to driving surface differences or vehicle loading. In order for the stabilizer/sway bar to disconnect/reconnect, the right and left halves of the bar must be aligned. This alignment may require that the vehicle be driven onto level ground or rocked from side to side.

To return to on-road mode, push the SWAY BAR switch again.

WARNING!

If the stabilizer/sway bar will not return to on-road mode, the Sway Bar Indicator Light will flash in the instrument cluster and vehicle stability may be reduced. Do not attempt to drive the vehicle over 18 mph (29 km/h). Driving faster than 18 mph (29 km/h) with a disconnected stabilizer/sway bar may contribute to the loss of vehicle control, which could result in serious injury.

SELEC-TERRAIN — IF EQUIPPED**SELEC-TERRAIN MODE SELECTION**

Selec-Terrain combines the capabilities of the vehicle control systems, along with driver input, to provide the best performance for all terrains. Tap the toggle up or down to cycle through the positions.

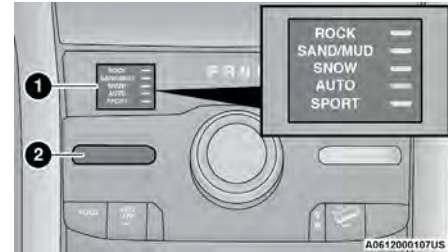
**Selec-Terrain**

- 1 — Selec-Terrain Positions
- 2 — Selec-Terrain Toggle

4

Selec-Terrain consists of the following positions:

- **ROCK** – Off-road calibration is only available in 4WD LOW. The vehicle is raised (if equipped with air suspension) for improved ground clearance. Traction-based tuning with improved steerability for use on high traction off-road surfaces. Use for low speed obstacles such as large rocks, deep ruts, etc. If equipped with air suspension, the vehicle level will change to Off-Road 2 (OR2). If the Selec-Terrain switch is in ROCK mode, and the transfer case is switched from 4WD LOW to 4WD HI, the Selec-Terrain system will return to AUTO.
- **SAND/MUD** – Off-road calibration for use on low traction surfaces such as mud or sand. Driveline is maximized for traction. Some binding may be felt on less forgiving surfaces. The electronic brake controls are set to limit traction control management of throttle and wheel spin. If equipped with air suspension, the level will change to Off-Road 1 (OR1).

- **SNOW** – Tuning set for additional stability in inclement weather. Use on and off-road on loose traction surfaces such as snow. When in SNOW mode (depending on certain operating conditions), the transmission may use SECOND gear (rather than FIRST gear) during launches, to minimize wheel slip-page. If equipped with air suspension, the default ride height for SNOW is Normal Ride Height (NRH).
- **AUTO** – Fully automatic full-time four-wheel drive operation can be used on and off-road. Balances traction with seamless steering feel to provide improved handling and acceleration over two-wheel drive vehicles. If the suspension is already in OR1 or OR2, the vehicle will not lower to NRH with Auto selection as to maintain capability.

NOTE:

If equipped with air suspension, the level will only raise to Normal Ride Height (NRH) in the AUTO mode. If the vehicle is in OR1 or OR2 the height will not lower automatically until defined speed thresholds are exceeded.

- **SPORT** – This mode is only available in 4WD HI. When activated, the engine and transmission, steering and suspension (if equipped with air suspension) are all set to their SPORT settings. SPORT mode will provide improved throttle response and modified transmission shift points as well as firmer suspension and steering, the vehicle will also be dropped to Aero Height for an enhanced driving experience. When SPORT mode has been activated, an indicator light will illuminate in the instrument cluster.

INSTRUMENT CLUSTER DISPLAY MESSAGES

When the appropriate conditions exist, a message will appear in the instrument cluster → page 85.

QUADRA-LIFT — IF EQUIPPED

DESCRIPTION

The Quadra-Lift Air Suspension system provides full time load leveling capability along with the benefit of vehicle height adjustment by a toggle switch. The vehicle will automatically raise and lower the ride height to adapt to the appropriate driving conditions. At higher speeds, the vehicle will lower to an aerodynamic ride height and when operating in off-road modes, the vehicle will raise the ride height accordingly. The buttons near the terrain switch in the center console area can be used to set preferred ride height to match the appropriate conditions.



Quadra-Lift Switch

- 1 – Off-Road 2 Ride Height Indicator Lamp (Customer Selectable)
- 2 – Off-Road 1 Ride Height Indicator Lamp (Customer Selectable)
- 3 – Normal Ride Height Indicator Lamp (Customer Selectable)
- 4 – Aero Ride Height Indicator Lamp (Customer Selectable)
- 5 – Entry/Exit Ride Height Indicator Lamp (Customer Selectable)
- 6 – Toggle Switch

- **Off-Road 2 (OR2) (Non-TrailHawk raises the vehicle approximately 2.4 inches [60 mm]) (TrailHawk raises the vehicle approximately 3.0 inches [75 mm])** – This position is intended for off-road use only where maximum ground clearance is required. To enter OR2, push the UP button twice from the NRH position or once from the OR1 position while vehicle speed is below 20 mph (32 km/h). While in OR2, if the vehicle speed exceeds 25 mph (40 km/h) the vehicle height will be automatically lowered to OR1 → page 166.

- **Off-Road 1 (OR1) (Raises the vehicle approximately 1.6 inches [40 mm])** – This is the primary position for all off-road driving until OR2 is needed. Push the UP button once from the NRH position while the vehicle speed is below 38 mph (61 km/h). When in the OR1 position, if the vehicle speed remains between 40 mph (64 km/h) and 50 mph (80 km/h) for greater than 20 seconds or if the vehicle speed exceeds 50 mph (80 km/h), the vehicle will be automatically lowered to NRH ↪ page 166.
- **Normal Ride Height (NRH) 0.0 inches (0 mm)** – This is the standard position of the suspension and is meant for normal driving.
- **Aero Height (Lowers the vehicle approximately -0.8 inches [-21 mm] Front and -1.0 inches [-25 mm] Rear)** – This position provides improved aerodynamics by lowering the vehicle. The vehicle will automatically enter Aero when the vehicle speed remains between 62 mph (100 km/h) and 66 mph (106 km/h) for greater than 20 seconds or if the vehicle speed exceeds 66 mph (106 km/h). The vehicle will return to NRH from Aero if the vehicle speed remains between 30 mph (48 km/h) and 35 mph (56 km/h) for greater than 20 seconds or if the vehicle speed falls below 30 mph (48 km/h). The vehicle will enter Aero, regardless of vehicle speed if the vehicle is in SPORT mode.
- **Entry/Exit Height (Lowers the vehicle approximately -1.8 inches [-46 mm] Front and -2.0 inches [-50 mm] Rear)** – This position lowers the vehicle for easier passenger entry and exit as well as lowering the rear of the vehicle for easier loading and unloading of cargo. To enter Entry/Exit, push the DOWN button twice from NRH while the vehicle speed is below 4 mph (6 km/h). To exit Entry/Exit, push the UP button twice while in Entry/Exit or drive the vehicle over 6 mph (10 km/h).

NOTE:

Automatic lowering of the vehicle into Entry/Exit can be enabled through the Uconnect Touchscreen Radio by selecting the “Auto Entry/Exit” setting. If this feature is enabled, the vehicle will only lower if the gear selector is in PARK, the terrain switch is in AUTO, the transfer case is in AUTO and the vehicle level is either in Normal or Aero Height. The vehicle will not automatically lower to Entry/Exit height if the air suspension level is in OR2 or OR1. If the vehicle is equipped with Intrusion Theft Module (ITM), the lowering will be suppressed when the ignition is switched OFF and the door is open to prevent setting the alarm off.

The Selec-Terrain system will automatically change the vehicle to the proper height based on the position of the Selec-Terrain switch. The height can be changed from the default Selec-Terrain setting by normal use of the air suspension buttons ↪ page 115.

The system requires that the engine be running for all changes. When lowering the vehicle all of the doors must be closed. If a door is opened at any time while the vehicle is lowering the change will not be completed until the open door(s) is/are closed.

The Quadra-Lift Air Suspension system uses a lifting and lowering pattern which keeps the headlights from incorrectly shining into oncoming traffic. When raising the vehicle, the rear of the vehicle will move up first and then the front. When lowering the vehicle, the front will move down first and then the rear.

After the engine is turned off, it may be noticed that the air suspension system operates briefly; this is normal. The system is correcting the position of the vehicle to ensure a proper appearance.

To assist with changing a spare tire, the Quadra-Lift Air Suspension system has a feature which allows the automatic leveling to be disabled ↪ page 169.

Default Ride Height

- Select Aero Height or Normal Ride Height as the default for all vehicle speeds and operation. This is the selected height that the suspension will level for speed changes (e.g. raising from Entry/Exit Height at speed, lowering from Off Road Height at speed, etc.).
- Default ride height can be changed by manually adjusting the ride height switch to Normal Ride Height or Aero Height and staying in the selected height for 2.5 seconds. It will be stored as the default ride height and the height will be maintained until a new default ride height is selected.

If equipped with a touchscreen radio, all enabling/disabling of air suspension features must be done through the radio ↪ page 169.

WARNING!

The air suspension system uses a high pressure volume of air to operate the system. To avoid personal injury or damage to the system, see an authorized dealer for service.

AIR SUSPENSION MODES

The Air Suspension system has multiple modes to protect the system in unique situations:

Tire/Jack Mode

To assist with changing a spare tire, the air suspension system has a feature which allows the automatic leveling to be disabled ↪ page 169.

NOTE:

This mode is intended to be enabled with the ignition on.

Auto Entry/Exit Mode

To assist in entering and exiting the vehicle, the air suspension system has a feature which automatically lowers the vehicle to Entry/Exit ride height ↪ page 169.

NOTE:

This mode is intended to be enabled with the ignition on.

Transport Mode

To assist with flat bed towing, the air suspension system has a feature which will put the vehicle into Entry/Exit height and disable the automatic load leveling system ↪ page 169.

NOTE:

This mode is intended to be enabled with the ignition on.

Suspension Display Messages Mode

The "Suspension Display Messages" setting allows you to only display suspension warnings ↪ page 169.

NOTE:

This mode is intended to be enabled with the ignition on.

Wheel Alignment Mode

Before performing a wheel alignment this mode must be enabled ↪ page 169.

NOTE:

This mode is intended to be enabled with the ignition on.

If equipped with a touchscreen radio, all enabling/disabling of air suspension features must be done through the radio ↪ page 169.

INSTRUMENT CLUSTER DISPLAY MESSAGES

When the appropriate conditions exist, a message will appear in the instrument cluster ↪ page 85.

OPERATION

The indicator lamps 1 through 5 will illuminate to show the current position of the vehicle. Flashing indicator lamps will show a position which the system is working to achieve. When raising, if multiple indicator lamps are flashing while raising, the highest flashing indicator lamp is the position the system is working to achieve. When lowering, if multiple indicators are flashing while lowering, the lowest solid indicator lamp is the position the system is working to achieve.

Toggle up once will move the suspension one position higher from the current position, assuming all conditions are met (i.e. ignition on, speed below threshold, etc). Toggle up can be pushed multiple times. Each toggle up will raise the requested level by one position up to a maximum position of OR2 or the highest position allowed based on current conditions (i.e. vehicle speed, etc).

Toggle down once will move the suspension one position lower from the current level, assuming all conditions are met (i.e. ignition on, doors closed, speed below threshold, etc). Toggle down can be pushed multiple times. Each toggle down will lower the requested

level by one position down to a minimum of Entry/Exit Height or the lowest position allowed based on current conditions (i.e. vehicle speed, etc.)

Automatic height changes will occur based on vehicle speed and the current vehicle height. The indicator lamps and instrument cluster display messages will operate the same for automatic changes and user requested changes.

- Off-Road 2 (OR2) Ride Height – Indicator lamps 1 through 5 will be illuminated.
- Off-Road 1 (OR1) Ride Height – Indicator lamps 2 through 5 will be illuminated.
- Normal Ride Height (NRH) – Indicator lamps 3 through 5 will be illuminated.
- Aero Ride Height – Indicator lamps 4 and 5 will be illuminated.
- Entry/Exit Ride Height – Indicator lamp 5 will be illuminated.
- Transport Mode – Indicator lamp 5 will be illuminated. Driving above 3 mph (5 km/h) or deselecting setting in the radio will disable Transport Mode.
- Tire/Jack Mode – Indicator lamps 3 through 5 will be illuminated. Driving above 5 mph (8 km/h) or deselecting setting in the radio will disable Tire/Jack Mode.
- Wheel Alignment Mode – Indicator lamps 3 through 5 will be illuminated. Driving above 5 mph (8 km/h) or deselecting setting in the radio will disable Wheel Alignment Mode.

FUEL SAVER TECHNOLOGY 5.7L ONLY

This feature offers improved fuel economy by shutting off four of the engine's eight cylinders during light load and cruise conditions. The system is automatic with no driver inputs or additional driving skills required.

NOTE:

This system may take some time to return to full functionality after a battery disconnect.

POWER STEERING

The electric power steering system will provide increased vehicle response and ease of maneuverability. The electric power steering system adapts to different driving conditions.

WARNING!

Continued operation with reduced assist could pose a safety risk to yourself and others. Service should be obtained as soon as possible.

NOTE:

Alternate electric power steering efforts can be selected through the Uconnect system. Refer to [page 169](#).



If the Electric Power Steering warning icon is displayed and the "Service Power Steering" or the "Power Steering Assist Off - Service System" message is displayed within the instrument cluster display, this indicates the vehicle needs to be taken to an authorized dealer for service. Refer to [page 93](#).

If the Electric Power Steering warning icon is displayed and the "Power Steering System Over Temp" message is displayed on the instrument cluster display, this indicates an over temperature condition in the power steering system. Once driving conditions are safe, pull over and let the vehicle idle for a few moments until the icon and message turn off.

NOTE:

- Even if the power steering assistance is no longer operational, it is still possible to steer the vehicle. Under these conditions there will be a substantial increase in steering effort, especially at low speeds and during parking maneuvers.
- If the condition persists, see an authorized dealer for service.

STOP/START SYSTEM — IF EQUIPPED

The Stop/Start function is designed to reduce fuel consumption. The system will stop the engine automatically during a vehicle stop if the required conditions are met. Releasing the brake pedal or pressing the accelerator pedal will automatically re-start the engine.

This vehicle has been upgraded with a heavy-duty starter, enhanced battery, and other upgraded engine parts, to handle the additional engine starts.

AUTOSTOP MODE

The Stop/Start feature is enabled after every normal customer engine start. At that time, the system will go into STOP/START READY and if all other conditions are met, can go into a STOP/START AUTOSTOP ACTIVE Autostop mode.

To Activate The Autostop Mode, The Following Must Occur:

- The system must be in STOP/START READY state. A STOP/START READY message will be displayed in the instrument cluster display within the Stop/Start section [page 85](#).
- The vehicle must be completely stopped.
- The gear selector must be in a forward gear and the brake pedal pressed.

The engine will shut down, the tachometer will move to the zero position and the Stop/Start telltale will illuminate indicating you are in Autostop. Customer settings will be maintained upon return to an engine running condition.

POSSIBLE REASONS THE ENGINE DOES NOT AUTOSTOP

Prior to engine shut down, the system will check many safety and comfort conditions to see if they are fulfilled. Detailed information about the operation of the Stop/Start system may be viewed in the instrument cluster display Stop/Start screen. In the following situations, the engine will not stop:

- Driver's seat belt is not buckled.
- Driver's door is not closed.
- Battery temperature is too warm or cold.
- Battery charge is low.
- The vehicle is on a steep grade.
- Cabin heating or cooling is in process and an acceptable cabin temperature has not been achieved.
- HVAC is set to full defrost mode at a high blower speed.
- HVAC is set to MAX A/C.

- Engine has not reached normal operating temperature.
- The transmission is not in a forward gear.
- Hood is open.
- Brake pedal is not pressed with sufficient pressure.
- Accelerator pedal input.
- Engine temperature is too high.
- 5 mph (8 km/h) threshold has not been achieved from previous Autostop.
- Steering angle is beyond threshold.

It may be possible for the vehicle to be driven several times without the Stop/Start system going into a STOP/START READY state under more extreme conditions of the previously listed items.

TO START THE ENGINE WHILE IN AUTOSTOP MODE

While in a forward gear, the engine will start when the brake pedal is released or the throttle pedal is pressed. The transmission will automatically re-engage upon engine restart.

Conditions That Will Cause The Engine To Start Automatically While In Autostop Mode:

- The transmission selector is moved out of DRIVE.
- To maintain cabin temperature comfort.
- HVAC is set to full defrost mode.
- HVAC system temperature or fan speed is manually adjusted.
- Battery voltage drops too low.
- Stop/Start OFF switch is pushed.
- A Stop/Start system error occurs.
- Steering angle is beyond threshold.

TO MANUALLY TURN OFF THE STOP/START SYSTEM



Stop/Start OFF Switch

Push the Stop/Start OFF switch (located on the switch bank). The light on the switch will illuminate. The “Stop/Start OFF” message will appear in the instrument cluster display and the Autostop mode will be disabled page 85.

NOTE:

The Stop/Start system will reset itself back to the ON mode every time the ignition is turned OFF and back ON.

TO MANUALLY TURN ON THE STOP/START SYSTEM

Push the Stop/Start OFF switch (located on the switch bank). The light on the switch will turn off.

SYSTEM MALFUNCTION

If there is a malfunction in the Stop/Start system, the system will not shut down the engine. A “Service Stop/Start System” message and a yellow Stop/Start telltale will appear in the instrument cluster display page 85.

If the “Service Stop/Start System” message appears in the instrument cluster display, have the system checked by an authorized dealer.

CRUISE CONTROL SYSTEMS

Your vehicle is equipped with the Adaptive Cruise Control (ACC) system which will adjust the vehicle speed up to the preset speed to maintain a distance with the vehicle ahead.

NOTE:

In vehicles **NOT** equipped with the Active Driving Assist (ADA) system:

- Fixed Speed Cruise Control can be used when ACC is not enabled, and functions as normal cruise control.
- Fixed Speed Cruise Control will not detect vehicles directly ahead of you. Always be aware of the feature selected.
- Only one Cruise Control feature can operate at a time. For example, if Fixed Speed Cruise Control is enabled, Adaptive Cruise Control will be unavailable, and vice versa.

ADAPTIVE CRUISE CONTROL (ACC)

Adaptive Cruise Control (ACC) increases the driving convenience provided by Cruise Control while traveling on highways and major roadways. However, it is not a safety system and not designed to prevent collisions.

ACC will allow you to keep Cruise Control engaged in light to moderate traffic conditions without the constant need to reset your Cruise Control. ACC utilizes a radar sensor and a forward facing camera designed to detect a vehicle directly ahead of you.

NOTE:

- If the ACC sensor detects a vehicle ahead, ACC will apply limited braking or acceleration (not to exceed the original set speed) automatically to maintain a preset following distance, while matching the speed of the vehicle ahead.
- Any chassis/suspension or tire size modifications to the vehicle will affect the performance of the Adaptive Cruise Control and Forward Collision Warning system.
- In vehicles **NOT** equipped with the Active Driving Assist system, Fixed Speed Cruise Control (ACC not enabled) will not detect vehicles directly ahead of you. Always be aware of the feature selected  page 331.

WARNING!

- Adaptive Cruise Control (ACC) is a convenience system. It is not a substitute for active driver involvement. It is always the driver's responsibility to be attentive of road, traffic, and weather conditions, vehicle speed, distance to the vehicle ahead and, most importantly, brake operation to ensure

(Continued)

WARNING!

safe operation of the vehicle under all road conditions. Your complete attention is always required while driving to maintain safe control of your vehicle. Failure to follow these warnings can result in a collision and death or serious personal injury.

- The ACC system:
 - Does not react to pedestrians, oncoming vehicles, and stationary objects (e.g., a stationary vehicle in a traffic jam or a disabled vehicle).
 - Cannot take street, traffic, and weather conditions into account, and may be limited upon adverse sight distance conditions.
 - Does not always fully recognize complex driving conditions, which can result in wrong or missing distance warnings.
 - Will bring the vehicle to a complete stop and hold the vehicle in the stop position for approximately 10 minutes when following a vehicle ahead. If the vehicle ahead does not start moving within 10 minutes, the parking brake will be activated, and the ACC system will be canceled.
- You should not utilize the ACC system:
 - When driving in fog, heavy rain, heavy snow, sleet, heavy traffic, and complex driving situations (i.e., in highway construction zones).
 - When entering a turn lane or highway off-ramp; when driving on roads that are winding, icy, snow-covered, slippery, or have steep uphill or downhill slopes.
 - When towing a trailer up or down steep slopes.
 - When circumstances do not allow safe driving at a constant speed.

Adaptive Cruise Control (ACC) Operation

The buttons on the right side of the steering wheel operate the ACC system.

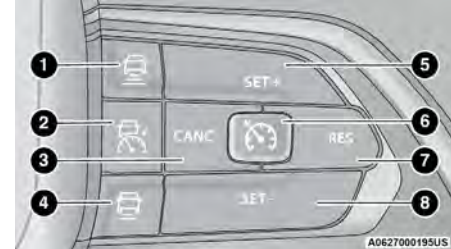

Adaptive Cruise Control Buttons

- 1 — Distance Increase Button
- 2 — Adaptive Cruise Control (ACC) On/Off
- 3 — CANCEL/Cancel
- 4 — Distance Decrease Button
- 5 — SET (+)/Accel
- 6 — Fixed Speed Cruise Control On/Off (if Equipped)
- 7 — RES/Resume
- 8 — SET (-)/Decel

Driving Assist Menu

The instrument cluster display will show the current system settings for Adaptive Cruise Control (ACC), Active Lane Management (ALM), and the Active Driving Assist (ADA) systems. The information it displays depends on ACC, ALM, and ADA system statuses.

Pushing the Adaptive Cruise Control (ACC) buttons will display one of the following messages in the instrument cluster display:

Adaptive Cruise Control Ready

When ACC is activated but the vehicle speed setting has not been selected, the display will read “Adaptive Cruise Control Ready.”

Adaptive Cruise Control Set

When the SET (+) or the SET (-) button is pushed, the display will read “ACC: XX mph (km/h)”.

When ACC is set, the set speed will show in the instrument cluster display.

The ACC screen may display once again if any of the following ACC activity occurs:

- System Cancel
- Driver Override
- System Off
- ACC Proximity Warning
- ACC Unavailable Warning

Adaptive Cruise Control Off

When ACC is deactivated, the display will read “Adaptive Cruise Control Off”.

The instrument cluster display will return to the last display selected after five seconds of no ACC display activity.

Activating Adaptive Cruise Control (ACC)

The minimum set speed for the ACC system is 20 mph (32 km/h).

When the system is turned on and in the ready state, the instrument cluster display will read “ACC Ready.”

When the system is off, the instrument cluster display will read “Adaptive Cruise Control (ACC) Off.”

NOTE:

You cannot engage ACC under the following conditions:

- When in 4WD Low
- When the brakes are applied
- When the parking brake is applied
- When the transmission is in PARK, REVERSE or NEUTRAL
- When the brakes are overheated
- When the driver’s door is open at low speeds
- When the driver’s seat belt is unbuckled at low speeds
- When there is a stationary vehicle in front of your vehicle in close proximity
- When Electronic Stability Control (ESC) Full Off mode is active

To Activate/Deactivate

Push and release the Adaptive Cruise Control (ACC) on/off button. The ACC menu in the instrument cluster displays “ACC Ready.”

To turn the system off, push and release the Adaptive Cruise Control (ACC) on/off button again. At this time, the system will turn off and the instrument cluster displays “Adaptive Cruise Control (ACC) Off.”

WARNING!

Leaving the Adaptive Cruise Control (ACC) system on when not in use is dangerous. You could accidentally set the system or cause it to go faster than you want. You could lose control and have a collision. Always leave the system off when you are not using it.

To Set A Desired Speed

When the vehicle reaches the speed desired, push the SET (+) button or the SET (-) button and release. The instrument cluster display will show the set speed.

NOTE:

Fixed Speed Cruise Control (if equipped) is used without ACC enabled. To change between Adaptive Cruise Control (ACC) and Fixed Speed Cruise Control features, first turn off ACC by pushing the ACC on/off button. Then, turn on Fixed Speed Cruise Control by pushing the Fixed Speed Cruise Control on/off button.

WARNING!

In Fixed Speed Cruise Control mode, the system will not react to vehicles ahead. In addition, the proximity warning does not activate and no alarm will sound even if you are too close to the vehicle ahead since neither the presence of the vehicle ahead nor the vehicle-to-vehicle distance is detected. Be sure to maintain a safe distance between your vehicle and the vehicle ahead. Always be aware which mode is selected.

If ACC is set when the vehicle speed is **below** 20 mph (32 km/h), the set speed will default to 20 mph (32 km/h).

NOTE:

Fixed Speed Cruise Control cannot be set below 20 mph (32 km/h).

If either system is set when the vehicle speed is **above** 20 mph (32 km/h), the set speed shall be the current speed of the vehicle.

NOTE:

- Keeping your foot on the accelerator pedal can cause the vehicle to continue to accelerate beyond the set speed. If this occurs, the message "DRIVER OVERRIDE" will display in the instrument cluster display.
- If you continue to accelerate beyond the set speed while ACC is enabled, the system will not be controlling the distance between your vehicle and the vehicle ahead. The vehicle speed will only be determined by the position of the accelerator pedal.

To Cancel

The following conditions cancel the ACC or Fixed Speed Cruise Control systems:

- The brake pedal is applied
- The CANCEL (cancel) button is pushed
- The gear selector is removed from the DRIVE position
- The Electronic Stability Control/Traction Control System (ESC/TCS) activates
- The vehicle parking brake is applied
- The Trailer Sway Control (TSC) activates
- The braking temperature exceeds normal range (overheated)

The following conditions will only cancel the ACC system:

- Driver seat belt is unbuckled at low speeds
- Driver door is opened at low speeds

To Turn Off

The system will turn off and erase the set speed in memory if:

- The Adaptive Cruise Control (ACC) on/off button is pushed
- Fixed Speed Cruise Control on/off button is pushed
- The ignition is placed in the OFF position
- 4WD Low is engaged
- The Active Driving Assist (ADA) system (if equipped) is enabled/engaged and the ADA button is pressed

NOTE:

If ADA is not enabled/engaged and the ADA button is pressed, the ACC system will remain on or turn on, depending on the state of ACC at the time of the ADA button press.

To Resume

If there is a set speed in memory, push the RES (resume) button and remove your foot from the accelerator pedal. The instrument cluster display will show the last set speed.

Resume can be used at any speed above 20 mph (32 km/h) when only Fixed Speed Cruise Control is being used.

Resume can be used at any speed above 0 mph (0 km/h) when ACC is active.

NOTE:

- While in ACC mode, when the vehicle comes to a complete stop longer than two seconds, the driver will either have to push the RES (resume) button or press the accelerator pedal to reengage the ACC system.
- ACC cannot be resumed if there is a stationary vehicle in front of your vehicle in close proximity.

WARNING!

The Resume function should only be used if traffic and road conditions permit. Resuming a set speed that is too high or too low for prevailing traffic and road conditions could cause the vehicle to accelerate or decelerate too sharply for safe operation. Failure to follow these warnings can result in a collision and death or serious personal injury.

To Vary The Speed Setting**To Increase Or Decrease The Set Speed**

After setting a speed, you can increase the set speed by pushing the SET (+) button, or decrease speed by pushing the SET (-) button.

U.S. Speed (mph)

- Pushing the SET (+), or SET (-) button once will result in a 1 mph speed adjustment. Each subsequent tap of the button results in an adjustment of 1 mph.
- If the button is continually pushed, the set speed will continue to adjust in 5 mph increments until the button is released. The new set speed is reflected in the instrument cluster display.

Metric Speed (km/h)

- Pushing the SET (+), or SET (-) button once will result in a 1 km/h speed adjustment. Each subsequent tap of the button results in an adjustment of 1 km/h.
- If the button is continually pushed, the set speed will continue to adjust in 10 km/h increments until the button is released. The new set speed is reflected in the instrument cluster display.

NOTE:

When you override and push the SET (+) button or SET (-) button, the new set speed will be the current speed of the vehicle.

When ACC Is Active

- When you use the SET (-) button to decelerate, if the engine's braking power does not slow the vehicle sufficiently to reach the set speed, the brake system will automatically slow the vehicle.
- The ACC system decelerates the vehicle to a full stop when following the vehicle in front. If your vehicle follows the vehicle in front to a standstill, after two seconds the driver will either have to push the RES (resume) button, or apply the accelerator pedal to reengage the ACC to the existing set speed.
- The ACC system maintains set speed when driving uphill and downhill. However, a slight speed change on moderate hills is normal. In addition, downshifting may occur while climbing uphill or descending downhill. This is normal operation and necessary to maintain set speed. When driving uphill and downhill, the ACC system will cancel if the braking temperature exceeds normal range (overheated).

Setting The Following Distance In ACC

The specified following distance for ACC can be set by varying the distance setting between four bars (longest), three bars (long), two bars (medium) and one bar (short). Using this distance setting and the vehicle speed, ACC calculates and sets the distance to the vehicle ahead. This distance setting appears in the instrument cluster display.

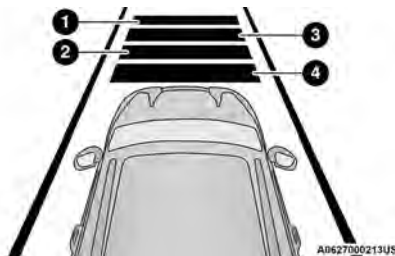
**Distance Settings**

- 1 — Longest Distance Setting (Four Bars)
- 2 — Medium Distance Setting (Two Bars)
- 3 — Long Distance Setting (Three Bars)
- 4 — Short Distance Setting (One Bar)

To increase the distance setting, push the Distance Increase button and release. Each time the button is pushed, the distance setting increases by one bar (longer).

To decrease the distance setting, push the Distance Decrease button and release. Each time the button is pushed, the distance setting decreases by one bar (shorter).

If there is no vehicle ahead, the vehicle will maintain the set speed. If a slower moving vehicle is detected in the same lane, the instrument cluster display will show the ACC Set With Target Detected Indicator Light, and the system will adjust the vehicle speed automatically to maintain the distance setting, regardless of the set speed.

The vehicle will then maintain the set distance until:

- The vehicle ahead accelerates to a speed above the set speed.
- The vehicle ahead moves out of your lane or view of the sensor.
- The distance setting is changed.
- The system disengages → page 122.

The maximum braking applied by ACC is limited; however, the driver can always apply the brakes manually, if necessary.

NOTE:

The brake lights will illuminate whenever the ACC system applies the brakes.

A Proximity Warning will alert the driver if ACC predicts that its maximum braking level is not sufficient to maintain the set distance. If this occurs, a visual alert "BRAKE!" will flash in the instrument cluster display and a chime will sound while ACC continues to apply its maximum braking capacity.

NOTE:

The "BRAKE!" screen in the instrument cluster display is a warning for the driver to take action and does not necessarily mean that the Forward Collision Warning system is applying the brakes autonomously.

Overtake Aid

When driving with Adaptive Cruise Control (ACC) engaged and following a vehicle, the system will provide an additional acceleration up to the ACC set speed to assist in passing the vehicle. This additional acceleration is triggered when the driver utilizes the left turn signal and will only be active when passing on the left hand side.

ACC Operation At Stop

If the ACC system brings your vehicle to a standstill while following a vehicle ahead, your vehicle will resume motion, without any driver interaction, if the vehicle ahead starts moving within two seconds of your vehicle coming to a standstill.

If the vehicle in front does not start moving within two seconds of your vehicle coming to a standstill, the driver will either have to push the RES (resume) button, or apply the accelerator pedal to reengage the ACC to the existing set speed.

NOTE:

- If your vehicle is at a standstill for longer than two seconds, the system will hold brake pressure for up to 10 minutes. If no driver action is taken after the 10 minutes, the Electric Park Brake will be applied and the ACC system will cancel.
- While ACC is holding your vehicle at a standstill (or the vehicle is traveling below 3 mph (5 km/h), and the driver seat belt is unbuckled or the driver door is opened, the Electric Park Brake will be applied and the ACC system will cancel.

WARNING!

When the ACC system is resumed, the driver must ensure that there are no pedestrians, vehicles or objects in the path of the vehicle. Failure to follow these warnings can result in a collision and death or serious personal injury.

Display Warnings And Maintenance

“WIPE FRONT RADAR SENSOR IN FRONT OF VEHICLE” WARNING

The “ACC Unavailable Wipe Front Radar Sensor” warning will display and a chime will sound when conditions temporarily limit system performance.

This most often occurs at times of poor visibility, such as in snow or heavy rain. The ACC system may also become temporarily blinded due to obstructions, such as mud, dirt or ice. In these cases, the instrument cluster display will display the previously listed message and the system will deactivate.

This message can sometimes be displayed while driving in highly reflective areas (i.e. ice and snow, or tunnels with reflective tiles). The ACC system will recover after the vehicle has left these areas. Under rare conditions, when the radar is not tracking any vehicles or objects in its path, this warning may temporarily occur.

NOTE:

If the “ACC Unavailable Wipe Front Radar Sensor” warning is active, Fixed Speed Cruise Control is still available.

If weather conditions are not a factor, the driver should examine the sensor. It may require cleaning or removal of an obstruction. The sensor is located in the center of the vehicle behind the lower grille.

To keep the ACC System operating properly, it is important to note the following maintenance items:

- Always keep the sensor clean. Carefully wipe the sensor lens with a soft cloth. Be cautious not to damage the sensor lens.
- Do not remove any screws from the sensor. Doing so could cause an ACC system malfunction or failure and require a sensor realignment.
- If the sensor or front end of the vehicle is damaged due to a collision, see your authorized dealer for service.
- Do not attach or install any accessories near the sensor, including transparent material or aftermarket grilles. Doing so could cause an ACC system failure or malfunction.

When the condition that deactivated the system is no longer present, the system will return to the “Adaptive Cruise Control Off” state and will resume function by simply reactivating it.

NOTE:

- If the “ACC Unavailable Wipe Front Radar Sensor” message occurs frequently (e.g. more than once on every trip) without any snow, rain, mud, or other obstructions, have the radar sensor realigned at an authorized dealer.
- Installing a snowplow, front-end protector, an aftermarket grille or modifying the grille is not recommended. Doing so may block the sensor and inhibit ACC operation.

“CLEAN FRONT WINDSHIELD” WARNING

The “ACC Limited Functionality Clean Front Windshield” warning will display, and a chime will sound when conditions temporarily limit system performance. This most often occurs at times of poor visibility, such as in snow or heavy rain and fog. The ACC system may also become temporarily blinded due to obstructions, such as mud, dirt, or ice on windshield and fog on the inside of glass. In these cases, the instrument cluster display will read “ACC Limited Functionality Clean Front Windshield” and the system will have degraded performance.

This message can sometimes be displayed while driving in adverse weather conditions. The ACC system will recover after the vehicle has left these areas. Under rare conditions, when the camera is not tracking any vehicles or objects in its path this warning may temporarily occur.

If weather conditions are not a factor, the driver should examine the windshield and the camera located on the back side of the inside rearview mirror. They may require cleaning or removal of an obstruction.

When the condition that created limited functionality is no longer present, the system will return to full functionality.

NOTE:

If the “ACC Limited Functionality Clean Front Windshield” message occurs frequently (e.g. more than once on every trip) without any snow, rain, mud, or other obstructions, have the windshield and forward facing camera inspected at an authorized dealer.

SERVICE ACC WARNING

If the system turns off, and the instrument cluster display reads “ACC Unavailable Service Required” or “Cruise Unavailable Service Required”, there may be an internal system fault or a temporary malfunction that limits ACC functionality. Although the vehicle is still drivable under normal conditions, ACC will be temporarily unavailable. If this occurs, try activating ACC again later, following an ignition cycle. If the problem persists, see an authorized dealer.

Precautions While Driving With ACC

In certain driving situations, ACC may have detection issues. In these cases, ACC may brake late or unexpectedly. The driver needs to stay alert and may need to intervene. The following are examples of these types of situations:

TOWING A TRAILER

Towing a trailer is not recommended when using ACC.

OFFSET DRIVING

ACC may not detect a vehicle in the same lane that is offset from your direct line of travel, or a vehicle merging in from a side lane. There may not be sufficient distance to the vehicle ahead. The offset vehicle may move in and out of the line of travel, which can cause your vehicle to brake or accelerate unexpectedly.

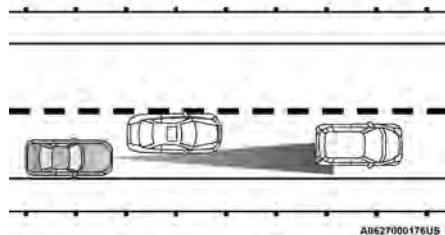

Offset Driving Condition Example

TURN AND BENDS

When driving on a curve with ACC engaged, the system may increase or decrease the vehicle speed for stability, with no vehicle ahead detected. Once the vehicle is out of the curve, the system will resume your original set speed. This is a part of normal ACC system functionality.

NOTE:

On tight turns ACC performance may be limited.

USING ACC ON HILLS

ACC performance may be limited when driving on hills. ACC may not detect a vehicle in your lane depending on the speed, vehicle load, traffic conditions, and the steepness of the hill.



AD627000175US

ACC Hill Example

LANE CHANGING

ACC may not detect a vehicle until it is completely in the lane in which you are traveling. In the following lane changing example, ACC has not yet detected the vehicle changing lanes and it may not detect the vehicle until it is too late for the ACC system to take action. ACC may not detect a vehicle until it is completely in the lane. There may not be sufficient distance to the lane-changing vehicle. Always be attentive and ready to apply the brakes if necessary.

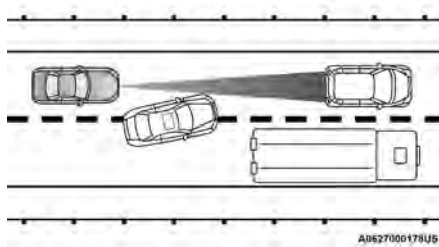

AD627000178US

Lane Changing Example

NARROW VEHICLES

Some narrow vehicles traveling near the outer edges of the lane or edging into the lane are not detected until they have moved fully into the lane. There may not be sufficient distance to the vehicle ahead.

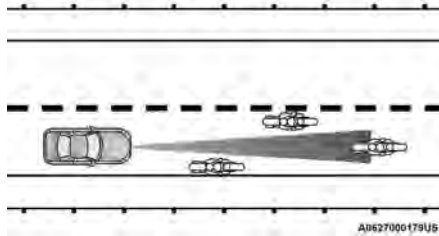

AD627000179US

Narrow Vehicle Example

STATIONARY OBJECTS AND VEHICLES

ACC does not react to stationary objects or vehicles. For example, ACC will not react in situations where the vehicle you are following exits your lane and the vehicle ahead is stopped in your lane. It will consider this stopped vehicle a stationary object as it did not previously detect movement from it. Always be attentive and ready to apply the brakes if necessary.

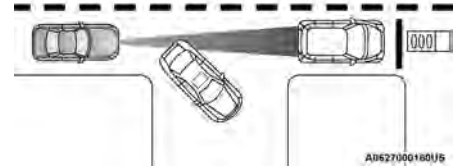

AD627000180US

Stationary Object And Stationary Vehicle Example

TRAFFIC SIGN ASSIST SYSTEM — IF EQUIPPED

The Traffic Sign Assist (TSA) system uses a camera mounted on the windshield, as well as map data when the vehicle is equipped with Navigation, to detect recognizable road signs such as:

- Speed limits
- School zones
- No passing zones

NOTE:

- The TSA system will automatically display the detected road sign using the unit of measurement (mph or km/h) selected within the instrument cluster display.
- If no speed limit signs are detected, the system will revert to the speed limit signs that are stored in the Navigation system.
- The system always checks the traffic signs indicating the current speed limit. The system is able to recognize and display up to two different road signs in the instrument cluster display. These road signs can be found on the Driver Assist page.

ACTIVATION/DEACTIVATION

The TSA System can be enabled/disabled within the Uconnect system through the Safety/Driver Assistance menu. System ON is signaled by road signs shown on the instrument cluster display.

NOTE:

Even if the system is OFF, the speed limit sign will be displayed when the driver selects it on the HOME screen.

TRAFFIC SIGN ASSIST MODES

TSA has three selectable modes of operation that are available through the Uconnect system ↗ page 169.

Visual

When Visual is selected, the system will alert the driver when the current speed of the vehicle exceeds the detected speed limit by showing a graphic in the instrument cluster display.

Visual + Chime

When Visual + Chime is selected, the system will alert the driver when the current speed of the vehicle exceeds the detected speed limit by showing a graphic in the instrument cluster display, and by sounding an audible alert. The audible alert will last for 10 seconds, and the visual alert will remain on as long as the vehicle is exceeding the speed limit.

TSA Off

When the TSA system is turned off, the system will not show any traffic signs (unless selected in the HOME screen, which will show detected speed limit signs), and no alerts will be issued to the driver.

INDICATIONS ON THE DISPLAY

Detected traffic signs are shown in the instrument cluster display, and can display any combination of signs at one time (e.g. speed limit, speed limit and supplemental info, and "Do Not Pass" signs) depending on what information is available.

When a newly detected speed limit is higher than the current speed limit, the display will update along with an up arrow.

When a newly detected speed limit is lower than the current speed limit, the display will update along with a down arrow.

NOTE:

Up or down arrows will be displayed for up to five seconds.

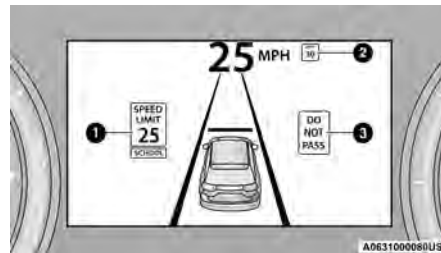

Traffic Signs Recognized

- 1 — Current Speed Limit With Supplemental Information (School Zone)
- 2 — Next Speed Limit Detected
- 3 — No Passing Zone Detected

Supplemental Information

Supplemental information may be displayed, along with a newly detected speed limit, indicating special circumstances of which the driver should be aware. Available supplemental information includes:

- School
- Construction
- Rain
- Snow
- Fog

NOTE:

Supplemental information will not be displayed when the vehicle is ONLY equipped with GPS.

Speed Limit Exceeded

When the vehicle's speed exceeds the displayed speed limit by 3 mph (5 km/h), the speed limit sign on the instrument cluster display will show a red outline to alert the driver.

CAUTION!

- Traffic Sign Assist is designed to assist the driver and not to substitute the driver. It is the driver's responsibility to continue to monitor the vehicle speed.
- Functionality may be limited or the system may not work if the sensor is obstructed.
- The system may have limited operation or not work at all in weather conditions such as heavy rain, hail, and thick fog. Strong light contrasts can influence the recognition capability of the sensor.

(Continued)

CAUTION!

- The area surrounding the sensor must not be covered with stickers or any other object.
- Do not tamper or perform any operations in the area of the windshield glass directly surrounding the sensor.
- Clean foreign matters such as bird droppings, insects, snow or ice on the windshield. For glass cleaning recommendations, see  page 320.

ACTIVE DRIVING ASSIST SYSTEM — IF EQUIPPED

OPERATION

The Active Driving Assist (ADA) system is combined with the Adaptive Cruise Control (ACC) system, and centers the vehicle in the driving lane while traveling at speeds up to 90 mph (145 km/h).

For ACC system operating instructions and system limitations, see  page 121.

NOTE:

- The driver should always obey traffic laws and speed limits. Never drive above applicable speed limit restrictions.
- The driver can override ADA at any time by braking, accelerating, or steering the vehicle.

Just like ACC, ADA will maintain a set speed as long as the set distance between your vehicle and the vehicle in front is maintained. ADA will also keep your vehicle centered between the lane lines, and monitor for other vehicles in adjacent lanes by utilizing the Blind Spot Monitoring sensors.

Two types of Active Driving Assist systems are available:

- Base ADA system
- Hands-Free ADA system

Base Active Driving Assist System — If Equipped

The Base ADA system uses sensors within the steering wheel to measure driver attentiveness, and requires that the driver have their hands on the steering wheel at all times.

The system will generally aim to keep the vehicle centered in the lane, but when the driver turns the steering wheel (e.g. to move farther away from a large vehicle in an adjacent lane) the system will reduce its control and enter "co-steering" mode. While in co-steering mode, the system will provide reduced assistance and allow the driver to control the path of the vehicle. Once the driver stops providing input to the steering wheel, the system will require a few seconds to fully resume lane centering assistance, especially during curves.

Hands-Free Active Driving Assist System — If Equipped

The Hands-Free ADA system uses sensors within the steering wheel and a driver monitoring camera located on top of the steering column to monitor driver attentiveness. The Hands-Free ADA system allows the driver to remove their hands from the steering wheel when engaged, but requires that the driver continue to pay attention to the road.

The Hands-Free ADA system will also change lanes when a turn signal is activated if the adjacent lane in the direction indicated is clear of another vehicle, and lane markings are detected (noted by a dashed line in the direction of the available lane change). The system uses sensors, including Blind Spot Monitoring (BSM) sensors, to determine if a lane change is possible. If the assisted lane change is in progress, a green arrow will appear. If a lane change is requested but the direction indicated is not possible, a yellow arrow will appear. Once conditions are clear, the arrow will turn green and the assisted lane change will begin.



Additionally, Hands-Free ADA will slow the vehicle down and issue a warning light within the instrument cluster display when approaching and going through sharp curves.



Assisted Lane Change (Green Left Arrow)

WARNING!

The driver is always responsible for determining if a lane change is safe. Failure to follow this warning can result in a collision and death or serious personal injury.

Extended Auto Resume

If equipped with Hands-Free ADA and the system brings your vehicle to a stop while following the vehicle ahead, your vehicle will automatically resume driving without driver input when the path in front of the vehicle is clear and the driver is attentive. The path in front of the vehicle is determined to be clear based on the forward facing camera, front radars, and front ultrasonic sensors.

If the vehicle in front does not start moving after 10 minutes, the Electric Park Brake (EPB) will be applied and the system will cancel.

NOTE:

- The Hands-Free Active Driving Assist system is only available on approved compatible roadways. Please consult the Jeep® website for further details on compatible roadways.
- The Hands-Free Active Driving Assist system requires an active subscription through the Jeep® Connect (Uconnect Connected Services) package. If the ADA on/off button is pushed without an active subscription, the instrument cluster display will show the message “Active Driving Assist Unavailable Update Subscription”. Refer to the Uconnect Owner’s Manual Supplement for further information.

- If previously disabled, activating the Hands-Free Active Driving Assist system will also activate the Forward Collision Warning and Pedestrian Emergency Braking systems → page 215.
- If the vehicle is equipped with the Jeep® Connect (Uconnect Connected Services) package, additional data may be collected through the Jeep® Connect (Uconnect Connected Services) system. This includes information about the vehicle’s operation, a collision involving the vehicle, the use of the vehicle and its features, and in certain situations, the location and approximate GPS speed of the vehicle. Refer to the Uconnect Owner’s Manual Supplement for Terms and Conditions and Privacy Statements.
- The driver monitoring camera may record images of the driver during certain crash, or near crash-like situations. To retrieve the images recorded by the camera, special equipment is required and access to the vehicle or the camera is needed.
- Vehicle data may be read from the Hands-Free ADA system with special equipment and access to the vehicle or the Event Data Recorder (EDR).

WARNING!

The Active Driving Assist (ADA) system is a convenience system. It is not a substitute for active driver involvement. It is always the driver's responsibility to be attentive of road traffic, weather conditions, vehicle speed, distance to the vehicle ahead, position in the lane compared to other vehicles, and brake operation to ensure safe operation of the vehicle under all road conditions. Your complete attention is always required while driving to maintain safe control of your vehicle. Failure to follow these warnings can result in a collision and death or serious personal injury.

Some states and local laws may require hands to be kept on the steering wheel at all times. For vehicles equipped with the Hands-Free ADA system, **ONLY** remove your hands from the steering wheel if the Hands-Free system is engaged, it is safe to do so, and it is permitted by state and local laws.

You should turn off the Active Driving Assist systems:

- When driving in complex driving situations (e.g. urban environments, construction zones, etc.), adverse weather or low visibility conditions (e.g. rain, snow, fog, sleet, dust), or adverse road conditions (e.g. heavy traffic, worn or missing lane markings, etc.).
- When entering a highway on-ramp or exiting an off-ramp.
- When driving on roads that are icy, snow covered, or slippery.
- When driving during difficult or uncertain conditions.

TURNING ACTIVE DRIVING ASSIST ON OR OFF

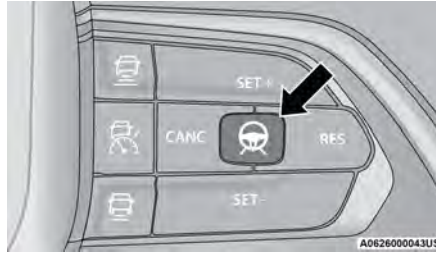

Active Driving Assist On/Off Button

To enable the Active Driving Assist system, proceed as follows:

1. Push the Active Driving Assist on/off button located on the right side of the steering wheel. The steering wheel image will display white in the instrument cluster display until the system is engaged. If ACC was previously disabled, pushing this button will activate BOTH ACC and Active Driving Assist systems.
2. If ACC was engaged before pushing the ADA on/off button, ACC will remain active and ADA will also become engaged (once all other conditions are met).
3. If ACC was not active before pushing the ADA on/off button, push the SET (+) button or the SET (-) button and release when the desired driving speed is shown in the instrument cluster display.

4. If desired, adjust the ACC distance setting by pushing the Distance Increase or Distance Decrease buttons.

When all system conditions are met as described in "System Engagement Conditions" in the next section, the system will engage and the steering wheel image in the display will change to green.

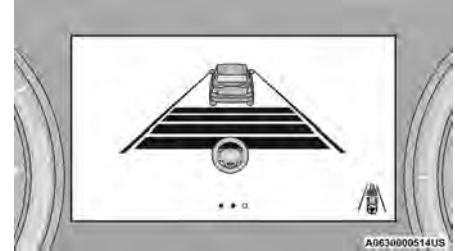

Active Driving Assist Engaged (Steering Wheel Green)

NOTE:

- Along with the color change of the steering wheel image, the "glow" effect of the instrument cluster display will also change to green when ADA is engaged.

System Engagement Conditions

The following conditions must be met before the system will engage:

- Active Driving Assist system is enabled
- Driver seat belt is buckled
- Driver is not pressing the brake pedal
- Driver door is closed
- System detects visible lane markings

- Vehicle is at an allowable ride height
- Vehicle is traveling below 90 mph (145 km/h)
- Vehicle is centered in lane
- Turn signal is not activated
- Vehicle is not in a tight curve
- Trailer is not connected
- Driver has hands on steering wheel and is paying attention to the road
- If equipped with the Hands-Free system, vehicle is driving on an approved roadway
- If equipped with the Hands-Free system, a subscription is active and the vehicle is receiving a clear cellular signal

NOTE:

For the system to detect the driver's hands on the steering wheel, the wheel must be gripped on the outside. Gripping the inside areas of the steering wheel will not satisfy the hands-on condition to engage the system.



Do Not Grip Inside Of Steering Wheel

System Deactivation

The system will be deactivated in any of the following situations:

- If the system has detected driver inattentiveness, and has gone through all escalation warnings:
 - **Base ADA:** Hands no longer detected on the steering wheel
 - **Hands-Free ADA:** Driver no longer attentive
- If lane markings are no longer detected or poor road conditions are experienced
- If the brake pedal is pressed or ACC system is deactivated
- If a turn signal is used when equipped with Base ADA (unless a target is in the blind spot zone on the same side the turn signal is being applied)
- If the driver performs an evasive maneuver, applying high torque to the steering wheel for a short duration
- If the driver's seat belt is unbuckled
- If the vehicle speed exceeds 90 mph (145 km/h)
- If the Active Driving Assist on/off button is pushed again (ADA will turn off)
- If the driver steers out of the lane and crosses a lane marking
- If the Forward Collision Warning (FCW) system becomes active and is providing warnings/braking

NOTE:

- ADA will not enable if the system detects a trailer is connected to the vehicle.
- Pushing the Active Driving Assist on/off button or deactivating ACC will turn the system off. All other deactivation conditions will place the system back into the "enabled" state with the steering wheel indicator displayed in white until all engagement conditions are met again.

- When the system is deactivated, the system status indicator lights will turn off, Active Lane Management will return to its previous state, and ACC will disable or remain engaged pending system conditions.

Hands-Free System Deactivation (If Equipped)

In addition to the deactivation conditions previously listed, the Hands-Free ADA system will also deactivate in the following situations:

- The system initiates a Stop-In-Lane maneuver to stop the vehicle due to driver inattentiveness. The Stop-In-Lane maneuver can be overridden by placing hands on the steering wheel and applying the accelerator or brake pedal. Refer to "Indications On The Display" in the next section for further information.
- The vehicle is not receiving a clear cellular signal for an extended period of time.
- The subscription for the Hands-Free system is expired.
- The vehicle leaves a supported roadway.

INDICATIONS ON THE DISPLAY

The Active Driving Assist system status can always be viewed in the instrument cluster display, and status changes are shown by changes in color of the system's indicator lights.

As the system detects driver inattentiveness as previously described ↗ page 129, the system status indicator lights will change from green, to yellow, to red. The following indicators will change in color as warnings to the driver escalate:

- Active Driving Assist Indicator (steering wheel icon in the instrument cluster display or Head Up Display [if equipped])
- Glow effect of the instrument cluster display

For Base ADA, if driver's hands are not returned to the steering wheel, the system will deactivate.

For Hands-Free ADA, if driver attention is not returned, the system will perform a Stop-In-Lane maneuver. Once the vehicle is at a standstill, the vehicle will be shifted to PARK and the Electric Park Brake (EPB) will be applied. Then, the vehicle will attempt to place an emergency call through the Assist and SOS system. If too many Stop-In-Lane maneuvers are initiated, or if one is completed, the system will be unavailable until the ignition is cycled OFF, then back to ON.

Active Driving Assist Indicators Are Off

- ADA is not turned on/enabled by the driver.

Active Driving Assist Indicators Are White

- ADA is turned on/enabled by the driver, but the system is not actively steering and providing speed control for the vehicle.

Active Driving Assist Indicators Are Green

- System is actively steering and providing speed control for the vehicle and the system detects driver is attentive.

Active Driving Assist Indicators Are Yellow

- Driver inattentiveness has been detected, warning the driver to place hands on the steering wheel, or look back toward the road (if equipped with the Hands-Free system).

Active Driving Assist Indicators Are Red

- Driver inattentiveness is still being detected, or driver take-over is being requested, warning the driver to place hands on the steering wheel, or if equipped with the Hands-Free system, take control of the vehicle.

NOTE:

For both Base ADA and Hands-Free ADA, the driver **MUST** replace hands on the steering wheel and take control of the vehicle when the system is deactivated.



Active Driving Assist Canceled Message

SYSTEM STATUS

Along with changes in the system's indicator lights (green, yellow, and red), the system can also issue several accompanying warnings intended to provide the driver with enough time to react, avoid or mitigate a potential collision.

Base Active Driving Assist System

- Two haptic brake jerk warnings will be issued (red warning light is issued).
- A steering wheel vibration warning (if enabled) will occur if the vehicle crosses a lane marker, for example, when driving on a tight curve. The steering wheel vibration feature can be turned on or off within the Uconnect system → page 169.

Hands-Free Active Driving Assist System

- A seat vibration warning will occur (red warning light is issued).

The driver can take control of the vehicle at anytime to override the warnings by pressing the gas or brake pedal, moving the steering wheel, and being attentive to the road.

SYSTEM OPERATION/LIMITATIONS

WARNING!

Active Driving Assist is an SAE Level 2 Driver Assist feature, requiring driver attention at all times. To prevent serious injury or death:

- Always remember that the Active Driving Assist system is a convenience system that cannot accurately detect all situations. Complete attention is always required while driving, even when using the Active Driving Assist system.
- Always remain alert and be ready to take control of the vehicle in the event that the Active Driving Assist system deactivates, or otherwise lacks full functionality as described further before and after this statement.
- Always keep your eyes on the road and hands on the steering wheel when the Base Active Driving Assist system is activated.
- Always keep your eyes on the road when the Hands-Free Active Driving Assist system is activated.
- Maintain a safe distance from other vehicles and pay attention to traffic conditions.

(Continued)

WARNING!

- Do not use a hand held device when either Base, or Hands-Free Active Driving Assist system is engaged.
- Always pay attention to the road when the Hands-Free Active Driving Assist system is engaged. The Active Driving Assist system will not steer to avoid safety hazards, construction zones, objects, or road impediments. You need to take control to steer and brake the vehicle in such situations, and when merging into traffic, exiting the highway, making a turn for crossing traffic, or stopping for traffic control devices.
- Do not place any objects on the steering wheel (e.g. steering wheel covers) which could interfere with the hand detection sensors.

The Base Active Driving Assist and Hands-Free Active Driving Assist systems **DO NOT**:

- Warn or prevent collisions with other vehicles
- Steer your vehicle around stopped vehicles, slower vehicles, construction zones or equipment, pedestrians, or animals
- Respond to traffic lights or stop signs
- Merge onto highways or exit off ramps
- Change lanes (exception: Hands-Free, only when initiated by the driver)
- React to cross traffic

NOTE:

Adaptive Cruise Control (ACC) is a core component of ADA. For ACC system limitations ↪ page 121.

The Active Driving Assist system may have limited or reduced functionality when one of the following conditions occur:

- The vehicle's radar sensors and/or forward facing camera is damaged, covered, misaligned, or obstructed (e.g. by mud, ice, snow, etc.)
- If the suspension alignment is not correct, if the vehicle is modified (e.g. lifting or lowering the suspension, installing different sized wheels or tires) or if there has been damage due to road hazards
- Driving near highway toll booths

NOTE:

If damage to the windshield occurs, have the windshield replaced by an authorized dealer as soon as possible.

PARKSENSE FRONT/REAR PARK ASSIST SYSTEM — IF EQUIPPED

The ParkSense Park Assist system provides visual and audible indications of the distance between the rear, and if equipped, the front fascia/bumper and a detected obstacle when backing up or moving forward (e.g. during a parking maneuver). The vehicle brakes may be automatically applied and released when performing a reverse parking maneuver if the system detects a possible collision with an obstacle.

NOTE:

- The driver can disable the automatic braking function by turning ParkSense off via the ParkSense switch. The driver can also override automatic braking by changing the gear or by pressing the gas pedal over 90% of its capacity during the braking event.

- Automatic brakes are not available if the vehicle is in 4WD Low.
- Automatic brakes will not be available if there is a faulted condition detected with the ParkSense Park Assist system or the Braking System Module.
- The automatic braking function may only be applied if the vehicle deceleration is not enough to avoid colliding with a detected obstacle.
- The automatic braking function may not be applied fast enough for obstacles that move toward the rear of the vehicle from the left and/or right sides.
- The automatic braking function can be enabled/disabled from the Customer Programmable Features section of the Uconnect system.
- ParkSense will retain its last known configuration state for the automatic braking function through ignition cycles.

The automatic braking function is intended to assist the driver in avoiding possible collisions with detected obstacles when backing up in REVERSE gear.

NOTE:

- The system is designed to assist the driver and not to substitute the driver.
- The driver must stay in full control of the vehicle's acceleration and braking and is responsible for the vehicle's movements.

For limitations of this system and recommendations, see ↪ page 140.

ParkSense will retain the last system state (enabled or disabled) from the last ignition cycle when the ignition is changed to the ON/RUN position.

ParkSense can be active only when the gear selector is in REVERSE or DRIVE. If ParkSense is enabled at one of these gear selector positions, the system will remain active until the vehicle speed is increased to approximately 7 mph (11 km/h) or above. The system will become active again if the vehicle speed is decreased to less than approximately 6 mph (9 km/h). A display warning will appear in the instrument cluster display if the vehicle is in REVERSE and the speed exceeds 7 mph (11 km/h).

PARKSENSE SENSORS

The four ParkSense sensors located in the rear fascia/bumper, and the six ParkSense sensors located in the front fascia/bumper, monitor the area in front and behind the vehicle that is within the sensors' field of view. The front sensors detect obstacles from approximately 12 inches (30 cm) up to 47 inches (120 cm) from the front fascia/bumper. The rear sensors can detect obstacles from approximately 12 inches (30 cm) up to 79 inches (200 cm) from the rear fascia/bumper. These distances depend on the location, type and orientation of the obstacle in the horizontal direction.

NOTE:

If the vehicle is equipped with ParkSense Active Park Assist, there will be six ParkSense sensors located in the rear fascia/bumper.

PARKSENSE DISPLAY

The warning display will turn on indicating the system status when the vehicle is in REVERSE or when the vehicle is in DRIVE and an obstacle has been detected.

The system will indicate a detected obstacle by showing a single arc in the left and/or right front or rear regions based on the object's distance and location relative to the vehicle.

If an object is detected in the left and/or right rear region, the display will show a single arc in the left and/or right rear region and the system will produce a tone. As the vehicle moves closer to the object, the display will show the single arc moving closer to the vehicle and the tone will change from a single 1/2 second tone to slow, to fast, to continuous.

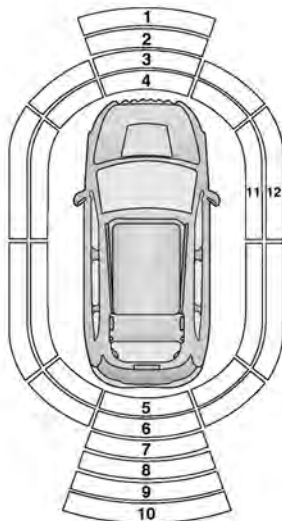

Front/Rear/Side ParkSense Arcs

A0629000256US

- 1 – No Tone/Solid Arc
- 2 – No Tone/Flashing Arc
- 3 – Fast Tone/Flashing Arc
- 4 – Continuous Tone/Flashing Arc
- 5 – Continuous Tone/Flashing Arc
- 6 – Fast Tone/Flashing Arc

- 7 – Fast Tone/Flashing Arc
- 8 – Slow Tone/Solid Arc
- 9 – Slow Tone/Solid Arc
- 10 – Single 1/2 Second Tone/Solid Arc
- 11 – Continuous Tone/Flashing Arcs
- 12 – Fast Tone/Flashing Arcs

The vehicle is close to the obstacle when the instrument cluster display shows one flashing arc and sounds a continuous tone. The following chart shows the warning alert operation when the system is detecting an obstacle:

WARNING ALERTS FOR REAR							
Rear Distance (inches/cm)	Greater than 79 inches (200 cm)	79-59 inches (200-150 cm)	59-47 inches (150-120 cm)	47-39 inches (120-100 cm)	39-25 inches (100-65 cm)	25-12 inches (65-30 cm)	Less than 12 inches (30 cm)
Audible Alert Chime	None	Single 1/2 Second Tone	Slow	Slow	Fast	Fast	Continuous
Arcs-Left	None	None	None	None	None	6th Flashing	5th Flashing
Arcs-Center	None	10th Solid	9th Solid	8th Solid	7th Flashing	6th Flashing	5th Flashing
Arcs-Right	None	None	None	None	None	6th Flashing	5th Flashing
Radio Volume Reduced	No	Yes	Yes	Yes	Yes	Yes	Yes

WARNING ALERTS FOR FRONT					
Front Distance (inches/cm)	Greater than 47 inches (120 cm)	47-39 inches (120-100 cm)	39-25 inches (100-65 cm)	25-12 inches (65-30 cm)	Less than 12 inches (30 cm)
Audible Alert Chime	None	None	None	Fast	Continuous
Arcs-Left	None	None	None	3rd Flashing	4th Flashing
Arcs-Center	None	1st Solid	2nd Flashing	3rd Flashing	4th Flashing
Arcs-Right	None	None	None	3rd Flashing	4th Flashing
Radio Volume Reduced	No	No	No	Yes	Yes

NOTE:

ParkSense will reduce the volume of the radio, if on, when the system is sounding an audio tone.

Front Park Assist Audible Alerts

ParkSense will turn off the Front Park Assist audible alert (chime) after approximately three seconds when an obstacle has been detected, and the vehicle is stationary.

Adjustable Chime Volume Settings

Front and rear chime volume settings can be selected from the Uconnect system  page 169.

The chime volume settings include low, medium, and high.

ParkSense will retain its last known configuration state through ignition cycles.

PARKSENSE WARNING DISPLAY

The ParkSense Warning screen is located within the instrument cluster display  page 85. It provides visual warnings to indicate the distance between the rear fascia/bumper and/or front fascia/bumper and the detected obstacle.

ENABLING AND DISABLING PARKSENSE

ParkSense can be enabled and disabled with the ParkSense switch located on the switch panel above the Uconnect display.

When the ParkSense switch is pushed to enable the system, the instrument cluster will display the system state.

When the ParkSense switch is pushed to disable the system, the instrument cluster will display the "PARKSENSE OFF" message for approximately two seconds. When the gear selector is moved to REVERSE and the system is disabled, the instrument cluster display will display the "PARKSENSE OFF" message for as long as the vehicle is in REVERSE.

NOTE:

When ParkSense is disabled and the gear selector is moved to the DRIVE position, no warning message will be displayed.

The ParkSense switch LED will be on when ParkSense is disabled or requires service. The ParkSense switch LED will be off when the system is enabled. If the ParkSense switch is pushed, and the system requires service, the ParkSense switch LED will blink momentarily, and then the LED will be on.

SERVICE THE PARKSENSE PARK ASSIST SYSTEM

During vehicle start-up, when the ParkSense System has detected a faulted condition, the instrument cluster will actuate a single chime, once per ignition cycle, and it will display a pop-up. The pop-up will include up to two faults. Possible fault messages are "PARKSENSE UNAVAILABLE WIPE REAR SENSORS", "PARKSENSE UNAVAILABLE WIPE FRONT SENSORS", or "PARKSENSE UNAVAILABLE SERVICE REQUIRED." The pop-up message will display for five seconds.

When the gear selector is moved to REVERSE and the system has detected a faulted condition, the instrument cluster display will display a "PARKSENSE UNAVAILABLE WIPE REAR SENSORS", "PARKSENSE UNAVAILABLE WIPE FRONT SENSORS" or "PARKSENSE UNAVAILABLE SERVICE REQUIRED" pop-up message for five seconds. After five seconds, a vehicle graphic will be displayed with "UNAVAILABLE" at either the front or rear sensor location depending on where the fault is detected. The system will continue to provide arc alerts for the side that is functioning properly. These arc alerts will interrupt the "PARKSENSE UNAVAILABLE WIPE REAR SENSORS", "PARKSENSE UNAVAILABLE WIPE FRONT SENSORS", or "PARKSENSE UNAVAILABLE SER-

VICE REQUIRED" messages if an object is detected within the five second pop-up duration. The vehicle graphic will remain displayed for as long as the vehicle is in REVERSE.

If "PARKSENSE UNAVAILABLE WIPE REAR SENSORS" or "PARKSENSE UNAVAILABLE WIPE FRONT SENSORS" appears in the instrument cluster display make sure the outer surface and the underside of the rear fascia/bumper and/or front fascia/bumper is clean and clear of snow, ice, mud, dirt or other obstructions and then cycle the ignition. If the message continues to appear see an authorized dealer.

If the "PARKSENSE UNAVAILABLE SERVICE REQUIRED" message appears in the instrument cluster display, see an authorized dealer.

CLEANING THE PARKSENSE SYSTEM

Clean the ParkSense sensors with water, car wash soap and a soft cloth. Do not use rough or hard cloths. Do not scratch or poke the sensors.

PARKSENSE SYSTEM USAGE PRECAUTIONS**NOTE:**

- Ensure that the front and rear fascia/bumper are free of snow, ice, mud, dirt and debris to keep the ParkSense system operating properly.
- Jackhammers, large trucks, and other vibrations could affect the performance of ParkSense.

- When you turn ParkSense off, the instrument cluster will display “PARKSENSE OFF.” Furthermore, once you turn ParkSense off, it remains off until you turn it on again, even if you cycle the ignition.
- When you move the gear selector to the REVERSE position and ParkSense is turned off, the instrument cluster will display “PARKSENSE OFF” for as long as the vehicle is in REVERSE.
- ParkSense, when on, will reduce the volume of the radio when it is sounding a tone.
- Clean the ParkSense sensors regularly, taking care not to scratch or damage them. The sensors must not be covered with ice, snow, slush, mud, dirt or debris. Failure to do so can result in the system not working properly. The ParkSense system might not detect an obstacle behind or in front of the fascia/bumper, or it could provide a false indication that an obstacle is behind or in front of the fascia/bumper.
- Use the ParkSense switch to turn the ParkSense system off if objects such as bicycle carriers, trailer hitches, etc., are placed within 12 inches (30 cm) of the rear fascia/bumper. Failure to do so can result in the system misinterpreting a close object as a sensor problem, causing the “PARKSENSE UNAVAILABLE SERVICE REQUIRED” message to be displayed in the instrument cluster.
- ParkSense should be disabled when the liftgate is in the open position. An opened liftgate could provide a false indication that an obstacle is behind the vehicle.

WARNING!

- Drivers must be careful when backing up even when using ParkSense. Always check carefully behind your vehicle, look behind you, and be sure to check for pedestrians, animals, other vehicles, obstructions, and blind spots before backing up. You are responsible for safety and must continue to pay attention to your surroundings. Failure to do so can result in serious injury or death.
- Before using ParkSense, it is strongly recommended that the ball mount and hitch ball assembly be disconnected from the vehicle when the vehicle is not used for towing. Failure to do so can result in injury or damage to vehicles or obstacles because the hitch ball will be much closer to the obstacle than the rear fascia/bumper when the vehicle sounds the continuous tone. Also, the sensors could detect the ball mount and hitch ball assembly, depending on its size and shape, giving a false indication that an obstacle is behind the vehicle.

CAUTION!

- ParkSense is only a parking aid and it is unable to recognize every obstacle, including small obstacles. Parking curbs might be temporarily detected or not detected at all. Obstacles located above or below the sensors will not be detected when they are in close proximity.

*(Continued)***CAUTION!**

- The vehicle must be driven slowly when using ParkSense in order to be able to stop in time when an obstacle is detected. It is recommended that the driver looks over his/her shoulder when using ParkSense.

SIDE DISTANCE WARNING SYSTEM

The Side Distance Warning system detects the presence of side obstacles near the vehicle using the parking sensors located in the front and rear fascia/bumpers.

4**Side Distance Warning Display**

The Side Distance Warning screen will only be displayed if this feature is enabled within Uconnect Settings
 ➔ page 169.

The system warns the driver with an acoustic signal and, when enabled, with visual indications on the instrument cluster display.

When the vehicle is in DRIVE, the Side Distance Warning volume/chime will match the Front ParkSense volume and chime type.

When the vehicle is in REVERSE, the Side Distance Warning volume/chime will match the Rear ParkSense volume and chime type.

WARNING ALERTS		
Distance (inches/cm)	Less than 12 inches (30 cm)	12 - 24 inches (30-60 cm)
Arcs-Left	Flashing	Flashing
Arcs-Right	Flashing	Flashing
Audible Alert Chime	Continuous	Fast audible chime as the objects get close to the vehicle
Radio Volume Reduced	Yes	Yes

NOTE:

ParkSense will reduce the volume of the radio if on when the system is sounding an audible tone. An audible tone will only sound if a collision is possible.

Activation/Deactivation

The system can operate only after driving a short distance and if the vehicle speed is between 0 and 7 mph (0 and 11 km/h). The system can be activated/deactivated via the Settings menu of the Uconnect system. If the ParkSense System is deactivated via the ParkSense hard switch, then the Side Distance Warning system will automatically be deactivated.

Message on the display for Side Distance Warning feature:

“Wipe Sensors” – This message is displayed in the case of a failure of the Side Distance Warning system sensors. Free the bumpers of any obstacles, ensure that the front and rear fascia/bumper are free of snow, ice, mud, dirt and debris to keep the ParkSense system operating properly.

“System Not Available” – This message is displayed if the Side Distance Warning system is not available. The failed operation of the system might be due to the insufficient voltage from the battery or other failures on the electrical system. Contact an authorized dealer as soon as possible to have the electrical system checked.

ParkSense Usage Precautions

Some conditions may influence the performance of the Side Distance Warning system:

NOTE:

- Ensure that the front and rear fascia/bumper are free of snow, ice, mud, dirt and debris to keep the ParkSense system operating properly.
- Construction equipment, large trucks, and other vibrations could affect the performance of ParkSense.
- When you turn ParkSense off, the message to appear in the instrument cluster display will read “PARKSENSE OFF.” Furthermore, once you turn ParkSense off, it remains off until you turn it on again, even if you cycle the ignition key.
- ParkSense, when on, will reduce the volume of the radio when it is sounding a tone.
- Clean the ParkSense sensors regularly, taking care not to scratch or damage them. The sensors must not be covered with ice, snow, slush, mud, dirt or debris. Failure to do so can result in the system not working properly. The ParkSense system might not detect an obstacle behind or in front of the fascia/bumper, or it could provide a false indication that an obstacle is behind or in front of the fascia/bumper.

- The presence of a tow hook without a trailer may interfere with the correct operation of the parking sensors. Before using the ParkSense system, it is recommended to remove the removable tow hook ball assembly and any attachments from the vehicle when it is not used for towing operations.

WARNING!

- Drivers must be careful when backing up even when using ParkSense. Always check carefully behind your vehicle, look behind you, and be sure to check for pedestrians, animals, other vehicles, obstructions, and blind spots before backing up. You are responsible for safety and must continue to pay attention to your surroundings. Failure to do so can result in serious injury or death.
- Before using ParkSense, it is strongly recommended that the ball mount and hitch ball assembly be disconnected from the vehicle when the vehicle is not used for towing. Failure to do so can result in injury or damage to vehicles or obstacles because the hitch ball will be much closer to the obstacle than the rear fascia/bumper when the vehicle sounds the continuous tone. Also, the sensors could detect the ball mount and hitch ball assembly, depending on its size and shape, giving a false indication that an obstacle is behind the vehicle.

CAUTION!

- ParkSense is only a parking aid and it is unable to recognize every obstacle, including small obstacles. Parking curbs might be temporarily detected or not detected at all. Obstacles located above or below the sensors will not be detected when they are in close proximity.
- The vehicle must be driven slowly when using ParkSense in order to be able to stop in time when an obstacle is detected. It is recommended that the driver looks over his/her shoulder when using ParkSense.

PARKSENSE ACTIVE PARK ASSIST SYSTEM — IF EQUIPPED

The ParkSense Active Park Assist system is intended to assist the driver during parallel and perpendicular parking maneuvers by identifying a proper parking space, providing audible/visual instructions, and controlling the steering wheel. The ParkSense Active Park Assist system is defined as “semi-automatic” since the driver maintains control of the accelerator, gear selector and brakes. Depending on the driver’s parking maneuver selection, the ParkSense Active Park Assist system is capable of maneuvering a vehicle into a parallel or a perpendicular parking space on either side (i.e., driver side or passenger side).

NOTE:

- The driver is always responsible for controlling the vehicle, responsible for any surrounding objects, and must intervene as required.

- The system is designed to assist the driver and not to substitute the driver.
- During a semi-automatic maneuver, if the driver touches the steering wheel after being instructed to remove their hands from the steering wheel, the system will cancel, and the driver will be required to manually complete the parking maneuver.
- The system may not work in all conditions (e.g. environmental conditions such as heavy rain, snow, etc., or if searching for a parking space that has surfaces that will absorb the ultrasonic sensor waves).
- New vehicles from the dealership must have at least 30 miles (48 km) accumulated before the ParkSense Active Park Assist system is fully calibrated and performs accurately. This is due to the system’s dynamic vehicle calibration to improve the performance of the feature. The system will also continuously perform the dynamic vehicle calibration to account for differences such as over or under inflated tires and new tires.

ENABLING AND DISABLING THE PARKSENSE ACTIVE PARK ASSIST SYSTEM



The ParkSense Active Park Assist system can be enabled and disabled with the ParkSense Active Park Assist switch, located on the switch panel above the Uconnect display.

To enable or disable the ParkSense Active Park Assist system, push the ParkSense Active Park Assist switch once (LED turns on). Pushing the switch a second time will disable the system (LED turns off).

The ParkSense Active Park Assist system will turn off automatically for any of the following conditions:

- Parking maneuver is completed
- Vehicle speed is greater than 18 mph (30 km/h) when searching for a parking space
- Vehicle speed is greater than 5 mph (7 km/h) during active steering guidance into the parking space
- Steering wheel is touched during active steering guidance into the parking space
- ParkSense Front and Rear Park Assist switch is pushed
- Driver’s door is opened
- Rear liftgate is opened
- Electronic Stability Control/Anti-Lock Braking System intervention

The ParkSense Active Park Assist system allows a maximum number of shifts between DRIVE and REVERSE. If the maneuver cannot be completed within the maximum amount of shifts, the system will cancel and the instrument cluster display will instruct the driver to complete the maneuver manually.

The ParkSense Active Park Assist system will only operate and search for a parking space when the following conditions are present:

- Gear selector is in DRIVE
- Ignition is in the RUN position
- ParkSense Active Park Assist switch is activated
- Driver’s door is closed
- Rear liftgate is closed
- Vehicle speed is less than 15 mph (25 km/h)
- The outer surface and the underside of the front and rear fascias/bumpers are clean and clear of snow, ice, mud, dirt or other obstructions

NOTE:

If the vehicle is driven above approximately 15 mph (25 km/h), the instrument cluster display will instruct the driver to slow down. If the vehicle is driven above approximately 18 mph (30 km/h), the system will cancel. The driver must then reactivate the system by pushing the ParkSense Active Park Assist switch.

When pushed, the LED on the ParkSense Active Park Assist switch will blink momentarily, and then the LED will turn off if any of the preceding conditions are not present.

If the vehicle is in any other gear than DRIVE, and an object is detected, the system will default to Parallel Park Exit. A prompt will appear in the radio screen, and the driver will need to select "Yes" or "No" for a Parallel Park Exit maneuver. Any other conditions will result in a default to a Parallel Parking maneuver.

PARALLEL/PERPENDICULAR PARKING SPACE ASSISTANCE OPERATION

When the ParkSense Active Park Assist system is enabled, you can select between Parallel, Perpendicular, and Parallel Park Exit maneuvers in the Uconnect system.

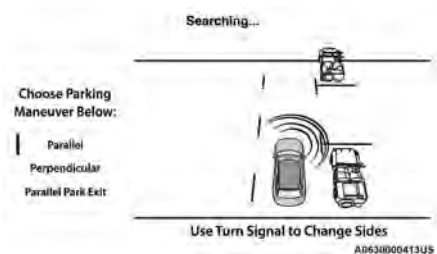

Choose Parking Maneuver

NOTE:

- When searching for a parking space, use the turn signal indicator to select which side of the vehicle you want to perform the parking maneuver. The ParkSense Active Park Assist system will automatically search for a parking space on the passenger's side of the vehicle if the turn signal is not activated.
- The driver needs to make sure that the selected parking space for the maneuver remains free and clear of any obstructions (e.g. pedestrians, bicycles, etc.).
- The driver is responsible to ensure that the selected parking space is suitable for the maneuver and free/clear of anything that may be overhanging or protruding into the parking space (e.g., ladders, tailgates, etc. from surrounding objects/vehicles).
- When searching for a parking space, the driver should drive as parallel or perpendicular (depending on the type of maneuver) to other vehicles as possible.

- The feature will only indicate the last detected parking space (e.g., if passing multiple available parking spaces, the system will only indicate the last detected parking space for the maneuver).
- While the vehicle is in DRIVE, there will be a full screen image in the Uconnect display. If the driver shifts to REVERSE while searching for a parking space, a camera image will appear in the Uconnect display with a "Shift To Drive" message.

When an available parking space has been found, and the vehicle is not in position, you will be instructed to move forward to position the vehicle for a perpendicular or parallel parking sequence (depending on the type of maneuver being performed).

Once active steering begins, a camera image will display in the Uconnect display with prompts that will display for the duration of the maneuver.



Parking Space Found – Keep Moving Forward

Once the vehicle is in position, you will be instructed to stop the vehicle's movement and remove your hands from the steering wheel. When the vehicle comes to a standstill (your hands still removed from the steering wheel), you will be instructed to place the gear selector into the REVERSE position.

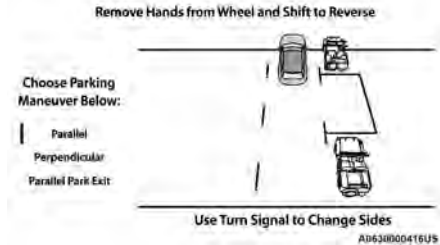

Shift To Reverse – Parallel Parking Space

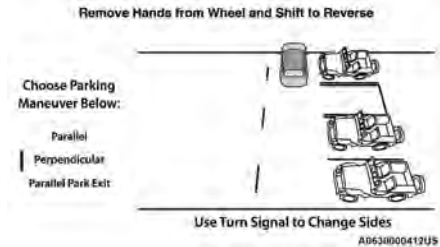

Shift To Reverse – Perpendicular Parking Space

The system may then instruct the driver to wait for steering to complete before then instructing to check the vehicle's surroundings, and move backward.

Several more gear shifts (DRIVE and REVERSE) while keeping hands off of the steering wheel will be instructed to the driver while checking the vehicle's surroundings before completing the parking maneuver.

When the vehicle is in the parking position, the maneuver is complete and the driver will be instructed to check the vehicle's parking position, then shift the vehicle into PARK. The message "Active ParkSense Complete - Check Parking Position" will be displayed momentarily.

NOTE:

- It is the driver's responsibility to use the brake and stop the vehicle. The driver should check their surroundings and be prepared to stop the vehicle either when instructed to, or when driver intervention is required.
- It is the driver's responsibility to use the brake and accelerator during the semi-automatic parking maneuver.
- When the system instructs the driver to remove their hands from the steering wheel, the driver should check their surroundings and begin to back up slowly.
- The ParkSense Active Park Assist system will allow a maximum of eight shifts between DRIVE and REVERSE. If the maneuver cannot be completed within eight shifts, the system will cancel and the instrument cluster display will instruct the driver to complete the maneuver manually.

- The system will cancel the maneuver if the vehicle speed exceeds 5 mph (7 km/h) during active steering guidance into the parking space. The system will provide a warning to the driver at 3 mph (5 km/h) that tells them to slow down. The driver is then responsible for completing the maneuver if the system is canceled.
- If the system is canceled during the maneuver for any reason, the driver must take control of the vehicle.

WARNING!

- Drivers must be careful when performing parallel or perpendicular parking maneuvers even when using the ParkSense Active Park Assist system. Always check carefully behind and in front of your vehicle, look behind and in front of you, and be sure to check for pedestrians, animals, other vehicles, obstructions, and blind spots before backing up and moving forward. You are responsible for safety and must continue to pay attention to your surroundings. Failure to do so can result in serious injury or death.
- Before using the ParkSense Active Park Assist system, it is strongly recommended that the ball mount and hitch ball assembly be disconnected from the vehicle when the vehicle is not used for towing. Failure to do so can result in injury or damage to vehicles or obstacles because the hitch ball will be much closer to the obstacle than the rear fascia/bumper when the vehicle sounds the continuous tone. Also, the sensors could detect the ball mount and hitch ball assembly, depending on its size and shape, giving a false indication that an obstacle is behind the vehicle.

CAUTION!

- The ParkSense Active Park Assist system is only a parking aid and it is unable to recognize every obstacle, including small obstacles. Parking curbs might be temporarily detected or not detected at all. Obstacles located above or below the sensors will not be detected when they are in close proximity.
- The vehicle must be driven slowly when using the ParkSense Active Park Assist system in order to be able to stop in time when an obstacle is detected. It is recommended that the driver looks over his/her shoulder when using the ParkSense Active Park Assist system.

EXITING THE PARKING SPACE**NOTE:**

The function does not work for exiting a perpendicular parking space, but only exiting parallel parking spaces.

Activation

To activate this function, push the Active ParkSense switch once. After selection, the system activates and warns the driver on the instrument cluster display about the operations that have to be carried out to perform the maneuver correctly.

Selection Of The Maneuver Side

Use the direction indicators to choose the direction that you want to perform the maneuver. Use the right arrow indicator to perform the maneuver to the right side and use the left arrow indicator to perform the maneuver to the left.

During the maneuver, the system instructs the driver to shift to REVERSE, and operate the turn signal in the direction you want to exit. Let go of the steering wheel and use the brake or accelerator pedals as instructed, while the system handles the steering automatically for exiting the parking space. If the driver continues to carry out a voluntary or involuntary action on the steering wheel during the exit maneuver (touching or holding the steering wheel to prevent its movement), the maneuver will be interrupted.

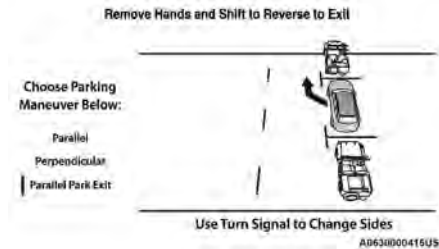
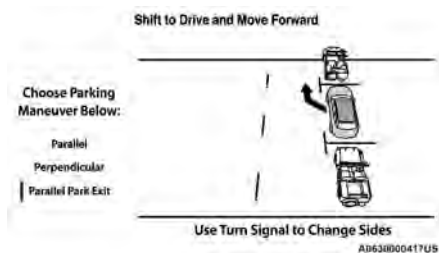
**Shift To Reverse Then Move Backward****Shift To Drive Then Move Forward****End Of Maneuver**

The semi-automatic maneuver ends when the display shows the message of a completed maneuver. At the end of the maneuver, the system gives back the vehicle control to the driver.

ACTIVE LANE MANAGEMENT SYSTEM — IF EQUIPPED**ACTIVE LANE MANAGEMENT OPERATION**

The Active Lane Management (ALM) system uses a forward facing camera to detect lane markings or road edges and to measure vehicle position within the lane boundaries. It also uses the Blind Spot Monitoring (BSM) sensors to detect vehicles in adjacent lanes while the driver is preparing to change lanes.

The system is operational at speeds above 37 mph (60 km/h) and below 112 mph (180 km/h).

When both lane markings are detected, and the vehicle approaches (or crosses) the lane marking with no turn signal applied, and the blind spot zone is not occupied, the ALM system provides warnings to prompt the driver to remain within the lane boundaries. These warnings include a visual warning in the instrument cluster along with steering assist torque (if configured in Uconnect Settings).

If the driver crosses the lane marking, the system will either guide the vehicle back to the center of the lane, provide a vibration in the steering wheel, or both, depending on radio settings.

When both lane markings are detected, and the driver uses the turn signal to indicate a lane change, and a vehicle is detected in the BSM zone on that side of the vehicle, the ALM system provides a warning in the form of steering assist and/or steering vibration (depending on radio settings) to guide the vehicle back to the center of the lane.

NOTE:

- The system will suppress visual warnings, steering vibration (if selected in radio settings), and steering assistance (if selected in radio settings) when the driver activates the turn signal, the blind spot zone is clear of vehicles, and a lane change is occurring.
- If the Blind Spot Monitoring (BSM) system detects a vehicle in the adjacent lane, and the turn signal is applied in that direction, the BSM LED on the mirror will flash. If the driver continues to attempt the lane change, steering wheel torque will be provided to keep the vehicle within its lane markings.

The driver may manually override the steering assist warning by applying force to the steering wheel at any time.

When only a single lane marking is detected and the driver drifts across the lane marking (no turn signal applied), the Active Lane Management system provides a visual warning in the instrument cluster, as well as a steering assist torque (if configured in Uconnect Settings), to prompt the driver to remain within the lane boundaries. If the driver continues to drift out of the lane, the system provides a flashing visual warning through the instrument cluster display as well as a haptic steering wheel vibration (if configured in Uconnect Settings) when the vehicle crosses the lane boundary.

NOTE:

When operating conditions have been met, the Active Lane Management system will monitor if the driver's hands are on the steering wheel and provides an audible and visual warning to the driver if removed. The system will cancel if the driver does not return their hands to the wheel.

TURNING ACTIVE LANE MANAGEMENT ON OR OFF



The Active Lane Management button is located on the switch panel above the Uconnect display.

To turn the system on, push the Active Lane Management button (LED turns off). A message is shown in the instrument cluster display.

To turn the system off, push the button again (LED turns on).

NOTE:

The Active Lane Management system will retain the last system state on or off from the last ignition cycle when the ignition is placed in the ON/RUN position.

ACTIVE LANE MANAGEMENT WARNING MESSAGE

The Active Lane Management system will indicate the current lane drift condition through the instrument cluster display.

When the system is on, the lane lines are gray when both of the lane boundaries have not been detected.



System On (Gray Lines)

Left Lane Departure — Only Left Lane Detected

- When the system is on and only the left lane marking has been detected, and the system is ready to provide visual warnings in the instrument cluster display and a vibration and/or steering assist warning in the steering wheel if a lane departure occurs, the left lane line will be green.

- When the system senses the lane line has been approached (but not crossed), the left lane line will change to solid yellow and the system will provide a haptic steering wheel vibration and/or steering assist torque (if programmed in Uconnect Settings).
- When the system senses the lane line is being crossed, the left lane line will change to flashing yellow.

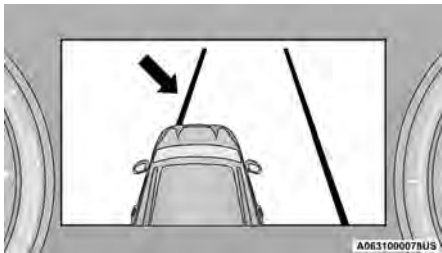

Lane Crossed (Flashing Yellow Line)

NOTE:

The Active Lane Management system operates with similar behavior for a right lane departure when only the right lane marking has been detected.

Left Lane Departure — Both Lanes Detected

- When the system is on, the lane lines turn from gray to green to indicate that both of the lane markings have been detected. When both lane markings have been detected, the system is ready to provide visual warnings in the instrument cluster display and a vibration and/or steering assist warning in the steering wheel if a lane departure occurs.

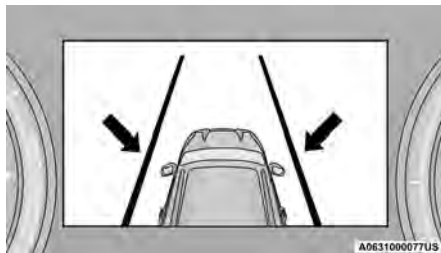

Lanes Sensed (Green Lines)

- When the system senses a lane drift situation, the left lane line turns solid yellow. At this time, steering assist warning is applied to the steering wheel in the opposite direction of the lane boundary.

For example: If approaching the left side of the lane, the steering wheel will turn to the right.

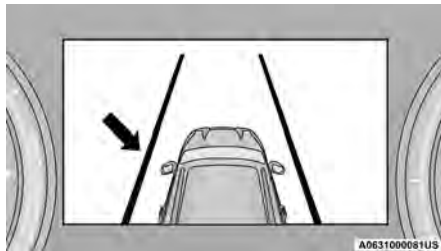

Lane Drift (Solid Yellow Line)

- When the system senses the lane line is being crossed, the left lane line changes from solid yellow to flashing yellow (on/off). At this time, vibration is applied to the steering wheel.

For example: If approaching the left side of the lane, the steering wheel will turn to the right.

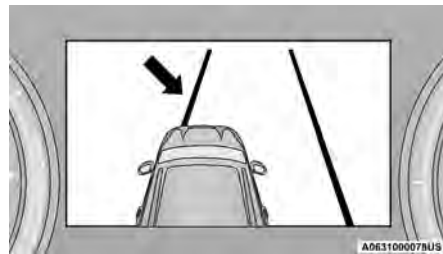

Lane Crossed (Flashing Yellow Line)

NOTE:

- The Active Lane Management system operates with similar behavior for a right lane departure.
- If the turn signal is activated, and the vehicle begins to depart the lane at the same time the Blind Spot Monitoring (BSM) system detects another vehicle in the BSM zones, the system will provide a haptic steering wheel vibration and/or steering assist torque (if programmed in Uconnect Settings).

CHANGING ACTIVE LANE MANAGEMENT STATUS

Configurable settings for the Active Lane Management system are available within the Uconnect system

↪ page 169.

Selectable Warning Types:

- Vibration Only
- Steering Assist Only
- Vibration And Steering Assist

Other configurable settings for this system are for the intensity of the vibration (high/med/low), steering assist warning (hi/med/low), and the warning zone sensitivity (early/medium/late).

NOTE:

- The system will not apply vibration and/or steering assist to the steering wheel whenever a safety system engages (Anti-Lock Brakes, Traction Control System, Electronic Stability Control, Forward Collision Warning, etc.).
- The Blind Spot Monitoring system will be forced on when the ALM system is enabled.
- The ALM system will be suppressed when the Active Driving Assist system (if equipped) is engaged.

PARKVIEW REAR BACK UP CAMERA

Your vehicle is equipped with the ParkView Rear Back Up Camera that allows you to see an on-screen image of the rear surroundings of your vehicle whenever the gear selector is put into REVERSE. The image will be displayed on the Uconnect display screen along with a caution note to “Check Entire Surroundings” across the top of the screen. After five seconds this note will disappear. The ParkView camera is located on the rear of the vehicle above the rear license plate.

When the vehicle is shifted out of REVERSE with camera delay turned off, the rear camera mode is exited and the previous screen appears.

Manual Activation Of The Back Up Camera

1. Press the Vehicle button located on the bottom of the Uconnect display and then select the Controls menu.
2. Press the Back Up Camera icon to turn the Rear View Camera system on.

NOTE:

The ParkView Rear Back Up Camera has programmable modes of operation that may be selected through the Uconnect system ↪ page 169.

When the vehicle is shifted out of REVERSE with camera delay turned off, the rear camera mode is exited and the previous screen appears. When the vehicle is shifted out of REVERSE with camera delay turned on, the camera image will continue to be displayed for up to 10 seconds unless the following conditions occur: the vehicle speed exceeds 8 mph (13 km/h), the vehicle is shifted into PARK, the vehicle’s ignition is placed in the OFF position, or the touchscreen X button to disable the display of the Rear View Camera is pressed.

When enabled, active guidelines are overlaid on the image to illustrate the width of the vehicle and its projected backup path based on the steering wheel position. A dashed center line overlay indicates the center of the vehicle to assist with parking or aligning to a hitch/receiver. Different colored zones indicate the distance to the rear of the vehicle.

The following table shows the approximate distances for each zone:

Zone	Distance To The Rear Of The Vehicle
Red	0 - 1 ft (0 - 30 cm)
Yellow	1 ft - 6.5 ft (30 cm - 2 m)
Green	6.5 ft or greater (2 m or greater)

WARNING!

Drivers must be careful when backing up even when using the ParkView Rear Back Up Camera. Always check carefully behind your vehicle, and be sure to check for pedestrians, animals, other vehicles, obstructions, or blind spots before backing up. You are responsible for the safety of your surroundings and must continue to pay attention while backing up. Failure to do so can result in serious injury or death.

CAUTION!

- To avoid vehicle damage, ParkView should only be used as a parking aid. The ParkView camera is unable to view every obstacle or object in your drive path.
- To avoid vehicle damage, the vehicle must be driven slowly when using ParkView to be able to stop in time when an obstacle is seen. It is recommended that the driver look frequently over his/her shoulder when using ParkView.

NOTE:

If snow, ice, mud, or any foreign substance builds up on the camera lens, clean the lens, rinse with water, and dry with a soft cloth. Do not cover the lens.

Rear Camera Washer (If Equipped)

When the rear window washer is activated by pushing the windshield wiper/washer lever forward, the Rear Back Up camera and Digital Rearview Mirror (if equipped) cameras are also washed. For more information, see [↩](#) page 57.

ZOOM VIEW

When the Rear View Camera image is being displayed, and the vehicle speed is below 8 mph (13 km/h) while in any gear selector position, Zoom View is available. By pressing the “magnifying glass” icon in the upper left of the display screen, the image will zoom in to four times the standard view. Pressing the icon a second time will return the view to the standard Back Up Camera display.

When Zoom View is selected while the vehicle is in REVERSE, then shifted to DRIVE, the camera delay view will display the standard Back Up Camera view. If the vehicle is then returned to REVERSE gear from DRIVE, the Zoom View selection will automatically resume.

Shifting to NEUTRAL from any gear will maintain the selected view (Zoom or Standard) as long as the vehicle speed is below 8 mph (13 km/h).

If the vehicle is in PARK, Zoom View is available until the gear selector is placed in DRIVE or REVERSE and speeds are at or above 8 mph (13 km/h).

NOTE:

- If the vehicle is in DRIVE, NEUTRAL, or REVERSE, and speed is greater than or equal to 8 mph (13 km/h), Zoom View is unavailable and the icon will appear gray.
- While in Zoom View, the guidelines will not be visible.

VIEWING AT SPEED

When the vehicle is in PARK, NEUTRAL or DRIVE, the Rear View Camera can be activated with the Back Up Camera button in the Controls menu. This feature allows the customer to monitor the area directly behind the vehicle (or trailer, if equipped) for up to 10 seconds while driving. If the vehicle speed remains below 8 mph (13 km/h), the Rear View Camera image will be displayed continuously until deactivated via the X button on the touchscreen.

TRAILCAM SYSTEM — IF EQUIPPED

The TrailCam system allows you to see an on-screen image of the front view of your vehicle. The image will be displayed on the Uconnect display along with a caution note “Check Entire Surroundings” across the top of the screen.

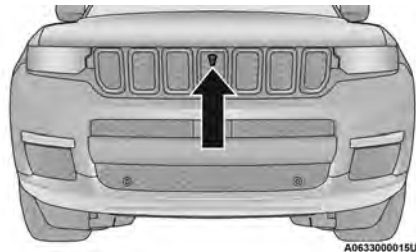

**Front View Camera****NOTE:**

The system will stay active while in 4WD Low. The TrailCam system has programmable settings that may be selected through the Uconnect system [↩](#) page 169.

Manual Activation Of The TrailCam

TrailCam view can be activated via the following methods:

- Press the FWD Camera button on the controls screen.
- Press the Forward Facing Camera button on the apps menu.
- Press the TrailCam button on the Off-Road Pages.

The TrailCam view can also be activated by pressing the  icon on the Back Up Camera view. The Back Up Camera view can also be activated by pressing the  icon on the TrailCam view.

When the vehicle is shifted out of REVERSE with camera delay turned off and TrailCam view is active, the TrailCam mode is exited and the previous screen appears again.

When the vehicle is shifted out of REVERSE with camera delay turned on and the TrailCam view is active, the TrailCam image will be displayed for up to 10 seconds unless the vehicle speed exceeds 8 mph (13 km/h), the transmission is shifted into PARK, the ignition is placed in the OFF position, or the touchscreen X button to disable display of the TrailCam view is pressed.

NOTE:

- If the vehicle speed remains below 8 mph (13 km/h) while in 2WD or 4WD High, the TrailCam image will be displayed continuously until deactivated via the touchscreen X button, the transmission is shifted into PARK, or the ignition is placed in the OFF position.
- The touchscreen X button to disable the display of the camera image is made available ONLY when the vehicle is not in REVERSE.
- The TrailCam view will stay active regardless of the vehicle speed and time while in 4WD Low.

Cleaning The TrailCam

Press and hold the Clean Camera button located on the TrailCam view to wash the TrailCam. Washer fluid will stop when the button is released. The camera can be washed up to 20 seconds at a time while holding the button.

NOTE:

- Pressing the Clean Camera button will also wash the Night Vision camera (if equipped).
- If the front window washer feature is activated, all of the front cameras on the vehicle will be washed as well. The front camera washers will not operate when the low washer fluid warning is displayed.

When enabled, active dynamic tire lines are projected on the ground plane of the TrailCam view based on the steering wheel position.

FAMCAM SYSTEM — IF EQUIPPED

The FamCam system consists of an interior monitoring camera mounted on the headliner that allows the driver to view cargo/passengers in the rear interior of the vehicle through the Uconnect screen.

 To activate the feature, press the FamCam button in the Controls tab of the Vehicle menu. The FamCam feature can also be accessed from the App Drawer, or the status bar at the top of the Uconnect display.

The display will show the entire view inside the vehicle on the left side of the screen, and will show a zoomed in view of the selected seat on the right side of the screen.

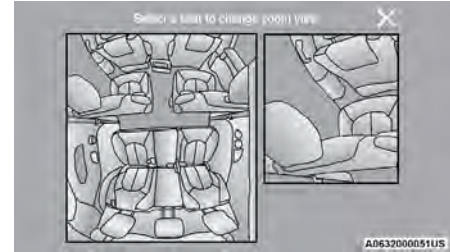

FamCam Display Example (7 Passenger Vehicle Shown)

4

To change the seat shown in the zoomed in view, press a different seat location on the left side of the display. The zoomed in view will then show the new seat location. By default, the second row driver's side seat will be displayed in the zoomed in view.

The display will appear in color in well-lit conditions and will appear black and white in low light conditions.

If the driver shifts into REVERSE or presses the X on the screen, the view will close. Otherwise, the FamCam view will remain on the display.

NOTE:

When FamCam is turned off, the selected seat in the zoomed in view on the right side of the display will be retained. The next time the feature is activated, the same seat will be shown in the zoomed in view.

NIGHT VISION CAMERA SYSTEM — IF EQUIPPED

Your vehicle may be equipped with a Night Vision Camera system which uses an infrared camera to view the area ahead of the vehicle, beyond the headlights, to detect people and large animals when it is dark outside.

The system detects pedestrians or large animals by measuring the temperature difference between the object and the surrounding area.

The thermal objects detected by the camera can be displayed in the instrument cluster display. Scroll to the Night Vision page in the instrument cluster display menu → page 89 to display the Night Vision screen.

Warm objects (e.g. animals) will appear lighter on the display while cold objects (e.g. traffic signs) will appear darker.

NOTE:

- Night Vision only shows objects of interest that are warmer or colder than the surroundings.
- Adjust the instrument cluster dimmer control brightness to make the image appear brighter or dimmer.

To exit out of the Night Vision screen, select a different menu in the instrument cluster display.

A yellow or red border and box highlight will appear around objects of interest. More than one object of interest may be highlighted.



Highlight Around Objects Of Interest

The highlighting of the object(s) of interest will update in real time based upon the current Night Vision assessment.

The two categories of Night Vision warnings are Pedestrian Warnings and Animal Warnings.



Pedestrian Warning Light



Animal Warning Light

A Pedestrian or Animal Warning is considered either Level 1 or Level 2. Level 1 warnings are yellow, and Level 2 warnings are red. The colors are not configurable.

Level 1 Warnings:

- Yellow telltale in the instrument cluster display
- Yellow highlights around the detected pedestrian/animal
- Occurs when the vehicle is moving at speeds greater than 8 mph (13 km/h) and the target is in or approaching the vehicle path

Level 2 Warnings:

- Red telltale in the instrument cluster display
- Red highlights around the detected pedestrian/animal
- Occurs when the vehicle is moving at speeds greater than 8 mph (13 km/h) and a collision with the detected pedestrian/animal is possible
- The pedestrian/animal is directly in the vehicle path, close to the headlight area
- A video pop-up will display when there is a target detected and the instrument cluster display is not showing the Night Vision page
- A chime will sound for a Level 2 Warning detection event

Only one telltale can be displayed at a time based upon priority.

The priority order of the warnings from highest to lowest is:

1. Pedestrian Warning Level 2
2. Animal Warning Level 2
3. Pedestrian Warning Level 1
4. Animal Warning Level 1

Level 2 Warnings may display in the Head Up Display (if equipped).

NOTE:

If the vehicle is stopped, or slowing down, all Level 2 warnings become Level 1 warnings.

You can enable or disable the warnings within the Uconnect system → page 169.

If the warnings are off, the telltales, chimes, and warning messages will all be off. Pedestrians and animals can still be detected by the system, but there will be no warnings.



The Night Vision alert status telltale will be gray when the warnings are suppressed. The telltale will also turn gray to indicate that the alerts are suppressed due to environmental factors (e.g. daylight hours, external temperature is greater than 86°F (30°C)) or if the gear selector is in REVERSE. When the Night Vision alerts are active, the telltale will be green → page 93.

Camera Washers

When the front window washer is activated, the Night Vision camera will also be washed → page 56.

WARNING!

- Do not jerk the steering wheel in response to a warning.
- Never attempt to swerve around animals if doing so would endanger you or others.
- Do not stare at the image while driving. You could crash and you or others could be injured.
- The Night Vision system only provides alerts to objects of interest and cannot serve as a substitute for the driver's personal judgment. The warnings are meant to direct your attention to the

(Continued)

WARNING!

detected objects, but the Night Vision system does not automatically brake the vehicle and may not provide a warning with enough time to help avoid a crash.

- Warnings are only provided if a pedestrian or large animal is detected by the system.
- It is always the driver's responsibility to be attentive of road, traffic, and weather conditions, vehicle speed, distance to the vehicle ahead, and most importantly, brake operation, to ensure safe operation of the vehicle under all road conditions. Your complete attention is always required while driving to maintain safe control of your vehicle.

DETECTION RANGE

The system can detect people 4 ft (1.25 m) tall or greater in the upright position. The system can also detect animals that are four-legged and 3 ft (1 m) tall or greater in the upright position.

The detection distance for the system is between 26 ft (8 m) and 328 ft (100 m) from the front of the vehicle.

The system may not be able to detect pedestrians or animals in the following situations:

- Pedestrian/animal is outside of the detection range
- Pedestrian/animal is fully or partially covered
- Pedestrian/animal does not reach the minimum detection height

NOTE:

Other objects on the road that meet the height/shape/temperature (e.g. sun exposure) of pedestrians/animals may be detected and classified as targets.

WARNING!

- Night Vision can only detect pedestrians and animals located within the range of the infrared camera.
- Night Vision may not detect pedestrians or animals and highlight them if:
 - They are not in an upright position, for example if they are sitting or lying down, or if the pedestrian is riding a bicycle
 - The figure in the display appears incomplete, for example because the pedestrian or animal is partially behind a vehicle
 - The pedestrian/animal is not directly ahead in the coverage area
 - The pedestrian/animal is part of a group
 - The pedestrian is wearing certain types of clothing
 - The pedestrian/animal is moving too quickly through the field of view
 - The sensor is blocked by dirt, rain, snow, or ice

SERVICE THE NIGHT VISION SYSTEM

When service conditions are present, the following fault messages may appear in the instrument cluster display when the vehicle is placed in the ON position.

If "Night Vision Unavailable Sensor Blocked" appears in the instrument cluster display, make sure the camera is clear of snow, ice, mud, dirt or other debris. The camera is located in the upper fascia/bumper, inside the driver side grille slot. Clean the camera using a soft wet cloth or by pressing the Clean Camera button in the Uconnect system. If the message continues to appear after cycling the ignition, see an authorized dealer.

If “Night Vision Temporarily Unavailable” or “Night Vision Unavailable Service Required” appears in the instrument cluster display after cycling the ignition, see an authorized dealer.

The camera must be properly aligned to work correctly. If the camera needs adjustment, see an authorized dealer. Do not attempt to adjust the camera yourself.

NOTE:

Alignment and performance of the Night Vision may be affected by aftermarket modifications. Mopar® parts should be used to get the optimal performance of this system.

NIGHT VISION SYSTEM LIMITATIONS

The Night Vision display is deactivated under the following conditions:

- Vehicle is shifted into REVERSE
- The ignition is not in the ON/RUN position
- The headlights are off and the vehicle speed is greater than 8 mph (13 km/h)

The Night Vision display warnings are suppressed under the following conditions:

- Daylight hours
- Temperatures above 86 °F (30 °C)

The system may not be fully functional in the following situations:

- On steep hills
- On tight curves of the road
- If the camera/sensor is damaged or blocked by dirt, snow, ice, or other debris

- In poor visibility conditions such as heavy fog, rain, snow, or other weather conditions
- If the vehicle has been modified with aftermarket parts and/or accessories

NOTE:

If any of these conditions are present, the system does not need service.

SURROUND VIEW CAMERA SYSTEM — IF EQUIPPED

Your vehicle may be equipped with the Surround View Camera system that allows you to see an on-screen image of the surroundings and Top View of your vehicle whenever the gear selector is put into REVERSE or a different view is selected through the touchscreen buttons. The Top View of the vehicle will show which doors are open. The image will be displayed on the Uconnect display along with a caution note “Check Entire Surroundings” across the top of the screen. After five seconds, this note will disappear. The Surround View Camera system is comprised of four sequential cameras located in the front grille, rear liftgate and side mirrors.

NOTE:

The Surround View Camera system has programmable settings that may be selected through the Uconnect system → page 169.



Press this button on the touchscreen to enter the Surround View Camera menu in the Uconnect system.

When the vehicle is shifted into REVERSE, the Rear View or Top View is the default view of the system.

When the vehicle is shifted out of REVERSE with camera delay turned on, the camera image will continue to be displayed for up to 10 seconds unless the vehicle speed exceeds 8 mph (13 km/h), the vehicle is shifted into PARK or the ignition is placed in the OFF position. There is a touchscreen X button to disable the display of the camera image.

When the vehicle is shifted out of REVERSE with camera delay turned off, the Surround View Camera mode is exited and the last known screen appears again.

When enabled, active guidelines are overlaid on the image to illustrate the width of the vehicle, including the side view mirrors and its projected backup path based on the steering wheel position.

Different colored zones indicate the distance to the rear of the vehicle.

The following table shows the approximate distances for each zone:

Zone	Distance To The Rear Of The Vehicle
Red	0 - 1 ft (0 - 30 cm)
Yellow	1 ft - 6.5 ft (30 cm - 2 m)
Green	6.5 ft or greater (2 m or greater)

Modes Of Operation

Manual activation of the Surround View Camera is selected by pressing the Surround View Camera button located in the Controls menu within the Uconnect system.

Top View

The Top View will show in the Uconnect system with Rear View or Front View in a split screen display. There are integrated ParkSense arcs in the image at the front, rear, and if equipped, the sides of the vehicle. The arcs will change color from yellow to red corresponding to the distance zones to the oncoming object.

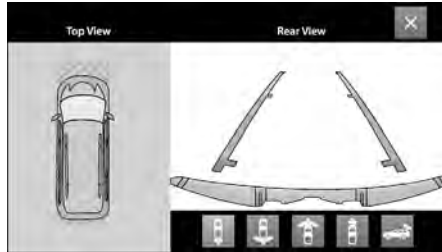

Surround View Camera View

NOTE:

- Front tires will be in image when the tires are turned.
- Due to wide angle cameras in the mirrors, the image may appear distorted.
- Top View will show which doors are open.
- Open front doors and/or liftgate will cancel outside image in Top View, but the standard view remains unchanged.

Rear View Plus Top View



This is the default view of the system in REVERSE and is always paired with the Top View of the vehicle with optional active guidelines for the projected path when enabled.

Rear Cross Path View



Pressing the Rear Cross Path button will give the driver a wider angle view of the rear camera system. The Top View will be disabled when this is selected.

Front View Plus Top View



Pressing the Front View will show you what is immediately in front of the vehicle and is always paired with the Top View of the vehicle.

Front Cross Path View



Pressing the Front Cross Path button will give the driver a wider angle view of the front camera system. The Top View will be disabled when this is selected.

Back Up Camera View



Pressing the Back Up Camera button will provide a full screen rear view with Zoom View.

NOTE:

If the Rear View Camera view was selected through the Surround View Camera menu, exiting out of the Rear View screen will return to the Surround View Camera menu. If the Back Up Camera was manually activated through the Controls menu of the Uconnect system, exiting out of the display screen will return to the Controls menu.

Deactivation

The system can be deactivated under the following conditions:

- The speed of the vehicle is greater than 8 mph (13 km/h).
- The vehicle is shifted into PARK.
- The vehicle is in any gear other than REVERSE and the touchscreen X button is pressed.
- The camera delay system is turned off manually through Uconnect Settings ➔ page 169.

Front And Rear Camera Washers

When the front windshield washer is activated by pulling the windshield wiper/washer lever rearward, the front camera is also washed.

When the rear window washer is activated by pushing the windshield wiper/washer lever forward, the Rear Back Up camera and Digital Rearview Mirror (if equipped) cameras are also washed. For more information, see ➔ page 57.

NOTE:

- If snow, ice, mud, or any foreign substance builds up on the camera lenses, clean the lenses, rinse with water, and dry with a soft cloth. Do not cover the lenses.
- If a malfunction with the system has occurred, see an authorized dealer.

WARNING!

Drivers must be careful when backing up even when using the Surround View Camera. Always check carefully behind your vehicle, and be sure to check for pedestrians, animals, other vehicles, obstructions, or blind spots before backing up. You are responsible for the safety of your surroundings and must continue to pay attention while backing up. Failure to do so can result in serious injury or death.

CAUTION!

- To avoid vehicle damage, Surround View should only be used as a parking aid. The Surround View camera is unable to view every obstacle or object in your drive path.
- To avoid vehicle damage, the vehicle must be driven slowly when using Surround View to be able to stop in time when an obstacle is seen. It is recommended that the driver look frequently over his/her shoulder when using Surround View.

ZOOM VIEW

When the Rear View Camera image is being displayed, and the vehicle speed is below 8 mph (13 km/h) while in any gear selector position, Zoom View is available.



By pressing the “magnifying glass” icon in the upper left of the display screen, the image will zoom in to two times the standard view.



Pressing the icon a second time will return the view to the standard Back Up Camera display.

When Zoom View is selected while the vehicle is in REVERSE, then shifted to DRIVE, the camera delay view will display the standard Back Up Camera view. If the vehicle is then returned to REVERSE gear from DRIVE, the Zoom View selection will automatically resume.

Shifting to NEUTRAL from any gear will maintain the selected view (Zoom or Standard) as long as the vehicle speed is below 8 mph (13 km/h).

If the vehicle is in PARK, Zoom View is available until the gear selector is placed in DRIVE or REVERSE and speeds are at or above 8 mph (13 km/h).

NOTE:

- If the vehicle is in DRIVE, NEUTRAL, or REVERSE, and speed is greater than or equal to 8 mph (13 km/h), Zoom View is unavailable and the icon will appear gray.
- While in Zoom View, the guidelines will not be visible.

REFUELING THE VEHICLE

1. Open the fuel filler door by pushing near the rear outer edge of the fuel door near the center to unlatch. Then use your hand to rotate fuel door to full open.

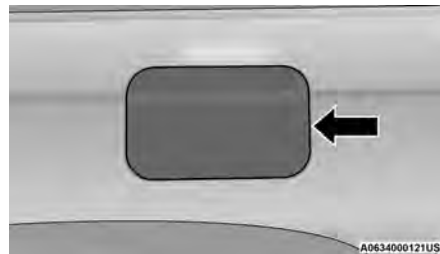
**Fuel Filler Door****NOTE:**

- In certain cold conditions, ice may prevent the fuel door from opening. If this occurs, lightly push around the perimeter of the fuel door to break the ice buildup.
 - There is no fuel filler cap. Two flapper doors inside the pipe seal the system.
2. Insert the fuel nozzle fully into the filler pipe – the nozzle opens and holds the flapper doors while refueling.

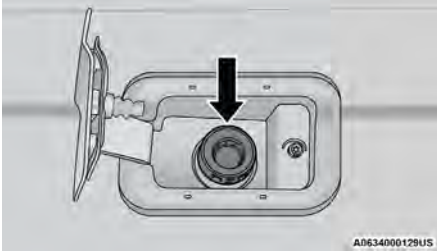
**Fuel Filler**

- Fill the vehicle with fuel – when the fuel nozzle “clicks” or shuts off the fuel tank is full.
- Wait five seconds before removing the fuel nozzle to allow fuel to drain from nozzle.
- Remove the fuel nozzle and close the fuel door. Engage the fuel door latch by pushing on the rear outer edge near the center.

WARNING!

- Never have any smoking materials lit in or near the vehicle when the fuel door is open or the tank is being filled.
- Never add fuel when the engine is running. This is in violation of most state and federal fire regulations and may cause the Malfunction Indicator Light to turn on.
- A fire may result if fuel is pumped into a portable container that is inside of a vehicle. You could be burned. Always place fuel containers on the ground while filling.

CAUTION!

To avoid fuel spillage and overflowing, do not “top off” the fuel tank after filling.

VEHICLE LOADING**GROSS VEHICLE WEIGHT RATING (GVWR)**

The GVWR is the total permissible weight of your vehicle including driver, passengers, vehicle, options and cargo. The Vehicle Certification Label specifies maximum capacities of front and rear axle systems (GAWR). Total load must be limited so GVWR and front and rear GAWR are not exceeded.

PAYLOAD

The payload of a vehicle is defined as the allowable load weight a truck can carry, including the weight of the driver, all passengers and cargo.

GROSS AXLE WEIGHT RATING (GAWR)

The GAWR is the maximum permissible load on the front and rear axles. The load must be distributed in the cargo area so that the GAWR of each axle is not exceeded.

Each axle GAWR is determined by the components in the system with the lowest load carrying capacity (axle, springs, tires or wheels). Heavier axles or suspension components sometimes specified by purchasers for increased durability do not necessarily increase the vehicle's GVWR.

TIRE SIZE

The tire size on the Vehicle Certification Label represents the actual tire size on your vehicle. Replacement tires must be equal to the load capacity of this tire size.

RIM SIZE

This is the rim size that is appropriate for the tire size listed.

INFLATION PRESSURE

This is the cold tire inflation pressure for your vehicle for all loading conditions up to full GAWR.

CURB WEIGHT

The curb weight of a vehicle is defined as the total weight of the vehicle with all fluids, including vehicle fuel, at full capacity conditions, and with no occupants or cargo loaded into the vehicle. The front and rear curb weight values are determined by weighing your vehicle on a commercial scale before any occupants or cargo are added.

LOADING

The actual total weight and the weight of the front and rear of your vehicle at the ground can best be determined by weighing it when it is loaded and ready for operation.

The entire vehicle should first be weighed on a commercial scale to ensure that the GVWR has not been exceeded. The weight on the front and rear of the vehicle should then be determined separately to be sure that the load is properly distributed over the front and rear axle. Weighing the vehicle may show that the GAWR of either the front or rear axles has been exceeded but the total load is within the specified

GVWR. If so, weight must be shifted from front to rear or rear to front as appropriate until the specified weight limitations are met. Store the heavier items down low and be sure that the weight is distributed equally. Stow all loose items securely before driving.

Improper weight distributions can have an adverse effect on the way your vehicle steers and handles and the way the brakes operate.

WARNING!

Do not load your vehicle any heavier than the GVWR or the maximum front and rear GAWR. If you do, parts on your vehicle can break, or it can change the way your vehicle handles. This could cause you to lose control. Overloading can shorten the life of your vehicle.

TRAILER TOWING

In this section you will find safety tips and information on limits to the type of towing you can reasonably do with your vehicle. Before towing a trailer, carefully review this information to tow your load as efficiently and safely as possible.

To maintain the New Vehicle Limited Warranty coverage, follow the requirements and recommendations in this manual concerning vehicles used for trailer towing.

COMMON TOWING DEFINITIONS

The following trailer towing related definitions will assist you in understanding the following information:

Gross Vehicle Weight Rating (GVWR)

The GVWR is the total allowable weight of your vehicle. This includes driver, passengers, cargo and tongue weight. The total load must be limited so that you do not exceed the GVWR → page 155.

Gross Trailer Weight (GTW)

The GTW is the weight of the trailer plus the weight of all cargo, consumables and equipment (permanent or temporary) loaded in or on the trailer in its "loaded and ready for operation" condition.

The recommended way to measure GTW is to put your fully loaded trailer on a vehicle scale. The entire weight of the trailer must be supported by the scale.

WARNING!

If the gross trailer weight is 5,000 lb (2,267 kg) or more, it is recommended to use a weight-distributing hitch to ensure stable handling of your vehicle. If you use a standard weight-carrying hitch, you could lose control of your vehicle and cause a collision.

Gross Combination Weight Rating (GCWR)

The GCWR is the total allowable weight of your vehicle and trailer when weighed in combination.

Gross Axle Weight Rating (GAWR)

The GAWR is the maximum capacity of the front and rear axles. Distribute the load over the front and rear axles evenly. Make sure that you do not exceed either front or rear GAWR → page 155.

WARNING!

It is important that you do not exceed the maximum front or rear GAWR. A dangerous driving condition can result if either rating is exceeded. You could lose control of the vehicle and have a collision.

Tongue Weight (TW)

The TW is the downward force exerted on the hitch ball by the trailer. You must consider this as part of the load on your vehicle.

Trailer Frontal Area

The frontal area is the maximum height multiplied by the maximum width of the front of a trailer.

Trailer Sway Control (TSC)

The TSC can be a mechanical telescoping link that can be installed between the hitch receiver and the trailer tongue that typically provides adjustable friction associated with the telescoping motion to dampen any unwanted trailer swaying motions while traveling.

The electronic TSC (if equipped) recognizes a swaying trailer and automatically applies individual wheel brakes and/or reduces engine power to attempt to eliminate the trailer sway.

Weight-Carrying Hitch

A weight-carrying hitch supports the trailer tongue weight, just as if it were luggage located at a hitch ball or some other connecting point of the vehicle. These kinds of hitches are used to tow small and medium sized trailers.

Weight-Distributing Hitch

A weight-distributing system works by applying leverage through spring (load) bars. They are typically used for heavier loads to distribute trailer tongue weight to the tow vehicle's front axle and the trailer axle(s). When used in accordance with the manufacturer's directions, it provides for a more level ride, offering more consistent steering and brake control thereby enhancing towing safety. The addition of a friction/hydraulic sway control also dampens sway caused by traffic and crosswinds and contributes positively to tow vehicle and trailer stability. Trailer Sway Control (TSC) and a weight-distributing (load equalizing) hitch are recommended for heavier Tongue Weights (TW) and may be required depending on vehicle and trailer configuration/loading to comply with Gross Axle Weight Rating (GAWR) requirements.

WARNING!

- If the gross trailer weight is 5,000 lb (2,267 kg) or more, it is recommended to use a weight-distributing hitch to ensure stable handling of your vehicle. If you use a standard weight-carrying hitch, you could lose control of your vehicle and cause a collision.
- An improperly adjusted weight-distributing hitch system may reduce handling, stability, braking performance, and could result in a collision.
- Weight-distributing systems may not be compatible with surge brake couplers. Consult with your hitch and trailer manufacturer or a reputable Recreational Vehicle dealer for additional information.

RECOMMENDED DISTRIBUTION HITCH ADJUSTMENT

1. Verify that the vehicle is at the Normal Ride Height.

NOTE:

The vehicle must remain in the engine run position with all doors closed while attaching a trailer for proper leveling of the air suspension system.

2. Position the vehicle to be ready to connect to the trailer (do not connect the trailer).
3. For vehicles equipped with Quadra-Lift air suspension, use the touchscreen radio settings to enable Tire/Jack mode. Tire/Jack mode will be canceled and the procedure must be restarted if the vehicle is driven at speeds above 5mph (8 km/h).
4. Measure the height from the top of the front wheel opening on the fender to ground; this is height H1.



A0636000080US

Measuring Height (H)

5. Attach the trailer to the vehicle without the weight distribution bars connected.
6. Measure the height from the top of the front wheel opening on the fender to the ground; this is height H2.
7. Install and adjust the tension in the weight distributing bars per the manufacturer's recommendations so that the height of the front fender is approximately $(H2-H1)/2+H1$ (about 1/2 the difference between H2 and H1 above Normal Ride Height [H1]).
8. Use the touchscreen radio settings and switch off Tire/Jack mode. Make sure the truck returns to Normal Ride Height. Perform a visual inspection of the trailer and weight-distributing hitch to confirm the manufacturers' recommendations have been met.
9. The vehicle can now be driven.

Measurement Example	Example Height (mm)
H1	925
H2	946
H2-H1	21
$(H2-H1)/2$	10.5
$(H2-H1)/2 + H1$	935.5

TRAILER HITCH CLASSIFICATION

The following chart provides the industry standard for the maximum trailer weight a given trailer hitch class can tow and should be used to assist you in selecting the correct trailer hitch for your intended towing condition.

Trailer Hitch Classification Definitions	
Class	Max. Trailer Hitch Industry Standards
Class I - Light Duty	2,000 lb (907 kg)
Class II - Medium Duty	3,500 lb (1,587 kg)
Class III - Heavy Duty	6,000 lb (2,722kg)
Class IV - Extra Heavy Duty	10,000 lb (4,535 kg)
Refer to the "Trailer Towing Weights (Maximum Trailer Weight Ratings)" chart for the Maximum Gross Trailer Weight (GTW) towable for your given drivetrain.	
All trailer hitches should be professionally installed on your vehicle.	

TRAILER TOWING WEIGHTS (MAXIMUM TRAILER WEIGHT RATINGS)

Grand Cherokee — 2nd Row Seats

Engine	Model	GCWR	Frontal Area	Maximum GTW	Maximum Trailer TW (See Note)
2.0L	AWD Without Trailer Tow Prep Group	9,625 lb (4,366 kg)	30 sq ft (2.79 sq m)	3,500 lb (1,588 kg)	350 lb (159 kg)
2.0L	AWD With Trailer Tow Prep Group	12,125 lb (5,568 kg)	40 sq ft (3.72 sq m)	6,000 lb (2,722 kg)	600 lb (272 kg)
3.6L	AWD Without Trailer Tow Prep Group	8,600 lb (3,901 kg)	30 sq ft (2.79 sq m)	3,500 lb (1,588 kg)	350 lb (159 kg)
3.6L	AWD With Trailer Tow Prep Group	11,300 lb (5,126 kg)	40 sq ft (3.72 sq m)	6,200 lb (2,812 kg)	620 lb (281 kg)
3.6L	RWD Without Trailer Tow Prep Group	8,500 lb (3,856 kg)	30 sq ft (2.79 sq m)	3,500 lb (1,588 kg)	350 lb (159 kg)

Engine	Model	GCWR	Frontal Area	Maximum GTW	Maximum Trailer TW (See Note)
3.6L	RWD With Trailer Tow Prep Group	11,200 lb (5,080 kg)	40 sq ft (3.72 sq m)	6,200 lb (2,812 kg)	620 lb (281 kg)
5.7L	AWD With Trailer Tow Prep Group	12,700 lb (5,761 kg)	40 sq ft (3.72 sq m)	7,200 lb (3,266 kg)	720 lb (327 kg)
Refer to local laws for maximum trailer towing speeds.					

Grand Cherokee L — 3rd Row Seats

Engine	Model	GCWR	Frontal Area	Maximum GTW	Maximum Trailer TW (See Note)
3.6L	RWD Without Trailer Tow Prep Group	9,000 lb (4,082 kg)	30 sq ft (2.79 sq m)	3,500 lb (1,588 kg)	350 lb (159 kg)
3.6L	RWD With Trailer Tow Prep Group	11,700 lb (5,307 kg)	40 sq ft (3.72 sq m)	6,200 lb (2,812 kg)	620 lb (281 kg)
3.6L	AWD Without Trailer Tow Prep Group	9,000 lb (4,082 kg)	30 sq ft (2.79 sq m)	3,500 lb (1,588 kg)	350 lb (159 kg)
3.6L	AWD With Trailer Tow Prep Group	11,700 lb (5,307 kg)	40 sq ft (3.72 sq m)	6,200 lb (2,812 kg)	620 lb (281 kg)
5.7L	AWD With Trailer Tow Prep Group	13,100 lb (5,942 kg)	40 sq ft (3.72 sq m)	7,200 lb (3,266 kg)	720 lb (327 kg)
Refer to local laws for maximum trailer towing speeds.					

NOTE:

- The trailer tongue weight must be considered as part of the combined weight of occupants and cargo, and should never exceed the weight referenced on the Tire And Loading Information Placard  page 304. The addition of passengers and cargo may require reducing trailer tongue weight and Gross Trailer Weight (GTW). Redistributing cargo (to the trailer) may be necessary to avoid exceeding Rear Gross Axle Weight Rating (GAWR).
- Vehicles not factory-equipped with the trailer tow package are limited to 3,500 lb (1,588 kg) GTW and 350 lb (158 kg) TW.

TRAILER HITCH RECEIVER COVER REMOVAL — IF EQUIPPED

Your vehicle may be equipped with a trailer hitch receiver cover, this must be removed to access the trailer hitch receiver. This cover is located at the bottom center of the rear fascia/bumper.

1. Turn the two locking retainers located at the bottom of the hitch receiver cover a quarter turn counter-clockwise and pull bottom of the hitch receiver cover outward (towards you).
2. Pull the bottom of the cover outward (towards you) then downwards to disengage the tabs located at the top of the hitch receiver cover to remove.

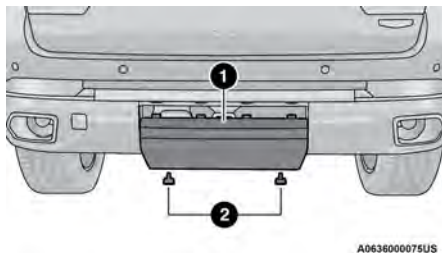

Hitch Receiver Cover

- 1 — Hitch Receiver Cover
2 — Locking Retainers

To reinstall the cover after towing repeat the procedure in reverse order.

NOTE:

Be sure to engage all tabs of the hitch receiver cover in the fascia/bumper prior to installation.

TRAILER AND TONGUE WEIGHT

Never exceed the maximum tongue weight stamped on your fascia/bumper or trailer hitch.

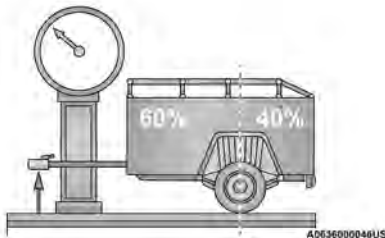

Weight Distribution

WARNING!

Always load a trailer with 60% of the weight in the front of the trailer. This places 10% of the GTW on the tow hitch of your vehicle. Loads balanced over the wheels or heavier in the rear can cause the trailer to sway severely side to side which will cause loss of control of the vehicle and trailer. Failure to load trailer heavier in front is the cause of many trailer collisions.

Consider the following items when computing the weight on the rear axle of the vehicle:

- The tongue weight of the trailer.
- The weight of any other type of cargo or equipment put in or on your vehicle.
- The weight of the driver and all passengers.

NOTE:

Remember that everything put into or on the trailer adds to the load on your vehicle. Also, additional factory-installed options or dealer-installed options must be considered as part of the total load on your vehicle. Refer to the Tire And Loading Information Placard for the maximum combined weight of occupants and cargo for your vehicle.

TOWING REQUIREMENTS

To promote proper break-in of the new vehicle drivetrain components, the following guidelines are recommended.

CAUTION!

- Do not tow a trailer at all during the first 500 miles (805 km) the new vehicle is driven. The engine, axle or other parts could be damaged.
- Then, during the first 500 miles (805 km) that a trailer is towed, do not drive over 50 mph (80 km/h) and do not make starts at full throttle. This helps the engine and other parts of the vehicle wear in at the heavier loads.

Perform the maintenance listed in the Scheduled Servicing  page 270. When towing a trailer, never exceed the GAWR or GCWR ratings.

WARNING!

Improper towing can lead to a collision. Follow these guidelines to make your trailer towing as safe as possible:

- Make certain that the load is secured in the trailer and will not shift during travel. When trailering cargo that is not fully secured, dynamic load shifts can occur that may be difficult for the driver to control. You could lose control of your vehicle and have a collision.
- When hauling cargo or towing a trailer, do not overload your vehicle or trailer. Overloading can cause a loss of control, poor performance or damage to brakes, axle, engine, transmission, steering, suspension, chassis structure or tires.
- Safety chains must always be used between your vehicle and trailer. Always connect the chains to the hook retainers of the vehicle hitch. Cross the chains under the trailer tongue and allow enough slack for turning corners.
- Vehicles with trailers should not be parked on a grade. When parking, apply the parking brake on the tow vehicle. Put the tow vehicle transmission in PARK (P). For four-wheel drive vehicles, make sure the transfer case is not in NEUTRAL (N). Always, block or "chock" the trailer wheels.
- GCWR must not be exceeded.
- **Total weight must be distributed between the tow vehicle and the trailer such that the following four ratings are not exceeded:**
 - GVWR
 - GTW
 - GAWR
 - Tongue weight rating for the trailer hitch utilized

Towing Requirements — Tires

- Do not attempt to tow a trailer while using a compact spare tire.
- Do not drive more than 50 mph (80 km/h) when towing while using a full size spare tire.
- Proper tire inflation pressures are essential to the safe and satisfactory operation of your vehicle.
- Check the trailer tires for proper tire inflation pressures before trailer usage.
- Check for signs of tire wear or visible tire damage before towing a trailer.
- Replacing tires with a higher load carrying capacity will not increase the vehicle's GVWR and GAWR limits.
- For further information ↗ page 304.

Towing Requirements — Trailer Brakes

- Do **not** interconnect the hydraulic brake system or vacuum system of your vehicle with that of the trailer. This could cause inadequate braking and possible personal injury.
- An electronically actuated trailer brake controller is required when towing a trailer with electronically actuated brakes. When towing a trailer equipped with a hydraulic surge actuated brake system, an electronic brake controller is not required.
- Trailer brakes are recommended for trailers over 1,000 lb (453 kg) and required for trailers in excess of 2,000 lb (907 kg).

WARNING!

- Do not connect trailer brakes to your vehicle's hydraulic brake lines. It can overload your brake system and cause it to fail. You might not have brakes when you need them and could have an accident.
- Towing any trailer will increase your stopping distance. When towing, you should allow for additional space between your vehicle and the vehicle in front of you. Failure to do so could result in an accident.

CAUTION!

If the trailer weighs more than 1,000 lb (453 kg) loaded, it should have its own brakes and they should be of adequate capacity. Failure to do this could lead to accelerated brake lining wear, higher brake pedal effort, and longer stopping distances.

Towing Requirements — Trailer Lights And Wiring

Whenever pulling a trailer, regardless of the trailer size, stop lights and turn signals on the trailer are required for motoring safety.

The Trailer Tow Package may include a four- and seven-pin wiring harness. Use a factory approved trailer harness and connector.

NOTE:

Do not cut or splice wiring into the vehicle's wiring harness.

The electrical connections are all complete to the vehicle but you must mate the harness to a trailer connector. Refer to the following illustrations.

NOTE:

- Disconnect the trailer wiring connector from the vehicle (or any other device plugged into vehicle's electrical connectors) before launching a boat into water.
- Be sure to reconnect once clear from water area.

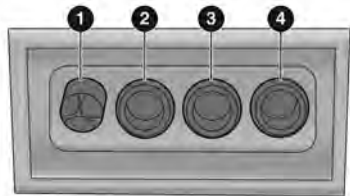

M0636000943US

Four-Pin Connector

- 1 – Ground
- 2 – Park
- 3 – Left Stop/Turn
- 4 – Right Stop/Turn

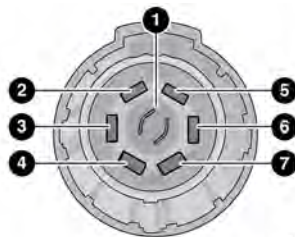

A0638000085US

Seven-Pin Connector

- 1 – Backup Lamps
- 2 – Running Lamps
- 3 – Left Stop/Turn
- 4 – Ground
- 5 – Battery
- 6 – Right Stop/Turn
- 7 – Electric Brakes

TOWING TIPS

Before towing, practice turning, stopping, and backing up the trailer in an area located away from heavy traffic.

Automatic Transmission

Select the DRIVE (D) range when towing. The transmission controls include a drive strategy to avoid frequent shifting when towing. However, if frequent shifting does occur while in DRIVE, you can use the AutoStick shift control to manually select a lower gear.

NOTE:

Using a lower gear while operating the vehicle under heavy loading conditions, will improve performance and extend transmission life by reducing excessive shifting and heat buildup. This action will also provide better engine braking.

Cruise Control — If Equipped

- Do not use on hilly terrain or with heavy loads.
- When using the Cruise Control, if you experience speed drops greater than 10 mph (16 km/h), disengage until you can get back to cruising speed.
- Use Cruise Control in flat terrain and with light loads to maximize fuel efficiency.

RECREATIONAL TOWING (BEHIND MOTORHOME)

TOWING THIS VEHICLE BEHIND ANOTHER VEHICLE

Towing Condition	Wheels OFF The Ground	Two-Wheel Drive Models	Four-Wheel Drive Models Without 4WD LOW	Four-Wheel Drive Models With 4WD LOW
Flat Tow	NONE	NOT ALLOWED	NOT ALLOWED	See Instructions <ul style="list-style-type: none"> • Transmission in PARK • Ensure vehicle is set to Normal Ride Height – if equipped • Transfer case in N (NEUTRAL) • Tow in forward direction
Dolly Tow	Front	NOT ALLOWED	NOT ALLOWED	NOT ALLOWED
	Rear	OK	NOT ALLOWED	NOT ALLOWED
On Trailer	ALL	OK	OK	OK

NOTE:

- When towing your vehicle, always follow applicable state and provincial laws. Contact state and provincial Highway Safety offices for additional details.
- Vehicles equipped with Quadra-Lift must be placed in Transport Mode before tying them down (from the body) on a trailer or flatbed truck. If the vehicle cannot be placed in Transport Mode (for example, engine will not run), tie-downs should be fastened over the tires using specific straps (not to the body). Failure to follow these instructions may cause fault codes to be set and/or cause loss of proper tie-down tension.

RECREATIONAL TOWING — TWO-WHEEL DRIVE MODELS

DO NOT flat tow this vehicle. Damage to the drivetrain will result.

Recreational towing (for two-wheel drive models) is allowed **ONLY** if the rear wheels are OFF the ground. This may be accomplished using a tow dolly or vehicle trailer. If using a tow dolly, follow this procedure:

1. Properly secure the dolly to the tow vehicle, following the dolly manufacturer's instructions.
2. Drive the rear wheels onto the tow dolly.
3. Apply the Electric Park Brake. Shift the transmission into PARK.

4. Turn the ignition OFF.
5. Properly secure the rear wheels to the dolly, following the dolly manufacturer's instructions.
6. Install a suitable clamping device, designed for towing, to secure the front wheels in the straight position.

CAUTION!

Towing with the rear wheels on the ground will cause severe transmission damage. Damage from improper towing is not covered under the New Vehicle Limited Warranty.

RECREATIONAL TOWING — QUADRA-TRAC I (SINGLE-SPEED TRANSFER CASE WITHOUT 4WD LOW RANGE) FOUR-WHEEL DRIVE MODELS

Recreational towing is not allowed. These models do not have a N (NEUTRAL) position in the transfer case.

NOTE:

This vehicle may be towed on a flatbed or vehicle trailer provided all four wheels are **OFF** the ground.

CAUTION!

Towing this vehicle in violation of the previously stated requirements can cause severe transmission and/or transfer case damage. Damage from improper towing is not covered under the New Vehicle Limited Warranty.

RECREATIONAL TOWING — QUADRA-TRAC II WITH 4WD LOW RANGE

The transfer case must be shifted into N (NEUTRAL) and the transmission must be in PARK (P) for recreational towing. The N (NEUTRAL) selection button is adjacent to the air suspension switch. Shifts into and out of transfer case N (NEUTRAL) can take place with the selector switch in any mode position.

NOTE:

- Ensure vehicle is set to Normal Ride Height - if equipped ↪ page 116.
- If the vehicle is equipped with Quadra-Lift air suspension, the engine should be started and left running for a minimum of 60 seconds (with all the doors closed) at least once every 24 hours. This process allows the air suspension to adjust the vehicle's ride height to compensate for temperature effects.

CAUTION!

- DO NOT dolly tow any 4WD vehicle. Towing with only one set of wheels on the ground (front or rear) will cause severe transmission and/or transfer case damage. Tow with all four wheels either ON the ground, or OFF the ground (using a vehicle trailer).
- Tow only in a forward direction. Towing this vehicle backwards can cause severe damage to the transfer case.
- The transmission must be in PARK for recreational towing.
- Before recreational towing, perform the procedure outlined under "Shifting into N (NEUTRAL)" to be certain that the transfer case is fully in N (NEUTRAL). Otherwise, internal damage will result.
- Towing this vehicle in violation of the previously stated requirements can cause severe transmission and/or transfer case damage. Damage from improper towing is not covered under the New Vehicle Limited Warranty.

(Continued)

CAUTION!

- Do not use a bumper-mounted clamp-on tow bar on your vehicle. The bumper face bar will be damaged.

Shifting Into Transfer Case N (NEUTRAL)

WARNING!

You or others could be injured or killed if you leave the vehicle unattended with the transfer case in the N (NEUTRAL) position without first fully engaging the Electric Park Brake. The transfer case N (NEUTRAL) position disengages both the front and rear drive-shafts from the powertrain and will allow the vehicle to roll, even if the transmission is in PARK. The Electric Park Brake should always be applied when the driver is not in the vehicle.

CAUTION!

It is necessary to follow these steps to be certain that the transfer case is fully in N (NEUTRAL) before recreational towing to prevent damage to internal parts.

Use the following procedure to prepare your vehicle for recreational towing:

1. Bring the vehicle to a complete stop on level ground, with the engine running.
2. Press and hold the brake pedal.
3. Shift the transmission into NEUTRAL.
4. If vehicle is equipped with Quadra-Lift air suspension, ensure the vehicle is set to Normal Ride Height with the Auto Entry/Exit setting deselected.

NOTE:

- Steps 1 through 4 are requirements that must be met before pushing the N (NEUTRAL) button, and must continue to be met until the shift has been completed. If any of these requirements are not met before pushing the N (NEUTRAL) button or are no longer met during the shift, then the N (NEUTRAL) indicator light will flash continuously until all requirements are met or until the N (NEUTRAL) button is released.
- The ignition must be in the ON/RUN position for a shift to take place and for the position indicator lights to be operable. If the ignition is not in the ON/RUN position, the shift will not take place and no position indicator lights will be on or flashing.
- A flashing N (NEUTRAL) position indicator light indicates that shift requirements have not been met.
- If the vehicle is equipped with Quadra-Lift air suspension, the engine should be started and left running for a minimum of 60 seconds (with all the doors closed) at least once every 24 hours. This process allows the air suspension to adjust the vehicle's ride height to compensate for temperature effects.

- Engaging/disengaging of the Electric Park Brake requires the ignition to be in the ON/RUN position.
 - If shift conditions/interlocks are not met, a "4WD Shift Canceled" or a "4WD Shift Aborted/ Retry Shift" message will be displayed on the instrument cluster. To reattempt shift, put the transmission in NEUTRAL (N) and push and hold the 4WD LOW button.
 - If shift conditions/interlocks are not met, a "To Complete 4WD Shift Put Transmission In Neutral" or a "To Complete 4WD Shift Speed Must Be Below 3 MPH" or a "To Complete 4WD Shift Allow Engine To Return To Idle" message will flash from the instrument cluster display → page 85.
5. Using a ballpoint pen or similar object, push and hold the recessed transfer case N (NEUTRAL) button (located by the selector switch) for more than four seconds. The light behind the N symbol will blink, indicating shift in progress. The light will stop blinking (stay on solid) when the shift to N (NEUTRAL) is complete. A "Four-Wheel Drive System In Neutral" message will appear in the instrument cluster.



N (NEUTRAL) Button

6. After the shift is complete and the N (NEUTRAL) light stays on, release the N (NEUTRAL) button.
7. Shift the transmission into REVERSE or DRIVE.
8. Release the brake pedal for five seconds and ensure that there is no vehicle movement.
9. Press and hold the brake pedal. Shift the transmission back into NEUTRAL.
10. Apply the Electric Park Brake.
11. With the transmission and transfer case in N (NEUTRAL), push and hold the ENGINE START/STOP button until the engine turns off. Ensure vehicle is in RUN position with the engine off.
12. Place the transmission gear selector in PARK. Release the brake pedal.
13. Attach the vehicle to the tow vehicle using a suitable tow bar.
14. Release the Electric Park Brake. Ensure vehicle is in RUN position with the engine off.
15. Push the ENGINE START/STOP button twice (without pressing the brake pedal), to turn the ignition to the OFF position.

Shifting Out Of Transfer Case N (NEUTRAL)

Use the following procedure to prepare your vehicle for normal use:

1. Bring the vehicle to a complete stop, leaving it connected to the tow vehicle.
2. Apply the Electric Park Brake.
3. Start the engine or for 4xe vehicles ensure the vehicle is in Ready to Drive mode, the READY indicator will appear in the instrument cluster display.

NOTE:

- Steps 1 through 5 are requirements that must be met before pushing the N (NEUTRAL) button, and must continue to be met until the shift has been completed. If any of these requirements are not met before pushing the N (NEUTRAL) button or are no longer met during the shift, the N (NEUTRAL) indicator light will flash continuously until all requirements are met or until the N (NEUTRAL) button is released.
 - The ignition must be in the ON/RUN position for a shift to take place and for the position indicator lights to be operable. If the ignition is not in the ON/RUN position, the shift will not take place and no position indicator lights will be on or flashing.
 - A flashing N (NEUTRAL) position indicator light indicates that shift requirements have not been met.
4. Press and hold the brake pedal.
 5. Shift the transmission into NEUTRAL.

6. Using a ballpoint pen or similar object, push and hold the recessed transfer case N (NEUTRAL) button (located by the selector switch) for five seconds.



N (NEUTRAL) Button

NOTE:

If the engine is in high idle after a cold start, the instrument cluster will display "To Complete 4WD Shift Allow Engine To Return To Idle" and the transfer case will not be able to shift out of N (NEUTRAL).

7. When the N (NEUTRAL) indicator light turns off, release the N (NEUTRAL) button. After the N (NEUTRAL) button has been released, the transfer case will always shift to 4WD HI.
8. Shift the transmission into PARK. Turn the engine off.
9. Release the brake pedal.
10. Disconnect vehicle from the tow vehicle.
11. Start the engine.

12. Press and hold the brake pedal.
13. Release the Electric Park Brake.
14. Shift the transmission into REVERSE or DRIVE, release the brake pedal, and check that the vehicle operates normally.

DRIVING TIPS

ON-ROAD DRIVING TIPS

Utility vehicles have higher ground clearance and a narrower track to make them capable of performing in a wide variety of off-road applications. Specific design characteristics give them a higher center of gravity than conventional passenger cars.

An advantage of the higher ground clearance is a better view of the road, allowing you to anticipate problems. They are not designed for cornering at the same speeds as conventional passenger cars any more than low-slung sports cars are designed to perform satisfactorily in off-road conditions. Avoid sharp turns or abrupt maneuvers. As with other vehicles of this type, failure to operate this vehicle correctly may result in loss of control or vehicle rollover.

OFF-ROAD DRIVING TIPS

Quadra-Lift — If Equipped

When off-roading, it is recommended that the lowest useable vehicle height that will clear the current obstacle or terrain be selected. The vehicle height should then be raised as required by the changes in terrain.

The Selec-Terrain switch will automatically change the vehicle to the optimized height based on the Selec-Terrain switch position. The vehicle height can be changed from the default height for each Selec-Terrain mode by normal use of the air suspension switches  page 112.

When To Use 4WD LOW Range — If Equipped

When off-road driving, shift to 4WD LOW for additional traction. This range should be limited to extreme situations such as deep snow, mud, or sand where additional low speed pulling power is needed. Vehicle speeds in excess of 25 mph (40 km/h) should be avoided when in 4WD LOW range.

WARNING!

Do not drive in 4WD LOW range on dry pavement; driveline damage may result. 4WD LOW range locks front and rear drivelines together and does not allow for differential action between the front to rear drive-shafts. Driving in 4WD LOW on pavement will cause driveline binding; use only on wet or slippery surfaces.

Driving Through Water

Although your vehicle is capable of driving through water, there are a number of precautions that must be considered before entering the water.

NOTE:

Your vehicle is capable of water fording in up to 24 inches (61 cm) with air suspension or 21 inches (53 cm) without air suspension, of water while crossing small rivers or streams. To maintain optimal performance of your vehicle's heating and ventilation system it is recommended to switch the system into recirculation mode during water fording. Be sure to avoid lowering the vehicle in water, ensure that the easy exit entry setting is turned off in Uconnect settings.

CAUTION!

When driving through water, do not exceed 5 mph (8 km/h). Always check water depth before entering as a precaution, and check all fluids afterward. Driving through water may cause damage that may not be covered by the New Vehicle Limited Warranty.

Driving through water more than a few inches/centimeters deep will require extra caution to ensure safety and prevent damage to your vehicle. If you must drive through water, try to determine the depth and the bottom condition (and location of any obstacles) prior to entering. Proceed with caution and maintain a steady controlled speed less than 5 mph (8 km/h) in deep water to minimize wave effects.

Flowing Water

If the water is swift flowing and rising (as in storm runoff), avoid crossing until the water level recedes and/or the flow rate is reduced. If you must cross flowing water avoid depths in excess of 9 inches (23 cm). The flowing water can erode the streambed, causing your vehicle to sink into deeper water. Determine exit point(s) that are downstream of your entry point to allow for drifting.

Standing Water

Avoid driving in standing water deeper than 24 inches (61 cm) with air suspension or 21 inches (53 cm) without air suspension, and reduce speed appropriately to minimize wave effects. Maximum speed is 5 mph (8 km/h).

Maintenance

After driving through deep water, inspect your vehicle fluids and lubricants (engine oil, transmission oil, axle, transfer case) to ensure the fluids have not been contaminated. Contaminated fluid (milky, foamy in appearance) should be flushed/changed as soon as possible to prevent component damage.

Driving In Snow, Mud And Sand

In heavy snow, when pulling a load, or for additional control at slower speeds, shift the transmission to a low gear and shift the transfer case to 4WD LOW if necessary  page 112. Only shift into a lower gear to maintain forward motion. Over-revving the engine can spin the wheels and traction will be lost.

Avoid abrupt downshifts on icy or slippery roads, because engine braking may cause skidding and loss of control.

Hill Climbing

NOTE:

Before attempting to climb a hill, determine the conditions at the crest and/or on the other side.

Before climbing a steep hill, shift the transmission to a lower gear and shift the transfer case to 4WD LOW. Use FIRST gear and 4WD LOW for very steep hills.

If you stall or begin to lose forward motion while climbing a steep hill, allow your vehicle to come to a stop and immediately apply the brakes. Restart the engine, and shift into REVERSE (R). Back slowly down the hill, allowing the compression braking of the engine to help regulate your speed. If the brakes are required to control vehicle speed, apply them lightly and avoid locking or skidding the tires.

WARNING!

If the engine stalls, you lose forward motion, or cannot make it to the top of a steep hill or grade, never attempt to turn around. To do so may result in tipping and rolling the vehicle. Always back carefully straight down a hill in REVERSE gear. Never back down a hill in NEUTRAL using only the brake.

Remember, never drive diagonally across a hill. Always drive straight up or down.

If the wheels start to slip as you approach the crest of a hill, ease off the accelerator and maintain forward motion by turning the front wheels slowly. This may provide a fresh "bite" into the surface and will usually provide traction to complete the climb.

Traction Downhill

When descending mountains or hills, use Hill Descent Control or Selec-Speed Control to avoid repeated heavy braking.

If not equipped with Hill Descent Control or Selec-Speed Control use the following procedure:

Shift the transmission into a low gear, and the transfer case into 4WD LOW range. Let the vehicle go slowly down the hill with all four wheels turning against engine compression drag. This will permit you to control the vehicle speed and direction.

When descending mountains or hills, repeated braking can cause brake fade with loss of braking control. Avoid repeated heavy braking by downshifting the transmission whenever possible.

After Driving Off-Road

Off-road operation puts more stress on your vehicle than does most on-road driving. After going off-road, it is always a good idea to check for damage. That way you can get any problems taken care of right away and have your vehicle ready when you need it.

- Completely inspect the underbody of your vehicle. Check tires, body structure, steering, suspension, and exhaust system for damage.
- Inspect the radiator for mud and debris and clean as required.
- Check threaded fasteners for looseness, particularly on the chassis, drivetrain components, steering, and suspension. Retighten them, if required, and torque to the values specified in the Service Manual.
- Check for accumulations of plants or brush. These things could be a fire hazard. They might hide damage to fuel lines, brake hoses, axle pinion seals, and propeller shafts.
- After extended operation in mud, sand, water, or similar dirty conditions, have the radiator, fan, brake rotors, wheels, brake linings, and axle yokes inspected and cleaned as soon as possible.
- If you experience unusual vibration after driving in mud, slush or similar conditions, check the wheels for impacted material. Impacted material can cause a wheel imbalance and freeing the wheels of it will correct the situation.

WARNING!

Abrasive material in any part of the brakes may cause excessive wear or unpredictable braking. You might not have full braking power when you need it to prevent a collision. If you have been operating your vehicle in dirty conditions, get your brakes checked and cleaned as necessary.

MULTIMEDIA

UCONNECT SYSTEMS

For detailed information about your Uconnect 5/5 NAV With 8.4-inch Display or Uconnect 5/5 NAV With 10.1-inch Display system, refer to your Uconnect Radio Instruction Manual.

NOTE:

Uconnect screen images are for illustration purposes only and may not reflect exact software for your vehicle.

CYBERSECURITY

Depending on applicability, your vehicle may be able to send or receive information from a wired or wireless network. This information allows systems and features in your vehicle to function properly.

Your vehicle may be equipped with certain security features to reduce the risk of unauthorized and unlawful access to vehicle systems and wireless communications. Vehicle software technology continues to evolve over time and FCA US LLC, working with its suppliers, evaluates and takes appropriate steps as needed. As always, if you experience unusual behavior, contact an authorized dealer immediately, ↩ page 327, or refer to your Uconnect Radio Instruction Manual for additional contact information.

The risk of unauthorized and unlawful access to your vehicle systems may still exist, even if the most recent version of vehicle software (such as Uconnect software) is installed.

WARNING!

- ONLY insert trusted devices/components into your vehicle. Media of unknown origin could possibly contain malicious software, and if installed in your vehicle, it may increase the possibility for vehicle systems to be breached.
- As always, if you experience unusual vehicle behavior, take your vehicle to an authorized dealer immediately.

NOTE:

To help further improve user experience, features, stability, etc., and minimize the potential risk of a security breach, vehicle owners should routinely check www.driveuconnect.com (US Residents) or www.driveuconnect.ca (Canadian Residents) to learn about available Uconnect software updates.

UCONNECT SETTINGS

The Uconnect system uses a combination of buttons on the touchscreen and buttons on the faceplate located on the center of the instrument panel. These buttons allow you to access and change the customer programmable features. Many features can vary by vehicle.

Buttons on the faceplate are located below and/or beside the Uconnect system in the center of the instrument panel. In addition, there is a SCROLL/ENTER control knob located on the right side. Turn the control knob to scroll through menus and change settings. Push the center of the control knob one or more times to select or change a setting.

Your Uconnect system may also have SCREEN OFF and MUTE buttons on the faceplate.

Push the SCREEN OFF button on the faceplate to turn off the Uconnect screen. Push the button again or tap the screen to turn the screen on.

Press the Back Arrow button to exit out of a Menu or certain option on the Uconnect system.

Push and hold the Power button on the radio's faceplate for a minimum of 15 seconds to reset the radio.

CUSTOMER PROGRAMMABLE FEATURES



Uconnect 5/5 NAV With 10.1-inch Display

1 – Uconnect Buttons On The Touchscreen

2 – Uconnect Buttons On The Faceplate

Press the Vehicle button, then press the Settings tab on the top of the touchscreen. In this menu, the Uconnect system allows you to access all of the available programmable features.

NOTE:

- Only one touchscreen area may be selected at a time.
- Depending on the vehicle's options, feature settings may vary.

When making a selection, press the button on the touchscreen to enter the desired menu. Once in the desired menu, press and release the preferred setting option until a check mark appears next to the setting, showing that setting has been selected. Once the setting is complete, press the Vehicle button to exit to the screen. Pressing the Up or Down Arrow button on the right side of the screen will allow you to toggle up or down through the available settings.

Display

When the Display button is pressed on the touchscreen, the system will display the options related to the theme (if equipped), brightness, and color of the touchscreen. The available settings are:

NOTE:

Depending on the vehicle's options, feature settings may vary.

Setting Name	Description
Language	This setting will change the language of the Uconnect system. The available languages are English, French, Spanish, and Italian.
Display Mode	This setting will allow you to set the brightness manually or have the system set it automatically. The "Auto" setting has the system automatically adjust the display brightness. The "Manual" setting will allow the user to adjust the brightness of the display.
Display Brightness Daytime	This setting will allow you to set the brightness when it is daytime. To access this setting, Display Mode must be set to "Manual". The "+" setting will increase the brightness; the "-" will decrease the brightness.
Display Brightness Nighttime	This setting will allow you to set the brightness when it is nighttime. To access this setting, Display Mode must be set to "Manual". The "+" setting will increase the brightness; the "-" will decrease the brightness.
Set Theme	This setting will allow you to change the display theme.
Units	This setting will allow you to change the units. The available options are "Speed" (MPH or km/h), "Distance" (mi or km), "Current Consumption" (MPG [US], MPG [UK], L/100 km, or km/L), "Pressure" (psi, kPa, or bar), and "Temperature" (°C or °F) units of measurement independently.
Theme Mode	This setting will allow you to adjust the brightness of your theme. Setting options are "Light", "Dark" and "Auto". Select to show themes in Light or Dark mode. "Auto" changes the theme with the headlights.
Touchscreen Beep	This setting will allow you to turn the touchscreen beep on or off.
Show Main Category Bar Labels	This setting will allow you to turn the bottom main category bar labels on or off.
Navigation Turn-by-Turn Displayed In Cluster	This setting will display Navigation prompts in the Instrument Cluster Display.
Phone Pop-ups Displayed In Cluster	This setting will display smartphone notifications and messages in the Instrument Cluster Display.
Ready To Drive Pop-ups	This setting will enable the Ready To Drive pop-ups in the Instrument Cluster Display.
Message Pop-Up Displayed With Button Press	This setting will activate or deactivate the message feature pop-ups.

Entertainment Screens

When the Entertainment Screens button is pressed on the touchscreen, the system displays the different options related to the vehicle's Entertainment.

NOTE:

Depending on the vehicle's options, feature settings may vary.

Setting Name	Description
Passenger Screen Permissions	This setting will enable or disable Passenger Screen Permissions. Options within this setting are "Navigation", "Device Manager", and "Uconnect Theater", and each have "On" and "Off" options.
Rear Seat Screen Permissions	This setting will enable or disable your Rear Seat Screen Permissions. "On" and "Off" options are found within "Navigation".

My Profile

When the My Profile button is pressed on the touchscreen, the system displays options related to the vehicle's profiles.

NOTE:

Depending on the vehicle's options, feature settings may vary.

Setting Name	Description
Language	This setting will change the language of the Uconnect system. The available languages are English, French, Spanish, and Italian.
Display Mode	This setting will adjust the display for the radio to "Auto" or "Manual". "Manual" allows for more customization with the radio display brightness.
Display Brightness Daytime	This setting will allow you to set the brightness when it is daytime. To access this setting, Display Mode must be set to "Manual". The "+" setting will increase the brightness; the "-" will decrease the brightness.
Display Brightness Nighttime	This setting will allow you to set the brightness when it is nighttime. To access this setting, Display Mode must be set to "Manual". The "+" setting will increase the brightness; the "-" will decrease the brightness.

Setting Name	Description
Theme Mode	This setting will allow you to adjust the brightness of your theme. Setting options are “Light”, “Dark” and “Auto”. Select to show themes in Light or Dark mode. “Auto” changes the theme with the headlights.
Units	This setting will allow you to change the units. The available options are “Speed” (MPH or km/h), “Distance” (mi or km), “Current Consumption” (MPG [US], MPG [UK], L/100 km, or km/L), “Pressure” (psi, kPa, or bar), and “Temperature” (°C or °F) units of measurement independently.
Touchscreen Beep	This setting will allow you to turn the touchscreen beep on or off.
Show Main Category Bar Labels	This setting will allow the main category bar labels to be shown on or off.
Navigation Turn-by-Turn Displayed In Cluster	This setting will display Navigation prompts in the Instrument Cluster Display.
Phone Pop-Ups Displayed In Cluster	This setting will display smartphone notifications and messages in the Instrument Cluster Display.
Message Pop-Up Displayed With Button Press	This setting will activate or deactivate the message feature pop-ups.
Time Format	This setting will allow you to set the time format (AM/PM). Sync Time With GPS must be “Off” for this setting to be available. The “12 hrs” setting will set the time to a 12-hour format. The “24 hrs” setting will set the time to a 24-hour format.
Voice Options	This setting will allow you to change the voice options for the radio to “Male” or “Female”.
Wake Up Word	This setting will allow you to set the system “Wake Up” word. The available options are “Off”, “Hey, Uconnect”, and “Hey, Jeep®”.
Voice Barge-in	This setting will allow Voice Barge-in, which is a feature that will allow you to interrupt the help message or system prompts by speaking, to be turned on or off.
Show Command List	This setting will allow the Command List to be shown on or off.
Navigation Settings	This setting will redirect to the list of Navigation settings. Refer to your Uconnect Radio Instruction Manual for further information.
Ambient Color Personalization	This setting will redirect to a new menu that will allow you to change the ambient lighting color in the cabin.
Auto-On Driver Heated/Ventilated Seat & Heated Steering Wheel	This setting will activate the vehicle’s comfort system and heated seats or heated steering wheel when the vehicle is remote started or ignition is started. The “Off” setting will not activate the comfort systems. The “Remote Start” setting will only activate the comfort systems when using Remote Start. The “All Start” setting will activate the comfort systems whenever the vehicle is started.
Radio Off Delay	This setting will keep certain electrical features running after the engine is turned off. When any door is opened, the electronics will deactivate. The available settings are “0 sec”, “45 sec”, “5 min”, and “10 min”.
Radio Off With Door	This setting will allow you to determine if the radio shuts off when any of the doors are opened.
Audio Settings	This setting will open the submenu, containing the audio settings  page 184.

Setting Name	Description
App Drawer Favoriting Pop-ups	This setting will allow you to favorite app drawer pop-ups with “On” and “Off” options.
App Drawer Unfavoritings Pop-ups	This setting will allow you to unfavoritize app drawer pop-ups with “On” and “Off” options.
New Text Message Pop-ups	This setting will allow you to have pop-up notifications for new text messages. Setting options are “On” and “Off”.
Missed Calls Message	This setting will allow you to have pop-up notifications for missed calls. Setting options are “On” and “Off”.
Navigation Pop-ups	This setting will allow you to have pop-up notifications for Navigation. Setting options are “On” and “Off”.
Reset App Drawer to Default Order	This setting will reset the app drawer to its factory default layout.
Restore Settings to Default	This setting will return all the previously changed settings to their factory defaults.
More Profile Options	This setting will give access to more profile options.

Safety & Driving Assistance

When the Safety & Driving Assistance button is pressed on the touchscreen, the system displays the options related to the vehicle’s safety settings. These options will differ depending on the features equipped on the vehicle. The settings may display in list form or within subfolders on the screen. To access a subfolder, select the desired folder; the available options related to that feature will then display on the screen.

NOTE:

Depending on the vehicle’s options, feature settings may vary.

Setting Name	Description
Forward Collision Warning Sensitivity — Located In Automatic Emergency Braking Submenu	This setting will change the distance at which the Forward Collision Warning (FCW) alert sounds. The “Medium” setting will have the FCW system signal when an object is in view, and the possibility of a collision is detected. The “Near” setting will have the FCW system signal when the object is closer to the vehicle. The “Far” setting will have the FCW system signal when an object is at a far distance from the vehicle.
Forward Collision Warning — Located In Automatic Emergency Braking Submenu	This setting will turn the Forward Collision Warning system on or off. The “Off” setting will deactivate the FCW system. If “Off” is selected, an Off icon will display on your Instrument Cluster Display. The “Warning Only” setting will provide only an audible chime when a collision is detected. The “Warning + Active Braking” setting will provide an audible chime and apply some brake pressure when a collision is detected.

Setting Name	Description
Pedestrian Emergency Braking — Located In Automatic Emergency Braking Submenu	This setting will turn the Pedestrian Emergency Braking system on or off. If “Off” is selected, an Off icon will display on your Instrument Cluster Display.
Active Driving Assist Steering Wheel Vibration	This setting will turn the Active Driving Assist Steering Wheel Vibration on or off.
Traffic Sign Assist	This setting will turn Traffic Sign Assist on or off.
Traffic Sign Assist Warning	This setting will allow you to set the warning type related to the traffic sign. The available options are “Off”, “Visual”, and “Visual + Chime”.
Traffic Sign Assist Sensitivity	This setting will change the Traffic Sign Assist Sensitivity. The available options are “+ 0”, “+ 5”, and “+ 10”.
Traffic Sign Assist Offset	This setting will alter the Traffic Sign Assist Offset. The available options will allow you to adjust the offset from a range of 0 to 5 mph.
Traffic Sign	Within this setting are three additional settings: “Traffic Sign Blinking” with “On” and “Off” options, “Traffic Sign Sensitivity” with “+ 0”, “+ 5”, and “+ 10” options, and “Traffic Sign Information Offset” with selectable options between 0 to 5 mph.
New Speed Zone Indication	This setting will allow you to set if the system will warn you that the speed limit has changed in an area. The available options are “Off”, “Visual”, and “Visual + Chime”.
Active Lane Management	This setting will alert the driver when a lane departure is detected. The available options are “Vibration Only”, “Steering Assist Only”, and “Vibration + Steering Assist”.
Lane Warning	This setting will let you choose between “Early”, “Medium”, and “Late”.
Vibration Strength	This setting will allow you to change the vibration strength between “Low”, “Medium”, and “High”.
Steering Assist Strength	This setting will change the strength of the steering wheel feedback during a lane departure. The available settings are “Low”, “Medium”, and “High”.
Night Vision Video Warning	This setting will turn the Night Vision Video Warning and green/gray cluster indicator light on or off.
ParkSense	This setting will change the type of ParkSense alert when a close object is detected and provide “only warning” and “warning + braking assist” options.
Front ParkSense Volume	This setting adjusts the volume of the Front ParkSense system. The available settings are “Low”, “Medium”, and “High”.
Rear ParkSense Volume	This setting adjusts the volume of the Rear ParkSense system. The available settings are “Low”, “Medium”, and “High”.
Rear ParkSense Braking Assist	This setting will turn the Rear ParkSense Braking Assist on or off.
Side Distance Warning	This setting will turn the Side Distance Warning on or off.
Drowsy Driver Detection	This setting will monitor the driver’s driving habits and warn you of any changes, indicating that the driver may be drowsy. The available options are “On” and “Off”.

Setting Name	Description
Blind Spot Alert	This setting will change the type of alert provided when an object is detected in a vehicle's blind spot. The "Off" setting will turn off Blind Spot Alert. The "Lights" setting will activate the Blind Spot Alert lights on the outside mirrors. The "Lights & Chime" setting will activate the lights on the outside mirrors and an audible chime.
Electric Power Steering Default	This setting will change the Electric Power Steering Default. The available options are "Comfort" for a lower effort steering experience, "Normal" for the standard effort steering experience, and "Sport" for a higher effort steering experience.
Hill Start Assist	This setting will turn the Hill Start Assist system on or off.
Tire Fill Assist	This setting will turn Tire Fill Assist on or off.
Rear Seat Alert	When this setting is turned on and the rear doors are opened while the engine is running, or if the engine is turned on within 10 minutes of the door opening, a message will appear to check the rear seat when the vehicle is powered OFF.

Clock & Date

When the Clock & Date button is pressed on the touchscreen, the system displays the different options related to the vehicle's internal clock.

NOTE:

Depending on the vehicle's options, feature settings may vary.

Setting Name	Description
Sync Time With GPS	This setting will sync the time to the GPS receiver in the system. The system will control the time via the GPS location.
Time Format	This setting will allow you to set the time format (AM/PM). Sync Time With GPS must be off for this setting to be available. The "12 hrs" setting will set the time to a 12-hour format. The "24 hrs" setting will set the time to a 24-hour format.
Set Time	This setting will allow you to set the hours and minutes. Sync Time With GPS must be off for this setting to be available. The "+" setting will increase the hours or minutes. The "-" setting will decrease the hours or minutes.
Set Time Hours	This setting will allow you to set the hours. Sync Time With GPS must be off for this setting to be available. The "+" setting will increase the hours. The "-" setting will decrease the hours.
Set Time Minutes	This setting will allow you to set the minutes. Sync Time With GPS must be off for this setting to be available. The "+" setting will increase the minutes. The "-" setting will decrease the minutes.

Setting Name	Description
Set Date	This setting will allow you to set the day, month and year. Using “+” or “-”, you can scroll through the available days, months, and years.
Show Time and Date During Screen Off	This setting will allow you to show the time and date while the screen is off. Available options are “On” and “Off”.

Phone/Bluetooth®

When the Phone/Bluetooth® button is pressed on the touchscreen, the system displays the options related to Bluetooth® connectivity from an external audio device or smartphone. The list of paired audio devices or smartphones can be accessed from this menu.

NOTE:

Depending on the vehicle's options, feature settings may vary.

Setting Name	Description
Device Manager	This setting will open the Device Manager main screen.
Do Not Disturb All	This setting will open the Do Not Disturb All settings menu. The available options are “On” and “Off”.
Enable Two Active Phones	This setting will enable or disable two active phones with the vehicle. The setting options are “On” and “Off”.
Phone Pop-Ups Displayed In Cluster	This setting will activate phone message pop-ups in the Instrument Cluster Display.

Voice

When the Voice button is pressed on the touchscreen, the system displays the options related to the vehicle's Voice Recognition feature.

NOTE:

Depending on the vehicle's options, feature settings may vary.

Setting Name	Description
Voice Options	This setting will allow you to change the system's voice to either "Male" or "Female".
Wake Up Word	This setting will allow you to set the system's "Wake Up" word. The available options are "Off", "Hey, Uconnect", and "Hey, Jeep®".
Voice Barge-In	This setting allows you to respond to a Voice Response before the statement is completed by the system. The available options are "On" and "Off".
Show Command List	This setting will allow you to turn the Command List on or off. The "Always" setting will always show the Command List. The "With Help" setting will show the Command List and provide a brief description of what the command does. The "Never" setting will turn the Command List off.

Navigation

When the Navigation button is pressed on the touchscreen, the system displays options related to the vehicle's built-in Navigation system. These settings can change which icons display on the map, how "time to arrival is calculated", and route types.

For more information on Navigation and settings, refer to your Uconnect Radio Instruction Manual.

Camera

When the Camera button is pressed on the touchscreen, the system displays the options related to the vehicle's camera features.

NOTE:

Depending on the vehicle's options, feature settings may vary.

Setting Name	Description
Surround View Camera Delay	This setting will add a timed delay to the Surround View Camera when shifting out of REVERSE.
Surround View Camera Guidelines	This setting will turn the Surround View Camera Guidelines on or off.
ParkView Backup Camera Delay	This setting will add a timed delay to the ParkView Backup Camera when shifting out of REVERSE.
ParkView Backup Camera Active Guidelines	This setting will turn the ParkView Backup Camera Active Guidelines on or off.
Forward Facing Camera Guidelines	This setting will turn the Forward Facing Camera Guidelines on or off.

Mirrors & Wipers

When the Mirrors & Wipers button is pressed on the touchscreen, the system displays the options related to the vehicle's mirrors and wipers.

NOTE:

Depending on the vehicle's options, feature settings may vary.

Setting Name	Description
Tilt Side Mirrors In Reverse	This setting will tilt the outside side-view mirrors when the ignition is in the ON/RUN position and the transmission gear selector is in the REVERSE position. The mirrors will move back to their previous position when the transmission is shifted out of REVERSE. The available settings are "On" and "Off".
Auto Folding Side Mirrors	This setting will automatically fold and unfold the side-view mirrors when the vehicle is turned off, the doors are locked, or the key fob button is pushed. The available options are "On" and "Off".
Rain Sensing Auto Wipers	This setting will turn the Rain Sensing Auto Wipers on or off.
Headlights With Wipers	This setting will turn the headlights on when the wipers are activated.

Lights

When the Lights button is pressed on the touchscreen, the system displays the options related to the vehicle's exterior and interior lights.

NOTE:

- When the "Daytime Running Lights" feature is selected, the daytime running lights can be turned on or off. This feature is only allowed by law in the country of the vehicle purchase.
- Depending on the vehicle's options, feature settings may vary.

Setting Name	Description
Ambient Color Personalization	This setting will redirect to a new menu that will allow you to change the ambient lighting color in the cabin.
Headlight Off Delay	This setting will allow you to set the amount of time it takes for the headlights to shut off after the vehicle is turned off. The available settings are "0 sec", "30 sec", "60 sec", and "90 sec".
Headlight Illumination On Approach	This setting will allow you to set the amount of time it takes for the headlights to shut off after the vehicle is unlocked. "Greeting Lights" must be selected and "Headlight Illumination on Approach" must be selected above 0 seconds for the feature to be enabled. The available settings are "0 sec", "30 sec", "60 sec", and "90 sec".
Headlights with Wipers	This setting will turn the headlights on when the wipers are activated.
Proximity Wake-Up	This setting will allow you to turn on or off some exterior and interior lighting illumination when approaching the vehicle. NOTE: "Headlight Illumination On Approach" must be set to a value other than zero for "Proximity Wake-Up" to be active.
Greeting Lights	When the "Greeting Lights" feature is selected, it enables "Headlight Illumination On Approach". When "Headlight Illumination On Approach" is selected, it allows the adjustment of the amount of time the headlights remain on after the doors are unlocked with the key fob. "Greeting Lights" must be selected and "Headlight Illumination On Approach" must be selected above zero seconds for the feature to be enabled. The available settings are "On" and "Off".
Auto Dim High Beams	This setting will allow you to turn the Auto Dim High Beams on or off.
Daytime Running Lights	This setting will allow you to turn the Daytime Running Lights on or off.
Cornering Lights	When this setting is selected, if the steering wheel rotation angle is large or the turn signal indicators are on, a light (incorporated in the fog light) will turn on, on the relevant side to improve visibility at night.
Flash Lights With Lock	This setting will allow you to turn the flashing of the lights when the Lock button is pushed on the key fob on or off.

Brakes

When the Brakes button is pressed on the touchscreen, the system will display settings related to the vehicle's brake system.

NOTE:

Depending on the vehicle's options, feature settings may vary.

Setting Name	Description
Auto Park Brake	This setting will turn the Auto Park Brake on or off.
Brake Service	This setting will allow you to set the brakes for service. When the setting is selected, a pop-up will display with "Yes" and "No" options.

Doors & Locks

When the Doors & Locks button is pressed on the touchscreen, the system displays the options related to locking and unlocking the vehicle's doors.

NOTE:

Depending on the vehicle's options, feature settings may vary.

Setting Name	Description
Auto Unlock On Exit	This setting will unlock the doors when any of the doors are opened from the inside.
Flash Lights With Lock	This setting will allow you to turn the flashing of the lights when the Lock button is pushed on the key fob on or off.
Sound Horn With Lock	This setting will sound the horn when the Lock button is pushed on the key fob. The "Off" setting will not sound the horn when the Lock button is pushed. The "1st Press" setting will sound the horn when the Lock button is pushed once. The "2nd Press" setting will sound the horn when the Lock button is pushed twice.
Sound Horn With Remote Start	This setting will sound the horn when the remote start is activated from the key fob.
Remote Door Unlock, Door Lock/1st Press Of Key Fob Unlocks	This setting will change how many pushes of the Unlock button on the key fob are needed to unlock all the doors. The "Driver Door" setting will only unlock the driver door on the first push on the Unlock button. The "All Doors" setting will unlock all doors with only one push of the Unlock button.

Setting Name	Description
Passive Entry	This setting will allow you to turn the Passive Entry feature (Keyless Enter 'n Go™) on or off.
Personal Settings Linked To Key Fob	This setting will recall preset radio stations and driver seat position that have been linked to the key fob.
Power Liftgate Alert	This setting will chime an audible alert when the power liftgate is raising or lowering. Selectable options are “On” and “Off”.
Hands-Free Power Liftgate	This setting will use hands-free technology to automatically open or close the power liftgate. Selectable options are “On” and “Off”.
Auto Relock	This setting will lock the doors after 30 seconds of the doors remaining unlocked. The available options are “On” and “Off”.

Seats & Comfort

When Seats & Comfort button is pressed on the touchscreen, the system displays the options related to the vehicle's comfort systems when remote start has been activated or the vehicle has been started.

NOTE:

Depending on the vehicle's options, feature settings may vary.

Setting Name	Description
Easy Exit Seats	This setting will automatically move the driver seat rearward when the engine is shut off. The available settings are “On” and “Off”.
Auto-On Driver Heated/Ventilated Seat & Heated Steering Wheel With Vehicle Start	This setting will activate the vehicle's comfort systems and heated seats or heated steering wheel when the vehicle is remote started or ignition is started. The “Off” setting will not activate the comfort systems. The “Remote Start” setting (if equipped) will only activate the comfort systems when using Remote Start. The “All Start” setting will activate the comfort systems whenever the vehicle is started.
3rd Row Seat Recline Lockout	This setting will activate the 3rd Row Seat Recline Lockout. Selectable options are “Off”, “Lock On Ignition”, and “Always Locked”.

Key Off Options

When the Key Off Options button is pressed on the touchscreen, the system displays the options related to vehicle shutoff. These settings will only activate when the ignition is set to OFF.

NOTE:

Depending on the vehicle's options, feature settings may vary.

Setting Name	Description
Sound Horn With Lower	This setting will sound the horn when the Lower button is pressed on the key fob.
Flash Lights With Lower	This setting will flash the lights when the Lower button is pressed on the key fob.
Easy Exit Seat	This setting adjusts the seats to make exiting the vehicle easier.
Headlight Off Delay	This setting will allow you to set the amount of time the headlights remain on after the vehicle has been turned off. The available settings are "0 sec", "30 sec", "60 sec", and "90 sec".
Auto Entry/Exit Suspension	This setting will turn the Auto Entry/Exit Suspension system on or off.
Radio Off Delay	This setting will keep the radio on for the selected amount of time after vehicle shut off. The available options are "0 sec", "45 sec", "5 min", and "10 min".
Radio Off With Door	This setting will keep the radio on when a door is opened or until the Radio Off Delay time is reached. The available settings are "On" and "Off".
Windows With Key Fob	This setting will allow you to control window function while the vehicle is off. The available options are "On" and "Off".

Suspension

When the Suspension button is pressed on the touchscreen, the system will display settings related to the vehicle's air suspension.

NOTE:

Depending on the vehicle's options, feature settings may vary.

Setting Name	Description
Auto Entry/Exit Suspension	This setting will turn the Auto Entry/Exit Suspension system on or off.
Display Suspension Messages	This setting will display suspension messages in the Instrument Cluster Display. The "All" setting will display all available messages. The "Warnings Only" setting will only display warning messages.
Tire Jack Mode	This setting will disable the Air Suspension system to assist in changing a spare tire.
Auxiliary Mode	This setting will allow you to set the Auxiliary Suspension Mode. The available options are "Off", "Transport Mode", and "Wheel Alignment Mode". In Transport Mode, the vehicle will not auto level when being transported by another vehicle. In Wheel Alignment Mode, the vehicle will not auto level when a wheel alignment is being performed.

Audio

When the Audio button is pressed on the touchscreen, the system displays options related to the vehicle's sound system. These settings can change the audio location within the vehicle, adjust the bass or treble levels, and auto-play settings from an audio device or smartphone.

NOTE:

Depending on the vehicle's options, feature settings may vary.

Setting Name	Description
Balance/Fade	This setting will adjust audio levels from specific speakers in the front/back and left/right of the vehicle. The Speaker icon can be moved to set audio location.
Equalizer	This setting will adjust the "Bass", "Mid", and "Treble" ranges of the audio.

Setting Name	Description
Speed Adjusted Volume	This setting will adjust audio volume as speeds increase. At a higher setting, the volume will increase more as the vehicle speeds up. The available settings are "Off", "1", "2", and "Max".
Surround Sound	This setting will turn the Surround Sound system on or off.
AUX Volume Offset	This setting will tune the audio levels from a device connected through the AUX port. The available settings are "+" and "-".
Auto Play	This setting will automatically begin playing audio from a connected device.
Auto-On Radio	This setting will automatically turn the radio on when the vehicle is started, if selected. The available settings are "Off", "On", and "Recall Last". With Recall Last, the system resumes the previous task before vehicle shut off.
Radio off With Door	This setting will keep the radio on when a door is opened or until the Radio Off Delay time is reached. The available settings are "On" and "Off".
Volume Adjustment	This setting will allow you to set the audio volume levels for each option (Media, Phone, Navigation, etc.). You can set the volume between 0 and 38.
Media Expander	This setting will allow you to turn the Media Expander setting "On" or "Off".
Loudness	This setting will improve audio quality at lower volumes.

Notifications

When the Notifications button is pressed on the touchscreen, the system displays the options related to Notifications for the system.

NOTE:

Depending on the vehicle's options, feature settings may vary.

Setting Name	Description
Notification Sounds	Turn this setting "On" or "Off" to hear notification sounds throughout your system.
App Drawer Favoriting Pop-Ups	This setting turns the App Favorited pop-up on or off.
App Drawer Unfavoriting Pop-Ups	This setting turns the App Unfavorited pop-up on or off.
New Text Message Pop-Ups	This setting turns receiving/storing a pop-up for new text messages of any connected phone on or off.
Missed Calls Message	This setting turns receiving/storing a pop-up for missed calls of any connected phone on or off.
Navigation Pop-Ups	This setting turns receiving/storing predictive Navigation Pop-Ups on or off.

SiriusXM® Setup

When the SiriusXM® Setup button is pressed on the touchscreen, the system displays the options related to SiriusXM® satellite radio. These settings can be used to skip specific radio channels and restart favorite songs from the beginning.

NOTE:

- A subscription to SiriusXM® satellite radio is required for these settings to be functional.
- Depending on the vehicle's options, feature settings may vary.

Setting Name	Description
SiriusXM® Account, Profile, And Settings	This setting will redirect you to the SiriusXM® Settings menu within the SiriusXM® menu.
Block Explicit	This setting will skip over content labeled as explicit. The available settings are "On" and "Off".

Accessibility — If Equipped

After pressing the Accessibility button on the touchscreen, the following setting will be available:

NOTE:

Depending on the vehicle's options, feature settings may vary.

Setting Name	Description
Video Button Readback	This setting will turn the Video Button Readback feature on or off.

Software Updates

When the Software Updates button is pressed on the touchscreen, the system will display the setting related to updating the Uconnect software.

NOTE:

Depending on the vehicle's options, feature settings may vary.

Setting Name	Description
Software Downloads over Wi-Fi	This setting will allow software updates to happen over Wi-Fi. Selectable options for the setting are "On" and "Off".

System Information

After pressing the System Information button on the touchscreen, the following settings will be available:

NOTE:

Depending on the vehicle's options, feature settings may vary.

Setting Name	Description
Version Information	When this feature is selected, a Version Information screen will appear, displaying information about the version of your radio.
License Information	When this feature is selected, a License Information screen will appear, displaying the licensing information of your radio.
Passenger License Information	When this feature is selected, Passenger License Information is displayed.

Reset

When the Reset button is pressed on the touchscreen, the system displays the options related to resetting the Uconnect system back to its default settings. These settings can clear personal data and reset selected settings from other menus.

NOTE:

Depending on the vehicle's options, feature settings may vary.

Setting Name	Description
Restart Radio	This setting will reboot the radio.
Reset Apps Drawer To Default Order	This setting will return the apps drawer to the default order. The available options are "Yes" and "Cancel". The X button can also be pressed to cancel the screen.
Restore Settings to Default	This setting will return all the previously changed settings to their factory defaults.
Clear Personal Data	This setting will display a pop-up that gives you the option to clear all personal data from the system, including Bluetooth® devices and presets.
Reset Wi-Fi Password For Projection	This setting will allow you to reset the vehicle's Wi-Fi password for smartphone projection. The available options are "Yes" and "Cancel". The X button can also be pressed to cancel the screen.
Reset Performance Values	This setting will reset the performance values for your vehicle.
Factory Reset	This setting will restore the radio to its factory default settings.

STEERING WHEEL AUDIO CONTROLS

The remote sound system controls are located on the rear surface of the steering wheel at the three and nine o'clock positions.



A042000006US

Steering Wheel Audio Controls

The right-hand control is a rocker-type switch with a push button in the center and controls the volume and mode of the sound system. Pushing the top of the rocker switch increases the volume, and pushing the bottom of the rocker switch decreases the volume.

Pushing the right-hand control's center button makes the radio switch between the various modes available (AM/FM/SXM or Media, etc.)

The left-hand control is a rocker-type switch with a push button in the center. The function of the left-hand control is different depending on which mode you are in.

The following describes the left-hand control operation in each mode:

RADIO OPERATION

Pushing the top of the switch will seek up for the next available station, and pushing the bottom of the switch will seek down for the next available station.

The button located in the center of the left-hand control will tune to the next preset station that you have programmed in the radio preset button.

MEDIA MODE

Pushing the top of the switch once goes to the next track on the selected media (AUX/USB/Bluetooth®). Pushing the bottom of the switch once goes to the beginning of the current track, or to the beginning of the previous track if it is within eight seconds after the current track begins to play.

PASSENGER SCREEN — IF EQUIPPED

Your vehicle may be equipped with a Passenger Screen located above the glove compartment on the passenger side of the vehicle. From the Passenger Screen, you will be able to access similar features seen within the Uconnect radio, such as media functions, Rear Seat Entertainment with Amazon FireTV Built-in, Navigation, and device management.

To begin using the Passenger Screen, push the Power button in the center stack, or press the Power button under the Controls tab within the Uconnect system. The Passenger Screen can be turned off by accessing the Control screen and pressing the Power Off button.

You must link Bluetooth® headphones to the Passenger Screen to begin listening to the system's audio
 ⇨ page 192.

NOTE:

The Passenger Screen will need to be turned On each time the vehicle is started, and the system will display the Home screen upon boot up.

PASSENGER SCREEN PERMISSIONS

Through the Uconnect system, features within the Passenger Screen can be activated and deactivated through Passenger Screen Permissions. To access Permissions, press the Vehicle button in the Menu Bar and select the Settings tab. Then, press the Passenger Screen Settings menu. Press the On button for the Passenger Screen Permissions setting to activate Permissions.



Passenger Screen Permissions Settings Menu

By default, the Passenger Screen Permissions setting is set to "Off", and the driver will need to give permission for the different features.

When Permissions is turned “On”, you can individually select the permissions for the followings:

- Navigation
- Device Manager
- Rear Seat Entertainment — If Equipped

Passenger Screen Permissions can also be activated through the Controls screen, under the Vehicle button in the Menu Bar. If “Deny Passenger Screen Permissions” is turned “On”, the setting will switch itself to “Off”.

HOME SCREEN



Passenger Screen Home Screen

- 1 — Home Screen Button
- 2 — Notifications Button
- 3 — Controls Button
- 4 — Feature Cards

When the Passenger Screen is started up and no other media was running during the last ignition cycle, the Home screen will display. Here, you can select from the features of the Passenger Screen. On the left side of the screen, you can access “Notifications and System Controls”.

The Notifications button (the bell) will take you to the Notifications screen, identical to what is seen in the main radio.

You can cycle between the features by swiping left or right on the touchscreen. When accessing a feature, press the Home button on the left side to access the feature view and select a different feature.

The available features are:

- Audio
- Video & Images
- HDMI
- Rear Seat Entertainment — If Equipped
- Navigation
- Devices
- Cameras

Controls Screen

From the Controls Screen, you can adjust the daytime/nighttime brightness of the screen, change headphone volume, and power off the Passenger Screen.

To change the brightness, adjust the slider up or down, or press the Up or Down Arrow button located next to the slider. “Up” will increase brightness; “Down” will decrease brightness. Daytime and nighttime brightness levels will vary, and the adjustment maximum/minimum will differ depending on the time of day.

To change the headphone volume, adjust the slider up or down, or press the Up or Down Arrow button located next to the slider. “Up” will increase the volume; “Down” will decrease the volume.

NOTE:

Headphone volume can also be manually adjusted from the headphones. Changing the headphone volume manually will not reflect in the headphone volume slider on the Passenger Screen.

If the Screen Off button is pressed, the Passenger Screen will continue to operate, but the screen will go dark. Tap the screen again to return to the display. While the screen is off, audio will continue to play from the Passenger Screen.

The Power Off button will fully shut down the Passenger Screen. No audio or video will play from it.

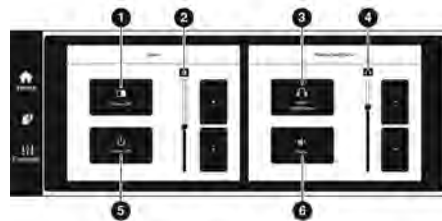

Passenger Screen Controls Screen

- 1 — Screen Off
- 2 — Display Brightness
- 3 — Manage Headphones
- 4 — Headphone Volume
- 5 — Power Off
- 6 — Mute Headphones

AUDIO AND VIDEO



Audio Feature

- 1 – All Sources Tab
- 2 – Now Playing Tab
- 3 – Browse Tab

Audio allows you to listen to your favorite radio station, a connected USB device, or connected media device. You can directly change the source on the Home screen by pressing the Source button in the feature. You can also expand it by pressing the Full Screen View button. To change the media source, press the Source button and then press on the desired source. The available sources are:

- Live Radio (FM, AM, SXM)
- Bluetooth®
- USB 1
- USB 2

- AUX
- AV 1 – If Equipped
- AV 2 – If Equipped
- Rear Screen 1 Listen In – If Equipped
- Rear Screen 2 Listen In – If Equipped

NOTE:

- Audio devices connected via Bluetooth® must be done through the Device Manager in the radio. For more information on pairing a device, refer to your Uconnect Radio Instruction Manual.
- If the driver is listening to “Live Radio”, the option will not be available in the Passenger Screen. Select “Now Playing On Radio” to listen to the currently playing station. If the driver selects a radio station while the Passenger Screen is playing live radio content, the feed will end on the Passenger Screen and control will be given to the Uconnect system.

On the Preset menu, you will be able to listen to saved radio presets. Press the desired preset to begin listening.

The Browse tab will let you browse through different radio stations or audio saved onto a USB or audio device. Press “Browse” and select from the different folders. You can scroll up and down to view the options within those folders. Press on the desired radio station or audio track to begin playing it.

When the USB source is selected, you can choose a video file to play if saved to a USB device. Press “Browse” and locate the folder with the video file. Press the video file name, and it will begin to play on the Passenger Screen.

NOTE:

Not all video files will be supported from a USB. Certain video files may require digital rights to view or play. These may be unavailable for playback on the Passenger Screen.



Playing A Video

- 1 – Source Bar
- 2 – Now Playing Tab
- 3 – Browse Tab
- 4 – Preset Bar
- 5 – Related Button
- 6 – Seek Down Button
- 7 – Tune Button
- 8 – Seek Up Button
- 9 – Replay Button

REAR SEAT ENTERTAINMENT WITH AMAZON FIRE TV BUILT-IN — IF EQUIPPED

Rear Seat Entertainment with Fire TV built-in will let you control and listen in to the content being played on the rear entertainment screens. You can view the contents of the rear screens, lock the rear screens, change the source of the rear screens, or turn the rear screens on or off → page 194.

HDMI PROJECTING

HDMI lets you connect a device to the provided HDMI port, using an HDMI cable, and project the device directly to the Passenger Screen. To begin, plug a device into the HDMI port. Then, press the HDMI button on the touchscreen.

HDMI will continue to show the menu bar and Headphone Pairing button.

NOTE:

- The HDMI Card will not automatically launch when a new device is connected. The HDMI Card will show a device connected, and the Card will need to be pressed.
- If the user disconnects a device from the HDMI port while the HDMI Card is in full screen, the system will close HDMI and reload the Home screen.

DEVICE MANAGER

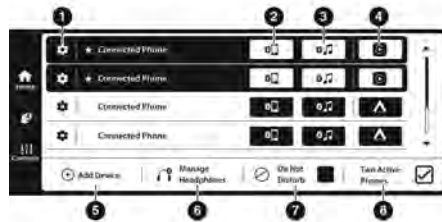

Device Manager

- 1 — Device Settings Button
- 2 — Phone Connectivity Button
- 3 — Media Connectivity Button
- 4 — Android Auto™/Apple CarPlay® Button
- 5 — Add Device Button
- 6 — Manage Headphone Button
- 7 — Do Not Disturb Button
- 8 — Two Active Phones Button

Device Manager provides an easy place to view all the devices connected to the Uconnect system and lets you pair the Driver's smartphone to the Uconnect system. You will also pair Bluetooth® headphones to the Passenger Screen from this screen.

For more information on pairing your smartphone, refer to your Uconnect Radio Instruction Manual.

To pair a set of Bluetooth® Headphones:

1. If viewing Device Manager in full screen, press the Add Device button. If viewing Device Manager on the Home screen, press "Pair Bluetooth® headphones".
2. From the pop-up, press "Search For Headphones". The system will begin searching for the Bluetooth® signal of your headphones.
3. Select the name of your headphones from the list of possible devices. The system will connect to the headphones.

NOTE:

The Passenger Screen will connect to previously paired Bluetooth® headphones after Passenger Screen activation.

Removing Bluetooth® Headphones

1. From the Controls screen, press the Manage Headphones button.
2. Press the Settings button (gear icon) next to the set of headphones you wish to remove.
3. Press "Delete Device"; the Bluetooth® headphones will be removed from the system.

NAVIGATION

Navigation allows you to assist the driver in searching for destinations using Uconnect's built-in Navigation system. For information on the full functionality of Navigation, refer to your Uconnect Radio Instruction Manual.

When a new route is selected from the Passenger Screen, a confirmation will be sent to the driver. The driver will be able to confirm or deny the route.

NOTE:

Using Navigation on the Passenger Screen will not affect the Navigation screen in the Uconnect system. The Driver can continue to use Navigation while the Passenger Screen can “suggest” new routes or stops.

CAMERA

Camera will display the equipped vehicle camera feed. When selected, press the desired Camera button. The feed from that camera will display in the center of the touchscreen. Press the X button or Back Arrow button to return to the Home screen.

NOTE:

The Passenger Screen will lose access to a camera if the driver chooses to view it on the Uconnect system or if a condition would activate the camera on the Uconnect system (the rearview camera being activated when the vehicle is shifted into REVERSE).

The McIntosh app will allow you to perform the following when listening to music:

NOTE:

The Seek feature will not work while using Bluetooth®.

Skip Backward	Press to skip backward. Press and hold to fast rewind.
Play/Pause	Press to play/pause the track.
Skip Forward	Press to skip forward. Press and hold to fast forward.
Repeat	Press to repeat track. Press again to repeat playlist. Press again to turn off (works only with a USB device).
Change Channel Down	Press to change channel down. Press and hold to seek channel down. While using AM/FM, pressing the channel down will change the frequency by 0.1. Pressing and holding in AM/FM will seek channels.
Change Channel Up	Press to change channel up. Press and hold to seek channel up. While using AM/FM, pressing the channel up will change the frequency by 0.1. Pressing and holding in AM/FM will seek channels.
Menu	Press to access McIntosh settings.
About	Press to learn more about McIntosh.
Audio	Press to open the audio settings page of the Uconnect media player.

3RD PARTY APPS

If equipped, your vehicle may contain some 3rd party apps, which will further enhance your Uconnect system.

McIntosh

McIntosh is a 3rd party app that can enhance your Uconnect system’s media player. For the app to be effective, there must be audio playback in the Uconnect media player. McIntosh can control the playback of audio as well as display the output level decibel meters.

To launch the app, begin playing audio and follow these steps:

1. Press the Apps button.
2. Press the McIntosh app.

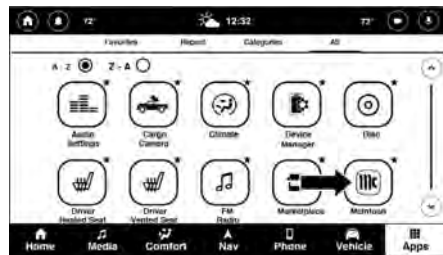
**McIntosh**

NOTE:

To change the source within the app, press the source name. Pressing this will open a menu with all available sources. To change the audio source outside of the app, press the Media button, and then press the Sources button.

To exit the app, press any of the buttons on the Bottom Menu Bar.

Day/Night Mode

Press the Menu button in the upper left-hand corner to access McIntosh settings. Tap on a Mode to set it as the default, or tap “Auto Mode” to enable your screen to automatically switch between Day and Night Modes.

Theater Mode

Press the Menu button in the upper left-hand corner to access McIntosh settings. Under the Theater Mode section, select “On” to bring forward the McIntosh meters. This will enlarge the meters for a more prominent view.

NOTE:

Theater Mode will engage after 10 seconds without input from the user.

For more information on McIntosh, the McIntosh app and its functionality, please visit <https://www.mcintoshlabs.com>.

REAR SEAT ENTERTAINMENT (RSE) WITH AMAZON FIRE TV BUILT-IN — IF EQUIPPED

OVERVIEW

Rear Seat Entertainment with Fire TV built-in is designed to give your family years of enjoyment.

Fire TV lets passengers enjoy a wide variety of content from popular apps (subscriptions may be required). Stream videos, play games, listen to music, get information, and watch downloaded programs all while on the road. Two Voice Remotes with Alexa are included with the system. Press the Microphone button on the Voice Remote with Alexa to easily find, launch, and control content. Check sports scores, play music, control smart home devices, or see your live camera feeds (compatible smart home device required and sold separately). In addition to streaming and downloaded content, changing the input in Fire TV also enables you to:

- Mirror what’s on your phone or tablet to Fire TV via Miracast capable devices
- Stream your favorite shows with Fire TV
- Plug and play a variety of standard video games or devices into the HDMI port
- Listen to audio over wired or wireless headphones (not included, customer will have to provide their own or play audio through in-cabin speakers with Listen In feature in front seat)
- Plug and play a variety of devices into the front seat Video USB port. USB ports located under the rear screens are charge only
- Watch content individually on each rear display or mirror across both displays to watch together

NOTE:

Vehicle must be in an active and usable cellular range and properly equipped with a Uconnect 5 NAV system and Rear Seat Entertainment with Fire TV package. Streaming requires a Wi-Fi connection and registered Amazon account to run Fire TV in the vehicle. Streaming service subscriptions are not included. Services and features are subject to change or withdrawal at any time, may not be available in all areas and languages, and may require separate subscriptions.

Please review this Owner’s Manual to become familiar with RSE features and operation.

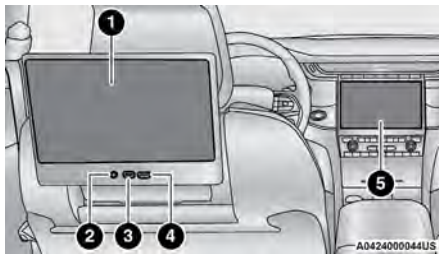
GETTING STARTED

Rear Screen Entertainment For Uconnect 5/5 NAV

- 1 — Rear Seat Entertainment (Rear Touchscreen)
- 2 — Headphone Jack
- 3 — USB C Charging Port
- 4 — HDMI Port
- 5 — Uconnect System (Front Touchscreen)

There are four different ways to operate the features of Rear Seat Entertainment with Fire TV built-in:

- Voice Remote with Alexa
- Front radio screen
- Passenger screen (if equipped)
- Individual rear touchscreens for Rear Seat Entertainment with Fire TV built-in touch on each rear screen

For information on the front media hub USB/AUX ports,  page 67.

ACCESSING REAR SEAT ENTERTAINMENT WITH FIRE TV BUILT-IN FROM THE FRONT RADIO SCREEN

You can access your Rear Seat Entertainment with Fire TV built-in system by following these steps:

Option 1

1. Press the Media button.
2. Press the Rear Seat button icon.

Option 2

1. Press the Apps button on the bottom of the touchscreen.
2. Press the Uconnect Theater button on the touchscreen. You may need to navigate to different pages in the Apps drawer to find the Uconnect Theater button.

ACCESSING REAR SEAT ENTERTAINMENT WITH FIRE TV BUILT-IN FROM THE REAR SCREENS

You can also access your Rear Seat Entertainment with Fire TV built-in by choosing one of the following options:

Option 1

- The system will automatically turn on when the vehicle is started. Pushing the power button on the Voice Remote with Alexa will turn the system back on if it was manually shut off. If the screen is inactive and goes to a screen saver, the system can be woken up by either tapping the screen or pushing any button on the Voice Remote with Alexa.

Option 2

- Swiping on either of the rear touchscreens.

NOTE:

When using the rear screens, the system will launch with Fire TV.

ACCESSING REAR SEAT ENTERTAINMENT WITH FIRE TV BUILT-IN FROM THE PASSENGER SCREEN — IF EQUIPPED

You can also access Rear Seat Entertainment with Fire TV built-in content from the Passenger Screen.

Follow these steps:

1. Access the Home screen for the Passenger Screen.
2. Swipe right on the Home screen and select Fire TV Rear Seat Entertainment Controls.

FIRST TIME STARTING UP (USING THE REAR SCREENS)

Boot-up Screen

When turning on the system for the first time from the rear screens, a boot-up screen will appear on the system displaying the Fire TV logo.

During this boot-up sequence, language options will be available for the system.

Voice Remote with Alexa Pairing

After the boot-up sequence is complete, the system will then give the option to pair a Voice Remote with Alexa (two are included with the system).

Follow the on-screen instructions for how to pair a Voice Remote with Alexa to the system. Two Voice Remotes with Alexa are included to be paired with each rear screen.

A Voice Remote with Alexa can be paired to each rear screen. It will function with the rear screen it was paired with. The pairing steps will need to be done for each rear screen.

NOTE:

If the Voice Remote with Alexa pairing fails, on-screen instructions will appear for trying to pair again.

Connecting to a Network

During the start-up process, the system will need to be connected to a network to function. Multiple network sources can be options for the system.

Some options for a network connection are:

- Wi-Fi Hotspot using a capable smartphone (if activated, it will show as a possible network for the system on the screen).
- Outside connection like a home Wi-Fi network.
- In-vehicle Wi-Fi.

NOTE:

When a network is connected to the system for the first time, an over-the-air-software update will take place using the Wi-Fi connection. It is recommended that an unlimited Wi-Fi connection, if available, be used during this update. After this first-time update, updates will only occur when one is available.

Account Sign-in

The next step will be the option to sign in to your Amazon account.

There are two options to sign into the system:

- **I already have an Amazon account:** Sign in with an already existing Amazon account
 - **I am new to Amazon:** Create a new Amazon Account
- If “I am new to Amazon” is selected, follow the on-screen steps to set up an Amazon account with the system.

Parental Controls

Another feature that will appear during this first time set up is parental controls.

When the parental controls page appears, it will give the options “Enable Parental Controls” and “No Parental Controls”. If “Enable Parental Controls” is selected, follow the on-screen steps to set up parental controls for the system.

ALEXA VOICE CONTROL

A feature with Rear Seat Entertainment with Fire TV built-in that enhances your experience is Alexa. It is simple to get started using this feature. Push the Microphone button at the top of the Voice Remote with Alexa to activate Alexa and get started.

LISTEN VIA VEHICLE SPEAKERS

A feature within Rear Seat Entertainment with Fire TV built-in is the front radio Listen feature. On the front radio Home screen for Fire TV, select the Listen button in the top right corner on either card for Screen 1 or 2. This will allow you to have either rear screen play audio through all the speakers in the vehicle.

QUICK MENU

Accessing the quick menu will give you more options for Fire TV.

To access the quick menu, tap the screen and it will appear. The quick menu is also accessible by pushing the Gear/Settings button on the Voice Remote with Alexa.

Some options of the quick menu are:

- **Power** — This will power the screen off.
- **On-Screen Remote** — This will bring up the on-screen remote to use with the system.
- **Back** — This will let you go back a page.
- **Home** — This will take you to the Home screen.
- **Gear/Settings** — This will let you access certain settings in the system. For more setting options, select “Settings” within the on-screen Gear/Settings menu.
- **Vehicle** — This will bring up the Vehicle menu. From here you can adjust rear climate controls and the Are We There Yet? app.

PARENTAL CONTROLS (USING THE REAR SCREENS)

If parental controls were not set during the first time start up of the system, they can be set by following these steps:

1. Push the Gear/Settings button on the Voice Remote with Alexa or tap the screen to access Settings in the “quick menu”.
2. Select the Gear/Settings icon on the screen.
3. Select “Settings” on the screen.
4. While in Settings, select “Preferences”.
5. Select “Parental Controls”; from here you can turn Parental Controls on or off and set up a PIN for the controls using the Voice Remote with Alexa.

VOICE REMOTE WITH ALEXA PAIRING (USING THE REAR SCREENS)

If the Voice Remote with Alexa needs to be paired again or a new remote is being paired, follow these procedures:

1. Install batteries into the remote.
2. Tap the screen and Select the Gear/Settings icon on the screen.
3. Select “Settings” on the screen.
4. In Settings, select “Controllers & Bluetooth® Devices”.
5. From this menu, select “Add New Remote”.
6. Follow the on-screen steps for Voice Remote with Alexa pairing.

A long press on the Home button can also re-pair a Voice Remote with Alexa that has become disconnected.

NOTE:

Your vehicle is included with two Voice Remotes with Alexa. A Voice Remote with Alexa can be paired to each rear screen. It will function with the rear screen it was paired with. The pairing steps will need to be done for each rear screen.

MEDIA SOURCES INPUT (USING THE FRONT RADIO AND REAR SCREENS)

Front Radio Screen

Users can select inputs for each rear screen from the front radio touchscreen by selecting the Rear Seat tab and choosing the desired content by selecting "Launch Source" on the Screen 1 or Screen 2 tab.

Inputs available within Launch Source under "Inputs" are "Fire TV", "HDMI", and "USB".

Rear Screens

To select inputs on the rear screen, scroll down on the Fire TV Home screen and select your desired input under "Input".

Inputs can also be selected from the Brand tab in the top menu. While in this tab, scroll down to "Inputs" for selection options.

NOTE:

The Brand tab naming in the top menu will depend on the naming of the vehicle's brand.

VOICE REMOTE WITH ALEXA

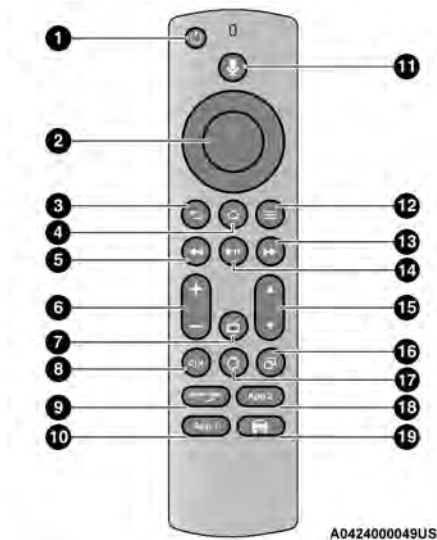

Voice Remote With Alexa

- 1. Power Button** – Turns the screen for the selected channel on or off.
- 2. 5-way Navigation Control** – This control has options by pressing the Circle button Up, Down, Left, or Right to navigate on-screen for selections and pushing the center button to confirm selections.

- 3. Back** – Push to exit out of menus or return to the previous screen.
- 4. Home** – Push to return to the Fire TV Home screen.
- 5. Seek Backward/Rewind Button** – Push and hold to fast rewind through the current audio track or video chapter. Push once to revert back to the previous track.
- 6. Volume** – Push the - button to decrease the volume and + button to increase the volume.
- 7. Channel Guide** – Push to access the channel guide for the system.
- 8. Mute** – Mutes headphone audio.
- 9. Prime Video** – Push to launch Prime Video app.
- 10. App 1** – Push to navigate to App 1.
- 11. Microphone Button** – Push to activate Alexa.
- 12. Menu** – Push to access the Fire TV menu.
- 13. Seek Forward Button** – Push and hold to fast forward through the current audio track or video chapter. Push once to skip to the next track.
- 14. Play/Pause Button ||** – Begin/resume or pause disc play.
- 15. Channel +/-** – Push the up or down arrow button on the Channel button to browse channels available in Fire TV.
- 16. Recent** – Push to access recently viewed content on Fire TV.
- 17. Gear/Settings** – Push to bring up setting options for Fire TV.
- 18. App 2** – Push to launch App 2.
- 19. Vehicle Button** – Push to activate the Vehicle menu.

REPLACING THE VOICE REMOTE WITH ALEXA BATTERIES

Each Voice Remote with Alexa requires two AAA batteries for operation.

To replace the batteries:

1. Locate the battery compartment on the back of the Voice Remote with Alexa, then slide the battery cover downward.
2. Remove the old batteries and follow battery recycling procedures for your area.
3. Install new batteries, making sure to orient them according to the polarity diagram shown inside the battery compartment.
4. Slide the battery compartment cover back on.

REAR SEAT ENTERTAINMENT WITH FIRE TV BUILT-IN STREAMING (USING THE FRONT RADIO AND REAR SCREENS)

Access Using Launch Source

To access Rear Seat Entertainment with Fire TV built-in from the front radio, press the Media tab located on the bottom menu bar. Then select the Rear Seat option located on the top menu bar. Select “Launch Source”, and then under “Inputs” select “Fire TV Home”.

Access Using Browse Media

Selecting “Browse Media” on the front radio screen will give access to different media within Rear Seat Entertainment with Fire TV built-in.

These options will be in the top menu of “Browse Media” and include:

- **Fire TV** — Selecting “Fire TV” will show streaming options for categories and to select apps. This option will be selectable on the left slider menu in “Browse Media”. While in “Browse Media” under Fire TV, it will display recent activity under “Recent”. This will display recent videos viewed from Fire TV and recent downloads as well.
- **USB Video** — Under “USB Videos”, videos will appear that are options with a USB device connected to Rear Seat Entertainment with Fire TV built-in.
- **USB Music** — Under “USB Music”, music will appear that are options with a USB device connected to Rear Seat Entertainment with Fire TV built-in.

Access Using the Voice Remote with Alexa and Rear Screens

Rear passengers will be able to access some options for streaming by pressing the “Prime Video”, “App 1”, or “App 2” button on the Voice Remote with Alexa. Selecting one of those buttons on the Voice Remote with Alexa will take you to the home page for that respective streaming service. Turning on either of the rear screens will launch Fire TV. By default, the rear screens will always launch in Fire TV. More streaming options can be selected on the Fire TV home page.

Fire TV

Fire TV is your source for online streaming with Rear Seat Entertainment with Fire TV built-in.

NOTE:

A data source needs to be connected to the system for streaming to be accessible. This can be set up when Fire TV is turned on for the first time from the rear screens. Some of these options can be an in-vehicle 4G Wi-Fi hot spot, capable Wi-Fi hot spot from a mobile device, or Wi-Fi from an outside source like a home or a garage.

To access Fire TV on the front screen, select “Launch Source” on the front radio rear seat screen and then “Fire TV Home” under the Inputs.

Viewing from the front radio screen or passenger screen mirrors or controls the Fire TV experience from one of the rear Fire TV displays.

The menu bar for Fire TV will have the options for “Home”, “Find”, “Library”, “Brand”, and “Live”.

Below the menu bar will be streaming options linked to your Prime account like “Prime Video”.

The front radio screen offers some options:

- **Power** — This will turn Fire TV on or off.
- **Screen 1 and Screen 2 Toggle** — This toggles between the Rear Screens (for use with front radio screen only).
- **Collapse** — While viewing on the front radio screen, this will collapse the screen to dashboard view.
- **Source Drawer** — This will open the “Source Drawer” and the source logo will be displayed on the icon.
- **Browse Media** — This will open the “Browse Media” pop-up.
- **Back** — This will let you go back the previous page.
- **Fire TV Home** — This will take you back to the Fire TV home page.
- **Menu** — This will open the Fire TV menu.
- **Remote icon** — This will display the on-screen remote.

NOTE:

Front radio screen mirroring and watching can only be done when the vehicle is in PARK. The vehicle must be in an active and usable cellular range and properly equipped with a Uconnect 5 NAV system and Rear Seat Entertainment with Fire TV package. For streaming, a Wi-Fi connection and registered Amazon account are required to run Fire TV in the vehicle. Streaming service subscriptions are not included. Services and features are subject to change or withdrawal at any time, may not be available in all areas and languages, and may require separate subscriptions.

FIRE TV APPS/GAMES (USING THE REAR SCREENS)

Apps and games can be accessed using Rear Seat Entertainment with Fire TV built-in.

To access Apps on the rear screen, turn on the system and select “Find” in the top menu. On the Find page, select “App Store®”. Within the App Store® you can purchase apps and games. From here you can also select from all the apps and games that have been purchased.

ARE WE THERE YET?

When a navigation route has been set from the Uconnect system, the second-row passengers can use “Are We There Yet?” for an animated screen showing distance and time remaining on navigation routes, as well as the estimated time of arrival with pop-up notifications.

Some screen information includes:

- Decrease Timing Between Notifications Button
- Notifications ON/OFF Button
- Increase Timing Between Notifications Button
- Arrival Time
- Time Remaining Until Destination Is Reached
- Distance Remaining

To access “Are We There Yet?” from the rear screens, follow these steps:

1. Tap one of the rear screens and select the Vehicle icon or push the Vehicle button on the Voice Remote with Alexa.
2. Select “Are We There Yet?” near the bottom of the menu on the first page of options.

USING THE VIDEO USB PORT

Plug in a USB drive or mass storage device and play your favorite music or movies.

NOTE:

To view USB media on the rear screens, insert a USB drive into the port. The USB drive port is located under the radio controls in the instrument panel.

On the rear screen you can browse the content of the USB device by going to the USB source in the inputs. Use the search feature to find your media faster.

PLAY VIDEO GAMES

Connect the video game console to either of the HDMI ports located behind either of the first row seats.

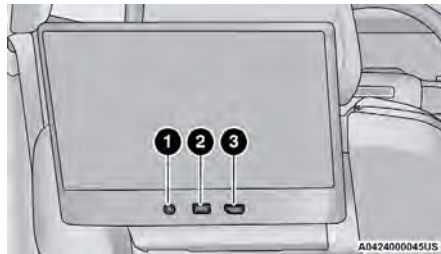

Headphone Jack/HDMI/USB

- 1 — Headphone Jack (Headphone Output Only)
- 2 — USB Port (Charge Only)
- 3 — HDMI Port

NOTE:

Certain high-end video games may exceed the power limit of the vehicle's Power Inverter → page 70.

HEADPHONES OPERATION

Rear Seat Entertainment with Fire TV built-in does not come equipped with headphones. Customers will need to provide their own wireless headphones that can be paired with the system using Bluetooth®. Customers can also use their own wired headphones and plug them into a Headphone Jack located under one of the rear screens.

Wireless Headphones Pairing

To pair wireless headphones with Rear Seat Entertainment with Fire TV built-in using the rear screens, follow these steps:

1. Push the Gear/Settings button on the Voice Remote with Alexa or tap the screen.
2. Select the Gear/Settings icon on the screen.
3. Select “Settings” on the screen.
4. While in Settings, select “Controllers & Bluetooth® Devices”.
5. Select “Other Bluetooth® Devices” and follow the on-screen steps for pairing.

While multiple headphones can be paired, only one will output audio at a time.





REAR CLIMATE CONTROLS

The Rear Climate Controls can also be controlled using Rear Seat Entertainment with Fire TV built-in [➔ page 57](#).

Rear Climate Controls can be accessed by using the Vehicle menu. Tap on either rear screen and select the Vehicle icon or press the Vehicle button on the Voice Remote with Alexa. Then select the Rear Climate Controls option.

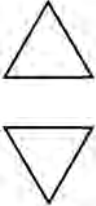
Options within Rear Climate Controls are:

Icon	Description
ON	Climate Control ON Button Press and release this button to turn the Rear Climate Controls on.
OFF	Climate Control OFF Button Press and release this button to turn the Rear Climate Controls off.
SYNC	SYNC Button Pressing this button will sync both sides of the Rear Climate Controls.
	AUTO Button Automatically controls the rear interior cabin temperature by adjusting airflow distribution and amount. Toggling this function will cause the system to switch between Manual mode and Automatic mode.

Icon	Description
	<p>Rear Passenger Temperature Up and Down Buttons Provides the rear passengers with independent temperature control. Press the button on the touchscreen to increase or decrease the temperature. The temperature will get warmer as you move up toward the red arrow and colder as you move down toward the blue arrow.</p>
<p>Headliner Mode</p> 	<p>Headliner Mode Air comes from the outlets in the headliner. Each of these outlets can be individually adjusted to direct the flow of air. Moving the air vanes of the outlets to one side will shut off the airflow.</p>
<p>Bi-Level Mode</p> 	<p>Bi-Level Mode Air comes from both the headliner outlets and the floor outlets.</p> <p>NOTE: In many temperature positions, the Bi-Level mode is designed to provide cooler air out of the headliner outlets and warmer air from the floor outlets.</p>
<p>Floor Mode</p> 	<p>Floor Mode Air comes from the floor outlets.</p>

Icon	Description
1,2,3, etc.	Blower Control Blower Control is used to regulate the amount of air forced through the Climate system. There are seven blower speeds available. Adjusting the blower will cause Automatic mode to switch to Manual operation.

LEGAL & COMPLIANCE

To access Legal and Compliance information about Rear Seat Entertainment with Fire TV built-in from the rear screens, follow these steps:

1. Push the Gear/Settings button on the Voice Remote with Alexa or tap the screen.
2. Select the Gear/Settings icon on the screen.
3. Select “Settings” on the screen.
4. While in the Settings menu, select “My Fire TV” and then “Legal & Compliance”.

OFF-ROAD PAGES — IF EQUIPPED

Your vehicle may be equipped with Off-Road Pages, which provides the vehicle status information while operating on off-road conditions. It supplies information relating to the vehicle ride height, the status of the transfer case, the pitch and roll of the vehicle, and the active Selec-Terrain Mode.

To access Off-Road Pages, press the Off Road button on the touchscreen from the Vehicle menu, and then press “Launch Off-Road”.

Off-Road Pages has the following selectable pages:

- Vehicle Dynamics
- Accessory Gauges
- Pitch & Roll
- Selec-Terrain — If Equipped
- Suspension — If Equipped
- Forward Facing Camera — If Equipped

NOTE:

With a Connected Services subscription (if equipped), you can record your Off-Road data and send it directly to the mobile app. Press the Record button to begin.

OFF-ROAD PAGES STATUS BAR

The Off-Road Pages Status Bar is located along the bottom of Off-Road Pages and is present on each of the selectable page options. It provides continually updating information for the following items:

- Current Transfer Case Status
- Current Selec-Terrain Mode
- Current Latitude/Longitude
- Current Altitude of the vehicle
- Status of Hill Descent Control or Selec-Speed Control Selected Speed in mph (km/h).
- Current Terrain Mode

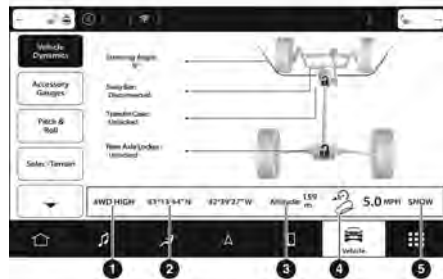

Status Bar

- 1 — Transfer Case Status
- 2 — Current Latitude/Longitude
- 3 — Current Altitude
- 4 — Hill Descent Control Or Selec-Speed Control
- 5 — Current Terrain Mode

VEHICLE DYNAMICS

The Vehicle Dynamics page displays information concerning the vehicle's drivetrain.

The following information is displayed:

- Steering angle in degrees
- Status of Transfer Case
- Status of the Rear Axle Locker – If Equipped
- Status of Sway Bar – If Equipped

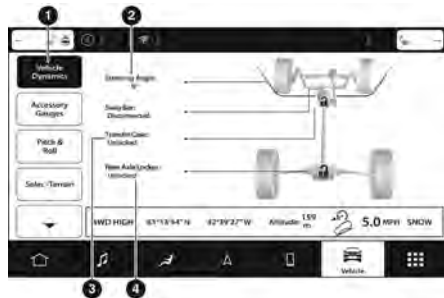

Vehicle Dynamics Menu

- 1 – Vehicle Dynamics
- 2 – Steering Angle
- 3 – Transfer Case Status
- 4 – Rear Axle Status

ACCESSORY GAUGES

The Accessory Gauges page displays the current status of the vehicle's Coolant Temperature, Oil Temperature, Oil Pressure, Transmission Temperature, and Battery Voltage.

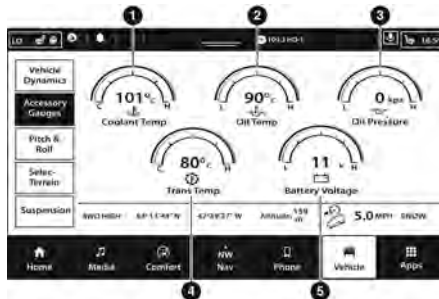

Accessory Gauges Menu

- 1 – Coolant Temperature
- 2 – Oil Temperature
- 3 – Oil Pressure
- 4 – Transmission Temperature
- 5 – Battery Voltage

PITCH & ROLL

The Pitch & Roll page displays the vehicle's current pitch (angle up and down) and roll (angle side to side) in degrees. The Pitch & Roll gauges provide a visualization of the current vehicle angle.



Pitch & Roll Menu

- 1 – Current Pitch
- 2 – Current Roll

SELEC-TERRAIN — IF EQUIPPED

The Selec-Terrain page displays the current Selec-Terrain Mode through a high resolution image. Adjusting the Selec-Terrain Mode will alter the image on the screen. The vehicle must be in the ON/RUN position to display Selec-Terrain information.

The selectable modes are as follows:

- Rock — Vehicle Must Be In 4WD Low
- Sand/Mud
- Snow
- Auto — Default
- Sport

NOTE:

The Off-Road Pages Status Bar will also display the current Selec-Terrain Mode.

SUSPENSION — IF EQUIPPED

The Suspension page displays information concerning the vehicle's suspension.

The following information is displayed:

- Wheel Articulation
- Current Ride Height Status
 - Off-Road 2
 - Off-Road 1
 - Normal
 - Aero
 - Entry/Exit

NOTE:

The wheel articulation will be represented by a yellow color in the Wheel Articulation. If Ride Height is adjusted, the Ride Height indicator on the screen will switch to the appropriate height and the Wheel Articulation will show the movement and change in height.

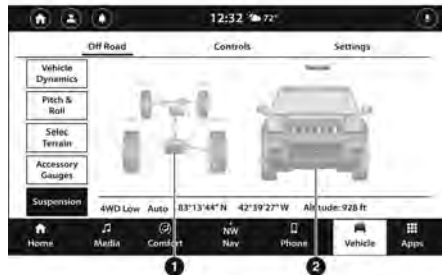

Suspension Menu

- 1 — Wheel Articulation
2 — Current Ride Height

RADIO OPERATION AND MOBILE PHONES

Under certain conditions, the mobile phone being on in your vehicle can cause erratic or noisy performance from your radio. This condition may be lessened or eliminated by repositioning the mobile phone within the vehicle. This condition is not harmful to the radio. If your radio performance does not satisfactorily improve from repositioning the mobile phone, it is recommended that the volume be turned down or off during mobile phone operation when not using the Uconnect system.

REGULATORY AND SAFETY INFORMATION

US/CANADA

Exposure to Radio Frequency Radiation

The radiated output power of the internal wireless radio is far below the FCC and IC radio frequency exposure limits. Nevertheless, the wireless radio will be used in such a manner that the radio is 8 inches (20 cm) or further from the human body.

The internal wireless radio operates within guidelines found in radio frequency safety standards and recommendations, which reflect the consensus of the scientific community.

The radio manufacturer believes the internal wireless radio is safe for use by consumers. The level of energy emitted is far less than the electromagnetic energy emitted by wireless devices such as mobile phones. However, the use of wireless radios may be restricted in some situations or environments, such as aboard airplanes. If you are unsure of restrictions, you are encouraged to ask for authorization before turning on the wireless radio → page 331.

SAFETY

SAFETY FEATURES

ANTI-LOCK BRAKE SYSTEM (ABS)

The ABS provides increased vehicle stability and brake performance under most braking conditions. The system automatically prevents wheel lock and enhances vehicle control during braking.

The ABS performs a self-check cycle to ensure that the ABS is working properly each time the vehicle is started and driven. During this self-check, you may hear a slight clicking sound as well as some related motor noises.

The ABS is activated during braking when the system detects one or more wheels are beginning to lock. Road conditions such as ice, snow, gravel, bumps, railroad tracks, loose debris, or panic stops may increase the likelihood of ABS activation(s).

You also may experience the following normal characteristics when the ABS activates:

- ABS motor noise or clicking sounds (you may continue to hear for a short time after the stop)
- Brake pedal pulsations
- A slight drop of the brake pedal at the end of the stop

The ABS is designed to function with the Original Equipment Manufacturer (OEM) tires. Modification may result in degraded ABS performance.

WARNING!

- The ABS contains sophisticated electronic equipment that may be susceptible to interference caused by improperly installed or high output radio transmitting equipment. This interference can cause possible loss of anti-lock braking capability. Installation of such equipment should be performed by qualified professionals.
- Pumping of the Anti-Lock Brakes will diminish their effectiveness and may lead to a collision. Pumping makes the stopping distance longer. Just press firmly on your brake pedal when you need to slow down or stop.
- The ABS cannot prevent the natural laws of physics from acting on the vehicle, nor can it increase braking or steering efficiency beyond that afforded by the condition of the vehicle brakes and tires or the traction afforded.
- The ABS cannot prevent collisions, including those resulting from excessive speed in turns, following another vehicle too closely, or hydroplaning.
- The capabilities of an ABS equipped vehicle must never be exploited in a reckless or dangerous manner that could jeopardize the user's safety or the safety of others.

Anti-Lock Brake System (ABS) Warning Light

The yellow ABS Warning Light will turn on when the ignition is placed in the ON/RUN mode and may stay on for as long as four seconds.

If the ABS Warning Light remains on or comes on while driving, it indicates that the anti-lock portion of the brake system is not functioning and that service is required. However, the conventional brake system will continue to operate normally if the ABS Warning Light is on.

If the ABS Warning Light is on, the brake system should be serviced as soon as possible to restore the benefits of Anti-Lock Brakes. If the ABS Warning Light does not come on when the ignition is placed in the ON/RUN mode, have the light repaired as soon as possible.

DROWSY DRIVER DETECTION (DDD) — IF EQUIPPED

DDD detects when the driver is feeling fatigued and warns the driver to pull over and take a break.

To Activate/Deactivate

DDD can be activated and deactivated through the Uconnect system by selecting the following in order:

1. "Safety & Driving Assistance"
2. "Drowsy Driver Detection"

WARNING!

The DDD system is an aid for driving and does not relieve the driver of the responsibility of driving the vehicle. Always drive alert and get plenty of rest before driving. If you experience fatigue while driving, do not wait for the DDD to intervene with a warning. Choose a safe and secure location where you can pull over safely for a break. Only return to the road when you are in the right physical and mental condition to prevent endangering yourself and others.

System Operation

Using feedback obtained from the driver's steering patterns, any buttons/switches that are pressed, and from the front camera, the system implements two operating logics:

- The first operating logic takes the driving style into account, observing the road and detecting to what extent the driver can continue driving with few lane crossing events.
- The second operating logic measures the time spent behind the wheel with the vehicle speed above 40 mph (60 km/h) and below 100 mph (160 km/h).

If the driving style indicates that the driver is unable to follow the road trajectory and respect the horizontal lane markings while within the operating speed range of the system, a pop up will display on the instrument cluster display to suggest that the driver should stop for a break. An audible signal will also sound.

If the driver **accepts** the suggestion provided by the system by pushing the "OK" button on the left side of the steering wheel, the message will disappear from the display.

If the driver **does not acknowledge** the warning, it will be displayed for 60 seconds and then disappear.

NOTE:

In the event of a DDD system failure, a dedicated message will appear in the instrument cluster display.

**DDD Warning Message****REAR SEAT REMINDER ALERT (RSRA)**

RSRA alerts of the possible presence of an object, passenger, or pet in the rear seats through a visual and auditory notification. When the system is activated, it displays the message "Check Rear Seat" on the instrument cluster display and sounds an auditory alert upon the driver placing the ignition in the OFF position to exit the vehicle. The system will activate automatically if a rear door is opened within 10 minutes of the ignition being placed in the ON/RUN position. RSRA should be used as a reminder to check the rear seats, it does not directly detect objects, passengers, or pets and is only activated when the previous conditions are met.

To enable or disable RSRA, see ⇨ page 169.

WARNING!

- Before exiting a vehicle, always come to a complete stop, then shift the automatic transmission into PARK and apply the parking brake.
- Always make sure the keyless ignition node is in the OFF position, key fob is removed from the vehicle and vehicle is locked.
- Never leave children alone in a vehicle, or with access to an unlocked vehicle. Leaving children in a vehicle unattended is dangerous for a number of reasons. A child or others could be seriously or fatally injured. Children should be warned not to touch the parking brake, brake pedal or the gear selector.
- Do not leave children or animals inside parked vehicles in hot weather. Interior heat buildup may cause serious injury or death.

ELECTRONIC BRAKE CONTROL (EBC) SYSTEM

If applicable, refer to the "Hybrid Supplement" for additional information.

Your vehicle is equipped with an advanced EBC system. This system includes the Anti-Lock Brake System (ABS), Brake Assist System (BAS), Electronic Brake Force Distribution (EBD), Electronic Roll Mitigation (ERM), Electronic Stability Control (ESC), Hill Start Assist (HSA), and Traction Control System (TCS). These systems work together to enhance both vehicle stability and control in various driving conditions.

Your vehicle may also be equipped with Dynamic Steering Torque (DST), Rain Brake Support (RBS), Ready Alert Braking (RAB), and Trailer Sway Control (TSC).

Brake Assist System (BAS)

The BAS is designed to optimize the vehicle's braking capability during emergency braking maneuvers. The system detects an emergency braking situation by sensing the rate and amount of brake application and then applies optimum pressure to the brakes. This can help reduce braking distances. The BAS complements the Anti-Lock Brake System (ABS). Applying the brakes very quickly results in the best BAS assistance. To receive the benefit of the system, you must apply continuous braking pressure during the stopping sequence (do not "pump" the brakes). Do not reduce brake pedal pressure unless braking is no longer desired. Once the brake pedal is released, the BAS is deactivated.

WARNING!

The Brake Assist System (BAS) cannot prevent the natural laws of physics from acting on the vehicle, nor can it increase the traction afforded by prevailing road conditions. BAS cannot prevent collisions, including those resulting from excessive speed in turns, driving on very slippery surfaces, or hydroplaning. The capabilities of a BAS-equipped vehicle must never be exploited in a reckless or dangerous manner, which could jeopardize the user's safety or the safety of others.

Brake System Warning Light

The red Brake System Warning Light will turn on when the ignition is placed in the ON/RUN mode and may stay on for as long as four seconds.

If the Brake System Warning Light remains on or comes on while driving, it indicates that the brake system is not functioning properly and that immediate service is required. If the Brake System Warning Light does not come on when the ignition is placed in the ON/RUN mode, have the light repaired as soon as possible.

Electronic Brake Force Distribution (EBD)

EBD manages the distribution of the braking torque between the front and rear axles by limiting braking pressure to the rear axle. This is done to prevent over-slip of the rear wheels to avoid vehicle instability, and to prevent the rear axle from entering ABS before the front axle.

Electronic Roll Mitigation (ERM)

ERM anticipates the potential for wheel lift by monitoring the driver's steering wheel input and the speed of the vehicle. When ERM determines that the rate of change of the steering wheel angle and vehicle's speed are sufficient to potentially cause wheel lift, it then applies the appropriate brake and may also reduce engine power to lessen the chance that wheel lift will occur. ERM can only reduce the chance of wheel lift occurring during severe or evasive driving maneuvers; it cannot prevent wheel lift due to other factors, such as road conditions, leaving the roadway, or striking objects or other vehicles.

NOTE:

ERM is disabled any time the ESC is in "Full Off" mode (if equipped). See  page 207 for a complete explanation of the available ESC modes.

WARNING!

Many factors, such as vehicle loading, road conditions and driving conditions, influence the chance that wheel lift or rollover may occur. ERM cannot prevent all wheel lift or rollovers, especially those that involve leaving the roadway or striking objects or other vehicles. The capabilities of an ERM-equipped vehicle must never be exploited in a reckless or dangerous manner which could jeopardize the user's safety or the safety of others.

Electronic Stability Control (ESC)

ESC enhances directional control and stability of the vehicle under various driving conditions. ESC corrects for oversteering or understeering of the vehicle by applying the brake of the appropriate wheel(s) to assist in counteracting the following conditions. Engine power may also be reduced to help the vehicle maintain the desired path.

- Oversteer — when the vehicle is turning more than appropriate for the steering wheel position.
- Understeer — when the vehicle is turning less than appropriate for the steering wheel position.

ESC uses sensors in the vehicle to determine the vehicle path intended by the driver and compares it to the actual path of the vehicle. When the actual path does not match the intended path, ESC applies the brake of the appropriate wheel to assist in counteracting the oversteer or understeer condition.

The ESC Activation/Malfunction Indicator Light located in the instrument cluster will start to flash as soon as the ESC system becomes active. The ESC Activation/Malfunction Indicator Light also flashes when the Traction Control System (TCS) is active. If the ESC Activation/Malfunction Indicator Light begins to flash during acceleration, ease up on the accelerator and apply as little throttle as possible. Be sure to adapt your speed and driving to the prevailing road conditions.

WARNING!

- Electronic Stability Control (ESC) cannot prevent the natural laws of physics from acting on the vehicle, nor can it increase the traction afforded by prevailing road conditions. ESC cannot prevent accidents, including those resulting from excessive speed in turns, driving on very slippery surfaces, or hydroplaning. ESC also cannot prevent accidents resulting from loss of vehicle control due to inappropriate driver input for the conditions. Only a safe, attentive, and skillful driver can prevent accidents. The capabilities of an ESC equipped vehicle must never be exploited in a reckless or dangerous manner which could jeopardize the user's safety or the safety of others.
- Vehicle modifications, or failure to properly maintain your vehicle, may change the handling characteristics of your vehicle, and may negatively affect the performance of the ESC system. Changes to the steering system, suspension, braking system, tire type and size or wheel size may adversely affect ESC performance. Improperly inflated and unevenly worn tires may also degrade ESC performance. Any vehicle modification or poor vehicle maintenance that reduces the effectiveness of the ESC system can increase the risk of loss of vehicle control, vehicle rollover, personal injury and death.

ESC Operating Modes

Depending upon model and mode of operation, the ESC system may have multiple operating modes.

ESC On

This is the normal operating mode for the ESC. Whenever the vehicle is started, the ESC system will be in this mode. This mode should be used for most driving conditions. Alternate ESC modes should only be used for specific reasons as noted in the following paragraphs.

Partial Off

This mode may be useful if the vehicle becomes stuck. This mode may modify TCS and ESC thresholds for activation, which allows for more wheel spin than normally allowed.

To enter the "Partial Off" mode, momentarily push the ESC OFF button and the ESC OFF Indicator Light will illuminate. To turn the ESC on again, momentarily push the ESC OFF button and the ESC OFF Indicator Light will turn off.

NOTE:

For vehicles with multiple partial ESC modes, the push and release of the button will toggle the ESC modes. Multiple attempts may be required to return to "ESC On" mode.

WARNING!

- When in "Partial Off" mode, the TCS functionality of ESC (except for the limited slip feature described in the TCS section) has been disabled and the ESC OFF Indicator Light will be illuminated. When in "Partial Off" mode, the engine power reduction feature of TCS is disabled, and the enhanced vehicle stability offered by the ESC system is reduced.
- Trailer Sway Control (TSC) is disabled when the ESC system is in the "Partial Off" mode.

ESC Activation/Malfunction Indicator Light And ESC OFF Indicator Light



The ESC Activation/Malfunction Indicator Light in the instrument cluster will come on when the ignition is placed in the ON/RUN mode. It should go out with the engine running. If the ESC Activation/Malfunction Indicator Light comes on continuously with the engine running, a malfunction has been detected in the ESC system. If this light remains on after several ignition cycles, and the vehicle has been driven several miles (kilometers) at speeds greater than 30 mph (48 km/h), see an authorized dealer as soon as possible to have the problem diagnosed and corrected.

The ESC Activation/Malfunction Indicator Light starts to flash as soon as the tires lose traction and the ESC system becomes active. The ESC Activation/Malfunction Indicator Light also flashes when TCS is active. If the ESC Activation/Malfunction Indicator Light begins to flash during acceleration, ease up on the accelerator

and apply as little throttle as possible. Be sure to adapt your speed and driving to the prevailing road conditions.



The ESC OFF Indicator Light indicates the customer has elected to have the Electronic Stability Control (ESC) in a reduced mode.

NOTE:

- The ESC Activation/Malfunction Indicator Light and the ESC OFF Indicator Light come on momentarily each time the ignition is placed in the ON/RUN mode.
- Each time the ignition is placed in the ON/RUN mode, the ESC system will be on even if it was turned off previously.
- The ESC system will make buzzing or clicking sounds when it is active. This is normal; the sounds will stop when ESC becomes inactive following the maneuver that caused the ESC activation.

Hill Descent Control (HDC) — If Equipped



HDC is intended for low speed off-road driving while in 4WD Low. HDC maintains vehicle speed while descending hills during various driving situations. HDC controls vehicle speed by actively controlling the brakes.

HDC Has Three States:

1. Off (feature is not enabled and will not activate).
2. Enabled (feature is enabled and ready but activation conditions are not met, or driver is actively overriding with brake or throttle application).
3. Active (feature is enabled and actively controlling vehicle speed).

Enabling HDC

HDC is enabled by pushing the HDC switch, but the following conditions must also be met to enable HDC:

- The driveline is in 4WD Low.
- The vehicle speed is below 5 mph (8 km/h).
- The parking brake is released.
- The driver door is closed.

Activating HDC

Once HDC is enabled it will activate automatically if driven down a grade of sufficient magnitude. The set speed for HDC is selectable by the driver, and can be adjusted by using the gear shift +/- . The following summarizes the HDC set speeds:

HDC Target Set Speeds

- P = No set speed. HDC may be enabled but will not activate.
- R = 0.6 mph (1 km/h)
- N = 1.2 mph (2 km/h)
- D = 0.6 mph (1 km/h)
- 1st = 0.6 mph (1 km/h)
- 2nd = 1.2 mph (2 km/h)
- 3rd = 1.8 mph (3 km/h)
- 4th = 2.5 mph (4 km/h)
- 5th = 3.1 mph (5 km/h)
- 6th = 3.7 mph (6 km/h)
- 7th = 4.3 mph (7 km/h)
- 8th = 5.0 mph (8 km/h)

NOTE:

During HDC the +/- shifter input is used for HDC target speed selection, but will not affect the gear chosen by the transmission. When actively controlling HDC the transmission will shift appropriately for the driver-selected set speed and corresponding driving conditions.

Driver Override

The driver may override HDC activation with throttle or brake application at any time.

Deactivating HDC

HDC will be deactivated but remain available if any of the following conditions occur:

- The driver overrides HDC set speed with throttle or brake application.
- The vehicle speed exceeds 20 mph (32 km/h) but remains below 40 mph (64 km/h).
- The vehicle is on a downhill grade of insufficient magnitude, is on level ground, or is on an uphill grade.
- The vehicle is shifted to PARK.

Disabling HDC

HDC will be deactivated and disabled if any of the following conditions occur:

- The driver pushes the HDC switch.
- The driveline is shifted out of 4WD Low.
- The parking brake is applied.
- The driver door opens.
- The vehicle is driven greater than 20 mph (32 km/h) for greater than 70 seconds.
- The vehicle is driven greater than 40 mph (64 km/h) (HDC exits immediately).
- HDC detects excessive brake temperature.

Feedback To The Driver

The instrument cluster has an HDC icon and the HDC switch has an LED icon, which offers feedback to the driver about the state HDC is in.

- The cluster icon and switch light will illuminate and remain on solid when HDC is enabled or activated. This is the normal operating condition for HDC.
- The cluster icon and switch light will flash for several seconds, then extinguish when the driver pushes the HDC switch but enable conditions are not met.
- The cluster icon and switch light will flash for several seconds, then extinguish when HDC disables due to excess speed.
- The cluster icon and switch light will flash when HDC deactivates due to overheated brakes. The flashing will stop and HDC will activate again once the brakes have cooled sufficiently.

WARNING!

HDC is only intended to assist the driver in controlling vehicle speed when descending hills. The driver must remain attentive to the driving conditions and is responsible for maintaining a safe vehicle speed.

Hill Start Assist (HSA)

HSA is designed to mitigate roll back from a complete stop while on an incline. If the driver releases the brake while stopped on an incline, HSA will continue to hold the brake pressure for a short period. If the driver does not apply the throttle before this time expires, the system will release brake pressure and the vehicle will roll down the hill as normal.

The following conditions must be met in order for HSA to activate:

- The feature must be enabled.
- The vehicle must be stopped.
- The parking brake must be off.
- The driver door must be closed.
- The vehicle must be on a sufficient grade.
- The gear selection must match vehicle uphill direction (i.e., vehicle facing uphill is in forward gear; vehicle backing uphill is in REVERSE (R) gear).
- HSA will work in REVERSE gear and all forward gears. The system will not activate if the transmission is in PARK (P) or NEUTRAL (N). For vehicles equipped with a manual transmission, if the clutch is pressed, HSA will remain active.

WARNING!

There may be situations where the Hill Start Assist (HSA) will not activate and slight rolling may occur, such as on minor hills or with a loaded vehicle, or while pulling a trailer. HSA is not a substitute for active driving involvement. It is always the driver's responsibility to be attentive to distance to other vehicles, people, and objects, and most importantly brake operation to ensure safe operation of the vehicle under all road conditions. Your complete attention is always required while driving to maintain safe control of your vehicle. Failure to follow these warnings can result in a collision or serious personal injury.

Disabling And Enabling HSA

This feature can be turned on or turned off. To change the current setting, proceed as follows:

- If disabling HSA using your instrument cluster display, see [↔ page 85](#) for further information.
- If disabling HSA using Uconnect Settings, see [↔ page 169](#) for further information.

Towing With HSA

HSA will also provide assistance to mitigate roll back while towing a trailer.

WARNING!

- If you use a trailer brake controller with your trailer, the trailer brakes may be activated and deactivated with the brake switch. If so, there may not be enough brake pressure to hold both the vehicle and the trailer on a hill when the brake pedal is released. In order to avoid rolling down an incline while resuming acceleration, manually activate the trailer brake or apply more vehicle brake pressure prior to releasing the brake pedal.
- HSA is not a parking brake. Always apply the parking brake fully when exiting your vehicle. Also, be certain to place the transmission in PARK.
- Failure to follow these warnings can result in a collision or serious personal injury.

Rain Brake Support (RBS)

RBS may improve braking performance in wet conditions. It will periodically apply a small amount of brake pressure to remove any water buildup on the front brake rotors. It functions when the windshield wipers are in LO or HI speed. When RBS is active, there is no notification to the driver and no driver interaction is required.

Ready Alert Braking (RAB)

RAB may reduce the time required to reach full braking during emergency braking situations. It anticipates when an emergency braking situation may occur by monitoring how fast the throttle is released by the driver. The Electronic Brake Controller (EBC) will prepare the brake system for a panic stop.

Selec-Speed Control (SSC) — If Equipped



SSC is intended for off-road driving in 4WD Low only. SSC maintains vehicle speed by actively controlling engine torque and brakes.

SSC has three states:

1. Off (feature is not enabled and will not activate)
2. Enabled (feature is enabled and ready but activation conditions are not met, or driver is actively overriding with brake or throttle application)
3. Active (feature is enabled and actively controlling vehicle speed)

Enabling SSC

SSC is enabled by pushing the SSC switch, but the following conditions must also be met to enable SSC:

- The driveline is in 4WD Low.
- The vehicle speed is below 5 mph (8 km/h).

- The parking brake is released.
- The driver door is closed.
- The driver is not applying throttle.

Activating SSC

Once SSC is enabled it will activate automatically once the following conditions are met:

- The driver releases the throttle.
- The driver releases the brake.
- The transmission is in any selection other than PARK.
- The vehicle speed is below 20 mph (32 km/h).

The set speed for SSC is selectable by the driver, and can be adjusted by using the gear shift +/- . Additionally, the SSC set speed may be reduced when climbing a grade and the level of set speed reduction depends on the magnitude of grade. The following summarizes the SSC set speeds:

SSC Target Set Speeds

- 1st = .6 mph (1 km/h)
- 2nd = 1.2 mph (2 km/h)
- 3rd = 1.8 mph (3 km/h)
- 4th = 2.5 mph (4 km/h)
- 5th = 3.1 mph (5 km/h)
- 6th = 3.7 mph (6 km/h)
- 7th = 4.3 mph (7 km/h)
- 8th = 5 mph (8 km/h)
- 9th = 5.6 mph (9 km/h) – if equipped
- REVERSE = .6 mph (1 km/h)
- NEUTRAL = 1.2 mph (2 km/h)
- PARK = SSC remains enabled but not active

NOTE:

- During SSC the +/- shifter input is used for SSC target speed selection but will not affect the gear chosen by the transmission. While actively controlling SSC the transmission will shift appropriately for the driver-selected set speed and corresponding driving conditions.
- SSC operation is influenced by Off Road+ drive mode if active. The differences may be notable to the driver as a varying level of aggressiveness.

Driver Override:

The driver may override SSC activation with throttle or brake application at any time.

Deactivating SSC

SSC will be deactivated but remain available if any of the following conditions occur:

- Driver overrides SSC set speed with throttle or brake application
- Vehicle speed exceeds 20 mph (32 km/h) but remains below 40 mph (64 km/h)
- Vehicle is shifted to PARK

Disabling SSC

SSC will deactivate and be disabled if any of the following conditions occur:

- The driver pushes the SSC switch.
- The driveline is shifted out of 4WD Low.
- The parking brake is applied.
- The driver door opens.
- The vehicle is driven greater than 20 mph (32 km/h) for greater than 70 seconds.
- The vehicle is driven greater than 40 mph (64 km/h) (SSC exits immediately).

Feedback To The Driver:

The instrument cluster has an SSC icon and the SSC switch has an LED which offer feedback to the driver about the state SSC is in.

- The cluster icon and switch light will illuminate and remain on solid when SSC is enabled or activated. This is the normal operating condition for SSC.
- The cluster icon and switch light will flash for several seconds then extinguish when the driver pushes the SSC switch but enable conditions are not met.
- The cluster icon and switch light will flash for several seconds then extinguish when SSC disables due to excess speed.
- The cluster icon and switch light will flash then extinguish when SSC deactivates due to overheated brakes.

WARNING!

SSC is only intended to assist the driver in controlling vehicle speed when driving in off road conditions. The driver must remain attentive to the driving conditions and is responsible for maintaining a safe vehicle speed.

Traction Control System (TCS)

The TCS monitors the amount of wheel spin of each of the driven wheels. If wheel spin is detected, the TCS may apply brake pressure to the spinning wheel(s) and/or reduce engine power to provide enhanced acceleration and stability. A feature of the TCS, Brake Limited Differential (BLD) functions similarly to a limited slip differential and controls the wheel spin across a driven axle. If one wheel on a driven axle is spinning faster than the other, the system will apply the brake of the spinning wheel. This will allow more engine power to be applied to the wheel that is not spinning. BLD may remain enabled even if TCS and Electronic Stability Control (ESC) are in reduced modes.

Trailer Sway Control (TSC)

TSC uses sensors in the vehicle to recognize an excessively swaying trailer and will take the appropriate actions to attempt to stop the sway. TSC will become active automatically once an excessively swaying trailer is recognized.

NOTE:

TSC cannot stop all trailers from swaying. Always use caution when towing a trailer and follow the trailer tongue weight recommendations ↗ page 156.

When TSC is functioning, the ESC Activation/ Malfunction Indicator Light will flash, the engine power may be reduced and you may feel the brakes being applied to individual wheels to attempt to stop the trailer from swaying. TSC is disabled when the ESC system is in the "Partial Off" mode.

WARNING!

If TSC activates while driving, slow the vehicle down, stop at the nearest safe location, and adjust the trailer load to eliminate trailer sway.

AUXILIARY DRIVING SYSTEMS**BLIND SPOT MONITORING (BSM)**

BSM system uses two radar sensors, located inside the rear fascia/bumper, to detect highway licensable vehicles (automobiles, trucks, motorcycles, etc.) that enter the blind spot zones from the rear/front/side of the vehicle.

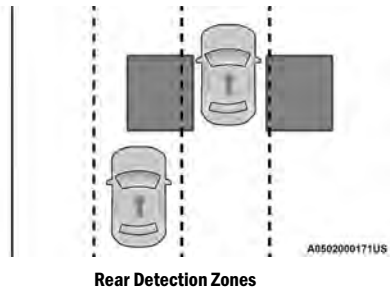

When the vehicle is started, the BSM Warning Light will momentarily illuminate in both outside rearview mirrors to let the driver know that the system is operational. The BSM system sensors operate when the vehicle is in any forward gear.

The BSM detection zone covers approximately one lane in width on both sides of the vehicle 12 ft (3.8 m). The zone length starts at the side of the vehicle, near the B-pillar, and extends approximately 10 ft (3 m) beyond the rear fascia/bumper of the vehicle. The BSM system monitors the detection zones on both sides of the vehicle when the vehicle speed reaches approximately 6 mph (10 km/h) or higher and will alert the driver of vehicles in these areas. BSM will alert earlier on faster-approaching vehicles — up to 33 mph (54 km/h) difference.

NOTE:

The BSM system detection zone DOES NOT change if your vehicle is towing a trailer. Therefore, visually verify the adjacent lane is clear for both your vehicle and trailer before making a lane change. If the trailer or other object (i.e., bicycle, sports equipment) extends beyond the side of your vehicle, this may result in random false detections on the trailer, and false chimes when the turn signal is used ↪ page 169.

The BSM system can become blocked if snow, ice, mud, or other road contaminations accumulate on the rear fascia/bumper where the radar sensors are located. The system may also detect blockage if the vehicle is operated in areas with extremely low radar returns such as a desert or parallel to a large elevation drop. If blockage is detected, a "Blind Spot Temporarily Unavailable, Sensor Blocked" message will display in the cluster, both mirror lights will illuminate, and BSM and RCP alerts will not occur. This is normal operation. The system will automatically recover and resume function when the condition clears or when an ignition cycle occurs. To minimize system blockage, do not block the area of the rear fascia/bumper where the radar sensors are located with foreign objects (bumper stickers, bicycle racks, etc.), and keep it clear of road contaminations.



A0503000830US

Sensor Location (Left Side Shown)

The BSM system notifies the driver of objects in the detection zones by illuminating the BSM Warning Light located in the outside mirrors. In addition, when the turn signal is activated during the alert on the side of the vehicle corresponding to the alert, an audible (chime) alert can be heard. During this audible (chime) alert, the radio volume will be reduced ↪ page 215.



A0503000834US

BSM Warning Light

The BSM system monitors the detection zone from three different entry points (Side, Rear, Front) while driving to see if an alert is necessary. The BSM system will issue an alert during these types of zone entries.

Entering From The Side

Vehicles that move into your adjacent lanes from either side of the vehicle.

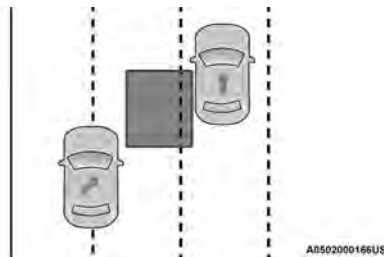

A0502000166US

Side Monitoring

Entering From The Rear

Vehicles that come up from behind your vehicle on either side and enter the rear detection zone with a relative speed of less than 33 mph (54 km/h). Fast approaching vehicles will receive an earlier alert based on relative speed.

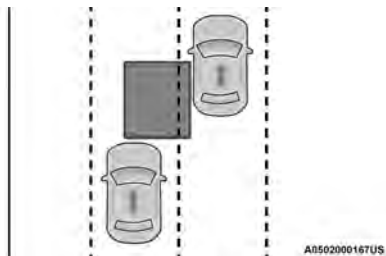

Rear Monitoring

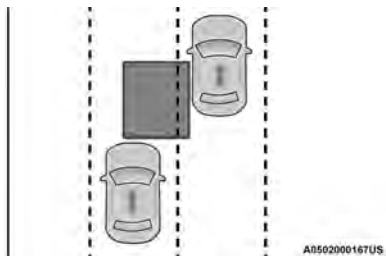

Overtaking/Passing

Overtaking Traffic

If you pass another vehicle slowly with a relative speed of less than 15 mph (24 km/h) the warning light will be illuminated. If the difference in speed between the two vehicles is greater than 15 mph (24 km/h), the warning light will not illuminate.

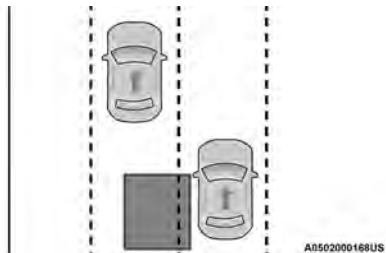

Overtaking/Approaching

The BSM system is designed not to issue an alert on stationary objects such as guardrails, posts, walls, foliage, berms, etc. However, occasionally the system may alert on such objects. This is normal operation and your vehicle does not require service.

The BSM system will not alert you of objects that are traveling in the opposite direction of the vehicle in adjacent lanes ⇐ page 331.

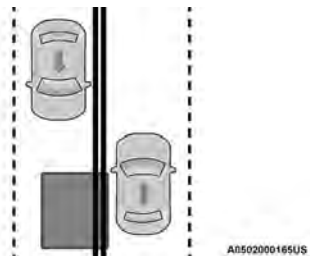

Opposing Traffic

WARNING!
<p>The Blind Spot Monitoring system is only an aid to help detect objects in the blind spot zones. The BSM system is not designed to detect pedestrians, bicyclists, or animals. Even if your vehicle is equipped with the BSM system, always check your vehicle's mirrors, glance over your shoulder, and use your turn signal before changing lanes. Failure to do so can result in serious injury or death.</p>

Rear Cross Path (RCP)

RCP is intended to aid the driver when backing out of parking spaces where their vision of oncoming vehicles may be blocked. Proceed slowly and cautiously out of the parking space until the rear end of the vehicle is exposed. The RCP system will then have a clear view of the cross traffic and if an oncoming vehicle is detected, alert the driver.

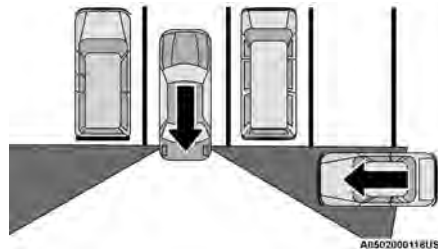

RCP Detection Zones

RCP monitors the rear detection zones on both sides of the vehicle, for objects that are moving toward the side of the vehicle with a minimum speed of approximately 5 mph (8 km/h), to objects moving a maximum of approximately 20 mph (32 km/h), such as in parking lot situations.

NOTE:

In a parking lot situation, oncoming vehicles can be obscured by vehicles parked on either side. If the sensors are blocked by other structures or vehicles, the system will not be able to alert the driver.

When RCP is on (Blind Spot Lights Only or Blind Spot Lights/Chimes) and the vehicle is in REVERSE, the driver is alerted using both the visual and audible alarms, including reducing the radio volume.

WARNING!

Rear Cross Path (RCP) Detection is not a back up aid system. It is intended to be used to help a driver detect a vehicle in a parking lot situation. Drivers must be careful when backing up, even when using RCP. Always check carefully behind your vehicle, look behind you, and be sure to check for pedestrians, animals, other vehicles, obstructions, and blind spots before backing up. Failure to do so can result in serious injury or death.

Blind Spot Modes

Three selectable modes of operation are available in the Uconnect system → page 169.

Blind Spot Alert Lights Only

When operating in Blind Spot Alert mode, the BSM system will provide a visual alert in the appropriate side view mirror based on a detected object. However, when the system is operating in Rear Cross Path (RCP) mode, the system will respond with both visual and audible alerts when a detected object is present. Whenever an audible alert is requested, the radio is muted.

Blind Spot Alert Lights/Chime

When operating in Blind Spot Alert Lights/Chime mode, the BSM system will provide a visual alert in the appropriate side view mirror based on a detected object. If the turn signal is then activated, and it corresponds to an alert present on that side of the vehicle, an audible chime will also be sounded. Whenever a turn signal and detected object are present on the same side at the same time, both the visual and audible alerts will be issued. In addition to the audible alert the radio (if on) will also be muted.

NOTE:

Whenever an audible alert is requested by the BSM system, the radio is also muted.

When the system is in RCP, the system shall respond with both visual and audible alerts when a detected object is present. Whenever an audible alert is requested, the radio is also muted. Turn/hazard signal status is ignored; the RCP state always requests the chime.

Blind Spot Alert Off

When the BSM system is turned off, there will be no visual or audible alerts from either the BSM or RCP systems.

NOTE:

The BSM system will store the current operating mode when the vehicle is shut off. Each time the vehicle is started, the previously stored mode will be recalled and used.

FORWARD COLLISION WARNING (FCW) WITH MITIGATION

The FCW with Mitigation system provides the driver with audible warnings, visual warnings (within the instrument cluster display), and may apply a limited braking to warn the driver when it detects a potential frontal collision. The warnings and limited braking are intended to provide the driver with enough time to react, avoid or mitigate the potential collision.

NOTE:

If either FCW or Pedestrian Emergency Braking (PEB) is turned off, the FCW OFF Indicator Light will illuminate. The FCW OFF Indicator Light will only shut off if both features are turned on and active braking is enabled.

NOTE:

FCW monitors the information from the forward looking sensors as well as the Electronic Brake Controller (EBC), to calculate the probability of a forward collision. When the system determines that a forward collision is probable, the driver will be provided with audible and visual warnings and may provide a brake jerk warning. If the driver does not take action based upon these progressive warnings, then the system will provide a limited level of active braking to help slow the vehicle and mitigate the potential forward collision. If the driver reacts to the warnings by braking and the system determines that the driver intends to avoid the collision by braking but has not applied sufficient brake force, the system will compensate and provide additional brake force as required.

If a Forward Collision Warning with Mitigation event begins at a speed below 39 mph (62 km/h), the system may provide maximum braking to mitigate the potential forward collision. If the Forward Collision Warning with Mitigation event stops the vehicle completely, the system will hold the vehicle at a standstill for two seconds and then release the brakes.

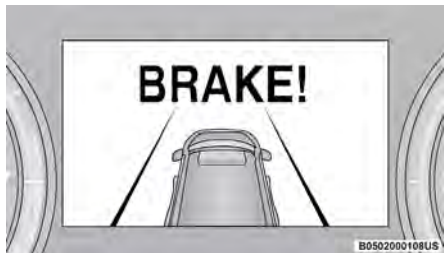

FCW Message

When the system determines a collision with the vehicle in front of you is no longer probable, the warning message will be deactivated ↪ page 331.

NOTE:

- The minimum speed for FCW activation is 3 mph (5 km/h).
- The FCW alerts may be triggered on objects other than vehicles, such as guardrails or sign posts based on the course prediction. This is expected and is a part of normal FCW activation and functionality.
- It is unsafe to test the FCW system. To prevent such misuse of the system, after four Active Braking events within an ignition cycle, the Active Braking portion of FCW will be deactivated until the next ignition cycle.
- The FCW system is intended for on-road use only. If the vehicle is taken off-road, the FCW system should be deactivated to prevent unnecessary warnings to the surroundings. If the vehicle enters 4WD Low, the FCW system will be automatically deactivated.

WARNING!

Forward Collision Warning (FCW) is not intended to avoid a collision on its own, nor can FCW detect every type of potential collision. The driver has the responsibility to avoid a collision by controlling the vehicle via braking and steering. Failure to follow this warning could lead to serious injury or death.

FCW Braking Status And Sensitivity

The FCW Sensitivity and Active Braking status are programmable through the Uconnect system ↪ page 169.

NOTE:

- The default sensitivity of FCW is the "Medium" setting and the system status is "Warning & Braking". This allows the system to warn the driver of a possible collision with the vehicle in front using audible/visual warnings and it applies autonomous braking.
- Changing the FCW status to the "Far" setting allows the system to warn the driver of a possible collision with the vehicle in front using an audible/visual warning when the latter is at a farther distance than the "Medium" setting. This provides the most reaction time to avoid a possible collision.
The "Far" setting may result in a greater number of FCW possible collision warnings experienced.
- Changing the FCW status to the "Near" setting allows the system to warn the driver of a possible collision with the vehicle in front when the distance between the vehicle in the front is much closer. This setting provides less reaction time than the "Far" and "Medium" settings, which allows for a more dynamic driving experience.
The "Near" setting may result in a lesser number of FCW possible collision warnings experienced.

NOTE:

- Changing the FCW status to “Only Warning” prevents the system from providing limited active braking, or additional brake support if the driver is not braking adequately in the event of a potential frontal collision, but maintains the audible and visual warnings.
- Changing the FCW status to “Off” prevents the system from providing autonomous braking, or additional brake support if the driver is not braking adequately in the event of a potential frontal collision.
- The system will retain the last setting selected by the driver after ignition shut down.
- FCW may not react to irrelevant objects such as overhead objects, ground reflections, objects not in the path of the vehicle, stationary objects that are far away, oncoming traffic, or leading vehicles with the same or higher rate of speed.
- FCW will be disabled like ACC, with the unavailable screens.

FCW Limited Warning

If the instrument cluster displays “Automatic Emergency Braking (AEB) Limited Service Required” or “Limited Functionality Clean Front Windshield” momentarily, there may be a condition that limits FCW functionality. Although the vehicle is still drivable under normal conditions, the active braking may not be fully available. Once the condition that limited the system performance is no longer present, the system will return to its full performance state. If the problem persists, see an authorized dealer.

Service FCW Warning

If the system turns off, the instrument cluster displays “AEB Unavailable Service Required.” AEB Unavailable Service Required indicates there is an internal system fault. Although the vehicle is still drivable under normal conditions, have the system checked by an authorized dealer.

Pedestrian Emergency Braking (PEB) — If Equipped

PEB is a subsystem of the Forward Collision Warning (FCW) system which provides the driver with audible warnings and visual warnings, in the instrument cluster display. It may apply limited automatic braking when it detects a potential frontal collision with a pedestrian/cyclist.

**PEB Message**

If a PEB event begins at a speed below 39 mph (62 km/h), the system may provide maximum braking to mitigate the potential collision with a pedestrian/cyclist. If the PEB event stops the vehicle completely, the system will hold the vehicle at a standstill for two

seconds and then release the brakes. When the system determines a collision with the pedestrian/cyclist in front of you is no longer probable, the warning message will be deactivated.

The minimum speed for PEB activation is 3 mph (5 km/h).

WARNING!

Pedestrian Emergency Braking (PEB) is not intended to avoid a collision on its own, nor can PEB detect every type of potential collision with a pedestrian/cyclist. The driver has the responsibility to avoid a collision by controlling the vehicle via braking and steering. Failure to follow this warning could lead to serious injury or death.

Turning PEB On Or Off**NOTE:**

The default status of PEB is “On.” This allows the system to warn you of a possible frontal collision with the pedestrian/cyclist.

The PEB button is located in the Uconnect display in the Control settings  page 169.

To turn the PEB system off, push the Pedestrian Emergency Braking button.

To turn the PEB system back on, push the Warning Active Braking button.

Changing the PEB status to “Off” deactivates the system, so no warning or active braking will be available in case of a possible frontal collision with the pedestrian/cyclist.

NOTE:

The PEB system will retain the last setting selected by the driver after ignition shut down. The system will not reset to the default setting when the vehicle is restarted.

Intersection Collision Assist (ICA) — If Equipped

ICA uses three front radar sensors located in the front fascia/bumper, to detect oncoming vehicles from the front or side when driving through an intersection. When the system determines that a collision is probable when turning across oncoming traffic, the system will attempt to mitigate a possible collision by decelerating the vehicle. When the system determines that a collision with a crossing vehicle is probable, the system may apply additional braking to supplement the driver braking input to attempt to mitigate a possible collision. The system will also provide audible warnings and visual warnings (shown in the instrument cluster). If the driver determines acceleration is needed to avoid a collision, when the accelerator is pressed ICA will cancel.

TIRE PRESSURE MONITORING SYSTEM (TPMS)

The TPMS will warn the driver of a low tire pressure based on the vehicle recommended cold tire pressure  page 331.

The tire pressure will vary with temperature by about 1 psi (7 kPa) for every 12°F (6.5°C). This means that when the outside temperature decreases, the tire pressure will decrease. Tire pressure should always be set based on cold inflation tire pressure. This is defined as the tire pressure after the vehicle has not been driven for at least three hours, or driven less than 1 mile

(1.6 km) after a three-hour period. The tire pressure will also increase as the vehicle is driven — this is normal and there should be no adjustment for this increased pressure.

For information on how to properly inflate the vehicle's tires, see  page 304.

The TPMS will warn the driver of a low tire pressure if the tire pressure falls below the low pressure warning threshold for any reason, including low temperature effects, or natural pressure loss through the tire.

The TPMS will continue to warn the driver of low tire pressure as long as the condition exists, and will not turn off until the tire pressure is at or above recommended cold tire pressure. Once the low tire pressure warning has been illuminated, the tire pressure must be increased to the recommended cold tire pressure in order for the TPMS Warning Light to be turned off.

NOTE:

When filling warm tires, the tire pressure may need to be increased up to an additional 4 psi (28 kPa) above the recommended cold placard pressure in order to turn the TPMS Warning Light off.

The system will automatically update and the TPMS Warning Light will extinguish once the updated tire pressures have been received. The vehicle may need to be driven for up to 20 minutes above 15 mph (24 km/h) to receive this information.

For example, your vehicle has a recommended cold (parked for more than three hours) tire pressure of 36 psi (248 kPa). If the ambient temperature is 68°F (20°C) and the measured tire pressure is 28 psi (193 kPa), a temperature drop to 20°F (-7°C) will decrease the tire pressure to approximately 24 psi (165 kPa). This tire pressure is sufficiently low enough to turn on the TPMS Warning Light. Driving the vehicle

may cause the tire pressure to rise to approximately 28 psi (193 kPa), but the TPMS Warning Light will still be on. In this situation, the TPMS Warning Light will turn off only after the tires have been inflated to the vehicle's recommended cold tire pressure value.

CAUTION!

- The TPMS has been optimized for the original equipment tires and wheels. TPMS pressures and warnings have been established for the tire size equipped on your vehicle. Undesirable system operation or sensor damage may result when using replacement equipment that is not of the same size, type, and/or style. The TPMS sensor is not designed for use on aftermarket wheels and may contribute to a poor overall system performance or sensor damage. Customers are encouraged to use Original Equipment Manufacturer (OEM) wheels to ensure proper TPMS feature operation.
- Using aftermarket tire sealants may cause the Tire Pressure Monitoring System (TPMS) sensor to become inoperable. After using an aftermarket tire sealant it is recommended that you take your vehicle to an authorized dealership to have your sensor function checked.
- After inspecting or adjusting the tire pressure, always reinstall the valve stem cap. This will prevent moisture and dirt from entering the valve stem, which could damage the Tire Pressure Monitoring System sensor.

NOTE:

- The TPMS is not intended to replace normal tire care and maintenance, or to provide warning of a tire failure or condition.
- The TPMS should not be used as a tire pressure gauge while adjusting your tire pressure, unless equipped with Tire Fill Alert.
- Driving on a significantly underinflated tire causes the tire to overheat and can lead to tire failure. Underinflation also reduces fuel efficiency and tire tread life, and may affect the vehicle's handling and stopping ability.
- The TPMS is not a substitute for proper tire maintenance, and it is the driver's responsibility to maintain correct tire pressure using an accurate tire gauge, even if underinflation has not reached the level to trigger illumination of the TPMS Warning Light.
- Seasonal temperature changes will affect tire pressure, and the TPMS will monitor the actual tire pressure in the tire.

The Tire Pressure Monitoring System (TPMS) uses wireless technology with wheel rim-mounted electronic sensors to monitor tire pressure levels. Sensors, mounted to each wheel as part of the valve stem, transmit tire pressure readings to the receiver module.

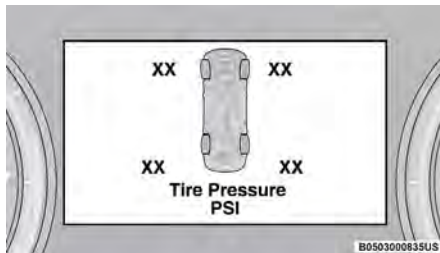

Tire Pressure Monitoring System Display

NOTE:

It is particularly important for you to regularly check the tire pressure in all of your tires and to maintain the proper pressure.

The Tire Pressure Monitoring System (TPMS) consists of the following components:

- Receiver module
- Four Tire Pressure Monitoring System sensors
- Various Tire Pressure Monitoring System messages, which display in the instrument cluster, and a graphic displaying tire pressures
- TPMS Warning Light

Tire Pressure Monitoring System Low Pressure Warnings



The TPMS Warning Light will illuminate in the instrument cluster, and an audible chime will be activated, when one or more of the four active road tire pressures are low. In addition, the instrument cluster will display an "Inflate to XX" message and a graphic display of the pressure value(s) with the low tire(s) in a different color → page 85.

NOTE:

Your system can be set to display pressure units in PSI, BAR, or kPa.

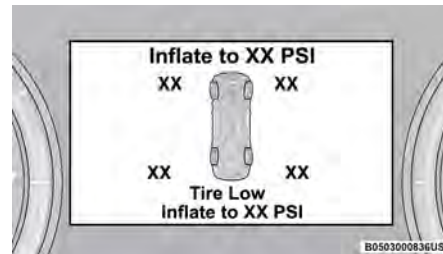

Low Tire Pressure Monitoring System Display

Should a low tire condition occur on any of the four active road tire(s), you should stop as soon as possible, and inflate the low tire(s) that is in a different color on the graphic display to the vehicle's recommended cold tire pressure displayed in the "Inflate to XX" message.

NOTE:

When filling warm tires, the tire pressure may need to be increased up to an additional 4 psi (28 kPa) above the recommended cold placard pressure in order to turn the TPMS Warning Light off.

The system will automatically update, the graphic display of the pressure value(s) will return to its original color and the TPMS Warning Light will extinguish once the updated tire pressure(s) have been received. The system will automatically update the graphic display of the pressure value(s) and will return to its original color. The TPMS Warning Light will extinguish once the updated tire pressure(s) have been received in the case when the ignition is ON. In the case when the ignition is OFF, the ignition on the vehicle has to be turned ON and may need to be driven for up to 20 minutes above 15 mph (24 km/h) to receive this information for the pressure value(s) to be updated.

Service TPMS Warning

The Tire Pressure Monitoring System Warning Light will flash on and off for 75 seconds, and remain on solid when a system fault is detected. The system fault will also sound a chime. The instrument cluster display will display a "SERVICE TPM SYSTEM" message for a minimum of five seconds. This message is then followed by a graphic display, with "--" in place of the pressure value(s), indicating which Tire Pressure Monitoring System sensor(s) is not being received.

If the ignition switch is cycled, this sequence will repeat, providing the system fault still exists. If the system fault no longer exists, the Tire Pressure Monitoring System Warning Light will no longer flash, the "SERVICE TPM SYSTEM" message will not be present, and a pressure value will be displayed instead of dashes. A system fault can occur by any of the following:

- Jamming due to electronic devices or driving next to facilities emitting the same radio frequencies as the TPMS sensors.
- Lots of snow or ice around the wheels or wheel housings.
- Using tire chains on the vehicle.
- Using wheels/tires not equipped with TPMS sensors.

NOTE:

A TPMS sensor is not offered on any size spare tire. In either option of having a full size spare equipped or not, the tire pressure is not monitored or displayed on the cluster for the corresponding spare tire location. If you install the spare tire in place of a road tire that has a pressure below the low-pressure warning limit, upon the next ignition switch cycle, the Tire Pressure Monitoring System Warning Light will remain on, a chime will sound, and the instrument cluster display will still display a pressure value in the different color graphic display and an "Inflate to XX" message will be displayed. After driving the vehicle for up to 20 minutes above 15 mph (24 km/h), the Tire Pressure Monitoring System Warning Light will flash on and off for 75 seconds and then remain on solid. In addition, the instrument cluster display will display a "SERVICE TPM SYSTEM" message for five seconds and then display dashes (-) in place of the pressure value. For each subsequent ignition switch cycle, a chime will sound, the Tire Pressure Monitoring System Warning Light will flash on and off for 75 seconds and then remain on solid, and the instrument cluster display will display a "SERVICE TPM SYSTEM" message for five seconds and then display dashes (-) in place of the pressure value. Once you repair or replace the original road tire, and reinstall it on the vehicle in place of the spare tire, the TPMS will update automatically.

In addition, the Tire Pressure Monitoring System Warning Light will turn off and the graphic in the instrument cluster display will display a new pressure value instead of dashes (-), as long as no tire pressure is below the low-pressure warning limit in any of the four active road tires. The vehicle may need to be driven for up to 20 minutes above 15 mph (24 km/h) in order for the TPMS to receive this information.

TPMS Deactivation — If Equipped

The Tire Pressure Monitoring System (TPMS) can be deactivated by replacing all four wheel and tire assemblies (road tires) with wheel and tire assemblies that do not have TPMS sensors, such as when installing winter wheel and tire assemblies on your vehicle.

To deactivate the TPMS, first, replace all four wheel and tire assemblies (road tires) with tires not equipped with Tire Pressure Monitoring System sensors. Then, drive the vehicle for 20 minutes above 15 mph (24 km/h). The TPMS will chime, the TPMS Warning Light will flash on and off for 75 seconds and then remain on. The instrument cluster will display the "SERVICE TPM SYSTEM" message and then display dashes (-) in place of the pressure values.

Beginning with the next ignition cycle, the TPMS will no longer chime or display the "SERVICE TPM SYSTEM" message in the instrument cluster but dashes (-) will remain in place of the pressure values.

To reactivate the TPMS, replace all four wheel and tire assemblies (road tires) with tires equipped with TPMS sensors. Then, drive the vehicle for up to 20 minutes above 15 mph (24 km/h). The TPMS will chime, the TPMS Warning Light will flash on and off for 75 seconds and then turn off. The instrument cluster will display the "SERVICE TPM SYSTEM" message and then display

pressure values in place of the dashes. On the next ignition cycle the "SERVICE TPM SYSTEM" message will no longer be displayed as long as no system fault exists.

Tire Fill Alert

This feature notifies the user when the placard tire pressure is attained while inflating or deflating the tire.

The customer may choose to disable or enable the Tire Fill Alert feature in the apps menu of the Uconnect system.

NOTE:

- The Tire Fill Alert system will only support inflating or deflating one tire at a time. The user is required to wait until the hazard lights STOP flashing or 26-30 seconds after the desired pressure is achieved in one wheel before switching to another.
- The Tire Fill Alert feature cannot be entered if an existing TPMS fault is set to "active" or if the system is in deactivation mode (if equipped).

The system will be activated when the system detects an increase in tire pressure while filling the tire. The ignition must be in the ON/RUN mode with the transmission in PARK for vehicles equipped with an automatic transmission. For vehicles equipped with a manual transmission, the parking brake must be applied.

NOTE:

It is not required to have the engine running to enter Tire Fill Alert mode.

The hazard lamps will come on to confirm the vehicle is in Tire Fill Alert mode. If the hazard lamps do not come on while inflating the tire, the Tire Pressure Monitoring

System sensor may be in an inoperative position, preventing the TPMS sensor signal from being received. In this case, the vehicle may need to be moved slightly forward or backward.

When Tire Fill Alert mode is entered, the tire pressure display screen will be displayed in the instrument cluster.

Operation:

- The horn will chirp once to let the user know when to stop filling the tire, when it reaches recommended pressure.
- The horn will chirp three times if the tire is overfilled and will continue to chirp every five seconds if the user continues to inflate the tire.
- The horn will chirp once again when enough air is let out to reach proper inflation level.
- The horn will also chirp three times if the tire is then underinflated and will continue to chirp every five seconds if the user continues to deflate the tire.

Selectable Tire Fill Alert (STFA) — If Equipped

The Selectable Tire Fill Alert (STFA) system is an optional feature that is included as part of the normal Tire Fill Alert system. The system is designed to allow you to select a pressure to inflate or deflate the vehicle's front and rear axle tires to, and to provide feedback while inflating or deflating the vehicle's tires.

In the Selectable Tire Fill Alert application, which is located in the apps menu of the Uconnect system, you will be able to select a pressure setting for both the front and rear axle tire pressures by scrolling through a pressure range from ≥ 15 psi to XX in 1 psi increments for each axle setting.

XX = the vehicle's cold placard pressure values for the front and rear axles as shown on the vehicle placard pressure label.

You may also store pressure values chosen for each axle in the Uconnect system application as preset pressure values. Up to two sets of preset pressure values can be stored in the Uconnect system for the front and rear axle. Once you select the tire pressures for the front and rear axles that you want to inflate or deflate to, you can begin inflating or deflating one tire at a time.

NOTE:

The STFA system will only support inflating or deflating one tire at a time. The user is required to wait until the hazard lights STOP flashing or 26-30 seconds after the desired pressure is achieved in one wheel before switching to another.

The system will be activated when the TPMS receiver module detects a change in tire pressure. The ignition must be in the ON/RUN mode, with the transmission in PARK in vehicles with an automatic transmission, and in NEUTRAL with the parking brake engaged in vehicles with a manual transmission. The hazard lamps will come on to confirm the vehicle is in Tire Fill Alert mode.

When Tire Fill Alert mode is entered, the tire pressure screen will be displayed in the instrument cluster. If the hazard lamps do not come on while inflating or deflating the tire, the Tire Pressure Monitoring System sensor may be in an inoperative position, preventing the TPMS sensor signal from being received. In this case, the vehicle may need to be moved slightly forward or backward.

Horn chirps will indicate STFA status as tires are inflated/deflated. The horn will chirp under the following STFA states:

1. The horn will chirp once when the selected pressure is reached to let you know when to stop inflating or deflating the tire.
2. The horn will chirp three times if the tire is overinflated or over-deflated.
3. The horn will chirp once again when enough air is added or removed to reach proper selected pressure level.

OCCUPANT RESTRAINT SYSTEMS

Some of the most important safety features in your vehicle are the restraint systems:

OCCUPANT RESTRAINT SYSTEMS FEATURES

- Seat Belt Systems
- Supplemental Restraint Systems (SRS) Air Bags
- Child Restraints

Some of the safety features described in this section may be standard equipment on some models, or may be optional equipment on others. If you are not sure, ask an authorized dealer.

IMPORTANT SAFETY PRECAUTIONS

Please pay close attention to the information in this section. It tells you how to use your restraint system properly, to keep you and your passengers as safe as possible.

Here are some simple steps you can take to minimize the risk of harm from a deploying air bag:

1. Children 12 years old and under should always ride buckled up in the rear seat of a vehicle with a rear seat.
2. A child who is not big enough to wear the vehicle seat belt properly must be secured in the appropriate child restraint or belt-positioning booster seat in a rear seating position → page 237.
3. If a child from 2 to 12 years old (not in a rear-facing child restraint) must ride in the front passenger seat, move the seat as far back as possible and use the proper child restraint → page 237.
4. Never allow children to slide the shoulder belt behind them or under their arm.
5. You should read the instructions provided with your child restraint to make sure that you are using it properly.
6. All occupants should always wear their lap and shoulder belts properly.
7. The driver and front passenger seats should be moved back as far as practical to allow the front air bags room to inflate.
8. Do not lean against the door or window. If your vehicle has side air bags, and deployment occurs, the side air bags will inflate forcefully into the space between occupants and the door and occupants could be injured.
9. If the air bag system in this vehicle needs to be modified to accommodate a disabled person, see → page 327 for customer service contact information.

WARNING!

- Never place a rear-facing child restraint in front of an air bag. A deploying passenger front air bag can cause death or serious injury to a child 12 years or younger, including a child in a rear-facing child restraint.
- Never install a rear-facing child restraint in the front seat of a vehicle. Only use a rear-facing child restraint in the rear seat. If the vehicle does not have a rear seat, do not transport a rear-facing child restraint in that vehicle.

SEAT BELT SYSTEMS

Buckle up even though you are an excellent driver, even on short trips. Someone on the road may be a poor driver and could cause a collision that includes you. This can happen far away from home or on your own street.

Research has shown that seat belts save lives, and they can reduce the seriousness of injuries in a collision. Some of the worst injuries happen when people are thrown from the vehicle. Seat belts reduce the possibility of ejection and the risk of injury caused by striking the inside of the vehicle. Everyone in a motor vehicle should be belted at all times.

Enhanced Seat Belt Use Reminder System (BeltAlert)

Driver And Passenger BeltAlert — If Equipped



BeltAlert is a feature intended to remind the driver and outboard front seat passenger (if equipped with outboard front passenger seat BeltAlert) to buckle their seat belts. The BeltAlert feature is active whenever the ignition switch is in the START or ON/RUN position.

Initial Indication

If the driver is unbuckled when the ignition switch is first in the START or ON/RUN position, a chime will signal for a few seconds. If the driver or outboard front seat passenger (if equipped with outboard front passenger seat BeltAlert) is unbuckled when the ignition switch is first in the START or ON/RUN position the Seat Belt Reminder Light will turn on and remain on until both outboard front seat belts are buckled. The outboard front passenger seat BeltAlert is not active when an outboard front passenger seat is unoccupied.

BeltAlert Warning Sequence

The BeltAlert warning sequence is activated when the vehicle is moving above a specified vehicle speed range and the driver or outboard front seat passenger is unbuckled (if equipped with outboard front passenger seat BeltAlert) (the outboard front passenger seat BeltAlert is not active when the outboard front passenger seat is unoccupied). The BeltAlert warning sequence starts by blinking the Seat Belt Reminder Light and sounding an intermittent chime. Once the BeltAlert warning sequence has completed, the Seat Belt Reminder Light will remain on until the seat belts are buckled. The BeltAlert warning sequence may repeat based on vehicle speed until the driver and occupied outboard front seat passenger seat belts are buckled. The driver should instruct all occupants to buckle their seat belts.

Change Of Status

If the driver or outboard front seat passenger (if equipped with outboard front passenger seat BeltAlert) unbuckles their seat belt while the vehicle is traveling, the BeltAlert warning sequence will begin until the seat belts are buckled again.

The outboard front passenger seat BeltAlert is not active when the outboard front passenger seat is unoccupied. BeltAlert may be triggered when an animal or other items are placed on the outboard front passenger seat or when the seat is folded flat (if equipped). It is recommended that pets be restrained in the rear seat (if equipped) in pet harnesses or pet carriers that are secured by seat belts, and cargo is properly stowed.

BeltAlert can be activated or deactivated by an authorized dealer. FCA US LLC does not recommend deactivating BeltAlert.

NOTE:

If BeltAlert has been deactivated and the driver or outboard front seat passenger (if equipped with outboard front passenger seat BeltAlert) is unbuckled the Seat Belt Reminder Light will turn on and remain on until the driver and outboard front seat passenger seat belts are buckled.

Lap/Shoulder Belts

All seating positions in your vehicle are equipped with lap/shoulder belts.

The seat belt webbing retractor will lock only during very sudden stops or collisions. This feature allows the shoulder part of the seat belt to move freely with you under normal conditions. However, in a collision the seat belt will lock and reduce your risk of striking the inside of the vehicle or being thrown out of the vehicle.

WARNING!

- Relying on the air bags alone could lead to more severe injuries in a collision. The air bags work with your seat belt to restrain you properly. In some collisions, the air bags won't deploy at all. Always wear your seat belt even though you have air bags.
- In a collision, you and your passengers can suffer much greater injuries if you are not properly buckled up. You can strike the interior of your vehicle or other passengers, or you can be thrown out of the vehicle. Always be sure you and others in your vehicle are buckled up properly.
- It is dangerous to ride in a cargo area, inside or outside of a vehicle. In a collision, people riding in these areas are more likely to be seriously injured or killed.
- Do not allow people to ride in any area of your vehicle that is not equipped with seats and seat belts.
- Be sure everyone in your vehicle is in a seat and using a seat belt properly. Occupants, including the driver, should always wear their seat belts whether or not an air bag is also provided at their seating position to minimize the risk of severe injury or death in the event of a crash.
- Wearing your seat belt incorrectly could make your injuries in a collision much worse. You might suffer internal injuries, or you could even slide out of the seat belt. Follow these instructions to wear your seat belt safely and to keep your passengers safe, too.
- Two people should never be belted into a single seat belt. People belted together can crash into one another in a collision, hurting one another badly. Never use a lap/shoulder belt or a lap belt for more than one person, no matter what their size.

WARNING!

- A lap belt worn too high can increase the risk of injury in a collision. The seat belt forces won't be at the strong hip and pelvic bones, but across your abdomen. Always wear the lap part of your seat belt as low as possible and keep it snug.
- A twisted seat belt may not protect you properly. In a collision, it could even cut into you. Be sure the seat belt is flat against your body, without twists. If you can't straighten a seat belt in your vehicle, take it to an authorized dealer immediately and have it fixed.
- A seat belt that is buckled into the wrong buckle will not protect you properly. The lap portion could ride too high on your body, possibly causing internal injuries. Always buckle your seat belt into the buckle nearest you.
- A seat belt that is too loose will not protect you properly. In a sudden stop, you could move too far forward, increasing the possibility of injury. Wear your seat belt snugly.
- A seat belt that is worn under your arm is dangerous. Your body could strike the inside surfaces of the vehicle in a collision, increasing head and neck injury. A seat belt worn under the arm can cause internal injuries. Ribs aren't as strong as shoulder bones. Wear the seat belt over your shoulder so that your strongest bones will take the force in a collision.
- A shoulder belt placed behind you will not protect you from injury during a collision. You are more likely to hit your head in a collision if you do not wear your shoulder belt. The lap and shoulder belt are meant to be used together.

*(Continued)***WARNING!**

- A frayed or torn seat belt could rip apart in a collision and leave you with no protection. Inspect the seat belt system periodically, checking for cuts, frays, or loose parts. Damaged parts must be replaced immediately. Do not disassemble or modify the seat belt system. If your vehicle is involved in a collision, or if you have questions regarding seat belt or retractor conditions, take your vehicle to an authorized FCA dealer or authorized FCA Certified Collision Care Program facility for inspection.

Lap/Shoulder Belt Operating Instructions

1. Enter the vehicle and close the door. Sit back and adjust the seat.
2. The seat belt latch plate is above the back of the front seat, and next to your arm in the rear seat (for vehicles equipped with a rear seat). Grab the latch plate and pull out the seat belt. Slide the latch plate up the webbing as far as necessary to allow the seat belt to go around your lap.

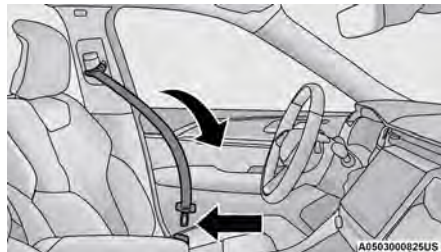
**Pulling Out The Latch Plate**

3. When the seat belt is long enough to fit, insert the latch plate into the buckle until you hear a "click."

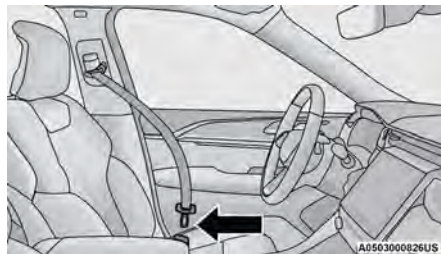
**Inserting Latch Plate into Buckle**

4. Position the lap belt so that it is snug and lies low across your hips, below your abdomen. To remove slack in the lap belt portion, pull up on the shoulder belt. To loosen the lap belt if it is too tight, tilt the latch plate and pull on the lap belt. A snug seat belt reduces the risk of sliding under the seat belt in a collision.

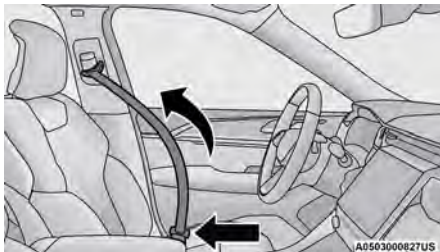
**Positioning The Lap Belt**

- Position the shoulder belt across the shoulder and chest with minimal, if any slack so that it is comfortable and not resting on your neck. The retractor will withdraw any slack in the shoulder belt.
- To release the seat belt, push the red button on the buckle. The seat belt will automatically retract to its stowed position. If necessary, slide the latch plate down the webbing to allow the seat belt to retract fully.

Lap/Shoulder Belt Untwisting Procedure

Use the following procedure to untwist a twisted lap/shoulder belt.

- Position the latch plate as close as possible to the anchor point.
- At about 6 to 12 inches (15 to 30 cm) above the latch plate, grab and twist the seat belt webbing 180 degrees to create a fold that begins immediately above the latch plate.

- Slide the latch plate upward over the folded webbing. The folded webbing must enter the slot at the top of the latch plate.
- Continue to slide the latch plate up until it clears the folded webbing and the seat belt is no longer twisted.

Adjustable Upper Shoulder Belt Anchorage

In the driver and outboard front passenger seats, the top of the shoulder belt can be adjusted upward or downward to position the seat belt away from your neck. Push or squeeze the anchorage button to release the anchorage, and move it up or down to the position that serves you best.

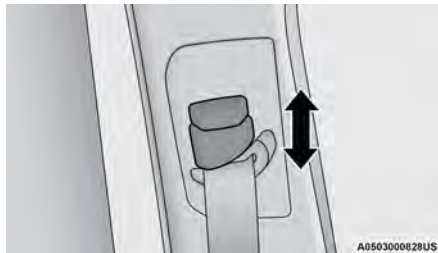
**Adjustable Upper Anchorage**

As a guide, if you are shorter than average, you will prefer the shoulder belt anchorage in a lower position, and if you are taller than average, you will prefer the shoulder belt anchorage in a higher position. After you release the anchorage button, try to move it up or down to make sure that it is locked in position.

NOTE:

The adjustable upper shoulder belt anchorage is equipped with an Easy Up feature. This feature allows the shoulder belt anchorage to be adjusted in the upward position without pushing or squeezing the release button. To verify the shoulder belt anchorage is latched, pull downward on the shoulder belt anchorage until it is locked into position.

WARNING!

- Wearing your seat belt incorrectly could make your injuries in a collision much worse. You might suffer internal injuries, or you could even slide out of the seat belt. Follow these instructions to wear your seat belt safely and to keep your passengers safe, too.
- Position the shoulder belt across the shoulder and chest with minimal, if any slack so that it is comfortable and not resting on your neck. The retractor will withdraw any slack in the shoulder belt.
- Misadjustment of the seat belt could reduce the effectiveness of the safety belt in a crash.
- Always make all seat belt height adjustments when the vehicle is stationary.

Seat Belt Extender

If a seat belt is not long enough to fit properly, even when the webbing is fully extended and the adjustable upper shoulder belt anchorage (if equipped) is in its lowest position, an authorized dealer can provide you with a Seat Belt Extender. The Seat Belt Extender should be used only if the existing seat belt is not long enough. When the Seat Belt Extender is not required for a different occupant, it must be removed.

WARNING!

- ONLY use a Seat Belt Extender if it is physically required in order to properly fit the original seat belt system. DO NOT USE the Seat Belt Extender if, when worn, the distance between the front edge of the Seat Belt Extender buckle and the center of the occupant's body is LESS than 6 inches.
- Using a Seat Belt Extender when not needed can increase the risk of serious injury or death in a collision. Only use the Seat Belt Extender when the lap belt is not long enough and only use in the recommended seating positions. Remove and store the Seat Belt Extender when not needed.

Seat Belts And Pregnant Women**Seat Belts And Pregnant Women**

Seat belts must be worn by all occupants including pregnant women: the risk of injury in the event of an accident is reduced for the mother and the unborn child if they are wearing a seat belt.

Position the lap belt snug and low below the abdomen and across the strong bones of the hips. Place the shoulder belt across the chest and away from the neck. Never place the shoulder belt behind the back or under the arm.

Seat Belt Pretensioner

The front outboard seat belt system is equipped with pretensioning devices that are designed to remove slack from the seat belt in the event of a collision. These devices may improve the performance of the seat belt by removing slack from the seat belt early in a collision. Pretensioners work for all size occupants, including those in child restraints.

NOTE:

These devices are not a substitute for proper seat belt placement by the occupant. The seat belt still must be worn snugly and positioned properly.

The pretensioners are triggered by the Occupant Restraint Controller (ORC). Like the air bags, the pretensioners are single use items. A deployed pretensioner or a deployed air bag must be replaced immediately.

Energy Management Feature

The front outboard seat belt system is equipped with an Energy Management feature that may help further reduce the risk of injury in the event of a collision. The seat belt system has a retractor assembly that is designed to release webbing in a controlled manner.

Switchable Automatic Locking Retractor (ALR)

The seat belts in the passenger seating positions are equipped with a Switchable Automatic Locking Retractor (ALR) which is used to secure a child restraint system → page 246.

The figure provided illustrates the locking feature for each seating position.

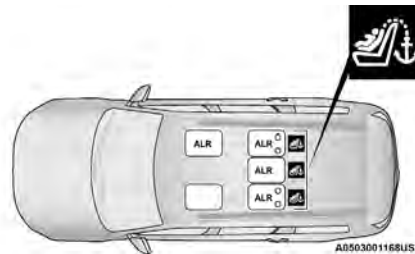
**Five Passenger Automatic Locking Retractor (ALR) Locations**

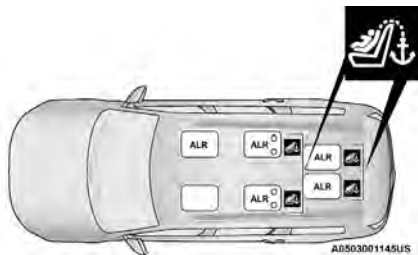

Captain's Chairs Second Row (Six Passenger) Automatic Locking Retractor (ALR) Locations

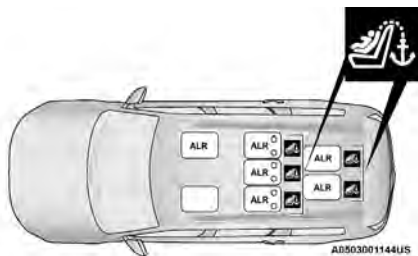

60/40 Second Row (Seven Passenger) Automatic Locking Retractor (ALR) Locations

If the passenger seating position is equipped with an ALR and is being used for normal usage, only pull the seat belt webbing out far enough to comfortably wrap around the occupant's mid-section so as to not activate the ALR. If the ALR is activated, you will hear a clicking sound as the seat belt retracts. Allow the webbing to

retract completely in this case and then carefully pull out only the amount of webbing necessary to comfortably wrap around the occupant's mid-section. Slide the latch plate into the buckle until you hear a "click".

In Automatic Locking Mode, the shoulder belt is automatically pre-locked. The seat belt will still retract to remove any slack in the shoulder belt. Use the Automatic Locking Mode anytime a child restraint is installed in a seating position that has a seat belt with this feature. Children 12 years old and under should always be properly restrained in the rear seat of a vehicle with a rear seat.

WARNING!

- Never place a rear-facing child restraint in front of an air bag. A deploying passenger front air bag can cause death or serious injury to a child 12 years or younger, including a child in a rear-facing child restraint.
- Never install a rear-facing child restraint in the front seat of a vehicle. Only use a rear-facing child restraint in the rear seat. If the vehicle does not have a rear seat, do not transport a rear-facing child restraint in that vehicle.

How To Engage The Automatic Locking Mode

1. Buckle the combination lap and shoulder belt.
2. Grab the shoulder portion and pull downward until the entire seat belt is extracted.
3. Allow the seat belt to retract. As the seat belt retracts, you will hear a clicking sound. This indicates the seat belt is now in the Automatic Locking Mode.

How To Disengage The Automatic Locking Mode

Unbuckle the combination lap/shoulder belt and allow it to retract completely to disengage the Automatic Locking Mode and activate the vehicle sensitive (emergency) locking mode.

WARNING!

- The seat belt assembly must be replaced if the switchable Automatic Locking Retractor (ALR) feature or any other seat belt function is not working properly when checked according to the procedures in the Service Manual.
- Failure to replace the seat belt assembly could increase the risk of injury in collisions.
- Do not use the Automatic Locking Mode to restrain occupants who are wearing the seat belt or children who are using booster seats. The locked mode is only used to install rear-facing or forward-facing child restraints that have a harness for restraining the child.

Third Row Stow Clip — If Equipped

Six And Seven Passenger Only

Your vehicle may be equipped with a stow clip on the lower trim behind the third row. This clip is used to hold the seat belt out of the path of the third row seat back when it is being folded and opened. Only place the seat belt webbing in this clip while folding and opening the seat. Do not leave the webbing behind the clip when using the belt to restrain an occupant.

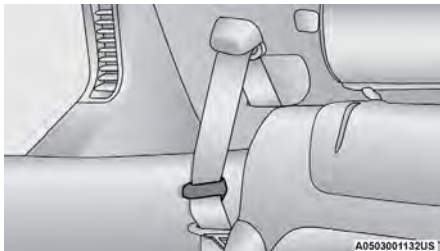

Third Row Stow Clip

WARNING!

Do not place the seat belt webbing behind the third row stow clip when using the seat belt to restrain an occupant. The seat belt will not be positioned properly on the occupant and they could be more seriously injured in an accident as a result.

SUPPLEMENTAL RESTRAINT SYSTEMS (SRS)

Some of the safety features described in this section may be standard equipment on some models, or may be optional equipment on others. If you are not sure, ask an authorized dealer.

The air bag system must be ready to protect you in a collision. The Occupant Restraint Controller (ORC) monitors the internal circuits and interconnecting wiring associated with the electrical Air Bag System Components. Your vehicle may be equipped with the following Air Bag System Components:

Air Bag System Components

- Occupant Restraint Controller (ORC)
- Air Bag Warning Light 
- Steering Wheel and Column
- Instrument Panel
- Knee Impact Bolsters
- Driver and Front Passenger Air Bags
- Seat Belt Buckle Switch
- Supplemental Side Air Bags
- Supplemental Knee Air Bags
- Front and Side Impact Sensors
- Seat Belt Pretensioners
- Seat Track Position Sensors
- Occupant Classification System

Air Bag Warning Light



The Occupant Restraint Controller (ORC) monitors the readiness of the electronic parts of the air bag system whenever the ignition switch is in the START or ON/RUN position. If the ignition switch is in the OFF position or in the ACC position, the air bag system is not on and the air bags will not inflate.

The ORC contains a backup power supply system that may deploy the air bag system even if the battery loses power or it becomes disconnected prior to deployment.

The ORC turns on the Air Bag Warning Light in the instrument panel for approximately four to eight seconds for a self-check when the ignition switch is first in the ON/RUN position. After the self-check, the Air Bag Warning Light will turn off. If the ORC detects a malfunction in any part of the system, it turns on the Air

Bag Warning Light, either momentarily or continuously. A single chime will sound to alert you if the light comes on again after initial startup.

The ORC also includes diagnostics that will illuminate the instrument panel Air Bag Warning Light if a malfunction is detected that could affect the air bag system. The diagnostics also record the nature of the malfunction. While the air bag system is designed to be maintenance free, if any of the following occurs, have an authorized dealer service the air bag system immediately.

- The Air Bag Warning Light does not come on during the four to eight seconds when the ignition switch is first in the ON/RUN position.
- The Air Bag Warning Light remains on after the four to eight-second interval.
- The Air Bag Warning Light comes on intermittently or remains on while driving.

NOTE:

If the speedometer, tachometer, or any engine related gauges are not working, the Occupant Restraint Controller (ORC) may also be disabled. In this condition the air bags may not be ready to inflate for your protection. Have an authorized dealer service the air bag system immediately.

WARNING!

Ignoring the Air Bag Warning Light in your instrument panel could mean you won't have the air bag system to protect you in a collision. If the light does not come on as a bulb check when the ignition is first turned on, stays on after you start the vehicle, or if it comes on as you drive, have an authorized dealer service the air bag system immediately.

Redundant Air Bag Warning Light



If a fault with the Air Bag Warning Light is detected, which could affect the Supplemental Restraint System (SRS), the Redundant Air Bag Warning Light will illuminate on the instrument panel. The Redundant Air Bag Warning Light will stay on until the fault is cleared. In addition, a single chime will sound to alert you that the Redundant Air Bag Warning Light has come on and a fault has been detected. If the Redundant Air Bag Warning Light comes on intermittently or remains on while driving have an authorized dealer service the vehicle immediately ↪ page 93.

Front Air Bags

This vehicle has front air bags and lap/shoulder belts for both the driver and front passenger. The front air bags are a supplement to the seat belt restraint systems. The driver front air bag is mounted in the center of the steering wheel. The passenger front air bag is mounted in the instrument panel, above the glove compartment. The words "SRS AIRBAG" or "AIRBAG" are embossed on the air bag covers.

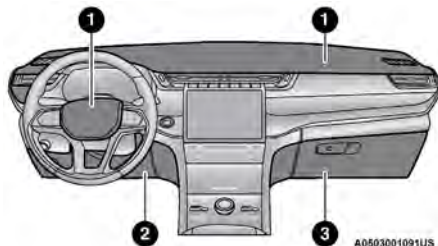

Front Air Bag/ Knee Bolster Locations

- 1 – Driver And Passenger Front Air Bags
- 2 – Driver Knee Impact Bolster/Supplemental Driver Knee Air Bag
- 3 – Passenger Knee Impact Bolster/Supplemental Passenger Knee Air Bag

WARNING!

- Being too close to the steering wheel or instrument panel during front air bag deployment could cause serious injury, including death. Air bags need room to inflate. Sit back, comfortably extending your arms to reach the steering wheel or instrument panel.
- Never place a rear-facing child restraint in front of an air bag. A deploying passenger front air bag can cause death or serious injury to a child 12 years or younger, including a child in a rear-facing child restraint.

(Continued)

WARNING!

- Never install a rear-facing child restraint in the front seat of a vehicle. Only use a rear-facing child restraint in the rear seat. If the vehicle does not have a rear seat, do not transport a rear-facing child restraint in that vehicle.

Driver And Passenger Front Air Bag Features

The Advanced Front Air Bag system has multistage driver and front passenger air bags. This system provides output appropriate to the severity and type of collision as determined by the Occupant Restraint Controller (ORC), which may receive information from the front impact sensors (if equipped) or other system components.

The first stage inflator is triggered immediately during an impact that requires air bag deployment. A low energy output is used in less severe collisions. A higher energy output is used for more severe collisions.

This vehicle may be equipped with a driver and/or front passenger seat belt buckle switch that detects whether the driver or front passenger seat belt is buckled. The seat belt buckle switch may adjust the inflation rate of the Advanced Front Air Bags.

This vehicle may be equipped with driver and/or front passenger seat track position sensors that may adjust the inflation rate of the Advanced Front Air Bags based upon seat position.

This vehicle is equipped with a right front passenger Occupant Classification System ("OCS") that is designed to provide Passenger Advanced Front Air Bag output appropriate to the occupant's seated weight input, as determined by the OCS.

WARNING!

- No objects should be placed over or near the air bag on the instrument panel or steering wheel because any such objects could cause harm if the vehicle is in a collision severe enough to cause the air bag to inflate.
- Do not put anything on or around the air bag covers or attempt to open them manually. You may damage the air bags and you could be injured because the air bags may no longer be functional. The protective covers for the air bag cushions are designed to open only when the air bags are inflating.
- Relying on the air bags alone could lead to more severe injuries in a collision. The air bags work with your seat belt to restrain you properly. In some collisions, air bags won't deploy at all. Always wear your seat belts even though you have air bags.

Front Air Bag Operation

Front Air Bags are designed to provide additional protection by supplementing the seat belts. Front air bags are not expected to reduce the risk of injury in rear, side, or rollover collisions. The front air bags will not deploy in all frontal collisions, including some that may produce substantial vehicle damage — for example, some pole collisions, truck underrides, and angle offset collisions.

On the other hand, depending on the type and location of impact, front air bags may deploy in crashes with little vehicle front-end damage but that produce a severe initial deceleration.

Because air bag sensors measure vehicle deceleration over time, vehicle speed and damage by themselves are not good indicators of whether or not an air bag should have deployed.

Seat belts are necessary for your protection in all collisions, and also are needed to help keep you in position, away from an inflating air bag.

When the Occupant Restraints Controller (ORC) detects a collision requiring the front air bags, it signals the inflator units. A large quantity of non-toxic gas is generated to inflate the front air bags.

The steering wheel hub trim cover and the upper passenger side of the instrument panel separate and fold out of the way as the air bags inflate to their full size.

The front air bags fully inflate in less time than it takes to blink your eyes. The front air bags then quickly deflate while helping to restrain the driver and front passenger.

Occupant Classification System (OCS) — Front Passenger Seat

The Occupant Classification System (OCS) is part of a Federally regulated safety system for this vehicle. It is designed to provide Passenger Advanced Front Air Bag output appropriate to the occupant's seated weight, as determined by the OCS.

The Occupant Classification System (OCS) consists of the following:

- Occupant Restraint Controller (ORC)
- Occupant Classification Module (OCM) and Sensor located in the front passenger seat
- Air Bag Warning Light 

Occupant Classification Module (OCM) And Sensor

The Occupant Classification Module (OCM) is located underneath the front passenger seat. The Sensor is located beneath the passenger seat cushion foam. Any weight on the seat will be sensed by the Sensor. The OCM uses input from the Sensor to determine the front passenger's most probable classification. The OCM communicates this information to the ORC. The ORC may reduce the inflation rate of the Passenger Advanced Front Air Bag deployment based on occupant classification. In order for the OCS to operate as designed, it is important for the front passenger to be seated properly and properly wearing the seat belt.

The OCS will NOT prevent deployment of the Passenger Advanced Front Air Bag. The OCS may reduce the inflation rate of the Passenger Advanced Front Air Bag if the OCS estimates that:

- The front passenger seat is unoccupied or has very light objects on it; or
- The front passenger seat is occupied by a small passenger, including a child; or
- The front passenger seat is occupied by a rear-facing child restraint; or
- The front passenger is not properly seated or his or her weight is taken off of the seat for a period of time.

Front Passenger Seat Occupant Status	Front Passenger Air Bag Output
Rear-facing child restraint	Reduced-power deployment
Child, including a child in a forward-facing child restraint or booster seat*	Reduced-power deployment OR full-power deployment
Properly seated adult	Full-power deployment OR reduced-power deployment
Unoccupied seat	Reduced-power deployment

* It is possible for a child to be classified as an adult, allowing a full-power Passenger Advanced Front Air Bag deployment. Never allow children to ride in the front passenger seat and never install a child restraint system, including a rear-facing child restraint, in the front passenger seat.

WARNING!

- Never place a rear-facing child restraint in front of an air bag. A deploying passenger front air bag can cause death or serious injury to a child 12 years or younger, including a child in a rear-facing child restraint.
- Never install a rear-facing child restraint in the front seat of a vehicle. Only use a rear-facing child restraint in the rear seat. If the vehicle does not have a rear seat, do not transport a rear-facing child restraint in that vehicle.
- Children 12 years or younger should always ride buckled up in the rear seat of a vehicle with a rear seat.

The OCS determines the front passenger's most probable classification. The OCS estimates the seated weight on the front passenger seat and where that weight is located. The OCS communicates the classification status to the ORC. The ORC uses the classification to determine whether the Passenger Advanced Front Air Bag inflation rate should be adjusted.

In order for the OCS to operate as designed, it is important for the front passenger to be seated properly and properly wearing the seat belt. Properly seated passengers are:

- Sitting upright
- Facing forward
- Sitting in the center of the seat with their feet comfortably on or near the floor
- Sitting with their back against the seatback and the seatback in an upright position



Seated Properly

Lighter Weight Passengers (Including Small Adults)

When a lighter weight passenger, including a small adult, occupies the front passenger seat, the OCS may reduce the inflation rate of the Passenger Advanced Front Air Bag. This does not mean that the OCS is working improperly.

Do not decrease OR increase the front passenger's seated weight on the front passenger seat

The front passenger's seated weight must be properly positioned on the front passenger seat. Failure to do so may result in serious injury or death. The OCS determines the most probable classification of the occupant that it detects. The OCS will detect the front passenger's decreased or increased seated weight, which may result in an adjusted inflation rate of the Passenger Advanced Front Air Bag in a collision. This does not mean that the OCS is working improperly. Decreasing the front passenger's seated weight on the front passenger seat may result in a reduced-power deployment of the Passenger Advanced Front Air Bag. Increasing the front passenger's seated weight on the front passenger seat may result in a full-power deployment of the Passenger Advanced Front Air Bag.

Examples of improper front passenger seating include:

- The front passenger's weight is transferred to another part of the vehicle (like the door, arm rest or instrument panel).
- The front passenger leans forward, sideways, or turns to face the rear of the vehicle.
- The front passenger's seatback is not in the full upright position.
- The front passenger carries or holds an object while seated (e.g., backpack, box, etc.).
- Objects are lodged under the front passenger seat.
- Objects are lodged between the front passenger seat and center console.
- Accessories that may change the seated weight on the front passenger seat are attached to the front passenger seat.
- Anything that may decrease or increase the front passenger's seated weight.

The OCS determines the front passenger's most probable classification. If an occupant in the front passenger seat is seated improperly, the occupant may provide an output signal to the OCS that is different from the occupant's properly seated weight input, for example:



Not Seated Properly

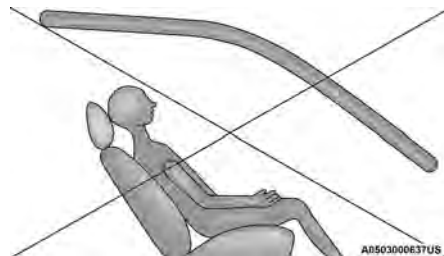

Not Seated Properly

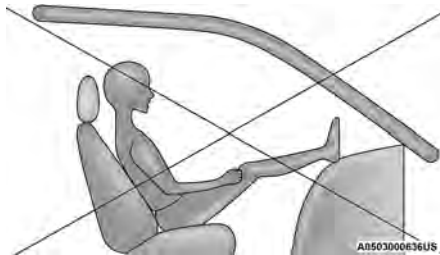

Not Seated Properly

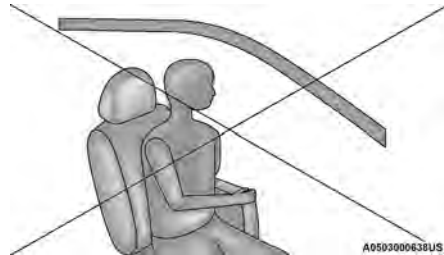

Not Seated Properly

WARNING!

- If a child restraint system, child, small teenager or adult in the front passenger seat is seated improperly, the occupant may provide an output signal to the OCS that is different from the occupant's properly seated weight input. This may result in serious injury or death in a collision.
- Always wear your seat belt and sit properly, with the seatback in an upright position, your back against the seatback, sitting upright, facing forward, in the center of the seat, with your feet comfortably on or near the floor.
- Do not carry or hold any objects (e.g., backpacks, boxes, etc.) while seated in the front passenger seat. Holding an object may provide an output signal to the OCS that is different than the occupant's properly seated weight input, which may result in serious injury or death in a collision.
- Placing an object on the floor under the front passenger seat may prevent the OCS from working properly, which may result in serious injury or death in a collision. Do not place any objects on the floor under the front passenger seat.

The Air Bag Warning Light  in the instrument panel will turn on whenever the OCS is unable to classify the front passenger seat status. A malfunction in the OCS may affect the operation of the air bag system.

If the Air Bag Warning Light  does not come on, or stays on after you start the vehicle, or it comes on as you drive, take the vehicle to an authorized dealer for service immediately.

The passenger seat assembly contains critical OCS components that may affect the Passenger Advanced Front Air Bag inflation. In order for the OCS to properly

classify the seated weight of a front seat passenger, the OCS components must function as designed. Do not make any modifications to the front passenger seat components, assembly, or to the seat cover. If the seat, trim cover, or cushion needs service for any reason, take the vehicle to an authorized dealer. Only FCA US LLC approved seat accessories may be used.

The following requirements must be strictly followed:

- Do not modify the front passenger seat assembly or components in any way.
- Do not use prior or future model year seat covers or cushions not designated by FCA US LLC for the specific model being repaired. Always use the correct seat cover and cushion specified for the vehicle.
- Do not replace the seat cover or cushion with an aftermarket seat cover or cushion.
- Do not add a secondary seat cover or mat.
- At no time should any Supplemental Restraint System (SRS) component or SRS related component or fastener be modified or replaced with any part except those which are approved by FCA US LLC.

WARNING!

- Unapproved modifications or service procedures to the passenger seat assembly, its related components, seat cover or cushion may inadvertently change the air bag deployment in case of a frontal collision. This could result in death or serious injury to the front passenger if the vehicle is involved in a collision. A modified vehicle may not comply with required Federal Motor Vehicle Safety Standards (FMVSS) and/or Canadian Motor Vehicle Safety Standards (CMVSS).

(Continued)

WARNING!

- If it is necessary to modify the air bag system for persons with disabilities, contact an authorized dealer.

Knee Impact Bolsters

The Knee Impact Bolsters help protect the knees of the driver and front passenger, and position the front occupants for improved interaction with the front air bags.

WARNING!

- Do not drill, cut, or tamper with the knee impact bolsters in any way.
- Do not mount any accessories to the knee impact bolsters such as alarm lights, stereos, citizen band radios, etc.

Supplemental Driver And Front Passenger Knee Air Bags

This vehicle is equipped with a Supplemental Driver Knee Air Bag mounted in the instrument panel below the steering column and a Supplemental Passenger Knee Air Bag mounted in the instrument panel below the glove compartment. The Supplemental Knee Air Bags provide enhanced protection during a frontal impact by working together with the seat belts, pretensioners, and front air bags.

Supplemental Side Air Bags

Supplemental Seat-Mounted Side Air Bags (SABs)

This vehicle is equipped with Supplemental Seat-Mounted Side Air Bags (SABs).

Supplemental Seat-Mounted Side Air Bags (SABs) are located in the outboard side of the front seats. The SABs are marked with "SRS AIRBAG" or "AIRBAG" on a label or on the seat trim on the outboard side of the seats.

The SABs may help to reduce the risk of occupant injury during certain side impacts, in addition to the injury reduction potential provided by the seat belts and body structure.



Front Supplemental Seat-Mounted Side Air Bag Label

When the SAB deploys, it opens the seam on the outboard side of the seatback's trim cover. The inflating SAB deploys through the seat seam into the space between the occupant and the door. The SAB moves at a very high speed and with such a high force that it could injure occupants if they are not seated properly, or if items are positioned in the area where the SAB inflates. Children are at an even greater risk of injury from a deploying air bag.

WARNING!

Do not use accessory seat covers or place objects between you and the Side Air Bags; the performance could be adversely affected and/or objects could be pushed into you, causing serious injury.

Supplemental Side Air Bag Inflatable Curtains (SABICs)

This vehicle is equipped with Supplemental Side Air Bag Inflatable Curtains (SABICs).

Supplemental Side Air Bag Inflatable Curtains (SABICs) are located above the side windows. The trim covering the SABICs is labeled "SRS AIRBAG" or "AIRBAG."



Supplemental Side Air Bag Inflatable Curtain (SABIC) Label Location

SABICs may help reduce the risk of head and other injuries to front and rear seat outboard occupants in certain side impacts, in addition to the injury reduction potential provided by the seat belts and body structure.

The SABIC deploys downward, covering the side windows. An inflating SABIC pushes the outside edge of the headliner out of the way and covers the window. The

SABICs inflate with enough force to injure occupants if they are not belted and seated properly, or if items are positioned in the area where the SABICs inflate. Children are at an even greater risk of injury from a deploying air bag.

The SABICs may help reduce the risk of partial or complete ejection of vehicle occupants through side windows in certain side impact events.

WARNING!

- Do not mount equipment, or stack luggage or other cargo up high enough to block the deployment of the SABICs. The trim covering above the side windows where the SABIC and its deployment path are located should remain free from any obstructions.
- In order for the SABICs to work as intended, do not install any accessory items in your vehicle which could alter the roof. Do not add an aftermarket sunroof to your vehicle. Do not add roof racks that require permanent attachments (bolts or screws) for installation on the vehicle roof. Do not drill into the roof of the vehicle for any reason.

Side Impacts

The Side Air Bags are designed to activate in certain side impacts. The Occupant Restraint Controller (ORC) determines whether the deployment of the Side Air Bags in a particular impact event is appropriate, based on the severity and type of collision. The side impact sensors aid the ORC in determining the appropriate response to impact events. The system is calibrated to deploy the Side Air Bags on the impact side of the vehicle during impacts that require Side Air Bag occupant protection. In side impacts, the Side Air Bags

deploy independently; a left side impact deploys the left Side Air Bags only and a right-side impact deploys the right Side Air Bags only. Vehicle damage by itself is not a good indicator of whether or not Side Air Bags should have deployed.

The Side Air Bags will not deploy in all side collisions, including some collisions at certain angles, or some side collisions that do not impact the area of the passenger compartment. The Side Air Bags may deploy during angled or offset frontal collisions where the front air bags deploy.

Side Air Bags are a supplement to the seat belt restraint system. Side Air Bags deploy in less time than it takes to blink your eyes.

WARNING!

- Occupants, including children, who are up against or very close to Side Air Bags can be seriously injured or killed. Occupants, including children, should never lean on or sleep against the door, side windows, or area where the side air bags inflate, even if they are in an infant or child restraint.
- Seat belts (and child restraints where appropriate) are necessary for your protection in all collisions. They also help keep you in position, away from an inflating Side Air Bag. To get the best protection from the Side Air Bags, occupants must wear their seat belts properly and sit upright with their backs against the seats. Children must be properly restrained in a child restraint or booster seat that is appropriate for the size of the child.

WARNING!

- Side Air Bags need room to inflate. Do not lean against the door or window. Sit upright in the center of the seat.
- Being too close to the Side Air Bags during deployment could cause you to be severely injured or killed.
- Relying on the Side Air Bags alone could lead to more severe injuries in a collision. The Side Air Bags work with your seat belt to restrain you properly. In some collisions, Side Air Bags won't deploy at all. Always wear your seat belt even though you have Side Air Bags.

NOTE:

Air bag covers may not be obvious in the interior trim, but they will open during air bag deployment.

Rollover Events

Side Air Bags and seat belt pretensioners are designed to activate in certain rollover events. The Occupant Restraint Controller (ORC) determines whether deployment in a particular rollover event is appropriate, based on the severity and type of collision. Vehicle damage by itself is not a good indicator of whether or not Side Air Bags and seat belt pretensioners should have deployed.

The Side Air Bags and seat belt pretensioners will not deploy in all rollover events. The rollover sensing system determines if a rollover event may be in progress and whether deployment is appropriate. In the event the vehicle experiences a rollover or near rollover event, and deployment is appropriate, the rollover sensing system will deploy the side air bags and seat belt pretensioners on both sides of the vehicle.

The SABICs may help reduce the risk of partial or complete ejection of vehicle occupants through side windows in certain rollover or side impact events.

Air Bag System Components

NOTE:

The Occupant Restraint Controller (ORC) monitors the internal circuits and interconnecting wiring associated with electrical Air Bag System Components listed below:

- Occupant Restraint Controller (ORC)
- Air Bag Warning Light 
- Steering Wheel and Column
- Instrument Panel
- Knee Impact Bolsters
- Driver and Front Passenger Air Bags
- Seat Belt Buckle Switch
- Supplemental Side Air Bags
- Supplemental Knee Air Bags
- Front and Side Impact Sensors
- Seat Belt Pretensioners
- Seat Track Position Sensors
- Occupant Classification System

If A Deployment Occurs

The front air bags are designed to deflate immediately after deployment.

NOTE:

Front and/or side air bags will not deploy in all collisions. This does not mean something is wrong with the air bag system.

If you do have a collision which deploys the air bags, any or all of the following may occur:

- The air bag material may sometimes cause abrasions and/or skin reddening to the occupants as the air bags deploy and unfold. The abrasions are similar to friction rope burns or those you might get sliding along a carpet or gymnasium floor. They are not caused by contact with chemicals. They are not permanent and normally heal quickly. However, if you haven't healed significantly within a few days, or if you have any blistering, see your doctor immediately.
- As the air bags deflate, you may see some smoke-like particles. The particles are a normal by-product of the process that generates the non-toxic gas used for air bag inflation. These airborne particles may irritate the skin, eyes, nose, or throat. If you have skin or eye irritation, rinse the area with cool water. For nose or throat irritation, move to fresh air. If the irritation continues, see your doctor. If these particles settle on your clothing, follow the garment manufacturer's instructions for cleaning.

Do not drive your vehicle after the air bags have deployed. If you are involved in another collision, the air bags will not be in place to protect you.

WARNING!

Deployed air bags and seat belt pretensioners cannot protect you in another collision. Have the air bags, seat belt pretensioners, and the seat belt retractor assemblies replaced by an authorized dealer immediately. Also, have the Occupant Restraint Controller System serviced as well.

NOTE:

- Air bag covers may not be obvious in the interior trim, but they will open during air bag deployment.
- After any collision, the vehicle should be taken to an authorized dealer immediately.

Enhanced Accident Response System

In the event of an impact, if the communication network remains intact, and the power remains intact, depending on the nature of the event, the Occupant Restraint Controller (ORC) will determine whether to have the Enhanced Accident Response System perform the following functions:

- Cut off fuel to the engine (if equipped)
- Cut off battery power to the electric motor (if equipped)
- Flash hazard lights as long as the battery has power
- Turn on the interior lights, which remain on as long as the battery has power or for 15 minutes from the intervention of the Enhanced Accident Response System
- Unlock the power door locks

Your vehicle may also be designed to perform any of these other functions in response to the Enhanced Accident Response System:

- Turn off the Fuel Filter Heater, Turn off the HVAC Blower Motor, Close the HVAC Circulation Door
- Cut off battery power to the:
 - Engine
 - Electric Motor (if equipped)
 - Electric power steering
 - Brake booster
 - Electric park brake
 - Automatic transmission gear selector
 - Horn
 - Front wiper

NOTE:

After an accident, remember to cycle the ignition to the STOP (OFF/LOCK) position and remove the key from the ignition switch to avoid draining the battery. Carefully check the vehicle for fuel leaks in the engine compartment and on the ground near the engine compartment and fuel tank before resetting the system and starting the engine. If there are no fuel leaks or damage to the vehicle electrical devices (e.g. headlights) after an accident, reset the system by following the procedure described here. If you have any doubt, contact an authorized dealer.

Enhanced Accident Response System Reset Procedure

In order to reset the Enhanced Accident Response System functions after an event, the ignition switch must be changed from ignition START or ON/RUN to ignition OFF. Carefully check the vehicle for fuel leaks in the engine compartment and on the ground near the engine compartment and fuel tank before resetting the system and starting the engine.

After an accident, if the vehicle will not start after performing the reset procedure, the vehicle must be towed to an authorized dealer to be inspected and to have the Enhanced Accident Response System reset.

Maintaining Your Air Bag System

WARNING!

- Modifications to any part of the air bag system could cause it to fail when you need it. You could be injured if the air bag system is not there to protect you. Do not modify the components or wiring, including adding any kind of badges or stickers to

(Continued)

WARNING!

the steering wheel hub trim cover or the upper passenger side of the instrument panel. Do not modify the front fascia/bumper, vehicle body structure, or add aftermarket side steps or running boards.

- It is dangerous to try to repair any part of the air bag system yourself. Be sure to tell anyone who works on your vehicle that it has an air bag system.
- Do not attempt to modify any part of your air bag system. The air bag may inflate accidentally or may not function properly if modifications are made. Take your vehicle to an authorized dealer for any air bag system service. If your seat, including your trim cover and cushion, needs to be serviced in any way (including removal or loosening/tightening of seat attachment bolts), take the vehicle to an authorized dealer. Only manufacturer approved seat accessories may be used. If it is necessary to modify the air bag system for persons with disabilities, contact an authorized dealer.

Event Data Recorder (EDR)

This vehicle is equipped with an event data recorder (EDR). The main purpose of an EDR is to record, in certain crash or near crash-like situations, such as an air bag deployment or hitting a road obstacle, data that will assist in understanding how a vehicle's systems performed. The EDR is designed to record data related to vehicle dynamics and safety systems for a short period of time, typically 30 seconds or less. The EDR in this vehicle is designed to record such data as:

- How various systems in your vehicle were operating;
- Whether or not the driver and passenger safety belts were buckled/fastened;

- How far (if at all) the driver was depressing the accelerator and/or brake pedal; and,
- How fast the vehicle was traveling.

These data can help provide a better understanding of the circumstances in which crashes and injuries occur.

NOTE:

EDR data are recorded by your vehicle only if a non-trivial crash situation occurs; no data are recorded by the EDR under normal driving conditions and no personal data (e.g., name, gender, age, and crash location) are recorded. However, other parties, such as law enforcement, could combine the EDR data with the type of personally identifying data routinely acquired during a crash investigation.

To read data recorded by an EDR, special equipment is required, and access to the vehicle or the EDR is needed. In addition to the vehicle manufacturer, other parties, such as law enforcement, that have the special equipment, can read the information if they have access to the vehicle or the EDR.

CHILD RESTRAINTS

Everyone in your vehicle needs to be buckled up at all times, including babies and children. Every state in the United States, and every Canadian province, requires that small children ride in proper restraint systems. This is the law, and you can be prosecuted for ignoring it. Children 12 years or younger should ride properly buckled up in a rear seat, if available. According to crash statistics, children are safer when properly restrained in the rear seats rather than in the front.

WARNING!

In a collision, an unrestrained child can become a projectile inside the vehicle. The force required to hold even an infant on your lap could become so great that you could not hold the child, no matter how strong you are. The child and others could be badly injured or killed. Any child riding in your vehicle should be in a proper restraint for the child's size.

There are different sizes and types of restraints for children from newborn size to the child almost large enough for an adult safety belt. Always check the child seat Owner's Manual to make sure you have the correct seat for your child. Carefully read and follow all the instructions and warnings in the child restraint Owner's Manual and on all the labels attached to the child restraint.

Before buying any restraint system, make sure that it has a label certifying that it meets all applicable Safety Standards. You should also make sure that you can install it in the vehicle where you will use it.

NOTE:

- For additional information, refer to <http://www.nhtsa.gov/parents-and-caregivers> or call: 1-888-327-4236
- Canadian residents should refer to Transport Canada's website for additional information: <https://tc.canada.ca/en/road-transportation/child-car-seat-safety>

Summary Of Recommendations For Restraining Children In Vehicles

	Child Size, Height, Weight Or Age	Recommended Type Of Child Restraint
Infants and Toddlers	Children who are two years old or younger and who have not reached the height or weight limits of their child restraint	Either an Infant Carrier or a Convertible Child Restraint, facing rearward in a rear seat of the vehicle
Small Children	Children who are at least two years old or who have outgrown the height or weight limit of their rear-facing child restraint	Forward-Facing Child Restraint with a five-point Harness, facing forward in a rear seat of the vehicle
Larger Children	Children who have outgrown their forward-facing child restraint, but are too small to properly fit the vehicle's seat belt	Belt Positioning Booster Seat and the vehicle seat belt, seated in a rear seat of the vehicle
Children Too Large for Child Restraints	Children 12 years old or younger, who have outgrown the height or weight limit of their booster seat	Vehicle Seat Belt, seated in a rear seat of the vehicle

Infant And Child Restraints

Safety experts recommend that children ride rear-facing in the vehicle until they are two years old or until they reach either the height or weight limit of their rear-facing child restraint. Two types of child restraints can be used rear-facing: infant carriers and convertible child seats.

The infant carrier is only used rear-facing in the vehicle. It is recommended for children from birth until they reach the weight or height limit of the infant carrier. Convertible child seats can be used either rear-facing or forward-facing in the vehicle. Convertible child seats often have a higher weight limit in the rear-facing direction than infant carriers do, so they can be used rear-facing by children who have outgrown their infant carrier but are still less than at least two years old. Children should remain rear-facing until they reach the highest weight or height allowed by their convertible child seat.

WARNING!

- Never place a rear-facing child restraint in front of an air bag. A deploying passenger front air bag can cause death or serious injury to a child 12 years or younger, including a child in a rear-facing child restraint.
- Never install a rear-facing child restraint in the front seat of a vehicle. Only use a rear-facing child restraint in the rear seat. If the vehicle does not have a rear seat, do not transport a rear-facing child restraint in that vehicle.

Older Children And Child Restraints

Children who are two years old or who have outgrown their rear-facing convertible child seat can ride forward-facing in the vehicle. Forward-facing child seats and convertible child seats used in the forward-facing direction are for children who are over two years old or who have outgrown the rear-facing weight or height limit of their rear-facing convertible child seat. Children should remain in a forward-facing child seat with a harness for as long as possible, up to the highest weight or height allowed by the child seat.

All children whose weight or height is above the forward-facing limit for the child seat should use a belt-positioning booster seat until the vehicle's seat belts fit properly. If the child cannot sit with knees bent over the vehicle's seat cushion while the child's back is against the seatback, they should use a belt-positioning booster seat. The child and belt-positioning booster seat are held in the vehicle by the seat belt.

WARNING!

- Improper installation can lead to failure of an infant or child restraint. It could come loose in a collision. The child could be badly injured or killed. Follow the child restraint manufacturer's directions exactly when installing an infant or child restraint.
- After a child restraint is installed in the vehicle, do not move the vehicle seat forward or rearward because it can loosen the child restraint attachments. Remove the child restraint before adjusting the vehicle seat position. When the vehicle seat has been adjusted, reinstall the child restraint.
- When your child restraint is not in use, secure it in the vehicle with the seat belt or LATCH anchorages, or remove it from the vehicle. Do not leave it loose in the vehicle. In a sudden stop or accident, it could strike the occupants or seatbacks and cause serious personal injury.

Children Too Large For Booster Seats

Children who are large enough to wear the shoulder belt comfortably, and whose legs are long enough to bend over the front of the seat when their back is against the seatback, should use the seat belt in a rear seat. Use this simple 5-step test to decide whether the child can use the vehicle's seat belt alone:

1. Can the child sit all the way back against the back of the vehicle seat?
2. Do the child's knees bend comfortably over the front of the vehicle seat while the child is still sitting all the way back?
3. Does the shoulder belt cross the child's shoulder between the neck and arm?
4. Is the lap part of the belt as low as possible, touching the child's thighs and not the stomach?
5. Can the child stay seated like this for the whole trip?

If the answer to any of these questions was "no," then the child still needs to use a booster seat in this vehicle. If the child is using the lap/shoulder belt, check seat belt fit periodically and make sure the seat belt buckle is latched. A child's squirming or slouching can move the belt out of position. If the shoulder belt contacts the face or neck, move the child closer to the center of the vehicle, or use a booster seat to position the seat belt on the child correctly.

WARNING!

Never allow a child to put the shoulder belt under an arm or behind their back. In a crash, the shoulder belt will not protect a child properly, which may result in serious injury or death. A child must always wear both the lap and shoulder portions of the seat belt correctly.

Recommendations For Attaching Child Restraints

Restraint Type	Combined Weight of the Child + Child Restraint	Use Any Attachment Method Shown With An "X" Below			
		LATCH - Lower Anchors Only	Seat Belt Only	LATCH - Lower Anchors + Top Tether Anchor	Seat Belt + Top Tether Anchor
Rear-Facing Child Restraint	Up to 65 lb (29.5 kg)	X	X		
Rear-Facing Child Restraint	More than 65 lb (29.5 kg)		X		
Forward-Facing Child Restraint	Up to 65 lb (29.5 kg)			X	X
Forward-Facing Child Restraint	More than 65 lb (29.5 kg)				X

Lower Anchors And Tethers For Children (LATCH) Restraint System



022660173

LATCH Label

Your vehicle is equipped with the child restraint anchorage system called LATCH, which stands for Lower Anchors and Tethers for Children. The LATCH system has three vehicle anchor points for installing LATCH-equipped child seats. There are two lower anchorages located at the back of the seat cushion where it meets the seatback and one top tether anchorage located behind the seating position. These anchorages are used to install LATCH-equipped child seats without using the vehicle's seat belts. Some seating positions may have a top tether anchorage but no lower anchorages. In these seating positions, the seat belt must be used with the top tether anchorage to install the child restraint. Please see the following table for more information.

LATCH Positions For Installing Child Restraints In This Vehicle

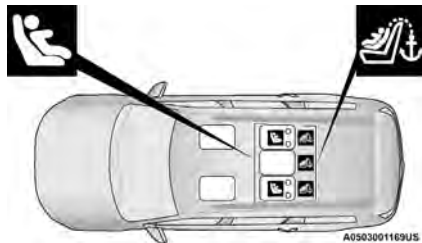

A0503001169US

Second Row LATCH Positions (Five Passenger)

 Lower Anchorage Symbol (2 Anchorages Per Seating Position)

 Top Tether Anchorage Symbol

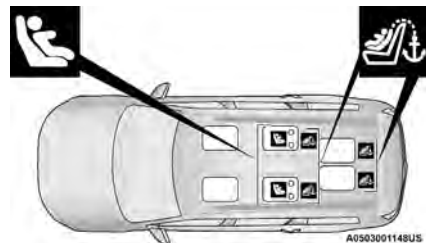

A0503001148US

Captain's Chairs Second Row LATCH Positions (Six Passenger)

 Lower Anchorage Symbol (2 Anchorages Per Seating Position)

 Top Tether Anchorage Symbol

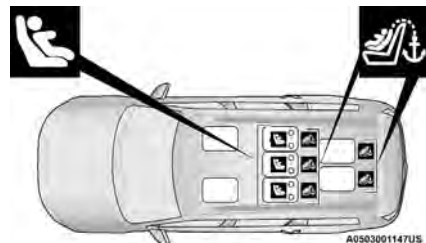

A0503001147US

60/40 Second Row LATCH Positions (Seven Passenger)

 Lower Anchorage Symbol (2 Anchorages Per Seating Position)

 Top Tether Anchorage Symbol

Frequently Asked Questions About Installing Child Restraints With LATCH		
What is the weight limit (child's weight + weight of the child restraint) for using the LATCH anchorage system to attach the child restraint?	65 lb (29.5 kg)	Use the LATCH anchorage system until the combined weight of the child and the child restraint is 65 lb (29.5 kg). Use the seat belt and tether anchor instead of the LATCH system once the combined weight is more than 65 lb (29.5 kg).
Can the LATCH anchorages and the seat belt be used together to attach a rear-facing or forward-facing child restraint?	No	Do not use the seat belt when you use the LATCH anchorage system to attach a rear-facing or forward-facing child restraint. Booster seats may be attached to the LATCH anchorages if allowed by the booster seat manufacturer. See your booster seat owner's manual for more information.
Can a child seat be installed in the center position using the inner LATCH lower anchorages from the outboard seating positions?	Five Passenger – No	Five Passenger – Use the seat belt and tether anchor to install a child seat in the center seating position. Seven Passenger – Use the provided lower anchorages in the second row center seating position.
Can two child restraints be attached using a common lower LATCH anchorage?	No	Never "share" a LATCH anchorage with two or more child restraints. If the center position does not have dedicated LATCH lower anchorages, use the seat belt to install a child seat in the center position next to a child seat using the LATCH anchorages in an outboard position.
Can the rear-facing child restraint touch the back of the front passenger seat?	Yes	The child seat may touch the back of the front passenger seat if the child restraint manufacturer also allows contact. See your child restraint owner's manual for more information.
Can the rear head restraints be removed?	No	

Locating The LATCH Anchorages



The lower anchorages are round bars that are found at the rear of the seat cushion where it meets the seatback. The anchorages are under a flap with the anchorage symbols on it. Pull the top of the flap away from the seatback to access the lower anchorages.

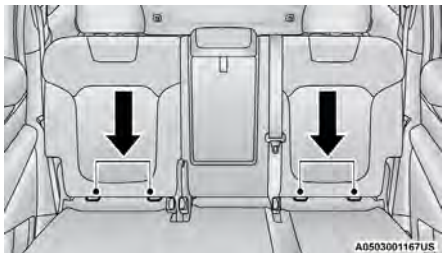

Five Passenger Second Row Lower Anchorages

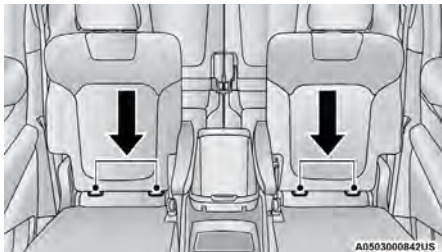

Six Passenger Second Row Lower Anchorages

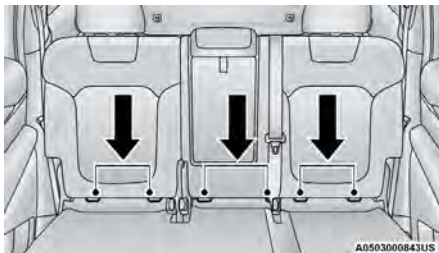

Seven Passenger Second Row Lower Anchorages

Locating The Upper Tether Anchorages



Five, Six, And Seven Passenger Vehicles:
Second Row Upper Tether Anchorage
Locations

There are tether strap anchorages behind each rear seating position located on the back of the seat.

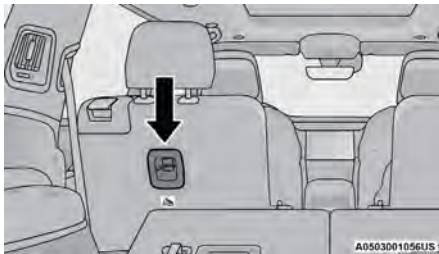

Six Passenger Top Tether Strap Anchorage (Captain's Chair)

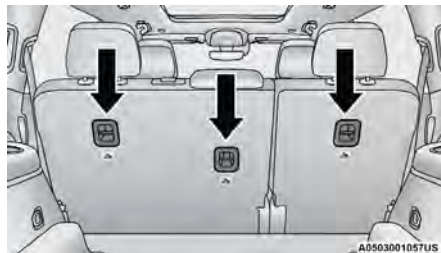

Five And Seven Passenger Top Tether Strap Anchorage (2nd Row Bench)

Six And Seven Passenger Vehicles: Third Row Upper Tether Anchorage Locations

There are tether strap anchorages behind each rear seating position located on the back of the seat. To access them, pull the carpeted floor panel away from the seat back, this will expose the top tether strap anchorages.



Pulling Down The Carpet Floor Panel To Access Top Tether Anchorage (3rd Row Bench)

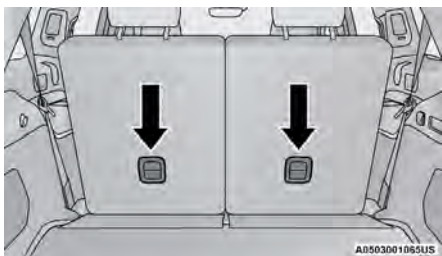

Tether Anchorages (3rd Row Bench)

LATCH-compatible child restraint systems will be equipped with a rigid bar or a flexible strap on each side. Each will have a hook or connector to attach to the lower anchorage and a way to tighten the connection to the anchorage. Forward-facing child restraints and some rear-facing child restraints will also be

equipped with a tether strap. The tether strap will have a hook at the end to attach to the top tether anchorage and a way to tighten the strap after it is attached to the anchorage.

Center Seat LATCH

Five Passenger Second Row Seating:

WARNING!

- Do not install a child restraint in the center position using the LATCH system. This position is not approved for installing child seats using the LATCH attachments. You must use the seat belt and tether anchor to install a child seat in the center seating position.
- Never use the same lower anchorage to attach more than one child restraint. For typical installation instructions, see ⇨ page 243.

Six Passenger Second Row Seating:

WARNING!

This vehicle does not have a center seating position. Do not use the center lower LATCH anchorages to install a child seat in the center of the back seat.

Seven Passenger Second Row Seating:

If a child restraint installed in the center position blocks the seat belt webbing or buckle for the outboard position, do not use that outboard position. If a child seat in the center position blocks the outboard LATCH anchors or seat belt, do not install a child seat in that outboard position.

WARNING!

Never use the same lower anchorage to attach more than one child restraint. For typical installation instructions, see ⇨ page 243.

Always follow the directions of the child restraint manufacturer when installing your child restraint. Not all child restraint systems will be installed as described here.

To Install A LATCH-Compatible Child Restraint

If the selected seating position has a Switchable Automatic Locking Retractor (ALR) seat belt, stow the seat belt, following the instructions below. See ⇨ page 240 to check what type of seat belt each seating position has.

1. Loosen the adjusters on the lower straps and on the tether strap of the child seat so that you can more easily attach the hooks or connectors to the vehicle anchorages.
2. Place the child seat between the lower anchorages for that seating position. If the second row seat can be reclined, you may recline the seat and/or raise the head restraint (if adjustable) to get a better fit. If the rear seat can be moved forward and rearward in the vehicle, you may wish to move it to its rear-most position to make room for the child seat. You may also move the front seat forward to allow more room for the child seat.
3. Attach the lower hooks or connectors of the child restraint to the lower anchorages in the selected seating position.

- If the child restraint has a tether strap, connect it to the top tether anchorage. See  page 246 for directions to attach a tether anchor.
- Tighten all of the straps as you push the child restraint rearward and downward into the seat. Remove slack in the straps according to the child restraint manufacturer's instructions.
- Test that the child restraint is installed tightly by pulling back and forth on the child seat at the belt path. It should not move more than 1 inch (25.4 mm) in any direction.

How To Stow An Unused Switchable-ALR (ALR) Seat Belt:

When using the LATCH attaching system to install a child restraint, stow all ALR seat belts that are not being used by other occupants or being used to secure child restraints. An unused belt could injure a child if they play with it and accidentally lock the seat belt retractor. Before installing a child restraint using the LATCH system, buckle the seat belt behind the child restraint and out of the child's reach. If the buckled seat belt interferes with the child restraint installation, instead of buckling it behind the child restraint, route the seat belt through the child restraint belt path and then buckle it. Do not lock the seat belt. Remind all children in the vehicle that the seat belts are not toys and that they should not play with them.

WARNING!

- Improper installation of a child restraint to the LATCH anchorages can lead to failure of the restraint. The child could be badly injured or killed. Follow the child restraint manufacturer's directions exactly when installing an infant or child restraint.
- Child restraint anchorages are designed to withstand only those loads imposed by correctly-fitted child restraints. Under no circumstances are they to be used for adult seat belts, harnesses, or for attaching other items or equipment to the vehicle.

Installing Child Restraints Using The Vehicle Seat Belt

Child restraint systems are designed to be secured in vehicle seats by lap belts or the lap belt portion of a lap/shoulder belt.

WARNING!

- Improper installation or failure to properly secure a child restraint can lead to failure of the restraint. The child could be badly injured or killed.
- Follow the child restraint manufacturer's directions exactly when installing an infant or child restraint.

The seat belts in the passenger seating positions are equipped with a Switchable Automatic Locking Retractor (ALR) that is designed to keep the lap portion of the seat belt tight around the child restraint so that it is not necessary to use a locking clip. The ALR retractor can be "switched" into a locked mode by pulling all of the webbing out of the retractor and then letting the web-

bing retract back into the retractor. If it is locked, the ALR will make a clicking noise while the webbing is pulled back into the retractor.

Refer to the "Automatic Locking Mode" description on  page 226 for additional information on ALR.

Please see the table below and the following sections for more information.

Lap/Shoulder Belt Systems For Installing Child Restraints In This Vehicle

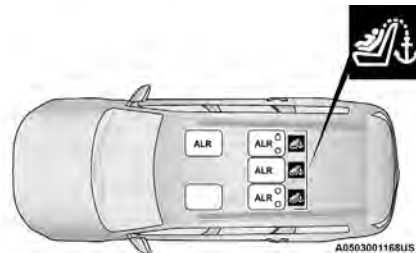

Five Passenger Automatic Locking Retractor (ALR) Locations

ALR — Switchable Automatic Locking Retractor
 Top Tether Anchorage Symbol

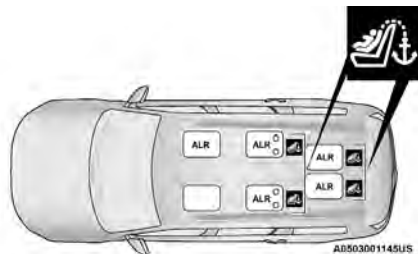

Captain's Chairs Second Row (Six Passenger) Automatic Locking Retractor (ALR) Locations

ALR — Switchable Automatic Locking Retractor
 Top Tether Anchorage Symbol

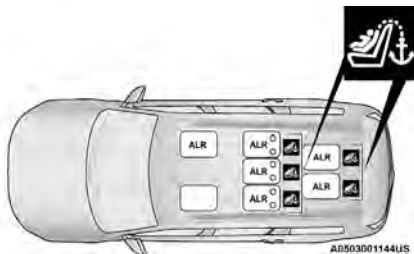

60/40 Second Row (Seven Passenger) Automatic Locking Retractor (ALR) Locations

ALR — Switchable Automatic Locking Retractor
 Top Tether Anchorage Symbol

Frequently Asked Questions About Installing Child Restraints With Seat Belts

What is the weight limit (child's weight + weight of the child restraint) for using the Tether Anchor with the seat belt to attach a forward-facing child restraint?	Weight limit of the Child Restraint	Always use the tether anchor when using the seat belt to install a forward-facing child restraint, up to the recommended weight limit of the child restraint.
Can the rear-facing child restraint touch the back of the front passenger seat?	Yes	Contact between the front passenger seat and the child restraint is allowed, if the child restraint manufacturer also allows contact.
Can the rear head restraints be removed?	No	
Can the buckle stalk be twisted to tighten the seat belt against the belt path of the child restraint?	No	Do not twist the buckle stalk in a seating position with an ALR retractor.

Installing A Child Restraint With A Switchable Automatic Locking Retractor (ALR):

Child restraint systems are designed to be secured in vehicle seats by lap belts or the lap belt portion of a lap/shoulder belt.

WARNING!

- Improper installation or failure to properly secure a child restraint can lead to failure of the restraint. The child could be badly injured or killed.
- Follow the child restraint manufacturer's directions exactly when installing an infant or child restraint.

1. Place the child seat in the center of the seating position. If the second row seat can be reclined, you may recline the seat and/or raise the head restraint (if adjustable) to get a better fit. If the rear seat can be moved forward and rearward in the vehicle, you may wish to move it to its rear-most position to make room for the child seat. You may also move the front seat forward to allow more room for the child seat.
2. Pull enough of the seat belt webbing from the retractor to pass it through the belt path of the child restraint. Do not twist the belt webbing in the belt path.
3. Slide the latch plate into the buckle until you hear a "click."
4. Pull on the webbing to make the lap portion tight against the child seat.
5. To lock the seat belt, pull down on the shoulder part of the belt until you have pulled all the seat belt webbing out of the retractor. Then, allow the webbing to retract back into the retractor. As the webbing retracts, you will hear a clicking sound. This means the seat belt is now in the Automatic Locking mode.
6. Try to pull the webbing out of the retractor. If it is locked, you should not be able to pull out any webbing. If the retractor is not locked, repeat step 5.
7. Finally, pull up on any excess webbing to tighten the lap portion around the child restraint while you push the child restraint rearward and downward into the vehicle seat.
8. If the child restraint has a top tether strap and the seating position has a top tether anchorage, connect the tether strap to the anchorage and tighten the tether strap. See ⇨ page 246 for directions to attach a tether anchor.
9. Test that the child restraint is installed tightly by pulling back and forth on the child seat at the belt path. It should not move more than 1 inch (25.4 mm) in any direction.

Any seat belt system will loosen with time, so check the belt occasionally, and pull it tight if necessary.

Installing Child Restraints Using The Top Tether Anchorage

WARNING!

Do not attach a tether strap for a rear-facing car seat to any location in front of the car seat, including the seat frame or a tether anchorage. Only attach the tether strap of a rear-facing car seat to the tether anchorage that is approved for that seating position, located behind the top of the vehicle seat. See ⇨ page 240 for the location of approved tether anchorages in your vehicle.



Five Passenger

1. Look behind the seating position where you plan to install the child restraint to find the tether anchorage. If the seat can be moved, you may need to move the seat forward to provide better access to the tether anchorage. If there is no top tether anchorage for that seating position, move the child restraint to another position in the vehicle if one is available.

- Route the tether strap to provide the most direct path for the strap between the anchor and the child seat. If your vehicle is equipped with adjustable rear head restraints, raise the head restraint, and where possible, route the tether strap under the head restraint and between the two posts. If not possible, lower the head restraint and pass the tether strap around the outboard side of the head restraint.
- Attach the tether strap hook of the child restraint to the top tether anchorage as shown in the diagram.

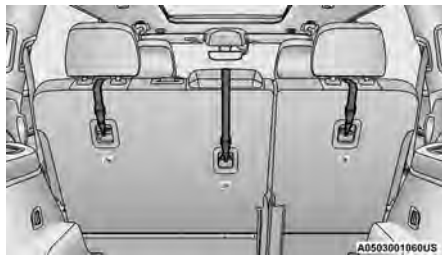

Second Row Bench Seat Top Tether Strap Mounting (Five And Seven Passenger Seating)

- Remove slack in the tether strap according to the child restraint manufacturer's instructions.

WARNING!

- An incorrectly anchored tether strap could lead to increased head motion and possible injury to the child. Use only the anchorage position directly behind the child seat to secure a child restraint top tether strap.

(Continued)

WARNING!

- If your vehicle is equipped with a split rear seat, make sure the tether strap does not slip into the opening between the seatbacks as you remove slack in the strap.

Six And Seven Passenger

- Look behind the seating position where you plan to install the child restraint to find the tether anchorage. You may need to move the seat forward to provide better access to the tether anchorage. If there is no top tether anchorage for that seating position, move the child restraint to another position in the vehicle if one is available.
- To access the top tether strap anchorages behind the rear seat, pull the carpeted floor panel away from the seat back, this will expose the top tether strap anchorages.



Pulling Down The Carpet Floor Panel To Access Top Tether Strap Anchorage (3rd Row Bench)

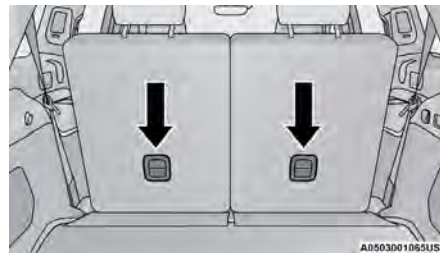

Third Row Top Tether Strap Anchorage (Located On Seatback)

- Route the tether strap to provide the most direct path for the strap between the anchor and the child seat. If your vehicle is equipped with adjustable rear head restraints, raise the head restraint, and where possible, route the tether strap under the head restraint and between the two posts. If not possible, lower the head restraint and pass the tether strap around the outboard side of the head restraint.
- For the center seating position, route the tether strap over the seatback and headrest then attach the hook to the tether anchor located on the back of the seat.
- Attach the tether strap hook of the child restraint to the top tether anchorage as shown in the diagram.

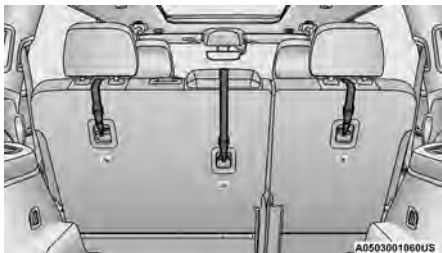

Second Row Bench Seat Top Tether Strap Mounting (Five And Seven Passenger Seating)

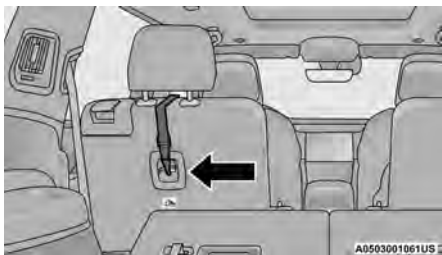

Captain's Chair Top Tether Strap Mounting (Six Passenger)

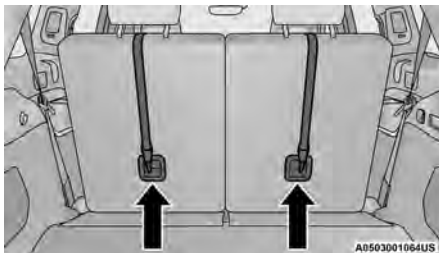

Third Row Seating Top Tether Strap Mounting

- Remove slack in the tether strap according to the child restraint manufacturer's instructions.

WARNING!

- The top tether anchorages are not visible until the gap panel is folded down. Do not use the visible cargo tie down hooks, located on the floor behind the seats, to attach a child restraint tether anchor.
- An incorrectly anchored tether strap could lead to increased head motion and possible injury to the child. Use only the anchorage position directly behind the child seat to secure a child restraint top tether strap.
- If your vehicle is equipped with a split rear seat, make sure the tether strap does not slip into the opening between the seatbacks as you remove slack in the strap.

SAFETY TIPS

TRANSPORTING PASSENGERS

NEVER TRANSPORT PASSENGERS IN THE CARGO AREA.

WARNING!

- Do not leave children or animals inside parked vehicles in hot weather. Interior heat buildup may cause serious injury or death.
- It is extremely dangerous to ride in a cargo area, inside or outside of a vehicle. In a collision, people riding in these areas are more likely to be seriously injured or killed.
- Do not allow people to ride in any area of your vehicle that is not equipped with seats and seat belts.
- Be sure everyone in your vehicle is in a seat and using a seat belt properly.

TRANSPORTING PETS

Air Bags deploying in the front seat could harm your pet. An unrestrained pet will be thrown about and possibly injured, or injure a passenger during panic braking or in a collision.

Pets should be restrained in the rear seat (if equipped) in pet harnesses or pet carriers that are secured by seat belts.

CONNECTED VEHICLES

Privacy of any wireless and wired communications cannot be assured. Third parties may unlawfully intercept information and private communications without your consent. For further information, refer to "Data Collection & Privacy" in your Uconnect Radio Instruction Manual or "Onboard Diagnostic System (OBD II) Cybersecurity" ↪ page 101.

WARNING!

It is not possible to know or to predict all of the possible outcomes if your vehicle's systems are breached. It may be possible that vehicle systems, including safety related systems, could be impaired or a loss of vehicle control could occur that may result in an accident involving serious injury or death.

SAFETY CHECKS YOU SHOULD MAKE INSIDE THE VEHICLE

Seat Belts

Inspect the seat belt system periodically, checking for cuts, frays, and loose parts. Damaged parts must be replaced immediately. Do not disassemble or modify the system.

If your vehicle is involved in a collision, or if you have questions regarding the seat belt or retractor conditions, take your vehicle to an authorized FCA dealer or authorized FCA Certified Collision Care Program facility for inspection.

Air Bag Warning Light



The Air Bag Warning Light will turn on for four to eight seconds as a bulb check when the ignition switch is first placed in the ON/RUN position. If the light is either not on during starting, stays on, or turns on while driving, have the system inspected at an authorized dealer as soon as possible. After the bulb check, this light will illuminate with a single chime when a fault with the Air Bag System has been detected. It will stay on until the fault is removed. If the light comes on intermittently or remains on while driving, have an authorized dealer service the vehicle immediately ↪ page 228.

Defroster

Check operation by selecting the defrost mode and place the blower control on high speed. You should be able to feel the air directed against the windshield. See an authorized dealer for service if your defroster is inoperable.



Floor Mat Safety Information

Always use floor mats designed to fit your vehicle. Only use a floor mat that does not interfere with the operation of the accelerator, brake or clutch pedals. Only use a floor mat that is securely attached using the floor mat fasteners so it cannot slip out of position and interfere with the accelerator, brake or clutch pedals or impair safe operation of your vehicle in other ways.

WARNING!

An improperly attached, damaged, folded, or stacked floor mat, or damaged floor mat fasteners may cause your floor mat to interfere with the accelerator, brake, or clutch pedals and cause a loss of vehicle control.

To prevent SERIOUS INJURY or DEATH:

- ALWAYS securely attach your floor mat using the floor mat fasteners. DO NOT install your floor mat upside down or turn your floor mat over. Lightly pull to confirm mat is secured using the floor mat fasteners on a regular basis. 
- ALWAYS REMOVE THE EXISTING FLOOR MAT FROM THE VEHICLE before installing any other floor mat. NEVER install or stack an additional floor mat on top of an existing floor mat. 
- ONLY install floor mats designed to fit your vehicle. NEVER install a floor mat that cannot be properly attached and secured to your vehicle. If a floor mat needs to be replaced, only use a FCA approved floor mat for the specific make, model, and year of your vehicle.
- ONLY use the driver's side floor mat on the driver's side floor area. To check for interference, with the vehicle properly parked with the engine off, fully depress the accelerator, the brake, and the clutch pedal (if present) to check for interference. If your floor mat interferes with the operation of any pedal, or is not secure to the floor, remove the floor mat from the vehicle and place the floor mat in your trunk.

(Continued)

WARNING!

- ONLY use the passenger's side floor mat on the passenger's side floor area.
- ALWAYS make sure objects cannot fall or slide into the driver's side floor area when the vehicle is moving. Objects can become trapped under accelerator, brake, or clutch pedals and could cause a loss of vehicle control.
- NEVER place any objects under the floor mat (e.g., towels, keys, etc.). These objects could change the position of the floor mat and may cause interference with the accelerator, brake, or clutch pedals.
- If the vehicle carpet has been removed and re-installed, always properly attach carpet to the floor and check the floor mat fasteners are secure to the vehicle carpet. Fully depress each pedal to check for interference with the accelerator, brake, or clutch pedals then re-install the floor mats.
- It is recommended to only use mild soap and water to clean your floor mats. After cleaning, always check your floor mat has been properly installed and is secured to your vehicle using the floor mat fasteners by lightly pulling mat.

PERIODIC SAFETY CHECKS YOU SHOULD MAKE OUTSIDE THE VEHICLE

Tires

Examine tires for excessive tread wear and uneven wear patterns. Check for stones, nails, glass, or other objects lodged in the tread or sidewall. Inspect the tread for cuts and cracks. Inspect sidewalls for cuts, cracks, and bulges. Check the lug nut/bolt torque for tightness. Check the tires (including spare) for proper cold inflation pressure.

Lights

Have someone observe the operation of brake lights and exterior lights while you work the controls. Check turn signal and high beam indicator lights on the instrument panel.

Door Latches

Check for proper closing, latching, and locking.

Fluid Leaks

Check area under the vehicle after overnight parking for fuel, coolant, oil, or other fluid leaks. Also, if gasoline fumes are detected or if fuel or brake fluid leaks are suspected, the cause should be located and corrected immediately.

EXHAUST GAS

WARNING!

Exhaust gases can injure or kill. They contain carbon monoxide (CO), which is colorless and odorless. Breathing it can make you unconscious and can eventually poison you. To avoid breathing (CO), follow these safety tips:

- Do not run the engine in a closed garage or in confined areas any longer than needed to move your vehicle in or out of the area.
- If you are required to drive with the trunk/liftgate/rear doors open, make sure that all windows are closed and the climate control BLOWER switch is set at high speed. DO NOT use the recirculation mode.
- If it is necessary to sit in a parked vehicle with the engine running, adjust your heating or cooling controls to force outside air into the vehicle. Set the blower at high speed.

The best protection against carbon monoxide entry into the vehicle body is a properly maintained engine exhaust system.

Whenever a change is noticed in the sound of the exhaust system, when exhaust fumes can be detected inside the vehicle, or when the underside or rear of the vehicle is damaged, have an authorized dealer inspect the complete exhaust system and adjacent body areas for broken, damaged, deteriorated, or mispositioned parts. Open seams or loose connections could permit exhaust fumes to seep into the passenger compartment. In addition, inspect the exhaust system each time the vehicle is raised for lubrication or oil change. Replace as required.

CARBON MONOXIDE WARNINGS

WARNING!

Carbon monoxide (CO) in exhaust gases is deadly. Follow the precautions provided to prevent carbon monoxide poisoning:

- Do not inhale exhaust gases. They contain carbon monoxide, a colorless and odorless gas, which can kill. Never run the engine in a closed area, such as a garage, and never sit in a parked vehicle with the engine running for an extended period. If the vehicle is stopped in an open area with the engine running for more than a short period, adjust the ventilation system to force fresh, outside air into the vehicle.
- Guard against carbon monoxide with proper maintenance. Have the exhaust system inspected every time the vehicle is raised. Have any abnormal conditions repaired promptly. Until repaired, drive with all side windows fully open.
- When exiting the vehicle, always make sure the ignition is in the OFF position, remove the key fob from the vehicle and lock your vehicle.

IN CASE OF EMERGENCY

HAZARD WARNING FLASHERS

The Hazard Warning Flashers button is located on the switch bank just above the radio screen.



Hazard Warning Flashers Button

Push the button to turn on the Hazard Warning Flashers. When the button is activated, all directional turn signals will flash on and off to warn oncoming traffic of an emergency. Push the switch a second time to turn off the Hazard Warning Flashers.

This is an emergency warning system and it should not be used when the vehicle is in motion. Use it only when your vehicle is disabled or signaling a safety hazard warning for other motorists.

When you must leave the vehicle to seek assistance, the Hazard Warning Flashers will continue to operate even though the ignition is placed in the OFF position.

NOTE:

With extended use, the Hazard Warning Flashers may discharge the battery.

ASSIST AND SOS SYSTEM — IF EQUIPPED



ASSIST And SOS Buttons

- 1 — ASSIST Button
2 — SOS Button

If equipped, the overhead console contains an ASSIST and SOS button.

WARNING!

ALWAYS obey traffic laws and pay attention to the road. ALWAYS drive safely with your hands on the steering wheel. You have full responsibility and assume all risks related to the use of the features and applications in this vehicle. Only use the features and applications when it is safe to do so. Failure to do so may result in an accident involving serious injury or death.

NOTE:

- Your vehicle may be transmitting data as authorized by the subscriber → page 331.
- The ASSIST and SOS buttons will only function if you are connected to an operable LTE (voice/data) or 4G (data) network, which comes as a built-in function. Other Jeep® Connect services will only be operable if you are connected to an operable LTE (voice/data) or 4G (data) network.

ASSIST Call

The ASSIST button is used to automatically connect you to any one of the following support centers:

- Roadside Assistance – If you get a flat tire, or need a tow, just push the ASSIST button and you will be connected to a representative for assistance. Roadside Assistance will know what vehicle you're driving and its location. Additional fees may apply for roadside assistance.

- Vehicle Customer Care – Total support for all other vehicle issues.
- Jeep® Connect Customer Care – Total support for Radio, Phone and NAV issues.

SOS Call

1. Push the SOS Call button on the overhead console.

NOTE:

In case the SOS Call button is pushed in error, there will be a 10 second delay before the SOS Call system initiates a call to an SOS operator. To cancel the SOS Call connection, push the SOS Call button on the overhead console or press the cancellation button on the Device Screen. Termination of the SOS Call will turn off the green LED light on the overhead console.

2. The LED light located within the ASSIST and SOS buttons on the overhead console will turn green once a connection to an SOS operator has been made.
3. Once a connection between the vehicle and an SOS operator is made, the SOS Call system may transmit the following important vehicle information to a SOS operator:
 - Indication that the occupant placed an SOS Call
 - The vehicle brand
 - The last known GPS coordinates of the vehicle
4. You should be able to speak with the SOS operator through the vehicle audio system to determine if additional assistance is needed.

WARNING!

ALWAYS obey traffic laws and pay attention to the road. ALWAYS drive safely with your hands on the steering wheel. You have full responsibility and assume all risks related to the use of the features and applications in this vehicle. Only use the features and applications when it is safe to do so. Failure to do so may result in an accident involving serious injury or death.

NOTE:

Once a connection is made between the vehicle's SOS Call system and the SOS operator, the SOS operator may be able to open a voice connection with the vehicle to determine if additional assistance is needed. Once the SOS operator opens a voice connection with the vehicle's SOS Call system, the operator should be able to speak with you or other vehicle occupants and hear sounds occurring in the vehicle. The vehicle's SOS Call system will attempt to remain connected with the SOS operator until the SOS operator terminates the connection.

5. The SOS operator may attempt to contact appropriate emergency responders and provide them with important vehicle information and GPS coordinates.

WARNING!

- If anyone in the vehicle could be in danger (e.g., fire or smoke is visible, dangerous road conditions or location), do not wait for voice contact from an Emergency Services Agent. All occupants should exit the vehicle immediately and move to a safe location.
- Never place anything on or near the vehicle's operable network and GPS antennas. You could prevent operable network and GPS signal reception, which can prevent your vehicle from placing an emergency call. An operable network and GPS signal reception is required for the SOS Call system to function properly.
- The SOS Call system is embedded into the vehicle's electrical system. Do not add aftermarket electrical equipment to the vehicle's electrical system. This may prevent your vehicle from sending a signal to initiate an emergency call. To avoid interference that can cause the SOS Call system to fail, never add aftermarket equipment (e.g., two-way mobile radio, CB radio, data recorder, etc.) to your vehicle's electrical system or modify the antennas on your vehicle. IF YOUR VEHICLE LOSES BATTERY POWER FOR ANY REASON (INCLUDING DURING OR AFTER AN ACCIDENT), THE JEEP® CONNECT FEATURES, APPS AND SERVICES, AMONG OTHERS, WILL NOT OPERATE.
- Modifications to any part of the SOS Call system could cause the air bag system to fail when you need it. You could be injured if the air bag system is not there to help protect you.

SOS Call System Limitations

Vehicles sold in Mexico **DO NOT** have SOS Call system capabilities.

SOS or other emergency line operators in Mexico may not answer or respond to SOS system calls.

If the SOS Call system detects a malfunction, any of the following may occur at the time the malfunction is detected, and at the beginning of each ignition cycle:

- The overhead console lights located within the ASSIST and SOS buttons will continuously illuminate red.
- The Device Screen will display the following message “Vehicle device requires service. Please contact an authorized dealer.”
- An In-Vehicle Audio message will state “Vehicle device requires service. Please contact an authorized dealer.”

WARNING!

- Ignoring the overhead console light could mean you will not have SOS Call services. If the overhead console light is illuminated, have an authorized dealer service the SOS Call system immediately.
- The Occupant Restraint Control module turns on the Air Bag Warning Light on the instrument panel if a malfunction in any part of the system is detected. If the Air Bag Warning Light is illuminated, have an authorized dealer service the Occupant Restraint Control system immediately.

Even if the SOS Call system is fully functional, factors beyond FCA US LLC’s control may prevent or stop the SOS Call system operation. These include, but are not limited to, the following factors:

- The ignition is in the OFF position
- The vehicle’s electrical systems are not intact
- The SOS Call system software and/or hardware are damaged during a crash
- The vehicle battery loses power or becomes disconnected during a vehicle crash
- LTE (voice/data) or 4G (data) network and/or Global Positioning Satellite signals are unavailable or obstructed
- Equipment malfunction at the SOS operator facility
- Operator error by the SOS operator
- LTE (voice/data) or 4G (data) network congestion
- Weather
- Buildings, structures, geographic terrain, or tunnels

WARNING!

ALWAYS obey traffic laws and pay attention to the road. ALWAYS drive safely with your hands on the steering wheel. You have full responsibility and assume all risks related to the use of the features and applications in this vehicle. Only use the features and applications when it is safe to do so. Failure to do so may result in an accident involving serious injury or death.

NOTE:

- Never place anything on or near the vehicle’s LTE (voice/data) or 4G (data) and GPS antennas. You could prevent LTE (voice/data) or 4G (data) and GPS signal reception, which can prevent your vehicle from placing an emergency call. An operable LTE (voice/data) or 4G (data) network connection and a GPS signal is required for the SOS Call system to function properly.

NOTE:

Changes or modifications not expressly approved by the party responsible for compliance could void the user’s authority to operate the equipment.

CAUTION!

To avoid damage to the mirror during cleaning, never spray any cleaning solution directly onto the mirror. Apply the solution onto a clean cloth and wipe the mirror clean.

Automatic SOS — If Equipped

Automatic SOS is a hands-free safety service that can immediately connect you with help in the event that your vehicle’s airbags deploy. Please refer to your provided radio supplement for complete information.

JACKING AND TIRE CHANGING

Use this QR code to access your digital experience.



WARNING!

- Do not attempt to change a tire on the side of the vehicle close to moving traffic. Pull far enough off the road to avoid the danger of being hit when operating the jack or changing the wheel.
- Being under a jacked-up vehicle is dangerous. The vehicle could slip off the jack and fall on you. You could be crushed. Never put any part of your body under a vehicle that is on a jack. If you need to get under a raised vehicle, take it to a service center where it can be raised on a lift.
- Never start or run the engine while the vehicle is on a jack.
- The jack is designed to be used as a tool for changing tires only. The jack should not be used to lift the vehicle for service purposes. The vehicle should be jacked on a firm level surface only. Avoid ice or slippery areas.

NOTE:

If your vehicle is equipped with an air suspension system, there is a feature which allows the automatic leveling to be disabled before changing a tire. This feature can be activated through the Uconnect system ↪ page 118.

NOTE:

Before changing a tire or using the jack please disable the hands free lift gate, This feature can be disabled through the Uconnect system ↪ page 181.

PREPARATIONS FOR JACKING

1. Park the vehicle on a firm, level surface as far from the edge of the roadway as possible. Avoid icy or slippery areas.

WARNING!

Do not attempt to change a tire on the side of the vehicle close to moving traffic. Pull far enough off the road to avoid being hit when operating the jack or changing the wheel.

2. Turn on the Hazard Warning Flashers.
3. Apply the parking brake.
4. Place the gear selector into PARK (P).
5. Turn OFF the ignition.
6. Block both front and rear of the wheel diagonally opposite of the jacking position. For example, if changing the left front wheel, block the right rear wheel.

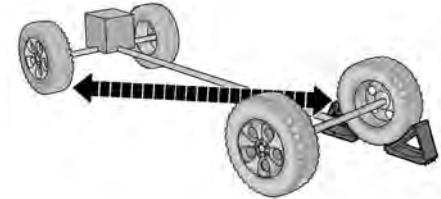

A0797001133U5

Wheel Blocked Example

NOTE:

Passengers should not remain in the vehicle when the vehicle is being raised or lifted.

JACK LOCATION

The scissor-type jack and tire changing tools are located in the rear cargo area, under the load floor.

NOTE:

Depending on the vehicle's trim level, the jacking tool locations vary from second and third row seating.

1. Locate and lift up on the load floor handle.

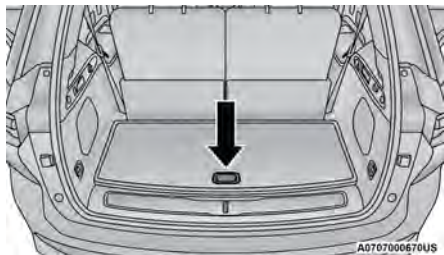

Load Floor Handle

2. Access the jack and tool storage.

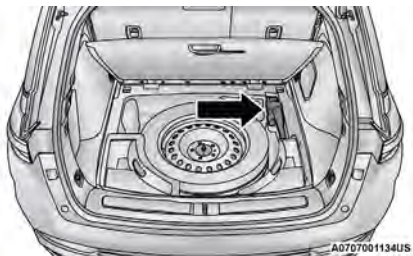

Jack Storage Location (Second Row Seating)



Jack Storage Location (Third Row Seating Without Air Suspension)

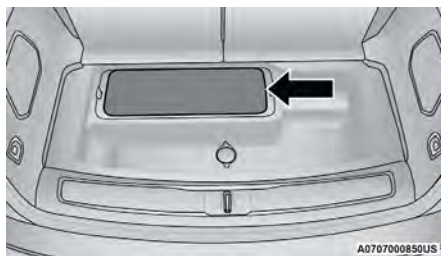

Jack Storage Location (Third Row Seating With Air Suspension)

3. Remove the jack storage cover. To remove, firmly press the two side tabs inward while lifting up or out.

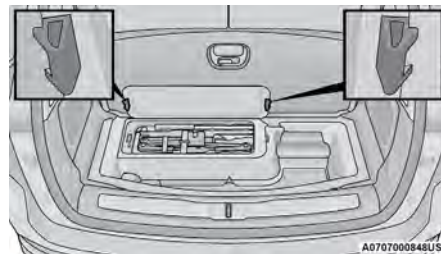

Jack Storage Cover Tabs

4. Release the Velcro straps and pull outward or up on the jack and tools to remove.

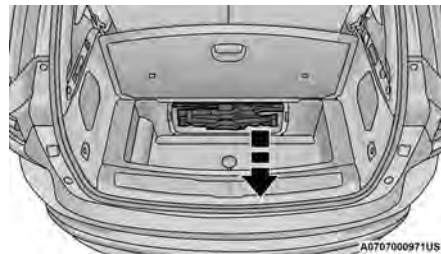

Jack Removal (Third Row Seating Without Air Suspension)

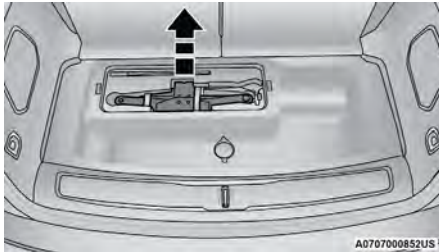

Jack Removal (Third Row Seating With Air Suspension)

5. Jack And Tools Description

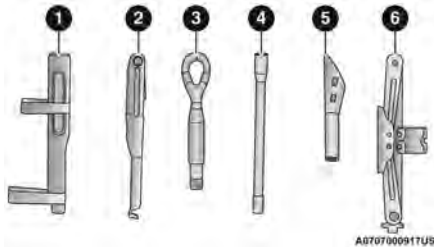

Jack And Tools

- 1 – Jack Tool Bag
- 2 – Lug Nut Wrench
- 3 – Tow Hook (If Equipped)
- 4 – Jack Handle Extension (If Equipped)
- 5 – Fuel Funnel
- 6 – Scissor Jack

SPARE TIRE STOWAGE

NOTE:

Depending on the vehicle's trim level, spare tire locations vary from second and third row seating.

Second Row Seating – If Equipped

For vehicles equipped with second row seating, the spare tire is located in the rear cargo area under the load floor.

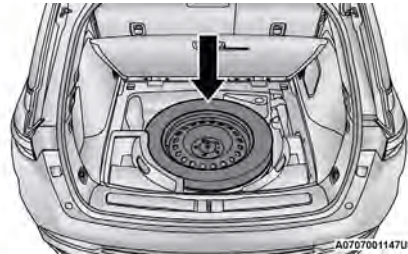

Spare Tire Location (Second Row Seating)

Third Row Seating – If Equipped

For vehicles equipped with third row seating, the spare tire is stowed under the rear of the vehicle by means of a cable winch mechanism. To remove or stow the spare, use the jack handle/lug wrench connected to the square socket extension to rotate the "spare tire drive" nut. The nut is located under a plastic cover at the center-rear of the cargo floor area, just inside the liftgate opening.

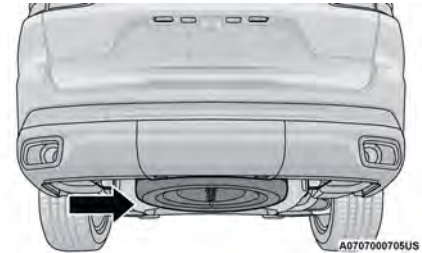

Spare Tire Location (Third Row Seating)

CAUTION!

The winch mechanism is designed for use with the jack wrench extension tool only. Use of air wrench or power tool may damage the winch.

SPARE TIRE REMOVAL

Remove the spare tire before attempting to jack up the vehicle.

NOTE:

Depending on the vehicle's trim level, the procedure for spare tire removal varies for second and third row seating.

Second Row Seating — If Equipped

1. Lift up on the rear load floor to access the spare tire. Remove the fastener securing the spare tire, and remove the spare tire from the vehicle.

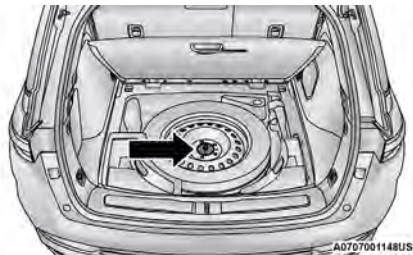

Spare Tire Fastener

2. Remove the spare tire fastener by rotating it counterclockwise.

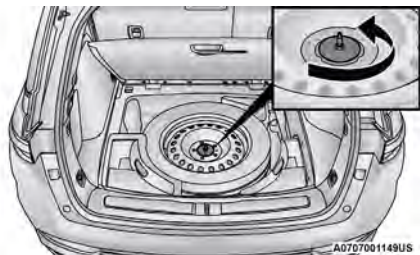

Removing The Spare Tire Fastener

3. After removing the fastener, pull the spare tire up away from the fastener pin and out of the vehicle.

Third Row Seating — If Equipped

1. Lift up on the rear load floor to access the spare tire winch plug. Locate and remove plug from the storage compartment floor to expose the winch access hole.

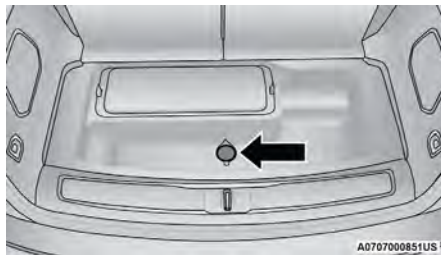

Winch Nut Plug

2. Fit the jack handle extension over the winch drive nut. Use the lug wrench handle and extension to completely lower the spare tire. Keep turning the handle counterclockwise until the winch stops.

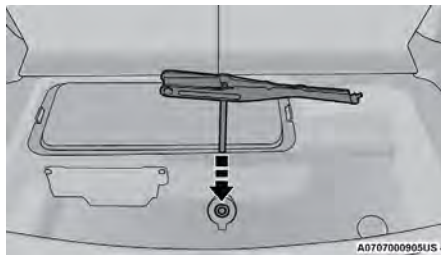

Winch Drive Nut Location

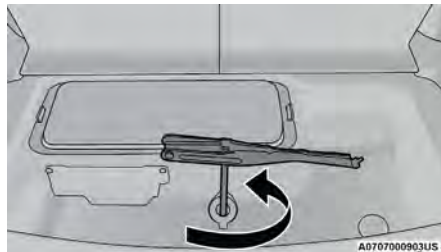

Wrench Rotation

3. Slide the tire out from under the vehicle and rotate it vertically behind the rear fascia/bumper.
4. Pull the metal retainer toward you to release it.

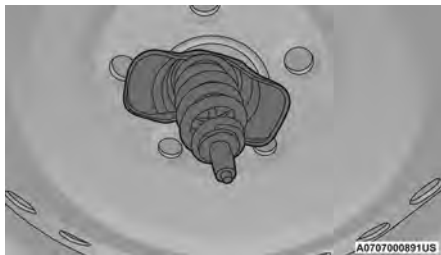

Spare Tire Retainer

5. Slide the retainer up the steel extension tube and winch cable. Rotate the retainer and push it through the hole in the wheel.

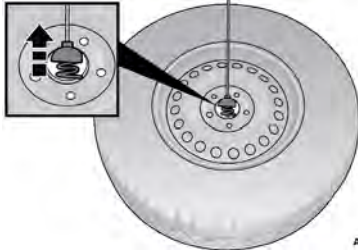

A0707000980US

Releasing The Retainer

JACKING INSTRUCTIONS

WARNING!

Carefully follow these tire changing warnings to help prevent personal injury or damage to your vehicle:

- Always park on a firm, level surface as far from the edge of the roadway as possible before raising the vehicle.
- Turn on the Hazard Warning Flashers.
- Apply the parking brake firmly and set the transmission in PARK.
- Block the wheel diagonally opposite the wheel to be raised.
- Never start or run the engine with the vehicle on a jack.

(Continued)

WARNING!

- Do not let anyone sit in the vehicle when it is on a jack.
- Do not get under the vehicle when it is on a jack. If you need to get under a raised vehicle, take it to a service center where it can be raised on a lift.
- Only use the jack in the positions indicated and for lifting this vehicle during a tire change.
- If working on or near a roadway, be extremely careful of motor traffic.
- To assure that spare tires, flat or inflated, are securely stowed, spares must be stowed with the valve stem facing the ground.



060600714

Jack Warning Label

CAUTION!

Do not attempt to raise the vehicle by jacking on locations other than those indicated in the Jacking Instructions for this vehicle.

1. Loosen (but do not remove) the wheel lug nuts, using the lug wrench by turning them counterclockwise, one turn, while the wheel is still on the ground.

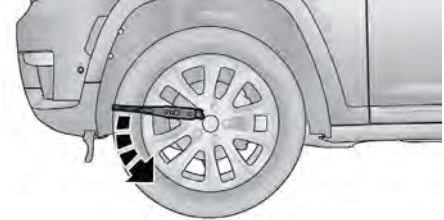

A0707001146US

Loosen Lug Nuts

2. Assemble the jack and jacking tools ⇨ page 255.

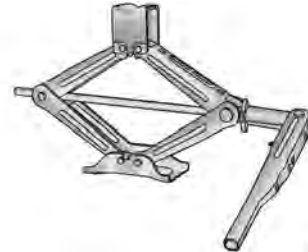

A0707001145US

Jack And Tools Assembled

NOTE:

Proper placement for the front and rear jacking locations is critical. See the following images for proper jacking locations.

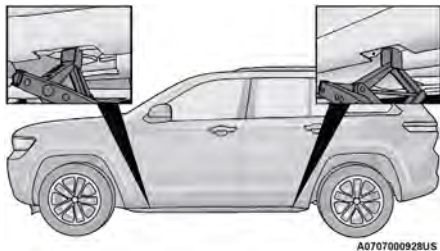

Jacking Locations

3. For the front axle, place the jack on the body flange just behind the front tire as indicated by the triangular lift point symbol on the sill molding. **Do not raise the vehicle until you are sure the jack is fully engaged.**

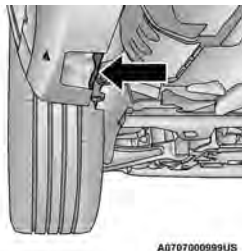

Front Lifting Point

NOTE:

The jack must be placed straight on with handle facing outwards.

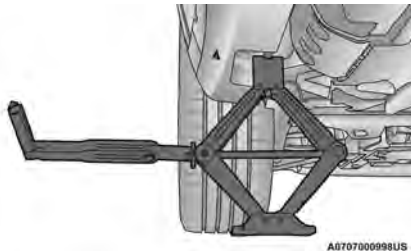

Front Jacking Location

4. For a rear tire, place the jack in the slot on the rear tie-down bracket, just forward of the rear tire (as indicated by the triangular lift point symbol on the sill molding). **Do not raise the vehicle until you are sure the jack is fully engaged.**

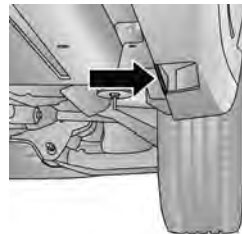

Rear Lifting Point

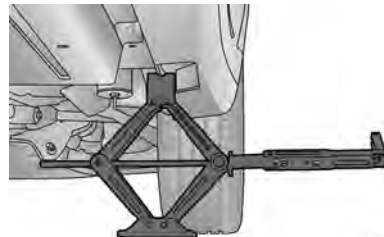

Rear Jacking Location

CAUTION!

Do NOT raise the vehicle by the body side sill molding. Be sure the jack is placed in the proper engagement location on the inside of the panel. Damage of the vehicle may occur if the procedure is not properly followed.

5. Raise the vehicle by turning the jack screw clockwise. Raise the vehicle only until the tire just clears the surface and enough clearance is obtained to install the spare tire. Minimum tire lift provides maximum stability.

WARNING!

Raising the vehicle higher than necessary can make the vehicle less stable. It could slip off the jack and hurt someone near it. Raise the vehicle only enough to remove the tire.

- Remove the lug nuts and wheel.
- Position the spare wheel/tire on the vehicle and install the lug nuts with the cone-shaped end toward the wheel. Lightly tighten the nuts.

CAUTION!

Be sure to mount the spare tire with the valve stem facing outward. The vehicle could be damaged if the inflatable spare tire is mounted incorrectly.

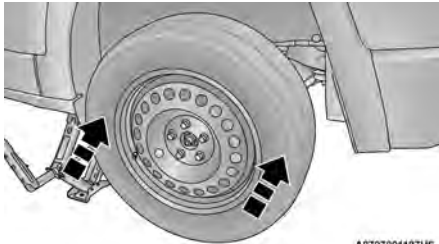

A0707001197US

Mounting Spare Tire**WARNING!**

To avoid the risk of forcing the vehicle off the jack, do not tighten the wheel nuts fully until the vehicle has been lowered. Failure to follow this warning may result in serious injury.

- Lower the vehicle by turning the jack screw counter-clockwise, and remove the jack and wheel blocks.
- Finish tightening the lug nuts. Push down on the wrench while at the end of the handle for increased leverage. Tighten the lug nuts in a star pattern until each nut has been tightened twice. For correct lug nut torque → page 321. If in doubt about the correct tightness, have them checked with a torque wrench by an authorized dealer or at a service station.

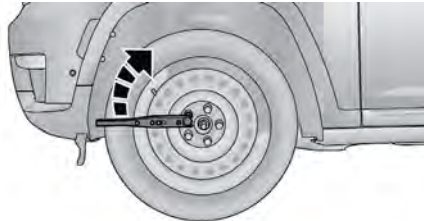

A0707001151US

Tighten Lug Nuts

- Lower the jack to the fully closed position.
- Return the jack and tools back into the jack storage bin. Reinstall the jack storage cover by firmly pushing down until the two side clips lock into position.
- After 25 miles (40 km), check the lug nut torque with a torque wrench to ensure that all lug nuts are properly seated against the wheel.
- Have the aluminum road wheel and tire repaired as soon as possible and properly secure the spare tire, jack and tool kit.

NOTE:

Do not drive with the spare tire installed for more than 50 miles (80 km) at a max speed of 50 mph (80 km/h).

WARNING!

A loose tire or jack thrown forward in a collision or hard stop could endanger the occupants of the vehicle. Always stow the jack parts and the spare tire in the places provided. Have the deflated (flat) tire repaired or replaced immediately.

Second Row Seating — If Equipped

1. Securely store the road wheel in the cargo area.

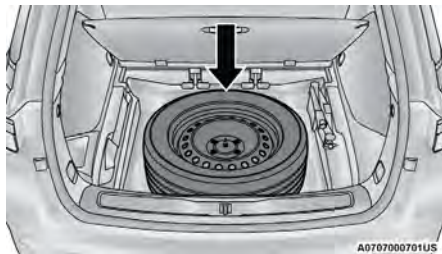

Road Wheel Installed In Spare Tire Location

2. Turn the fastener clockwise until secured.

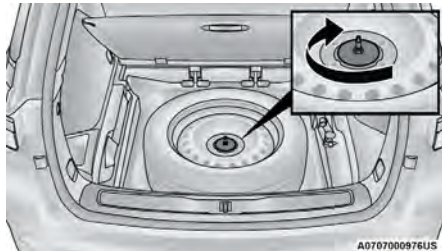

Reinstalling Tire Fastener

Third Row Seating — If Equipped

1. Position the wheel behind the rear fascia/bumper facing outward. Push the end of the winch's cable, spring and steel sleeve through the back of the road wheel. Making sure the valve stem is facing the ground when the wheel is stowed.

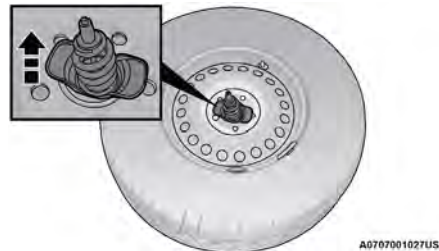

Installing Winch

2. Slide the road wheel on the ground until it is directly under the winch and between the rear fascia/bumper and exhaust system heat shields. Raise the tire by turning the lug wrench on the winch extension clockwise until it clicks/ratchets three times to make sure the cable is tight.

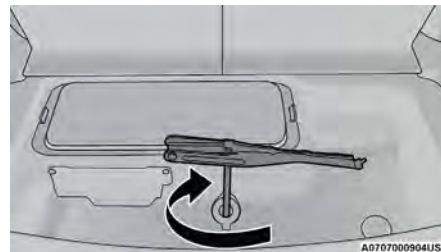

Winch Wrench Rotation

CAUTION!

The winch mechanism is designed for use with the jack wrench extension tool only. Use of air wrench or power tool may damage the winch.

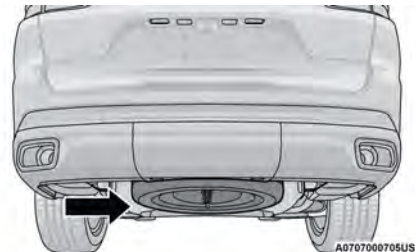

Road Wheel Installed In Spare Location

JUMP STARTING

If your vehicle has a discharged battery, it can be jump started using a set of jumper cables and a battery in another vehicle, or by using a portable battery booster pack. Jump starting can be dangerous if done improperly, so please follow the procedures in this section carefully.

WARNING!

Do not attempt jump starting if the battery is frozen. It could rupture or explode and cause personal injury.

CAUTION!

Do not use a portable battery booster pack or any other booster source with a system voltage greater than 12 Volts or damage to the battery, starter motor, alternator or electrical system may occur.

NOTE:

When using a portable battery booster pack, follow the manufacturer's operating instructions and precautions.

PREPARATIONS FOR JUMP START

There are remote terminals located under the hood to assist in jump starting.

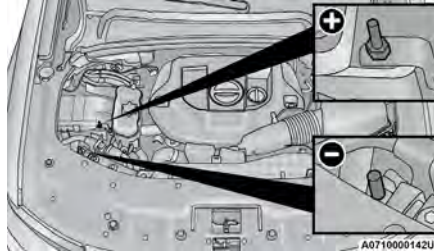

Jump Starting Posts

Remote Positive (+) Post
Remote Negative (-) Post

NOTE:

The remote battery posts are viewed by standing on the right side of the vehicle looking over the fender. The positive battery post may be covered with a protective cap. Lift up on the cap to gain access to the positive battery post. Do not jump off fuses. Only jump directly off positive post which has a positive (+) symbol on or around the post.

See the following steps to prepare for jump starting:

1. Apply the parking brake, shift the automatic transmission into PARK (P) and turn the ignition OFF.
2. Turn off the heater, radio, and all electrical accessories.

3. If using another vehicle to jump start the battery, park the vehicle within the jumper cables' reach, apply the parking brake and make sure the ignition is OFF.

NOTE:

Be sure that the disconnected cable ends do not touch each other, or either vehicle, until properly connected for jump starting.

WARNING!

Do not allow vehicles to touch each other as this could establish a ground connection and personal injury could result.

WARNING!

- Take care to avoid the radiator cooling fan whenever the hood is raised. It can start anytime the ignition switch is ON. You can be injured by moving fan blades.
- Remove any metal jewelry such as rings, watch bands and bracelets that could make an inadvertent electrical contact. You could be seriously injured.
- Batteries contain sulfuric acid that can burn your skin or eyes and generate hydrogen gas which is flammable and explosive. Keep open flames or sparks away from the battery.

JUMP STARTING PROCEDURE

WARNING!

Failure to follow this jump starting procedure could result in personal injury or property damage due to battery explosion.

CAUTION!

Failure to follow these procedures could result in damage to the charging system of the booster vehicle or the discharged vehicle.

NOTE:

Make sure at all times that unused ends of jumper cables are not contacting each other or either vehicle while making connections.

Connecting The Jumper Cables

1. Connect the positive (+) end of the jumper cable to the remote positive (+) post of the discharged vehicle.
2. Connect the opposite end of the positive (+) jumper cable to the positive (+) post of the booster battery.
3. Connect the negative (-) end of the jumper cable to the negative (-) post of the booster battery.
4. Connect the opposite end of the negative (-) jumper cable to the remote negative (-) post (exposed metallic/unpainted post of the discharge vehicle) located directly in front of the underhood fuse box.

WARNING!

Do not connect the jumper cable to the negative (-) post of the discharged battery. The resulting electrical spark could cause the battery to explode and could result in personal injury.

5. Start the engine in the vehicle that has the booster battery, let the engine idle a few minutes, and then start the engine in the vehicle with the discharged battery.

CAUTION!

Do not run the booster vehicle engine above 2,000 RPM since it provides no charging benefit, wastes fuel, and can damage booster vehicle engine.

6. Once the engine is started, follow the disconnecting procedure.

Disconnecting The Jumper Cables

1. Disconnect the negative (-) end of the jumper cable from the remote negative (-) post of the discharged vehicle.
2. Disconnect the opposite end of the negative (-) jumper cable from the negative (-) post of the booster battery.
3. Disconnect the positive (+) end of the jumper cable from the positive (+) post of the booster battery.
4. Disconnect the opposite end of the positive (+) jumper cable from the remote positive (+) post of the discharged vehicle.

5. Reinstall the protective cover over the remote positive (+) post of the discharged vehicle.

If frequent jump starting is required to start your vehicle have the battery and charging system tested at an authorized dealer.

CAUTION!

Accessories plugged into the vehicle power outlets draw power from the vehicle's battery, even when not in use (i.e., cellular devices, etc.). Eventually, if plugged in long enough without engine operation, the vehicle's battery will discharge sufficiently to degrade battery life and/or prevent the engine from starting.

REFUELING IN EMERGENCY

The vehicle is equipped with a refueling funnel
 ➔ page 255 for a capless fuel system. If refueling is necessary, while using an approved gas can, please insert the refueling funnel into the filler neck opening.

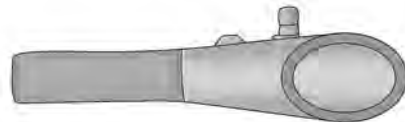

A0711000013US

Refueling Funnel

NOTE:

In certain cold conditions, ice may prevent the fuel door from opening. If this occurs, lightly push around the perimeter of the fuel door to break the ice buildup. Re-release the fuel door by pushing on the rear outer edge near the center to unlatch. Do not pry on the door.

Emergency Gas Can Refueling

Most gas cans will not open the flapper doors. A funnel is provided to allow emergency refueling with a gas can. See the following steps for refueling:

1. Retrieve funnel from under the rear cargo load floor.
2. Insert funnel into same filler pipe opening as the fuel nozzle.

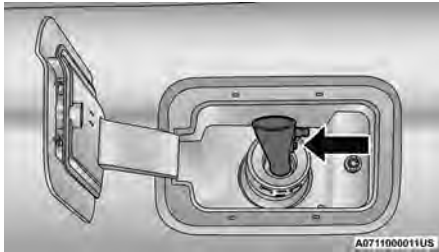
**Inserting Funnel**

3. Ensure funnel is inserted fully to hold flapper doors open.
4. Pour fuel into funnel opening.

CAUTION!

To avoid fuel spillage and overflowing, do not “top off” the fuel tank after filling.

5. Remove funnel from filler pipe, clean off prior to putting back in the spare tire storage area.
6. Close the fuel door making sure the latch is engaged by pushing on the rear outer edge near the center.

WARNING!

- Never have any smoking materials lit in or near the vehicle when the fuel door is open or the tank is being filled.
- Never add fuel when the engine is running. This is in violation of most state and federal fire regulations and may cause the Malfunction Indicator Light to turn on.
- A fire may result if fuel is pumped into a portable container that is inside of a vehicle. You could be burned. Always place fuel containers on the ground while filling.

IF YOUR ENGINE OVERHEATS

If the vehicle is overheating, it will need to be serviced by an authorized dealer.

Potential signs of vehicle overheating:

- Temperature gauge is at HOT (H)
- Strong smell of coolant
- White smoke coming from engine or exhaust
- Coolant bottle coolant has bubbles present

WARNING!

You or others can be badly burned by hot engine coolant (antifreeze) or steam from your radiator. If you see or hear steam coming from under the hood, do not open the hood until the radiator has had time to cool. Never try to open a cooling system pressure cap when the radiator or coolant bottle is hot.

If the temperature gauge is moving towards or close to the HOT (H) position, you can reduce the potential for overheating by taking the appropriate action.

- On highways — slow down.
- In city traffic — while stopped, place the transmission in NEUTRAL (N), but do not increase the engine idle speed while preventing vehicle motion with the brakes.
- Turn off the Air Conditioner (A/C). The A/C system adds heat to the engine cooling system and turning the A/C off can help remove this heat.
- Turn the temperature control to maximum heat, and the blower control to high. This allows the heater core to act as a supplement to the radiator and aids in removing heat from the engine cooling system.

CAUTION!

Driving with a hot cooling system could damage your vehicle. If the temperature gauge reads “H,” pull over and stop the vehicle. Idle the vehicle with the air conditioner turned off until the pointer drops back into the normal range. If the pointer remains on the “H” and you hear continuous chimes, turn the engine off immediately and call for service.

MANUAL PARK RELEASE

WARNING!

You should be seated in the driver's seat with your foot firmly placed on the brake pedal to maintain control of the vehicle before activating the Manual Park Release. If possible, you should apply the parking brake. Activating the Manual Park Release will allow your vehicle to roll away if it is not secured or properly connected to a tow vehicle. Activating the Manual Park Release on an unsecured vehicle could lead to serious injury or death for those in or around the vehicle.

To move the vehicle in cases where the transmission will not shift out of PARK (P) (such as a depleted battery), a Manual Park Release is available.

To activate the Manual Park Release, see the following steps:

1. Apply firm pressure to the brake pedal while seated in the driver's seat.
2. Apply the Electric Park Brake (EPB), if possible.
3. Using a flathead screwdriver or similar tool, remove the Manual Park Release access cover, which is to the lower left of the steering column.

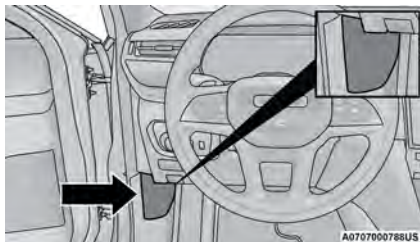

Manual Park Release Access Cover

NOTE:

Insert the flathead screwdriver or similar tool in the lower notch of the access cover and gently rotate clockwise to remove.

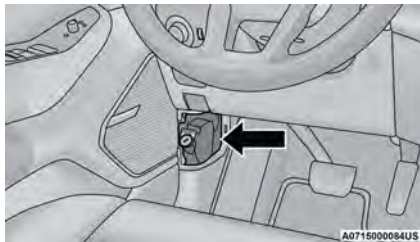

Manual Park Release Location

4. Unlock the orange lock plug by turning it a quarter turn counterclockwise.

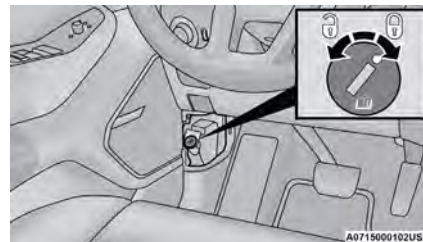

Locked – Unlocked Position

5. Pull the lock plug out as far as it will go, then release it. The transmission should now be in NEUTRAL (N), allowing the vehicle to be moved.

NOTE:

When the lever is locked in the released position, the lock plug and tether will remain outside of the trim panel and the access cover cannot be reinstalled.

6. Release the EPB only when the vehicle is securely connected to a tow vehicle.

To Reset The Manual Park Release:

1. Apply firm pressure to the brake pedal while seated in the driver's seat.
2. Pull the lock plug out again, then release it.
3. Allow the tether to retract with the lever back to its original position.
4. Verify that the transmission is in PARK (P).
5. Confirm that the tether has retracted fully, then firmly push the orange lock plug back to the locking position within the housing. Reinstall the access cover. If the access cover cannot be reinstalled, repeat steps 1 through 4.

FREERING A STUCK VEHICLE

If your vehicle becomes stuck in mud, sand or snow, it can often be moved using a rocking motion. Turn the steering wheel right and left to clear the area around the front wheels. Then, shift back and forth between DRIVE (D) and REVERSE (R) while gently pressing the accelerator.

NOTE:

Shifts between DRIVE (D) and REVERSE (R) can only be achieved at wheel speeds of 5 mph (8 km/h) or less. Whenever the transmission remains in NEUTRAL (N) for more than two seconds, you must press the brake pedal to engage DRIVE (D) or REVERSE (R).

Use the least amount of accelerator pedal pressure that will maintain the rocking motion without spinning the wheels or racing the engine.

NOTE:

Push the ESC OFF button to place the Electronic Stability Control (ESC) system in "Partial OFF" mode, before rocking the vehicle ↪ page 207. Once the vehicle has been freed, push the ESC OFF button again to restore "ESC On" mode.

WARNING!

Fast spinning tires can be dangerous. Forces generated by excessive wheel speeds may cause damage, or even failure, of the axle and tires. A tire could explode and injure someone. Do not spin your vehicle's wheels faster than 30 mph (48 km/h) or for longer than 30 seconds continuously without stopping when you are stuck and do not let anyone near a spinning wheel, no matter what the speed.

CAUTION!

- Racing the engine or spinning the wheels may lead to transmission overheating and failure. Allow the engine to idle with the transmission in NEUTRAL for at least one minute after every five rocking-motion cycles. This will minimize overheating and reduce the risk of transmission failure during prolonged efforts to free a stuck vehicle.
- When "rocking" a stuck vehicle by shifting between DRIVE and REVERSE, do not spin the wheels faster than 15 mph (24 km/h), or drivetrain damage may result.
- Revving the engine or spinning the wheels too fast may lead to transmission overheating and failure. It can also damage the tires. Do not spin the wheels above 30 mph (48 km/h) while in gear (no transmission shifting occurring).

TOWING A DISABLED VEHICLE

This section describes procedures for towing a disabled vehicle using a commercial towing service.

If the transmission and drivetrain are operable, disabled 4x4 vehicles may also be towed as described on ↪ page 163.

Towing Condition	Wheels OFF The Ground	Two-Wheel Drive Models	Four-Wheel Drive Models Without 4WD Low Range	Four-Wheel Drive Models With 4WD Low Range
Flat Tow	NONE	NOT ALLOWED	NOT ALLOWED	See Instructions <ul style="list-style-type: none"> • Transmission in PARK • Transfer case in N (NEUTRAL) • Tow in forward direction
Dolly Tow	Front	NOT ALLOWED	NOT ALLOWED	NOT ALLOWED
	Rear	OK	NOT ALLOWED	NOT ALLOWED
On Trailer	ALL	OK	OK	OK

Proper towing or lifting equipment is required to prevent damage to your vehicle. Use only tow bars and other equipment designed for this purpose, following equipment manufacturer's instructions. Use of safety chains is mandatory. Attach a tow bar or other towing device to main structural members of the vehicle, not to fascia/bumpers or associated brackets. State and local laws regarding vehicles under tow must be observed.

NOTE:

- You must ensure that the Auto Park Brake  page 106 feature is disabled before towing this vehicle to avoid inadvertent Electric Park Brake engagement. The Auto Park Brake feature is enabled or disabled via the customer programmable features in the Uconnect Settings.
 - Vehicles with a discharged battery, or total electrical failure when the Electric Park Brake (EPB) is engaged, will need a wheel dolly or jack to raise the rear wheels off the ground when moving the vehicle onto a flatbed.
 - The Safehold feature will engage the Electric Park Brake whenever the driver's door is opened (if the battery is connected, ignition is ON, transmission is not in PARK, and brake pedal is released). If you are towing this vehicle with the ignition in the ON/RUN mode, you must manually disable the Electric Park Brake each time the driver's door is opened by pressing the brake pedal and then releasing the EPB.
- If you must use the accessories (wipers, defrosters, etc.) while being towed, the ignition must be in the ON/RUN mode.

If the vehicle's battery is discharged, instructions on shifting the automatic transmission out of PARK (P) in order to move the vehicle  page 266.

CAUTION!

- Do not use sling type equipment when towing. Vehicle damage may occur.
- When securing the vehicle to a flat bed truck, do not attach to front or rear suspension components. If vehicle is equipped with Quadra-lift air suspension, secure vehicle only with tire/wheel straps (no suspension components or body) to prevent air suspension from adjusting during towing against securement straps and causing damage. Damage to your vehicle may result from improper towing.

REAR-WHEEL DRIVE MODELS

FCA US LLC recommends towing your vehicle with all four wheels **OFF** the ground using a flatbed.

If flatbed equipment is not available, and the transmission is operable, the vehicle may be towed (with rear wheels off the ground) under the following conditions:

- The transmission must be in NEUTRAL (N). For instructions on shifting the transmission to NEUTRAL (N) when the engine is off  page 266.
- The towing speed must not exceed 30 mph (48 km/h).
- The towing distance must not exceed 30 miles (48 km).

CAUTION!

- Towing faster than 30 mph (48 km/h) or farther than 30 miles (48 km) with rear wheels on the ground can cause severe transmission damage. Damage from improper towing is not covered under the New Vehicle Limited Warranty.

If the transmission is not operable, or the vehicle must be towed faster than 30 mph (48 km/h) or farther than 30 miles (48 km), tow with the rear wheels **OFF** the ground. Acceptable methods are to tow the vehicle on a flatbed, or with the front wheels raised and the rear wheels on a towing dolly, or (when using a suitable steering wheel stabilizer to hold the front wheels in the straight position) with the rear wheels raised and the front wheels **ON** the ground.

FOUR-WHEEL DRIVE MODELS

FCA US LLC recommends towing with all wheels **OFF** the ground. Acceptable methods are to tow the vehicle on a flatbed or with one end of the vehicle raised and the opposite end on a towing dolly.

If flatbed equipment is not available, and the transfer case is operable, vehicles **with a two-speed transfer case** may be towed (in the forward direction, with **ALL** wheels on the ground), **IF** the transfer case is in NEUTRAL (N) and the transmission is in **PARK**  page 163.

Vehicles equipped with a single-speed transfer case have no NEUTRAL (N) position, and therefore **must** be towed with all four wheels **OFF** the ground.

CAUTION!

- Front or rear wheel lifts must not be used (if the remaining wheels are on the ground). Internal damage to the transmission or transfer case will occur if a front or rear wheel lift is used when towing.
- Towing this vehicle in violation of the approved requirements can cause severe transmission and/or transfer case damage. Damage from improper towing is not covered under the New Vehicle Limited Warranty.

EMERGENCY TOW HOOKS — IF EQUIPPED

If your vehicle is equipped with tow hooks, there will be two mounted on the front of the vehicle and one in the rear. The rear tow hook will be located on the driver's side of the vehicle.

CAUTION!

Tow hooks are for emergency use only, to rescue a vehicle stranded off road. Do not use tow hooks for tow truck hookup or highway towing. You could damage your vehicle.



Front Tow Hooks

NOTE:

For off road recovery, it is recommended to use both of the front tow hooks to minimize the risk of damage to the vehicle.



Rear Tow Hook

WARNING!

- Do not use a chain for freeing a stuck vehicle. Chains may break, causing serious injury or death.
- Stand clear of vehicles when pulling with tow hooks. Tow straps may become disengaged, causing serious injury.

ENHANCED ACCIDENT RESPONSE SYSTEM (EARS)

This vehicle is equipped with an Enhanced Accident Response System.

This feature is a communication network that takes effect in the event of an impact → page 236.

EVENT DATA RECORDER (EDR)

This vehicle is equipped with an Event Data Recorder (EDR). The main purpose of an EDR is to record data that will assist in understanding how a vehicle's systems performed under certain crash or near crash-like situations, such as an air bag deployment or hitting a road obstacle → page 237.

SERVICING AND MAINTENANCE

SCHEDULED SERVICING

Your vehicle is equipped with an automatic oil change indicator system. The oil change indicator system will remind you that it is time to take your vehicle in for scheduled maintenance.

Based on engine operation conditions, the oil change indicator message will illuminate. This means that service is required for your vehicle. Operating conditions such as frequent short-trips, trailer tow, extremely hot or cold ambient temperatures, and E85 fuel usage will influence when the "Oil Change Required" message is displayed. Have your vehicle serviced as soon as possible, within the next 500 miles (805 km).

An authorized dealer will reset the oil change indicator message after completing the scheduled oil change.

NOTE:

Under no circumstances should oil change intervals exceed 10,000 miles (16,000 km), 12 months or 350 hours of engine run time, whichever comes first. The 350 hours of engine run or idle time is generally only a concern for fleet customers.

Once A Month Or Before A Long Trip:

- Check engine oil level.
- Check windshield washer fluid level.
- Check the tire inflation pressures and look for unusual wear or damage.
- Check the fluid levels of the coolant reservoir, brake master cylinder and fill as needed.
- Check function of all interior and exterior lights.

MAINTENANCE PLAN – GASOLINE ENGINES

Refer to the Maintenance Plan for the required maintenance intervals.

At Every Oil Change Interval As Indicated By Oil Change Indicator System
● Change oil and filter.
● Rotate the tires at the first sign of irregular wear, even if it occurs before the oil indicator system turns on.
● Inspect battery and clean and tighten terminals as required.
● Inspect the CV/Universal joints.
● Inspect brake pads, shoes, rotors, drums, hoses and parking brake.
● Inspect engine cooling system protection and hoses.
● Inspect exhaust system.
● Inspect engine air cleaner filter if using in dusty or off-road conditions. Replace engine air cleaner filter, as necessary.

Mileage Or Time Passed (Whichever Comes First)	20,000	30,000	40,000	50,000	60,000	70,000	80,000	90,000	100,000	110,000	120,000	130,000	140,000	150,000
Or Years:	2	3	4	5	6	7	8	9	10	11	12	13	14	15
Or Kilometers:	32,000	48,000	64,000	80,000	96,000	112,000	128,000	144,000	160,000	176,000	192,000	208,000	224,000	240,000
Additional Inspections														
Inspect the CV/Universal joints.	X	X	X	X	X	X	X	X	X	X	X	X	X	X
Inspect front suspension, tie rod ends, and replace if necessary.	X		X		X		X		X		X		X	
Inspect the front and rear axle fluid, change if using your vehicle for police, taxi, fleet, off-road or frequent trailer towing.		X			X			X			X			X
Inspect the brake linings, parking brake function.	X		X		X		X		X		X		X	
Inspect transfer case fluid.		X			X			X			X			X
Additional Maintenance														
Replace engine air cleaner filter.		X			X			X			X			X
Replace the cabin air filter.	To be replaced every 12,000 miles (19,000 km).													
Replace spark plugs – 2.0L.**					X						X			
Replace spark plugs – 3.6L & 5.7L.**									X					
Flush and replace the engine coolant at 10 years or 150,000 miles (240,000 km) whichever comes first.									X					X
Replace accessory drive belt.														X

** The spark plug change interval is mileage-based only, yearly intervals do not apply.

Mileage Or Time Passed (Whichever Comes First)	20,000	30,000	40,000	50,000	60,000	70,000	80,000	90,000	100,000	110,000	120,000	130,000	140,000	150,000
Or Years:	2	3	4	5	6	7	8	9	10	11	12	13	14	15
Or Kilometers:	32,000	48,000	64,000	80,000	96,000	112,000	128,000	144,000	160,000	176,000	192,000	208,000	224,000	240,000
Inspect accessory drive belt tensioner and pulley, replace if necessary.														X
Change transfer case fluid – Normal Usage.											X			
Change transfer case fluid – Severe Usage (police, taxi, fleet, off-road, or frequent trailer towing.)						X							X	
Replace PCV valve.									X					

WARNING!

- You can be badly injured working on or around a motor vehicle. Do only service work for which you have the knowledge and the right equipment. If you have any doubt about your ability to perform a service job, take your vehicle to a competent mechanic.
- Failure to properly inspect and maintain your vehicle could result in a component malfunction and affect vehicle handling and performance. This could cause an accident.

ENGINE COMPARTMENT

2.0L ENGINE

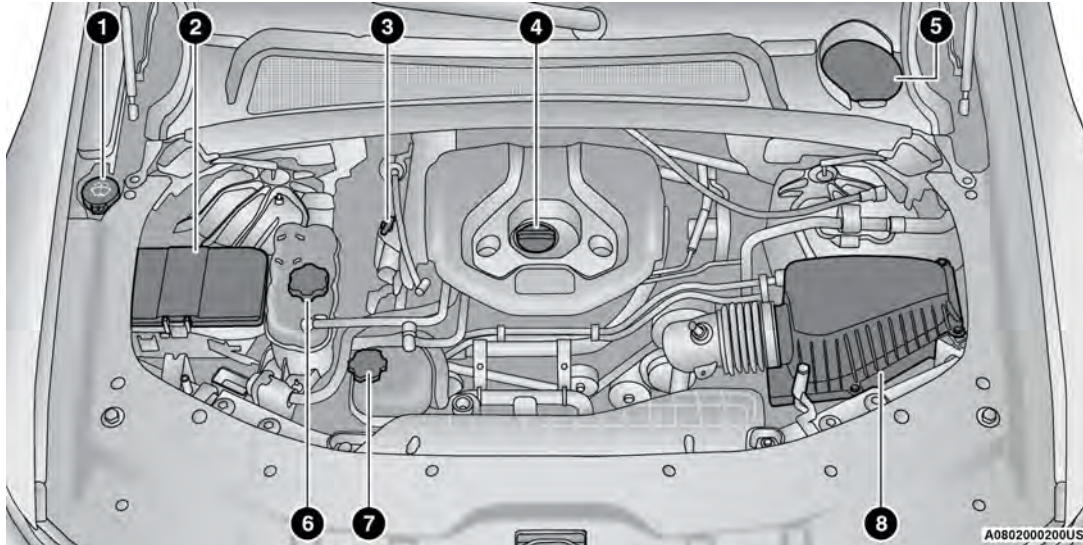

- 1 — Washer Fluid Reservoir Cap
- 2 — Power Distribution Center (Fuses)
- 3 — Engine Oil Dipstick
- 4 — Engine Oil Fill

- 5 — Brake Fluid Reservoir Access
- 6 — Engine Coolant Pressure Cap
- 7 — Intercooler Coolant Reservoir Cap
- 8 — Engine Air Cleaner, Filter

3.6L ENGINE

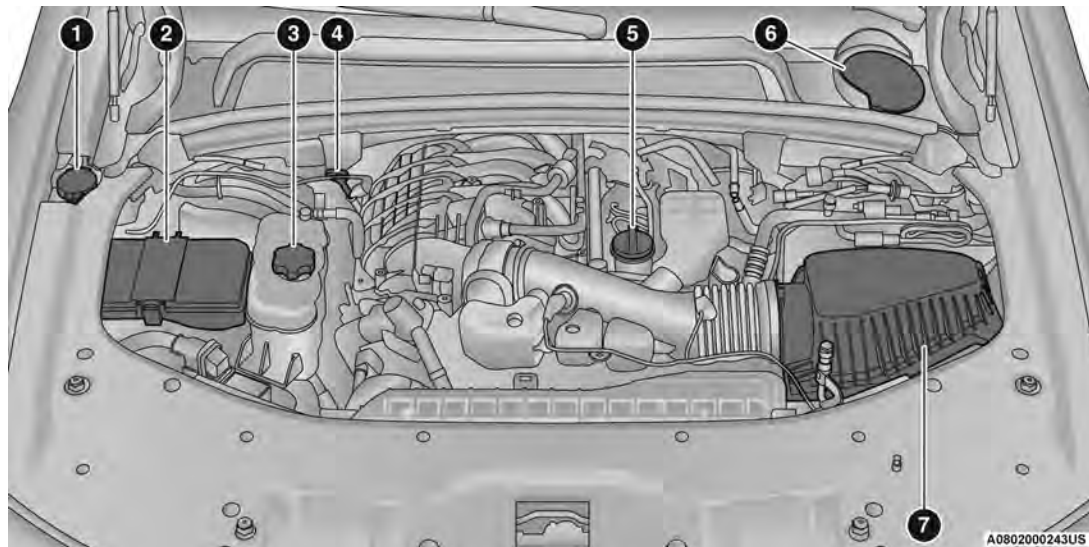

- 1 – Washer Fluid Reservoir Cap
- 2 – Power Distribution Center (Fuses)
- 3 – Engine Coolant Pressure Cap
- 4 – Engine Oil Dipstick

- 5 – Engine Oil Fill
- 6 – Brake Fluid Reservoir Access
- 7 – Engine Air Cleaner, Filter

5.7L ENGINE

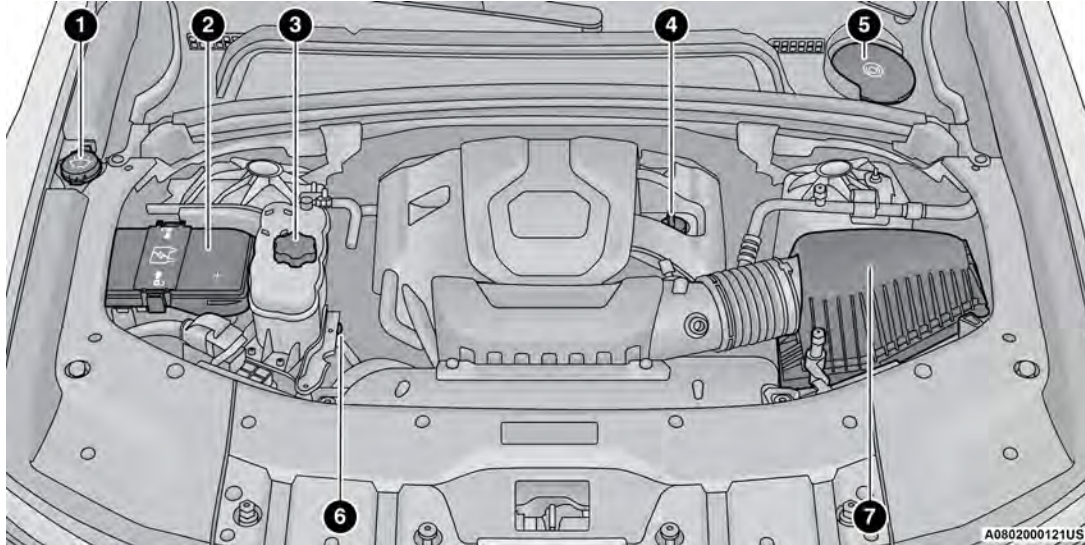

- 1 – Washer Fluid Reservoir Cap
- 2 – Power Distribution Center (Fuses)
- 3 – Engine Coolant Pressure Cap
- 4 – Engine Oil Fill

- 5 – Brake Fluid Reservoir Access
- 6 – Engine Oil Dipstick
- 7 – Engine Air Cleaner, Filter

CHECKING OIL LEVEL

To ensure proper engine lubrication, the engine oil must be maintained at the correct level. Check the oil level at regular intervals, such as every fuel stop. The best time to check the engine oil level is about five minutes after a fully warmed up engine is shut off.

Checking the oil while the vehicle is on level ground will improve the accuracy of the oil level readings.

There are four possible dipstick types:

- Crosshatched zone.
- Crosshatched zone marked SAFE.
- Crosshatched zone marked with MIN at the low end of the range and MAX at the high end of the range.
- Crosshatched zone marked with dimples at the MIN and the MAX ends of the range.

NOTE:

Always maintain the oil level within the crosshatch markings on the dipstick.

Adding 1 qt (1.0 L) of oil when the reading is at the low end of the dipstick range will raise the oil level to the high end of the range marking.

NOTE:

Always maintain the oil level within the crosshatch markings on the dipstick.

NOTE:

Use care when filling under hood fluids such as engine oil, washer fluid, antifreeze, etc., to minimize spillage onto the top of the engine. Any excess fluid that is spilled onto the top of the engine should be removed using compressed air or an absorbent cloth.

ADDING WASHER FLUID

The instrument cluster display will indicate when the washer fluid level is low. When the sensor detects a low fluid level, the Low Washer Fluid Warning Light will illuminate and the "Washer Fluid Low" message will display.

The fluid reservoir for the windshield washers and the rear window washer is shared. The fluid reservoir is located in the engine compartment, be sure to check the fluid level at regular intervals. Fill the reservoir with windshield washer solvent only (not radiator antifreeze). When refilling the washer fluid reservoir, take some washer fluid and apply it to a cloth or towel and wipe clean the wiper blades, this will help blade performance. To prevent freeze-up of your windshield washer system in cold weather, select a solution or mixture that meets or exceeds the temperature range of your climate. This rating information can be found on most washer fluid containers.

NOTE:

Use care when filling under hood fluids such as engine oil, washer fluid, antifreeze, etc., to minimize spillage onto the top of the engine. Any excess fluid that is spilled onto the top of the engine should be removed using compressed air or an absorbent cloth.

WARNING!

Commercially available windshield washer solvents are flammable. They could ignite and burn you. Care must be exercised when filling or working around the washer solution.

CAUTION!

Do not travel with the windshield washer fluid reservoir empty: the windshield washers are essential for improving visibility.

MAINTENANCE-FREE BATTERY

Your vehicle is equipped with a maintenance-free battery. Water will never have to be added, and periodic maintenance is not required.

WARNING!

- Battery fluid is a corrosive acid solution and can burn or even blind you. Do not allow battery fluid to contact your eyes, skin, or clothing. Do not lean over a battery when attaching clamps. If acid splashes in eyes or on skin, flush the area immediately with large amounts of water. Refer to Jump Starting Procedure ↗ page 264.
- Battery gas is flammable and explosive. Keep flame or sparks away from the battery. Do not use a booster battery or any other booster source with an output greater than 12 Volts. Do not allow cable clamps to touch each other.
- Battery posts, terminals, and related accessories contain lead and lead compounds. Wash hands after handling.

CAUTION!

- It is essential when replacing the cables on the battery that the positive cable is attached to the positive post and the negative cable is attached to the negative post. Battery posts are marked positive (+) and negative (-) and are identified on the battery case. Cable clamps should be tight on the terminal posts and free of corrosion.
- If a "fast charger" is used while the battery is in the vehicle, disconnect both vehicle battery cables before connecting the charger to the battery. Do not use a "fast charger" to provide starting voltage.

PRESSURE WASHING

Cleaning the engine compartment with a high pressure washer is not recommended.

CAUTION!

Precautions have been taken to safeguard all parts and connections however, the pressures generated by these machines is such that complete protection against water ingress cannot be guaranteed.

VEHICLE MAINTENANCE

An authorized dealer has the qualified service personnel, special tools, and equipment to perform all service operations in an expert manner. Service Manuals are available which include detailed service information for your vehicle. Refer to these Service Manuals before attempting any procedure yourself.

NOTE:

Intentional tampering with emissions control systems may void your warranty and could result in civil penalties being assessed against you.

WARNING!

You can be badly injured working on or around a motor vehicle. Only do service work for which you have the knowledge and the proper equipment. If you have any doubt about your ability to perform a service job, take your vehicle to a competent mechanic.

ENGINE OIL**Engine Oil Selection**

Use only the manufacturer's recommended fluid
 ⇨ page 324.

NOTE:

Hemi engines at times can tick right after startup and then quiet down after approximately 30 seconds. This is normal and will not harm the engine. This characteristic can be caused by short drive cycles. For example, if the vehicle is started then shut off after driving a short distance. Upon restarting, you may experience a ticking sound. Other causes could be if the vehicle is unused for an extended period of time, incorrect oil, extended oil changes or extended idling. If the engine continues to tick or if the Malfunction Indicator Light (MIL) comes on, see the nearest authorized dealer.

American Petroleum Institute (API) Approved Engine Oil

These symbols mean that the oil has been certified by the API. The manufacturer only recommends API trademark oils.



The API Starburst trademark certifies 0W-20, 0W-30 and 5W-30 engine oils.



The API Donut trademark certifies 0W-40 and 5W-40 engine oil.

CAUTION!

Do not use chemical flushes in your engine oil as the chemicals can damage your engine. Such damage is not covered by the New Vehicle Limited Warranty.

Synthetic Engine Oils

Your engine was designed for synthetic engine oils, only use synthetic API approved engine oils.

Synthetic engine oils which do not have both the correct API trademark and the correct SAE viscosity grade numbers should not be used.

Materials Added To Engine Oil

The manufacturer strongly recommends against the addition of any additives (other than leak detection dyes) to the engine oil. Engine oil is an engineered product and its performance may be impaired by supplemental additives.

Disposing Of Used Engine Oil And Oil Filters

Care should be taken in disposing of used engine oil and oil filters from your vehicle. Used oil and oil filters, indiscriminately discarded, can present a problem to the environment. Contact an authorized dealer, service station or governmental agency for advice on how and where used oil and oil filters can be safely discarded in your area.

ENGINE OIL FILTER

The engine oil filter should be replaced with a new filter at every engine oil change.

Engine Oil Filter Selection

A full-flow type disposable oil filter should be used for replacement. The quality of replacement filters varies considerably. Only high quality Mopar® filters should be used. If Mopar® Engine Oil Filters are unavailable, only use filters that meet or exceed SAE/USCAR-36 Filter Performance Requirements.

ENGINE AIR CLEANER FILTER

For the proper maintenance intervals ⇨ page 270.

WARNING!

The air induction system (air cleaner, hoses, etc.) can provide a measure of protection in the case of engine backfire. Do not remove the air induction system (air cleaner, hoses, etc.) unless such removal is necessary for repair or maintenance. Make sure that no one is near the engine compartment before starting the vehicle with the air induction system (air cleaner, hoses, etc.) removed. Failure to do so can result in serious personal injury.

Engine Air Cleaner Filter Selection

The quality of replacement engine air cleaner filters varies considerably. Only high quality Mopar® filters should be used.

Engine Air Cleaner Filter Inspection and Replacement

Engine Air Cleaner Filter Removal

1. With a suitable tool, fully loosen fasteners on the engine air cleaner filter cover.
2. Lift the engine air cleaner filter cover and rotate hinge to access the air cleaner filter.

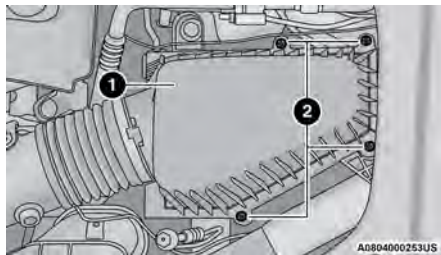

Engine Air Cleaner Filter Cover

- 1 — Engine Air Cleaner Filter Cover
 - 2 — Fasteners
-
3. Remove the engine air cleaner filter from the housing assembly.

Engine Air Cleaner Filter Installation

NOTE:

Inspect and clean the housing assembly if significant dirt or debris is present before replacing the engine air cleaner filter.

1. Install the engine air cleaner filter into the housing assembly with the engine air cleaner filter inspection surface facing downward.
2. Install the engine air cleaner filter cover onto the housing assembly locating tabs.
3. Tighten the fasteners on the engine air cleaner filter assembly.

CAUTION!

Do not overtighten the engine air cleaner filter cover lid screws or damage may result.

AIR CONDITIONER MAINTENANCE

For best possible performance, your air conditioner should be checked and serviced by an authorized dealer at the start of each warm season. This service should include cleaning of the condenser fins and a performance test. Drive belt tension should also be checked at this time.

WARNING!

- Use only refrigerants and compressor lubricants approved by the manufacturer for your air conditioning system. Some unapproved refrigerants are flammable and can explode, injuring you. Other unapproved refrigerants or lubricants can cause the system to fail, requiring costly repairs. Refer to Warranty Information Book, for further warranty information.
- The air conditioning system contains refrigerant under high pressure. To avoid risk of personal injury or damage to the system, adding refrigerant or any repair requiring lines to be disconnected should be done by an experienced technician.

CAUTION!

Do not use chemical flushes in your air conditioning system as the chemicals can damage your air conditioning components. Such damage is not covered by the New Vehicle Limited Warranty.

Refrigerant Recovery And Recycling – R-1234yf

R-1234yf Air Conditioning Refrigerant is a Hydrofluorolefin (HFO) that is endorsed by the Environmental Protection Agency and is an ozone-friendly substance with a low global-warming potential. The manufacturer recommends that air conditioning service be performed by an authorized dealer using recovery and recycling equipment.

NOTE:

Use only manufacturer approved A/C system PAG compressor oil, and refrigerants.

Cabin Air Filter Replacement

For the proper maintenance intervals ↪ page 270.

WARNING!

Do not remove the cabin air filter while the vehicle is running, or while the ignition is in the ON/RUN mode. With the cabin air filter removed and the blower operating, the blower can contact hands and may propel dirt and debris into your eyes, resulting in personal injury.

The cabin air filter is located in the fresh air inlet behind the glove compartment. Perform the following procedure to replace the filter:

1. Open the glove compartment and remove all contents.
2. There is a glove compartment travel stop on the right side of the glove compartment door. Partially close the glove compartment door and pull the travel stop toward you to release the glove compartment travel stop.

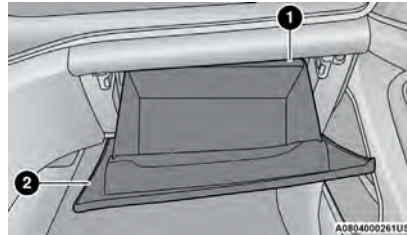

Glove Compartment

- 1 – Glove Compartment Travel Stop
- 2 – Glove Compartment Door

3. With the glove compartment door loose, remove the glove compartment tension tether and tether clip by sliding the clip toward the face of the glove compartment door and lifting the clip out of glove compartment door.

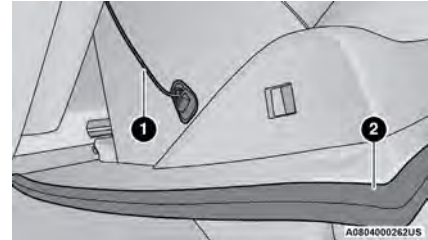

Side Of Glove Compartment

- 1 – Glove Compartment Tension Tether
 - 2 – Glove Compartment Door
4. Lower the glove compartment door to the floor.
 5. Squeeze the retaining tabs together that secures the cabin air filter cover to the HVAC housing. Unhinge the filter cover on the right side to fully remove the cover.

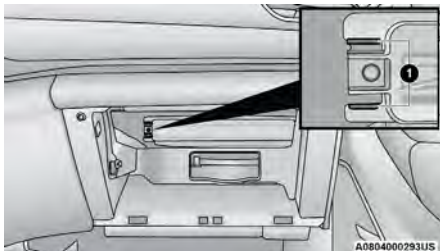

Cabin Air Filter Cover

1 – Retaining Tabs

6. Remove the cabin air filter by pulling it straight out of the housing.
7. Install the cabin air filter with the arrow on the filter pointing toward the floor. When installing the filter cover, make sure the retaining tabs fully engage into the HVAC housing.

CAUTION!

The cabin air filter is identified with an arrow to indicate airflow direction through the filter. Failure to properly install the filter will result in the need to replace it more often.

8. Lift the glove compartment door up and reattach the tension tether by inserting the tether clip in the glove compartment and sliding the clip away from the face of the glove compartment door.

9. Push the door to the near closed position to reengage the glove compartment travel stops.

NOTE:

Ensure the glove compartment travel stops are fully engaged.

ACCESSORY DRIVE BELT INSPECTION

WARNING!

- Do not attempt to inspect an accessory drive belt with vehicle running.
- When working near the radiator cooling fan, disconnect the fan motor lead. The fan is temperature controlled and can start at any time regardless of ignition mode. You could be injured by the moving fan blades.
- You can be badly injured working on or around a motor vehicle. Only do service work for which you have the knowledge and the proper equipment. If you have any doubt about your ability to perform a service job, take your vehicle to a competent mechanic.

When inspecting accessory drive belts, small cracks that run across ribbed surface of belt from rib to rib, are considered normal. These are not a reason to replace belt. However, cracks running along a rib (not across) are not normal. Any belt with cracks running along a rib must be replaced. Also have the belt replaced if it has excessive wear, frayed cords or severe glazing.

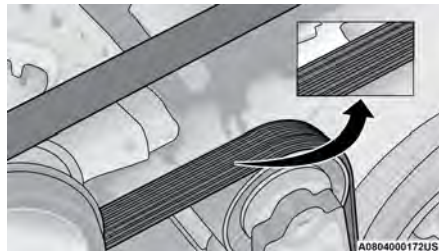

Accessory Belt (Serpentine Belt)

Conditions that would require replacement:

- Rib chunking (one or more ribs has separated from belt body)
- Rib or belt wear
- Longitudinal belt cracking (cracks between two ribs)
- Belt slips
- Groove jumping (belt does not maintain correct position on pulley)
- Belt broken (identify and correct problem before new belt is installed)
- Noise (objectionable squeal, squeak, or rumble is heard or felt while drive belt is in operation)

Some conditions can be caused by a faulty component such as a belt pulley. Belt pulleys should be carefully inspected for damage and proper alignment.

Belt replacement on some models requires the use of special tools, we recommend having your vehicle serviced at an authorized dealer.

BODY LUBRICATION

Locks and all body pivot points, including such items as seat tracks, door hinge pivot points and rollers, liftgate, tailgate, decklid, sliding doors and hood hinges, should be lubricated periodically with a lithium-based grease, such as Mopar® Spray White Lube to ensure quiet, easy operation and to protect against rust and wear. Prior to the application of any lubricant, the parts concerned should be wiped clean to remove dust and grit; after lubricating excess oil and grease should be removed. Particular attention should also be given to hood latching components to ensure proper function. When performing other underhood services, the hood latch, release mechanism and safety catch should be cleaned and lubricated.

The external lock cylinders should be lubricated twice a year, preferably in the Autumn and Spring. Apply a small amount of a high quality lubricant, such as Mopar® Lock Cylinder Lubricant directly into the lock cylinder.

WINDSHIELD WIPER BLADES

Clean the rubber edges of the wiper blades and the windshield periodically with a sponge or soft cloth and a mild nonabrasive cleaner. This will remove accumulations of salt or road film.

Operation of the wipers on dry glass for long periods may cause deterioration of the wiper blades. Always use washer fluid when using the wipers to remove salt or dirt from a dry windshield.

Avoid using the wiper blades to remove frost or ice from the windshield. Keep the blade rubber out of contact with petroleum products such as engine oil, gasoline, etc.

NOTE:

Life expectancy of wiper blades varies depending on geographical area and frequency of use. Poor performance of blades may be present with chattering, marks, water lines or wet spots. If any of these conditions are present, clean the wiper blades or replace as necessary.

The wiper blades and wiper arms should be inspected periodically, not just when wiper performance problems are experienced. This inspection should include the following points:

- Wear or uneven edges
- Foreign material
- Hardening or cracking
- Deformation or fatigue

If a wiper blade or wiper arm is damaged, replace the affected wiper arm or blade with a new unit. Do not attempt to repair a wiper arm or blade that is damaged.

Front Wiper Blade Removal/Installation

CAUTION!

Do not allow the wiper arm to spring back against the glass without the wiper blade in place or the glass may be damaged.

1. Lift the wiper arm to raise the wiper blade off of the glass, until the wiper arm is in the full up position.

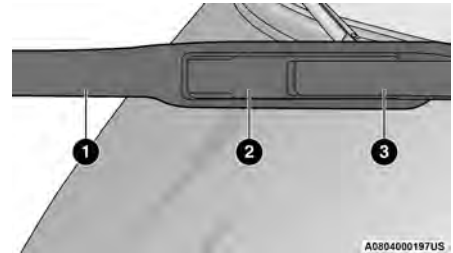

Wiper Blade With Release Tab In Locked Position

- 1 – Wiper
- 2 – Release Tab
- 3 – Wiper Arm

2. To disengage the wiper blade from the wiper arm, flip up the release tab on the wiper blade and while holding the wiper arm with one hand, slide the wiper blade down towards the base of the wiper arm.

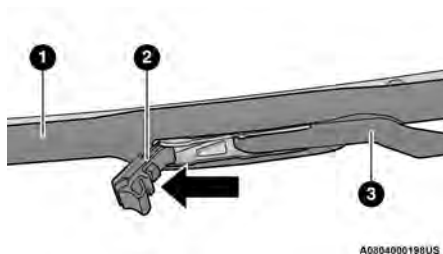

Wiper Blade With Release Tab In Unlocked Position

- 1 – Wiper Blade
2 – Release Tab
3 – Wiper Arm

3. With the wiper blade disengaged, remove the wiper blade from the wiper arm by holding the wiper arm with one hand and separating the wiper blade from the wiper arm with the other hand (move the wiper blade toward the right side of the vehicle to separate the wiper blade from the wiper arm).

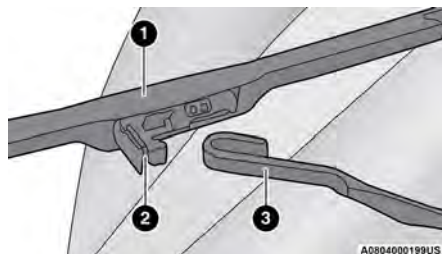

Wiper Blade Removed From Wiper Arm

- 1 – Wiper Blade
2 – Release Tab
3 – Wiper Arm

4. Gently lower the wiper arm onto the glass.

Installing The Front Wipers

1. Lift the wiper arm off of the glass, until the wiper arm is in the full up position.
2. Position the wiper blade near the hook on the tip of the wiper arm with the wiper release tab open and the blade side of the wiper facing up and away from the windshield.
3. Insert the hook on the tip of the arm through the opening in the wiper blade under the release tab.
4. Slide the wiper blade up into the hook on the wiper arm and rotate the wiper blade until it is flush against the wiper arm. Fold down the latch release tab and snap it into its locked position. Latch engagement will be accompanied by an audible click.
5. Gently lower the wiper blade onto the glass.

Rear Wiper Blade Removal/Installation

1. Lift the rear wiper arm fully off the glass.

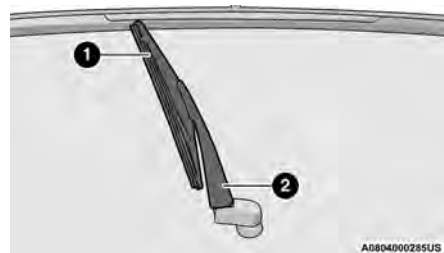

Wiper Blade In Folded Out Position

- 1 – Wiper Blade
2 – Wiper Arm

2. To remove the wiper blade from the wiper arm, grab the bottom end of the wiper blade nearest to wiper arm with your left hand. With your right hand, hold the wiper arm as you pull the wiper blade away from the wiper arm past its stop (far enough to unsnap the wiper blade pivot from the receptacle on the end of the wiper arm).

NOTE:

- Resistance will be accompanied by an audible snap.
- The wiper arm does not stay in the service up position.

- Still grabbing the bottom end of the wiper blade, move the wiper blade upward and away from the wiper arm to disengage.

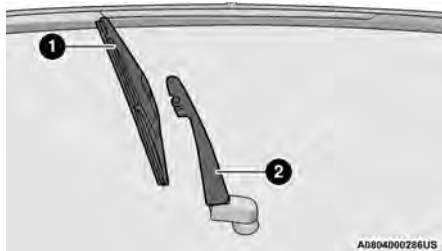

Wiper Blade Removed From Wiper Arm

- 1 – Wiper Blade
2 – Wiper Arm

- Gently lower the tip of the wiper arm onto the glass.

Installing The Rear Wiper

- Lift the rear wiper arm fully off the glass.
- Insert the wiper blade pivot pin into the opening on the end of the wiper arm. Grab the bottom end of the wiper arm with one hand, and press the wiper blade flush with the wiper arm until it snaps into place.
- Lower the wiper blade onto the glass.

EXHAUST SYSTEM

The best protection against carbon monoxide entry into the vehicle body is a properly maintained engine exhaust system.

If you notice a change in the sound of the exhaust system; or if exhaust fumes can be detected inside the vehicle; or when the underside or rear of the vehicle is damaged; have an authorized technician inspect the complete exhaust system and adjacent body areas for broken, damaged, deteriorated, or mispositioned parts. Open seams or loose connections could permit exhaust fumes to seep into the passenger compartment. In addition, have the exhaust system inspected each time the vehicle is raised for lubrication or oil changes. Replace as required.

WARNING!

- Exhaust gases can injure or kill. They contain Carbon Monoxide (CO), which is colorless and odorless. Breathing it can make you unconscious and can eventually poison you. To avoid breathing CO → page 248.
- A hot exhaust system can start a fire if you park over materials that can burn. Such materials might be grass or leaves coming into contact with your exhaust system. Do not park or operate your vehicle in areas where your exhaust system can contact anything that can burn.

CAUTION!

- The catalytic converter requires the use of unleaded fuel only. Leaded gasoline will destroy the effectiveness of the catalyst as an emissions control device and may seriously reduce engine performance and cause serious damage to the engine.
- Damage to the catalytic converter can result if your vehicle is not kept in proper operating condition. In the event of engine malfunction, particularly involving engine misfire or other apparent loss of performance, have your vehicle serviced promptly. Continued operation of your vehicle with a severe malfunction could cause the converter to overheat, resulting in possible damage to the converter and vehicle.

Under normal operating conditions, the catalytic converter will not require maintenance. However, it is important to keep the engine properly tuned to ensure proper catalyst operation and prevent possible catalyst damage.

NOTE:

Intentional tampering with emissions control systems can result in civil penalties being assessed against you. In unusual situations involving grossly malfunctioning engine operation, a scorching odor may suggest severe and abnormal catalyst overheating. If this occurs, stop the vehicle, turn off the engine and allow it to cool. Service, including a tune-up to manufacturer's specifications, should be obtained immediately.

To minimize the possibility of catalytic converter damage:

- Do not interrupt the ignition when the transmission is in gear and the vehicle is in motion.
- Do not try to start the vehicle by pushing or towing the vehicle.
- Do not idle the engine with any ignition components disconnected or removed, such as during diagnostic testing, or for prolonged periods during very rough idle or malfunctioning operating conditions.

COOLING SYSTEM

WARNING!

- You or others can be badly burned by hot engine coolant (antifreeze) or steam from your radiator. If you see or hear steam coming from under the hood, do not open the hood until the radiator has had time to cool. Never open a cooling system pressure cap when the radiator or coolant bottle is hot.
- Keep hands, tools, clothing, and jewelry away from the radiator cooling fan when the hood is raised. The fan starts automatically and may start at any time, whether the engine is running or not.
- When working near the radiator cooling fan, disconnect the fan motor lead or turn the ignition to the OFF position. The fan is temperature controlled and can start at any time the ignition is in the ON position.

Engine Coolant Checks

Check the engine coolant (antifreeze) protection every 12 months (before the onset of freezing weather, where applicable). If the engine coolant is dirty, the system should be drained, flushed, and refilled with fresh Organic Additive Technology (OAT) coolant (conforming to MS.90032) by an authorized dealer. Check the front of the A/C condenser for any accumulation of bugs, leaves, etc. If dirty, clean by gently spraying water from a garden hose vertically down the face of the condenser.

Check the engine cooling system hoses for brittle rubber, cracking, tears, cuts, and tightness of the connection at the coolant recovery bottle and radiator. Inspect the entire system for leaks. **DO NOT REMOVE THE COOLANT PRESSURE CAP WHEN THE COOLING SYSTEM IS HOT.**

Cooling System — Drain, Flush And Refill

NOTE:

Some vehicles require special tools to add coolant properly. Failure to fill these systems properly could lead to severe internal engine damage. If any coolant is needed to be added to the system please contact an authorized dealer.

If the engine coolant (antifreeze) is dirty or contains visible sediment, have an authorized dealer clean and flush with Organic Additive Technology (OAT) coolant (conforming to MS.90032).

For the proper maintenance intervals ⇨ page 270.

Selection Of Coolant

Refer to Engine Fluids And Lubricants ⇨ page 324.

NOTE:

- Mixing of engine coolant (antifreeze) other than specified Organic Additive Technology (OAT) engine coolant, may result in engine damage and may decrease corrosion protection. OAT engine coolant is different and should not be mixed with Hybrid Organic Additive Technology (HOAT) engine coolant or any “globally compatible” coolant. If a non-OAT engine coolant is introduced into the cooling system in an emergency, the cooling system will need to be drained, flushed, and refilled with fresh OAT coolant (conforming to MS.90032), by an authorized dealer as soon as possible.
- Do not use water alone or alcohol-based engine coolant products. Do not use additional rust inhibitors or anti-rust products, as they may not be compatible with the radiator engine coolant and may plug the radiator.
- This vehicle has not been designed for use with propylene glycol-based engine coolant. Use of propylene glycol-based engine coolant is not recommended.
- Some vehicles require special tools to add coolant properly. Failure to fill these systems properly could lead to severe internal engine damage. If any coolant is needed to be added to the system please contact an authorized dealer.

Adding Coolant

Your vehicle has been built with an improved engine coolant (OAT coolant conforming to MS.90032) that allows extended maintenance intervals. This engine coolant (antifreeze) can be used up to 10 years or 150,000 miles (240,000 km) before replacement. To prevent reducing this extended maintenance period, it is important to use the same engine coolant (OAT coolant conforming to MS.90032) throughout the life of your vehicle.

Please review these recommendations for using Organic Additive Technology (OAT) engine coolant that meets the requirements of the manufacturer Material Standard MS.90032. When adding engine coolant:

- We recommend using Mopar® Antifreeze/Coolant 10 Year/150,000 Mile (240,000 km) Formula OAT that meets the requirements of the manufacturer Material Standard MS.90032.
- Mix a minimum solution of 50% OAT engine coolant that meets the requirements of the manufacturer Material Standard MS.90032 and distilled water. Use higher concentrations (not to exceed 70%) if temperatures below -34°F (-37°C) are anticipated. Please contact an authorized dealer for assistance.
- Use only high purity water such as distilled or deionized water when mixing the water/engine coolant solution. The use of lower quality water will reduce the amount of corrosion protection in the engine cooling system.
- Use care when filling under hood fluids such as engine oil, washer fluid, antifreeze, etc., to minimize spillage onto the top of the engine. Any excess fluid that is spilled onto the top of the engine should be removed using compressed air or an absorbent cloth.
- Some vehicles require special tools to add coolant properly. Failure to fill these systems properly could lead to severe internal engine damage. If any coolant is needed to be added to the system, please contact a local authorized dealer.
- Mixing engine coolant types is not recommended and can result in cooling system damage. If HOAT and OAT coolant are mixed in an emergency, have an authorized dealer drain, flush, and refill with OAT coolant (conforming to MS.90032) as soon as possible.

NOTE:

- It is the owner's responsibility to maintain the proper level of protection against freezing according to the temperatures occurring in the area where the vehicle is operated.

Cooling System Pressure Cap

The cap must be fully tightened to prevent loss of engine coolant (antifreeze), and to ensure that engine coolant will return to the radiator from the coolant expansion bottle/recovery tank (if equipped).

The cap should be inspected and cleaned if there is any accumulation of foreign material on the sealing surfaces.

WARNING!

- Do not open a hot engine cooling system. Never add engine coolant (antifreeze) when the engine is overheated. Do not loosen or remove the cap to cool an overheated engine. Heat causes pressure to build up in the cooling system. To prevent scalding or injury, do not remove the pressure cap while the system is hot or under pressure.

(Continued)

WARNING!

- Do not use a pressure cap other than the one specified for your vehicle. Personal injury or engine damage may result.

Disposal Of Used Coolant

Used ethylene glycol-based coolant (antifreeze) is a regulated substance requiring proper disposal. Check with your local authorities to determine the disposal rules for your community. To prevent ingestion by animals or children, do not store ethylene glycol-based coolant in open containers or allow it to remain in puddles on the ground, clean up any ground spills immediately. If ingested by a child or pet, seek emergency assistance immediately.

Coolant Level

The coolant bottle provides a quick visual method for determining that the coolant level is adequate. With the engine off and cold, the level of the engine coolant (antifreeze) in the bottle should be between the ranges indicated on the bottle.

The radiator normally remains completely full, so there is no need to remove the radiator/coolant pressure cap unless checking for engine coolant freeze point or replacing coolant. Advise your service attendant of this. As long as the engine operating temperature is satisfactory, the coolant bottle need only be checked once a month.

When additional engine coolant is needed to maintain the proper level, only OAT coolant that meets the requirements of the manufacturer Material Standard MS.90032 should be added to the coolant bottle. Do not overfill.

Engine Coolant Level — 2.0L

WARNING!

- Do not open a hot engine cooling system. Never add engine coolant (antifreeze) when the engine is overheated. Do not loosen or remove the cap to cool an overheated engine. Heat causes pressure to build up in the cooling system. To prevent scalding or injury, do not remove the pressure cap while the system is hot or under pressure.
- Do not use a pressure cap other than the one specified for your vehicle. Personal injury or engine damage may result.

With the engine OFF and cold, the level of the engine coolant should be within the OK range between the ADD and FULL range on the dipstick.

1. Remove the cap with level dipstick from the engine coolant bottle.
2. Clean off the coolant from the dipstick.
3. Rest the cap on the opening of the coolant bottle without tightening the cap.
4. Remove the cap with dipstick and check the coolant level on the dipstick.

The radiator normally remains completely full, so there is no need to remove the radiator/coolant pressure cap unless checking for engine coolant freeze point or replacing coolant. Advise your service attendant of this. As long as the engine operating temperature is satisfactory, the coolant bottle need only be checked once a month.

When additional engine coolant is needed to maintain the proper level, only OAT coolant that meets the requirements of the manufacturer Material Standard MS.90032 should be added to the coolant bottle. Do not overfill.

Cooling System Notes

NOTE:

When the vehicle is stopped after a few miles/ kilometers of operation, you may observe vapor coming from the front of the engine compartment. This is normally a result of moisture from rain, snow, or high humidity accumulating on the radiator and being vaporized when the thermostat opens, allowing hot engine coolant (antifreeze) to enter the radiator.

If an examination of your engine compartment shows no evidence of radiator or hose leaks, the vehicle may be safely driven. The vapor will soon dissipate.

- Do not overfill the coolant expansion bottle.
- Check the coolant freeze point in the radiator and in the coolant expansion bottle. If engine coolant needs to be added, the contents of the coolant expansion bottle must also be protected against freezing.
- If frequent engine coolant additions are required, the cooling system should be pressure tested for leaks.
- Maintain engine coolant concentration at a minimum of 50% OAT coolant (conforming to MS.90032) and distilled water for proper corrosion protection of your engine which contains aluminum components.
- Make sure that the coolant expansion bottle overflow hoses are not kinked or obstructed.

- Keep the front of the radiator clean. If your vehicle is equipped with air conditioning, keep the front of the condenser clean.
- Do not change the thermostat for Summer or Winter operation. If replacement is ever necessary, install ONLY the correct type thermostat. Other designs may result in unsatisfactory engine cooling performance, poor gas mileage, and increased emissions.

BRAKE SYSTEM

In order to ensure brake system performance, all brake system components should be inspected periodically. For the proper maintenance intervals ⇨ page 270.

WARNING!

Riding the brakes can lead to brake failure and possibly a collision. Driving with your foot resting or riding on the brake pedal can result in abnormally high brake temperatures, excessive lining wear, and possible brake damage. You would not have your full braking capacity in an emergency.

Fluid Level Check — Brake Master Cylinder

The fluid level of the master cylinder should be checked whenever the vehicle is serviced, or immediately if the Brake System Warning Light is on. If necessary, add fluid to bring level within the designated marks on the side of the reservoir of the brake master cylinder. Be sure to clean the top of the master cylinder area before removing cap. With disc brakes, fluid level can be expected to fall as the brake pads wear. Brake fluid level should be checked when pads are replaced. If the brake fluid is abnormally low, check the system for leaks.

WARNING!

- Use only manufacturer's recommended brake fluid  page 326. Using the wrong type of brake fluid can severely damage your brake system and/or impair its performance. The proper type of brake fluid for your vehicle is also identified on the original factory installed hydraulic master cylinder reservoir.
- To avoid contamination from foreign matter or moisture, use only new brake fluid or fluid that has been in a tightly closed container. Keep the master cylinder reservoir cap secured at all times. Brake fluid in an open container absorbs moisture from the air resulting in a lower boiling point. This may cause it to boil unexpectedly during hard or prolonged braking, resulting in sudden brake failure. This could result in a collision.
- Overfilling the brake fluid reservoir can result in spilling brake fluid on hot engine parts, causing the brake fluid to catch fire. Brake fluid can also damage painted and vinyl surfaces, care should be taken to avoid its contact with these surfaces.
- Do not allow petroleum-based fluid to contaminate the brake fluid. Brake seal components could be damaged, causing partial or complete brake failure. This could result in a collision.

AUTOMATIC TRANSMISSION**Special Additives**

The manufacturer strongly recommends against using any special additives in the transmission. Automatic Transmission Fluid (ATF) is an engineered product and its performance may be impaired by supplemental additives. Therefore, do not add any fluid additives to the transmission. Avoid using transmission sealers as they may adversely affect seals.

CAUTION!

Do not use chemical flushes in your transmission as the chemicals can damage your transmission components. Such damage is not covered by the New Vehicle Limited Warranty.

Fluid Level Check

The fluid level is preset at the factory and does not require adjustment under normal operating conditions. Routine fluid level checks are not required; therefore the transmission has no dipstick. An authorized dealer can check your transmission fluid level using special service tools. If you notice fluid leakage or transmission malfunction, visit an authorized dealer immediately to have the transmission fluid level checked. Operating the vehicle with an improper fluid level can cause severe transmission damage.

CAUTION!

If a transmission fluid leak occurs, visit an authorized dealer immediately. Severe transmission damage may occur. An authorized dealer has the proper tools to adjust the fluid level accurately.

Fluid And Filter Changes

Routine fluid and filter changes are not required. However, change the fluid and filter if the fluid becomes contaminated (with water, etc.), or if the transmission is disassembled for any reason.

Selection Of Lubricant

It is important to use the proper transmission fluid to ensure optimum transmission performance and life. Use only the manufacturer's specified transmission fluid  page 326. It is important to maintain the transmission fluid at the correct level using the recommended fluid.

NOTE:

No chemical flushes should be used in any transmission; only the approved lubricant should be used.

CAUTION!

Using a transmission fluid other than the manufacturer's recommended fluid may cause deterioration in transmission shift quality and/or torque converter shudder.

FRONT/REAR AXLE FLUID

For normal service, periodic fluid level checks are not required. When the vehicle is serviced for other reasons the exterior surfaces of the axle assembly should be inspected. If gear oil leakage is suspected inspect the fluid level.

Front Axle Fluid Level Check

The front axle oil level needs to be no lower than 1/8 inch (3 mm) below the bottom of the fill hole.

The front axle fill and drain plugs should be tightened to 22 to 29 ft-lb (30 to 40 N·m).

CAUTION!

Do not overtighten the plugs as it could damage them and cause them to leak.

Rear Axle Fluid Level Check

The rear axle oil level needs to be no lower than 1/8 inch (3 mm) below the bottom of the fill hole.

The rear axle fill and drain plugs should be tightened to 22 to 29 ft-lb (30 to 40 N·m).

CAUTION!

Do not overtighten the plugs as it could damage them and cause them to leak.

Selection Of Lubricant

Use only the manufacturer's recommended fluid
 ⇨ page 326.

TRANSFER CASE

Fluid Level Check

For normal service, periodic fluid level checks are not required. When the vehicle is serviced for other reasons the exterior surfaces of the transfer case assembly should be inspected. If oil leakage is suspected inspect the fluid level.

Adding Fluid

Add fluid at the filler hole, until it runs out of the hole, when the vehicle is in a level position.

Drain

First remove fill plug, then remove drain plug. Recommended tightening torque for drain and fill plugs is 15 to 25 ft-lb (20 to 34 N·m).

CAUTION!

When installing plugs, do not overtighten. You could damage them and cause them to leak.

Selection Of Lubricant

Use only the manufacturer's recommended fluid
 ⇨ page 326.

FUSES

General Information

WARNING!

- When replacing a blown fuse, always use an appropriate replacement fuse with the same amp rating as the original fuse. Never replace a fuse with another fuse of higher amp rating. The use of a fuse with a rating other than indicated may result in a dangerous electrical system overload. If a properly rated fuse continues to blow, it indicates a problem in the circuit that must be corrected. Never replace a blown fuse with metal wires or any other material. Do not place a fuse inside a circuit breaker cavity or vice versa. Failure to use proper fuses may result in serious personal injury, fire and/or property damage.
- Before replacing a fuse, make sure that the ignition is off and that all the other services are switched off and/or disengaged.
- If the replaced fuse blows again, contact an authorized dealer.
- If a general protection fuse for safety systems (air bag system, braking system), power unit systems (engine system, transmission system) or steering system blows, contact an authorized dealer.

The fuses protect electrical systems against excessive current.

When a device does not work, you must check the fuse element inside the blade fuse for a break/melt.

Also, please be aware that using power outlets for extended periods of time with the engine off may result in vehicle battery discharge.

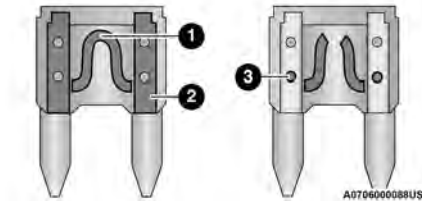

Blade Fuses

1 – Fuse Element

2 – Blade Fuse with a good/functional fuse element

3 – Blade Fuse with a bad/not functional fuse element (blown fuse)

CAUTION!

If it is necessary to wash the engine compartment, take care not to directly hit the fuse box, and the windshield wiper motor with water.

Underhood Fuses — Gasoline Engine

The Power Distribution Center (PDC) is located on the passenger side of the engine compartment, behind the headlamp. This center contains cartridge fuses, micro fuses, relays, and circuit breakers. A description of each fuse and component may be stamped on the inside cover, otherwise the cavity number of each fuse is stamped on the inside cover that corresponds to the following chart.

CAUTION!

When installing the power distribution center cover, it is important to ensure the cover is properly positioned and fully latched. Failure to do so may allow water to get into the power distribution center and possibly result in an electrical system failure.

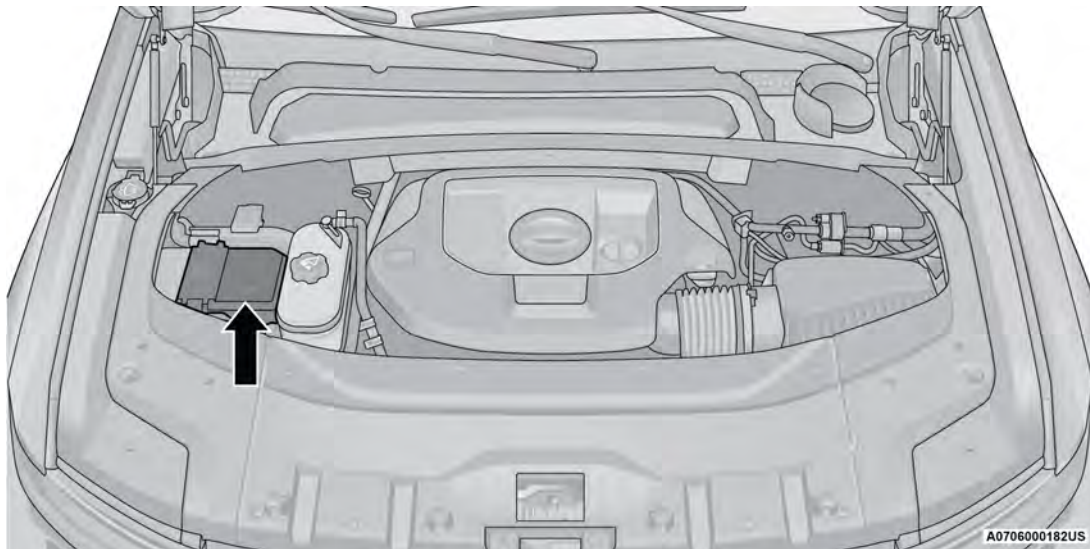

Power Distribution Center

NOTE:

Fuses for safety systems must be serviced by an authorized dealer.

Cavity	Cartridge Fuse	Micro Fuse * If Equipped	Description
F01	-	-	Crank Batt
F02	-	-	Spare
F03	500 Amp Gray	-	Starter
F04	250 Amp Gray	-	Alternator
F05	-	-	Spare
F06	-	-	Aux Battery
F07	100 Amp Gray	-	Rad Fan
F08	80 Amp Gray	-	ELEC PWR STR
F09	80 Amp Gray	-	ELEC PWR STR
F10	80 Amp Gray	-	Feed to IPDC
F11	150 Amp Gray	-	PCR *
F12	-	-	Not Populated
F13	40 Amp Green	-	Starter
F14	-	10 Amp Red	GNMM / VPMS *
F15	-	10 Amp Red	ECM *
F16	-	15 Amp Blue	Cluster
F17A	-	10 Amp Red	EPS
F17B			Not Populated
F18	-	-	Not Populated
F19	30 Amp Pink	-	BSM Valves #2 *
F20	-	-	Not Populated
F21	-	-	Not Populated
F22	-	-	Not Populated
F23A	-	10 Amp Red	ECM / EPS / PIM / SLM / GPF
F23B			Air Suspension / ELSD RR

Cavity	Cartridge Fuse	Micro Fuse * If Equipped	Description
F24	-	-	Not Populated
F25	-	-	Not Populated
F26	50 Amp Red	-	BSM Motor #2 *
F27	30 Amp Pink	-	Rear Defroster (EBL)
F28	-	-	Not Populated
F29	-	-	Not Populated
F30	-	-	Not Populated
F31	-	-	Not Populated
F32	-	-	Not Populated
F33	-	-	Not Populated
F34	-	-	Not Populated
F35	-	-	Not Populated
F36	50 Amp Red	-	BCM Feed #1
F37	30 Amp Pink	-	DTCM
F38	-	-	Not Populated
F39	-	-	Not Populated
F40	-	5 Amp Tan	Battery Sensor
F41	-	20 Amp Yellow	CADM MAP *
F42	-	-	Not Populated
F43	-	10 Amp Red	Engine Control Module (ECM)
F44	-	-	Not Populated
F45	-	15 Amp Blue	Front Axle Disconnect
F46	-	-	Not Populated
F47	-	-	Not Populated
F48	-	10 Amp Red	CVPAM

Cavity	Cartridge Fuse	Micro Fuse * If Equipped	Description
F49	-	-	Not Populated
F50	-	-	Not Populated
F51	-	20 Amp Yellow	Fuel Pump
F52	-	-	Not Populated
F53	-	-	Not Populated
F54	-	20 Amp Yellow	Headlamp LT
F55	-	15 Amp Blue	BPCM *
F56	-	-	Not Populated
F57	-	-	Not Populated
F58	-	-	Not Populated
F59	-	-	Not Populated
F60	-	-	Not Populated
F61	-	-	Not Populated
F62	-	-	Not Populated
F63	-	20 Amp Yellow	Camera Washer Front
F64	-	15 Amp Blue	Smart Bar Control Module
F65	-	15 Amp Blue	ACT Grille Shutter / ACT Rear Axle Coolant Valve / Active Air Dam
F66	-	20 Amp Yellow	Horns
F67	-	10 Amp Red	DTCM / ASBS / Switchable Engine Mount / BSM
F68	-	20 Amp Yellow	Headlamp RT
F69	-	-	Not Populated
F70	-	20 Amp Yellow	IGN Coil / IGN Capacitors / Fuel Inj
F71	-	-	Not Populated
F72	-	-	Not Populated
F73	-	-	Not Populated

Cavity	Cartridge Fuse	Micro Fuse * If Equipped	Description
F74	-	-	Not Populated
F75	-	-	Not Populated
F76	-	5 Amp Tan	IDCM *
F77	-	20 Amp Yellow	TCM SBW
F78	-	20 Amp Yellow	ECM
F79	-	10 Amp Red	Fuel Door / ELCM / Fuel Injectors *
F80	20 Amp Blue	-	ECM
F81	40 Amp Green	-	BCM Feed #4
F82	-	-	Not Populated
F83	40 Amp Green	-	LTR Coolant Pump * / Trans Oil Pump *
F84	-	-	Not Populated
F85	-	10 Amp Red	PCR *
F86	50 Amp Red	-	BSM Feed #1
F87	-	-	Not Populated
F88	50 Amp Red	-	BSM Feed #2
F89	-	-	Not Populated
F90	-	-	Not Populated
F91	-	-	Not Populated
F92	20 Amp Blue	-	Front De-Icer
F93	-	-	Not Populated
F94	-	10 Amp Red	A/C Compressor Clutch
F95	-	10 Amp Red	Batt Cool Heater *
F96	-	5 Amp Tan	Elect Cool Heater *
F97	-	-	Not Populated
F98	-	-	Not Populated

Cavity	Cartridge Fuse	Micro Fuse * If Equipped	Description
F99	-	-	Not Populated
F100A	-	-	Not Populated
F100B	-	-	Not Populated
F101	-	-	Not Populated
F102	-	-	Not Populated
F103	30 Amp Pink	-	Frnt Wiper
F104A	-	15 Amp Blue	PECP Low Temp Passive Pump *
F104B			AHP High Temp Aux Pump *
F105A	-	15 Amp Blue	BCP Low Temp Active Pump *
F105B			LTR Coolant Pump PECP - 2 *

Interior Power Distribution Center — Gasoline Engine

The Interior Power Distribution Center is located underneath the steering column on the driver's side of the vehicle. This center contains cartridge fuses, micro fuses, relays, and circuit breakers. Fuse numbers are labeled next to each fuse cavity, fuse descriptions correspond with the following chart.



Interior PDC Location

NOTE:

Fuses for safety systems must be serviced by an authorized dealer.

Cavity	Cartridge Fuse	Micro Fuse	Description
		* If Equipped	
F01	-	-	Spare
F02	25 Amp Clear	-	MTR Sunshade Sunroof Dual Pane / MTR sunroof single Pane
F03	-	15 Amp Blue	MOD Seat Heater Frt (Steering Wheel) *
F04	-	10 Amp Red	Night Vision Module / Driver Monitoring Camera (DMC)
F05	-	-	Spare
F06	-	-	Spare
F07	-	-	Spare
F08	-	15 Amp Blue	Automatic Gearbox Shifter Module (AGSM) / Steering Column Lock
F09	-	-	Spare
F10	40 Amp Green	-	HVAC Blower Motor
F11	-	-	Spare
F12	-	20 Amp Yellow	Assy Cigar Lighter
F13	-	10 Amp Red	Assy Mirror Inside Rearview / Digital TV (DTV) */ Sunroof Single - Dual Pane / Port UC1 Dual USB RR / Interior Monitoring Camera
F14	-	-	Spare
F15A	-	-	Spare
F15B	-	-	Spare
F16	-	10 Amp Red	MOD ORC
F17	-	-	Spare
F18	-	-	Spare
F19	-	-	Spare
F20	-	10 Amp Red	Overhead Console Assy (OHC) W/Sunshade / Intrusion Module / Intrusion Sensor / Siren / Head Up Display (HUD) / Digital TV (DTV) *
F21	30 Amp Pink	-	Trailer Tow Electric Brake - Aftermarket
F22	-	-	Spare
F23	-	-	Spare

Cavity	Cartridge Fuse	Micro Fuse * If Equipped	Description
F24	-	-	Spare
F25	-	-	Spare
F26	-	-	Spare
F27	-	-	Spare
F28	-	-	Spare
F29	-	-	Spare
F30	-	-	Spare
F31	-	-	Spare
F32	-	15 Amp Blue	MOD ICS Switch Bank / SW Bank Upper / SW EPB / Aux Switch Bank Module (ASBM)
F33	-	15 Amp Blue	Transfer case SW / Humidity Rain Light Sensor (HRLS) / Suspension SW *
F34	-	-	Spare
F35	-	10 Amp Red	IRCAM Heater
F36	-	-	Spare
F37	-	-	Spare
F38	-	-	Spare
F39	-	-	Spare
F40	-	-	Spare
F41A	-	10 Amp Red	MOD Occupant Class / Steering Column Lock
F41B			Spare
F42A	-	10 Amp Red	Parktronics System MOD (PTS) / MOD Haptic Lane Feedback / Trailer Tow Module
F42B			MOD HVAC Control / Frt ERC Motor Ctrl / RR ERC Motor Ctrl
F43A	-	-	Spare
F43B	-	-	Spare

Cavity	Cartridge Fuse	Micro Fuse	Description
		* If Equipped	
F44	-	15 Amp Blue	MOD Cluster CCN / MOD SGW (Cybersecurity)
F45	-	-	Spare
F46	-	-	Spare
F47A	-	-	Spare
F47B	-	-	Spare
F48A	-	-	Spare
F48B	-	-	Spare
F49	-	7.5 Amp Brown	MOD RF HUB / Module Ignition (MD KIN)
F50A	-	10 Amp Red	Telematics Box Module (TBM) / MOD Front Passenger Display Module (FPDM) / MOD DCSD *
F50B	-	-	Port Diagnostics 1 & 2
F51A	-	-	Spare
F51B	-	-	Spare
F52	-	-	Spare
F53	-	20 Amp Yellow	MOD CMCM (Radio)
F54A	-	-	Spare
F54B	-	-	Spare
F55	-	-	Spare
F56	-	-	Spare
F57	-	-	Spare
F58	-	-	Spare
F59	-	-	Spare
F60	-	-	Spare
F61	-	-	Spare
F62A	-	-	Spare
F62B	-	-	Spare

Cavity	Cartridge Fuse	Micro Fuse * If Equipped	Description
F63A	-	15 Amp Blue	Media HUB #1 Frt / Port UC1 Dual USB Frt / Wireless Charging Pad MOD (WCPM)
F63B			Not Populated
F64A	-	10 Amp Red	MOD ORC
F64B			Steering Column Control Module (SCCM)
F65	-	5 Amp Tan	MOD SGW (Cybersecurity)
F66	-	-	Spare
CB1	-	-	Spare
CB2	-	-	Spare
CB3	-	-	Spare
CB4	-	-	Spare
CB5	-	-	Spare
CB6	-	-	Spare

Rear Power Distribution Center — Gasoline Engine

The Rear Power Distribution Center is located underneath the passenger seat. This center contains cartridge fuses, micro fuses, relays, and circuit breakers. The following chart corresponds to the fuses inside.

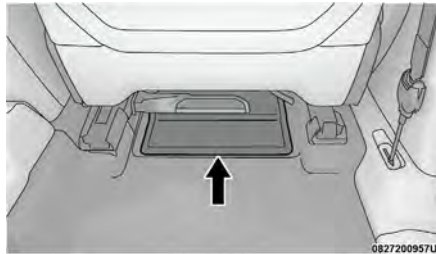

Rear Power Distribution Center

NOTE:

Fuses for safety systems must be serviced by an authorized dealer.

Cavity	Cartridge Fuse	Micro Fuse	Description
* If Equipped			
F01	-	-	Spare
F02	-	-	Spare
F03	Shunt	-	Auxiliary Battery Feed *
F04	-	-	Spare
F05	150 Amp Gray	-	Underhood PDC Feed *
F06	-	-	Spare
F07	-	-	Spare
F08	-	-	Spare
F09	-	-	Spare
F10	-	-	Spare
F11	50 Amp Red	-	Mod BCM Feed #2
F12	-	-	Spare
F13	-	-	Spare
F14	-	-	Spare
F15A	-	10 Amp Red	Spare
F15B			Hands-Free Liftgate / Rear Window Switches / MOD HVAC Cntrl Frt
F16	-	-	Spare
F17	40 Amp Green	-	Mod BCM Feed #3
F18	30 Amp Pink	-	Power Liftgate Module
F19A	-	-	Spare
F19B	-	-	Spare
F20A	-	15 Amp Blue	Central ADAS Decision Module (CADM)
F20B			Spare
F21A	-	-	Spare
F21B			

Cavity	Cartridge Fuse	Micro Fuse	Description
		* If Equipped	
F22	-	-	Spare
F23	-	10 Amp Red	Media Hub #2 (RR) / #3 (LR)
F24	-	-	Spare
F25	30 Amp Pink	-	Mod Door MUX Passenger
F26	20 Amp Blue	-	Headrest Dump 3rd Row (LT & RT) *
F27	-	-	Spare
F28	30 Amp Pink	-	MOD Memory / Power Seat (Passenger Frt)
F29A	-	10 Amp Red	MOD ICS Switch Bank Rear (Frt Console)
F29B			Spare
F30	30 Amp Pink	-	MOD Memory / Power Seat (Driver Frt)
F31	-	-	Spare
F32	-	-	Spare
F33	-	-	Spare
F34	30 Amp Pink	-	MOD Door MUX Driver
F35	25 Amp Clear	-	Trailer Tow Module #2
F36A	-	10 Amp Red	Intelligent Event Base Lighting Module
F36B			Port Pwr USB Console (USB CH Only) / Port UCI Dual USB Rear
F37	25 Amp Clear	-	Trailer Tow Module #1
F38	-	-	Spare
F39	-	-	Spare
F40	-	30 Amp Green	Mod Audio Amplifier #1A
F41	-	-	Spare
F42A	-	10 Amp Red	Spare
F42B			Rear Entertainment Screens 1 (Res1) / (Res2) / Media Hub #2 RR Wake Up / Media Hub #3 Wake Up / APO Illumination / 2nd - 3rd Row Seat Switches-Illumination

Cavity	Cartridge Fuse	Micro Fuse	Description
		* If Equipped	
F43	-	-	Spare
F44A	-	20 Amp Yellow	12 Volt Power Outlet Cargo Area (Ign)
F44B			12 Volt Power Outlet Cargo Area (Battery)
F45	-	20 Amp Yellow	MOD CRSM (Heated Seat RR RT)
F46	30 Amp Pink	-	Folding Seat Module 3rd Row Feed #1 *
F47	-	-	Spare
F48	-	-	Spare
F49	-	-	Spare
F50	-	15 Amp Blue	Seat Massage Driver Mod (SSMD) / Seat Massage Passenger Mod (SSMP) *
F51	-	30 Amp Green	MOD IAir Suspension (Valves)
F52	-	20 Amp Yellow	MOD CRSM (Heat Seat RR LT) *
F53	30 Amp Pink	-	Electronic Limited Slip Differential (ELSD) Rear #1
F54	-	-	Spare
F55	30 Amp Pink	-	MOD Inverter
F56	30 Amp Pink	-	Folding Seat Module 3rd Row Feed #2 *
F57	-	-	Spare
F58	-	15 Amp Blue	3rd Row Additional USB charge (Only LT - RT) / Port Pwr USB Console UBS (CH Only)
F59	-	-	Spare
F60	-	-	Spare
F61	-	-	Spare
F62	-	20 Amp Yellow	Module Seat Heater Frt (Driver) *
F63	30 Amp Pink	-	Assy Trailer Tow Receptacle B+
F64	-	-	Spare
F65	-	-	Spare

Cavity	Cartridge Fuse	Micro Fuse * If Equipped	Description
F66	20 Amp Blue	-	MOD Door MUX Passenger Rear - Smart Motor
F67	-	30 Amp Green	MOD Audio Amplifier #1B
F68	-	-	Spare
F69	-	20 Amp Yellow	L2+ Central ADAS Decision Module (CADM) MID *
F70	-	10 Amp Red	Video Routing Module (VRM) / Port Power - USB IP (USB Ch Only)
F71	-	-	Spare
F72	-	-	Spare
F73	-	-	Spare
F74	-	5 Amp Tan	L2+ Intelligent Battery Sensor (IBS) - 2 *
F75	-	-	Spare
F76	-	-	Spare
F77	-	-	Spare
F78	50 Amp Red	-	MOD IAir Suspension
F79	-	-	Spare
F80	-	-	Spare
F81	-	20 Amp Yellow	Module Seat Heater Frt (PASS) *
F82	-	10 Amp Red	SW Seat Heater (RR RT - RR LT) *
F83	-	-	Spare
F84	-	-	Spare
F85	-	-	Spare
F86	-	15 Amp Blue	Lumbar Support Driver - Passenger SW *
F87	-	-	Spare
F88	20 Amp Blue	-	MOD Door MUX Driver Rear - Smart Motor

BULB REPLACEMENT

Replacement Bulbs, Names, And Part Numbers

In the instance a bulb needs to be replaced, this section includes bulb description and replacement part numbers.

Interior Bulbs

The Interior lights are LED, for replacement of any LED lamps, see an authorized dealer.

Exterior Bulbs

The exterior lights are LED, for replacement of any LED lamps, see an authorized dealer.

TIRES

TIRE SAFETY INFORMATION

Tire safety information will cover aspects of the following information: Tire Markings, Tire Identification Numbers, Tire Terminology and Definitions, Tire Pressures, and Tire Loading.

Tire Markings

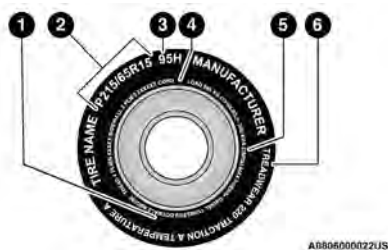

Tire Markings

- 1 – US DOT Safety Standards Code (TIN)
- 2 – Size Designation
- 3 – Service Description
- 4 – Maximum Load
- 5 – Maximum Pressure
- 6 – Treadwear, Traction and Temperature Grades

NOTE:

- P (Passenger) – Metric tire sizing is based on US design standards. P-Metric tires have the letter "P" molded into the sidewall preceding the size designation. Example: P215/65R15 95H.
- European – Metric tire sizing is based on European design standards. Tires designed to this standard have the tire size molded into the sidewall beginning with the section width. The letter "P" is absent from this tire size designation. Example: 215/65R15 96H.
- LT (Light Truck) – Metric tire sizing is based on US design standards. The size designation for LT-Metric tires is the same as for P-Metric tires except for the letters "LT" that are molded into the sidewall preceding the size designation. Example: LT235/85R16.
- Temporary spare tires are designed for temporary emergency use only. Temporary high pressure compact spare tires have the letter "T" or "S" molded into the sidewall preceding the size designation. Example: T145/80D18 103M.
- High flotation tire sizing is based on US design standards and it begins with the tire diameter molded into the sidewall. Example: 31x10.5 R15 LT.

TIRE SIZING CHART

EXAMPLE:
Example Size Designation: P215/65R15XL 95H, 215/65R15 96H, LT235/85R16C, T145/80D18 103M, 31x10.5 R15 LT
<p>P = Passenger car tire size based on US design standards, or "...blank..." = Passenger car tire based on European design standards, or LT = Light truck tire based on US design standards, or T or S = Temporary spare tire or 31 = Overall diameter in inches (in) 215, 235, 145 = Section width in millimeters (mm) 65, 85, 80 = Aspect ratio in percent (%) <ul style="list-style-type: none"> ● Ratio of section height to section width of tire, or 10.5 = Section width in inches (in)</p>
<p>R = Construction code <ul style="list-style-type: none"> ● "R" means radial construction, or ● "D" means diagonal or bias construction 15, 16, 18 = Rim diameter in inches (in)</p>
Service Description:
<p>95 = Load Index <ul style="list-style-type: none"> ● A numerical code associated with the maximum load a tire can carry H = Speed Symbol <ul style="list-style-type: none"> ● A symbol indicating the range of speeds at which a tire can carry a load corresponding to its load index under certain operating conditions ● The maximum speed corresponding to the speed symbol should only be achieved under specified operating conditions (i.e., tire pressure, vehicle loading, road conditions, and posted speed limits) </p>
Load Identification:
<p>Absence of the following load identification symbols on the sidewall of the tire indicates a Standard Load (SL) tire:</p> <ul style="list-style-type: none"> ● XL = Extra load (or reinforced) tire, or ● LL = Light load tire or ● C, D, E, F, G = Load range associated with the maximum load a tire can carry at a specified pressure
Maximum Load - Maximum load indicates the maximum load this tire is designed to carry
Maximum Pressure - Maximum pressure indicates the maximum permissible cold tire inflation pressure for this tire

Tire Identification Number (TIN)

The TIN may be found on one or both sides of the tire; however, the date code may only be on one side. Tires with white sidewalls will have the full TIN, including the date code, located on the white sidewall side of the tire. Look for the TIN on the outboard side of black sidewall tires as mounted on the vehicle. If the TIN is not found on the outboard side, then you will find it on the inboard side of the tire.

EXAMPLE:
DOT MA L9 ABCD 0301
DOT = Department of Transportation <ul style="list-style-type: none"> This symbol certifies that the tire is in compliance with the US Department of Transportation tire safety standards and is approved for highway use
MA = Code representing the tire manufacturing location (two digits)
L9 = Code representing the tire size (two digits)
ABCD = Code used by the tire manufacturer (one to four digits)
03 = Number representing the week in which the tire was manufactured (two digits) <ul style="list-style-type: none"> 03 means the 3rd week
01 = Number representing the year in which the tire was manufactured (two digits) <ul style="list-style-type: none"> 01 means the year 2001 Prior to July 2000, tire manufacturers were only required to have one number to represent the year in which the tire was manufactured. Example: 031 could represent the 3rd week of 1981 or 1991

Tire Terminology And Definitions

Term	Definition
B-pillar	The vehicle B-pillar is the structural member of the body located behind the front door.
Cold Tire Inflation Pressure	Cold tire inflation pressure is defined as the tire pressure after the vehicle has not been driven for at least three hours, or driven less than 1 mile (1.6 km) after sitting for a minimum of three hours. Inflation pressure is measured in units of psi (pounds per square inch) or kPa (kilopascals).
Maximum Inflation Pressure	The maximum inflation pressure is the maximum permissible cold tire inflation pressure for this tire. The maximum inflation pressure is molded into the sidewall.
Recommended Cold Tire Inflation Pressure	Vehicle manufacturer's recommended cold tire inflation pressure as shown on the tire placard.
Tire Placard	A label permanently attached to the vehicle describing the vehicle's loading capacity, the original equipment tire sizes and the recommended cold tire inflation pressures.

Tire Loading And Tire Pressure

NOTE:

The proper cold tire inflation pressure is listed on the driver's side B-pillar or the rear edge of the driver's side door.

Check the inflation pressure of each tire, including the spare tire (if equipped), at least monthly and inflate to the recommended pressure for your vehicle.

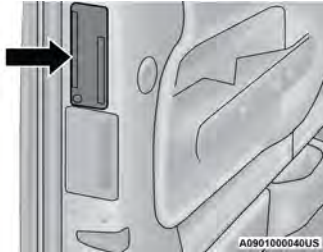

Example Tire Placard Location (Door)

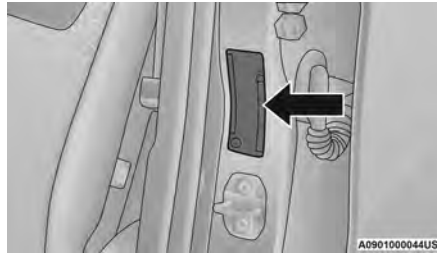

Example Tire Placard Location (B-pillar)

Tire And Loading Information Placard

TIRE AND LOADING INFORMATION			
SEATING CAPACITY - TOTAL 5 FRONT 2 REAR 3			
THE COMBINED WEIGHT OF OCCUPANTS AND CARGO SHOULD NEVER EXCEED XXX KG OR XXX LBS.			
TIRE	FRONT	REAR	SPARE
ORIGINAL TIRE SIZE	P195/70R14	P195/70R14	T125/70D15
COLD TIRE INFLATION PRESSURE	200kPa, 29PSI	200kPa, 29PSI	420kPa, 60PSI
SEE OWNER'S MANUAL FOR ADDITIONAL INFORMATION			4N109298

Tire And Loading Information Placard

This placard tells you important information about the:

1. Number of people that can be carried in the vehicle.
2. Total weight your vehicle can carry.
3. Tire size designed for your vehicle.
4. Cold tire inflation pressures for the front, rear, and spare tires.

Loading

The vehicle maximum load on the tire must not exceed the load carrying capacity of the tire on your vehicle. You will not exceed the tire's load carrying capacity if you adhere to the loading conditions, tire size, and cold tire inflation pressures specified on the Tire And Loading Information Placard in ↪ page 155.

NOTE:

Under a maximum loaded vehicle condition, Gross Axle Weight Rating (GAWR) for the front and rear axles must not be exceeded.

For further information on GAWR, vehicle loading, and trailer towing, refer ↪ page 155.

To determine the maximum loading conditions of your vehicle, locate the statement "The combined weight of occupants and cargo should never exceed XXX kg or XXX lbs" on the Tire And Loading Information Placard. The combined weight of occupants, cargo/luggage and trailer tongue weight (if applicable) should never exceed the weight referenced here.

Steps For Determining Correct Load Limit—

- (1) Locate the statement “The combined weight of occupants and cargo should never exceed XXX kg or XXX lbs.” on your vehicle’s placard.
- (2) Determine the combined weight of the driver and passengers that will be riding in your vehicle.
- (3) Subtract the combined weight of the driver and passengers from XXX kg or XXX lbs.
- (4) The resulting figure equals the available amount of cargo and luggage load capacity. For example, if “XXX” amount equals 1400 lbs. and there will be five 150 lb passengers in your vehicle, the amount of available cargo and luggage load capacity is 650 lbs. (1400-750 (5x150) = 650 lbs.)

(5) Determine the combined weight of luggage and cargo being loaded on the vehicle. That weight may not safely exceed the available cargo and luggage load capacity calculated in Step 4.

(6) If your vehicle will be towing a trailer, load from your trailer will be transferred to your vehicle. Consult this manual to determine how this reduces the available cargo and luggage load capacity of your vehicle.

Metric Example For Load Limit

For example, if “XXX” amount equals 635 kg and there will be five 68 kg passengers in your vehicle, the amount of available cargo and luggage load capacity is 295 kg (635-340 (5x68) = 295 kg) as shown in step 4.

NOTE:

- If your vehicle will be towing a trailer, load from your trailer will be transferred to your vehicle. The following table shows examples on how to calculate total load, cargo/luggage, and towing capacities of your vehicle with varying seating configurations and number and size of occupants. This table is for illustration purposes only and may not be accurate for the seating and load carry capacity of your vehicle.
- For the following example, the combined weight of occupants and cargo should never exceed 865 lbs (392 kg).

Occupants			Combined weight of occupants and cargo from Tire Placard	MINUS	Combined Occupant's weight	=	AVAILABLE Cargo/Luggage and Trailer Tongue Weight
TOTAL	FRONT	REAR					
EXAMPLE 1			865 lbs	minus	670 lbs	=	195 lbs
5	2	3					
EXAMPLE 2			865 lbs	minus	540 lbs	=	325 lbs
3	2	1					
EXAMPLE 3			865 lbs	minus	400 lbs	=	465 lbs
2	2	0					

811a4d11

8

WARNING!

Overloading of your tires is dangerous. Overloading can cause tire failure, affect vehicle handling, and increase your stopping distance. Use tires of the recommended load capacity for your vehicle. Never overload them.

TIRES — GENERAL INFORMATION

Tire Pressure

Proper tire inflation pressure is essential to the safe and satisfactory operation of your vehicle. Four primary areas are affected by improper tire pressure:

- Safety
- Fuel Economy
- Tread Wear
- Ride Comfort and Vehicle Stability

Safety

WARNING!

- Improperly inflated tires are dangerous and can cause collisions.
- Underinflation increases tire flexing and can result in overheating and tire failure.
- Overinflation reduces a tire's ability to cushion shock. Objects on the road and chuckholes can cause damage that result in tire failure.
- Overinflated or underinflated tires can affect vehicle handling and can fail suddenly, resulting in loss of vehicle control.
- Unequal tire pressures can cause steering problems. You could lose control of your vehicle.
- Unequal tire pressures from one side of the vehicle to the other can cause the vehicle to drift to the right or left.
- Always drive with each tire inflated to the recommended cold tire inflation pressure.

Both underinflation and overinflation affect the stability of the vehicle and can produce a feeling of sluggish response or over responsiveness in the steering.

NOTE:

- Unequal tire pressures from side to side may cause erratic and unpredictable steering response.
- Unequal tire pressure from side to side may cause the vehicle to drift left or right.

Fuel Economy

Underinflated tires will increase tire rolling resistance resulting in higher fuel consumption.

Tread Wear

Improper cold tire inflation pressures can cause abnormal wear patterns and reduced tread life, resulting in the need for earlier tire replacement.

Ride Comfort And Vehicle Stability

Proper tire inflation contributes to a comfortable ride. Overinflation produces a jarring and uncomfortable ride.

Tire Inflation Pressures

The proper cold tire inflation pressure is listed on the driver's side B-pillar or rear edge of the driver's side door.

NOTE:

The recommended pressures may be different for the front and rear axles.

At least once a month:

- Check and adjust tire pressure with a good quality pocket-type pressure gauge. Do not make a visual judgment when determining proper inflation. Tires may look properly inflated even when they are under-inflated.
- Inspect tires for signs of tire wear or visible damage.

CAUTION!

After inspecting or adjusting the tire pressure, always reinstall the valve stem cap. This will prevent moisture and dirt from entering the valve stem, which could damage the valve stem.

Inflation pressures specified on the placard are always "cold tire inflation pressure". Cold tire inflation pressure is defined as the tire pressure after the vehicle has not been driven for at least three hours, or driven less than 1 mile (1.6 km) after sitting for a minimum of three hours. The cold tire inflation pressure must not exceed the maximum inflation pressure molded into the tire sidewall.

Check tire pressures more often if subject to a wide range of outdoor temperatures, as tire pressures vary with temperature changes.

Tire pressures change by approximately 1 psi (7 kPa) per 12°F (7°C) of air temperature change. Keep this in mind when checking tire pressure inside a garage, especially in the Winter.

Example: If garage temperature = 68°F (20°C) and the outside temperature = 32°F (0°C) then the cold tire inflation pressure should be increased by 3 psi (21 kPa), which equals 1 psi (7 kPa) for every 12°F (7°C) for this outside temperature condition.

Tire pressure may increase from 2 to 6 psi (13 to 40 kPa) during operation. DO NOT reduce this normal pressure buildup or your tire pressure will be too low.

Tire Pressures For High Speed Operation

The manufacturer advocates driving at safe speeds and within posted speed limits. Where speed limits or conditions are such that the vehicle can be driven at high speeds, maintaining correct tire inflation pressure is very important. Increased tire pressure and reduced vehicle loading may be required for high-speed vehicle operation. Refer to an authorized tire dealer or original equipment vehicle dealer for recommended safe operating speeds, loading and cold tire inflation pressures.

WARNING!

High speed driving with your vehicle under maximum load is dangerous. The added strain on your tires could cause them to fail. You could have a serious collision. Do not drive a vehicle loaded to the maximum capacity at continuous speeds above 75 mph (120 km/h).

Radial Ply Tires

WARNING!

Combining radial ply tires with other types of tires on your vehicle will cause your vehicle to handle poorly. The instability could cause a collision. Always use radial ply tires in sets of four. Never combine them with other types of tires.

Tire Repair

If your tire becomes damaged, it may be repaired if it meets the following criteria:

- The tire has not been driven on when flat.
- The damage is only on the tread section of your tire (sidewall damage is not repairable).
- The puncture is no greater than $\frac{1}{4}$ of an inch (6 mm).

Consult an authorized tire dealer for tire repairs and additional information.

Damaged Run Flat tires, or Run Flat tires that have experienced a loss of pressure should be replaced immediately with another Run Flat tire of identical size and service description (Load Index and Speed Symbol). Replace the tire pressure sensor as well as it is not designed to be reused.

Run Flat Tires — If Equipped

Run Flat tires allow you the capability to drive 50 miles (80 km) at 50 mph (80 km/h) after a rapid loss of inflation pressure. This rapid loss of inflation is referred to as the Run Flat mode. A Run Flat mode occurs when the tire inflation pressure is of/or below 14 psi (96 kPa). Once a Run Flat tire reaches the Run Flat mode it has limited driving capabilities and needs to be replaced immediately. A Run Flat tire is not repairable. When a Run Flat tire is changed after being driven in a Run Flat mode 14 psi (96 kPa) condition, please replace the TPMS sensor as it is not designed to be reused.

NOTE:

TPMS sensor must be replaced after driving the vehicle on a flat tire condition.

It is not recommended driving a vehicle loaded at full capacity or to tow a trailer while a tire is in the Run Flat mode.

See the Tire Pressure Monitoring System section for more information ↪ page 218.

Tire Spinning

When stuck in mud, sand, snow, or ice conditions, do not spin your vehicle's wheels above 30 mph (48 km/h) or for longer than 30 seconds continuously without stopping.

For further information ↪ page 267.

WARNING!

Fast spinning tires can be dangerous. Forces generated by excessive wheel speeds may cause tire damage or failure. A tire could explode and injure someone. Do not spin your vehicle's wheels faster than 30 mph (48 km/h) for more than 30 seconds continuously when you are stuck, and do not let anyone near a spinning wheel, no matter what the speed.

Tread Wear Indicators

Tread wear indicators are in the original equipment tires to help you in determining when your tires should be replaced.

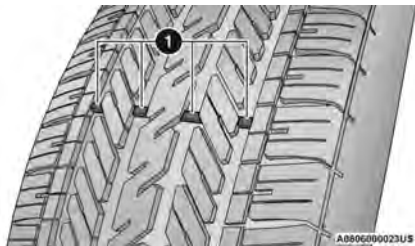

Tire Tread

1 — Tread Wear Indicators

These indicators are molded into the bottom of the tread grooves. They will appear as bands when the tread depth becomes 1/16 of an inch (1.6 mm). When the tread is worn to the tread wear indicators, the tire should be replaced.

For further information ↗ page 312.

Life Of Tire

The service life of a tire is dependent upon varying factors including, but not limited to:

- Driving style
- Tire pressure - Improper cold tire inflation pressures can cause uneven wear patterns to develop across the tire tread. These abnormal wear patterns will reduce tread life, resulting in the need for earlier tire replacement.

- Distance driven
- Performance tires, tires with a speed rating of V or higher, and Summer tires typically have a reduced tread life. Rotation of these tires per the vehicle scheduled maintenance is highly recommended.

WARNING!

Tires and the spare tire should be replaced after six years, regardless of the remaining tread. Failure to follow this warning can result in sudden tire failure. You could lose control and have a collision resulting in serious injury or death.

NOTE:

Wheel valve stem must be replaced as well when installing new tires due to wear and tear in existing tires.

Keep dismantled tires in a cool, dry place with as little exposure to light as possible. Protect tires from contact with oil, grease, and gasoline.

Replacement Tires

The tires on your new vehicle provide a balance of many characteristics. They should be inspected regularly for wear and correct cold tire inflation pressures. The manufacturer strongly recommends using tires equivalent to the originals in size, quality and performance when replacement is needed ↗ page 312. Refer to the Tire And Loading Information Placard or the Vehicle Certification Label for the size designation of your tire. The Load Index and Speed Symbol for your tire will be found on the original equipment tire sidewall.

See the Tire Sizing Chart example found in the "Tire Safety Information" section of this manual for more information relating to the Load Index and Speed Symbol of a tire.

It is recommended to replace the two front tires or two rear tires as a pair. Replacing just one tire can seriously affect your vehicle's handling. If you ever replace a wheel, make sure that the wheel's specifications match those of the original wheels.

It is recommended you contact an authorized tire dealer or original equipment dealer with any questions you may have on tire specifications or capability. Failure to use equivalent replacement tires may adversely affect the safety, handling, and ride of your vehicle.

WARNING!

- Do not use a tire, wheel size, load rating, or speed rating other than that specified for your vehicle. Some combinations of unapproved tires and wheels may change suspension dimensions and performance characteristics, resulting in changes to steering, handling, and braking of your vehicle. This can cause unpredictable handling and stress to steering and suspension components. You could lose control and have a collision resulting in serious injury or death. Use only the tire and wheel sizes with load ratings approved for your vehicle.
- Never use a tire with a smaller load index or capacity, other than what was originally equipped on your vehicle. Using a tire with a smaller load index could result in tire overloading and failure. You could lose control and have a collision.
- Failure to equip your vehicle with tires having adequate speed capability can result in sudden tire failure and loss of vehicle control.

CAUTION!

Replacing original tires with tires of a different size may result in false speedometer and odometer readings.

WARNING!

Do not use Summer tires in snow/ice conditions. You could lose vehicle control, resulting in severe injury or death. Driving too fast for conditions also creates the possibility of loss of vehicle control.

TIRE TYPES

All Season Tires — If Equipped

All Season tires provide traction for all seasons (Spring, Summer, Autumn, and Winter). Traction levels may vary between different all season tires. All season tires can be identified by the M+S, M&S, M/S or MS designation on the tire sidewall. Use all season tires only in sets of four; failure to do so may adversely affect the safety and handling of your vehicle.

Summer Or Three Season Tires — If Equipped

Summer tires provide traction in both wet and dry conditions, and are not intended to be driven in snow or on ice. If your vehicle is equipped with Summer tires, be aware these tires are not designed for Winter or cold driving conditions. Install Winter tires on your vehicle when ambient temperatures are less than 40 °F (5 °C) or if roads are covered with ice or snow. For more information, contact an authorized dealer.

Summer tires do not contain the all season designation or mountain/snowflake symbol on the tire sidewall. Use Summer tires only in sets of four; failure to do so may adversely affect the safety and handling of your vehicle.

Snow Tires



Some areas of the country require the use of snow tires during the Winter. Snow tires can be identified by a mountain/snowflake symbol on the tire sidewall.

If you need snow tires, select tires equivalent in size and type to the original equipment tires. Use snow tires only in sets of four; failure to do so may adversely affect the safety and handling of your vehicle.

Snow tires generally have lower speed ratings than what was originally equipped with your vehicle and should not be operated at sustained speeds over 75 mph (120 km/h). For speeds above 75 mph (120 km/h) refer to original equipment or an authorized tire dealer for recommended safe operating speeds, loading and cold tire inflation pressures.

While studded tires improve performance on ice, skid and traction capability on wet or dry surfaces may be poorer than that of non-studded tires. Some states prohibit studded tires; therefore, local laws should be checked before using these tire types.

SPARE TIRES — IF EQUIPPED

NOTE:

For vehicles equipped with Tire Service Kit instead of a spare tire, please refer to "Tire Service Kit" in "In Case Of Emergency" for further information.

CAUTION!

Because of the reduced ground clearance, do not take your vehicle through an automatic car wash with a compact or limited use temporary spare installed. Damage to the vehicle may result.

For restrictions when towing with a spare tire designated for temporary emergency use → page 161.

Spare Tire Matching Original Equipped Tire And Wheel — If Equipped

Your vehicle may be equipped with a spare tire and wheel equivalent in look and function to the original equipment tire and wheel found on the front or rear axle of your vehicle. This spare tire may be used in the tire rotation for your vehicle. If your vehicle has this option, refer to an authorized tire dealer for the recommended tire rotation pattern.

Compact Spare Tire — If Equipped

The compact spare is for temporary emergency use only. You can identify if your vehicle is equipped with a compact spare by looking at the spare tire description on the Tire And Loading Information Placard located on the driver's side door opening or on the sidewall of the tire. Compact spare tire descriptions begin with the letter "T" or "S" preceding the size designation. Example: T145/80D18 103M.

T, S = Temporary Spare Tire

Since this tire has limited tread life, the original equipment tire should be repaired (or replaced) and reinstalled on your vehicle at the first opportunity.

Do not install a wheel cover or attempt to mount a conventional tire on the compact spare wheel, since the wheel is designed specifically for the compact spare tire. Do not install more than one compact spare tire and wheel on the vehicle at any given time.

WARNING!

Compact and collapsible spares are for temporary emergency use only. With these spares, do not drive more than 50 mph (80 km/h). Temporary use spares have limited tread life. When the tread is worn to the tread wear indicators, the temporary use spare tire needs to be replaced. Be sure to follow the warnings, which apply to your spare. Failure to do so could result in spare tire failure and loss of vehicle control.

Collapsible Spare Tire — If Equipped

The collapsible spare is for temporary emergency use only. You can identify if your vehicle is equipped with a collapsible spare by looking at the spare tire description on the Tire And Loading Information Placard located on the driver's side door opening or on the sidewall of the tire.

Collapsible spare tire description example:
165/80-17 101P.

Since this tire has limited tread life, the original equipment tire should be repaired (or replaced) and reinstalled on your vehicle at the first opportunity.

Inflate collapsible tire only after the wheel is properly installed to the vehicle. Inflate the collapsible tire using the electric air pump before lowering the vehicle.

Do not install a wheel cover or attempt to mount a conventional tire on the collapsible spare wheel, since the wheel is designed specifically for the collapsible spare tire.

WARNING!

Compact and Collapsible spares are for temporary emergency use only. With these spares, do not drive more than 50 mph (80 km/h). Temporary use spares have limited tread life. When the tread is worn to the tread wear indicators, the temporary use spare tire needs to be replaced. Be sure to follow the warnings, which apply to your spare. Failure to do so could result in spare tire failure and loss of vehicle control.

Full Size Spare — If Equipped

The full size spare is for temporary emergency use only. This tire may look like the originally equipped tire on the front or rear axle of your vehicle, but it is not. This spare tire may have limited tread life. When the tread is worn to the tread wear indicators, the temporary use full size spare tire needs to be replaced. Since it is not the same as your original equipment tire, replace (or repair) the original equipment tire and reinstall on the vehicle at the first opportunity.

Limited Use Spare — If Equipped

The limited use spare tire is for temporary emergency use only. This tire is identified by a label located on the limited use spare wheel. This label contains the driving limitations for this spare. This tire may look like the original equipped tire on the front or rear axle of your vehicle, but it is not. Installation of this limited use spare tire affects vehicle handling. Since it is not the same as your original equipment tire, replace (or repair) the original equipment tire and reinstall on the vehicle at the first opportunity.

WARNING!

Limited use spares are for emergency use only. Installation of this limited use spare tire affects vehicle handling. With this tire, do not drive more than the speed listed on the limited use spare wheel. Keep inflated to the cold tire inflation pressures listed on your Tire And Loading Information Placard located on the driver's side B-pillar or the rear edge of the driver's side door. Replace (or repair) the original equipment tire at the first opportunity and reinstall it on your vehicle. Failure to do so could result in loss of vehicle control.

WHEEL AND WHEEL TRIM CARE

All wheels and wheel trim, especially aluminum and chrome plated wheels, should be cleaned regularly using mild (neutral Ph) soap and water to maintain their luster and to prevent corrosion. Wash wheels with the same soap solution recommended for the body of the vehicle and remember to always wash when the surfaces are not hot to the touch.

Your wheels are susceptible to deterioration caused by salt, sodium chloride, magnesium chloride, calcium chloride, etc., and other road chemicals used to melt ice or control dust on dirt roads. Use a soft cloth or sponge and mild soap to wipe away promptly. Do not use harsh chemicals or a stiff brush. They can damage the wheel's protective coating that helps keep them from corroding and tarnishing.

CAUTION!

Avoid products or automatic car washes that use acidic solutions or strong alkaline additives or harsh brushes. Many aftermarket wheel cleaners and automatic car washes may damage the wheel's protective finish. Such damage is not covered by the New Vehicle Limited Warranty. Only car wash soap, Mopar® Wheel Cleaner or equivalent is recommended.

When cleaning extremely dirty wheels including excessive brake dust, care must be taken in the selection of tire and wheel cleaning chemicals and equipment to prevent damage to the wheels. Mopar® Wheel Treatment or Mopar® Chrome Cleaner or their equivalent is recommended or select a non-abrasive, non-acidic cleaner for aluminum or chrome wheels.

CAUTION!

Do not use scouring pads, steel wool, a bristle brush, metal polishes or oven cleaner. These products may damage the wheel's protective finish. Such damage is not covered by the New Vehicle Limited Warranty. Only car wash soap, Mopar® Wheel Cleaner or equivalent is recommended.

NOTE:

If you intend parking or storing your vehicle for an extended period after cleaning the wheels with wheel cleaner, drive your vehicle and apply the brakes to remove the water droplets from the brake components. This activity will remove the red rust on the brake rotors and prevent vehicle vibration when braking.

Dark Vapor Chrome, Black Satin Chrome, or Low Gloss Clear Coat Wheels

CAUTION!

If your vehicle is equipped with these specialty wheels, DO NOT USE wheel cleaners, abrasives, or polishing compounds. They will permanently damage this finish and such damage is not covered by the New Vehicle Limited Warranty. HAND WASH ONLY USING MILD SOAP AND WATER WITH A SOFT CLOTH. Used on a regular basis; this is all that is required to maintain this finish.

SNOW TRACTION DEVICES

Use of traction devices require sufficient tire-to-body clearance. Due to limited clearance, the following snow traction devices are recommended. Follow these recommendations to guard against damage:

- Snow traction device must be of proper size for the tire, as recommended by the snow traction device manufacturer.
- No other tire sizes are recommended for use with the snow traction device.
- Please see the following table for the recommended tire size, axle and snow traction device:

4x2 Trim Level	Axle	Tire/Wheel Size	Snow Traction Device (Maximum Projection Beyond Tire Profile Or Equivalent)
LAREDO	Rear	P245/70R17-Two Row Only 265/60R18 265/50R20	S Class
LIMITED		265/60R18 265/50R20	
OVERLAND		265/50R20	
SUMMIT		265/50R20	20" - S Class

4x4 Trim Level	Axle	Tire/Wheel Size	Snow Traction Device (Maximum Projection Beyond Tire Profile Or Equivalent)
LAREDO	Rear	P245/70R17-Two Row Only 265/60R18 265/50R20	S Class
TRAILHAWK-Two Row Only		265/60R18	
LIMITED OVERLAND		265/60R18 265/50R20	
SUMMIT		265/50R20 275/45R21XL	20" - S Class 21" - 12 mm

WARNING!

Using tires of different size and type (M+S, Snow) between front and rear axles can cause unpredictable handling. You could lose control and have a collision.

CAUTION!

To avoid damage to your vehicle or tires, observe the following precautions:

- Because of restricted traction device clearance between tires and other suspension components, it is important that only traction devices in good condition are used. Broken devices can cause serious damage. Stop the vehicle immediately if noise occurs that could indicate device breakage. Remove the damaged parts of the device before further use.
- Install device as tightly as possible and then retighten after driving about ½ mile (0.8 km).
- Do not exceed 30 mph (48 km/h).
- Drive cautiously and avoid severe turns and large bumps, especially with a loaded vehicle.
- Do not drive for a prolonged period on dry pavement.
- Observe the traction device manufacturer's instructions on the method of installation, operating speed, and conditions for use. Always use the suggested operating speed of the device manufacturer's if it is less than 30 mph (48 km/h).
- Do not use traction devices on a compact spare tire.

TIRE ROTATION RECOMMENDATIONS

The tires on the front and rear of your vehicle operate at different loads and perform different steering, handling, and braking functions. For these reasons, they wear at unequal rates.

These effects can be reduced by timely rotation of tires. The benefits of rotation are especially worthwhile with aggressive tread designs such as those on On/Off-Road type tires. Rotation will increase tread life, help to maintain mud, snow, and wet traction levels, and contribute to a smooth, quiet ride.

Refer to the "Maintenance Plan" for the proper maintenance intervals. More frequent rotation is permissible if desired. The reasons for any rapid or unusual wear should be corrected prior to rotation being performed.

NOTE:

The premium Tire Pressure Monitoring System will automatically locate the pressure values displayed in the correct vehicle position following a tire rotation.

The suggested rotation method is the "rearward cross" shown in the following diagram.

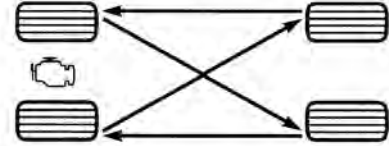

055703771

Tire Rotation (Rearward Cross)

DEPARTMENT OF TRANSPORTATION UNIFORM TIRE QUALITY GRADES

The following tire grading categories were established by the National Highway Traffic Safety Administration. The specific grade rating assigned by the tire's manufacturer in each category is shown on the sidewall of the tires on your vehicle.

All passenger vehicle tires must conform to Federal safety requirements in addition to these grades.

TREADWEAR

The Treadwear grade is a comparative rating, based on the wear rate of the tire when tested under controlled conditions on a specified government test course. For example, a tire graded 150 would wear one and one-half times as well on the government course as a tire graded 100. The relative performance of tires depends upon the actual conditions of their use, however, and may depart significantly from the norm due to variations in driving habits, service practices, and differences in road characteristics and climate.

TRACTION GRADES

The Traction grades, from highest to lowest, are AA, A, B, and C. These grades represent the tire's ability to stop on wet pavement, as measured under controlled conditions on specified government test surfaces of asphalt and concrete. A tire marked C may have poor traction performance.

WARNING!

The traction grade assigned to this tire is based on straight-ahead braking traction tests, and does not include acceleration, cornering, hydroplaning, or peak traction characteristics.

TEMPERATURE GRADES

The Temperature grades are A (the highest), B, and C, representing the tire's resistance to the generation of heat and its ability to dissipate heat, when tested under controlled conditions on a specified indoor laboratory test wheel.

Sustained high temperature can cause the material of the tire to degenerate and reduce tire life, and excessive temperature can lead to sudden tire failure. The grade C corresponds to a level of performance, which all passenger vehicle tires must meet under the Federal Motor Vehicle Safety Standard No.

109. Grades B and A represent higher levels of performance on the laboratory test wheel, than the minimum required by law.

WARNING!

The temperature grade for this tire is established for a tire that is properly inflated and not overloaded. Excessive speed, underinflation, or excessive loading, either separately or in combination, can cause heat buildup and possible tire failure.

STORING THE VEHICLE — GRAND CHEROKEE

If you are storing your vehicle for more than three weeks, we recommend that you take the following steps to minimize the drain on your vehicle's battery:

- Disconnect the negative cable from battery.
- Any time you store your vehicle or keep it out of service (i.e., vacation) for two weeks or more, run the air conditioning system at idle for about five minutes in the fresh air and high blower setting. This will ensure adequate system lubrication to minimize the possibility of compressor damage when the system is started again.

BODYWORK

PROTECTION FROM ATMOSPHERIC AGENTS

Vehicle body care requirements vary according to geographic locations and usage. Chemicals that make roads passable in snow and ice and those that are sprayed on trees and road surfaces during our seasons are highly corrosive to the metal in your vehicle. Outside parking, which exposes your vehicle to airborne contaminants, road surfaces on which the vehicle is operated, extreme hot or cold weather and other extreme conditions will have an adverse effect on paint, metal trim, and underbody protection.

The following maintenance recommendations will enable you to obtain maximum benefit from the corrosion resistance built into your vehicle.

What Causes Corrosion?

Corrosion is the result of deterioration or removal of paint and protective coatings from your vehicle.

The most common causes are:

- Road salt, dirt and moisture accumulation.
- Stone and gravel impact.
- Insects, tree sap and tar.
- Salt in the air near seacoast localities.
- Atmospheric fallout/industrial pollutants.

BODY AND UNDERBODY MAINTENANCE

Cleaning Headlights

Your vehicle is equipped with plastic headlights and fog lights that are lighter and less susceptible to stone breakage than glass headlights.

Plastic is not as scratch resistant as glass and therefore different lens cleaning procedures must be followed.

To minimize the possibility of scratching the lenses and reducing light output, avoid wiping with a dry cloth. To remove road dirt, wash with a mild soap solution followed by rinsing.

Do not use abrasive cleaning components, solvents, steel wool or other aggressive material to clean the lenses.

PRESERVING THE BODYWORK

Washing

- Wash your vehicle regularly. Always wash your vehicle in the shade using Mopar® Car Wash, or a mild car wash soap, and rinse the panels completely with water.
- If insects, tar, or other similar deposits have accumulated on your vehicle, use Mopar® Super Kleen Bug and Tar Remover to remove.
- Use a high quality cleaner wax, such as Mopar® Cleaner Wax to remove road film, stains and to protect your paint finish. Use precautions to not scratch the paint.
- Avoid using abrasive compounds and power buffing that may diminish the gloss or thin out the paint finish.

CAUTION!

- Do not use abrasive or strong cleaning materials such as steel wool or scouring powder that will scratch metal and painted surfaces.
- Use of power washers exceeding 1,200 psi (8,274 kPa) can result in damage or removal of paint and decals.

Special Care

- If you drive on salted or dusty roads or if you drive near the ocean, hose off the undercarriage at least once a month.
- It is important that the drain holes in the lower edges of the doors, rocker panels, and trunk be kept clear and open.
- If you detect any stone chips or scratches in the paint, touch them up immediately.
- If your vehicle is damaged due to a collision or similar cause that destroys the paint and protective coating, have your vehicle repaired as soon as possible.
- If you carry special cargo such as chemicals, fertilizers, de-icer salt, etc., be sure that such materials are well packaged and sealed.
- If a lot of driving is done on gravel roads, consider mud or stone shields behind each wheel.
- Use Mopar® Touch Up Paint on scratches as soon as possible. An authorized dealer has touch up paint to match the color of your vehicle.

INTERIORS

SEATS AND FABRIC PARTS

Use Mopar® Total Clean to clean fabric upholstery and carpeting.

WARNING!

Do not use volatile solvents for cleaning purposes. Many are potentially flammable, and if used in closed areas they may cause respiratory harm.

Seat Belt Maintenance

Do not bleach, dye or clean the belts with chemical solvents or abrasive cleaners. This will weaken the fabric. Sun damage can also weaken the fabric.

If the belts need cleaning, use a mild soap solution or lukewarm water. Do not remove the belts from the vehicle to wash them. Dry with a soft cloth.

Replace the belts if they appear frayed or worn or if the buckles do not work properly.

WARNING!

A frayed or torn seat belt could rip apart in a collision and leave you with no protection. Inspect the seat belt system periodically, checking for cuts, frays, or loose parts. Damaged parts must be replaced immediately. Do not disassemble or modify the seat belt system. If your vehicle is involved in a collision, or if you have questions regarding seat belt or retractor conditions, take your vehicle to an authorized FCA dealer or authorized FCA Certified Collision Care Program facility for inspection.

PLASTIC AND COATED PARTS

Use Mopar® Total Clean to clean vinyl upholstery.

CAUTION!

- Direct contact of air fresheners, insect repellents, suntan lotions, or hand sanitizers to the plastic, painted, or decorated surfaces of the interior may cause permanent damage. Wipe away immediately.
- Damage caused by these type of products may not be covered by your New Vehicle Limited Warranty.

Cleaning Plastic Instrument Cluster Lenses

The lenses in front of the instruments in this vehicle are molded in clear plastic. When cleaning the lenses, care must be taken to avoid scratching the plastic.

Clean with a wet soft cloth. A mild soap solution may be used, but do not use high alcohol content or abrasive cleaners. If soap is used, wipe clean with a clean damp cloth. Dry with a soft cloth.

LEATHER SURFACES

Mopar® Total Clean is specifically recommended for leather upholstery.

The leather upholstery can be best preserved by regular cleaning with a damp soft cloth. Small particles of dirt can act as an abrasive and damage the leather upholstery and should be removed promptly with a damp cloth. Stubborn soils can be removed easily with a soft cloth and Mopar® Total Clean. Care should be taken to

avoid soaking your leather upholstery with any liquid. Please do not use polishes, oils, cleaning fluids, solvents, detergents, or ammonia-based cleaners to clean your leather upholstery.

NOTE:

If equipped with light colored leather, it tends to show any foreign material, dirt, and fabric dye transfer more so than darker colors. The leather is designed for easy cleaning, and the manufacturer recommends Mopar® total care leather cleaner applied on a cloth to clean the leather seats as needed.

CAUTION!

Do not use alcohol and alcohol-based and/or ketone-based cleaning products to clean leather upholstery, as damage to the upholstery may result.

GLASS SURFACES

All glass surfaces should be cleaned on a regular basis with Mopar® Glass Cleaner, or any commercial household-type glass cleaner. Never use an abrasive type cleaner. Use caution when cleaning the inside rear window equipped with electric defrosters or windows equipped with radio antennas. Do not use scrapers or other sharp instruments that may scratch the elements. When cleaning the rearview mirror, spray cleaner on the towel or cloth that you are using. Do not spray cleaner directly on the mirror.

TECHNICAL SPECIFICATIONS

VEHICLE IDENTIFICATION NUMBER (VIN)

The VIN is found on a label located on the left front corner of the instrument panel pad, visible from outside of the vehicle through the windshield.

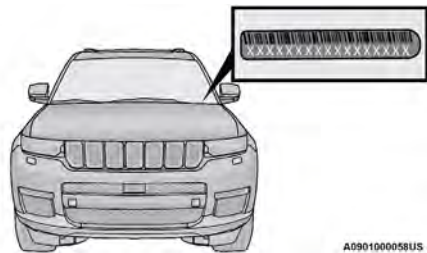

Windshield VIN Label Location

NOTE:

It is illegal to remove or alter the VIN.

BRAKE SYSTEM

Your vehicle is equipped with dual hydraulic brake systems. If either of the two hydraulic systems lose normal capability, the remaining system will still function. However, there will be some loss of overall braking effectiveness. You may notice increased pedal travel during application, greater pedal force required to slow or stop, and potential activation of the Brake Warning Light.

In the event power assist is lost for any reason the brakes will still function. However, the effort required to brake the vehicle will be much greater than that required with the power system operating.

WHEEL AND TIRE TORQUE SPECIFICATIONS

Proper lug nut/bolt torque is very important to ensure that the wheel is properly mounted to the vehicle. Any time a wheel has been removed and reinstalled on the vehicle, the lug nuts/bolts should be torqued using a properly calibrated torque wrench using a six-sided (hex) deep wall socket.

TORQUE SPECIFICATIONS

Lug Nut/Bolt Torque	**Lug Nut/Bolt Size	Lug Nut/Bolt Socket Size
130 ft-lb (176 N·m)	M14 x 1.50	22 mm

**Use only authorized dealer recommended lug nuts/bolts and clean or remove any dirt or oil before tightening.

Inspect the wheel mounting surface prior to mounting the tire and remove any corrosion or loose particles.

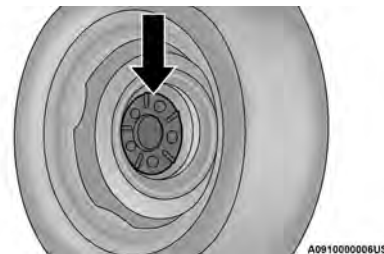

A091000006US

Wheel Mounting Surface

Tighten the lug nuts/bolts in a star pattern until each nut/bolt has been tightened twice. Ensure that the socket is fully engaged on the lug nut/bolt (do not insert it half way).

NOTE:

If in doubt about the correct tightness, have them checked with a torque wrench by an authorized dealer or service station.

After 25 miles (40 km), check the lug nut/bolt torque to be sure that all the lug nuts/bolts are properly tightened.

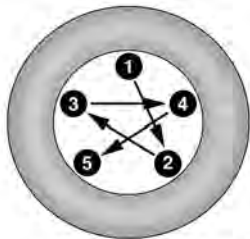

A091000004US

Torque Pattern

WARNING!

To avoid the risk of forcing the vehicle off the jack, do not tighten the lug nuts/bolts fully until the vehicle has been lowered. Failure to follow this warning may result in personal injury.

FUEL REQUIREMENTS

While operating on gasoline with the required octane number, hearing a light knocking sound from the engine is not a cause for concern. However, if the engine is heard making a heavy knocking sound, see a dealer immediately. Use of gasoline with an octane number lower than recommended can cause engine failure and may void the New Vehicle Limited Warranty. Poor quality gasoline can cause problems such as hard starting, stalling, and hesitations. If you experience these symptoms, try another brand of gasoline before considering service for the vehicle.

2.0L ENGINE – GRAND CHEROKEE

This engine is designed to meet all emissions requirements, and provide satisfactory fuel economy and performance, when using high-quality unleaded regular gasoline having an octane rating of 87, as specified by the (R+M)/2 method. The use of 91 or higher octane premium gasoline will allow these engines to operate to optimal performance. This increase in performance is most noticeable in hot weather or under heavy load conditions, such as while towing.

3.6L ENGINE

Do not use E-85 flex fuel or ethanol blends greater than 15% in this engine.



This engine is designed to meet all emissions regulations and provide optimum fuel economy and performance when using high quality unleaded regular gasoline having a posted octane number of 87 as specified by the (R+M)/2 method. The use of higher octane premium gasoline is not required, as it will not provide any benefit over regular gasoline in these engines.

5.7L ENGINE

Do not use E-85 flex fuel or ethanol blends greater than 15% in this engine.



This engine is designed to meet all emission regulations and provide satisfactory fuel economy and performance when using high-quality unleaded gasoline having an octane range of 87 to 89 as specified by the (R+M)/2 method. The use of 89 octane plus gasoline is recommended for optimum performance and fuel economy.

REFORMULATED GASOLINE

Many areas of the country require the use of cleaner burning gasoline referred to as "reformulated gasoline". Reformulated gasoline contains oxygenates and are specifically blended to reduce vehicle emissions and improve air quality.

The use of reformulated gasoline is recommended. Properly blended reformulated gasoline will provide improved performance and durability of engine and fuel system components.

MATERIALS ADDED TO FUEL

Besides using unleaded gasoline with the proper octane rating, gasolines that contain detergents, corrosion and stability additives are recommended. Using gasolines that have these additives will help improve fuel economy, reduce emissions, and maintain vehicle performance.



Designated TOP TIER Detergent Gasoline contains a higher level of detergents to further aide in minimizing engine and fuel system deposits. When available, the usage of TOP TIER Detergent Gasoline is recommended. Visit www.toptiergas.com for a list of TOP TIER Detergent Gasoline retailers.

Indiscriminate use of fuel system cleaning agents should be avoided. Many of these materials intended for gum and varnish removal may contain active solvents or similar ingredients. These can harm fuel system gasket and diaphragm materials.

GASOLINE/OXYGENATE BLENDS

Some fuel suppliers blend unleaded gasoline with oxygenates such as ethanol.

CAUTION!

DO NOT use E-85, gasoline containing methanol, or gasoline containing more than 15% ethanol (E-15). Use of these blends may result in starting and drivability problems, damage critical fuel system components, cause emissions to exceed the applicable standard, and/or cause the Malfunction Indicator Light to illuminate. Please observe pump labels as they should clearly communicate if a fuel contains greater than 15% ethanol (E-15).

Problems that result from using gasoline containing more than 15% ethanol (E-15) or gasoline containing methanol are not the responsibility of the manufacturer and may void or not be covered under New Vehicle Limited Warranty.

DO NOT USE E-85 IN NON-FLEX FUEL VEHICLES

Non-Flex Fuel Vehicles (FFV) are compatible with gasoline containing up to 15% ethanol (E-15). Use of gasoline with higher ethanol content may void the New Vehicle Limited Warranty.

If a Non-FFV vehicle is inadvertently fueled with E-85 fuel, the engine will have some or all of these symptoms:

- Operate in a lean mode.
- OBD II Malfunction Indicator Light on.

- Poor engine performance.
- Poor cold start and cold drivability.
- Increased risk for fuel system component corrosion.

CNG AND LP FUEL SYSTEM MODIFICATIONS

Modifications that allow the engine to run on Compressed Natural Gas (CNG) or Liquid Propane (LP) may result in damage to the engine, emissions, and fuel system components. Problems that result from running CNG or LP are not the responsibility of the manufacturer and may void or not be covered under the New Vehicle Limited Warranty.

METHYLCYCLOPENTADIENYL MANGANESE TRICARBONYL (MMT) IN GASOLINE

MMT is a manganese-containing metallic additive that is blended into some gasolines to increase octane. Gasoline blended with MMT provides no performance advantage beyond gasoline of the same octane number without MMT. Gasoline blended with MMT reduces spark plug life and reduces emissions system performance in some vehicles. The manufacturer recommends that gasoline without MMT be used in your vehicle. The MMT content of gasoline may not be indicated on the gasoline pump; therefore, you should ask your gasoline retailer whether the gasoline contains MMT. MMT is prohibited in Federal and California reformulated gasoline.

FUEL SYSTEM CAUTIONS

CAUTION!

Follow these guidelines to maintain your vehicle's performance:

- The use of leaded gasoline is prohibited by Federal law. Using leaded gasoline can impair engine performance and damage the emissions control system.
- An out-of-tune engine or certain fuel or ignition malfunctions can cause the catalytic converter to overheat. If you notice a pungent burning odor or some light smoke, your engine may be out of tune or malfunctioning and may require immediate service. Contact an authorized dealer for service assistance.
- The use of fuel additives, which are now being sold as octane enhancers, is not recommended. Most of these products contain high concentrations of methanol. Fuel system damage or vehicle performance problems resulting from the use of such fuels or additives is not the responsibility of the manufacturer and may void or not be covered under the New Vehicle Limited Warranty.

NOTE:

Intentional tampering with the emissions control system can result in civil penalties being assessed against you.

FLUID CAPACITIES — GRAND CHEROKEE

	US	Metric
Fuel (Approximate)		
All Engines	23 gal	87 L
Engine Oil With Filter		
2.0L Engine	5 qt	4.7 L
3.6L Engine	5 qt	4.7 L
5.7L Engine	7 qt	6.6 L
Cooling System *		
2.0L Engine	10.4 qt	9.8 L
2.0L Engine Intercooler	4.4 qt	4.2 L
3.6L Engine - Without Trailer Tow Package	11 qt	10.4 L
3.6L Engine - With Trailer Tow Package	11.5 qt	10.9 L
5.7L Engine	15 qt	14.2 L

* Includes heater and coolant recovery bottle filled to MAX level.

ENGINE FLUIDS AND LUBRICANTS — GRAND CHEROKEE

Component	Fluid, Lubricant, or Genuine Part
Engine Coolant	We recommend using Mopar® Antifreeze/Coolant 10 year/150,000 mile (240,000 km) Formula OAT (Organic Additive Technology) meeting the requirements of the manufacturer Material Standard MS.90032.
Intercooler	We recommend using Mopar® Antifreeze/Coolant 10 year/150,000 mile (240,000 km) Formula OAT (Organic Additive Technology) or equivalent meeting the requirements of the manufacturer Material Standard MS.90032.

Component	Fluid, Lubricant, or Genuine Part
Engine Oil – 2.0L Engine	We recommend using Mopar® API SP/GF-6A Certified SAE 5W-30 Full Synthetic Engine Oil which meets the requirements of the manufacturer Material Standard MS-13340. Equivalent full synthetic SAE 5W-30 API SP engine oil can be used but must have the API Donut trademark ↪ page 277.
	CAUTION!
	Failure to use the recommended API SP/GF-6A or equivalent oil can cause engine damage not covered by the vehicle warranty.
Engine Oil – 3.6L & 5.7L Engine	We recommend using Mopar® SAE 0W-20 Full Synthetic Engine Oil which meets the requirements of the manufacturer Material Standard MS-6395. Equivalent full synthetic SAE 0W-20 engine oil can be used but must have the API Starburst trademark ↪ page 277.
Fuel Selection – 2.0L Engine	87 Octane (R+M)/2 Method, 0-15% Ethanol.
Fuel Selection – 3.6L Engine	87 Octane (R+M)/2 Method, 0-15% Ethanol (Do not use E-85).
Fuel Selection – 5.7L Engine	89 Octane Recommended - 87 Octane Acceptable (R+M)/2 Method, 0-15% Ethanol (Do not use E-85).

ENGINE FLUIDS AND LUBRICANTS — GRAND CHEROKEE 4XE

Component	Fluid, Lubricant, or Genuine Part
Engine, Intercooler, Power Electric and Battery Coolant	We recommend using Mopar® Antifreeze/Coolant 10 year/150,000 mile (240,000 km) Formula OAT (Organic Additive Technology) meeting the requirements of the manufacturer Material Standard MS.90032.
Engine Oil – 2.0L Engine	We recommend using Mopar® API SP/GF-6A Certified SAE 5W-30 Full Synthetic Engine Oil which meets the requirements of the manufacturer Material Standard MS-13340. Equivalent full synthetic SAE 5W-30 engine oil can be used if it meets API SP/GF-6A Certification. If API SP/GF-6A or equivalent oil is unavailable then please contact a local dealership for recommendation.
	CAUTION!
	Failure to use the recommended API SP/GF-6A or equivalent oil can cause engine damage not covered by the vehicle warranty.

Component	Fluid, Lubricant, or Genuine Part
Engine Oil Filter	We recommend using a Mopar® Engine Oil Filter. If a Mopar® Engine Oil Filter is unavailable only use filters that meet or exceed SAE/USCAR-36 Filter Performance Requirements.
Fuel Selection – 2.0L Engine	87 Octane (R+M)/2 Method, 0-15% Ethanol.

CHASSIS FLUIDS AND LUBRICANTS

Component	Fluid, Lubricant, or Genuine Part
Automatic Transmission	Use only Mopar® ZF 8 & 9 Speed ATF Automatic Transmission Fluid or equivalent. Failure to use the correct fluid may affect the function or performance of your transmission.
Transfer Case – 1-Speed or 2-Speed Transfer Case	We recommend using Mopar® ATF+4 Automatic Transmission Fluid.
Axle Differential (Front-Rear) - Without Electronic Limited Slip Differential (ELSD)	We recommend using Mopar® GL-5 Synthetic Axle Lubricant, SAE 75W-85.
Axle Differential (Rear) - With Electronic Limited Slip Differential (ELSD)	We recommend using Mopar® GL-5 Synthetic Axle Lubricant, SAE 75W-85 with friction modifier additive.
Brake Master Cylinder	We recommend using Mopar® DOT 3 Brake Fluid, SAE J1703.

CUSTOMER ASSISTANCE

SUGGESTIONS FOR OBTAINING SERVICE FOR YOUR VEHICLE

PREPARE FOR THE APPOINTMENT

All work to be performed may not be covered by the warranty. Discuss additional charges with the service manager. Keep a maintenance log of your vehicle's service history. This can often provide a clue to the current problem.

PREPARE A LIST

Make a written list of your vehicle's problems or the specific work you want done. If you've had an accident or work done that is not on your maintenance log, let the service advisor know.

BE REASONABLE WITH REQUESTS

If you list a number of items and you must have your vehicle by the end of the day, discuss the situation with the service advisor and list the items in order of priority. At many authorized dealers, you may obtain a rental vehicle (additional charges may apply). If you need a rental, it is advisable to make these arrangements when you call for an appointment.

IF YOU NEED ASSISTANCE

FCA US LLC and its authorized dealers are vitally interested in your satisfaction. We want you to be happy with our products and services.

Warranty service must be done by an authorized dealer. We strongly recommend that you take the vehicle to an authorized dealer. They know your vehicle the best, and are most concerned that you get prompt and high quality service. FCA US LLC's authorized dealers have the facilities, factory-trained technicians, special tools, and the latest information to ensure the vehicle is fixed correctly and in a timely manner.

This is why you should always talk to an authorized dealer's service manager first. If for some reason you are still not satisfied, talk to the general manager or owner of the authorized dealer. They want to know if you need assistance. If an authorized dealer is unable to resolve the concern, you may contact FCA US LLC's Customer Assistance center.

Any communication to FCA US LLC's customer center should include the following information:

- Owner's name and address
- Owner's telephone number (home, mobile, and office)
- Authorized dealer name
- Vehicle Identification Number (VIN)
- Vehicle delivery date and mileage

ROADSIDE ASSISTANCE

Available 24 hours, 7 days a week.

Call 1-800-521-2779 or visit [chrysler.rsahelp.com\(USA\)](http://chrysler.rsahelp.com(USA))

Call 1-800-363-4869 or visit fca.roadsideaid.com (Canada)

Who is Covered

You are covered by Roadside Assistance services if you are a purchaser for use of the vehicle. Roadside Assistance services last for five years or 60,000 miles on the odometer, whichever occurs first, calculated from the start date of the Basic Limited Warranty, as set forth in your Warranty Information book.¹

1. Towing services provided through Cross Country Motor Club, Inc., 400 River's Edge Drive, Medford, MA 02155, except in AK, CA, HI, OR, WI, and WY, where services are provided by Cross Country Motor Club of California, Inc., 275 East Hillcrest Drive, Suite 165, Thousand Oaks, CA 91360.

What to Do

If your vehicle requires jump start assistance, out of gas/fuel delivery, tire service, lockout service or towing as a result of a mechanical breakdown, dial toll-free: USA: 1-800-521-2779/Canada: 1-800-363-4869. Provide your name, Vehicle Identification Number (VIN) required for covered services, license plate number, and your location, including the telephone number from which you are calling. Briefly describe the nature of the problem and answer a few simple questions. You will be given the name of the service provider and an estimated time of arrival. If you feel you are in an unsafe situation, please let us know. With your consent, we will contact local police or safety authorities.

If Unable to Contact Roadside Assistance

If you are unable to contact Roadside Assistance or unable to provide a valid Vehicle Identification Number (VIN), and you obtain towing services on your own, you may submit your original receipts from the licensed towing or service facility, for services rendered within 30 days of the occurrence. Be sure to include your VIN, odometer mileage at the time of service, and current mailing address. We will process the claim based on vehicle and service eligibility. If eligible, we will reimburse you for the reasonable amount actually paid, based on the usual and customary charges for that service in the area where they were provided. FCA US LLC's determination relating to reimbursement is final. Correspondence should be mailed to:

FCA US LLC Customer Assistance

P.O. Box 9145

Medford, MA 02155

Attention Claims Department

FCA US LLC reserves the right to modify the terms or discontinue the Roadside Assistance Program at any time. The Roadside Assistance program is subject to restrictions and conditions of use, which are determined solely by FCA US LLC.

Flat Tire Service

If you are inconvenienced by a flat tire, we will dispatch a service provider to use your vehicle's temporary spare tire (if equipped) as recommended in your Owner's Manual. This is not a permanent flat tire repair.

Out of Gas/Fuel Delivery

Drivers cannot always count on a gas station being nearby, especially when traveling away from home. We will dispatch a service provider to deliver a small amount of fuel (maximum two gallons) to get you to a nearby station. This service is limited to two occurrences in a 12-month period.

Battery Jump Assistance

No time is a good time for a depleted battery. With Roadside Assistance, you do not have to worry about being stranded. We will dispatch a service provider to provide you with a battery jump anytime, day or night.

Lockout Service

Whether the keys are locked in your vehicle or frozen locks are keeping you from getting on your way, help is just a phone call away. This service is limited to providing access to the vehicle's seating area. It does not cover the cost of replacement keys.

Towing Service

Our towing service gives you peace of mind and confidence. If your vehicle becomes disabled as a result of a mechanical breakdown, Roadside Assistance will dispatch a towing service to transport your vehicle to the closest authorized Chrysler, Dodge, Jeep®, or Ram dealer. If you choose to go to another dealer, you will be responsible for the cost if the extra distance exceeds 10 miles.

FCA US LLC CUSTOMER CENTER

P.O. Box 21-8004

Auburn Hills, MI 48321-8004

Phone: (877) 426-5337

FCA CANADA CUSTOMER CARE

P.O. Box 1621

Windsor, Ontario N9A 4H6

Phone: (800) 465-2001 English/(800) 387-9983 French

MEXICO**Customer Relations Office**

Av. Prolongacion Paseo de la Reforma, 1240

Sante Fe C.P. 05109

Mexico, CDMX

In Mexico City: (800) 505-1300

Outside Mexico City: +(52) 55 50817568

PUERTO RICO AND US VIRGIN ISLANDS**FCA Caribbean LLC Customer Service**

P.O. Box 191857

San Juan 00919-1857

Phone: (877) 426-5337

CUSTOMER ASSISTANCE FOR THE HEARING OR SPEECH IMPAIRED (TDD/TTY)

To assist customers who have hearing difficulties, FCA US LLC has installed special Telecommunication Devices for the Deaf (TDD) equipment at its customer center. Any hearing or speech impaired customer, who has access to a TDD or a conventional teletypewriter (TTY) in the United States, can communicate with FCA US LLC by dialing 1-800-380-2479.

Canadian residents with hearing difficulties that require assistance can use the special needs relay service offered by Bell Canada. For TTY teletypewriter users, dial 711 and for Voice callers, dial 1-800-855-0511 to connect with a Bell Relay Service operator.

SERVICE CONTRACT

You may have purchased a service contract for a vehicle to help protect you from the high cost of unexpected repairs after FCA US LLC's New Vehicle Limited Warranty expires. The Mopar® Vehicle Protection plans are the ONLY vehicle extended protection plans authorized, endorsed and backed by FCA US LLC to provide additional protection beyond your vehicle's warranty. If you purchased a Mopar® Vehicle Protection Plan, you will receive Plan Provisions and an Owner Identification Card in the mail within three weeks of the vehicle delivery date. If you have any questions about the service contract, call FCA US LLC's Service Contract National Customer Hotline at 1-800-521-9922.

For Canadian residents, you may have purchased additional coverage with an extended service contract. FCA Canada Inc. stands fully behind its service contracts. Be sure that the one you buy is a genuine Canada Inc. service contract. We are not responsible for other companies' contracts. If you purchased a contract other than a genuine FCA Canada Inc. service contract and you have a problem, you will have to contact the administrator of that contract for resolution. If you have any questions about the service contract, call the FCA's Service Contract National Customer Hotline at (800) 465-2001 English / (800) 387-9983 French).

FCA US LLC is not responsible for any service contract you may have purchased from another manufacturer. If you require service after the FCA US LLC New Vehicle Limited Warranty expires, please refer to the contract documents, and contact the person listed in those documents.

We appreciate that you have made a major investment when you purchased the vehicle. An authorized dealer has also made a major investment in facilities, tools, and training to assure that you are absolutely delighted with the ownership experience.

WARRANTY INFORMATION

See the Warranty Information for the terms and provisions of FCA US LLC warranties applicable to this vehicle and market. Refer to www.mopar.com/om for further information.

See the Warranty Information for the terms and provisions of FCA Canada Inc. warranties applicable to this vehicle and market. Refer to www.owners.mopar.ca/en/ for further information.

For French, refer to www.owners.mopar.ca/fr for further information.

Use this QR code to access your digital experience.



MOPAR® PARTS

Mopar® original equipment parts & accessories and factory filled fluids are available from an authorized dealer. They are recommended for your vehicle to keep it operating at its best and maintain its original condition.

REPORTING SAFETY DEFECTS

IN THE 50 UNITED STATES AND WASHINGTON, D.C.

If you believe that your vehicle has a defect that could cause a crash or cause injury or death, you should immediately inform the National Highway Traffic Safety Administration (NHTSA) in addition to notifying FCA US LLC.

If NHTSA receives similar complaints, it may open an investigation, and if it finds that a safety defect exists in a group of vehicles, it may order a recall and remedy campaign. However, NHTSA cannot become involved in individual problems between you, an authorized dealer or FCA US LLC.

To contact NHTSA, you may call the Vehicle Safety Hotline toll free at 1-888-327-4236 (TTY: 1-800-424-9153); or go to <http://www.safercar.gov>; or write to: Administrator, NHTSA, 1200 New Jersey Avenue, SE., West Building, Washington, D.C. 20590. You can also obtain other information about motor vehicle safety from <http://www.safercar.gov>.

IN CANADA

If you believe that your vehicle has a safety defect, you should contact the Customer Service Department immediately. Canadian customers who wish to report a safety defect to the Canadian government should contact Transport Canada, Motor Vehicle Defect Investigations and Recalls at 1-800-333-0510 or go to wwwapps.tc.gc.ca/Saf-Sec-Sur/7/PCDB-BDPP.

PUBLICATION ORDER FORMS

To order the following manuals, you may use either the website or the phone numbers listed below.

Service Manuals

These comprehensive Service Manuals provide a complete working knowledge of the vehicle, system, and/or components and is written in straightforward language with illustrations, diagrams, and charts.

Diagnostic Procedure Manuals

Diagnostic Procedure Manuals are filled with diagrams, charts and detailed illustrations. These manuals make it easy to find and fix problems on computer-controlled vehicle systems and features. They show exactly how to find and correct problems, using step-by-step troubleshooting and drivability procedures, proven diagnostic tests and a complete list of all tools and equipment.

To order a digital copy of your Service or Diagnostic Procedure manuals, visit:

www.techauthority.com (US and Canada).

Owner's Manuals

These Owner's Manuals have been prepared with the assistance of service and engineering specialists to acquaint you with specific FCA vehicles.

To access your Owner's Information online, visit www.mopar.com/om (US) or www.owners.mopar.ca/en/ (Canada).

Or visit:

www.techauthority.com to order physical copies of Owner's Manuals (US).

Owner's Manuals, Radio Manuals and Warranty Information Books can be ordered through Archway at:

- 1-800-387-1143 (Canada)

Change Of Ownership Or Address

*If you have purchased this vehicle used or have changed your address, please provide the following information and mail to:

FCA US LLC

P.O. Box 21-8008

Auburn Hills, MI 48321-8004

Make sure to include the following:

- Date of Sale (mm/dd/yy)
- Vehicle Identification Number (17 Character ID located on top left of the instrument panel)
- Exact Odometer Reading
- First and Last Name
- Phone Number
- Street Address, City, State and Zip Code
- Email Address

*Applies to US residents only.

GENERAL INFORMATION

The following regulatory statement applies to all Radio Frequency (RF) devices equipped in this vehicle:

This device complies with Part 15 of the FCC Rules and with Innovation, Science and Economic Development Canada license-exempt RSS standard(s). Operation is subject to the following two conditions:

1. This device may not cause harmful interference, and
2. This device must accept any interference received, including interference that may cause undesired operation.

Le présent appareil est conforme aux CNR d'Innovation, Science and Economic Development applicables aux appareils radio exempts de licence. L'exploitation est autorisée aux deux conditions suivantes:

1. l'appareil ne doit pas produire de brouillage, et
2. l'utilisateur de l'appareil doit accepter tout brouillage radioélectrique subi, même si le brouillage est susceptible d'en compromettre le fonctionnement.

La operación de este equipo está sujeta a las siguientes dos condiciones:

1. es posible que este equipo o dispositivo no cause interferencia perjudicial y
2. este equipo o dispositivo debe aceptar cualquier interferencia, incluyendo la que pueda causar su operación no deseada.

NOTE:

Changes or modifications not expressly approved by the party responsible for compliance could void the user's authority to operate the equipment.

INDEX

A

About Your Brakes321
Accessory Drive Belt Inspection280
Active Driving Assist System129
Active Lane Management System96, 100, 144
Adaptive Cruise Control (ACC)97, 99, 120
Adding Engine Coolant (Antifreeze)285
Adding Fuel154
Additives, Fuel322
Adjust	
Down37
Forward37
Rearward37
Up37
Air Bag93
Air Bag Operation230
Air Bag Warning Light228, 230
Driver Knee Air Bag233
Enhanced Accident Response236, 269
Event Data Recorder (EDR)269
Front Air Bag230
If Deployment Occurs235
Knee Impact Bolsters233
Maintaining Your Air Bag System236
Maintenance236
Redundant Air Bag Warning Light229
Side Air Bags234
Transporting Pets248
Air Bag Light228, 249
Air Cleaner, Engine (Engine Air Cleaner Filter)278
Air Conditioner Maintenance278
Air Conditioner Refrigerant278, 279
Air Conditioner System278
Air Conditioning58

Max58
Rear62
Air Conditioning Filter64
Air Conditioning, Operating Tips64
Air Conditioning System63
Air Filter278
Air Pressure	
Tires310
Alarm	
Arm The System24
Disarm The System24
Panic18
Rearm The System24
Security Alarm95
Alarm System	
Security Alarm24, 25
Alterations/Modifications	
Vehicle10
Amazon FireTV194, 198
Amazon FireTV Built-in194
Ambient Light	
Multicolor55
Antifreeze (Engine Coolant)284, 324
Disposal285
Anti-Lock Brake System (ABS)96, 205
Anti-Lock Warning Light96
Apps193
Arming System	
Security Alarm24
Assist, Hill Start210
Audio Systems (Radio)90, 169
Auto Down Power Windows72
Auto Hold99, 108
Automatic Folding Mirrors47

Automatic Headlights52
Automatic High Beams52
Automatic Temperature Control (ATC)63
Automatic Transmission103, 109
Adding Fluid287
Fluid And Filter Change287
Fluid Change287
Fluid Level Check287
Fluid Type287, 326
Special Additives287
Automatic Transmission Limp Home Mode111
AutoPark104
Autostick111
Operation111
AUX Cord67
Auxiliary Driving Systems212
Auxiliary Electrical Outlet (Power Outlet)69
Auxiliary Power Outlet69
Axle Fluid326
B	
Battery94, 276
Charging System Light94
Keyless Key Fob Replacement18
Battery Saver Feature54
Belts, Seat249
Body Mechanism Lubrication281
Bodywork319
B-Pillar Location307
Brake Assist System207
Brake Control System, Electronic206
Brake Fluid286, 326
Brake System286, 321

- Anti-Lock (ABS)321
 Fluid Check286
 Master Cylinder286
 Parking106
 Warning Light93
 Brake/Transmission Interlock109
 Bulb Replacement304
 Bulbs, Light250
- C**
- Camera, Front148
 Camera, Night Vision150
 Camera, Rear147, 152
 Camera, Rear Washer147
 Camera, Surround View152
 Capacities, Fluid324
 Caps, Filler
 Oil (Engine)273
 Radiator (Coolant Pressure)285
 Carbon Monoxide Warning250, 251
 Care And Maintenance319
 Cargo Area Cover79, 80
 Cargo Area Storage78
 Cargo Compartment78
 Cargo Tie-Downs78
 Car Washes319
 Cellular Phone204
 Center Console, Front65
 Center Console, Rear66
 Chains, Tire316
 Charging
 Wireless70
 Chart, Tire Sizing305
 Check Engine Light (Malfunction Indicator Light)102
 Checking Your Vehicle For Safety248
 Checks, Safety248
- Child Restraint237
 Child Restraints
 Booster Seats239
 Child Seat Installation246
 How To Stow An unused ALR Seat Belt244
 Infant And Child Restraints238
 Locating The LATCH Anchorages242
 Lower Anchors And Tethers For Children240
 Older Children And Child Restraints238
 Seating Positions239
 Child Safety Locks29
 Clean Air Gasoline322
 Cleaning
 Wheels315
 Climate Control57
 Automatic58
 Rear60
 CNG And LP Fuel System Modifications323
 Cold Weather Operation105
 Compact Spare Tire314
 Contract, Service329
 Cooling Pressure Cap (Radiator Cap)285
 Cooling System284
 Adding Coolant (Antifreeze)285
 Coolant Level285, 286
 Cooling Capacity324
 Disposal Of Used Coolant285
 Drain, Flush, And Refill284
 Inspection284, 285, 286
 Points To Remember286
 Pressure Cap285
 Radiator Cap285
 Selection Of Coolant (Antifreeze)284, 324, 325
 Corrosion Protection319
 Cruise Control (Speed Control)120
 Cruise Light100
 Customer Assistance327
- Customer Programmable Features170
 Cybersecurity169
- D**
- Daytime Running Lights51
 Defroster, Windshield249
 De-Icer, Remote Start23
 De-Icer, Windshield57
 Deluxe Security Alarm25
 Diagnostic System, Onboard101
 Digital Instrument Cluster 83
 Dipsticks
 Oil (Engine)276
 Disposal
 Antifreeze (Engine Coolant)285
 Do Not Use E-85 In Non-Flex Fuel Vehicles323
 Door Ajar94
 Door Locks26, 29
 Child-Protection Door Lock – Rear Doors29
 Doors26
 Driver's Seat Back Tilt33
 Driving166
 Tips166
 DrowsyDriverDetection205
- E**
- Electrical Outlet, Auxiliary (Power Outlet)69
 Electric Brake Control System206
 Anti-Lock Brake System205
 Electronic Roll Mitigation207, 212
 Electric Parking Brake106
 Electronic Stability Control (ESC)96, 207
 Electronic Sway Bar Disconnect114
 Electronic Throttle Control Warning Light94

- Emergency
 Engine Overheating265
 Freeing A Stuck Vehicle267
 Hazard Warning Flashers252
 Jump Starting263
 Manual Park Release266
 Refueling264
 Tow Hooks269
 Towing A Disabled Vehicle267
- Emergency Braking217
- Emission Control System Maintenance102
- Engine273
 Air Cleaner278
 Break-In Recommendations105
 Checking Oil Level276
 Compartment273, 274, 275
 Compartment Identification273, 274, 275
 Coolant (Antifreeze)94
 Cooling284
 Exhaust Gas Caution250, 251
 Fails To Start105
 Flooded, Starting105
 Fuel Requirements322, 324
 Jump Starting263
 Oil277, 324
 Oil Filler Cap273
 Oil Filter278
 Oil Selection277, 324, 325
 Oil Synthetic277
 Starting103
- Engine Oil Life Reset 87
- Enhanced Accident Response Feature236, 269
- Ethanol323
- Exhaust Gas Cautions250, 251
- Exhaust System250, 283
- Extend, Seats.38
- Exterior Lights50, 250, 304
- F**
- FamCam System149
- Filters
 Air Cleaner278
 Air Conditioning64, 279
 Engine Oil278
 Engine Oil Disposal278
- FireTV198
- Flashers
 Turn Signals100, 250
- Flash-To-Pass52
- Flooded Engine Starting105
- Fluid Capacities324
- Fluid Leaks250
- Fluid Level Checks
 Brake286
 Engine Oil276
- Fluids And Lubricants326
- Fog Lights53, 100
- Fold-Flat Seats33
- Forward Collision Warning97, 99, 215
- Four Wheel Drive97, 98, 112, 115
 Operation112
 Shifting98
 System112
- Four Wheel Drive Operation112
- Freeing A Stuck Vehicle267
- Front And Rear ParkSense System134
- Front Axle (Differential)288
- Front View Camera148
- Fuel322
 Additives322
 Clean Air322
 Ethanol323
 Gasoline322
 Materials Added322
 Methanol323
- Octane Rating322
- Requirements322, 324
- Specifications324, 325
- Tank Capacity324
- Fueling154
- Fuel Saver Technology119
- Fuel System Cautions323
- Fuses288
- G**
- Garage Door Opener (HomeLink)47
- Gasoline, Clean Air322
- Gasoline, (Fuel)322
- Gasoline, Reformulated322
- Gear Ranges110
- Glass Cleaning320
- Gross Axle Weight Rating156
- Gross Combination Weight Rating156
- Gross Trailer Weight156
- Gross Vehicle Weight Rating156
- GVWR155
- H**
- Hands-Free Liftgate77
- Hazard Warning Flashers252
- Headlights50
 Automatic52
 Cleaning319
 Delay53
 High Beam/Low Beam Select Switch51
 Leveling54
 Lights On Reminder53
 On With Wipers52
 Passing52
 Switch50

Head Restraints42
Head Up Display (HUD) If Equipped 91
Heated Mirrors47
Heated Seats40
Heated Steering Wheel30
Hill Descent Control100, 209
Hill Descent Control Indicator209
Hill Start Assist210
Hitches Trailer Towing158
Hold 'N Go108
HomeLink (Garage Door Opener)47
Hood Closing94
Opening94
Hood Release75
HUD91

I

Ignition21
Key Fob Battery Low Or Dead21
Key Fob Not Detected21
Keyless Ignition21
Keyless Push Button21
Push Button Ignition21
Switch21
Ignition Park Interlock109
Immobilizer (Sentry Key)20
Inside Rearview Mirror44, 252
Instrument Cluster85
Descriptions100
Display85
Home87, 89
Menu Items89

Instrument Cluster Display Vehicle Info89
Instrument Panel Lens Cleaning320
Interior And Instrument Lights54
Interior Appearance Care320
Interior Lights54
Interior Monitoring Camera149
Intermittent Wipers (Delay Wipers)56
Intersection Collision Assist218
Inverter Power70
iPod/USB/MP3 Control67

J

Jacking And Tire Changing 255
Jacking And Tire Changing Instructions255
Jacking Instructions259
Jack Location255
Jack Operation259
Jump Starting263

K

Key Fob Arm The System24
Disarm The System24
Programming Additional Key Fobs20
Key Fob Battery Service (Remote Keyless Entry)18
Key Fob Programming (Remote Keyless Entry)20
Keyless Enter 'n Go™103
Passive Entry27
Passive Entry Programming27
Keys17
Replacement20
Sentry (Immobilizer)20



L

Lane Change Assist54
Lane Management System144
Lap/Shoulder Belts223
Latches250
Lead Free Gasoline322
Leaks, Fluid250
Life Of Tires312
Liftgate76, 94
Adjustable Height77
Closing76
Hands-Free77
Opening76
Liftgate Window Wiper/Washer57
Light Bulbs250
Lighted Cupholders66
Lights250
Air Bag93, 228, 249
Ambient55
Ambient, Multicolor55
Automatic Headlights52
Brake Assist Warning208
Brake Warning93
Bulb Replacement304
Cruise100
Daytime Running51
Dimmer Switch55
Dimmer Switch, Headlight50
Electric Power Steering94
Electronic Stability Control96
Exterior50, 250
Fog53, 100
Hazard Warning Flasher252
Headlights On With Wipers52
High Beam101
High Beam/Low Beam Select51

Hill Descent Control Indicator100, 209	M		N	
Interior54	Main Menu89	Navigation90
Lights On Reminder53	Maintenance74, 75	Neutral.99
Low Fuel96	Maintenance Free Battery276	New Vehicle Break-In Period105
Malfunction Indicator (Check Engine)97	Maintenance Schedule270	Night Vision Camera.150
Neutral99	Malfunction Indicator Light (Check Engine)97, 102		
Night Vision95, 97, 100	Manual		O	
Oil Temperature95	Service330	Occupant Restraints.222
Park52, 100	Massage		Octane Rating, Gasoline (Fuel)322
Passing52	Seats40	Off-Road Driving (Off-Pavement).90
Reading54	McIntosh193	Off Road Pages202
Seat Belt Reminder95	Memory Feature (Memory Seats)31	Accessory Gauges203
Security Alarm95	Memory Seat31	Pitch And Roll203
SelecSpeed Control101	Memory Seats And Radio31	Selec Terrain204
Service304	Methanol323	Status Bar202
Sport Mode100	Methylcyclopentadienyl Manganese Tricarbonyl (MMT) In Gasoline323	Suspension204
StopStart100	Mirrors44	Vehicle Dynamics203
Sway Bar99	Automatic Dimming Rearview44	Oil Change Indicator87
Sway Bar Fault98	Digital Rearview44	Reset87
Traction Control208	Exterior Folding45	Oil, Engine277
Transmission Temperature95	Heated47	Capacity324
Turn Signals54, 100, 250	Outside45	Checking276
Vanity Mirror45	Power46	Dipstick276
Loading Vehicle155	Power Folding46	Disposal278
Tires307	Rearview44, 252	Filter278
Load Shed Battery Saver Mode92	Tilt Side Mirrors47	Filter Disposal278
Load Shed Battery Saver On92	Vanity45	Identification Logo277
Load Shed Electrical Load Reduction92	Modifications/Alterations		Materials Added To277
Load Shed Intelligent Battery Sensor92	Vehicle10	Pressure Warning Light95
Locks		Monitor, Tire Pressure System218	Recommendation277, 324
Child Protection29	Mopar Parts329	Synthetic277
Manual26	Multi-Function Control Lever.51	Viscosity324
Power Door26				
Lubrication, Body281				
Luggage Carrier.81				
Lug Nuts/Bolts321				

- Oil Filter, Change278
Oil Filter, Selection.278
Oil Pressure Light.95
Onboard Diagnostic System101
Operating Precautions101
Operator Manual
 Owner's Manual330
Outside Rearview Mirrors45
- P**
Paint Care.319
Panic Alarm18
Parking Brake106
ParkSense
 Front And Rear134
ParkSense Active Park Assist.141
ParkSense System, Rear.134
Passenger Screen189
Passive Entry27
Pedestrian Warning System217
Permissions.189
Pets248
Pinch Protection73, 75
Placard, Tire And Loading Information307
Power
 Brakes321
 Distribution Center (Fuses)295, 299
 Door Locks26
 Inverter70
 Mirrors46
 Outlet (Auxiliary Electrical Outlet)69
 Seats37
 Steering119
 Sunroof73, 74
 Tilt/Telescoping Steering Column30
 Windows71
- Power Seats
 Down37
 Forward37
 Rearward37
 Up37
Power Seats, Third Row39
Pregnant Women And Seat Belts.226
Preparation For Jacking255
Pressure Washing277
Pretensioners
 Seat Belts226
Profile.172
Programmable Features169
- Q**
Quadra-Lift98, 99, 116
Quadra-Trac.113
- R**
Radial Ply Tires311
Radiator Cap (Coolant Pressure Cap).285
Radio
 Off Road Pages202
 Settings169
 Sound Setting184
Radio Operation204
Radio Remote Controls189
Rain Sensitive Wiper System57
Rear Air Conditioning62
Rear Axle (Differential).288
Rear Camera.147, 152
Rear Camera, Washer147
Rear Cross Path214
Rear ParkSense System134
Rear Seat Entertainment194
- RearSeatReminderAlert206
Rear Wiper/Washer.57
Reclining Front Seats33
Recreational Towing163
Reformulated Gasoline322
Refrigerant279
Release, Hood75
Reminder, Seat Belt223
Remote Control
 Starting System22
Remote Keyless Entry.17
 Arm The Alarm24
 Disarm The Alarm24
 Programming Additional Key Fobs20
Remote Sound System (Radio) Control189
Remote Starting
 Exit Remote Start Mode23
Remote Starting System22
Replacement Bulbs304
Replacement Keys20
Replacement Tires312
Reporting Safety Defects329
Restraints, Child.237
Restraints, Head42
Roll Over Warning9
Roof Luggage Rack81
Rotation, Tires.317
- S**
Safety Checks Inside Vehicle249
Safety Checks Outside Vehicle250
Safety Defects, Reporting329
Safety, Exhaust Gas250
Safety Information, Tire304
Safety Tips248
Schedule, Maintenance270

Screen, Passenger189	Second Row USB68	Steering Wheel Audio Controls189
Seat Belts222, 249	Security Alarm24, 25, 95	Steering Wheel Mounted Sound System Controls189
Adjustable Shoulder Belt225	Arm The System24	Stop/Start97, 100, 119
Adjustable Upper Shoulder Anchorage225	Disarm The System24	Storage65
Adjustable Upper Shoulder Belt Anchorage225	Selec-Terrain115	Cargo Area78
Automatic Locking Retractor (ALR)226	Sentry Key (Immobilizer)20	Storage, Vehicle318
Child Restraints237	Sentry Key Replacement20	Storing Your Vehicle318
Energy Management Feature226	Service Assistance327	Streaming194
Extender225	Service Contract329	Sunglasses Storage65
Front Seat222, 223, 224	Service Manuals330	Sun Roof73, 74, 75
Inspection249	Settings90, 169	Opening73
Lap/Shoulder Belt Operation224	Shifting108	Sunshade Operation67, 73, 74, 75
Lap/Shoulder Belts223	Automatic Transmission108, 109	Sun Visor45
Lap/Shoulder Belt Untwisting225	Shifting Into NEUTRAL (N)164	Surround View Camera152
Operating Instructions224	Shifting Out Of NEUTRAL (N)166	Sway Bar Disconnect	
Pregnant Women226	Shift Paddles111	Electronic114
Pretensioners226	Shoulder Belts223	Sway Control, Trailer212
Rear Seat223	Side Distance Warning139	Symbol Glossary10
Reminder95, 100, 101, 223	Signals, Turn100, 250	Synthetic Engine Oil277
Seat Belt Extender225	Snow Chains (Tire Chains)316	System, Remote Starting22
Seat Belt Pretensioner226	Snow Tires313		
Seat Belt Reminder101	Spare Tires257, 313, 314		
Untwisting Procedure225	Speed Control			
Seat Belts Maintenance320	Accel/Decel (ACC Only)123		
Seats33, 37, 41	Sport Mode112		
Adjustment33, 37	Starting22, 103		
Bolster Adjustment38	Button21		
Easy Entry38	Cold Weather105		
Extend38	Engine Fails To Start105		
Heated40, 41	Remote22		
Massage40	Starting And Operating103		
Memory31	Starting Procedures103		
Rear Folding33	Steering29		
Reclining33	Power119		
Seatback Release33	Tilt Column29, 30		
Tilting33	Wheel, Heated30		
Vented41	Wheel, Tilt29, 30		
Ventilated41	Wheel, Voice Recognition31		
				T	
				Telescoping Steering Column29, 30
				Temperature Control, Automatic (ATC)63
				Third Party Apps193
				Third Row USB68
				Tie Down Hooks, Cargo78
				Tilt Steering Column29, 30
				Tire And Loading Information Placard307
				Tire Identification Number (TIN)306
				Tire Markings304
				Tires250, 310, 313, 317
				Aging (Life Of Tires)312
				Air Pressure310
				Chains316
				Changing255

- Compact Spare314
 General Information310, 313
 High Speed311
 Inflation Pressure310
 Life Of Tires312
 Load Capacity307
 Pressure Monitoring System (TPMS)98, 218
 Quality Grading317
 Radial311
 Replacement312
 Rotation317
 Run Flat311
 Safety304, 310
 Sizes305
 Snow Tires313
 Spare Tires257, 313, 314
 Spinning311
 Trailer Towing161
 Tread Wear Indicators312
 Types313
 Wheel Nut Torque321
 Tire Safety Information304
 Tire Terminology And Definitions306
 Tongue Weight/Trailer Weight.156, 160
 To Open Hood75
 Towing156
 Disabled Vehicle267
 Guide158
 Recreational163
 Weight158
 Towing Behind A Motorhome163
 Towing This Vehicle Behind Another Vehicle163
 Traction Control212
 Traffic Sign Assist System128
 TrailCam System148
 Trailer Frontal Area156
 Trailer Sway Control (TSC)156, 212
 Trailer Towing156
 Hitch Cover Removal160
 Hitches158
 Minimum Requirements160
 Tips162
 Trailer And Tongue Weight160
 Weight-Carrying Hitch156
 Weight-Distributing Hitch157
 Wiring161
 Trailer Weight158
 Transfer Case288
 Fluid326
 Maintenance288
 Transmission109
 Automatic109, 287
 Fluid326
 Maintenance287
 Shifting108
 Transporting Pets248
 Tread Wear Indicators312
 Trip Computer90
 Turn Signals.100
- U**
 Uconnect 5/5 NAV169
 Uconnect (Radio)169
 Uconnect Settings169
 Customer Programmable Features27, 29
 Passive Entry Programming27, 29
 Uniform Tire Quality Grades317
 Universal Garage Door Opener (HomeLink®) —
 If Equipped 47
 Unleaded Gasoline322
 Untwisting Procedure, Seat Belt225
- USB
 Second Row68
 Third Row68
 USB Port67
- V**
 Vanity Mirrors.45
 Vehicle Identification Number (VIN)321
 Vehicle Loading155, 307
 Vehicle Maintenance277
 Vehicle Modifications/Alterations10
 Vehicle Security Alarm24
 Vehicle Settings169
 Vehicle Storage318
 Voice Command31
 Voice Recognition System (VR)31
- W**
 Warning Lights And Messages.93
 Warning Lights (Instrument Cluster Descriptions)93
 Warnings, Roll Over9
 Warranty Information 329
 Washers, Windshield.56, 97, 276
 Washing Vehicle.319
 Wheel And Wheel Tire Care315
 Wheel And Wheel Tire Trim.315
 Wind Buffeting72
 Window Fogging64
 Window Lockout Switch72
 Windows71
 Power71
 Reset Auto-Up72
 Windshield Defroster249
 Windshield Delcer57

Windshield Washers56, 276
Fluid276
Windshield Wiper Blades281
Windshield Wipers56
Wipers Blade Replacement281
Wipers, Intermittent.56
Wipers, Rain Sensitive57
Wireless Charging Pad70

The driver's primary responsibility is the safe operation of the vehicle. Driving while distracted can result in loss of vehicle control, resulting in an accident and personal injury. FCA US LLC strongly recommends that the driver use extreme caution when using any device or feature that may take their attention off the road. Use of any electrical devices, such as cellular telephones, computers, portable radios, vehicle navigation or other devices by the driver while the vehicle is moving is dangerous and could lead to a serious accident. Texting while driving is also dangerous and should never be done while the vehicle is moving. If you find yourself unable to devote your full attention to vehicle operation, pull off the road to a safe location and stop your vehicle. Some states or provinces prohibit the use of cellular telephones or texting while driving. It is always the driver's responsibility to comply with all local laws.

This Owner's Manual has been prepared to help you get acquainted with your new Jeep® brand vehicle and to provide a convenient reference source for common questions.

Not all features shown in this manual may apply to your vehicle. For additional information, visit mopar.com/om (USA), owners.mopar.ca (Canada) or your local Jeep® brand dealer.

U.S. Residents: If you are the first registered retail owner of your vehicle, you may obtain a complimentary printed copy of the Warranty Booklet by calling **1-877-426-5337** or by contacting your dealer. Replacement kits can be purchased by visiting www.techauthority.com.

Canadian Residents: If you are the first registered retail owner of your vehicle, you may obtain a complimentary printed copy of the Warranty Booklet or purchase a replacement kit by calling **1-800-387-1143** or by contacting your dealer.

DRIVING AND ALCOHOL

Drunk driving is one of the most frequent causes of accidents. Your driving ability can be seriously impaired with blood alcohol levels far below the legal minimum. If you are drinking, don't drive. Ride with a designated non-drinking driver, call a cab, a rideshare, a friend or use public transportation.

WARNING

Driving after drinking can lead to an accident. Your perceptions are less sharp, your reflexes are slower and your judgment is impaired when you have been drinking. Never drink and then drive.



Whether it's providing information about specific product features, taking a tour through your vehicle's heritage, knowing what steps to take following an accident or scheduling your next appointment, we know you'll find the app an important extension of your Jeep® brand vehicle. Simply download the app, select your make and model and enjoy the ride. To get this app, go directly to the App Store® or Google Play® Store and enter the search keyword "JEEP" (U.S. residents only).

USA



mopar.com/om

**DOWNLOAD THE MOST UP-TO-DATE OWNER'S MANUAL,
RADIO AND WARRANTY BOOKS**

Canada



owners.mopar.ca