



Grecale

Owner's manual



WARNING:

Operating, servicing and maintaining a passenger vehicle or off-highway motor vehicle can expose you to chemicals including engine exhaust, carbon monoxide, phthalates, and lead, which are known to the State of California to cause cancer and birth defects or other reproductive harm. To minimize exposure, avoid breathing exhaust, do not idle the engine except as necessary, service your vehicle in a well-ventilated area and wear gloves or wash your hands frequently when servicing your vehicle. For more information go to: <http://www.P65Warnings.ca.gov/passenger-vehicle>"www.P65Warnings.ca.gov/passenger-vehicle.



Dear Customer,

thank you for choosing a Maserati.

This vehicle represents the result of Maserati's great experience in the design and production of sports, touring and racing vehicles.

The purpose of this manual and of the other documents in the two on-board documentation kits is to provide you with an understanding of the equipment, systems and controls of the vehicle and to explain how they work.

Consulting this manual you will acquaint yourself with the equipment and optional properties of your Maserati in order to take best advantage of all its potential.

The description of all the on-board safety systems and devices and the car's technical data are given in the main guide.

Any change or alteration of the car might seriously affect its safety and road holding thus causing accidents, in which the occupants could even be fatally injured.

Before driving your vehicle for the first time, we suggest reading this manual carefully in order to quickly acquaint with commands and functions of your vehicle.

In a dedicated section of this manual you will also find instructions for basic maintenance procedures, in order to ensure steady levels of performance, quality and safe driving.

In addition, keep in mind that proper maintenance is an essential factor to help preserve the value of the vehicle over time and protect the environment.

For "Scheduled Maintenance" or any other operations, we recommend to contact the **Authorized Maserati Dealer**: you can trust our trained technical staff, who is constantly updated and provided with the required equipment in order to ensure that all service operations are performed properly and reliably.

All the documents contained in on-board documentation kits are integral part of the vehicle and should always be kept on board.

All documentation is also available at <https://ownerdocumentation.maserati.com>.



Introduction	1
Understanding the Vehicle	2
Before Starting	3
Dashboard Instruments and Controls	4
Starting and Driving	5
Driver Assistance Systems	6
In an Emergency	7
Maintenance and Care	8
Index	9





1 - Introduction

On-board Documentation Kits	6
Updating	6
Owner's Information Online	7
Consulting the manual	7
Abbreviations	8



On-board Documentation Kits

On board there are various documents to provide the User with all the necessary information regarding the manufacturer's warranty, assistance requests and to know all the devices supplied with the car and their functions, in order to be able to operate the vehicle using all of its potential.

These documents are contained in two kits, one placed in the dashboard glove box and the other inside the luggage compartment.

The kit inside the dashboard glove box contains the Warranty Card and the Owner's Main Guide.

The kit inside the luggage compartment, in addition to this Owner's Manual, also contains the Maserati Intelligent Assistant™ (MIA) information booklet and Regulatory Information.

Depending on the equipment chosen, the market, etc., the kits may contain other additional documents.

NOTE:

After reviewing the manual, always put the document in its case to avoid losing it.

All specifications and illustrations contained in these documents refer to the manual publishing date.

Updated versions of the on-board documentation and the “Regulatory Information” are always available and can be consulted by accessing the website <https://ownerdocumentation.maserati.com>. In case of loss, excluding the Warranty Card, it is possible to purchase a copy of these documents by requesting it from your **Authorized Maserati Dealer**.

Updating

The vehicle's high quality level is guaranteed by constant improvements. Therefore, there may prove to be differences between this manual and your vehicle.

Maserati reserves the right to carry out design and functional changes and to achieve additions or improvements without incurring any obligation to update previously manufactured vehicles.

This manual illustrates and describes all versions of the current vehicle model. Therefore, some of the equipment and accessories in this publication may not appear on your vehicle; please only consider the information related to your vehicle.

All specifications and illustrations contained in this manual refer to the Manual publishing date.

NOTE:

The updated version of on-board documentation can be consulted by accessing the website <https://ownerdocumentation.maserati.com>.



Owner's Information Online

All of the on-board documents can also be consulted online in PDF format by accessing the website <https://ownerdocumentation.maserati.com>. The website is available for most markets.

The online documents may be more up to date than those supplied with the car. By accessing the website www.maserati.com it is possible to watch videos and find other useful information regarding your Maserati and all available services.

Consulting the manual

This manual illustrates maintenance and use information related to gasoline motorization models (3.0 V6 and 2.0 L4 MHEV). If not otherwise specified, the information is valid for all models.

For an easy identification of the topics, this manual is divided into sections and chapters: each chapter can have more paragraphs.

Meaning of Warning and Note Symbols

Within the text, important warnings and notes are also easily identifiable through icons.



WARNING!

Describe operating procedures that could result in a bodily injury and/or death.



WARNING!

Potential danger relating to the electronic components of the MHEV models. Misuse or inappropriate intervention on the system components can generate severe electric short-circuits and can cause serious or fatal

injuries if the instructions indicated are not observed.



ENVIRONMENTAL!

This note indicates the correct behaviour when using the vehicle to protect the environment.



CAUTION!

Describe procedures that could result in damage to your vehicle.

NOTE:

Additional information regarding the subject and/or the operation described.



In addition to these, this symbol in the text indicates a reference to the Owner's Main Guide.

Optional Equipment and Versions/Markets Validity



In addition to the standard equipment, this manual also describes optional parts and accessories which are identified in the title and /or text by this symbol alongside in brackets.



Optional equipment and also some functions or systems are not available in all vehicle versions and may only be available in certain markets. In these cases, the



Introduction

equipment or the function/system will be identified in the title and/or text by this symbol alongside in brackets.

Other General Indications

- In the images the vehicle is represented in the base version. On other versions, some part or equipment may differ from those shown in the images.
- "Left" and "right" in this manual, always refer to the driving direction.
- All indications and images in this manual refer to a vehicle with left-hand drive. On right-hand drive vehicles, some controls are ordered differently than shown in the illustrations.
- If not otherwise specified, the instrument cluster shown in the images is the version with the speedometer in mph with the classic layout in "Comfort" drive mode – however the indications given are also valid for the version in km/h and other layout.

Abbreviations

Some descriptions and terms with particular meanings are found in this manual in abbreviated form.

A/C	Air-Conditioning system.	CC	Cruise Control.
ABA	Advanced Brake Assist.	CRS	Child Restraint System.
ABS	Anti-Lock Braking System.	DDD	Drowsy Driver Detection
ABSA	Active Blind Spot Assist.	DRL	Daytime Running Lights.
ACC	Adaptive Cruise Control.	EBD	Electronic Brake-force Distribution.
ADA	Active Driving Assist.	ECU	Electronic Control Unit.
ADAS	Advanced Driver Assistance Systems.	EDR	Event Data Recorder.
AEB	Autonomous Emergency Braking.	ELK	Emergency Lane Keeping.
AFS	Advanced Frontlighting System.	EPB	Electric Parking Brake.
ALM	Active Lane Management.	EPS	Electric Power Steering.
ALR	Automatic Locking Retractor.	ESC	Electronic Stability Control.
AQS	Air Quality Sensor.	ETC	Electronic Throttle Control.
ATC	Automatic Temperature Control.	FCW	Forward Collision Warning.
AVH	Auto Vehicle Hold.	HBA	Hydraulic Brake Assistance.
AWD	All-Wheel Drive.	HDC	Hill Descent Control.
BAS	Brake Assist System.	HSA	Hill Start Assist.
BSA	Blind Spot Assist.	HUD	Head Up Display.
BTO	Brake Throttle Override.	ISA	Intelligent Speed Assist.
CAN	Controller Area Network.	LATCH	Lower Anchors and Tether for Children.
		LSD	Limited Slip Differential.
		MHEV	Mild Hybrid Electric Vehicle.
		MIL	Malfunction Indicator Light.
		MIA	Maserati Intelligent Assistant.
		OBD	On-board Diagnostics.



ORC	Occupant Restraint Controller.
ORS	Occupants Restraint Systems.
PEB	Pedestrian Emergency Braking.
RAB	Ready Alert Braking.
RCP	Rear Cross Path.
RHD	Right-Hand Drive.
RKE	Remote Keyless Entry.
ROM	Roll-Over Mitigation.
SAB	Side AirBag.
SABIC	Supplemental Side AirBag Inflatable Curtains.
SBR	Seat Belt Reminder.
SL	Speed Limiter.
SRS	Supplemental Restraint Sys- tem.
TCS	Traction Control System.
TPMS	Tire Pressure Monitoring Sys- tem.
TSA	Traffic Sign Assist.
TSM	Trailer Sway Mitigation.
VIN	Vehicle Identification Number.





2 - Understanding the Vehicle

Main Controls Overview	12
Mild Hybrid System Information (2.0 L4 MHEV only)	14
Front Seats	18
Memorize the Driver's Seat Position	21
Rear Seats	23
Steering Wheel Adjustment	25
Rear View Mirrors	26
External Lighting	29
Interior Lighting	34
Internal Equipment	36
Access the Glove Box Compartment	43
Audio System	44
Cargo Area	46
Front to Back Roof Rails (OPT)	50
HomeLink®	51
Air Conditioning Distribution	55



Main Controls Overview

On Dashboard

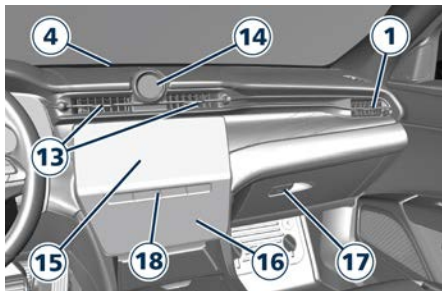
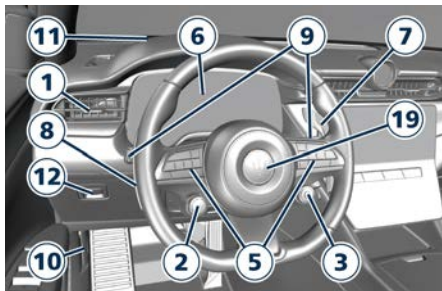

- 1 Adjustable side air outlets (page 55)
- 2 Engine **START/STOP** button (page 62)
- 3 Drive mode selector and suspension stiffness button (page 169)
- 4 Vehicle security alarm light (🚨) (📖 : chapter “Vehicle Security Alarm” in section “Safety”)

- 5 Steering wheel controls (page 133)
- 6 Instrument cluster (page 85)
- 7 Right shift paddle + (page 165)
- 8 Left shift paddle - (page 165)
- 9 Multifunction lever (windshield wipers, headlight selection and turn signals) (page 136) and (page 141)
- 10 Hood release lever (page 80)
- 11 Head Up Display (HUD) (📖) (page 98)
- 12 Electric parking brake lever (page 180)
- 13 Adjustable central air outlets (page 55)
- 14 Smart clock (page 143)
- 15 MIA display (page 114)
- 16 Comfort display (page 144)
- 17 Dashboard glove box handle (page 43)
- 18 Transmission button selectors (page 161)
- 19 Horn (📖 : chapter “Supplemental Restraint System (SRS) - AirBags” in section “Safety”)

On Central Console

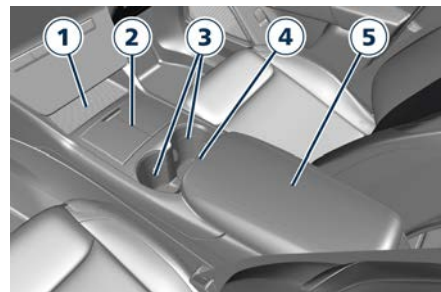

Central Console Front Part

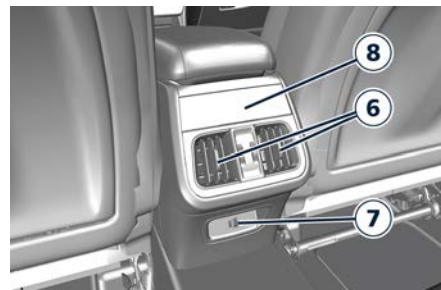

Central Console Rear Part



- 1 Wireless charger (📖) (page 39)
- 2 Central tunnel compartment with USB (page 38)
- 3 Cupholders (page 38)
- 4 Unlock button for rear central tunnel compartment (page 37)
- 5 Rear central tunnel compartment (page 37)
- 6 Adjustable air outlets (page 55)

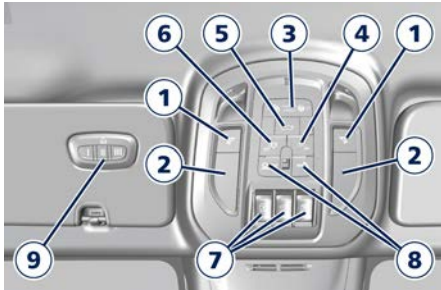

- 7 USB slot (page 38)
- 8 Three-zone climate controls for rear passengers () (page 149)

On Front Dome Console



- 1 Reading lights control button (page 139)
- 2 Reading lights (page 139)
- 3 Passenger airbag deactivation warning light
- 4 Button to switch on passenger compartment lights (page 35)
- 5 Button to open fully/partially the power liftgate
- 6 Button to turn off compartment lights when doors are opened (page 35)
- 7 Sunroof controls () (page 73)
- 8 Button to activate the Assist Call or the SOS Emergency Call () () : chapter "SOS and Assist Call" of section "In an Emergency")
- 9 HomeLink controls (page 51)

On Front Doors

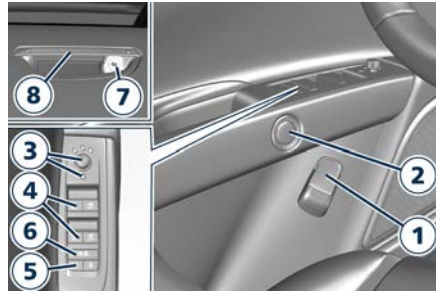

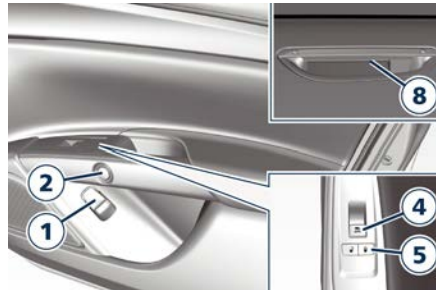

Driver door





Passenger door

- 1 Internal emergency handle ( : chapter "Doors Security Locking" of section "Safety")
- 2 E-latch door button (page 70)
- 3 External rear view mirrors switches (page 26)
- 4 Power window switches (page 71)

- 5 Power doors lock/unlock buttons ( : chapter "Doors Security Locking" of section "Safety")
- 6 Rear windows child lock button ( : chapter "Doors Security Locking" of section "Safety")
- 7 Door outboard manual opening lock
- 8 External door handle

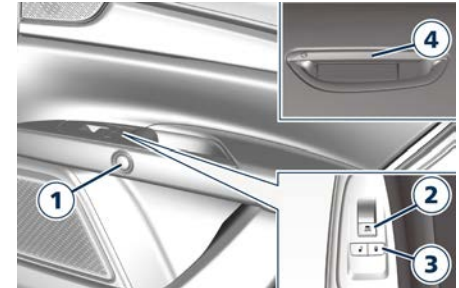
On Rear Doors



- 1 E-latch door button (page 70)
- 2 Power window switch (page 71)
- 3 Power doors lock/unlock buttons ( : chapter "Doors Security Locking" of section "Safety")
- 4 External door handle



Mild Hybrid System Information (2.0 L4 MHEV only)

2

System Components

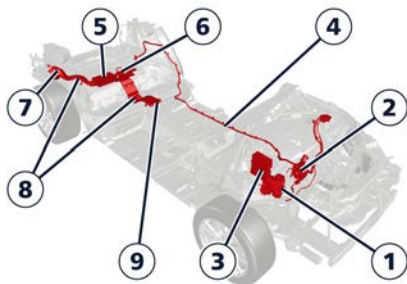

The mild hybrid system installed on the MHEV models, in addition to the traditional gasoline thermal engine, is composed of the following main components:

- 1 Belt Starter Generator (BSG) 48 V installed on the thermal engine RH side.
- 2 eBooster 48 V with flap-valve in front of the thermal engine.
- 3 Hybrid system ECU in the engine compartment RH side.
- 4 48 V connecting cable.
- 5 48 V Li-Ion Battery housed in the luggage compartment.
- 6 48 V/12 V DC/DC converter on the 48 V battery.

- 7 Fan battery cooling.
- 8 Cooling ducts.
- 9 Air intake grill.

The 48 V battery containing twelve lithium ion cells that needs no maintenance. The battery housing also contains a battery control and supervision unit, a relay, a fuse, a shunt resistor, two temperature sensors and a pressure balancing unit.

The main functions of the battery system are to store the electrical energy supplied by the 48 V power supply during braking and returns it to the system when the electric motor starts operating parallel to the thermal engine. During its operation, the 48 V battery can develop heat which is dissipated using a fan and a series of ducts. The fan sucks the air from the rear bottom side passenger compartment through a air intake grill then directs it through ducts to the battery. To ensure the cooling of the 48 V battery it is important that the air intake remains free.



WARNING!

Do not cover, close or throw objects inside the air intake grill on the rear bottom side passenger compartment with a plug/stopper. The air must circulate in the battery system at all time to prevent its overheating and a potential risk of fire.



The BSG is driven by the crankshaft by means of a belt and is at the same time able to perform the function of current generator and that of electric motor, also with the function of starter motor for the thermal engine in some situations such as in the phases Start&Stop. In the latter case, after stopping the car in a stop and automatic engine shutdown with the Start&Stop system, re-ignition occurs through the BSG. The traditional starter motor is used only for the first ignition of the car, when you have power from the



12 V battery, which is certainly charged, and more power is needed.

When acting as an electric motor, the mild hybrid system provides additional power to the thermal engine at start-up, when starting from a standstill or when there is a demand for greater drive torque, or in the most demanding moments in terms of consumption and emissions.

Based on the information from the on-board sensors, the hybrid system ECU decides when it is more convenient to recover energy such as when a vehicle decelerates, a phase in which the system slows down the car with the BSG generating energy to be stored in the 48 V battery or to power the car's services. In certain driving conditions, the hybrid system ECU also regulates energy flows taking into account the charge level of the 48 V battery. This management is optimal especially when using some ADAS systems because the energy recovery starts automatically even when a vehicle is detected in front of the car, slowing down the vehicle with the activation of the BSG.

The eBooster is used to support the main turbocharger and improve vehicle acceleration and driveability.

Bi-directional DC/DC converter is used to link 48 V and 12 V board net. In

forward mode works as converter to supply the 12 V net; in pre-charge mode works as converter to pre-charge the 48 V net with limited current.

The connection cable between the 48 V battery and the BSG is sufficiently protected and housed in a position that cannot be accessed by the user.

General Safety Instructions on the 48 V Battery System

Although this is no high-voltage battery system (link voltages remain below 60 V), misuse or inappropriate interventions on the system components using insufficiently insulated tools can generate short-circuits and cause injury due to the flow of high currents and/or the resulting high temperatures. To avoid these problems, carefully follow the recommendations below.



WARNING!

- **Battery system components may be damaged in an accident, although the damage may not be visible. Touching or moving damaged battery system components could result in electrocution.**
- **Never perform modifications to components of battery system.**

- **Only technicians with the necessary experience and equipment are allowed to work on the battery system. In case of battery system problems, do not intervene but contact an Authorized Maserati Dealer.**
- **Do not open the battery housing, or otherwise disassemble the battery system.**
- **Do not puncture, impact, crush, shock, or deform the battery system.**
- **Avoid touching the battery housing, as its surface may be hot both during and after usage.**
- **Do not wet the battery system with any type of liquid to avoid electrocution.**
- **Do not expose the battery system to external heat.**
- **Do not cover or close the air intake grill on the rear bottom side passenger compartment with a plug/stopper. The air must circulate in the battery system at any time to prevent its overheating and a potential risk of fire.**

In Case of Damage to the 48 V Battery

The 48 V battery cell has a hermetically sealed metal housing and does not represent a danger to health if the battery is used correctly.

If the battery system is used improperly, damaged, overheated, abused, or in unusual environmental conditions may



Understanding the Vehicle





cause the cell to leak with release of flammable electrolyte fumes. In these cases the car has a strategy that drives the fan battery cooling and warns the user through the hybrid system failure warning light and a message that invites passengers to leave the vehicle. After this event, the 48 V battery must be replaced at an **Authorized Maserati Dealer**.



Overheated System Components: Failures and Derating Strategies

If the temperature of the 48 V system components increases, a message will appear that will ask you to verify that the grille on the rear parcel shelf of the cooling duct is not obstructed.

When the temperature is not within the working range or an error occurs, the strategies shown in the following table are followed:

System Component	Fail Warning Light (*)	Fail Pop-up	Derating Pop-up
Belt Starter Generator (BSG) and 48 V/12 V DC/DC converter		Hybrid System Unavailable See Dealer	
			
48 V Li-Ion battery		Hybrid System Unavailable See Dealer	
eBooster 48 V		Hybrid System Unavailable See Dealer	eBooster Temporarily Unavailable
Battery fan		Hybrid System Cooling Unavailable See Dealer	
(*) See chapter “Warning and Indicator Lights” in section “Dashboard Instruments and Controls”			



Understanding the Vehicle

If the 48 V Battery is Discharged

The hybrid system does not allow recharging the 48 V battery from external devices or sources and therefore it is necessary to prevent it from discharging over the minimum limit because after it could no longer be usable.

The charge level of the 48 V battery can be monitored on the cluster display by entering the left configurable widget area or by the "Electric Vehicle" menu on MIA screen.

When the battery charge is close to the minimum threshold, the engine will bring it to a safe level by normally driving the car.

Before leaving the car stationary for a long time, follow the instructions in the chapter "Vehicle Stored for long Periods" in section "Maintenance and Care".

Front Seats

Seats, head restraints and seat belts are parts of the Occupant Restraint System (ORS) of the vehicle. For further information,  : chapter "Occupant Restraint System (ORS)" and "Head Restraints" in section "Safety".

Depending on the different markets and versions, the front seats may have different controls for adjustment and optional functions. The configurations shown below may differ from the ones in your vehicle.

The front passenger seat is equipped with a sensor that informs the SBR system about the presence of an occupant on the seat.



WARNING!

Be sure everyone in your vehicle is in a seat and using a seat belt properly.

Front Power Seats

The power seats switches are located on the outboard side of the seat cushion. Use the front switch **1** to move the seat up or down, forward or rearward or to recline the seat cushion (.

Use the switch **2** to recline the seatback. Use the rear switch **3** to adjust the lumbar support.

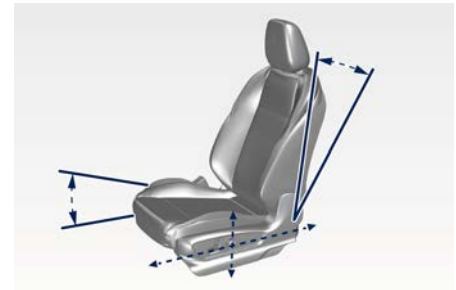

Seat Forward/Rearward Adjustment

The seat can be adjusted both forward and rearward.

Push the seat switch **1** forward or rearward, the seat will move in the direction of the switch. Release the switch **1** when the desired position is reached.

Seat Up/Down Adjustment

The height of the seat can be adjusted up or downward.



Grip switch **1** from the back side and push it down or up.
Release the switch **1** when the desired position is reached.



CAUTION!

If the seat's movement does not work, make sure that the corresponding fuse is not tripped (see chapter "If a Fuse Blows" in section "In an Emergency").

Seat Tilt Control (Rotation)

The angle of the seat cushion can be adjusted in four directions.
Pull upward or push the front of the switch **1**, to move the front cushion seat in the direction of the switch.
Release the switch **1** when the desired position is reached.

Seat Back Tilt Control

The angle of the seatback can be adjusted forward or rearward.
Push the seatback switch **2** forward or rearward, the upper seatback will move in the direction of the switch.
Release the switch **2** when the desired position is reached.

Power Lumbar

Push the switch **3** forward or rearward to increase or decrease the lumbar support.
Push the switch **3** upward or downward to raise or lower the lumbar support.

Seat Bolster Control

The side bolsters of the seats can be adjusted from the Seats menu of the Comfort display.
Push the "+" or "-" control to adjust the opening of the bolsters.



WARNING!

- **Never adjust the seat while driving. You could lose control of the vehicle. Moving the seat could distract you or make you press a pedal unintentionally.**
- **Seats should be adjusted before fastening the seat belts and while the vehicle is parked.**
- **Do not travel with the seatback reclined so that the shoulder belt is no longer resting against your chest. In a collision you could slide under the seat belt, which could result in serious injury or death.**



CAUTION!

Do not place any object under a power seat or obstruct its movement as it may cause damage to the seat controls. Seat movement may become limited if there is an obstruction in the way.

Front Heated Seats

The front seats can be equipped with heaters in both seat cushions and seatbacks.
The front seats heating is operated by the Comfort Display.
The seat comfort icons are always visible in the main page of the Comfort Display.
To activate and set the heating/ventilation functions of the front seats and the heating of the steering wheel (), touch the related seats and wheel icons.





WARNING!

- **Persons with low skin sensitivity because of advanced age, chronic illness, diabetes, spinal cord injury, medication, alcohol use, exhaustion or other physical conditions must be careful when using the seat heater. It may cause burns even at low temperatures, especially if used for long periods of time.**
- **Do not place anything on the seat that insulates against heat, such as a blanket or cushion. This may cause the seat heater to overheat.**

Front Seats Heat Function

NOTE:

The engine must be running for the heated seats to operate.

If the function is not active (state "OFF"), the dynamic parts of the icon are grey: to activate the function operate in the following mode:

- Starting from the state "OFF", touch the driver or passenger seat soft-key once to select HI-level heating displayed by the seat icon with 3 arrows and 3 red lines.
- Touch the driver or passenger seat soft-key a second time to select MID-level heating displayed by the seat icon with 2 arrow and 2 red lines and a third

time to select LO-level with 1 arrow and 1 red line.

- Touch the same soft-key a fourth time to shut off the seat heating.

NOTE:

- Once a heat setting is selected, heat will be felt within 2 to 5 minutes.
- The heating of the seat can start automatically when starting the engine under particular conditions (see "Functions of Settings Menu on MIA" in section "Dashboard Instruments and Controls").

Front Ventilated Seats (OPT)

To enhance occupants comfort by high external temperatures, both the driver and passenger seats, on request, can be ventilated.

Small fans are located in the seat cushion and seatback, they draw air from the seat surface through fine perforations in the seat cover to help keep the driver and front passenger cooler when the temperature is high.

The ventilated seats are operated with the Comfort Display.

The icons are always visible in the main page of the Comfort Display.



Front Ventilated Seats Function

NOTE:

The engine must be running for the ventilated seats to operate.

If the function is not active (state "OFF"), the dynamic parts of the icon are grey: to activate the function operate in the following mode:

- Starting from the state "OFF", touch the driver or passenger seat soft-key once to select HI-level ventilation displayed by the seat icon with the fan and 3 blue lines.
- Touch the driver or passenger seat soft-key a second time to select MID-level ventilation displayed by the seat icon with the fan and 2 blue lines and a third time to select LO-level with the fan and 1 blue line.
- Touch the same soft-key a fourth time to shut off the seat ventilation.

**NOTE:**

The ventilation of the seat can start automatically when starting the engine under particular conditions (see "Functions of Settings Menu on MIA" in section "Dashboard Instruments and Controls").

Memorize the Driver's Seat Position

This function allows the driver to store up to three different memory profiles for easy recall through Seats menu on the Comfort Display. Each memory profile contains desired position settings for the driver seat, external side mirrors, power tilt and telescopic steering column and a set of programmed radio stations.

Your key fob can also be set to recall the same positions by pressing the  button.

NOTE:

- Only one key fob can be linked to each of the memory positions.
- "Passive Entry" door handles cannot be linked to the memory function. Use either the memory recall soft-key or the key fob (if linked to the memory function) to recall memory positions 1, 2 or 3.

The memory seat soft-key is located in the Seats menu on the Comfort Display. The icons consist of three buttons: The M1, M2 and M3 icons which are used to recall either of three programmed memory profiles.



Memory Profiles Setting

NOTE:

Saving a new memory profile will erase an existing profile from memory

To create a new memory profile, perform the following:

- Cycle the ignition device to **ON**.
- Adjust all memory profile settings to desired preferences (i.e., seat, side mirrors, power tilt and telescopic steering column, and radio station presets).
- Long press and release one of the three memory soft-keys.

After these steps, the profile set will be memorized in the selected position.

NOTE:

Memory profiles can be set without the vehicle in P (Park), but the vehicle must be in P (Park) to recall a memory profile



Pairing Remote Keyless Entry Transmitter to Seats Memory

Your key fob can be programmed to recall one of three programmed memory profiles by pressing the  button on the key fob.

NOTE:

This function can be enabled or disabled using the MIA system, refer to “Functions of Setting Menu on MIA” in section “Dashboard Instruments and Controls” for further information.

To program your key fobs, perform the following actions:

- Cycle the ignition device to **ON** position.
- Put the key fob on the spot inside the rear central tunnel compartment, under the armrest.
- Move the seat and/or the other adjustable devices in the position that you wish to memorize, or recall a previously memorized profile, pressing the corresponding memory "M1", "M2" or "M3".
- Press and release the desired memory soft-key "M1", "M2" or "M3" for 3 seconds.
- Press and release the  button on the key fob.

To check if the system has memorized the correct profile, you can move the

seat and press the  button: the seat will move to the memorized position.

Memory Position Recall

NOTE:

The vehicle must be in **P (Park)** to recall memory positions. If a recall is attempted when the vehicle is not in **P (Park)**, a message will display in the instrument cluster.

To recall the memory settings for driver, press memory soft-key "M1", "M2" or "M3" on the Comfort Display or the  button on the key fob linked to memory position "M1", "M2" or "M3" with ignition device in **ON** position.

A recall can be canceled by pressing any of the icons ("M1", "M2" or "M3") during a recall. When a recall is canceled, the driver seat, external side mirrors and power tilt and telescopic steering column stop moving.

A delay of at least one second will occur before selecting a new recall.

Easy Entry/Exit Driver Seat

This function provides automatic driver seat positioning to enhance driver mobility when entering and exiting the vehicle.

The distance the driver seat moves depends on where you have the driver

seat positioned when you place the ignition device to the **STOP** position.

- When you cycle the ignition device to the **STOP** position the driver seat:
 - will move about 60 mm (2.36 in) rearward if the driver seat position is greater than or equal to ca. 140 mm (5.51 in) forward of the rear stop;
 - will move to a position of ca. 80 mm (3.15 in) rearward of the rear stop if the driver seat position is between 140 mm (5.51 in) and 80 mm (3.15 in) forward of the rear stop.
- The seat will return to its previously set position when you place the ignition device into the **ON** position.
- The easy entry/exit function is disabled when the driver seat position is less than 80 mm (3.15 in) forward of the rear stop. In this position, there would be no benefit to the driver by moving the seat for easy exit or easy entry.

Each stored memory setting will have an associated easy entry/exit position.

NOTE:

The "Easy Entry/Exit" function can be enabled or disabled using the MIA system, refer to “Function of Settings Menu on MIA” in section “Dashboard Instruments and Controls” for further information.



Rear Seats

Rear seats can fit three passengers. Seats, head restraints and seat belts are parts of the occupant restraint system of the vehicle.



WARNING!

Be sure everyone in your vehicle is in a seat and using a seat belt properly.

NOTE:

For further information,  : chapter "Occupants Restraint Systems (ORS)" and "Head Restraints" in section "Safety".

Rear Seat Folding Seatback

The 40/20/40 split-folding seatback of the rear seat provides for a self-folding function that can be set using the lever on seat external side. The LH lever folds the long part (40+20), while the RH lever folds the shorter one (40).

To fold the seatback, lift the lever and the backrest portion will fold autonomously to increase the cargo space. To restore the sitting position, the backrest must be tilted up till the original position where it locks to the body.

Ensure that seatback is fastened to the position by trying to move it back and forth.



WARNING!

- **When the seat backrest is released, both from the lower level or from the cargo space, it folds till the flat position. Make sure that you or other people are not in the seat trajectory before operating the release lever.**
- **Be sure that any fragile object is not present in the folding areas of the seat to avoid damages due to their weight.**
- **Ensure the seatback is always locked before fastening the rear seat belts. An unlocked seatback cannot ensure the necessary stability for passengers and/or for child seats. An unlocked seatback could cause severe injuries in case of accident.**
- **When fastening a child seat on external rear seats, ensure that the**

corresponding seatback is duly locked in the less tilted position.

- **Always check that the head restraint of the rear seats that must be occupied by a passenger is correctly adjusted ( : chapter "Head Restraints" in section "Safety".).**

NOTE:

Rear seat backrest can be fully folded to increase luggage space. See "Cargo Area" in this section for further details.

Rear Armrest

The rear armrest is mobile and can be folded up into the seatback.

- To lower it, pull the stripe as indicated.

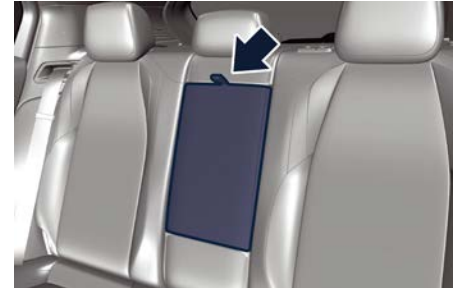

- To close it, pull it upwards then push it back into its seat.

On the front part of the armrest there are two cupholders (see "Internal Equipment" in this section).



Understanding the Vehicle



CAUTION!

- The armrest is not designed to support the weight of an adult or a child: please use it only to store beverages or small objects.
- When the seat backrest portion (60) or central portion is folded make sure that the armrest is not open (must be inside the seat). Folding the seat with the armrest open and, eventually, with objects inside the cup holder, can cause damage to the objects and potential damage to the seat itself.

NOTE:

The seatback central portion where the armrest is located can fold completely allowing you to carry long objects or ski bags with no need to fold the seatback. See “Cargo Area” in this section for further details.

Rear Side Heated Seats ()

The side rear seats can be equipped with heaters both in seat cushion and seatback.

Rear seats heating can be adjusted by operating control devices on the climate control panel for rear passengers on the backside of the central tunnel.



WARNING!

- **Persons with low skin sensitivity because of advanced age, chronic illness, diabetes, spinal cord injury, medication, alcohol use, exhaustion or other physical conditions must be careful when using the seat heater. It may cause irritations even at low temperatures, especially if used for long periods of time.**
- **Do not place anything on the seat that insulates against heat, such as a blanket or cushion. This may cause the seat heater to overheat. Sitting in a seat that has been overheated could cause irritations due to the increased surface temperature of the seat.**

The icon on the control panel with the resistance icon and horizontal lines activates the heating on the corresponding seat.

- Push the heated seat switch once to turn the HI heating level on.
- Push the heated seat switch a second time to turn the MED heating level on.
- Push the heated seat switch a third time to turn the LO heating level on.
- Push the heated seat switch a fourth time to turn the heating elements off. The LEDs will turn off.



NOTE:

- Once a heat setting is selected, heat will be felt within two to five minutes.
- The engine must be running for the heated seats to operate.



Steering Wheel Adjustment

This function allows you to tilt the steering column upward or downward or to lengthen or shorten it in order to adjust the steering wheel to an optimized position.

NOTE:

Make sure that the distance between your upper body and the steering wheel is at least 10 in (25 cm).

Power Adjustment

The power tilt/telescoping steering column/wheel switch is located on the lower side of the steering column.

To adjust the tilt of the steering column/wheel, move the switch up or down as desired.

To lengthen or shorten the steering column/wheel, pull the switch toward you or push it inward as desired.



NOTE:

You can use your key fob or the memory soft-keys on the Comfort display to return the tilt/telescopic steering column/wheel to programmed positions. See “Memorize the Driver’s Seat Position” in this section.



WARNING!

Do not adjust the steering column/wheel while driving. Adjusting the steering column/wheel while driving could cause the driver to lose control of the vehicle. Be sure the steering column/wheel is adjusted before driving your vehicle. Failure to follow this warning may result in serious injury or death.

Heated Steering Wheel ()

The steering wheel may contain a heating element inside the rim that helps warm driver’s hands by cold weather.

The heated steering wheel has only one temperature setting.

The heated steering wheel can be turned on and off using the Comfort Display as shown in picture.

Touch the steering wheel icon to activate the heating function.



- The engine must be running for the heated steering wheel to operate.
- The heating of the steering wheel can start automatically when starting the engine under particular conditions (see "Functions of Settings Menu on MIA" in section "Dashboard Instruments and Controls").

If the function is not active (state "OFF"), the dynamic parts of the icon are grey: to activate the function operate in the following mode:

- Touch the heated steering wheel soft-key to turn on the function displayed by the steering wheel icon with the arrows and red line.
- Touch the heated steering wheel soft-key a second time to shut off the function: the dynamic parts of the icon turns grey.



WARNING!

- Persons who are unable to feel pain to the skin because of advanced age, chronic illness, diabetes, spinal cord injury, medication, alcohol use, exhaustion, or other physical conditions must exercise care when using the steering wheel heater. It may cause irritations even at low temperatures, especially if used for long periods.
- Do not place anything on the steering wheel that insulates against heat, such as a blanket or steering wheel covers of any type and material. This may cause the steering wheel heater to overheat.

Rear View Mirrors

External Mirrors

External mirrors can be adjusted electrically and are equipped with anti-mist resistors operated by the air conditioning system (see “Air Conditioning Controls” in section “Dashboard Instruments and Controls”). The mirrors can be closed electrically and will yield in both directions in case of a collision.

The external mirrors are electrochromic (), which means, they automatically operate an anti-dazzle function by gradually shading as the light hitting the mirrors increases.

The external rearview electrochromic mirrors work in conjunction with the internal rearview electrochromic mirror.

NOTE:

- The mirrors can be adjusted electrically only with the ignition device in **ON** position.
- When the vehicle is started, the warning light shown in the picture will momentarily illuminate in both outside rear-view mirrors to let the driver know that the BSA system () is operational. For more details see chapter “Blind Spot Assist - BSA” in section “Driver Assistance Systems”.



The external of the rear-view mirror support is equipped with LEDs, lighting up when the turn signals and vehicle entry/exit lights are activated. When the surround view camera system is installed, at the external bottom side of the rear-view mirror is the side view camera (refer to “Surround View Camera System” in section “Driver Assistance Systems”).

Mirrors Positioning

The power mirror controls are located on the driver's door trim panel. The power mirrors control consist of a mirror select inner ring and a four-way joystick switch.

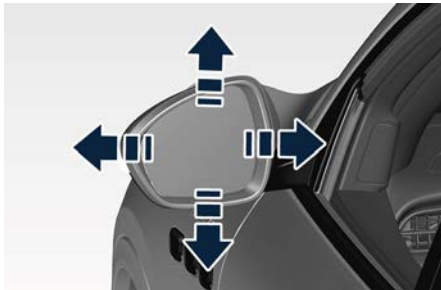

To adjust a rear view mirror, rotate the inner ring on **L** (left) or **R** (right) position to select the mirror that you want to adjust. A dot LED on it will illuminate indicating which rear view mirror is activated and can be adjusted. Press the mirror joystick switch to the direction of the desired movement. For optimal vision orientate the outside(s) mirror(s) in order to frame the adjacent lane and get a partial overlap with the

visible image on the internal rear-view mirror.

Power mirror preselected positions can be reset by operating the optional memory driver seat device. Check “Memorize the Driver’s Seat Position” in this section for further information.



WARNING!

Vehicles and other objects seen in the external side convex mirror will look smaller and farther away than they really are. Use the inside mirror to judge the size or distance of a vehicle seen in the external side convex mirror.

Tilt Side Mirrors In Reverse

This function provides automatic external rear-view mirrors positioning, allowing the driver to view the ground area behind the front doors. The external mirrors will move slightly downward from the current position when the transmission is into (R) reverse mode. The external mirrors will then return to the original position when the transmission is moved out of the (R) reverse mode.

Each memory set of the driver’s seat (see “Memorize the Driver’s Seat Position” chapter in this section) corresponds to a mirror tilt position in reverse.

NOTE:

The mirrors tilt in reverse can be turned on and off using the MIA system, refer to “Functions of Settings Menu on MIA” in section “Dashboard Instruments and Controls”.

Folding Mirrors

By selecting this function on MIA the rear-view mirrors automatically fold when the vehicle is locked by the key fob and when the power liftgate is closed and locked by pressing the  button on the right ledge of the liftgate interior trim. When the vehicle and the liftgate will be unlocked and the ignition device is set in **ON** position, the rear-view mirrors will automatically open in the position they had before the lock. The switch for the power folding mirrors is located on the drivers’s door trim panel.





With the inner ring in position **0** move it to position  to fold the mirrors.

Turn the inner ring to position **L**, **R** or **0** to return the mirrors to the driving position.

There is a way to make external mirrors automatically fold/unfold.

- If the function is available, it needs to be activated by MIA (refer to “Functions of Settings Menu on MIA” in section “Dashboard Instruments and Controls”).
- If the mirrors are automatically folded after the last lock action, then they will automatically unfold when the ignition device is set in **ON** position.
- If the mirrors were manually folded by the switch on the driver’s door panel, before a lock action, they will need to be manually unfolded to reactivate the automatic function.



CAUTION!

Never retract or open the mirrors manually: it could damage the power mechanism.

Internal Rear-View Mirror

The position of internal rear-view mirror can be manually adjusted, and is endowed with an accident prevention release system operating in the event of a collision.

Internal rear-view mirror is electrochromic: this glare function is automatically deactivated in reverse to ensure maximum visibility of obstacles.



CAUTION!

To avoid damage to the mirror during cleaning, never spray any cleaning solution directly onto the mirror. Apply the solution onto a clean cloth and wipe the mirror clean.

“Mirror Dimmer” Function

The internal rear-view mirror is equipped with an auto-dimming function.

Typical case is at night when the auto-dimming can be excessive (low reflectance). This function will increase the reflectance of the internal mirror, increasing visibility.





External Lighting

External Lights Equipment

The vehicle is equipped with lighting systems and functions; some of these are completely automatic, other can be switched on and off via the light menu on the Comfort Display and the multifunction lever on the dashboard, or via "Settings" menu of "Vehicle" page on MIA.

This chapter only describes systems that may or may not be installed because of the various options available.

For switching the external lights on and off via the light menu on the Comfort Display and the multifunction lever behind the steering wheel, refer to the chapter "External Light Controls" in section "Dashboard Instruments and Controls".

External Lights Cluster

The lights of the front clusters are arranged as follows:

Full-LED Version

- 1 Low-beam light LED.
- 2 Position, DRL and turn signal light LED.
- 3 High-beam light LED.
- 4 Side-marker LED.
- 5 Cornering light LED.
- 6 Side Reflex LED

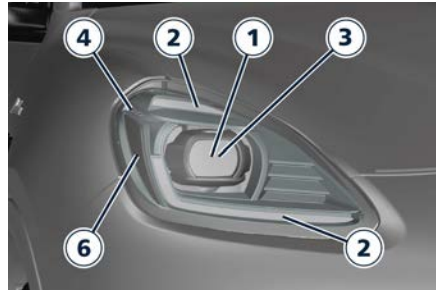

Base Version

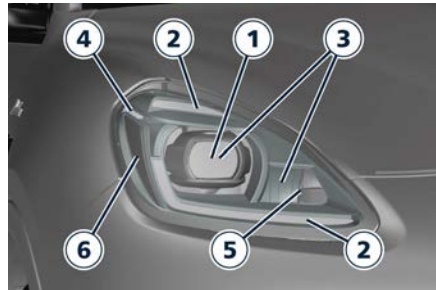

Top Version

The lights of the rear clusters are arranged as follows:

- 1 Position light / Side marker LED.
- 2 Stop light LED / Turn signal LED.
- 3 Reverse light LED.
- 4 Side reflex-reflector.

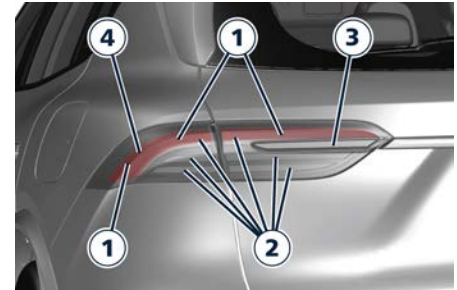

Integrated External Rear-View Mirror Lights

LED turn signals are integrated on the support of the external rear-view mirrors.



The LED turn signal indicators flash simultaneously with the corresponding turn signal lights in the front and rear of the vehicle. Turning on the hazard warning lights will also activate these LEDs.

All external mirrors are equipped with approach and courtesy LEDs, lighting



up when the vehicle entry/exit lights are activated. For further information, see chapter "Illuminated Entry/Exit" in section "Before Starting".

SmartBeam™ System

The SmartBeam™ system provides increased forward lighting for a more comfortable and secure driving experience without glaring other vehicles in several traffic situations.

The SmartBeam™ system uses a forward facing digital camera, located on the windshield behind the internal rear-view mirror, and an electronic headlights controller in order to dynamically adapt the front light distribution according to the traffic scenario.

The digital camera works like a human eye, it is able to see which is the traffic context while the headlight electronic controller works like a human brain, using information from the camera to command a headlight reaction that gives to the driver the "best" light distribution (best is always in reference to the specific traffic environment).

The camera gives information to the electronic headlight controller about environmental brightness, traffic participants vehicle and obstacles lights, distances and velocities. Using a proper combination of all these data the smart beam system is able to dynamically

modify the light shape produced by the dipped beam and by the full beam as well, to make the driver visibility as much comfortable as possible in every condition without glaring other traffic participants.

System Limitations

There are some cases in which the SmartBeam™ system could not properly work temporarily causing glaring for other vehicles especially with "Auto Dim High Beams" function activated on MIA "Settings" page (see "Functions of Settings Menu on MIA" in section "Dashboard Instruments and Controls").

These cases could be related to:

- Vehicles headlight and/or rear light (one or both of them) not visible in the field of view of the camera.
- Heavy rainy weather.
- Heavy foggy weather.
- Snowing weather.
- Windshield dirt or impurities in camera lens zone.
- Camera lens obstruction or logging.

In all these cases, it will be driver's responsibility to avoid this glaring by acting manually on the system, switching off the high beam by means of steering wheel multifunction lever.

Adaptive "Full-LED" Headlight



The Adaptive Front-lighting System actively adjusts the lights depth. The shape of the light beam according to the driving conditions combines excellent visibility of the road with minimum glare for the vehicles traveling in the opposite direction.

"Full-LED" Technology

This technology allows having headlights with a simpler construction and a more compact size.

Other advantages are:

- a clearer light beam, with a cool white tone that allows a better perception of the contrasts thus making the night vision more efficient and less tiring;
- a longer duration equivalent at least to that of the vehicle;
- a reduced current consumption.

These functions positively affect some vehicle management economy aspects by eliminating/reducing the fuel consumption.

The picture shows the increased brightness of the low beam of standard halogen headlights (A) compared to those Full-LED (B) in the "motorway beam" mode.

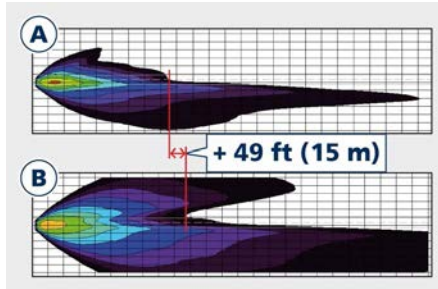

AFS Functions

These headlights combine the “Full-LED” technology to the AFS (Advanced Frontlighting System) adaptive functions.

The system is able to process signals of onboard systems and subsequently start up four strategic steps in the following situations:

- “motorway beam” that improves low beam performance exceeding 68 mph (110 km/h);
- “base beam” from 31 mph (50 km/h) to 68 mph (110 km/h);
- “town beam” that increases beam spread from 0 mph to 31 mph (50 km/h);
- “adverse weather beam” that reduces glare on wet roads;

A fifth strategic step is the “tourist beam” that can be manually activated for example in countries with circulation on the opposite side; in this case,

the function “Headlight Dip” must be activated via the menu of MIA (refer to “Functions of Settings Menu on MIA” in section “Dashboard Instruments and Controls” for more details).

The advantages offered by the AFS system are perceived especially in case of bad weather, fog and/or insufficient road indications providing broader illumination of the side zones, which are normally left in the dark, and for motorway driving.

This surely increases driving safety as it offers less eye stress and increased orientation for the driver and better detection of other persons on the road sides (pedestrians, bicycle riders and motorcycle drivers). Furthermore, the headlamps are suitable to prevent glare to the other vehicles, providing optimal lighting when driving the car in a country with circulation on the opposite side.

The system assures better visibility of the road surface when driving in a curve, steering, or in the event of road deviations, optimizing vertical light distribution according to the current drive path.

The increased lateral illumination is gained through a fixed bending light or a cornering light (depending on the market) elaborating information about

the steering angle, the vehicle speed and the turn indicator.

The improved vertical illumination, in case of fast acceleration and/or fast deceleration, will assure the deeper illuminated distance from the vehicle, through a dynamical adaptation of headlight vertical attitude.

NOTE:

- Each time the headlight system is turned on, the headlights adjustment will perform a self-adjustment cycle.
- “Adaptive Front Lights” function can be turned on or off using the MIA system, refer to “Functions of Settings Menu on MIA” in section “Dashboard Instrument and Controls” for further information.

AFS System Failure

In the event of AFS system unavailable, the related warning light and message will light up on the cluster display. Take your vehicle to the nearest Center of the **Authorized Maserati Dealer** as soon as possible to check the system.



Automatic High Beam (OPT)

The Automatic High Beam headlight control system provides increased forward lighting at night by automating high beam control through the use of the forward-facing digital camera located behind the rear-view mirror, which is the same one used for example by the Active Lane Management - ALM system on vehicles with ADAS systems. This camera detects the environmental luminosity, the headlamps of oncoming vehicles and the tail lamps of proceeding vehicles in the front area.

In these cases system automatically switches from high beams to low beams until the approaching vehicle is out of view.

Furthermore, using the maps, together with the camera, the system is able to detect the urban areas and the inhabited

centers and to turn off the high beams when driving near of one of them. The system will be active once passed the speed of 21.7 mph (35 km/h). The properly working for this system (if all the other conditions are met) is ensured between 15.5 mph (25 km/h) and 155 mph (250 km/h).

Activation Mode

To activate Automatic High Beam function:

- Activate the "AUTO" button in the Light menu on the Comfort Display.
- Touch the "Vehicle" soft-key on the main category bar of the MIA display and open the "Settings" menu.
- Choose the "Auto Dim High Beams" function in the "Lights" submenu and insert the check mark in the box to turn on the function.
- To turn off the function delete the check mark in the box.
- Shift the multifunction lever onward



NOTE:

All the previous steps must be performed with the ignition device in ON position

After these steps, the white indicator on the left side of the cluster display comes on.

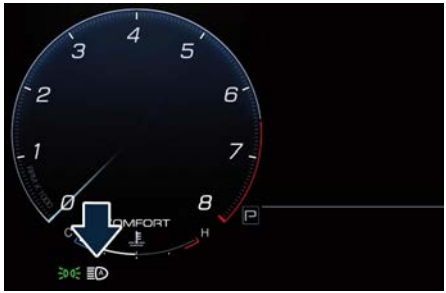

Once the high beams are physically on, the blue indicator on the left side of the cluster display comes on.

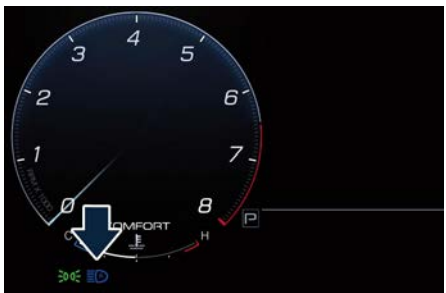

NOTE:

- The function is enabled only if the brightness sensor detects the right lighting conditions and then switch to low beam on.
- Broken, muddy, or obstructed headlights and taillights of vehicles in the field of view will cause headlights



to remain on longer (closer to the vehicle). Also, dirt, film, and other obstructions on the windshield or camera lens will cause the system to function improperly.

High Beam with “Glare Free” Function (for “Full-LED” headlight with AFS)

The “Glare Free” function assists the driver during traveling on an off-city road with not sufficient environmental illumination allowing the high beam use also with other traffic participants without glaring disturbance.

The no glaring effect is obtained through matrixes of LED that are dynamically switched on and off in order to create a shadow zone in correspondence of each other traffic participants lights (motor vehicles and bicycles, as well), according to the information about other vehicles’ lights coming from the forward-facing digital camera located on the windshield, behind the internal rear-view mirror.

The no glaring system is a multi-shadow system, since it’s able to create up to four dark tunnels simultaneously, each tunnel zone is as large as the obstacle that should not be glared.

The figure represents an example of the car that is traveling in the following scenarios:

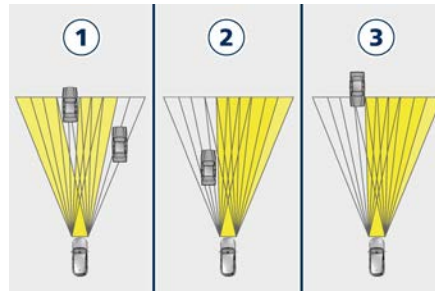

- 1 two vehicles ahead in the same direction;
- 2 another vehicle that is overtaking;
- 3 another vehicle proceeding in the opposite direction.

The system is able to detect and react to an oncoming vehicle starting from a distance of about 437 yds (400 m), within a second. Instead, in case of the preceding vehicles, the system is able to detect and react in a second starting from a distance of about 109 yds (100 m).

Activation Mode

The digital camera is the same used for the automatic high beam, and like automatic high beam also for “Glare Free” function it needs to be activated

by MIA “Settings” menu of “Vehicle” page, insert the check mark on the box of the “Auto Dim High Beams” function (see chapter “Functions of Settings Menu on MIA” in section “Dashboard Instruments and Controls”).

The “Glare Free” function will be engaged only if the engine is running. The “Glare Free” function will work only if the vehicle speed is equal or greater than 35 km/h (21.7 mph) in the engagement phase of the function. Once the system will be active, there will be two indicators on the instrument cluster, showed at the same time: one blue and one green.

The green indicator indicates that the position lights are on; the blue indicator indicates that all or only some high beam LEDs are physically on in that moment. When instead there is the needing to switch off the whole high beam module to obtain the no glaring effect, on the instrument cluster there will be the green position lights indicator and the auto high beam indicators in white.

When the scenario allows the partial or full use of high beam with no glaring disturbance, the blue indicator will appear again.

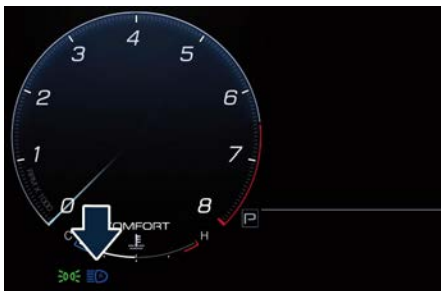

NOTE:

- Some unpredictable conditions, such as dirt, dust, film or any other obstruction on camera lens zone events could affect “Glare Free” function making it working improperly.
- Heavy rainy and foggy weather could affect system performance, leaving the full beam switched on for longer time than the nominal working condition. This could cause a glaring disturbance for other vehicles, to avoid this the driver has to switch off the high beam manually.
- In phase of disengagement of the function, the minimum operating speed is 15.5 mph (25 km/h).
- “Glare Free” function proper operation is guaranteed if vehicle speed is less than, or at least equal to 155 mph (250 km/h).

Automatic High Beams/Glare Free High Beams Failure

In the event of a failure on high beam system (Automatic or Glare Free equipped, as well), the related amber warning light will light up on the cluster display.

Take your vehicle to the nearest Center of the **Authorized Maserati Dealer** as soon as possible avoiding to use this system.

Interior Lighting

The interior and external approach lights turn on and off when entering/exiting the vehicle (see “Illuminated Entry/Exit” in section “Before Starting” for further information).

Dome Lights

The dome lights integrated into the front dome console, include two reading lights.

The reading lights automatically turns on when one of the doors is opened and turns off when the door is closed (timed switching off).

The reading lights are controlled by the respective side buttons.



If they are turned on by pressing the button, they will stay on for about 10 minutes after turning the engine off, and will then turn off gradually.





If one or more doors are opened, the front and rear dome lights will turn on for 27 seconds. If the door is closed before this time, the lights will dim and subsequently switch off after about 3 seconds.

NOTE:

The dome lights will also turn on by pressing the  or  button for centralized doors unlock and lock on the key fob. See “Illuminated Entry/Exit” section “Before Starting” for further information.

In the event of a collision causing automatic interruption of fuel supply, the dome lights switch on automatically and remain lit for approx. 15 minutes. Apart the lights on the front dome console, there is a light with relevant on/off switch located on the internal roof lining for the external rear seats. These lights will operate only when the ignition device is in **ON** position.



Button to Switch on Passenger Compartment Lights

In addition to specific switches to turn on and off the dome lights as previously described, on the front console there is a button that allows to turn on all these lights.



The lighting of all the compartment lights when opening the doors can also be inhibited by pushing the indicated button.



Interior Lights

To protect the battery, the interior lights will turn off automatically 10 minutes after the ignition device has been shifted to **STOP**. This occurs if the interior lights were turned on manually or by opening a door. The glove box light, on the dashboard, shares the same characteristics excepting the trunk and liftgate lights. When the ignition device is out of **STOP**, the light switch can be in any position, and the system is in “NIGHT” mode (detected by the RLS solar sensor) the brightness of controls, instruments and ambient lights, can be adjusted by means of the soft-key on the Comfort Display, enter “Ambient Light Menu”.

The dimmable lights are the following:

- instrument cluster display;
- dome light (front/rear);
- LED on the unlatch button to open the door;



Understanding the Vehicle

- doors and steering wheel backlight controls LED;
- front footrest light;
- front seats night lighting.

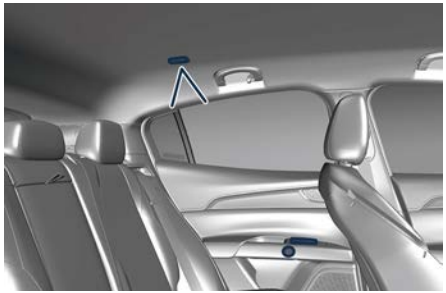
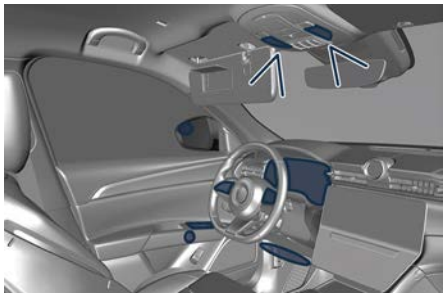

Cargo Lights

To illuminate the cargo area there are two lights on liftgate and two more inside the trunk compartment. These lights turn on when liftgate is opened and turn off when it is closed.

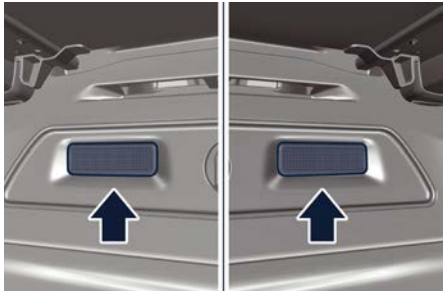
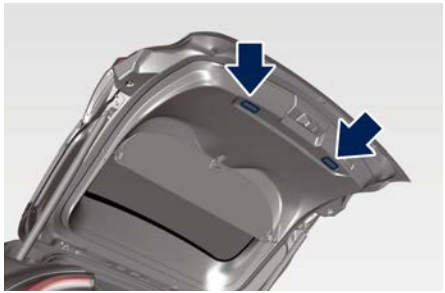

If liftgate is left open for a long time, lights will turn off after 30 minutes to save battery charge.

Internal Equipment



WARNING!

Cellular phones, music players, and other handheld electronic devices should be stowed while driving. Use of these devices while driving could cause an accident due to distraction.

Electric Power Outlets

The vehicle is equipped with two 12 Volt (13 Amp) electric power outlets, one inside the rear central tunnel compartment and one fitted in the trunk compartment.

An additional 115 V electric power outlet (⏏) can be equipped in the trunk compartment left side.

In vehicles equipped with “Cigarette Lighter” the electric power outlet inside the cupholder is replaced with a specific socket.

All power outlets are supplied only when the engine is started or the ignition device is set to **ON**.

Power outlets are protected by a fuse. Insert a cigar lighter or accessory plug into the power outlets to ensure proper operation. Otherwise, check the matching fuse integrity, see “If a Fuse Blows” in section “In an Emergency” for further information.

**CAUTION!**

- Do not plug in accessories that exceed the maximum power of 160 Watts (13 Amps) at 12 Volts.
- Power outlets are designed for accessory plugs only. Do not insert any other object in the power outlets as this will damage the outlet and blow the fuse. Damages caused by improper use of the power outlet are not covered by the New Vehicle Limited Warranty.

**WARNING!**

To avoid serious injury or death:

- Only devices designed for use in this type of outlet should be inserted into any 12 Volt outlet.
- Replacing the fuses that protect power outlets with others of higher amperage, there is the risk of fire.
- Do not touch with wet hands.
- Close the lids when the plug is not used and while driving the vehicle.
- If this outlet is mishandled, it may cause an electric shock and failure.

Power Outlet for Cigarette Lighter inside the Rear Central Tunnel Compartment

To access the 12 V power outlet inside the rear central tunnel compartment behind the cupholders, press the button

as indicated to completely open the armrest.

NOTE:

This outlet is specifically dedicated to power the cigarette lighter. It is not recommended to use it as an outlet to charge devices: use the other power outlets for this function.

**CAUTION!**

High power consumption items plugged into this outlet for long periods may discharge the battery and/or prevent the engine from starting.



Inside the rear central tunnel compartment, under the armrest, there is a storage area for storing the key fob.



Power Outlet inside the Trunk

The 12 V power outlet is positioned on the left side of the trunk compartment.



An additional 115 V electric power outlet (OPT) can be equipped in the vehicle below the 12 V socket.



Cupholders

The vehicle is equipped with several cupholders.



CAUTION!

- Use light and shatterproof containers.
- Do not forcefully push unsuitable containers into the cupholders to prevent damage to the containers.
- Do not store hot drinks.

Cupholders for Front Passengers

The front cupholders are located between the front and rear central tunnel compartments.

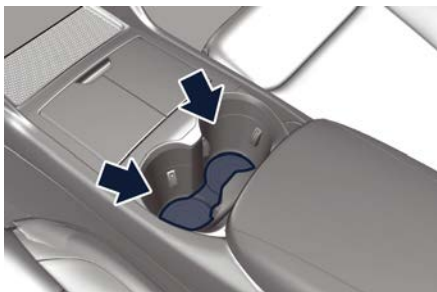
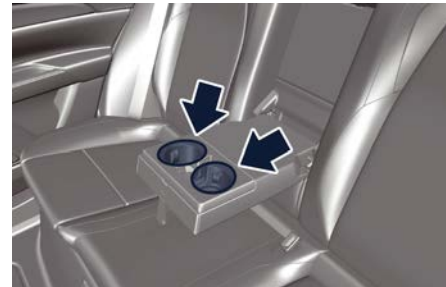

Cupholders for Rear Passengers

Two cupholders are available in the front side of the rear seats central armrest.

Multimedia Ports

The ports are located inside the compartment at the front end of the central tunnel. To access the inputs, lift to the side the two half lids as indicated.

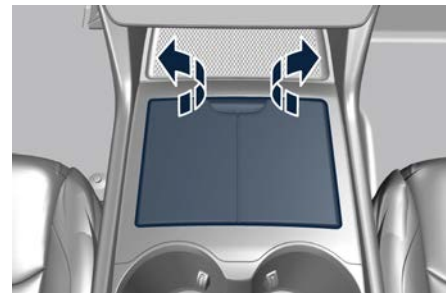



The USB ports (Type-A and Type-C) can be used for data exchange (refer to the "Maserati Intelligent Assistant™ (MIA)" guide for further details) and charge of the connected source.

For rear seat passengers, there are two ports (Type-A and Type-C) inputs inside the compartment located on the rear end of the central console, under the air vents.

This USB ports allow charging (CHARGE ONLY label) the connected source.



Following conditions can create USB inputs damage or malfunction:

- Usage of non-original lighting cables.
- Usage of defective rechargeable devices (smartphone, tablet, mass storage devices or other generic USB devices).
- ONLY insert media, into your vehicle if it came from a trusted source.
- Usage of damaged or defective cables.

Wireless Charger ^(OPT)

The Wireless Charger is located in a dedicated phone box compartment on the central tunnel, under the Comfort Display.

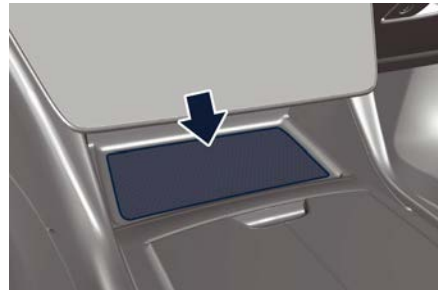

The Wireless Charger allows you to recharge your mobile phone (if it support this technology) without have to connect it to the charging port through a cable. The Wireless Charger system is designed to wirelessly charge mobile

phones (maximum power available 15 W) compatible with the Qi® standard.

The system is activated in automatic mode when the mobile phone is placed in its compartment.

If the mobile phone is removed from the Wireless Charger compartment during the wireless charging phase, this will automatically be interrupted.



CAUTION!

- Key fob must not be placed on or close to the Wireless Charger compartment. This could cause excessive overheating and damage to the key fob. Placing the key fob in the Wireless Charger compartment may prevent the engine from starting. In this case, a dedicated message will be shown on the MIA screen to alert the driver of the need to remove the key fob from this compartment.
- Do not place any other type of metal or magnetized object (e.g. credit cards, coins, badge, etc.) inside the Wireless Charger compartment.
- Make sure that you place the mobile phone correctly (display facing upward) in the phone drawer: charging may not be enabled if it is in the wrong position.



Understanding the Vehicle

2

- To avoid interference with the key fob search, the Wireless Charger system stops the charge for a moment when any door is opened.
- Make sure that there are no metal objects between the mobile phone and the wireless charger system during charging. Any such objects could overheat.

NOTE:

- The wireless charger device is equipped with an NFC antenna, so the "Apple Pay Wallet" function could be activated on iPhone phones: in any case this will not involve any economic transaction or charging interruptions.
- Some smartphones, due to their specific construction characteristics (e.g. internal metal body), could show charging problems in some driving conditions. In this case, the message "Foreign Object Detection (FOD)" may appear.
- According to driving style, brief interruptions in the charging process (with the related message popup activation) generated by the movement of the smartphone within the charging area may occur. This is not an anomalous behavior and the charging process will resume regularly as soon as driving conditions permit.

- When using smartphone cases, the wireless charging efficiency may be reduced or not possible. In this case, it will be sufficient to remove the smartphone case and verify the restoration of the correct charging conditions, keeping in mind conditions and exceptions described in the previous paragraphs.
- During the charging process, the mobile phone can overheat and stop charging because of open applications or functions used. This is not an anomalous behavior. The charging process will resume as soon as the device's temperature drops to normal conditions.
- It is possible to deactivate the pop-ups related to the wireless charger by removing the flag on the MIA screen (see "Wireless Charger Status Popups" in chapter "Functions of Settings Menu on MIA" in section "Dashboard Instruments and Controls").
- In all disconnection cases, to restore normal charging conditions, simply place the telephone in the drawer central position.

The charge status icon of the mobile phone housed in the Wireless Charger compartment is always visible on the MIA in the "Home" (if the Phone widget

is visible or the icon is on the status bar) and "Phone" screen.

This icon becomes blue if the mobile phone is charging, green if it is fully charged and blinking red for system fail or foreign object in the compartment. The blink ends after a timeout of 5 seconds and the icon becomes solid until the fail is solved.

You can also drag and drop the Wireless Charger icon from the shortcut page to insert it in the upper status bar.



iPod® Connection

An iPod® can be connected to the system via USB ports.

The MIA will then control the following functions: play, pause, fast forward, rewind, next track, previous track, random or repeat mode, selection and navigation of playlist/genre/singer/album/Podcast.

**CAUTION!**

Do not leave your USB device, iPod® or an external audio source in the vehicle for extended periods of time: extreme temperatures and humidity can occur in the vehicle.

Sun Visors

Sun visors can be folded to the front and to the side of the vehicle. To move the sun visor laterally, lower and release it from its catch as indicated.

In this condition, the sun visor can be extended by sliding the sun visor end backward.

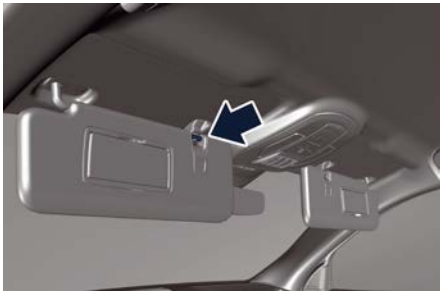

By lowering the sun visor you can access the courtesy mirror and, by opening the mirror protective cover, a LED light will automatically light up (with the ignition device in **ON**).

NOTE:

The light on the sun visor turns on only when it is in non-extended position and pushed towards the endstop of the sliding rod support.

Before raising the sun visor, close the mirror cover: the light will turn off.

A business card holder is fitted inside each sun visor.

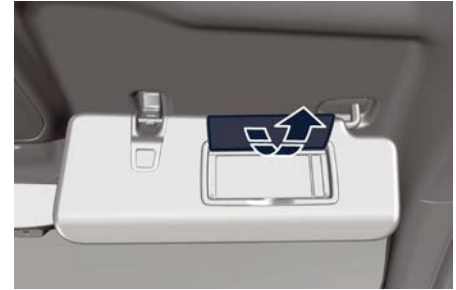
**Cigarette Lighter (OPT)**

The kit includes a lighter, that takes place of the power outlet, in the rear central tunnel compartment.

In addition, an approved ashtray with cover can be located inside the cupholders, between the front and rear central tunnel compartments.

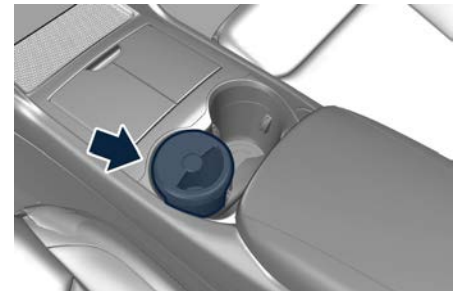

The rear seat passengers can use the removable ashtray by inserting it into the rear doors pocket.



Understanding the Vehicle

Press the central button to activate the cigarette lighter. After about 20 seconds the button returns automatically to the initial position and stops the heating: from this time the cigarette lighter is ready for use.

NOTE:

The Authorized Maserati Dealer can provide you with any information about the Maserati approved Ashtray, available in the "Genuine Accessories" range.



CAUTION!

After use, always make sure that the cigarette lighter is switched off.



WARNING!

- The cigarette lighter reaches high temperatures. Handle it carefully and do not allow children to use it so as to avoid risk of fire and injury!
- The cigarette lighter must not be used as a power outlet to avoid risk of fire and injury!

Handholds and Cloth Hooks

Handholds are fitted above the passenger doors. Once grabbed, they will lower until the block position. When released, a return spring will bring them back to the original position.



Cloth hooks are present on rear handholds.



On the side walls of the trunk compartment there is a shopping hook that can withstand a maximum load of 10 kg (22 lb).



Mesh Pockets

Front seats are fitted with mesh pockets, on the rear of the seatbacks, and accessible by rear passengers.



**CAUTION!**

Do not put heavy or sharp objects in the mesh pockets.

Wi-Fi Hotspot 

For further information about this service, see the “Maserati Intelligent Assistant™ (MIA)” guide.

Access the Glove Box Compartment

The glove box compartments on the dashboard passenger side may be used to store devices, small items or documents.

**WARNING!**

Do not operate the vehicle with the lid of glove box compartment in the open position. It could injure the occupants during a brake or in an accident.

**CAUTION!**

Do not place objects weighing over 22 lb (10 kg) in the glove box compartment.

To open the glove box, pull the handle as shown in the picture.



The glove box handle is equipped with a lock: if blocked, unlock the lock by



Audio System

The vehicle is equipped with an audio system that offers superior sound quality, higher sound pressure levels and reduced energy consumption.

The system maximizes the amplifier and speaker technology delivering substantially higher components and system efficiency.

Base System

The vehicle can be equipped with a basic sound system which features 8 speakers and can develop a sound output of 270 W.

The basic system includes:

- Four 6x9 in (152x229 mm) diameter Woofers, one on each door.
- Four 1 in (25 mm) diameter Tweeters, one at the base of the windshield side pillars and one on each rear door.

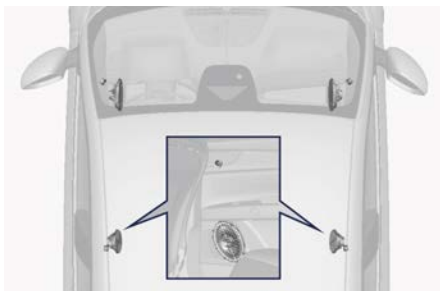

Base System

Sonus Faber Premium Audio System

The vehicle can be equipped with a “Premium” sound system which features 14 speakers and can develop a sound output of 860 W.

This system includes:

- Four 6x9 in (152x229 mm) diameter Woofers, one on each door.
- Three 3.9 in (100 mm) diameter Midrange: one on the top of the dashboard, one on each front door panel.
- Two 3.1 in (80 mm) diameter Midrange: one on each side wall of the trunk, above the cover level.
- Four 1 in (25 mm) diameter Tweeters: one at the base of the windshield side pillars and one on each rear door.
- One Fresh Air Subwoofer (Dual Voice Coil) in the trunk, under the front part of the floor.
- 17-channel amplifier positioned in the wall of the trunk left side.

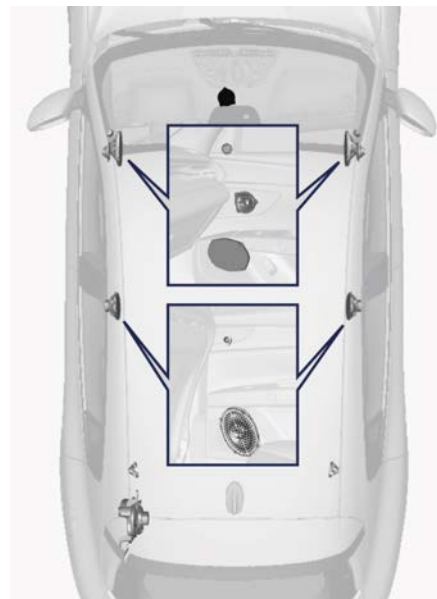

Sonus Faber Premium Audio System

Sonus Faber Additional Features:

- **Media expander:** application of algorithm for processing MP3 files or low resolution / compressed sources to improve sound quality.
- **Specific tuning:** 2 different set-up that can be chosen by the customer for characterizing their listening experience:
 - **GUARNERI:** precise soundstage with extreme openness, clarity and speed;



AMATI: full and balanced sound perception with enhanced bass.

- **Sound On/Off:** 2D surround delivers a spatial experience which is achieved with a proprietary surround sound algorithm.

Sonus Faber High Premium Audio System

The vehicle can be equipped with a “High Premium” audio system including 21 speakers and 1285 W of sound power, available upon request.

The “High Premium” system includes:

- Four 6x9 in (152x229 mm) diameter Woofers, one on each door.
- Three 3.9 in (100 mm) diameter Midrange: one on the top of the dashboard, one on each front door panel.
- Two 3.1 in (80 mm) diameter Midrange: one on each side wall of the trunk, above the cover level.
- Four 1 in (25 mm) diameter Height-Midrange: one on the windshield side pillars and two on the roof panel.
- Seven 1 in (25 mm) diameter Tweeters: one on center dashboard, one at the base of the windshield side pillars, one on each rear door and one on each side wall of the trunk, above the cover level.
- One Fresh Air Subwoofer (Dual Voice Coil) in the trunk, under the front part of the floor.

- 24-channel amplifier positioned in the wall of the trunk left side.



Sonus Faber High Premium Audio System

Sonus Faber Additional Features:

- **Separate Subwoofer control:** the subwoofer dB level can be selected according to customer preference.
- **Media expander:** application of algorithm for processing MP3 files or low resolution / compressed sources to improve sound quality.

- **Specific tuning:** 2 different set-up that can be chosen by the customer for characterizing their listening experience:
 - EX3MA:** full and balanced sound perception with enhanced bass;
 - REFERENCE:** precise soundstage with extreme openness, clarity and speed.
- **2D and 3D Surround, with intensity level (for 3D Surround only):** customer can select 2D and 3D Surround achieved with a proprietary surround sound algorithm.

Sonus faber has a natural sound delivered by consistent application of key technologies and philosophy design approach.

Signature ‘Voice of Sonus faber’ sound is achieved by optimizing the phase and amplitude alignment between midrange and tweeter.

Natural materials and proprietary loudspeaker design and construction are used to deliver unique tonal balance throughout the vehicle cabin.

Each speaker is driven by a dedicated power tailored Class-D Dual DSP amplifier stage.

This surround effect is available from any audio source - AM/FM/Satellite Radio or USB input and is activated through the MIA system controls (see “Functions of Settings Menu on MIA” in section “Dashboard Instruments and Controls”).



Understanding the Vehicle

All information on the current operational mode can be found in the specific booklet visible on the MIA screen. Fader control is available in surround mode but it should be set to the center position for optimal surround performance.

Cargo Area



WARNING!
To help protect against personal injury, passengers should not be seated in the rear cargo area. The rear cargo space is intended for load carrying purposes only, not for passengers, who should sit in seats and use seat belts.

Vehicle Load Carrying Capacity

The load carrying capacity of your vehicle is shown on the vehicle homologation label positioned on the rear driver door's ledge.



The information indicated on the label concerns passengers and luggage loading operations.

Do not exceed the specified Gross Vehicle Weight Rating (GVWR) or the Gross Axle Weight Rating (GAWR), both front and rear.

The GVWR is the total allowable weight of your vehicle. This includes driver, passengers, and cargo.

The total load must be limited so that you do not exceed the GVWR indicated on the label.



- WARNING!**
- Improper weight distribution can have an adverse effect on the way the vehicle steers, handles and the way the brakes operate.
 - Never drive with the liftgate open. Exhaust gases can enter the passenger compartment.
 - Do not arrange any luggage on cargo area cover. In said position luggage could not only impair driver's view but also, in case of collision or unexpected stop, it could cause injury to all occupants.

The trunk is the most suitable place to load bulky and heavy objects onboard the vehicle.

To load your vehicle properly, store heavier items below and be sure you distribute their weight as evenly as possible.

Stow all loose items securely before start driving as they could move during the trip.

To separate trunk from passenger compartment, the vehicle is equipped with a rigid horizontal panel, fitted behind the rear seat backrest. The **Authorized Maserati Dealer** can provide you with any information about the items dedicated to the usage of the trunk (luggage compartment mat, ...), available in the "Genuine Accessories" range.

Luggage Fasteners and Retainers

Vehicle can be equipped with fixed and mobile anchorages on trunk floor allowing to fasten and retain any luggage in a convenient and safe manner.

For retaining luggage or the documentation kit, on the trunk left side wall there is a special elastic band.



Longitudinal rails (PT) on trunk floor provide safe anchorage for luggage of different size, thanks to the special

hooks with locking button. To position the hook, slide it along the rails until reaching the required position, holding down the central button. Release the button and slightly move the hook to secure its position in the notches of the guide.



By using the Railing Fastening Bar, available in the "Genuine Accessories" range, fastened by means of sliding blocks along the floor rails, you can

fasten heavy luggage in the innermost area of the trunk.



CAUTION!

To avoid luggage inadvertent movement, in case of sudden braking or collision, always check correct fastening of the retainers onto floor rails before anchoring any luggage.

NOTE:

The **Authorized Maserati Dealer** can provide you with information about the available "Genuine Accessories" for the trunk compartment.

Loading with Rear Seatbacks Folded Down

The 40/20/40 split-folding seatback of the rear seat provides cargo-carrying versatility.

The seatback folded down provides a continuous nearly-flat extension of the load floor able to accommodate bulky luggage, large-sized equipment and objects that may not fit with the normal dimensions of the trunk.

NOTE:

Both seat backs can be folded down independently.



WARNING!

To prevent the other luggage in the trunk from getting into the passenger compartment and creating a potential danger for the passengers, keep trunk cover installed when folding down one of the two seatbacks.

When the seatbacks are unfolded to the upright position, make sure they are latched (see "Rear Seats" in this section).



WARNING!

- Make sure that the seatback is securely locked into position. If the seatback is not securely locked into position, the seat will not provide the proper stability for child seats and/or rear passengers. An improperly latched seat could cause serious injury.
- The cargo area in the rear of the vehicle with the rear seatbacks in the folded down position should not be used as a play area by children when the vehicle is in motion. They could be seriously injured in a collision. Children should be seated and use proper restraint systems.

Ski and Snowboard Bag Compartment

To stow and safely fasten a ski fold down the central seatback (20) pulling the indicated strap.



CAUTION!

When the seat backrest portion (60) or central portion is folded make sure that the armrest is not open (must be inside the seat). Folding the seat with the armrest open and, eventually, with objects inside the cup holder, can cause damage to the objects and potential damage to the seat itself.

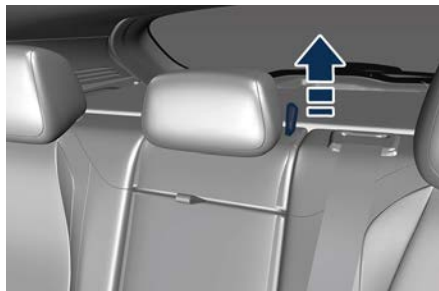

- Insert the bag end without anchor hook between the rear seats.
- Fasten the hook to one of the eyelets available on trunk floor.
- From the passenger compartment, route bag strap under central rear seat (20) and fasten it.



If you follow these instructions, the bag will be securely fastened to vehicle structure and will thus remain in place also in case of collision or unexpected braking.

Trunk Compartment Cover

Trunk compartment cover does not lift when liftgate is opened.

The cover can be rolled up to obtain a larger cargo area, as follows:

- slide the outer end of the trunk cover upward towards the outside of the car to slide the two lower ends out of their guides

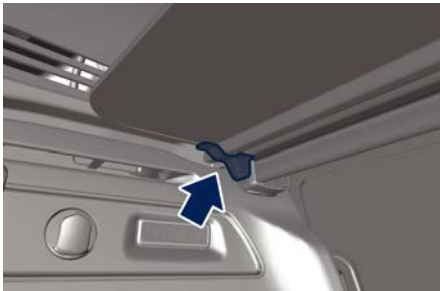

- slide the trunk cover to the end of the guide

**WARNING!**

Driving with rolled up cover could be dangerous. Any unfastened luggage or objects could move into the passenger compartment in case of sudden stop or collision and seriously injure the occupants.

When unrolling the trunk cover, perform the same operations in reverse order.

NOTE:

The rewinding of the trunk cover is not automated and must always be performed using the handle on the cover accompanying the rewinding operation.

**WARNING!**

After unrolling the trunk cover, make sure that the lower ends have properly engaged in their guides. If cover is not properly positioned and fastened, in case of unexpected stop or collision it could move and seriously injure the passengers in the rear seats.

Cargo Area Extension

The following procedure is aimed at obtaining the maximum possible extension of the cargo area, and it can be only a partial extension if you carry out only a few of the listed operations.

- Roll up the trunk cover as indicated under "Trunk compartment cover" in this chapter.
- Completely lower the head restraints of rear seats ( : chapter "Head Restraints" in section "Safety").
- On the left part (40 + 20) of the backrest place the central head restraint in the position of use indicated on the label applied on the fixed side

windows ( : chapter "Head Restraints" in section "Safety").

- Completely fold down the rear seats backrests by lifting the lever on the external part of the rear side seat or on the side wall of the trunk compartment.



- Release the lever when seatback is against the seat: the control cable will click into place and lock.



Now that seatbacks are folded down, trunk floor and the back panels of seatbacks will form a larger flat floor.



CAUTION!

Seatback rear panel is not suitable to support heavy loads and metal objects with protruding elements that might scratch its surface. If necessary, protect the seatback rear panel surface using rigid panels.

Front to Back Roof Rails (OPT)

The front to back roof rails that can be installed to this vehicle have been designed to carry luggage or equipment suitable for transport outside of the vehicle.



Weight of luggage/equipment carried on the rails must not exceed 158 lb (70 kg) and must be evenly distributed. This weight must be added to the load carried inside of the vehicle as well as the passengers' weight, and total must not exceed the total allowable weight-GVWR ( : chapter "Weights" in section "Technical Specifications"). When arranging load on rails, make sure that it will not interfere with liftgate and sunroof opening (if equipped). Securely fasten load to rails using the suitable retainers that can hold the original anchorage points throughout the trip.

When installing to rails any bicycle, surfboard or other types of carriers requiring cross bars, please comply with the equipment manufacturer's instructions to ensure proper installation. The **Authorized Maserati Dealer** can provide you with any information about the Maserati approved Carrying Items, available in the "Genuine Accessories" range.



WARNING!

- During the trip, it is recommended to periodically check that all luggage or equipment carried on the roof rails remained properly fastened. Parts or items that may have shifted or become unfastened during travel could damage the vehicle or become detached from the roof, resulting in potential danger to you or vehicles around yours.
- When driving with a bulky load on roof rails, take additional precautions and drive at lower speed, keeping a wider safety distance from vehicles ahead. Indeed, a bulky and/or heavy load carried on the roof will affect driving behavior and steering response since it shifts the vehicle center of gravity to a higher position compared to normal conditions.

**NOTE:**

All objects/equipment carried on the roof and protruding beyond the windshield, e.g. surfboard, must be fastened to both sides of the vehicle. Any wind blow might suddenly increase load lift possibly resulting in breakage and loss of part of the carried equipment.

HomeLink®

HomeLink® replaces up to three hand-held transmitters operating the automatic devices that open garage doors and gates, enable/disable the lighting or security systems. The HomeLink® unit is powered by your vehicle's 12 Volt battery. The HomeLink® buttons that are located on the driver sun visor designate the three different HomeLink® channels. The HomeLink® warning light is located behind the buttons.

**NOTE:**

HomeLink® is disabled when the vehicle security alarm is active ( : chapter "Vehicle Security Alarm" in section "Safety").

**WARNING!**

- **Your motorized door or gate will open and close while you are programming the universal transceiver. Do not program the transceiver if people, pets or other objects are in the path of the door or gate. Only use this transceiver with a garage door opener that has a "stop and reverse" function as required by Federal safety standards. This includes most garage door opener models manufactured after 1982. Do not use a garage door opener without these safety functions. Call toll-free 1-800-355-3515 or, on the Internet at www.HomeLink.com for safety information or assistance.**
- **Vehicle exhaust contains carbon monoxide, a dangerous gas. Do not run your vehicle in the garage while programming the transceiver. Exhaust gas can cause serious injury or death.**

Before You Start Programming HomeLink®

Be sure that your vehicle is parked outside of the garage before you begin programming.

For more efficient programming and accurate transmission of the radio-frequency signal it is recommended that a new battery be placed in the hand-held



Understanding the Vehicle

transmitter of the device that is being programmed to the HomeLink® system. Before starting programming it is necessary to erase the standard codes memorized on the HomeLink® device during the production phase. To erase such codes:

- place the ignition device in **ON** position without starting the engine;
- press and hold the two outside HomeLink® buttons (I and III) until the warning light starts flashing (after approximately 20 seconds);
- release the buttons.

NOTE:

- Erasing the standard codes should only be performed when programming HomeLink® for the first time. Do not perform this operation to program additional buttons.
- If you have any problems, or require assistance, please call toll-free 1-800-355-3515 or, on the Internet at www.HomeLink.com for information or assistance.

System with Devices Provided with Rolling Codes

Programming the Hand-held Transmitters Manufactured after 1995

These devices can be identified by the “LEARN” or “TRAIN” setting button located where the hanging antenna is attached to the garage door/gate

opener. It is NOT the button that is normally used to open and close the door.

The name and color of the button may vary by manufacturer.

- Place the ignition device to **ON** position without starting the engine.
- Place the garage door opener transmitter 1 to 3 inches (3 - 8 cm) away from the Homelink® button you wish to program.
- Push and hold the Homelink® button you want to program while you push and hold the garage door opener transmitter button you are trying to replicate.

The quick flashing light indicates that the channel with the new frequency has been acquired and programmed correctly by the HomeLink® system.

NOTE:

The distance necessary between the portable hand-held transmitter and the HomeLink® in the vehicle depends on the system you wish to program. Probably it will be necessary to try several times. Upon every attempt, keep the setting position for at least 15 seconds before trying again.

Synchronising the Rolling Codes

At the end of the previously-described programming, if the HomeLink® has been programmed for a rolling code system,

it will be necessary to synchronise it to ensure its correct operation.

- Locate the “LEARN” or “TRAINING” setting button of the opening motor. Firmly press it and then release it. On some garage door openers/devices there may be a light that blinks when the garage door opener/device is in the LEARN/TRAIN mode.

NOTE:

You have 30 seconds to initiate the next step after the setting button has been pressed.

- Return to the vehicle and press the programmed HomeLink® button for two seconds and then release it.
- Repeat this operation a second time.

If the garage door opening device activates, the programming/synchronization phase is complete.

NOTE:

If the garage door opening device does not activate, press the button a third time for two seconds and then release it to complete the programming/synchronization phase.

- To program the remaining two HomeLink® buttons, repeat the same step for the same remaining button. **DO NOT erase the channels.**



Reprogramming a Single HomeLink® Button

To reprogram a channel that has been previously trained, follow these steps:

- Place the ignition device to **ON** position without starting the engine.
- Press and hold the desired HomeLink® button.
- **Without releasing the button** proceed with “Programming the hand-held transmitters” from second step and follow all remaining steps.

System with Devices Without Rolling Code

Programming the Hand-held Transmitters Manufactured before 1995

- Turn the ignition device to **ON** position without starting the engine.
- Place the hand-held transmitter 1 to 3 inches (3 to 8 cm) away from the HomeLink® button you wish to program.
- Simultaneously press and hold both buttons until the warning light starts flashing quickly; then release both buttons.

The quick flashing light indicates that the channel with the new frequency has been acquired and programmed correctly by the HomeLink® system.

NOTE:

The distance necessary between the portable hand-held transmitter and the

HomeLink® in the vehicle depends on the system you wish to program. Probably it will be necessary to try several times.

Upon every attempt, keep the setting position for at least 15 seconds before trying again.

- Press and hold the programmed HomeLink® button.

If the garage door opener/device activates, programming is complete. To program the remaining two HomeLink® buttons, repeat each step for each remaining button. **Do not erase the channels.**

Reprogramming a Single HomeLink® Button

To reprogram a channel that has been previously trained, follow these steps:

- Place the ignition device to **ON** position without starting the engine.
- Press and hold the desired HomeLink® button.
- **Without releasing the button** proceed with “Programming the hand-held transmitters” from second step and follow all remaining steps.

Canadian/Gate Operator Programming

The programming of transmitters in Canada/United States require the

transmitter signals to “time-out” after several seconds of transmission:

NOTE:

Canadian Radio Frequency (RF) laws require transmitter signals to time-out (or quit) after several seconds of transmission, which may not be long enough for HomeLink® to pick up the signal during programming. Similar to this Canadian law, some U.S. gate operators are designed to time-out in the same manner.

It may be helpful to unplug the device during the cycling process to prevent possible overheating of the garage door or gate motor.

- 1 Place the ignition in the **ON** position.
- 2 Place the hand-held transmitter 1 to 3 inches (3 to 8 cm) away from the HomeLink® button you wish to program while keeping the HomeLink® indicator light in view.
- 3 Continue to press and hold the HomeLink® button, while you press and release (cycle) your hand-held transmitter every two seconds until HomeLink® has successfully accepted the frequency signal. The indicator light will flash slowly and then rapidly when fully trained.
- 4 Watch for the HomeLink® indicator to change flash rates. When it



Understanding the Vehicle

changes, it is programmed. It may take up to 30 seconds or longer in rare cases. The garage door may open and close while you are programming.

- 5 Press and hold the programmed HomeLink® button and observe the indicator light.

NOTE:

- If the indicator light stays on constantly, programming is complete, and the garage door/device should activate when the HomeLink® button is pushed.
- To program the two remaining HomeLink® buttons, repeat each step for each remaining button. **DO NOT** erase the channels.

If you have unplugged the garage door opener/device for programming, plug it back in at this time.

Reprogramming A Single HomeLink® Button (Canadian/Gate Operator)

To reprogram a channel that has been previously trained, follow these steps:

- 1 Place the ignition to the **ON** position.
- 2 Press and hold the desired HomeLink® button until the indicator light begins to flash after 20 seconds. Do not release the button.

- 3 Without releasing the button, proceed with “Canadian/Gate Operator Programming” step 2 and follow all remaining steps.

Using HomeLink®

To operate, press and release the programmed HomeLink® button. Activation will now occur for the programmed device (i.e., garage door opener, gate operator, security system, entry door lock, home/office lighting, etc.). The hand-held transmitter of the device may also be used at any time.

Security

It is advisable to erase all channels before you sell or turn in your vehicle. To erase the channels press and hold the two outside HomeLink® buttons (I and III) until the warning light starts flashing (after approximately 20 seconds).

The HomeLink® Universal Transceiver is disabled when the vehicle security alarm is active ( : chapter “Vehicle Security Alarm” in section “Safety”).

Troubleshooting Tips

If you are having trouble while programming HomeLink®, here are some of the most common solutions:

- Replace the battery in the original hand-held transmitter.

- Press the LEARN button on the garage door opener to complete the training for a rolling code.
- Did you unplug the device for programming and forgot to plug it back in?

If you have any problems, or require assistance, please call toll-free 1-800-355-3515 or, on the Internet at www.HomeLink.com for information or assistance.

NOTE:

You can consult the list of compatible devices with the HomeLink®, and their level of compatibility, on the website www.HomeLink.com.

Radio Frequency RKE Transmitter - Regulatory Information

The “Regulatory Information” for all the radio frequency and radar devices can be consulted by accessing the section “Services” on the website www.maserati.com.



Air Conditioning Distribution

Adjustable and fixed air vents allow passengers to achieve the optimal comfort conditions.

NOTE:

The **Authorized Maserati Dealer** can provide you with any information about the **Maserati approved Multifunctional Air Filter**, available in the "Genuine Accessories" range.

Fixed Air Vents

- The fixed vents, positioned on the upper surface of the dashboard, in the center and on the sides, are meant to guarantee the demisting and defrosting of the windshield and the side windows.

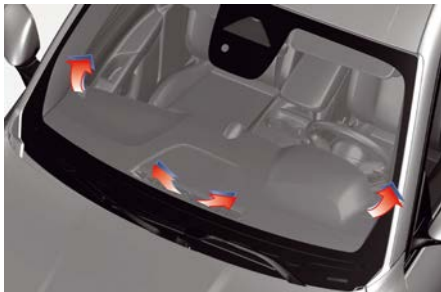

- The fixed vents under the dashboard are aimed at ventilating the lower part of the front passenger compartment.



The ventilation of the lower part of the rear passengers compartment is made by fixed vents positioned under the front seats.



Adjustable Air Vents

The adjustable vents are located at the center of the dashboard, above the MIA display and at the side ends of the dashboard. They have the purpose of ventilating the upper part of the passenger compartment. There are also adjustable vents placed at the rear end of the central tunnel. The rotor **1**, located near each vent, allows to control the quantity of the air flow from fully closed to fully open, and vice versa.

The grill of these vents can be oriented by operating on the central handle **2**.

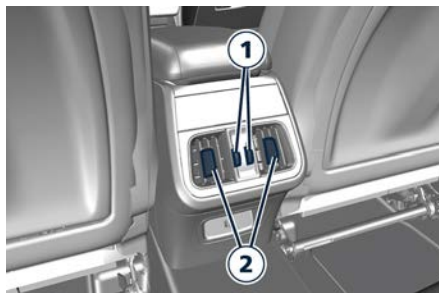
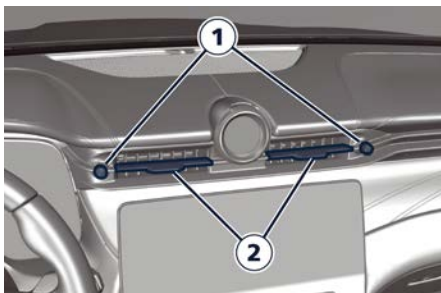

A/C Three-zone

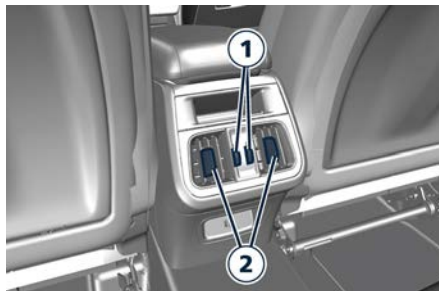

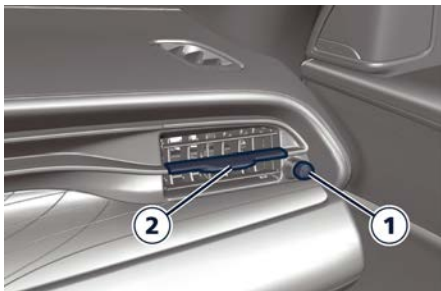

A/C Dual-zone



NOTE:
In order not to obstruct the air conditioning inlet, the defrosting or the demisting function of the glass surfaces, avoid covering vents with clothing or other items.



3 - Before Starting

Keys	58
Ignition Device	62
Illuminated Entry/Exit	64
Passive Entry System	67
Proximity System 	69
Exiting the Car	70
Power Windows	71
Power Sunroof with Sunshade 	73
Open and Close the Liftgate	75
Open and Close the Hood	80



Keys

The vehicle is equipped with an electronic key with a Remote Keyless Entry (RKE) transmitter, synthetically called "key fob", to enter and protect the vehicle.

The vehicle is provided with two programmed key fobs and a wearable activity key.

In addition to the RKE transmitter the key fob also contains a metal insert with the function of emergency key. You can keep the emergency key with you when using valet parking.



WARNING!

- When leaving the vehicle, always remove the key fob and lock your vehicle.
- Do not allow children to be in a vehicle unattended or with access to an unlocked vehicle. A child or others could be seriously or fatally injured. Children should be warned not to touch the parking brake trigger, brake pedal or the shift paddles.
- Before leaving the vehicle, ALWAYS engage the parking brake. Activate mode P (Park) and press the ignition device to set it to STOP. When leaving the vehicle, always lock all the doors

by pressing the  button on the key fob.

- Do not leave the key fob in or near the vehicle, and do not leave the ignition device in the ON position. A child could operate power windows, other controls, or move the vehicle.
- Do not leave children or animals inside parked vehicles in hot weather. Interior heat build-up may cause serious injury or death.
- An unlocked car is an invitation to thieves. Always remove the key fob from vehicle, cycle the ignition device to STOP and lock all doors when leaving the vehicle unattended.



CAUTION!

The electronic components inside the key fob may be damaged if the key fob is subjected to strong shocks. In order to ensure complete efficiency of the electronic devices inside the key fob, it should never be exposed to direct sunlight.



Key fob Operation

On the key fob there are 4 buttons with the following functions.



Doors Unlock

The short press of the  button unlock the doors. At the same time, switch-on in timed mode the interior courtesy lights and performs a single flashing of direction indicators (if activated from the MIA system).

To open all windows, perform a short press and release of the  button, then within 5 seconds press and hold  button.

When the function is enabled on MIA screen, press and release the  button on the key fob once only to unlock the driver side door or twice within 1 second to unlock all doors.

It is however possible to change the current setting through the MIA menu. So that the system unlocks: all doors on the first press of the button; only the driver door on the first press of the button (where provided).



Moreover, from the MIA system you can activate or deactivate the flashing of the direction indicators upon locking/unlocking the doors and activate the "Greetings Light" function (dipped beam headlights, welcome lights and direction indicators switch on) upon unlocking the doors. For further information, see "Functions of Settings Menu on MIA" in section "Dashboard Instruments and Controls."

The driver's door can always be unlocked in the following way:

- Insert the emergency key in the cavity on the plastic cap on the handle (see "remove the emergency key from the key fob" in this chapter).



- Rotate the emergency key in order to align the reference marks present on the cap and the handle body.



- Remove the cap and put the key inside the door lock present on the driver's side handle and rotate the key to unlock the door.

When the unlock operation is completed reassemble the cap in the following way:

- Insert the cap on the handle aligning the reference marks present on the cap and the handle body.
- Rotate the emergency key in order to misalign the reference marks present on cap and handle body.
- Remove the emergency key.



NOTE:

Always remember to replace the plastic cap on handle.

Doors Lock

The short press of the  button lock the doors. At the same time, switch-off in timed mode the interior courtesy light and performs a double flashing of

direction indicators (if activated from MIA system).

To close all windows, perform a short press and release of the  button, then within 5 seconds press and hold  button.

If one or more doors are open, the doors are locked and this is indicated by a rapid flashing of the direction indicators (where provided). The doors prepare for locking, which is active from the moment they are closed. The doors will unlock again only if the key fob presence is detected inside the passenger compartment.

The driver's door can always be locked by putting the emergency key inside the door lock on the driver's side handle.

Liftgate Open

Press the  button on the key fob twice within five seconds to unlock the liftgate and fully open it.

See chapters "Passive Entry System", "Proximity System" and "Open and Close the Liftgate" in this section for further information.

PANIC Alarm

Press  once to turn the panic alarm on. Wait approximately 3 seconds and press the button a second time to turn the panic alarm off.



Before Starting

Requiring and Setting Additional Key fobs

In order to purchase additional key fob you need to bring with you at an **Authorized Maserati Dealer**:

- all key fobs in your possession;
- a personal ID;
- the identification and registration documents proving ownership of the vehicle.

Setting new key fobs or re-setting the original ones may only be performed at an **Authorized Maserati Dealer**.

NOTE:

The codes of any key fob that are not available when the new setting procedure is carried out will be deleted from the memory to prevent any lost or stolen key fob being used to disarm the electronic alarm system.

Key fob Battery Replacement

NOTE:

A low charge level of the key fob battery will be indicated on the instrument cluster display.

The recommended replaced battery type is a: CR2450.

To replace the battery proceed as follows:

- Remove the emergency key as indicated in "Remove the Emergency

Key from the Key fob" chapter of this section.

- Unclip and remove the lower cover pulling upwards by rotation.



- Separate both parts of the key fob case.



- Remove the battery from its seat and replace with a new recommended type of battery.

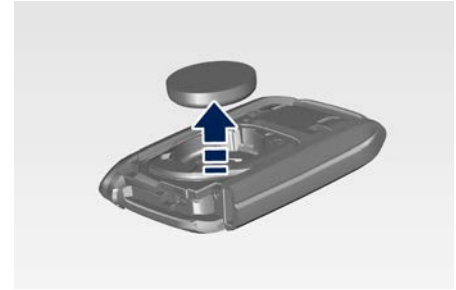

ENVIRONMENTAL!

Batteries contain dangerous materials that could harm the environment. Please dispose of them according to local regulations or at an **Authorized Maserati Dealer**.



WARNING!

- Do not ingest battery, chemical burn hazard. This product contains a coin/button cell battery. If the coin/button is swallowed, it can cause severe internal burns in just 2 hours and can lead to death.
- Keep new and used batteries away from children. If the battery compartment does not close securely, stop using the product and keep it away from children. If you think batteries might have been swallowed



or placed inside any part of the body, seek immediate medical attention.

NOTE:

Avoid touching the new battery with your fingers. Skin oils may cause battery deterioration. If you touch a battery, clean with alcohol.

- Match the + sign on the battery to the + sign on the inside of the battery clip, located on the back cover.
- Assemble the key fob case a click will ensure the succeeded sealing.
- reassemble the emergency key.

If the Key fob Battery is Flat

If the key fob battery is flat, or the key fobs are not detected, is still possible to operate the ignition device using the key fob with discharged battery after placing it inside the rear central tunnel compartment, under the armrest.

Lay the key fob on the indicated spot, respecting the position shown in picture.



NOTE:

The system does not recharge the key fob battery; it must be replaced as indicated in the paragraph "Key fob Battery Replacement".

Remove the Emergency Key from the Key fob

To remove the emergency key from the key fob:

- Pull the valet release button in the arrow direction
- simultaneously remove the emergency key by sliding laterally towards the end of the key fob.



To reassemble the key fob push the emergency key back into the key body till the valet release button returns in his original location.



Wearable Activity Key Content

Maserati provides the user a wearable activity key that emulates the key fob passive entry functions (see "Passive Entry System" in this section).

The device allows to lock and unlock vehicle's door(s) and to turn the ignition device in ON position without having the key fob with you.

The device is wearable with the appropriate strap.





Before Starting

NOTE:

- No buttons or soft-keys are present on the device.
- A low charge level of the wearable activity key battery will be indicated on the instrument cluster display.

NOTE:

It is recommend to not use the wearable activity key on the arm next to the power window.

The wearable activity key is resistant to immersion in water (49 feet (15 m)/1 hour) and can therefore be used for outdoor activities or sports activities in general. Every indication in this manual related to the electronic key is applicable to the wearable activity key, except for the functions related to the presence of the buttons and the battery replacement procedure.



CAUTION!

The wearable activity key must not be used for deep diving or other activities involving contact with highspeed water (such as water skiing, diving, kite surfing, etc.).



CAUTION!

The batteries of the device cannot be changed. Contact an **Authorized Maserati Dealer** to get your activity key replaced.

Radio Frequency RKE Transmitter - Regulatory Information

The "Regulatory Information" for all the radio frequency and radar devices can be consulted by accessing the section "Services" on the website www.maserati.com.

Ignition Device

The ignition device is positioned on the steering wheel left side and is activated by the key fob that must be inside the cockpit.

NOTE:

The ignition device is always visible even if all the other LEDs are switched off. It will blink 5 times after closing the door to signal the point where to switch the vehicle on. It have to be activated with a single, continous push motion covering the whole travel of the button.



**WARNING!**

Do not leave the ignition device in the **ON** position. A child could operate power windows, other controls, or move the vehicle.

**CAUTION!**

It is absolutely forbidden to carry out any after-market operation involving steering system or steering column modifications (e.g. installation of anti-theft device) that could adversely affect performance, invalidate the warranty, cause **SERIOUS SAFETY PROBLEMS** and also result in the car not meeting type-approval requirements.

- If the ignition device has been tampered with (e.g. an attempted theft), have it checked over by an Authorized Maserati Dealer before driving again.

**CAUTION!**

If the ignition device has been tampered with (e.g. an attempted theft), have it checked over by an Authorized Maserati Dealer before driving again.

NOTE:

Before leaving the vehicle, **ALWAYS** engage the parking brake. Activate mode **P** (Park) and press the ignition device to set it to **STOP**. When leaving the vehicle, always lock all the doors by pressing the “Passive Entry” button on the door handle or the  button on the key fob.

Ignition Device States

The ignition device has the following possible states.

STOP: engine off. Some electrical devices (e.g. central door locking system, alarm system, etc.) are still available.

ON: all electrical devices are available. This state can be selected by pressing the ignition device button once, without pressing the brake pedal.

**CAUTION!**

Do not leave the ignition device on the **ON** position for a long time before a long period of inactivity to avoid further discharging of the battery.

With the ignition device switch **ON**, if 30 minutes pass with **P** (Park) mode engaged and the engine stopped, the ignition device will automatically move to the **STOP** position.

With the engine running, it is possible to go away from the vehicle taking the key fob with you. The engine will still be running. The instrument cluster will indicate with a message the absence of the key fob on board.

For more information on the engine start-up, see "Normal Starting of the Engine" in section "Starting and driving".

NOTE:

- do not start the engine immediately after reconnecting the terminals, but press the ignition device, without operating the pedals, to turn on the instrument cluster and then start the engine.
- the  on the instrument cluster will remain on, indicating that the steering must be initialized. To do this, turn the steering wheel from one end to the other and bring it back to the center position within 30 seconds from starting the engine. If any red warning lights on the instrument cluster remain lit, stop the engine, wait for at least 5 seconds and repeat the starting procedure described above.

Shift Ignition Device to STOP Alert

If the ignition device is left in **ON** position, when vehicle is locked the system will turn off the instrument cluster and automatically set ignition device to **STOP** after 30 minutes.



Before Starting

Setting the MIA system (see "Functions of Settings Menu on MIA" in section "Dashboard Instruments and Controls"), radio will remain active for up to 10 minutes after the ignition device is cycled to the **STOP** position. Power window switches and power outlet are not affected by this function.

3

Illuminated Entry/Exit

Lights will turn on and off when you enter/exit the vehicle and operate the buttons on the key fob and/or on the "Passive Entry" system as follows:



lighting, and approach lighting will stay on for a set time (see "Functions of Settings Menu on MIA" in section "Dashboard Instruments and Controls" for further information) (examples in pictures).



- If the unlock command is enabled by pressing the specific  button on the key fob or by the "Passive Entry" system, the "illuminated entry" mode will activate. Courtesy & dimmable internal lighting, night front seats

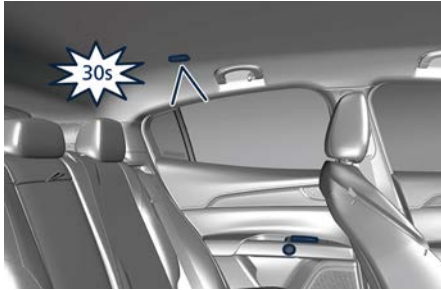



- If the lock command of the car is enabled by pressing the specific  button on the key fob or by the “Passive Entry” system, all the lights will turn off within 3 seconds, if they were previously on and all conditions are met.

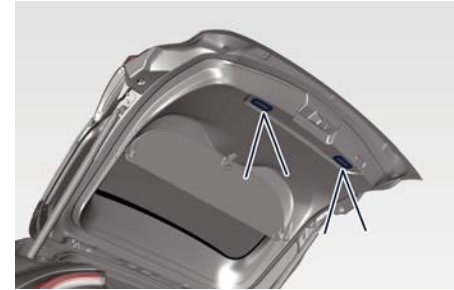

- After activating the liftgate opening command in the possible modes (see “Open and Close the Liftgate” in this section), the inner trunk and liftgate lights will turn on and will stay on for 10

minutes before turning off. The lights will immediately turn off if you lock the liftgate before 10 minutes.



- If the  PANIC button is pressed on the key fob, the panic alarm will turn on. Wait approximately 3 seconds and press the button a second time to turn the panic alarm off.



Vehicle Lighting with Open/Closed Doors

- If one or more doors are open, the central lights, front/rear domelights (main and spot light), the instrument cluster, the MIA display, the Comfort



Before Starting

- Display and all other backlight will turn on and will light up for 30 seconds.
- If the doors are closed, all lights will turn off (within 3 seconds) with the exception of the console display and the ignition device backlighting, which will turn off after 27 seconds.

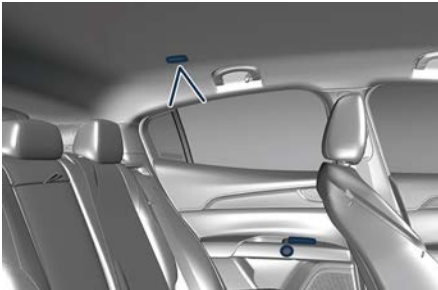
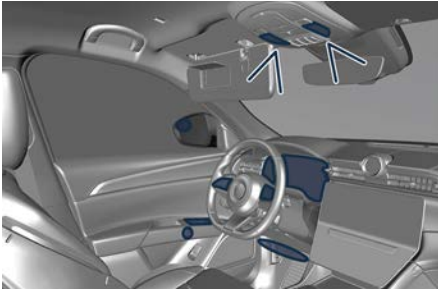

Courtesy Light with Logo

If equipped, a courtesy light with the Maserati logo can be provided on the bottom of the front doors. The

illuminated logo will remain on until the door is closed.

NOTE:

The **Authorized Maserati Dealer** can provide you with any information about the Maserati approved “Courtesy Light with Logo”, available in the “Genuine Accessories” range.

Use of Light Switch for Vehicle Lighting

Vehicle lighting can be operated from the key fob, the “Passive Entry” system and from the lights menu on the Comfort Display. Refer to “External Light Controls” in section “Dashboard Instruments and Controls” where it is indicated which external lights turn on according to the soft-key selection.



Ambient Lights and Backlight Adjustment (☞)

The ambient light and the backlight of the controls and instruments does not depend on the selection of the soft-key on the Comfort Display but on the detection of the ambient brightness made by the RLS solar sensor.

The ambient lighting is adjustable in the same condition which is possible to adjust the backlighting. Enter Ambient menu on the Comfort Display.



Passive Entry System

The “Passive Entry” system is an enhancement to the vehicle’s Remote Keyless Entry (RKE) system. This function allows you to lock and unlock the vehicle’s door(s) without having to press the key fob lock or unlock buttons.

NOTE:

- “Passive Entry” may be programmed to on/off; see “Functions of Settings Menu on MIA” in section “Dashboard Instruments and Controls” for further information.
- If wearing gloves, or if it has been raining on the “Passive Entry” door handle, the unlock sensitivity can be affected, resulting in a slower response time.
- Access to the vehicle using “Passive Entry” system may not work properly in case of interference caused by external sources such as metal objects, mobile phones, overhead power lines, antennas, etc. In these cases, use the buttons of the key fob to open and close the vehicle or the emergency key, inserting it into the driver side door lock.
- The “Passive Entry” system does not lock and unlock the doors directly and immediately but with a slight delay (about 2 seconds).

Unlock Door from the Driver Side

With a valid key fob within 3.3 ft (1 m) of the driver’s door handle, touch the inside part of driver’s door external handle using the hand fingers to unlock the door.



NOTE:

If “1st Press of Key Fob Unlock” is programmed on all doors will unlock when you grip the front driver’s door handle. To select between “Driver Door” and “All Doors”, see “Functions of Settings Menu on MIA” in section “Dashboard Instruments and Controls”.

Unlock Door from the Passenger Side

With a valid key fob within 3.3 ft (1 m) of the passenger door handle, touch the inside part of passenger’s door external handle using the hand fingers to unlock all four doors automatically.

NOTE:

All doors will unlock when you grip the front passenger door handle regardless of the driver’s door unlock preference setting (“Driver Door” or “All Doors”).

Preventing Inadvertent Locking of the Key fob Inside the Vehicle

To minimize the possibility of unintentionally locking a key fob inside your vehicle, the “Passive Entry” system is equipped with an automatic door unlock function which will function if the ignition device is in the **STOP** position. If one of the vehicle doors is open and the door panel switch  is used to lock the vehicle, once all open doors have been closed, the system checks the inside and outside of the vehicle for any valid key fobs.

NOTE:

The vehicle automatically unlocks the doors under any of the following conditions:

- there is a valid key fob inside the vehicle;
- there is not a valid key fob outside the vehicle.



Before Starting

3



NOTE:

The vehicle will not automatically unlock the doors under any of the following conditions:

- the doors are locked using the key fob;
- there is a valid key fob outside the vehicle and within 3.3 ft (1 m) of either "Passive Entry" door handle;
- three attempts are made to lock the doors using the door panel switch and/or the lower  button and then close the doors.

Release the Liftgate and Enter the Trunk

With the key fob within 3.3 ft (1 m) of the liftgate, press the button located between the license plate lights, the liftgate will automatically open until fully home; if the same button is not pressed again to stop it (for more information, see chapter "Open and Close the Liftgate" in this section).

If the vehicle had already been unlocked through key fob or "Passive Entry", the presence of the key fob is not required; simply use the button located between the license plate lights to unlock or to open the power liftgate automatically.

Door Lock from Outside



- With one of the vehicle's key fobs beyond 3.3 ft (1 m) of the driver or passenger front door handles, all four doors will lock.
- Touching the inside part of external driver/passenger door handle using the hand fingers, all four doors will lock.



NOTE:

- You must wait two seconds before all doors will lock.
- The "Passive Entry" system will not operate if the key fob battery is dead.
- If the liftgate has been left open, it will stay open, and the locking function

will only occur after the closing of the liftgate.

The vehicle doors can also be locked by using the key fob lock button  or the lock button  located on the vehicle's inner door panels.





Radio Frequency RKE Transmitter - Regulatory Information

The "Regulatory Information" for all the radio frequency and radar devices can be consulted by accessing the section "Services" on the website www.maserati.com.

Proximity System

The "Proximity" system is an enhancement to the vehicle's Remote Keyless Entry (RKE) system. This function allows you to lock the vehicle's door(s) without having to press the key fob lock and the external handle buttons.

- After three days of inactivity, the Proximity System turns off.
- For periods longer than three days, use the Passive Entry System or the key fob to lock or unlock the car (the wearable key is effective only with the Passive Entry System).

NOTE:

- Access and the key fob detection to the vehicle using "Proximity" system may not work properly in case of interference caused by external sources such as metal objects, mobile phones, overhead power lines, antennas, power chargers, etc. In these cases, use the buttons of the key fob to open and close the vehicle or the emergency key, inserting it into the driver side door lock.
- Parking the vehicle, please storage the key fob at a distance farther than 6,5 yds (6 m) from the car to avoid unintentional and irregular (or not

standard) battery consumption (or battery electrical absorption).

Welcome Lights

This function allows the external lights to switch on when, having your key fob or wearable key, you enter the detection zone.

Walk Away Lock

Walking away from the vehicle, it will be automatically locked once you exit the walk away zone.

NOTE:

- Check by lights animation or by chime signal that the vehicle is locked.
- When a key fob is inside the detection zone, it may happen that the vehicle shows multiple lights animation.
- Deactivate this setting on the MIA screen (see chapter "Functions of Settings Menu on MIA" in section "Dashboard Instruments and Controls") when leaving the car with other people or animals inside to prevent the activation of the alarm system.
- The system inhibits the Walk Away Lock together with the Welcome Lights after three close consecutive triggers of the Walk Away Lock. Use the Passive Entry or a valid key fob to reset these two functions.

(Continued)



Before Starting

(Continued)

- Walk Away Lock works when all doors are closed (trunk lid included).
- Walk Away Lock will not lock the vehicle if the customer with the key fob or wearable leaves the detection area before the trunk lid is completely closed.

NOTE:

Vehicle model, rooftop material, interposition of other vehicles, weather conditions and key fob/wearable key position may interfere with working distances.

Exiting the Car

Open a Door

Each door has a button on the interior panel that unlatch and opens it slightly and a handle that allows the user to open it completely. If the Auto Door Locks has been activated on the MIA screen (see chapter "Functions of Settings Menu on MIA" in section "Dashboard Instruments and Controls"), pressing the button on the interior panel will unlatch all the doors; if the Auto Door Locks is deactivated, pressing the button on the interior panel will unlatch only the door you intend to open; the relative white LED will switch off after pressing the button.

Under certain conditions (battery charge status below 8 V or speed signal failure) if the door is locked, it can be opened pressing three consecutive times the internal or external button on the door within 2 seconds.

NOTE:

Press button three times in 2 seconds to open the door in motion at speeds above 3 mph or 5 km/h (to prevent spontaneous opening of the door while in motion). Otherwise the doors will open only when the vehicle speed is 0 mph pressing the button for the first

time. In this condition the relative white LED will switch off after pressing the button.

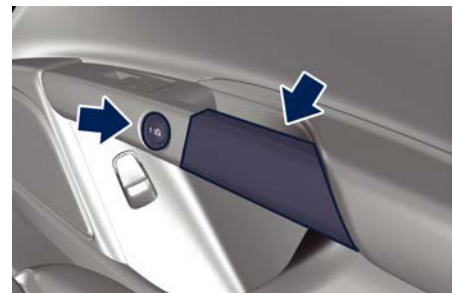
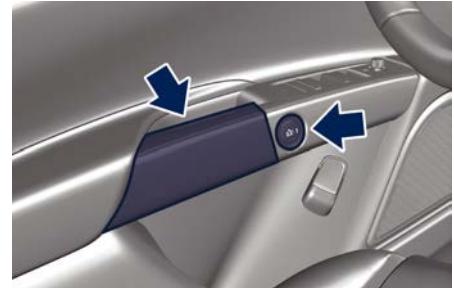

Once unlatched, the door is opened partially and then, with a slight push with the internal handle, automatically rotates outwards.

For details on the manual door emergency opening of the door from the inside, see  "Doors Security Locking" in section "Safety".



Reset

Resetting the door is automatic for a certain number of times after which it must be done manually using the pawl removing the cap and using the key inside the remote control (see paragraph "Remove the Emergency Key from the Key fob" in chapter "Keys" in this section for more details).



Power Windows

The window controls on the driver's door panel govern all the door windows.



There are single window controls on each passenger door trim panel, which operate the corresponding window. The window controls will operate only when the ignition device is **ON** position.

NOTE:

- The power window switches will remain active for up to 10 minutes after the ignition device is turned to the **STOP** position. Opening either front door will cancel this function. The time lapse can be set. See "Functions of Settings Menu on MIA" in section "Dashboard Instruments and Controls" for further information.
- Frequent activations of the power windows could result in a temporary lock of their motors. In this case, wait a moment before a new activation.



WARNING!

Improper use of the power windows and the sunroof (☞) can be dangerous, even with the anti-pinch prevention system. Before and during activation of the power window, always check that the passengers are not exposed to the risk of injury both by the moving window and by personal objects that could be dragged or hit by it. Do not leave unattended children in a vehicle with a key fob inside. When getting out of the vehicle, always remove the key fob to prevent the windows being accidentally activated, posing a risk to passengers remaining onboard.



Before Starting

Auto-Down Function

The driver door power window switch and some model passenger door power window switches have an auto-down function.

Press the window switch to the second detent, release, and the window will go completely down automatically. To open the window part way, press the window switch to the first detent and release it when you want the window to stop. To stop the window from going all the way down during the auto-down operation, pull up on the switch briefly.

Auto-Up Function with Anti-Pinch Protection

Lift the window switch to the second detent, release, and the window will go all the way up automatically.

To stop the window from going all the way up during the auto-up operation, push down on the switch briefly.

To close the window part way, lift the window switch to the first detent and release it when you want the window to stop.

NOTE:

- If the window runs into any obstacle during auto-closure, it will reverse direction and then go back down. Remove the obstacle and use the

window switch again to close the window.

- Any impact due to rough road conditions may trigger the auto reverse function unexpectedly during auto-closure. If this happens, pull the switch lightly to the first detent and hold to close the window manually.
- Frequent activations of the anti-pinch function could disable the auto-down and auto-up function of the windows. In order to re-activate this function proceed with a reset cycle as described in the next paragraph.



WARNING!

There is no anti-pinch protection when the window is almost closed. Be sure to clear all objects from the area before closing the window.

Reset Auto-Up/Down

Should the auto-up/down function stop working, the window probably needs to be reset.



To reset auto-up/down, pull the window switch up to close the window completely.

Open and Close the Windows with Key fob and Ignition STOP



When the ignition device is in STOP position, windows can be opened or

closed by pressing the buttons on the key fob.

Opening:

- press the  button and release it;
- press a second time the  button and keep it pressed until complete opening of the windows, if they were closed.

Closing:

- press the  button and release it;
- press a second time the  button and keep it pressed until complete closure of the windows, if they were open.

Rear Window and Door Lockout Button

For further information, see : "Child-Protection Door Lock System - Rear Doors" in section "Safety".

Wind Buffeting

Wind buffeting can be described as the perception of pressure or a helicopter-type sound. Your vehicle may exhibit wind buffeting with the windows down, or the sunroof () in open or partially open positions. This is a normal occurrence and can be minimized. If the buffeting occurs with the rear windows open, open the front and rear windows together to minimize the buffeting. If the buffeting occurs with the sunroof open, then adjust the sunroof opening to minimize the buffeting.



Power Sunroof with Sunshade

The sunroof and the sunshade are power-controlled and can only be operated with the ignition device in **ON** position.

The sunroof is made of two glass panels: the front one can be moved whereas the rear one is fixed with an electrically operated sunshade. The left switch **(1)** controls the sunroof movement, whereas the right one **(3)** controls the sunshade.

Lifting of the sunroof front panel for venting is controlled by the central switch **(2)** on the front dome console. The sunroof has three preset positions: fully closed; comfort (intermediate opening); fully open.

By opening the sunroof a wind deflector rises automatically in order to deviate the air flow.



WARNING!

- **Improper use of the sunroof can be dangerous, even if it features a finger-trap prevention system. Before and during the sunroof operation, always make sure that passengers are not exposed to the risk of injuries caused by the moving sunroof or by personal objects dragged or hit by the moving sunroof.**
- **In a collision, there is a greater risk of being thrown from the vehicle if the sunroof is open. Always fasten your seat belt properly and make sure all passengers are properly secured too.**
- **Do not allow small children to operate the sunroof. Never insert fingers, other body parts, or any object through the roof opening.**

CAUTION!

- **In the event of rain, always close the sunroof to prevent water infiltrations from staining the fabric/leather upholstery.**
- **Do not open the sunroof if there is ice on it: risk of damage.**
- **Do not open the sunroof in case of presence of any object (bicycle, surfboard or other type of carriers fixed to cross bars) that might interfere with sunroof.**

Slide Opening Sunroof

Opening

Press the **(1)** button: the sunroof will open to the comfort position. A second press will open it fully.

A long press of the same button will open the sunroof until it is released, or if held down, until it reaches the comfort position. Use the button in the same way to open the sunroof fully from that position.

The automatic motion can be interrupted in any position by pressing the **(1)** button again.

If the electric sunshade is closed, the sunroof opening control opens it too.





Before Starting

Closing

From the position of complete opening press the **(1)** button: the sunroof will close completely.

A long press of the same button moves the sunroof until it is released.

The automatic motion can be interrupted in any position by pressing the **(1)** button again.

Venting Sunroof

To bring the sunroof into "vent" position, press and release the **(2)** button.

This type of vent opening can be activated irrespective of the position of the sunroof. When starting with the roof in closed position, pressing the button automatically causes its vent-opening. If the sunroof is already open, pressing the button will open it to the vent position. Press the **(2)** button again during automatic opening or closing to stop movement of the sunroof.

NOTE:

When the sunroof is moved in opened and in vent position, if the sunshade was closed, it will open in an intermediate position.

Sunshade

The sunshade is electrically operated.

The sunshade has three preset positions: fully closed; comfort (intermediate opening); fully open.

Press the **(3)** right switch to open the sunshade. Press the **(3)** button again to close the sunshade.

The automatic motion can be interrupted in any position by pressing the **(3)** button again.

If the sunroof is open, the sunshade closing control will also close the sunroof.

Pinch Protect Function

This function will detect an obstruction in the roof opening during the automatic closure or a constant obstruction of the sunroof front panel. If an obstruction is detected by the safety system during the closing movement, the sunroof front panel will automatically retract. If this occurs, remove the obstruction then press onwards and release the left switch to reactivate the sunroof automatic closure.

NOTE:

• If three consecutive pinch events are experienced, the e-drive will only close manually. The sunroof shall stay in only manual close mode until the panel reaches the flush position or until the ignition device is moved in **STOP** position. After that, the e-drive will re-enable the express close movements.

• Pinch protection is disabled while pressing the switch/es.

Initialization Procedure

Automatic operation of the sunroof must be initialised again in case of faulty sunroof operation.

NOTE:

The pinch protection function is deactivated during the initialisation procedure.

Proceed as follows:

- set the ignition device to **ON** position starting the engine;
- press the **(1)** button to bring the sunroof into completely closed position;
- open the driver side door;
- bring the ignition device into **STOP** position;
- within 5 seconds, set the ignition device to **ON** position starting the engine;
- within 10 seconds hold the **(1)** button pressed; after 10 seconds you will hear the electric motors of the sunroof and sunshade stop in sequence;
- release the button and within 5 seconds, press the **(1)** button and hold it down (until the cycle end): the sunroof will automatically perform a complete open and close cycle including both the sunroof and the sunshade (to indicate that the

initialisation has been successful). If this does not occur, the procedure must be restarted from the beginning;

- check that the re-initialisation operation was successful by checking the “one touch” function of the sunroof and of the sunshade.

Wind Buffeting

Wind buffeting can be described as the perception of pressure or a helicopter-type sound. Your vehicle may exhibit wind buffeting with the windows down, or the sunroof in certain open or partially open positions. This is a normal occurrence and can be minimized. If the buffeting occurs with the rear windows open, then open the front and rear windows together to minimize the buffeting. If the buffeting occurs with the sunroof open, then adjust the sunroof opening to minimize the buffeting.

Ignition STOP Operation

The power sunroof controls will remain active for up to approximately ten minutes after the ignition device is in **STOP** position. Opening either front door will cancel this function. The ignition system timing can be set using the MIA system (see “Functions of Settings Menu on MIA” in section “Dashboard Instruments and Controls”).

Sunroof Maintenance

Use only a nonabrasive cleaner and a soft cloth to clean the glass panel.

Open and Close the Liftgate

Power Liftgate/Hands Free Operation

Automatic opening and closing movement of the power liftgate/Hands Free is driven by electric actuators and a motorized latch ensuring lid locking upon closing.

Power liftgate can be opened or closed from outside pressing twice within five seconds the button  on the key fob. When the button on the key fob is pressed twice, the turn signals flash twice to indicate the opening or closing of the power liftgate.



The  button on key fob does not only allow user to completely open the power liftgate, but also to invert its movement by pressing twice the button again. The power liftgate opening can be also operated from inside the vehicle



Before Starting

pressing the button on front dome console.



When the liftgate is opening, by pressing again the button, it is possible to stop the liftgate at any intermediate position and at this stage two cases are possible:

- by pressing and holding the button the liftgate will open again.
- by pressing one time + pressing and holding the button the liftgate will reverse the motion (closing).

The close operation from button on front dome console requires to press and hold the button. To stop the liftgate at any intermediate position, just stop pressing the button. After the liftgate is stopped in this way, two cases are possible:

- by pressing and holding the button the liftgate will reverse the motion (opening).
- by pressing one time + pressing and holding the button the liftgate will close again.

In addition to these commands, it is possible open and close the power liftgate/Hands free, or stop its movement, by simply moving your foot under the rear bumper, if the vehicle is so equipped with the kick sensor option. In this latter case, the liftgate will be opened and closed only if the “Passive Entry” system acknowledges the presence of the key fob within 1 m (3.3 ft) of the liftgate.

Power liftgate/Hands free uses the button in between the license plate lights, indicated in figure, to activate the opening once the car has been unlocked by the key fob or by the “Passive Entry” function.





By pressing this button when the power liftgate is closed, you can open it completely, or by pressing the button again stop the opening process (after stopping, the liftgate enters in manual mode and can be only moved manually).



While the liftgate is closing, by pressing this button, the liftgate can invert the movement and open it completely. When the power liftgate is open, to move it there are two buttons positioned on the right side of the outer edge of the liftgate as indicated in the figure.





When the liftgate is completely open if you press and release the left button , the power liftgate will be completely closed unless it is stopped;

- if instead the power liftgate is in an intermediate position and you press and release the left button  during the closing or opening stroke, it will be open again;
- if instead the power liftgate is stopped in an intermediate position and you press and release the left button , it will reverse its previous movement and it will be completely opened or closed unless it is stopped again.



In any case, when you press the left button , the doors will not be locked and the alarm system will not be armed. When the liftgate is completely open if you press and release the right button , the power liftgate will be completely closed unless it is stopped;



- if instead the power liftgate is in an intermediate position and you press and release the right button  during the closing or opening stroke, it will be stopped;
- if instead the power liftgate is stopped in an intermediate position and you press and release the right button , it will reverse its previous movement and it will be completely opened or closed unless it is stopped again.

In any case, after the right button  is pressed and the liftgate has reached completely closed position, then the vehicle will be locked and the alarm system will be armed, if a key fob or wearable activity key is detected outside the vehicle.

NOTE:

- The order of the functions shown does not represent the sequence in which they can be performed.
- The buttons of the power liftgate do not work if a gear is engaged or if the

vehicle speed is higher than 0 mph or km/h.

- The power liftgate/Hands free system does not work with temperatures lower than $-22\text{ }^{\circ}\text{F}$ ($-30\text{ }^{\circ}\text{C}$) or higher than $150\text{ }^{\circ}\text{F}$ ($65\text{ }^{\circ}\text{C}$).
- If the opening buttons or the handles are operated while the power liftgate/Hands free is closing, the stroke of liftgate stops. Pressing another time the same command it reverses movement and fully open.
- If the power liftgate finds an obstacle during the same operating cycle without reaching fully closed/open condition, it will stop automatically and must be opened or closed manually.
- If the power liftgate is closing and a gear is engaged, the liftgate will continue closing. In this condition, it is possible that, during the closing stroke, it may find an obstacle and stop.
- Pressing the () button on the right side of the outer edge of the trunk lid, wait the complete closure of the trunk lid to exit the walk away zone to have the function activation. Otherwise, press the () button on the right side of the outer edge of the trunk lid to immediately walk away and to be sure of the vehicle lock (see "Walk Away Lock" paragraph in "Proximity System"

chapter in this section for further information).



WARNING!

If, for any reason, the liftgate must remain open while driving, close all the windows and activate the fan of the air conditioning control at the maximum speed to force the air out of the vehicle to avoid exhaust emission intrusion. Do not activate recirculation.





Close and Lock with Key Fobs inside the Vehicle

If the key fob and the wearable activity key are let inside the car and the  button on the outer edge of the liftgate is pressed to close and lock the vehicle, the system will not lock the car because it will detect them inside the vehicle. If you voluntarily want to leave the key fob and the wearable activity key inside the vehicle, make sure to bring the emergency key with you (see "Remove the Emergency Key from the Key fob" in chapter "Keys" in this section). Repeating three times the liftgate lock procedure, the system will accept the request as voluntary and will lock the vehicle.





Before Starting

NOTE:

- In this case the vehicle can be opened with the emergency key (see "Key fob Operation" in chapter "Keys" in this section) or another key fob or wearable activity key not left in the car.
- Opening the vehicle with the emergency key will activate the alarm (see  "To disarm the System" in chapter "Vehicle Security Alarm" in section "Safety" for further information).
- The key fob left in the car can be rehabilitate with next lock  or unlock .
- The wearable activity key left in the car can be rehabilitate with next lock  or unlock  of another key fob.

Set the Position of Maximum Power Liftgate Opening

The maximum opening position of the liftgate can be modified using the previously described buttons on the right side of the outer edge of the liftgate.

1. Activate the liftgate and stop it in the new maximum opening position to be set, by pressing the left  button.
2. Press the left  or right  buttons and keep it pressed for 3 seconds.

3. Release the button (pressed in the previous point). Upon the following opening controls, the liftgate will stop in the stored position.

If you want to reset the maximum possible opening position of the liftgate, proceed as described below starting from the previously set opening position.

1. Manually push the liftgate to the maximum possible opening position.
2. Repeat the previously performed steps 2 and 3.

Power Liftgate Automatic Safe Movement

Power liftgate safe opening and closing is ensured by a protection system able to stop its movement when an obstacle is detected along the path: when opening or closing, it stops automatically and then slightly moves back.

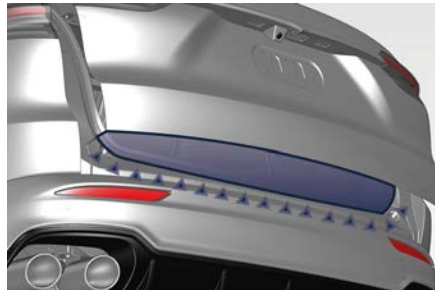

After the closing/opening command, when power liftgate starts closing/opening, all the indicators will blink and a chime will sound to warn anyone within range.

When power liftgate edge reaches the car body, the motor locking the latch is activated automatically.

If necessary, the power liftgate can also be opened or closed manually. This operation could be required when the liftgate remains open for a long period of time.

NOTE:

Frequent activations of the anti-pinch protection function may disable the automatic movement of the liftgate. To reactivate this function, perform a reset cycle by carrying out a complete opening/closing sequence, after manually closing the liftgate.



WARNING!

- Activate power liftgate/Hand free only when vehicle is at a standstill to not obstruct rear visibility.
- Always pay utmost attention when opening and closing the liftgate. If for any reason the protection system might fail to respond, it could cause



injury to anyone within the operating area.

- **After the closing command, always make sure that power liftgate/Hand free is completely closed.**



CAUTION!

- Under extreme weather conditions, liftgate seal could freeze and compromise power liftgate automatic opening and closing.
- Before opening power liftgate, make sure that no objects or snow are set on liftgate or might jam or prevent its opening.

Hands Free Power Liftgate Release and Closing

"Hands Free" mode is controlled by the "Passive Entry" system (see chapter "Passive Entry System" in this section), which automatically releases and closes the power liftgate when the foot is placed in the area under the rear bumper. The system will only operate if the system acknowledges the presence of the key fob within 3.3 ft (1 m) of the power liftgate/Hands free.

The range of the sensors that detect your foot movement extends along and underneath the central portion of the rear bumper.

To activate the power liftgate, stand behind the vehicle, near the liftgate, and move your foot under the bumper as if to kick something. Do not place your foot too close to the bumper or touch the underbody.



WARNING!

- **Pay careful attention to the exhaust tailpipes as they can reach high temperatures and, in case of contact, they can cause severe burns.**
- **When it is not necessary to open the power liftgate with the "Hands Free" mode, make sure the key fob is outside the range of use (3.3 ft/1 m). Otherwise, the power liftgate can be opened accidentally by an unintentional movement of the foot.**



NOTE:

- **During manual or automatic car washing, make sure the key fob is outside the range of use (3.3 ft/1 m).**
- **Installation of trailer tow bar is not compatible with Hand Free sensors. If the car is equipped with Hands Free, remove it before installing the tow bar.**

In order for the sensors to detect your foot movement, move your foot towards the vehicle rather than sideways and immediately pull it back: from this moment, the Hands free will activate the power liftgate within two seconds.

If closed, with the foot movement the Hands free will:

- unlock and completely open the power liftgate;
- after another kick, will stop the power liftgate;
- after another kick, will reverse its movement and completely close unless stopped again.

If open, with the foot movement the Hands free will:

- completely close the power liftgate but not lock the car;
- another kick before the completed closing can stop the movement;
- if the movement was stopped another kick operation will invert a complete opening.



Before Starting

NOTE:

- If your foot movement fails to activate the power liftgate movement through Hands free, wiggling your foot under the bumper will not help. Repeat the whole kick movement.
- In particular situations, external factors affecting the sensor area may trigger the power liftgate release function through Hands free. For example, when washing the vehicle, a water jet aimed at the sensor area may trigger the power liftgate release function through Hands free. Keep the key fob away from the sensing range of the sensors (10 ft/3 m). A key fob located in the front seat passenger area is considered out of range of the Hands free liftgate release sensor.
- If somebody or something knocks against the power liftgate while it is moving using Hands free, the safety system might stop lid opening or closing movement.

Liftgate Emergency Release

If the power release control fails to operate by either the key fob or by pressing the button on the dome console, the vehicle battery could be in a low condition or disconnected. If the doors are still locked, use the emergency mechanical key inserted in the driver's door lock to enter the vehicle and open

the hood. In this condition, it is possible to temporarily power the system by using the battery remote poles located inside the engine compartment (see "Auxiliary Jump-Start Procedure" in section "In an Emergency"). Then it is possible to normally unlock and open the liftgate by using the key fob or the button on the dome console. Have the vehicle subsequently serviced by an **Authorized Maserati Dealer**.

Open and Close the Hood

Opening

- Two latches must be released to open the hood.
- From inside the vehicle, pull the hood release lever located under the left lower side of the dashboard.



- Move to the outside and stand in front of the vehicle front grille.



- Slightly lift the hood and push the safety catch as indicated by the arrow.

The safety catch is located in the center of the hood.



- Lift the hood completely: this operation is facilitated by two gas struts keeping the fully open position.

With the ignition device in **ON** position, the red symbol  will display on the instrument cluster with the message indicating that the hood is open.

Closing

Lower the hood until it begins to drop under its own weight.

When it stops against the lock, press on the hood to close it completely.



CAUTION!

To prevent possible damage, do not slam the hood to close it.



WARNING!

Be sure the hood is fully latched before driving your vehicle. If the lid is not fully latched, it could open when the vehicle is in motion and block your vision. Failure to follow this warning could result in serious injury or death.



WARNING!

Gear shifting is always active and may be performed even when one or more doors, the hood or the liftgate are open. Therefore, in these conditions, take great care to avoid pushing gearshift buttons and so accidentally engage gears.



Before Starting



4 - Dashboard Instruments and Controls

On-Board Instrumentation Overview	84
Responsible Use of Digital Instrumentation	84
Instrument Cluster Overview	85
Instrument Cluster Pop Up Messages	90
Instrument Cluster Settings and Menu Overview	91
Main Menu Contents	92
Quick Actions Contents	97
Widgets Contents	99
Warning and Indicator Lights	104
Maserati Intelligent Assistant™ Operation	114
Functions of My Car Menu on MIA	118
Functions of Electric Vehicle Menu on MIA (EV)	119
Functions of Performance Menu on MIA	120
Functions of Controls Menu on MIA	121
Functions of Settings Menu on MIA	122
Controls on Steering Wheel	133
External Lights Controls	136
Internal Light Controls	139
Wipers and Washers Control	140
Smart Clock	143
Air Conditioning Controls	144



On-Board Instrumentation Overview

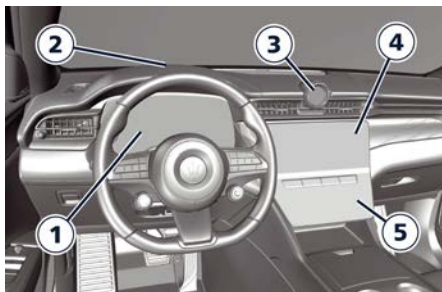

- 1 Instrument cluster (page 85)
- 2 Head Up Display (HUD) (OPT) (page 98)
- 3 Smart clock (page 143)
- 4 MIA display (page 114)
- 5 Comfort display (page 144)

Responsible Use of Digital Instrumentation

Driver Distraction

The vehicle is equipped with feature-rich entertainment and communication systems that enrich the driving experience. These systems may include hands-free mobile phones, multipurpose audio and navigation systems, and also other portable electronic devices. If used improperly, any of these could cause a distraction.

It is the driver's responsibility to do everything possible to ensure his own safety, that of the passengers on board and that of other users sharing the road. Part of this responsibility is to avoid distractions, including driving activities that are not directly related to controlling the vehicle.

A responsible driver should never use these devices or any vehicle features that can distract him from the task of driving safely.



WARNING!

- **Distraction can cause serious accidents.**
- **Never use a mobile phone while driving. Some countries prohibit mobile phone use by a driver while the vehicle is moving.**
- **If the vehicle is in motion, never program radio audio system. Program radio presets only with the vehicle parked. To make radio use simpler and quicker, use the programmed presets.**
- **With active navigator, set and make changes to travel itinerary only when the vehicle is parked.**
- **While the vehicle is moving, never use portable computers or personal digital assistants.**

Operational Safety

The electronic systems that equip the vehicle interact with each other. Their tampering could cause malfunctions in other interconnected systems.

Such malfunctions could seriously endanger the operational safety of the car and that of the occupants.

Even modifications made to the car, if carried out incorrectly, can compromise its operational safety.



Instrument Cluster Overview

The vehicle is equipped with a full digital 12.2 inch instrument cluster with a display with anti-glare and antireflection surface treatment.

The user can interact with the instrument cluster only through the buttons located on the left spoke of the steering wheel (see “Controls on Steering Wheel” in this section).



The layout of the instrument cluster consists of three active sectors. In the lateral ones **A** are only displayed the hard telltales, the central sector is configured with specific screen, depending on the drive mode selector position (see “Drive Mode” in section “Starting and Driving”).

The central sector is divided into 3 macro areas (in the example of picture: Comfort mode in classic layout).

B WIDGET area (quick actions, widgets, etc.).

C MAIN MENU area (speedometer, navigation, stored messages, etc.)

D ADAS area.



4

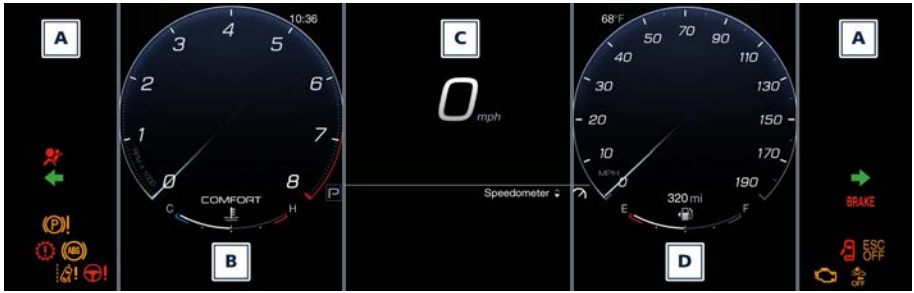

United States Market



Canadian Market

U.S. Federal Regulations requires that upon transfer of vehicle ownership, the seller certify to the purchaser the correct mileage that the vehicle has been driven. If your odometer needs to be repaired or serviced, the repair technician should leave the odometer reading the same as it was before the repair or service. This repair should be performed by an Authorized Maserati Dealer. The odometer setting should be maintained following the repair or service. Keep a record of the odometer mileage before any repair or service to ensure that the odometer is properly reset.

Central Sector Layout

The central sector is divided into many micro areas depending of the four cluster visualizations. The presence of some areas depends on the type of equipment and the target market.

The different layout of the central sector are rendered in the following list and pictures.



Areas List

The following list is valid for all drive mode layouts: some items may only be present in some layouts.

- 1** Main Screen
- 2a** Tachometer dial
- 2b** Speedometer dial
- 3a** Customizable widget
- 3b** ADAS widget
- 4** Digital Speedometer
- 5** Current gear indicator light
- 6** Drive mode
- 7a** Dynamic bar of engine coolant temperature
- 7b** Dynamic bar of fuel economy
- 8a.3** Parking lights indicator light
- 8a.4** Low beams, auto low beams, high beams and auto high beams indicator lights
- 8b.1** Red warning lights rolling area
- 8b.2** Amber warning lights rolling area
- 8b.3** TPMS indicator warning light
- 8b.4** Front Seat belt reminder warning light
- 8c** Drowsy Driver Detection system activation light
- 8e** Active Lane Management deactivation light
- 8f** Forward collision warning light
- 8h** Active HOLD indicator light (displayed only at a standstill)
- 8ss** Start and Stop indicator light
- 9** Information bar
- 10a** Left reconfigurable area
- 10b** Right reconfigurable area
- 10t** Chronometer Feedback
- 11** Cruise Control (CC), Adaptive Cruise Control (ACC) and Speed Limiter (SL) function status
- 12** Traffic Sign Assist indicator light
- 15** Title Area
- 15b** Main screen icons
- 16** Shift light



Dashboard Instruments and Controls

- 17 Lifter indicator light
- 19 Suspensions indicator light
- 20 Launch control indicator light

NOTE:

For the description of the contents that can be displayed on the instrument cluster, see “Instrument Cluster Settings and Menu Overview” in this section.

4

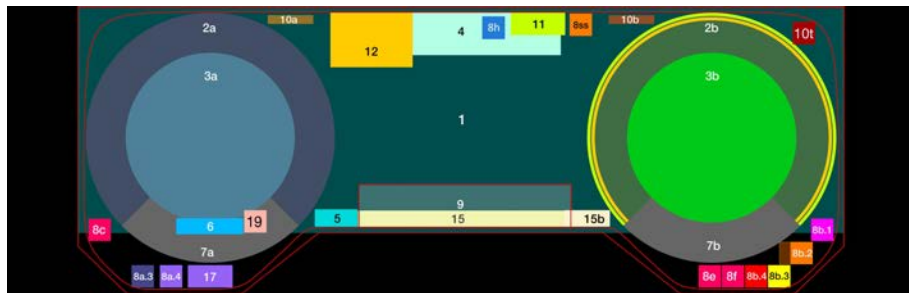

Classic Layout

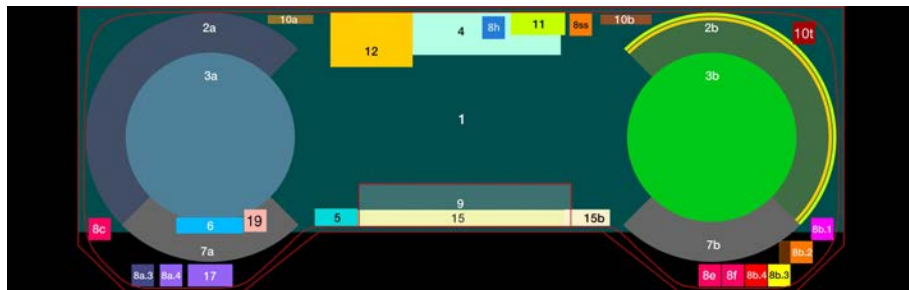

Evolved Layout

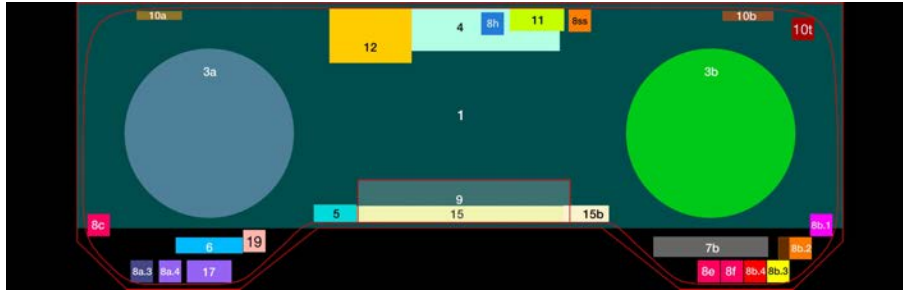

Relaxed Layout

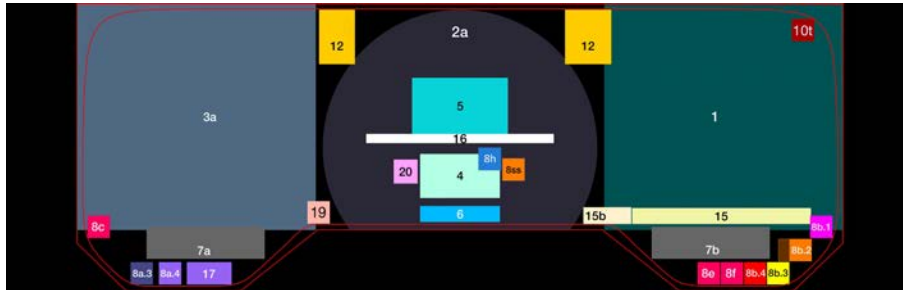

CORSA Layout

NOTE:

Classic, Evolved and Relaxed Layout can be selected by the Quick Actions Menu (see chapter "Quick Actions Contents" in this section). Corsa layout is only available selecting Corsa Drive Mode with the selector on the steering wheel (see chapter "Drive Mode" in section "Starting and Driving").



Instrument Cluster Pop Up Messages

Pop up position on instrument cluster

For every digital cluster visualization, pop ups are always displayed on the widget area, in the left part of the instrument cluster.

The display background may change according to the type of pop up message displayed:

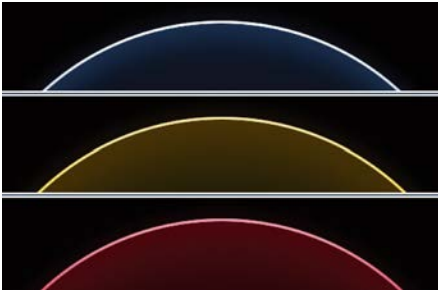

- No color: no telltale related message.
- Yellow color: amber telltale related message.
- Red color: red telltale related message.

Pop up Messages

This message type is displayed until the condition that activated the message is cleared or pressing any key on the left steering wheel spoke.

Pop up Messages with Ignition Device in ON

This message type is displayed until the ignition device is in **ON** position. An example of this message type is the one shown in picture.

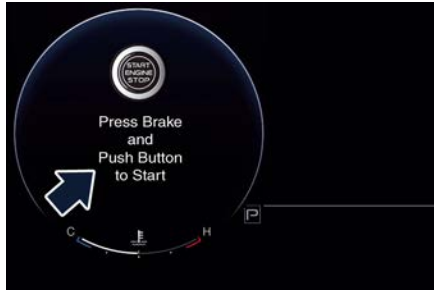

Navigation Messages

When the navigation pop-up is enabled on the MIA screen it will be displayed in the widget area, in the left part of the cluster display, while changing direction or approaching a turning point. The navigation pop-up will be displayed outside the navigation main screen.

While approaching the turn, further pop ups will be displayed starting at 328 ft (100 m) from the turning point and the countdown to 0 miles/meters.



While getting closer to a turn, the sections referred to the distance already traveled will switch off while the ones referred to the distance yet to be traveled will remain on.

NOTE:

The distance indicated above the road name is expressed in the unit of measure set by the user.



Instrument Cluster Settings and Menu Overview

Setting Controls

Operate the controls on the left side of the steering wheel to scroll the main menu (A), the Quick Actions menu (B) and widgets (C).

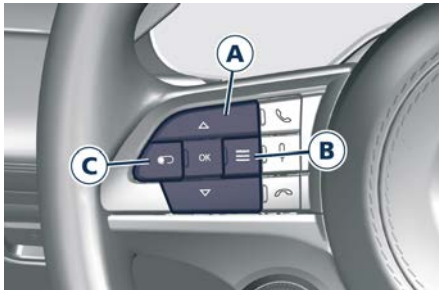

Press and release the \triangle or ∇ to scroll upwards and downwards the main menu titles.

The screen area in sector 1 (main area) will be updated after the selection of the title with graphical up/down arrow in sector 2 (main menu title).

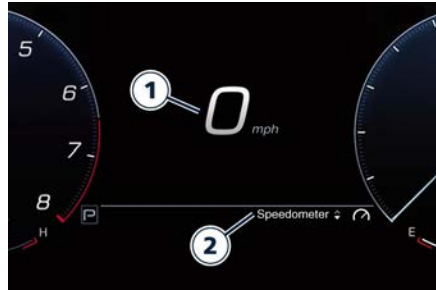

Press OK, the main menu title will disappear and a contextual action will be displayed in sector 2 for about 15 seconds to help the user understand what is the available action.



To enter the Quick Actions Menu, click the \equiv button.

An overview of the submenus is displayed in the left dial on the instrument cluster.

Scroll the different submenus with the \triangle or ∇ button, choosing one of them with OK.

It is possible to exit Quick Actions Menu by pressing the \equiv , the widget or the phone down button.



To enter Widgets Menu, click the \odot button.

An overview of the submenus is displayed with a number of timed-out dots, that correspond to the number of available widgets, in the left dial of the instrument cluster.

The number of widgets can be set from the MIA display.

The element with different color represents the current page.

Click the \odot button again to scroll all selectable widgets.



- Time and Weather
- Blank (no-widget)
- Other widget can be enabled from the MIA Display (See “Functions of Settings Menu on MIA” in this section).
- Current Consumption
- Trip A/B
- Torque Management
- Tire Pressure
- Hybrid Info (2.0 L4 MHEV only)

Widget cycles maintains last position after switching off the vehicle.

Main Menu Overview

- 1 Speedometer
- 2 Navigation
- 3 Performance
- 4 Driver Assist (if foreseen)
- 5 Stored Messages
- 6 Trip A
- 7 Trip B (Disabled by default. It is possible to enable it from MIA Display. See “Functions of Settings Menu on MIA” in this section).

Quick Actions Overview

- 1 Recent Calls
- 2 Cluster Layout
- 3 Head Up Display (HUD) (OPT)

Widget Overview

- Media/Radio
- G-Meter
- Compass

Main Menu Contents

1. SPEEDOMETER

Press and release the Δ or ∇ button until this menu item is displayed. Pressing the OK button the unit of measure will toggle between mph or km/h.



2. NAVIGATION

Press and release the Δ or ∇ button until this menu item is displayed. Pressing the OK button you can enter in zoom modality: short press Δ or ∇ arrows to zoom in or out step by step or long press the same buttons to continuously zoom in or out. Press OK again to exit zoom modality. This mode does not persist at next key cycle. Zoom levels and views are independent among cluster and MIA display, but map and instructions are all synchronized even with HUD.



Above the map the NIP (Next Instruction Panel) is displayed. It is composed by:

1. Turn arrow
2. Distance to next turn
3. Road number
4. Exit number
5. Towards Name
6. Lanes (only if present)



NOTE:

- Using Apple Carplay™ or Android Auto™, the native map is not available

on the instrument cluster. A pop-up message will inform the user that the map is available only on MIA display.

- If the map has not loaded yet on MIA display, a loading screen will be displayed on the instrument cluster. After 30 seconds an error loading map message will appear.

3. PERFORMANCE

Press and release the \triangle or ∇

button until this menu item is displayed. Performance page contents automatically changes according to the selected drive mode.

- In Comfort Drive Mode, Current and Average Consumption are displayed. Instantaneous value of the last 20 minutes trip, according to currently selected unit of measurement, is visualized both in numbers and with a bar graph. In the first minute of trip, numbers are substituted by dashes. Values can be reset with a long press of the OK button on the steering wheel, when visualizing the Consumption History bar graph.



- In GT Drive Mode, Consumption History is displayed. This screen is composed by a consumption bar graph and an instantaneous consumption bar (vertical) on the right. The consumption trend is visualized with many samples from right to left, each sample is a column; the closest column to instantaneous consumption always represents the most recent value and is filled with a lighter color than the other columns. The horizontal amber line represents the average consumption.



Dashboard Instruments and Controls



- In Sport Drive Mode, sport gauges (Brake, Power and Oil Temperature) are displayed. Brake and Power gauges represent the current position of brake and gas pedal and they are expressed in 0-100 % scale. The engine oil temperature is white colored if in normal operating ranges; it becomes red and is shown with a pop-up message if it is too high.



- In Corsa Drive Mode, sport gauges (Torque, Turbo and Oil Pressure) are

displayed. Instantaneous turbo boost pressure (Turbo) and engine torque (Torque) are represented in white bars. The engine oil pressure is white colored if in normal operating ranges; it becomes red and is shown with a pop-up message if it is too low.

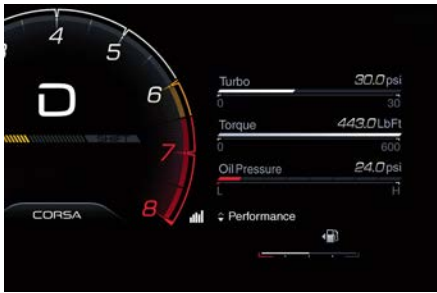

- In Sport and Corsa Drive Mode, pressing the OK button on the steering wheel, the Lap Time menu is displayed. The user can scroll the list and choose the lap recording type (no sector, two sector, three sector) or the lap history.



At the same time, when in lap time menu, the chrono content overlaps the current smart clock theme with the following visualization:



In the recording page, the timer starts pressing OK. According to the number of sector chosen, pressing OK when the timer is already started, the system records an intermediate time. Holding the OK button, the timer stops. Last Time and Best time are always displayed in the submenus.



At the same time, when in recording page, the chrono content overlaps the current smart clock theme with the following visualization:



When the time recording is active, a specific chronometer icon is displayed on the instrument cluster.



Every time a lap/sector time is taken the relative time gap is shown in overlay on the Smart Clock. Gap value is calculated comparing the time taken when a sector/lap is completed with the sector/lap of the best lap time of the session. Gap is not shown during first lap. Gap information is colored in green when the time is lower/better, in red when is higher/worst.

NOTE:

When the numerical Gap value is shown on the smart clock, the label “T1”, “T2” or flag-icon is shown to indicate to what the Gap is referred to.



Also the progress bars in the recording page follow the same coloring system of the smart clock gap. Holding the OK button again, if at least one lap has been recorded, the user can chose to resume to continue his session or watch the session history.





4

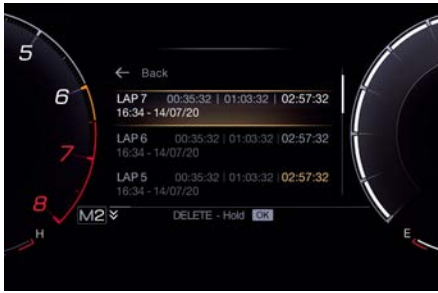

- In Off-Road Drive Mode, Pitch and Roll angle are displayed (if equipped with air suspension). When the car starts to pitch/roll, there will be a continuous filling on the cluster indicator for every degree, both clockwise and counterclockwise. The degrees value shall be positive moving the car on the screen clockwise and negative counter-clockwise. The pitch value moves to -35° to 35° and the roll value up to 25° ; each graphic step value is 15° .

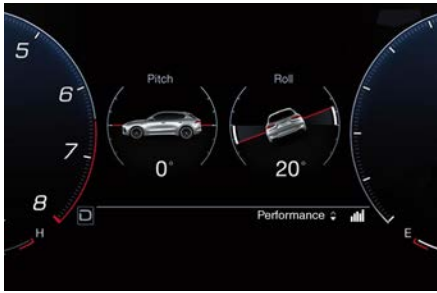

4. DRIVER ASSIST (if foreseen)

Press and release the Δ or ∇ button until this menu item is displayed. Driver Assist page displays the current status of ACC, BSA, Active Lane Management and Active Driving Assist if these functions are available on the vehicle. ADA can be visualized into the speed dial or in the main menu screen.

NOTE:

Active Driving Assist is not visualized when Corsa Drive Mode is selected. For further information see also “Driver Assistance Systems” section in this manual.



5. STORED MESSAGES

Press and release the Δ or ∇ button until this menu item is displayed. Press the OK button on the steering wheel to enter the scroll mode as visualized on the screen. Scroll among messages with Δ or ∇ arrows; a vertical pagination is displayed with a number of dots that corresponds to the messages contained in the menu. To exit the scroll mode, press OK again.





6-7. TRIP A / TRIP B (when active)

Press and release the \triangle or ∇ button until this menu item is displayed.

Trip displays data of user's voyage. Trip A format is identical to Trip B except for the fact that Trip A is set as default, Trip B not (It is possible to enable it from MIA Display. See "Functions of Settings Menu on MIA" in this section). The trip area displays the following parameters:

1. Total odometer
2. Trip distance (*)
3. Trip timer (*)
4. Average trip consumption (*)

(*) These values can be reset holding the OK button on steering wheel.

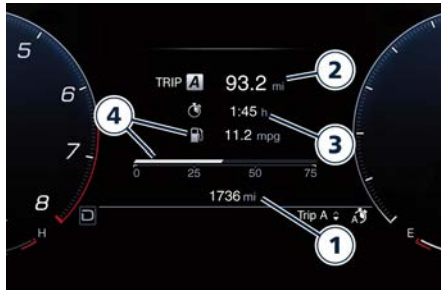

Quick Actions Contents

1. RECENT CALLS

Press and release the \triangle or ∇ button until this menu item is displayed.

Pressing the OK button a list should appear presented in chronological order with latest call as first, regardless of the call category.

NOTE:

- In case no recent call are present, the first element of the list is filled with a "No recent calls" message.
- In case no phone is connected, the first element of the list is grayed and filled with a "No phone connected" message.

During multiphone connection, information available in cluster depends on phone priority defined on MIA display; favorite phone information will be displayed. "Phone name" will be also displayed below Recent call.

In Recent Calls list, the entries should start with an icon showing the call type (incoming, outgoing or missed), followed by the CID (Caller ID): contact name, "private number - unknown" or phone number (if contact name unavailable). On the second line is displayed the time or the date of the call.

NOTE:

- Missed calls should display "Missed Call" message before the time.
- Private calls will not have pressable areas on line items because user cannot call back the unknown number.



NOTE:

- If the user selects a recent call, the call shall start without further confirmation.
- If the user access Quick Actions menu when a call is active, Recent Calls menu item is grayed.

2. CLUSTER LAYOUT

Press and release the \triangle or ∇ button until this menu item is displayed. Cluster layout allows the user to reconfigure the elements on the screen according to 3 different layouts:

- Classic
- Evolved
- Relaxed



3. HEAD UP DISPLAY (HUD) (OPT)

Press and release the \triangle or ∇ button until this menu item is displayed. Head Up Display can be activated ON/OFF (both from Quick Actions menu and MIA display). The Head Up is a type of display that allows driver to see instrument panel data projected onto the windshield without taking their eyes off the road which helps to reduce the risk of distracted driving.



There are three HUD layouts that can be selected only from MIA Display:

- Standard: Digital speed, Traffic Sign recognition and simplified map (with next instruction panel if the navigation is on) are displayed.
- Simple: Digital speed and Traffic Sign recognition are displayed.



- Advanced: Digital speed, Traffic Sign recognition and simplified map (with next instruction panel if the navigation is on) and ADAS widget are displayed. A fourth layout, not selectable on the MIA screen, is only available in "Corsa" drive mode:
- Corsa: Shift light, digital speed and Corsa RPM are displayed.



Simplified map is actually a simplified, less detailed version of the map that can be displayed at the same time on the Digital Cluster and on the MIA display. All the information displayed in the HUD display is not in a mutually exclusive relationship with the information displayed in the Digital Cluster. Therefore, when a function is displayed in the HUD display as well as in the Digital Cluster, it shall be persistent on both sides, except for voluntary action of removal by the user.

NOTE:

- The brightness of the Head Up Display (HUD) automatically changes with the environmental conditions.
- Otherwise brightness and height of the Head Up Display (HUD) can be set on the MIA display (see chapter "Functions of Settings Menu on MIA" in this section).



Widgets Contents

MEDIA

Media widget displays Android Auto™, Apple Carplay™ and Amazon Alexa™ devices connected via Bluetooth or USB. Screen titles will follow these priorities:

- Album Art
- Source
- Artist (if available)
- Song name



The screen will be updated at the start of each new song; available information will depend on the song. Buttons on the rear of the steering wheel are effective on Media. If the selected widget is different from the Media/Radio widget, no feedback is provided when the user changes track / station.

(Continued)

Adas contents

ADAS contents displayed on the Head Up Display are:

- Forward Collision Warning (car and pedestrian warning)
- Intersection Collision Assist
- Traffic Sign Recognition
- Active Driving Assist and ACC/CC
- Active Lane Management / Lane Departure Warning

ADAS visualization on HUD shall follow the same visualization of the Driver Assist Screen or the ADAS widget.

When a function is displayed in the HUD it shall remain visible in the Cluster display as well. HUD shall display also visual warning for braking event phase and for hands not detected on the steering wheel.



Valid for ADA and ALM



Valid for ADA



NOTE:

- When the source is "unknown" or not defined, a dedicated icon will be displayed in the applicable rows.
- If pieces of information are missing, "unknown" will be displayed for those items.
- If audio is muted, all info is hidden and the dedicated "Music Muted" icon is shown.

When no external device is connected, Media widget is replaced by the Radio one which displays FM or AM radio information following these priorities:

FM:

- Station Name (or frequency)
- Artist (or whatever information is displayed in the radio in place of it)
- Song name (or whatever information is displayed in the radio in place of it)

AM:

- Frequency



Buttons on the rear of the steering wheel are effective on Media. If the selected widget is different from the Media/Radio widget, no feedback is provided when the user changes track / station.

NOTE:

If audio is muted, all info is hidden and the dedicated "Music Muted" icon is shown.

G-METER

G-Meter content shows the acceleration with the vertical and horizontal values.

G-Meter are shown in two different layout:

- Base layout for GT, Off-Road- Comfort and Sport drive mode
- Corsa layout for CORSA drive mode

The G-Meter widget contains the following information:

- Halo (current real time acceleration)
- Peak Values (at four sides, shown only when the lateral acceleration overcomes the threshold value)
- Outermost ring (blinking feedback)

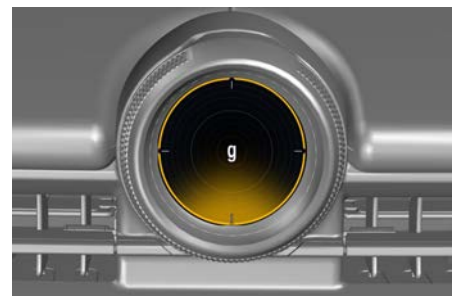

Filling of the halo is related to the real time acceleration value and it fills from the center to the edge in the direction of the acceleration.

The max peak value is updated in real time with the highest value received, when the acceleration overcomes the threshold value, and it is shown on the screen for a timeout. Max peak value can be replaced by a new peak value if the acceleration overcomes the last peak value in the same direction. More than



one peak value can be displayed at the same time.

Only in CORSA drive mode it is present a graphical arc notch inside the circle for each of the four peaks direction. Every arc notch has to move (from center to the edge) following the relative peak numerical value. The arc notch should appear if the value is above the threshold and disappears if timeout expires and the value is below the threshold.

When the peak visualization timeout expires and the acceleration is below the threshold:

- In Comfort, GT, Sport and Off Road the values textbox should be blank.
- In CORSA drive mode the values textbox shall show "0.00" and the relative arc notch should disappear.

When the acceleration end-scale is reached the outermost ring will blink.



NOTE:

When the internal signal is equal to 0 or Fail status, the G-meter visualization shall be as the acceleration equals to 0 condition (no digits) and no colored halo/notch shall be shown. For the base layout the peak values shall be not shown; In CORSA mode, with CORSA layout, has to be shown dashes instead of digits.

COMPASS

The compass widget contains the compass pictogram and cardinal coordinates. The whole graphic shall be rotated based on the rotation angle.



NOTE:

If the compass is not available, the area displays dashes "—".

TIME and WEATHER

Time and Weather widget contains the following informations:

- Time: the time value will be XX (hours information): XX (minutes information); 12h or 24h format are selectable on MIA display.
- Date: the date value will be XX/XX/XX. In setting on MIA display user can choose one of the three identified menus: DD/MM/YY - MM/DD/YY or YY/MM/DD. The format on the cluster display must be aligned with the one on MIA display.
- External Temperature: the temperature value will be XX.X ° when it is displayed in Celsius format, no decimals are foreseen when the temperature is expressed in Fahrenheit format (XX°)



BLANK (no-widget)

No graphical item is displayed in the left dial on the instrument cluster.

No matter how many enabled widgets are, the blank position is always the last.

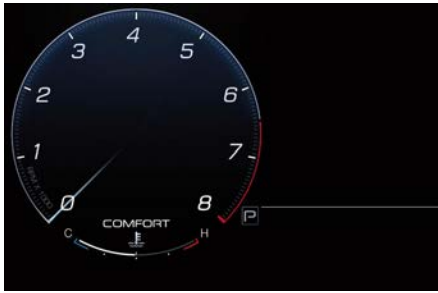

CURRENT CONSUMPTION

Consumption instantaneous value, according to currently selected unit of measurement, is visualized both in numbers and with a bar graph. The average value, based on Trip A, can be substituted by dashes "--" after a reset or if data are not available.



When speed is equal to 0 mph or km/h or when the gas pedal is not pressed or if the signal is not available, the gauge is empty and the instantaneous

value is represented as dashes "--". Exceeding the maximum scale limit, the instantaneous numerical value shall be at least the upper limit of the scale.

TRIP A / TRIP B (when active)

Trip displays data of user's voyage. Trip A format is identical to Trip B except for the fact that Trip A is set as default, Trip B not (It is possible to enable it from MIA Display. See "Functions of Settings Menu on MIA" in this section). The trip area displays the following parameters:

- Trip A or Trip B label
- Trip distance
- Trip timer
- Average trip consumption



NOTE:

- Distance, elapsed time, average consumption and average speed can be reset only on Main Menu Screen. After a reset, or if the signal is not

available, the value of the related items should be replaced with a dash "-" for each digit, except for the elapsed time that will restart from 00:00.

- Cluster displays "--" in place of value for Average Trip consumption and Trip Distance if cluster does not receive signal.

TORQUE MANAGEMENT

Instantaneous engine torque is represented by the filling of the gauge near each wheel. If the signal is not available the graphic is greyed out. The widget shall have 50% of torque on the front axle (25% for each wheel) and 100% on rear axle (50% maximum for each rear wheel) as a maximum value. The arrows shall follow the current Torque value (example: if torque is 0, no arrow is shown).





TIRE PRESSURE

Tire Pressure page shows the current inflation of each tire. The units of measurement will be converted coherently with the current settings (see "Functions of Settings Menu on MIA" in this chapter). The car graphics will vary according to the model and version. If a warning on a tire is present, the corresponding tire will be yellow highlighted with the current underinflated pressure value.



HYBRID INFO (2.0 L4 MHEV only)

This submenu screen shows the following parameters in the form of symbol and dynamic bars related to the functionality of the hybrid system:

- **Regenerative braking ("Charge" label):** the energy recuperation bar fills linearly counterclockwise in green from right to left when charging and unfill from left

to right when the charge recovery is not present.

- **State of Charge of 48 V battery (represented with a battery symbol):** the 48 V battery charge level is represented by the filling in green of the symbol from the bottom to the top and viceversa, following the behaviour of Charge and eBoost/eAssist parameters. It is very important to avoid completely discharging the 48 V battery. If the state of charge shown in the "Hybrid Info" screen is below 50%, if possible avoid stopping the engine and drive the car for a while to allow the BSG to recharge the 48 V battery, at least up to 50%. If the car has to remain stationary for a long time, proceed as indicated in the chapter "Vehicle Stored for Long Periods" in section "Maintenance and Care".
- **Energy boost obtained from the BSG ("eBoost" label):** The eBoost bar is the sum of eBoost (electric compressor) and eAssist (Belt Start Generator) contributes. The bar fills linearly clockwise in green from left to right and unfill viceversa if boost is not requested.



- **System failure state:** In this state the "Charge" and "eBoost" bars are empty, the related labels become grey and a generic fail warning light is displayed inside of the battery symbol. In addition to that, dedicated fail messages and symbols will be displayed in the dedicated area (see "Warning and Indicator Lights" in this section).
- **Missing Message / SNA state:** In this state the battery indicator, "Charge" and "eBoost" bars are empty and the related labels become grey. In addition to that, dedicated fail messages and symbols will be displayed in the dedicated area (see "Warning and Indicator Lights" in this section).



Warning and Indicator Lights

Hard Telltales

Following telltales are displayed on the lateral sectors of the instrument cluster.

Airbag Warning Light



This warning light will illuminate for a few seconds for a bulb check when the ignition device is in **ON**. If the light does not illuminate while starting the engine, stays lit, or switches on while driving, have the system checked at an **Authorized Maserati Dealer** as soon as possible.

For further information,  : chapter "Supplemental Restraint System (SRS) - Airbags" in section "Safety".



WARNING!

If the warning light does not come on when starting the engine, stays on or comes on when driving, the airbags may not be working properly, therefore have the system checked by an Authorized Maserati Dealer as soon as possible.

Transmission Failure Warning Light



This warning light illuminates in red, together with a buzzer warning, to indicate that the transmission is faulty. In this case, stop

the vehicle and contact an **Authorized Maserati Dealer**.

Electric Power Steering Failure Warning Light



This warning light illuminates when the electric power steering is not operating and needs service.

If the warning light is on, steering assistance may be not available.

NOTE:

After battery disconnection event, the warning light may be on. In this case, start the engine and perform a steering wheel stroke end to end to switch off the warning light. If the problem persists, contact an Authorized Maserati Dealer.

Brake Warning Light



This warning light monitors various brake functions, including brake fluid level and parking brake engagement.



If the brake warning light illuminates the parking brake may be engaged, the brake fluid level may be low or a problem

with the anti-lock brake system (ABS) reservoir may have occurred.

In all the above situations, a related message will be displayed.

If the warning light still illuminates when the parking brake has been disengaged,

and the fluid level is at the full mark on the master cylinder reservoir, there could be a brake hydraulic system malfunction or a problem with the brake booster detected by the ABS/ESC system. If this occurs, the warning light will remain lit until the problem has been solved. If the problem concerns the brake booster, the ABS pump will run when engaging the brake and a brake pedal pulsation may be felt during each stop of the vehicle.

Inefficiency of one of the dual brake system cycle is indicated by the brake indicator light, which will turn on when the brake fluid level in the master cylinder has dropped below a certain level.

The warning light will remain lit until the problem has been solved. If the brake warning light flashes for 10 seconds with the electric parking brake warning light and the related message on, an EPB system failure has occurred. If a brake failure occurs, visit an **Authorized Maserati Dealer** as soon as possible in order to check up the brake system. In the event of an Electronic Brake Force Distribution (EBD) failure, both the brake warning light and the ABS light illuminate. Immediate repair of the ABS system is required.



Functioning of the brake warning light can be checked by turning the ignition device from **STOP** to **ON** position.

The warning light should illuminate for approximately 2 seconds.

The warning light should switch off unless the parking brake is engaged or a brake fault is detected. If the warning light does not illuminate, have the light system overhauled by an **Authorized Maserati Dealer**.

The warning light will also switch on when the parking brake is engaged with the ignition device in **ON** position. This light only indicates the brake is engaged but not the clamping force of the parking brake to the wheels.



WARNING!

Driving a vehicle with the red brake light on can be very dangerous. Part of the brake system may have failed, resulting in increased braking distances and the risk of an accident. Have the braking system checked as soon as possible at an Authorized Maserati Dealer.

Door Ajar Indicator Light



This indicator light illuminates on when one or more doors are ajar or not properly closed. When one or more doors are open, a related message will be displayed if the vehicle

is running at a speed of 5 mph (8 km/h) or faster.

Electric Parking Brake Failure Warning Light



This warning light and related message illuminate when there is an EPB system failure. The failure could also completely or partially block the vehicle because the parking brake could remain on even after it has been automatically or manually disengaged though its controls.

If it is still possible to use the vehicle (parking brake not engaged) drive to the nearest **Authorized Maserati Dealer** and remember to perform each operation/command during which the electric parking brake does not work.

NOTE:

If the car is parked on slopes greater than 27% and/or the braking system is overheated, when the parking brake is engaged, the warning light will turn on to signal a condition which may not be safe

Anti-Lock Braking System (ABS) Malfunction Warning Light



This warning light, and its related message, indicate possible malfunctions of the Anti-Lock Brake System (ABS).

The warning light will turn on when the ignition device is in **ON** position and

may stay on for 4 seconds. If the ABS warning light remains lit or turns on while driving, the Anti-Lock portion of the brake system is not functioning and requires service. However, the conventional brake system will continue to operate normally if the **BRAKE** (US market) or  (CDN market) warning light is switched off. If the ABS warning light turns on while driving, or if it does not switch on when the ignition device is in **ON** position, please visit as soon as possible an **Authorized Maserati Dealer** in order to restore the Anti-Lock brakes functions.

Active Lane Management (ALM) Fault



This warning light on indicates that the ALM system is in fault. If the warning light and the relevant message do not go off after a few maneuvers and eventually an ignition cycle, contact an **Authorized Maserati Dealer**.

Electronic Stability Control (ESC) Activation/Malfunction Indicator Light



The ESC activation/malfunction indicator light on the instrument cluster will display when the ignition device is in **ON** position. It should switch off by starting the engine.



Dashboard Instruments and Controls

If the light stays on with the engine running, there is a malfunction in the ESC system.

If the light still stays on after several ignition cycles, and the vehicle has been driven for several miles at more than 30 mph (48 km/h) speed, visit an **Authorized Maserati Dealer** as soon as possible to have the problem diagnosed and restored.

NOTE:

Each time the ignition device is in **ON**:

- The ESC OFF indicator light and the ESC activation/malfunction indicator light illuminates temporarily.
- The ESC system will be on, even if it was turned off previously. The ESC system will make buzzing or clicking sounds when active. This is normal; the sounds will stop when ESC becomes inactive by solving the problem that caused the ESC activation.

Electronic Stability Control (ESC) OFF Indicator Light

 This indicator notifies that the Electronic Stability Control (ESC) is disabled; the linked message will be displayed.

Malfunction Indicator Light (MIL)

 The Malfunction Indicator Light (MIL) is part of an onboard diagnostic system that monitors

engine and transmission control systems.

Under normal conditions, this indicator light should switch on when the ignition device is in **ON** position and switch off after the engine is started (the MIL does not shut off immediately).

This is a sign of the indicator light working properly. If the indicator remains lighted up or switches on while driving, there is a failure in the fuel supply/ignition and emission control systems.

The failure could cause high exhaust emissions, loss of performance, poor vehicle handling and high consumption levels.

Should this occur, proceed with caution to your **Authorized Maserati Dealer** without heavy throttle application or driving at high speeds. Obey all applicable local traffic regulations. The indicator light will go out if the problem is no longer present. The error will be registered by the system in any case.



CAUTION!

- When the ignition device is in the **ON** position and if the indicator light does not switch on or if it switches on while driving, contact an **Authorized Maserati Dealer** as soon as possible.
- Prolonged driving with the MIL on could cause damage to the engine control system. It also could affect fuel economy and drivability. If the MIL is flashing, severe catalytic converter damage and power loss may occur. Immediate service is required.

Forward Collision Warning (FCW) Off



This warning light informs the driver that FCW is disabled. This might occur when front sensor and/or the ACC/FCW system sensors are malfunctioning and need cleaning or servicing and when ACC/FCW system is not available due to a system error (for further details, refer to “Adaptive Cruise Control - ACC” in section “Driver Assistance Systems”). This warning light will light even when the activation of another driver assistance function disables the FCW.

Left Direction Indicator Light



This indicator lights up when the left direction indicators or the hazard lights are turned on.

The indicator light will flash at the same frequency of the direction indicators and is controlled by the left multifunction lever.

If the indicator flashes at a fast rate, check for a defective exterior light LED.

Right Direction Indicator Light



This indicator lights up when the right direction indicators or the hazard lights are switched on.

The indicator light will flash at the same frequency of the turn indicators and is controlled by the left multifunction lever behind the steering wheel.

If the indicator flashes at a fast rate, check for a defective exterior light LED.

Soft Telltales

Following telltales are displayed in the central sector of the instrument cluster.

Charging System Warning Light



This warning light shows the status of the electrical charging system. If the light stays on or comes on while driving, turn off some of the vehicle's non-essential electrical devices or increase engine speed (if at idle). If the charging system warning light remains on, it means that the vehicle is experiencing a problem with the charging system. Require IMMEDIATE service at an **Authorized Maserati Dealer**. If jump starting is

required, refer to "Auxiliary Jump Start Procedure" in section "In an Emergency".

SOS Call Battery Failure Warning Light



This warning light shows the status of the SOS Battery System. If the charging system warning light remains on, it means that the vehicle is experiencing a problem with the charging system. Require service at an **Authorized Maserati Dealer**.

Engine Coolant Temperature Warning Light



This warning light notifies when the coolant temperature is too high and the engine is overheated. If the coolant temperature reaches critical levels, this warning light will illuminate combined with the related message on display. When the coolant temperature is reaching the set threshold an acoustic signal will be heard. If the warning light switches on while driving, safely pull over and stop the vehicle. If the A/C system is on, turn it off. Also, shift the transmission into N (Neutral) and idle the vehicle. If the coolant temperature does not return to normal, immediately turn the engine off and contact an **Authorized Maserati Dealer**. Check "Engine Overheating" in section "In an Emergency" for more information.

Low Oil Pressure Warning Light



Under normal conditions, the warning light illuminates when the ignition device is turned on and goes off as soon as the engine is started.

If the warning light stays or turns on while driving, the engine oil pressure is too low. The warning light is combined with a displayed message and an acoustic signal that will last 4 minutes. In this case, turn the engine off immediately and carry out the necessary checks.

Do not operate the vehicle until the problem has been solved. This warning light does not indicate the oil level. If the problem persists, contact an **Authorized Maserati Dealer**.

Engine Oil Temperature Warning Light



This warning light indicates that the engine oil is overheated. The warning light is combined with the related displayed message. In this case, drive carefully until the temperature drops back to normal level and the warning light indicator turns off. If the problem persists, contact an **Authorized Maserati Dealer**.

Overfilling of Engine Oil Warning Light



This warning light and the related displayed message, indicate a too high engine oil level. In this case engine oil level must



be checked and reported to the correct level. Contact an **Authorized Maserati Dealer** to perform this operation.

Airbag Warning Light



This warning light will illuminate for a few seconds for a bulb check when the ignition device is in **ON**. If the light does not illuminate while starting the engine, stays lit, or switches on while driving, have the system checked at an **Authorized Maserati Dealer** as soon as possible.

For further information, : chapter "Supplemental Restraint System (SRS) - Airbags" in section "Safety".



WARNING!

If the warning light does not come on when starting the engine, stays on or comes on when driving, the airbags may not be working properly, therefore have the system checked by an Authorized Maserati Dealer as soon as possible.

Seat Belt Reminder Indicator Light



When the ignition device is in **ON**, the seat belt reminder indicator light will light up for a few seconds as a bulb check.

During the bulb check, you will hear an acoustic signal if one or both seat belts are unbuckled.

After the bulb check or while driving, with the passenger seated, if driver

or passenger seat belt is unbuckled, together with the acoustic signal the seat belt reminder light will light up.



WARNING!

Maserati urges you to use the seat belts correctly fastened and adjusted at all times. Correct use of the seat belts can help reduce the risk of serious injury in the event of an accident. Do not pass seat belts over sharp edges: they could tear. Do not pin anything to the seat belts. This could reduce their initial strength and cause them to tear in the event of a crash.

For further information, : chapter "Occupants Restraint Systems (ORS)" in section "Safety".

Traffic Sign Assist (TSA) Indicator Lights



Speed limit unconditioned signs (in example: 80 mph), limiting condition acknowledged (in



example: snow), conditioned speed limit signs and overtaking ban are displayed when the TSA function is active.

For further information, see "Traffic Sign Assist - TSA" in section "Driver Assistance Systems".

Door Failure Warning Light



This warning light report a failure of the electric opening of the doors by the e-latch button. In this case use the manual door emergency handle as described in : paragraph "Door opening form inside-discharged battery" in chapter "Doors Security Locking" in section "Safety". Contact an **Authorized Maserati Dealer** as soon as possible.

Electronic Throttle Control (ETC)

Indicator Light



This indicator light indicates a failure of the Electronic Throttle Control (ETC) system. If the indicator turns on while driving (a torque decrease is possible), have the system checked by an **Authorized Maserati Dealer**.

When detecting a failure, the light indicator will illuminate while the engine is running.

If the indicator remains lit with the engine running, you can still drive your vehicle. However, contact an **Authorized Maserati Dealer** as soon as possible.

If the indicator is flashing while the engine is running, immediate service is required. You may experience reduced performance, an elevated/rough idle or engine stall and your vehicle may require towing.



Brake Disk Temperature Warning Light



This warning light illuminates in the case of brake discs overheating. In this case, avoid heavy use of brake system until the warning light goes off.

Brake Pads Wear Warning Light



This warning light and the related message indicate that the brake pads have reached their wear limit.



US Please contact an **Authorized Maserati Dealer** to have them replaced.

CDN

Drowsy Driver Detection (DDD) System Activation



The symbol appears, together with a message on the display, in case of activation of the DDD (Drowsy Driver Detection) system. Stop to pause while driving, pulling the car over in safe conditions.

Keyless Start System Failure



This warning light illuminates to signal a failure of the keyless start system.

Verify correct activation of engine start button (press STOP and START again), if problem persists, contact an **Authorized Maserati Dealer** as soon as possible.

Hybrid System Failure Warning Light (2.0 L4 MHEV only)



The hybrid system is unavailable or temporarily unavailable and may have function restrictions.

In these cases, contact an **Authorized Maserati Dealer** as soon as possible.

eBooster Failure (2.0 L4 MHEV only)



The hybrid system is unavailable or temporarily unavailable and may have function restrictions on eBooster due to a malfunction.

This warning light illuminates to indicate that the eBooster is not available. In these cases, contact an **Authorized Maserati Dealer** as soon as possible.

Tire Pressure Monitoring Light



This warning light is connected to the Tire Pressure Monitoring System (TPMS).

Under normal conditions, the warning light should illuminate when the ignition device is in **ON** and should go off as soon as the engine is started. If the warning light remains lit or illuminates while driving, the pressure of one or more tires is too low and a message will be displayed. The TPMS malfunction warning light is connected to the low tire pressure monitoring light.

When the system detects a malfunction, the monitoring light and the related

message will flash for approximately one minute and then remain lit.

This sequence will continue upon subsequent vehicle start-ups as long as the malfunction lasts.

When the malfunction warning light lights up, the system may not be able to detect or signal low tire pressure correctly.

For further information,  chapter "Tire Pressure Monitoring System (TPMS)" in section "Safety".

Electronic Differential (e-DIFF) Fault

 This warning light indicates a fault on the electronic differential.

Contact an **Authorized Maserati Dealer** as soon as possible.

Transmission Overheating Warning Light



This warning light and the related message indicate that the transmission fluid temperature is rising.

If this warning light turns on, safely pull over and stop the vehicle. Then, move the transmission into P (Park) mode and run the engine at idle until the temperature drops and the light switches off. If the problem persists, contact an **Authorized Maserati Dealer**.



CAUTION!

Continuous driving with the transmission temperature warning light illuminated will eventually cause severe transmission damage or failure.

Low Fuel Indicator Light



When the fuel level reaches approximately 3.75 Gallons (14.2 liters) this indicator light at the end of the fuel economy dynamic bar, normally white, will turn on in amber, and remain on until fuel is added together with the related message. Refer to "Refueling" in section "Starting and Driving" for fuel filling.

Ice Hazard Indicator Light



When the external temperature falls below 38°F (3°C), the temperature value blinks for a few seconds, the warning light turns on, a message is displayed and an acoustic signal is triggered to warn the driver of the risk of icy roadbed. Under such conditions, drive carefully and slow down as the grip of the tires may be significantly reduced. The warning light flashes for 5 seconds and switches off when the temperature reaches 43°F (6°C) or higher.

Rain Sensor Failure Warning Light



This warning light illuminates in the case of failure of the automatic windscreen wiper.

Contact an **Authorized Maserati Dealer** as soon as possible.

Park Sensors Failure Warning Light



This warning light illuminates in the case of failure of one or more park sensor. Contact an

Authorized Maserati Dealer as soon as possible.

Twilight Sensors Failure Warning Light



This warning light illuminates in the case of failure of the twilight sensor. Turn on the lights manually and contact an

Authorized Maserati Dealer as soon as possible. **Immobilizer and Antitheft System Warning Light**



This warning light monitors various functions of the immobilizer and antitheft systems. The pop-up message in the instrument cluster will indicate for which of these functions the warning light has come on.

The warning light can appear:

- to report a failure of the engine immobilizer system. In this case contact an **Authorized Maserati Dealer** as soon as possible.
- when the ignition device is moved to **ON** position, to indicate a possible

break-in attempt detected by the alarm system.

- when the engine is started and the key fob is not recognized by the system.
- to report an antitheft system failure.

Fuel Filler Cap Open Warning Light



After refueling the car performs a check of the fuel filler cap and this warning light comes on if it is not correctly closed, after approximately 10 minutes also depending on driving conditions. See "Refueling" in section "Starting and Driving" for more details.



CAUTION!

Do not drive with this warning light on. Check that the fuel filler cap is tightened correctly.

Oil Level Sensor Fault



This warning light illuminates to signal a failure of the sensor that detects the engine oil level.

Contact an **Authorized Maserati Dealer** as soon as possible.

Exterior Lights Failure Warning Light



This warning light illuminates to indicate a failure on the following lights: position/DRL lights, parking lights, direction indicators, rear fog light, reversing light and brake lights. The failure may be caused by a blown bulb/LED, a blown protection fuse or an



interruption of the electrical connection. Contact an **Authorized Maserati Dealer** to replace the bulb/LED or the relevant fuse.

Headlight Aiming System Failure Warning Light



This warning light, and the related message, indicate a failure of the automatic aiming of the headlight system. Please contact an **Authorized Maserati Dealer** to check the system.

Advanced Frontlighting System (AFS) Failure Warning Light



This warning light and the related message light up to report a failure of the AFS system.

Contact the **Authorized Maserati Dealer** as soon as possible.

Automatic High Beam Failure Warning Light



This warning light and the related message light up to report a failure of the automatic high beam headlights.

Contact an **Authorized Maserati Dealer** as soon as possible.

Trailer Connection Fault Warning Light



The warning light and the relevant message are displayed to indicate a fault or failure of the connection between vehicle and trailer. In these cases please contact an

Authorized Maserati Dealer as soon as possible, and avoid using the vehicle with a trailer.

Suspension System Failure Warning Light



This warning light illuminates to report a failure of the suspension system. Contact an **Authorized Maserati Dealer** as soon as possible.

Windshield Wiper Failure Warning Light



This warning light illuminates to indicate a windshield wiper failure. Contact an **Authorized Maserati Dealer** as soon as possible to have the failure eliminated.

Windshield Washer Low Fluid Indicator Light



This indicator light will illuminate for 5 seconds to indicate a low level of the windshield and headlights washer fluid. A related message will be displayed. See “Maintenance Procedures” in section “Maintenance and Care” for fluid filling.

AWD Failure Warning Light



This warning light turns on to indicate a fault of the AWD system otherwise a fault or overheating due to excessive wheel spin. Contact an **Authorized Maserati Dealer** as soon as possible, and avoid using the vehicle in heavy duty conditions.

Temporary AWD Failure Warning Light



The symbol will appear to indicate that the AWD dynamic control system is temporarily deactivated to prevent damage because of high engine load. The traction system will work in RWD mode in this case. Until the symbol appears on the display, reduce the load to allow the system to cool down. The AWD system will resume normal operation when the symbol disappears from the display.

Drowsy Driver Detection (DDD) Failure Warning Light



The symbol comes on in the event of a DDD (Drowsy Driver Detection) system failure. In these cases, contact an **Authorized Maserati Dealer** as soon as possible.

Suspension Lifter System Failure Warning Light



This warning light illuminates to indicate a failure of the Suspension Lifter system. In this case, avoid using the system and contact an **Authorized Maserati Dealer** as soon as possible to have the failure eliminated.

Suspension Lifter System Failure Warning Light due to payload



This warning light illuminates to indicate a excessive payload on the suspension lifter system. In



this case lighten the vehicle to get the warning light switched off.

Forward Collision Warning (FCW) and Pedestrian Emergency Braking (PEB) Fault

 This warning light informs that FCW and/or PEB is in fault state and the autonomous braking may not be available. If this occurred together with other specific messages, could mean that a system fault requiring servicing at an **Authorized Maserati Dealer**.

It is nevertheless possible to drive the vehicle without using this function (for further details, refer to “Forward Collision Warning - FCW” in section “Driver Assistance Systems”).

Active Driving Assist (ADA) Fail

 This warning light will turn on to indicate a failure of the ADA system.

Contact an **Authorized Maserati Dealer** as soon as possible avoiding using this system.

Speed Limiter (SL) Failure Warning Light

 This warning light illuminates when SL system is not operating or needs servicing.

Contact an **Authorized Maserati Dealer** as soon as possible avoiding to use this system.

Cruise Control (CC) Fault

 This warning light turns on when CC is not operating or needs servicing, For further details, refer to “Cruise Control - CC” in section “Driver Assistance Systems”.

Adaptive Cruise Control (ACC) Fault

 This warning light turns on when ACC is not operating or needs servicing, For further details, refer to “Adaptive Cruise Control - ACC” in section “Driver Assistance Systems”.

Traffic Sign Assist (TSA) Off

 This indicator light illuminates when the Traffic Sign Assist (TSA) is turned off. For further details, see “Traffic Sign Assist (TSA)” in section “Driver Assistance Systems”.

Traffic Sign Assist (TSA) Fail

 This warning light turns on when TSA is not operating or needs servicing. For further details, see “Traffic Sign Assist (TSA)” in section “Driver Assistance Systems”.

Auto Vehicle Hold Fail

 This warning light illuminates to indicate a failure of the Auto Vehicle Hold Function. Contact an **Authorized Maserati Dealer** to have the system checked. See chapter "Brake and Stability Control Systems" in section "Understanding the Vehicle" for further information.

Start&Stop Failure Warning Light

 This warning light illuminates when there is a failure in the Start&Stop system. Switch the engine on or off using the normal procedure with the ignition device **START/STOP** and have the vehicle checked at an **Authorized Maserati Dealer**.

Start&Stop Active Indicator Light

 This indicator light indicates that the engine has been switched off automatically by the Start&Stop system.

When the engine starts again, this indicator light will switch off. See chapter “Automatic Start&Stop System” in section “Starting and Driving” for further information.

Auto Vehicle Hold Indicator Light

 The indicator light indicates that the auto vehicle hold function is active. See chapter "Brake and Stability Control Systems" in section "Understanding the Vehicle" for further information.

Speed Limiter (SL) Indicator Light

 This white or green indicator light will illuminate when the SL function is on, or set and in driver override (with green set speed below) or temporarily canceled (with white set speed below). For further information, check



“Speed Limiter - SL” in section “Driver Assistance Systems”.

Cruise Control (CC) Set



This green indicator light will illuminate with the set speed when the CC is set and in driver override. For further information, check “Cruise Control - CC” in section “Driver Assistance Systems”.

Adaptive Cruise Control (ACC) Set



This green indicator light with below the set speed turns on when the ACC is set (for further details, refer to “Adaptive Cruise Control - ACC” in section “Driver Assistance Systems”) and vehicle will keep set speed.

Intelligent Speed Assist (ISA) Set



This green indicator light will illuminate with the set speed when the ISA is set and in driver override. For further information, check “Intelligent Speed Assist - ISA” in chapter “Traffic Sign Assist - TSA” in section “Driver Assistance Systems”.

Hill Descent Control (HDC) Set



This green indicator light with below the set speed turns on when the HDC is set. For further details, refer to “Hill Descent Control - HDC” in section “Driver Assistance Systems”.

Low Beams On Indicator Light



This indicator light will illuminate when the low beams headlights are turned on in manual or in automatic mode.



For further details, see “External Lights Controls” in this section.

Headlight On Indicator Light



This indicator light will illuminate when the position/DRL lights or headlights are turned on.

For further details, see “External Lights Controls” in this section.

Auto Low Beams On Indicator Light OFF



This indicator light will illuminate when the automatic low beams headlights are turned off. For further details, see “External Lights Controls” in this section.

Auto High Beams On Indicator Light OFF



This indicator light will illuminate when the automatic high beams headlights are turned off. For further details, see “External Lights Controls” in this section.

Hill Descent Control (HDC) Ready



This white indicator light turns on to indicate that HDC is ready to be set and, once it sets, to turn it off temporarily. For further details, refer to “Hill Descent Control - HDC” in section “Driver Assistance Systems”.

Active Lane Management (ALM) OFF



This indicator light will illuminate when the Active Lane Management (ALM) is turned off. For further details, see “Active Lane Management (ALM)” in section “Driver Assistance Systems”.

Cruise Control (CC) Ready or Canceled



This white indicator light will illuminate when the CC is ready to be set (with 3 dashes below) and, once it sets, when it is temporarily canceled (set speed in white below). For further information, check “Cruise Control - CC” in section “Driver Assistance Systems”.

Adaptive Cruise Control (ACC) Ready or Canceled



This white indicator light indicates that the ACC is ready to be set (with 3 dashes below) and, once it sets, when it is temporarily canceled (set speed in white below). For further details, refer to “Adaptive Cruise Control - ACC” in section “Driver Assistance Systems”.

Start&Stop Disable Indicator Light



This indicator light illuminates when Start&Stop system is not available in the conditions described in “Start&Stop Function Disabling” of the “Automatic Start&Stop System” chapter, or the system is turned off through the controls on the right side



of the steering wheel or through the relevant soft-key on MIA. See chapter “Automatic Start&Stop System” of section “Starting and Driving” for further information.

Sport Suspension Setting Indicator Light



This indicator light displays which suspensions setting (sport "S") is on. For further details, refer to “Drive Mode” in section “Starting and Driving”.

Hard Suspension Setting Indicator Light



This indicator light displays which suspensions setting (hard "H") is on. For further details, refer to “Drive Mode” in section “Starting and Driving”.

Ride Height Indicator Light



Ride height set through the control on central console is always displayed in the specific area on the LH side of the cluster display. From the “Normal” level ride height can be lowered at “Aero 1” or “Aero 2” levels when using vehicle on the road. When using the vehicle off road, ride height can be set to a higher position thanks to “Off Road 1” or “Off Road 2” levels. For further details, refer to “Setting Ride Height” and “Off-road Drive” in section “Starting and Driving”.

Gear Shift Indicator Light



This indicator lights up to indicate gear shift change in order to optimize fuel consumption.



See “Automatic Transmission” in section “Starting and Driving” for further information.

Performance “Launch Control” Running Indicator Light



This indicator lights up when the car is launched in the “Launch Control” performance start procedure.

See chapter “Launch Control Mode” in section “Starting and Driving” for the activation procedure.

High Beam Indicator Light



This indicator lights up when the high beams are switched on or when blinking. For further details, see “External Lights Controls” in this section.

Auto High Beam Indicator Light ON



This indicator lights up when the automatic high beams are switched on. For further details, see “External Lights Controls” in this section.

Maserati Intelligent Assistant™ Operation

General Notes

The vehicle is equipped with the infotainment Maserati Intelligent Assistant™ (MIA) system, an advanced user interface which combines innovative and exclusive technical functions integrating entertainment, user settings, navigation and communication functions within a single system. The MIA system features an audio system which is acoustically optimized for this specific vehicle.

All entertainment and communication functions are described in a specific guide called “Maserati Intelligent Assistant™ (MIA)”. This guide also includes all warnings and precautions, which are essential for a safe use of the MIA system. Maserati advises you to read this guide carefully and thoroughly.

Manual Controls and Devices

The MIA display is positioned in the central part of the dashboard and the manual controls and devices for multimedia navigation and to connect external sources are positioned on the central console.

This manual controls are a further interface for the driver and nearby



passenger, that adds to the MIA display soft-keys. Using the manual controls, the MIA display will work as a graphic display of the inputs from the controls.

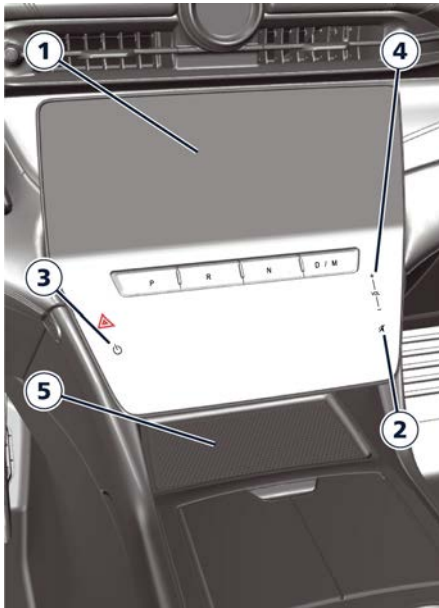

1 MIA touch display

The touch screen soft-keys allows to access to all available functions. When you touch an active area of the screen a visual feedback of active area's is linked to the touch event. It is valid for all active areas with or without long touch functionality. This

feedback associated to the touching state highlight the icon or text label and apply an additional graphic shape. This strategy is valid for all the active areas of the display (soft-keys, main category bar, etc...) except the lists, the status bar and the draggable areas.

To select a list item touch and release the screen.

2 "MUTE" capacitive touch button

Press this capacitive touch button to mute the volume of the active sources.

3 "ON/OFF" capacitive touch button

Press this capacitive touch button to turn the MIA system on or off.

4 "VOLUME" control

Independently from currently shown MIA screen, touch "+" capacitive touch button to increase the volume, and "-" to decrease it or slide the bar.

When the volume control is adjusted through the "VOLUME" capacitive touch buttons or the steering wheel control, a volume alert pop up will appear at the top of MIA screen. Volume alert shows the icon of the active source, and the volume level bar with numerical value. Touching the drop down arrow on the right side of the volume alert to view and possibly change the volume level of the other sources (Media, Phone, Phone Ring, Navigation and Voice Recognition).

The volume control pop up can be closed touching anywhere outside of the pop up or touching the "X" softkey on the upper right side, otherwise it will close automatically with a 5 seconds time out after last touch.



5 Wireless Charger (OPT)

The Wireless Charger allows you to recharge your mobile phone (if it supports this technology) without having to connect it to the charging port through a cable (see "Internal Equipment" in section "Understanding the Vehicle").

6 Multimedia Ports

For further details, refer to "Internal Equipment" in section "Understanding the Vehicle".

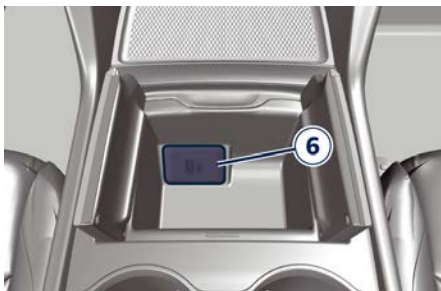

Main Status Bar on MIA Display

Main status bar is set up by Maserati: some of soft-keys that make up the bar can be customized according to personal requirements, as explained in "Customizing Main Status and Category Bar" in this chapter.

The composition of the main status bar is briefly indicated below. For further information, refer to the "Maserati Intelligent Assistant™ (MIA)" guide included in the on board documentation.

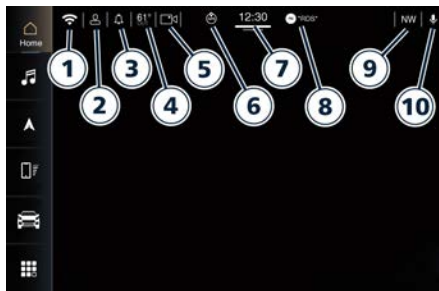

- 1 Wi-Fi Hotspot () (customizable).
- 2 Profiles (customizable).
- 3 Notifications (customizable).
- 4 Outside Temperature (customizable).
- 5 Rear View Camera (customizable).
- 6 Geolocation.
- 7 Clock.
- 8 Status Alert Box.
- 9 Compass (customizable).
- 10 Passenger Voice Recognition - VR (customizable).

NOTE:

The images may represent a main status bar other than the one on your MIA.

Main Category Bar on MIA Display

The soft keys located on the left part of the MIA display represent the default main categories, which are briefly indicated below. The figure shows the

main menu bar of a car equipped with navigator.



Main category bar is set up by Maserati: user can reorganize its menus according to personal requirements, as explained in "Customising the Main Status and Category Bar" in this chapter.

To view the label of the soft-keys in the main category bar it is necessary to activate the "Show Main Category Labels" function in the "Display" submenu of the "Settings" screen of the "Vehicle" page.

NOTE:

The images may represent a main category bar other than the one on your MIA.

For further information on the "Home", "Media", "Nav", "Vehicle", "Phone" and "Apps", refer to the "Maserati Intelligent Assistant™ (MIA)" guide included in the onboard documentation.



Touch one of these soft-keys to access the list of functions that the user can set.

- 1 **" Home "** soft-key
Touch this soft-key to enter the home page from which you can choose among all the available widgets the one to display the desired function.
- 2 **" Media "** soft-key
Touch this soft-key to access media sources such as: Radio, USB device, and Bluetooth as long as the requested media is present.
- 3 **" Nav "** soft-key (if equipped)
Touch this soft-key to access the Navigation function.
- 4 **" Phone "** soft-key
Touch this soft-key to access the MIA Phone function that can be set or monitored via MIA.
- 5 **" Vehicle "** soft-key
Touch this soft-key to access the "My Car", "Electric Vehicle" (), "Performance", "Controls" and "Settings" menu from which to choose which the customer programmable functions of some driver assistance system (ADAS) to set up. Functions can be selected and adjusted or turned on/off by touching the related soft-key (see "Functions of Controls Menu on MIA" in this section).

- 6 **" Apps "** soft-key
Touch this soft-key to have access to the Apps page from which you can choose which app you want to display between "Favorites", "Recent", "Categories" and "All".

Switch Off Touch Screen Backlight

If the screen backlight becomes annoying when driving, it is possible to switch it off pressing  ON/OFF capacitive touch button described in the "Manual Controls and Devices" of this chapter (the audio will be switched off too).

The MIA touch screen can be turned off by touching the "Screen Off" soft-key in the "Controls" menu of the "Vehicle" page.

Touch screen Display Warnings



CAUTION!

- Do NOT attach any object to the touch screen, doing so can result in damage to the touch screen.
- Do not press the screen with any hard or sharp objects (pen, USB stick, jewelry, etc.) which could scratch the touch screen surface.
- Do not spray any liquid or caustic chemicals directly on the screen. Use a

clean and dry micro fiber lens cleaning cloth in order to clean the touch screen.

- If necessary, use a lint-free cloth dampened with a cleaning solution, such as isopropyl alcohol, or an isopropyl alcohol and water solution ratio of 50:50. Be sure to follow the solvent manufacturer's precautions and directions.

Customising the Main Status and Category Bar

The soft-keys for the main functions of the MIA system, indicated on the left of the MIA display, and some of those on the main status bar can be easily customized to suit user's requirements, as follows:

- drag and drop the soft-key to move it inside the bar;
- drag and drop the icon corresponding to the selected function until it overlaps the one to be replaced.



Functions of My Car Menu on MIA

The MIA system uses a combination of keys able to access to the information about the vehicle present in the "My Car" menu of the "Vehicle" screen page. A shortcut to set this menu is available in the "Apps" screen page.

Once you enter the "My Car" screen using the touch soft-keys, read information about the vehicle.

Touch the function soft-key to confirm the selection.

NOTE:

Only one touch screen area/soft-key may be selected at a time.

In this mode the MIA system allows you to access the following submenus displayed on the left side of the screen page: Overview, Oil Level, Tire Pressure and Drive Mode Explorer. On the right side is shown a summary of the vehicle status.

Overview

Touching this soft-key, the "My Car" Overview page shows a summary of the vehicle status:

- A Service table with miles and days to the "Next Service";
- An overview of the vehicle with information on wheels. A (!) symbol

will appear next to a wheel highlighted in yellow in case of warning.

- An overview of the vehicle with information on oil level. A symbol will appear on top of the engine highlighted in red in case of warning.

NOTE:

- Touching the (!) symbol, the page will jump on the Tire Pressure page.
- Touching the symbol, the page will jump on the Oil Level page.



NOTE:

- If no tire warning are detected, no (!) symbol will be shown.
- If no oil level warning are detected, no symbol will be shown.
- In case one of the systems is not available or in fail, the corresponding status indication will be substituted by dashes.

Tire Pressure

Touching this soft-key, the "My Car" Tire Pressure page shows the current inflation of each tire.

The units of measurement will be converted coherently with the current settings (see "Functions of Settings Menu on MIA" in this chapter).

The car graphics will vary according to the model and version.

If a warning on a tire is present, the corresponding tire will be yellow highlighted with the current underinflated pressure value.

If a warning on a tire is present, a information button will appear on the Tires pressure page. Pushing on this button, a pop-up will be shown on the cluster display.

Oil Level

Touching this soft-key, "My Car" Oil Level page shows the current oil level.

Follow the instruction on the screen to have an updated reading. If the bar lever is highlighted in red, a pop up message with the related icon will be shown on the instrument cluster.

Drive Mode Explorer

Touching this soft-key, the "Drive Mode Explorer" page shows how different vehicle dynamics parameters are configured in the various drive modes.



The screen shows information related to the currently selected drive mode.



NOTE:

- The other drive modes information can be viewed by tapping on the corresponding drive mode label only when the vehicle is stationary.
- When the vehicle starts moving, the current drive mode information is automatically displayed and the focus is on the current drive mode. The other drive modes buttons are disabled.

Functions of Electric Vehicle Menu on MIA

The MIA system uses a combination of keys able to access to the information about the vehicle present in the "Electric Vehicle" menu of the "Vehicle" screen page. A shortcut to set this menu is available in the "Apps" screen page. Once you enter the "Electric Vehicle" screen using the touch soft-keys, you can read information about the electric vehicle.



The screen shows information about the current flow.

Starting from a greyed image of the vehicle, the system shows two different flow visualizations.

The first one during deceleration or breaking with a towards battery blue flow.

The second one during acceleration showing a towards wheels orange flow passing through the green e-booster.



Functions of Performance Menu on MIA

The MIA system uses a combination of keys able to access to the information about the vehicle present in the “performance” menu of the “vehicle” screen page. A shortcut to set this menu is available in the "Apps" screen page. Once you enter the “Performance” screen using the touch soft-keys, you can read information about the vehicle.

NOTE:

Available Performance contents vary according to vehicle model and equipment.

Performance Pages contents are:

Technical Gauges, Consumption history, Torque Management, Drag Race, Off Road and Accessory gauges.

A scroll bar is displayed on the left part of the screen. User will be able to select the submenus by scrolling/tapping the content list.



Technical Gauges

Touching this soft key, the Performance "Technical Gauges" page shows three different gauges: Boost pressure (turbo), Engine Torque and Oil Pressure.

Consumption History

Touching this soft key, the Performance "Consumption History" page shows a specific histogram.

This screen is composed by a consumption bar graph and an

instantaneous consumption bar (vertical) on the right.

The consumption trend is visualized with many samples from right to left, each sample is a column; the closest column to instantaneous consumption always represents the most recent value and is filled with a lighter color than the other columns. The horizontal amber line represents the average consumption.

NOTE:

If the latest sample is not available the system will leave an empty column on the display.

The user can reset all the stored data by pressing on the dedicated soft-key. When the user taps on the reset soft-key, a confirmation pop up will appear; scroll and push to confirm or touch “No” soft-key.

Torque Management

Touching this soft-key, the Performance “Torque Management” page shows the torque split between front and rear wheels and Slope percentage.

The torque is expressed with dynamic arrows and percentage on each wheel and they change in length dynamically.

Drag Race

Touching this soft-key, the Performance "Drag Race" page shows the following

contents divided into Current, Last and Best race time:

- 0-60 mph and 0-100 mph time
- 1/8 mile time and speed
- 1/4 mile time and speed
- Braking distance time and speed

The system constantly records the previous values and keeps the best ones memorized. When these conditions occur, the current status will display “ready”; during registration it will be replaced with “Rec”. If the session gets interrupted, the status "Incomplete" will be displayed.

On the right of the screen there are two interactive soft-keys: “Reset Last” and “Reset All”. "Reset Last" resets the value reported in the "Last" column while "reset all" resets all values.

When the user taps on the reset button, a confirmation pop up appears; scroll and push to confirm or touch “No” soft-key.

Off Road

Touching this soft-key, the Performance “Off Road” page shows three different gauges: Pitch Angle, Roll Angle and Air Suspension.

Accessory Gauges

Touching this soft-key, the Performance "Accessory Gauges" page shows three different gauges: Oil Temperature,

Transmission Temperature, Battery Voltage.

Functions of Controls Menu on MIA

The MIA system uses a combination of keys able to access and change the customer programmable functions present in the "Controls" or "Settings" menu of the "Vehicle" screen page.

A shortcut to set the customer programmable functions is available in the "Apps" screen page.

Once you enter the “Controls” screen, use the touch soft-keys to scroll and change settings of the customer programmable functions.

Touch the function soft-key to confirm the selection.



Some functions can be set only on or off touching the corresponding soft-key which will be highlighted with the yellow outline (example: "Mirror Dimmer").



Other functions can have one or more instruction/setting pages that are accessed by touching the corresponding soft-key (example: "Surround View Camera").

NOTE:

- All settings must be edited with ignition device set to **ON** position.
- Some of the customer programmable functions are optional or for a specific model/version and may not be available on your vehicle.
- Only one touch screen area/soft-key may be selected at a time.

• Screen Off

This function allows you to switch off the MIA screen backlight if it becomes annoying when driving.

• Mirror Dimmer

The auto-dimming function can be disabled or re-enabled by touching this soft-key. See "Rear-View Mirrors" in section "Understanding the Vehicle" for further details.

• Surround View Camera

Activating this function the system uses four cameras to monitor the area around the vehicle when transmission is moved in P (Park), N (Neutral) or D (Drive) mode.

When activation occurs by touching the "Surround View Camera" soft-key in the "Controls" screen or moving the

transmission in R (Reverse) mode, the initial view will be the default view (associated with current gear state). See "Surround View Camera System" in section "Driver Assistance Systems" for further details.

• Rear Parking Camera

This function allows you to switch on the Rear Parking Camera.

See "Rear parking Camera" in section "Driver Assistance Systems" for further details.

Functions of Settings Menu on MIA

The MIA system uses a combination of keys able to access and change the customer programmable functions present in the "Controls" or "Settings" menu of the "Vehicle" screen page.

A shortcut to set the customer programmable functions is available in the "Apps" screen page.

Once you enter the "Settings" screen, use the touch soft-keys to scroll and change settings of the customer programmable functions.

NOTE:

- All settings must be edited with ignition device set to **ON** position.
- Some of the customer programmable functions are optional or for a specific model/version and may not be available on your vehicle.
- Only one touch screen area/soft-key may be selected at a time.

Modes for Setting a Function

To enter the desired function, touch the corresponding soft-key on the lateral list (the picture shown is "Display").

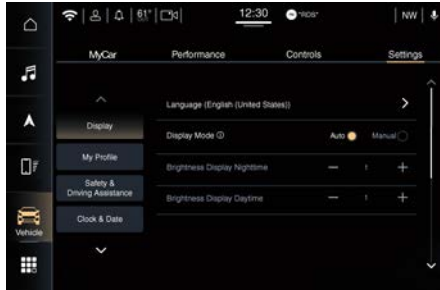

To scroll through the functions of the list, move the cursor up or down, or touch the arrow ∇ or \blacktriangle until the function to be set is displayed. Touching the \blacktriangle or ∇ soft keys and the cursor on the right side of the screen will allow you to scroll up or down through the available setting options. In this screen one or more boxes may indicate status or possible variants of the function. A check mark in a box indicates the active status of the function.

When in a setting line with many options:

- touching on the option currently not selected (no check mark in option) move the selector and change the option accordingly;
- touching on the option already selected (with selection) do not perform action (maintain the option selection).

When in a setting line with one option only:

- if on/off setting (example: "Touchscreen Beep") touching on the option select/deselect the option (check mark appear/disappear). The same behavior is performed touching on the entire row area;
- if one-of-many option setting (example: "English" under "Language" function) touching on the option do not perform action (maintain the check mark). Also in this case, the same behavior is performed touching on the entire row area.

When in a function with +/- soft-key:

- if touch on the +/- soft-key, increase or decrease the value. Touching outside the +/- soft-key do not perform action;
 - when the maximum value +/- is reached, +/- the soft-key turn gray.
- Once the procedure is completed, touch the \leftarrow back arrow to return to the previous menu.

In this mode the MIA system allows you to access the following programmable functions: Display, My Profile, Safety & Driving Assistant, Clock & Date, Phone/Bluetooth, Voice, Navigation, Camera, Mirrors & Wipers, Lights, Brakes, Doors & Locks, Seats & Comfort, Key Off Options, Suspension, Audio, Notifications, Radio Setup, Geolocation, Software Updates, System Information and Reset.

Display

Touch this soft-key to set the following modes.

• Language

When in this display, you can select one language for all display descriptions, including the trip functions and the navigation system (if equipped). The available languages are specific to the target markets.

• Display Mode

When in this display, you can select "Auto" or "Manual" mode.

• Brightness Display Nighttime

When "Display Mode" function is in "Manual" mode, you can select the brightness (night condition). Adjust the brightness from level 0 to 10 with the "+" and "-" setting soft-keys or by selecting any point on the scale between the "+" and "-" soft-keys.

• Brightness Display Daytime

When "Display Mode" is in "Manual" mode, you can select the brightness (day condition). Adjust the brightness as previously explained for "Nighttime" setting.

• Units

When in this display, you can custom each unit of measure that can be independently displayed in the cluster Display and in the navigation system (if



equipped). The following selectable units of measure are listed below:

- **Speed** unit:
select from: "mph" or "km/h".
- **Distance** unit:
select from: "mi" or "km".
- **Pressure** unit:
select from: "psi", "kPa" or "bar".
- **Temperature** unit:
select from: "°F" or "°C".
- **Fuel Consumption** unit:
select from: "MPG (US)", "MPG (UK)", "l/100km" and "km/l".
- **Power** unit:
select from: "HP (US)", "HP (UK)" or "kW".
- **Torque** unit:
select from: "lb-ft" or "Nm".

• Touchscreen Beep

When in this display, you can turn on or shut off the sound activated by pressure of a touchscreen soft-key.

• Show Main Category Bar Labels

By selecting this function, the system shows the labels on the soft-keys of the main category bar.

• Navigation Turn-by-Turn Displayed in Cluster

By selecting this function, the next turn direction will appear on the instrument cluster along a programmed route until the desired destination is reached.

• Phone Pop-ups Displayed in Cluster

When this mode is selected a pop up message will appear in case of incoming call. Information associated to call in progress are available by entering to the "Audio" menu using the buttons on the steering wheel LH side.

• Cluster Options

When in this display, you can custom all secondary settings listed below, displayed in the instrument cluster:

- **Trip B on Cluster**
- **Performance Pages on cluster:**
select the favourite Main Menu Performance visualization for each Drive Mode.
- **Custom Areas on Cluster:**
customize the upper left (10a) and right (10b) area on the instrument cluster with "time", "date", "external temperature", "compass" or "empty" space.
- **Widget List:**
select which additional widget can be visualized in the widget menu on the instrument cluster.
- **Cluster Secondary Content:**
select "Instruction Text" to show instructions to navigate the instrument cluster.

• Head Up Display

When in this display, you can activate/deactivate or custom the Head Up Display:

- **Head Up Display**
select from: "On" or "Off".
- **HUD Brightness:**
adjust the brightness from level 0 to 10 with the "+" and "-" setting soft-keys.
- **HUD Height:**
adjust the height from level 0 to 10 with the "+" and "-" setting soft-keys.
- **HUD Content:**
select the visualization between: "Simple", "Standard" or "Advanced".

My Profile

Touch this soft-key to custom a list of settings, linked to the chosen profile, extracted by each setting sub-menu.

Safety & Driving Assistant

Touch this soft-key to set the following modes.

• Forward Collision Warning / Pedestrian Emergency Braking

The FCW function primary use the front radar and the forward looking camera for sensing vehicle and pedestrian ahead, provide warnings to the driver and may perform brakings and brake jerks (if set).

FCW is always active: it is possible to set the warnings, the sensitivity and the aid of the active braking.



FCW warnings can be set in "Off", "Only Active Braking" (default mode) and "Warning + Active".
 FCW sensitivity can be set to "Near", to "Med (Medium)" or to "Far".
 The default status of FCW sensitivity is the "Med" setting.
 FCW with active braking can be set to "On" or "Off".
 See "Forward Collision Warning - FCW" in section "Driver Assistance Systems" for more details.

- **Pedestrian Emergency Braking** 

PEB can be set in "Off" or "Warning + Active Braking".

- **Active Lane Management**

Activating this function the ALM system will attempt to keep the vehicle in lane and can apply direct input to electric power steering system to change direction of vehicle.

The system can be set to "Vibration only", "Steering Assist only" and "Vibration + Steering Assist".

lane Warning can be set to "Early" (default mode), "Medium" and "Late".
 Vibration Strength can be set to "Low" (default mode), "Medium" and "High".
 Steering Assist Strength can be set to "Low" (default mode), "Medium" and "High".

- **Traffic Sign Assist**

Activating this function the forward-facing digital camera, with the aid of maps on the navigation system, is able to detect signs (no overtaking, etc.) and speed limits. Those are displayed by the TSA system on the instrument cluster display together with a possible alert when the vehicle exceeds the speed limit.

See "Traffic Sign Assist - TSA" in section "Driver Assistance Systems" for further details.

- **Park Assist**

The park assist system will scan for objects behind and in front of the vehicle when the transmission is in R (Reverse) or D (Drive) mode and the vehicle speed is less than 7 mph (11 km/h).

The system can be enabled or turned "Off". See "Park Assist" in section "Driver Assistance Systems" for further information.

- **Park Assist Front Sensors Active in Drive**

If this function is active, when driver moves from P (Park) or N (Neutral) to D (Drive) mode, front parking sensors are activated. If this function is not active, when driver moves from P (Park) or N (Neutral) to D (Drive) mode, front parking sensors are NOT activated.

- **Front ParkAssist Volume**

When this function is selected, the chime volume of front park assist sensors can be set to "Low", "Medium" or "High" level. "Medium" is the default setting.

The system will retain its last known configuration state through ignition cycles.

- **Rear ParkAssist Volume**

When this function is selected, the chime volume of rear park assist sensors can be set to "Low", "Medium" or "High" level.

"Medium" is the default setting.

The system will retain its last known configuration state through ignition cycles.

- **Active Park Braking**

When this function is selected, when the vehicle move backwards in R (Reverse mode) at a very low speed and an obstacle is detected, the system brakes automatically.

- **Side Distance Warning**

When this function is selected, the surround screen visualize 4 more arcs on the vehicle sides in the top view.

- **Blind Spot Alert**

Activating this function the system will try to prevent collision between host vehicle and potential blind spot collision hazard.



This function can be set in "Off", "Lights" or "Lights + Chime".

See "Blind Spot Assist - BSA" in section "Driver Assistance Systems" for more details.

• Hill Start Assist

By selecting and check-mark this function, this system provides start assistance when the vehicle is on an incline.

• Passenger airbag

By selecting this function, this current status of the front passenger airbag is changed and it is visualized on the front dome console.

Clock & Date

Time is visible on the dashboard smart clock (see "Smart Clock" in this section) and on the instrument cluster and on the MIA display.

With this function it is possible to view and set the following modes.

• Sync with GPS Time

Time is normally automatically synchronized with the radio signal. It is also possible to set automatic synchronization mode using GPS signal instead.

• Set Time Hours

With "Sync with GPS Time" function unchecked and this mode selected, you can set the hours manually from 1 to 24.

To select, touch the "+" or "-" soft-keys to adjust the hours.

• Set Time Minutes

With "Sync with GPS Time" function unchecked and this mode selected, you can set the minutes manually from 0 to 59. To select, touch the "+" or "-" soft-keys as done for the hours.

• Time Format

When in this mode, you can select the time format display. To change the current setting, touch and release the "12 h" or "24 h" soft-key.

• Show Time In Status Bar

This function will allow you to turn on or shut off the digital clock in the upper status bar.

• Set Date (in Cluster)

When in this mode, you can set the date manually on the instrument cluster display. Touch the "+" or "-" soft-keys to adjust day, month and year.

• Show Time and Date During Screen Off

When in this mode, you can display the digital clock and date during screen off.

Phone/Bluetooth

Touch this soft-key to select the function related to the connect phones.

• Device Manager

By selecting this function, when touch the "Phone" soft-key in the main category bar the system open the

"Device Manager" page to manage the connected devices.

• Do Not Disturb All

By selecting this function will block incoming texts, calls or both.

• Enable Two Active Phones

By selecting this function the MIA system enable two phones connected via Bluetooth.

NOTE:

On the Maserati website, at www.maserati.com, or through an Authorized Maserati Dealer you may consult the list of telephones that are compatible with the MIA, and their level of compatibility.

• Phone Pop ups Displayed in Cluster

When this mode is selected a pop up message will appear in case of incoming call. Information associated to call in progress are available by entering to the "Audio" menu using the buttons on the steering wheel LH side.

Voice

After touching this soft-key the following modes to give voice commands will be available.

• Voice Options

It is possible choose between "Female" or "Male" voice commands.

• Wake Up Word



With the microphones in the listening mode, this function allows you to select the wake up word from the available options.

- **Voice Barge-in**

By selecting this function it is possible to respond to a voice response before the statement is completed.

- **Show Command List**

When this function is selected, it is possible to select suggested options during a voice control session.

Navigation

Touch this soft-key to set the following modes.

- **Show**
- **Map View**
- **Routing**
- **Sound & Alerts**
- **Other**

Camera

Touch this soft-key to set the following modes.

- **Surround View Camera Delay**

By selecting this function the surround camera image will be displayed for up to 10 seconds after shifting out of R (Reverse) unless the forward vehicle speed exceeds 8 mph (13 km/h).

- **Surround View Camera Guidelines**

By selecting this function, surround camera guidelines are displayed on the screen.

- **Rear View Camera Delay**

By selecting this function the rear view camera image will be displayed for up to 10 seconds after shifting out of R (Reverse) unless the forward vehicle speed exceeds 8 mph (13 km/h).

- **Rear View Camera Active Guidelines**

By selecting this function, rear view camera guidelines are displayed on the screen.

Mirrors & Wipers

Touch this soft-key to set the following modes.

- **Tilt Side Mirrors In Reverse**

By selecting this function the outside side-view mirrors will tilt downward when the ignition device is in **ON** position and the transmission is in R (Reverse) mode. The mirrors will move back to their previous position when the transmission is moved out of R (Reverse) mode.

- **Auto Folding Side Mirrors**

By selecting this function the rear-view mirrors automatically fold when the vehicle is locked by the key fob and when the liftgate is closed and locked by pressing the  button on the right side of the outer edge of the liftgate. When the vehicle and the liftgate will

be unlocked, the rear-view mirrors will automatically open in the position they had before the lock.

If the mirrors were manually folded by the switch on the driver's door panel, before a lock action, they will need to be manually unfold to reactivate the automatic behave.

- **Headlights with Wipers**

By selecting this function, while the headlight lever is in "AUTO" position, the headlight will turn on approximately 10 seconds after the wipers are activated. The headlight will also turn off when the wipers deactivate if they were activated in the current mode.

Lights

Press the "Lights" soft-key to set the following modes.

- **Headlight Off Delay**

To change the current headlight off delay status when the engine is shut off, touch the "+" or "-" soft-keys to adjust the desired time range.

- **Headlights Illumination on Approach**

By selecting this function, the driver can choose to have the headlight on when the doors are unlocked with the key fob for a desired amount of time, set touching the "+" or "-" soft-keys.

- **Proximity Wake-Up**

By selecting this function, external lights, position lights, handle lights and



external rear view mirrors lights will switch on.

• Greetings Light

By selecting this function, the activation of the headlight is activated unlocking the vehicle with the key fob; set touching the “+” or “-” soft-keys.

• Auto Dim High Beams

By selecting this function, the high beam headlight will deactivate automatically under certain conditions. See “External Lighting” in section “Understanding the Vehicle” for further information.

• Headlight Dip (right/left-hand drive)

By selecting this function, the headlights will change their light distribution when a left-hand-drive vehicle enter a Country with right-hand-drive system and vice versa.

• Flash Lights with Lock

By selecting this function, the headlights will flash when the doors are locked or unlocked with the key fob or when using the "Passive Entry" function.

Brakes

Touch this soft-key to set the following modes.

• Auto Park Brake

By selecting and check-mark this function, the EPB will automatically be

engaged if the transmission is set in P (Park) mode.

• Brake Service

By selecting this function, the system will ask the driver to disengage the EPB to have the brakes serviced.

Doors & Locks

Touch this soft-key to set the following modes.

• Auto Door Locks

When this function is selected, all doors will automatically lock when the vehicle is in motion.

• Auto Unlock on Exit

By selecting this function, all doors will unlock when the vehicle is stopped, the transmission is in P (Park) or N (Neutral) mode and the driver's door is open.

• Flash Lights with Lock

By selecting this function, the headlights will flash when the doors are locked or unlocked with the key fob or when using the "Passive Entry" function.



• Sound Horn with Lock

When this function is selected, the horn will sound when the doors are locked or unlocked with the key fob. The default status of this function is set to "Off" (no sound). The customer could change the status to have a comfort, following the regulation in his country.

• Sound Horn with Remote Start

When this function is selected, the horn will sound when you use the Maserati Connect App to start the engine. See “Remote Start System” in section “Starting and Driving” for further details.

• 1st Press of Key Fob Unlock

By selecting this function you may set up only the driver's door or all doors mode will unlock on the first press of the key fob  button. When “Driver Door” is selected, you must press the key fob  button twice to unlock also the passenger's doors.

When unlocking “All Doors” by first press selection mode, all doors will unlock on the first press of the key fob  button.

• Personal Settings Linked to Key Fob

This selected mode enables to combine the key fob to personal driver's position settings. These settings will be implemented when pressing the  button on the key fob with ignition device in **ON** position.

• Power Liftgate Alert

By selecting this function, the system plays an alert when the power liftgate is raising or lowering.

• Hands Free Power Liftgate

To prevent the accidental opening of the power liftgate with Hand Free



function with the movement of the foot, it is possible to disable this function. This operation is recommended when you have to wash the car (for further information, refer to “Open and Close the Liftgate” in section “Before Starting”).

• **Walk Away Lock**

Waling away from the vehicle, it will lock automatically once you exit the walk away zone.

NOTE:

Check by lights animation or by chime signal that the vehicle is locked.

Seat & Comfort

Press this soft-key to set the following modes.

• **Easy Exit Seats**

When this function is selected, the driver's seat will automatically move rearward once the engine is shut off for easy exit of the vehicle.

• **Auto-on Comfort**

This function allows to activate the comfort of the driving seat when starting the engine.

If equipped, the driver's heated/vented seat and/or heated steering wheel will automatically activate by temperatures below 40°F (4°C). When temperatures are above 80°F (26°C) the driver vented seat will turn on.

If the vehicle is equipped with the remote start system, you can choose from the following options: “Off”, “Remote Start” (activation of this function when you use the Maserati Connect App to start the engine) and “All Starts” (activation of this function when you start the engine in all modes).

Key Off Options

This function allows you to set some functions after turning off the engine.

• **Easy Exit Seats**

When this function is selected, the driver's seat will automatically move rearward once the engine is shut off for easy exit of the vehicle.

• **Headlight Off Delay**

To change the current headlight off delay status when the engine is shut off, touch the “+” or “-” soft-keys to adjust the desired time range.

• **Auto Entry/Exit Suspension**

Select this mode to automatically lower vehicle to minimum ground clearance when driver takes transmission to P (Park) mode to help entry into and exit from the vehicle and unloading of cargo from the trunk compartment.

• **Radio Off Delay**

To change the current radio off delay status when the engine is shut off,

touch the “+” or “-” soft-keys to adjust the desired time range.

NOTE:

If **Switch On the MIA (Power On Button) with Radio Off Delay set**, the brightness of the display decreases to the minimum status to preserve the battery.

• **Radio Off with Door**

When this function is selected, radio remains on until driver or passenger door is opened or when Radio Off Delay selected time expires.

Suspension

This function allows displaying and setting the following modes of the pneumatic suspension system.

• **Auto Entry/Exit Suspension**

Select this mode to automatically lower vehicle to minimum ground clearance when driver takes transmission to P (Park) mode to help entry into and exit from the vehicle and unloading of cargo from the trunk compartment.

• **Display Suspension Messages**

Select this mode to choose whether to display all suspension related messages (option "All") or only suspension warning messages (option “Warning only”).

• **Tire Jack Mode** (Stationary Auto Leveling)



Select this mode to disable the pneumatic suspension to avoid automatic levelling, when vehicle must be lifted for changing a wheel or tire.

• **Auxiliary Modes**

Select this mode to choose between:

- **Transport Mode** to lower the pneumatic suspension to minimum ride height and disable system operation to help vehicle loading and transport, for instance on the platform of a tow truck
- **Wheel Alignment Mode** to prevent automatic pneumatic suspension alignment when servicing suspension and/or steering parts
- **Off** (default mode)

Audio

This function enables to view and set the available audio modes depending on the type of audio system supplied on the car.

• **Audio Settings**

Touch this function to open the subscreen with all the audio settings items.

The following settings refer to the "High Premium" audio system.

• **Balance/Fade**

Use this screen to adjust the balance and fade settings. Touch and drag the speaker icon using the arrows to adjust them.

• **Equalizer**

This screen is used to adjust the "Bass", "Mid", "Treb" and "XBass" settings. Adjust the settings with the "+" and "-" setting soft-keys or scroll and touch the slider in any point on the scale between the "+" and "-" soft-keys.

• **Speed Adjusted Volume**

This function increases or decreases volume combined to vehicle speed. To change the speed adjusted volume touch the "Off", "1", "2" or "Max" soft-key.

• **Surround Sound**

This function provides simulated surround sound mode. Available settings: "Off", "2D" and "3D".

• **Surround Sound Intensity**

This function increases or decreases the intensity of the surround sound. Adjust the settings with the "+" and "-" setting soft-keys or scroll and touch the slider between the "+" and "-" soft-keys.

• **Auto Play**

When a portable device is connected via USB port to MIA system, it plays automatically the songs if this function is set to "On".

• **Auto-On Radio**

This function has three states: "ON", "OFF" and "Recall Last". When set to "OFF" the Radio will not turn on after

ignition cycle. When set to "ON" the Radio will turn on after an ignition cycle. If you choose "Recall Last" the Radio recalls the last state.

• **Radio Off with Door**

When this function is selected, radio remains on until driver or passenger door is opened or when Radio Off Delay selected time expires.

• **Volume Adjustment**

Use this screen to adjust the volume settings of the different sources (Media, Phone, Navigation and Voice Recognition). Touch and drag the bar or use the "-" and "+" soft-keys to adjust the volume.

• **Tuning Mode**

Use this screen to choose between 2 different set-up for characterizing the listening experience (see "Audio System" in section "Understanding the Vehicle" for further information).

• **Media Expander**

Application of algorithm for processing MP3 files or low resolution/compressed sources to improve sound quality. Available settings: "On" and "Off".

Notification

Touch this soft-key to set the following modes.

• **Notifications Sounds**



By selecting this function it is possible to turn on and off notifications volume.

- **App Drawer Favoriting Popups**

By selecting this function it is possible to turn on and off popup for "App Favorited".

- **App Drawer Unfavoriting Popups**

By selecting this function it is possible to turn on and off popup for "App Unfavorited".

- **New Text Message Popups**

By selecting this function it is possible to turn on and off the receiving/storing of a popup for new text messages of any connected phone.

- **Missed Calls Message**

By selecting this function it is possible to turn on and off the receiving/storing of a popup for missed calls of any connected phone.

- **Navigation Popups**

By selecting this function it is possible to turn on and off the receiving/storing of predictive Navigation popups and any other Navigation popups that can be turned off.

- **Wireless Charger Status Popups**

By selecting this function it is possible to turn on and off the Wireless Charger status popups.

- **Drive Mode Transition Popups**

By selecting this function it is possible to turn on and off Drive Mode change pop-ups on the MIA display.

SiriusXM Setup

After pressing the "SiriusXM Setup" soft-key the following settings will be available.

- **Tune Start**

"Tune Start" begins playing the current song from the beginning when you tune to a music channel, so you can enjoy the complete song. "Tune Start" works in the background, so you will not even realize it's on, except that you will miss the experience of joining your favorite song with only a few seconds left to play.

- **Channel Skip**

SiriusXM can be programmed to designate a group of channels that are the most desirable to listen to or to exclude undesirable channels while scanning. To make your selection, touch the Channel Skip soft-key, select the channels you would like to skip followed by pressing the arrow < soft-key.

- **Subscription Information**

SiriusXM Satellite Radio requires a user-paid subscription to access these stations.

It will be necessary to access the information on the Subscription

Information Screen in order to subscribe. Touch the Subscription Info soft-key to access your receiver ID number. Write down the SiriusXM ID numbers for your radio. To activate SiriusXM service, either call the number listed on the screen or visit SiriusXM online at www.siriusxm.com/subscriptions or call the number listed.

Geolocation

Touch this soft-key to set the following modes.

- **Geolocation**

By selecting this function it is possible to disable or re-enable the GPS tracking in the vehicle.

Software Updates

Touch this soft-key to set the following modes.

- **Software Downloads over Wi-Fi**

By selecting this function you can download the MIA software via Wi-Fi.

System Information

Touch this soft-key to set the following modes.

- **Version Information**

By selecting this function you can access the data page relating to the software version installed on MIA.

- **License Information**



Reset

Touch this soft-key to set the functions which allow you to reset data, Apps and password used by MIA system .

• Restart Radio

• Reset App Drawer to Default Order

By selecting this function a popup will appear asking user to confirm App Drawer resetting. Select "Yes" to restore, or "Cancel" and "X" to close the popup without reset the App Drawer.

• Restore Setting to Default

When this function is selected, it will reset the "Clock", "Audio", and "Radio" settings to their default settings.

Run this function and a pop up will appear asking user to confirm default settings resetting. Select "Yes" to restore, or "Cancel" and "X" to exit. Once the settings are restored, a pop up appears confirming that settings have been reset to default and then the MIA will restart.

• Clear Personal Data

When this function is selected, it will remove personal data concerning settings and/or options that have been modified compared to factory settings and will also remove from system memory Bluetooth devices, Apps and presets.

To remove personal information, select this function and a pop up will appear

asking confirmation to delete all personal data. Select "Yes" to clear, or "Cancel" and "X" to exit. Once the data have been cleared, a pop up appears confirming that personal data have been cleared and then the MIA will restart.

NOTE:

This function is guaranteed when:

- the vehicle is stationary with the ignition device ON.
- 15 minutes have passed since the vehicle is turned off (including the MIA screen); the operation will be performed at the next key on.

Non-observance of the previous indications could fail partially or at all the executions of the function.

• Reset Wi-Fi Password for Projection

By selecting this function a popup will appear with the request to confirm the intention to change the Wi-Fi password. Select "Yes" and then "OK" to reset the password, or "Cancel" and "X" to close the popup without reset the Wi-Fi password.

• Reset Performance Values

By selecting this function a popup will appear with the request to confirm the intention to reset performance values. Select "Yes" and then "OK" to reset the values, or "Cancel" and "X" to close the

popup without reset the performance values.

• Factory Reset

Selecting this function a popup will appear with the request to confirm the intention to reset the MIA to the factory defaults. The "Yes" choice will cause the MIA to restart and the backup camera, the radio, SOS Call and several driving assistance functions will not available. This could take several minutes. Select "Cancel" or "X" to close the popup without resetting the factory defaults.



Controls on Steering Wheel

ADAS Controls

The controls on the right side of the steering wheel are dedicated to ADAS systems and their presence and layout depend on the car's options.

The "Standard Configuration" includes the controls of the **1** Cruise Control (CC) and **2** Speed Limiter (SL) systems.

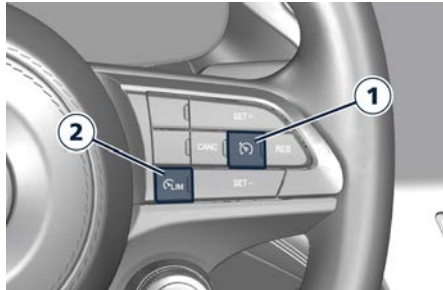

Standard Configuration

The other two "Optional Configuration" add the **3** Adaptive Cruise Control (ACC) and/or the **4** Active Driving Assist (ADA) button to the Cruise Control (CC) and **2** Speed Limiter (SL) systems.

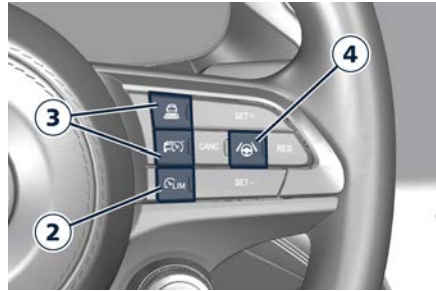

Optional Configuration

For all information on the use of these commands, see the chapters on the individual ADAS systems in the section "Driver Assistance Systems".

Phone and Voice Controls

The controls on the left side of the steering wheel activate (📞) / deactivate (📞) the phone mode and the Voice Recognition (🗣️) functions.

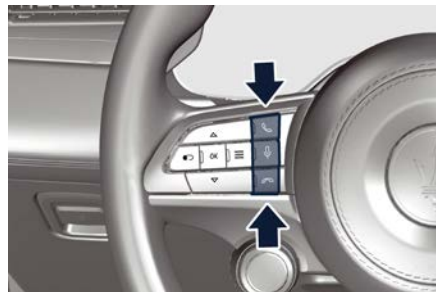

These functions are only available when one or more Bluetooth® compatible mobile phones are paired with the MIA system connection.

To pair a phone and to learn all available functions refer to the "Maserati Intelligent Assistant™ (MIA)" guide.

NOTE:

On the Maserati website, at www.maserati.com, or through an **Authorized Maserati Dealer** you may consult the list of telephones that are compatible with the MIA, and their level of compatibility.

The voice command communication system is fully integrated with the vehicle's audio system.

The volume can be adjusted from the "VOLUME" capacitive touch button on the Comfort Display (see "Maserati Intelligent Assistant™ Operation" in this section) or from the steering wheel audio controls described in this chapter.

The system will automatically mute the radio when using the phone mode. When activating the phone mode using voice commands with speakerphone, you should talk quietly in a normal conversational tone by keeping the driving position and turning to the microphone of the voice command system located inside the internal rearview mirror.



Dashboard Instruments and Controls

The ability of the system voice control to recognise the user's voice commands can be invalidated when speaking too quickly or too loudly.



WARNING!

Any voice-controlled system should be used only in safe driving conditions following all applicable regulations. Full attention should be kept on driving.

Phone Mode Button

By using the phone button  on the steering wheel it is possible to: activate the phone mode, start a call, show recent incoming and outgoing calls, show contacts list, etc.





Phone call status information during an active call will be shown in the widget area of the cluster display.

Touching the active call soft-key on the main category bar, the "Phone" page will open.



Information on incoming call is indicated in a pop up on instrument cluster display widget area if this function is checkmarked on MIA (see "Functions of Settings Menu on MIA" in this section). Said information will stay displayed until a control is executed (e.g.: answer, reject, etc.) for the incoming call.

The screen will only display the phone number or name of caller (if available) as long as this complies with system specifications in terms of font and number of characters.

Call details can be displayed at any time through Recent Calls submenu of Quick Actions () button on the left side of the steering wheel. On display, said details shall temporarily replace the ones on media source in use.

To close a call, use the phone button ()

Voice Recognition Button

The short pressure of the VR  button on the steering wheel allows you to give voice commands dedicated to all the native functions of the MIA (radio, media, navigator () , etc.). Excluded are all functions that interact with the Apps: "Apple CarPlay" and "Android Auto" or those of the voice assistants: Siri,

Google Voice, etc..., supported on the mobile paired via Bluetooth® to the MIA. Google Voice is supported only in Android Auto™ and not via Bluetooth®. A long pressure of the VR  button, in addition to the native ones of the MIA, allows to give voice commands dedicated to the above mentioned Apps and voice assistants.

NOTE:

The pressure difference of the VR  button (short or long) is effective only when the mobile is paired via Bluetooth® to the MIA.

On the markets where it is available, once voice recognition is activated via the VR  button on the steering wheel, a "teleprompter" screen is displayed on the MIA with a list of commands specific to each active function key shown on the vertical menu bar in the left side of the screen.

The teleprompter screen shall always open at the "Suggested" menu. Selecting a different menu will bring up commands within that menu.

The key words to activate the dialog are white, the variable ones grey between the symbols "< >" and the alternative ones after the slash "/".

Touching voice help  soft-key the help response will be reproduced. It will have



the same function as saying help. If the dialogue is paused, at the end of the help  prompt the teleprompter will return to the listening status.

Touching setting  soft-key the voice session will be cancelled and will open the voice settings page.

At the top center of the teleprompter screen is displayed an animation representing the listening, processing and speaking state. While in the listening state, the animation will react to the microphone input: when in speaking state, will react to the prompt.

Touch the "Cancel" soft-key to end the voice dialog and close the teleprompter screen.

Touching one of the soft-key on the main category bar, the session is canceled and displays the selected category screen.

When pressing the VR  button an acoustic signal will invite to give a voice command.

NOTE:

For further details refer to the "Maserati Intelligent Assistant™ (MIA) guide".

Siri Smart Personal Assistant

When a compatible iPhone® or iPad® that supports Siri voice recognition is paired to the vehicle via Bluetooth®, a

long press of the VR  button activates the Siri Smart Personal Assistant. Siri requires mobile internet access and its functionality might change depending on the geographical area.

Through simple voice commands, without taking your eyes off the road, it may be possible to send messages, make phone calls, create notes and reminders, etc.

Audio System Controls

The vehicle is equipped with audio controls which allow the driver to operate the audio system. These controls can be used to adjust audio volume, change radio station or mode. These audio controls are rocker-type switches with a button in the center and are located on the rear side of the steering wheel, right behind the front switches.



Press any button to display information on the radio station or track being listened to inside a pop up for 2 seconds on instrument cluster.

The right-hand control manages the volume.

By pressing the top of the rocker switch you can increase the volume and by pressing the bottom of the rocker switch you can lower it. Press the center button to mute the volume.

The left-hand control functions depend on the current source. To change source, press the center button.

When in "Radio" mode, pressing the top of the switch will "Seek" up for the previous listenable station and pressing the bottom of the switch will "Seek" down for the previous listenable station. When an external source is connected to MIA, a light press on the top of the switch will play the next track on the device connected.

Press the bottom of the switch once to go to the beginning of the current track, or to the beginning of the previous track if it is within 1 second after the current track begins to play.

If you press the switch up or down twice, it plays the second track; three times, it will play the third one, etc.



External Lights Controls

Controls on Comfort Display

The controls for managing the external lighting are located on the left multifunction lever behind the steering wheel and in a side menu of the Comfort Display as follows:

1. External lights soft-keys
2. Parking lights soft-keys



The indicator lights of the status lights active are shown in the left lower side of the instrument cluster (area 8a.3 and 8a.4): 8a.4 is a rolling area where low beam and high beam lights may appear (for the areas description, see “Instrument Cluster Overview” in this section).

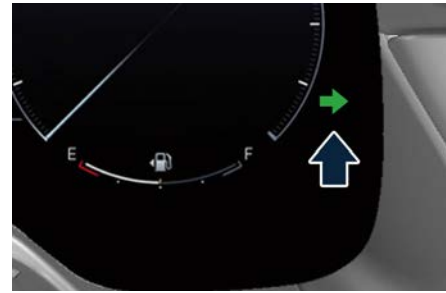
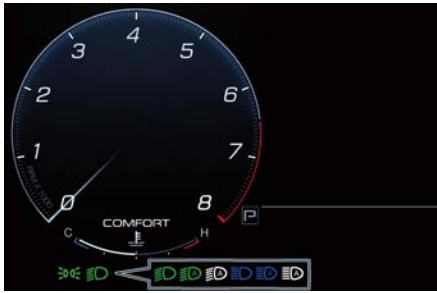

When a turn signal is activated, the related indicator light is displayed in the side sectors of the instrument cluster dedicated to the hard telltales.











External Lights Switch Operation

Every time the user turns the vehicle on (key on), lights status is automatically set to AUTO mode. When the user turns the vehicle off (key off) with the low beams active, the functional status will be set to OFF.

Starting from key off, the table shows the functions that can be activated by pressing the lights switch in succession and their display on the instrument cluster.

Vehicle state	Lights function with action on Comfort Display	Indicator light in area 8a.3 an 8a.4
Key off	Light controls and slope grayed out. Parking light OFF.	-
Key off	Light controls and slope grayed out. Parking light ON.	-
Key on	Light control in OFF position.	-
Key on	Light control in AUTO position.	 Low beam off
		 Low beam on
Key on	Light control in Low beam  position	
Key on	Light control in position light  position	



Parking Lights

All parking lights can be activated via soft-key only when in Key off.

Parking lights left or right side separately can be activated via soft-key in the light menu on the Comfort Display only when in Key off.

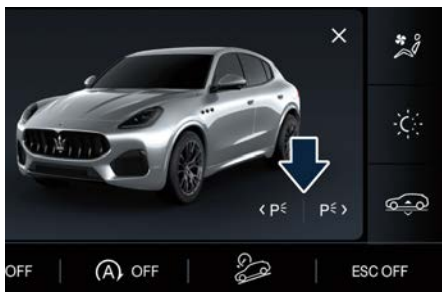

If you want to leave only those on one side (right/left) switched on, you need to select only one of the two soft-keys: the left one to leave the parking lights on the left side on, the right one to leave those on the rights side on.

Daytime Running Lights (DRL)

DRL are activated in AUTO mode during day time.

The use of low beams deactivates the DRL to activate parking lights.

During night time, the use of AUTO mode deactivates the DRL to activate parking lights.

Together with the DRL lights are also turned on the number plate lights.

NOTE:

In countries where DRL use is not required, these lights can be switched off.

Low and High Beam Lights

Low beam lights can be switched on manually or automatically in AUTO mode based on the ambient brightness detected by the twilight sensor. Both modes are activated using the soft-keys in the light menu on the Comfort Display. With low beam lights switched on manually or automatically in AUTO mode, the high beam lights can be switched on pushing the left multifunction lever towards the instrument cluster.



With high beam lights on, the  blue indicator light on the 8a.4 area of the

instrument cluster will come on at the same time.

The high beam lights are switched off by pushing the left multifunction lever again. The  indicator light switches off on the instrument cluster.

Twilight Sensor



This is composed by an infrared LED sensor on the windscreen that works in conjunction with the rain sensor. It is able to detect variations in the outside light level.

The functionality of the twilight sensor is essential for the management of the external lights when the AUTO mode is selected.

Blinking

The flashing of the high beam lights is activated by pulling the left multifunction lever towards the steering wheel, the lights remain on while you are operating the lever.

Direction Indicators

Move the left multifunction lever all the way up or down until the stop trigger; the  left or  right indicator light on the lateral sectors of the instrument cluster flashes to show proper operation of the front and rear direction indicator lights.



In these cases, contact an **Authorized Maserati Dealer**.

Internal Light Controls

Dome Console Lights

The dome console includes two lateral lights and the related control buttons and two anti-theft sensors (OPT)



Both the lateral lights automatically turns on when one of the doors is opened and turns off when the door is locked and the ignition device is in **ON** position and if the greeting lights are active on the MIA screen (see paragraph "Functions of Controls Menu on MIA" in this section). The light may be switched on manually by pressing both buttons. The switching on and off of the lateral lights can be controlled by the respective buttons (reading function). Pressing a single button will switch on the respective front light. The central button on the dome console switches on all compartment lights.

To activate lane change function, tap the lever up or down once, without moving beyond the detent. The direction indicators (right or left) will flash three times then automatically turn off. This function is useful when overtaking or changing lanes.

NOTE:

If either light remains on and does not flash, or flashes at a fast rate, check for a defective outside light. If an indicator on instrument cluster fails while moving the lever, then the direction indicator is probably defective.

Lights Failure Messaging

The failure conditions (example: "High beams fail service required", "Right turn signal light out", etc..) are notified on instrument cluster with a pop-up message and with the switching on of the dedicated warning light, if present.



Pressing the button a second time, all lights are switched off.

NOTE:

The dome lights will also turn on by pressing the  button on the key fob if the greeting lights are active on the MIA screen (see paragraph "Functions of Controls Menu on MIA" in this section).

Interior Brightness Adjustment

The interior and external greeting lights turn on and off when entering/exiting the vehicle.

The brightness and tone of the ambient lights, controls and instruments, but not the dome console lights, can be adjusted via the Ambient Menu on the Comfort Display.

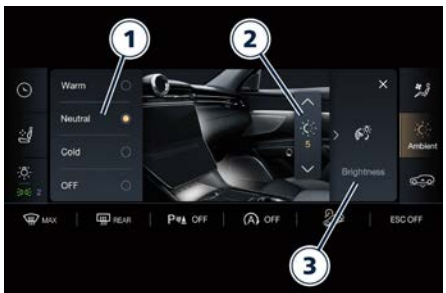

1. Set ambient light tone
2. Set ambient light tone brightness (max value reached 6)
3. Screen and controls brightness menu (max value reached 6)

Wipers and Washers Control

The right multifunction lever controls wiper and washer operation. This operates only with the ignition device at ON.

Windshield washer low fluid level is indicated by the warning light and by a message on the instrument cluster.



To refill the fluid, see "Maintenance Procedures" in section "Maintenance and Care".

WARNING!

- Do not start the washers during the cold months until the windshield has warmed up. If it has not warmed up, the liquid could freeze on the glass and block your view.

- Sudden loss of visibility through the glass could lead to a collision. You might not see other vehicles or other obstacles. To avoid sudden icing of the glass during freezing weather, warm them with the defroster before and during washer use.

CAUTION!

- Never use the wipers to remove layers of snow or ice from the glasses. In such conditions, the windshield wiper may be subjected to excessive stress and the motor cut-out switch, which prevents operation for a few seconds, may intervene. If operation is not subsequently restored, even after restarting the engine, contact an Authorized Maserati Dealer.
- In cold weather, always turn off the wipers control and allow the wipers to return to the park position before turning off the engine. If the wipers control is left on and the wipers freeze, the wipers motor may be damaged when the vehicle is restarted.
- Always remove any buildup of snow that prevents the wiper blades from returning to the off position. If the wipers control is turned off and the

- blade cannot return to the off position, the wipers motor may be damaged.
- Do not operate the wipers with the blade lifted from the glass.
- Make sure the wipers and washer device is turned off if there is ice on the glass.

Operation of Control

The ring on the lever can be set to the following positions:

- 0 windshield wiper off;
- A rotating the ring to the first position activates the first sensitivity level of the rain sensor;
- A rotating the ring to the second position activates the second sensitivity level of the rain sensor;
- rotating the ring to the third position activates the first continuous speed level of the windshield wipers in manual mode;
- rotating the ring to the fourth position activates the second continuous speed level of the windshield wipers in manual mode.



Move the right multifunction lever upwards (unstable position) or downwards (unstable position) to activate the MIST function respectively for the windshield and the rear window: its operation is limited to the time for which the lever is held in this position. When released, the lever will return to its default position and the windshield or rear window wiper automatically stop. This function is useful to remove small deposits of dust from the glasses, or morning dew.

NOTE:

MIST function does not activate the washer; washer fluid will not therefore be sprayed onto the glasses. To spray washer fluid onto the glasses, the washing function must be used.

With ring in position — or —, the windshield wiper will automatically

adapt its operating speed to the speed of the car.

“Smart washing” Function

Pull the right multifunction lever towards the steering wheel (unstable position) to operate the windshield washer. Keep the lever pulled to activate both the windshield washer jet and the windshield wiper with a single movement; the latter turns on automatically.

The windshield wiper stops working three strokes after the lever is released. A further stroke after approx. 6 seconds completes the wiping cycle.

Head Windshield Washer Nozzles (OPT)

To avoid fluid freezing inside at low external temperatures, the fluid supply nozzles can be heated by internal resistors.

Rain Sensor Operation

The rain sensor is located behind the interior rear view mirror, in contact with the windshield and can detect the presence of rain and, consequently, manage the cleaning of the windshield in accordance with the amount of water on the windshield.



The sensor has an adjustment range which varies progressively from wiper still (no stroke) when the windshield is dry, to wiper at 2nd continuous speed (fast continuous operation) with intense rain.

Positions **1A** and **2A** correspond to sensitivity level 1 and 2 of the rain sensor.

Activation

Turn the ring of the right multifunction lever to position **1A** or **2A** to activate the rain sensor.

The activation of the sensor is signaled by a flick of the wiper (indicating that the command has been acquired).

The variation in sensitivity during rain sensor operation is also signaled by a flick of the wiper (command acquired and implemented). This stroke is also executed with the windshield dry.

If the windshield washer is used with the rain sensor activated, the normal washing cycle is performed, after which the rain sensor resumes its normal automatic operation.



CAUTION!

- Keep the glass in the sensor area clean.
- With the windshield wiper ring turned to the **1-** or **2A** position, wiping operates automatically and is disabled when the outside temperature is below 32 °F (0 °C).
- Use on the windshield of RainX® or products containing wax or silicone may reduce rain sensor performance.

Deactivation

Use ring of the right multifunction lever or place the ignition device in **STOP** position.

In the event of malfunction of the rain sensor whilst it is active, the windshield wiper operates intermittently at a speed consistent with the sensitivity setting of the rain sensor, regardless of whether there is rain on the glass, while sensor failure is indicated on the display (see “Warning and Indicator Lights” in this section).

The sensor continues to operate and it is possible to set the windshield wiper to continuous mode **1-** or **2-**. The failure

indication remains for as long as the rain sensor is active.

The rain sensor is able to recognize, and automatically adjust itself in the presence of the following conditions:

- presence of dirt on the controlled surface (e.g. salt, dirt, etc.);
- presence of streaks of water caused by the worn window wiper blade;
- difference between day and night.



CAUTION!

Do not activate the rain sensor when washing the car in an automatic car wash.



WARNING!

Make sure the device is turned off whenever the windscreen glass must be cleaned to avoid personal injury.

Rear Window Wiper/Washer

Engaging reverse gear with the windscreen wiper operating activates a single cycle of the rear window wiper. Moving the multifunction lever towards the dashboard activates the rear window washer (a brief push activates one washing cycle, keeping the multifunction lever pushed washes continuously until the lever is released).



Moving the multifunction lever downwards (with reverse gear engaged) activates/deactivates the continuous operation of the rear window wiper, regardless of the movement of the windscreen wiper.

Moving the multifunction lever downwards (with reverse gear not engaged) activates/deactivates the intermittent operation (with actuating frequency of about 3 seconds) of the rear window wiper, regardless of the movement of the windscreen wiper. Pushing the button on the right multifunction lever, the rear wiper will start cleaning the rear window without activating the washer jet until the button is pressed again.

Smart Clock

To configure the digital clock located on the center of the dashboard between the air outlets, use the Watch menu on the Comfort Display.



It is possible to choose among 3 digital clock theme (Classic, Sport and Design); other different contents can also be selected (example: Compass, Pedals,...) swiping the list on the left of the screen.



The time can be displayed also on the MIA upper status bar and on the instrument cluster display (see “Functions of Settings Menu on MIA” in this section).

Clock lighting works in the same way as instrument and controls backlighting (refer to “Interior Brightness Adjustment” in chapter "Internal Light Controls" in this section).



Air Conditioning Controls

The vehicle is equipped with an automatic dual-zone air conditioning system (🚗) that allows to adjust separately the temperature and the airflow distribution in the left and in the right zone of the passenger compartment, according to the requests of the driver and the front passenger.

A humidity sensor, positioned on the inner surface of the windshield, over the rear view mirror, allows the A/C system to prevent/eliminate fogging of the windshield and side windows.

The best efficacy in preventing fogging is obtained by selecting the "AUTO" function, described later.

A dual zone solar sensor helps to achieve the best comfort in presence of solar radiation.

There is an additional automatic zone air conditioning system (🚗) installed in the tunnel console, between the front seats. The additional zone module, can be operated by the rear passengers (see "Three-zone Climate Control" in this chapter), by means of the control panel at the end of central tunnel, but also by the front passengers entering the Rear menu on the Comfort Display.



Dual Zone Climate Controls

This system can be operated by using the Climate main page of the Comfort Display.

Description of Controls

All described functions can be set and modified using the soft-keys on the Comfort Display.

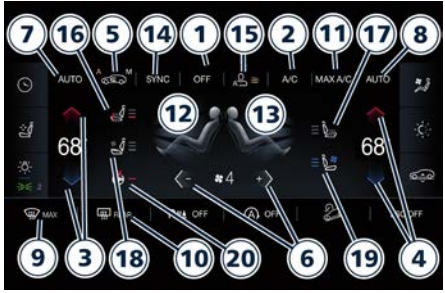

1. Climate control on/off

Touch the "OFF" soft-key to switch the climate control off.

NOTE:

For vehicles equipped with Remote Start, the Air Conditioning System will not function during Remote Start operation if the climate control is left in "OFF".

The menu will switch on again touching the soft-key indicated in picture.



2. A/C

Touch the "A/C" soft-key to change the current air conditioning setting; the soft-key illuminates when the A/C is on.

3. Driver temperature control

Provides the driver with independent temperature control. Touch the blue ∨ soft-key for cooler temperature.

Touch the red ^ soft-key for warmer temperature. Between the arrows, the current temperature is displayed

**NOTE:**

In “SYNC” mode, this control will also automatically and simultaneously adjust the passenger temperature.

4. Passenger temperature control

Provides the passenger with independent temperature control.

Touch the \checkmark soft-key for cooler temperature. Touch the \wedge soft-key for warmer temperature. Between the arrows, the current temperature is displayed.

NOTE:

Pressing the 4 button/soft-key while in “SYNC” mode will automatically exit “SYNC” and it is possible to adjust the temperature on the passenger side.

5. Recirculation

Press to change the current setting, the relevant soft-key illuminates to indicate which recirculation function is activated. For further details, see paragraph “Dual zone Climate Control Functions” in this chapter.

6. Blower control

Blower control is used to adjust the amount of air forced through the climate system. Eight levels of blower speed can be selected. Adjusting the blower will cause automatic mode to switch to manual.

Touch the $-$ or $+$ arrow to select the blower speed you want to set.

7-8. AUTO

This function automatically controls the interior temperature by adjusting the air flow rate and the air distribution respectively on the driver and on the passenger zone. Press “AUTO” to switch the ATC between manual and automatic mode. The “AUTO” soft-key illuminates in amber when the automatic function is activated. See “Automatic Temperature Control (ATC)” in this chapter for more information.

9. MAX defrosting/demisting

Press the soft-key to switch the airflow setting to the windshield and the front side windows to get quick defrosting/defogging. The soft-key illuminates in amber when this function is activated. Operating this function will cause the ATC to switch into manual mode: the “AUTO” soft-key will turn off. With engine off, the blower will run at minimum speed (level 1) and can be increased manually: with engine on, the blower speed will gradually increase to the higher speed (level 8). MAX defrosting/demisting shall also involve REAR defrosting/demisting function. If this function is turned off the climate system will return to the previous setting.

10. REAR defrosting/demisting

Press the soft-key to turn on the rear window defroster and the heated outside mirrors. The soft-key will illuminate in amber when the rear window defroster and the heated external mirrors are on. The rear window defroster and the heated external mirrors automatically turn off after 10 minutes. For any subsequent request after the first one (in the current ignition cycle), the system activates the function for 5 minutes. The timing described above is automatically reset and the defrost/demisting function is deactivated at each key-off.

**CAUTION!**

Failure to observe the following cautions may cause damage to the rear windows defroster:

- Use care when washing the inside of the rear window. Do not use abrasive window cleaners on the interior surface of the window. Use a soft cloth and a mild washing solution, wiping parallel to the heating elements. Labels can be peeled off after soaking with warm water.



- Do not use scrapers, sharp instruments, or abrasive window cleaners on the interior surface of the window.
- Keep all objects inside the vehicle at a safe distance from the window.

11. MAX A/C

By pressing the “MAX A/C” soft-key, the system automatically switches to get the maximum cold air flow in both zones.

12-13 Air flow distribution modes

The airflow distribution mode, respectively on the driver and on the passenger zone, can be adjusted so air comes from the dashboard vents, vents under the dashboard in direction of the floor, demist/defrost vents and vents under the front seats and adjustable vents at the rear end of the central tunnel for the rear passengers only.

The Comfort Display shows the relevant soft-keys to set these modes individually for each zone.

Available settings are as follows:

- **“Dashboard” mode** 

Air for each zone flows from four adjustable vents of the dashboard and two positioned at the rear end of the central tunnel. Each of these vents can be singly adjusted. The air grids or vanes of the vents can be moved to adjust air flow direction. A setting

wheel, placed near each vent, allows to regulate or close the airflow.

- **“Bi-Level” mode** 

Air for each zone flows from the dashboard and central tunnel adjustable vents and from the fixed floor vents described in "Floor" mode.

NOTE:

Bi-Level mode is designed to let cooler air come in the dashboard and rear part of the central console vents and warmer air from the floor vents.

- **“Floor” mode** 

Air for each zone flows from the fixed front vents, located under the dashboard, and under the front seats for the rear passengers. A small portion of the airflow is directed through the defrost/demist vents to prevent windows fogging.

- **“Mix” mode** 

Air for each zone flows from the defrost/demist vent, the fixed vent under the dashboard and which from floor vent described in "Floor" mode. This mode is recommended for cold climates, to improve comfort and prevent windows fogging.

- **“Defrost” mode** 

Air for each zone flows from the dashboard defrost/demist vents to prevent windows fogging.

- **“Hi-Level” mode** 

Air for each zone flows from the dashboard defrost/demist vents, from the dashboard and central tunnel adjustable vents.

- **“Tri-Level” mode** 

Air for each zone flows from all the adjustable/fixed and defrost/demist vents and from the fixed floor vents described in "Floor" mode.

14. “SYNC” mode

Touch the “SYNC” soft-key on the Comfort Display to switch the Sync function on/off. The “SYNC” soft-key illuminates in amber when this function is selected. This function is used to synchronize the passenger temperature setting with the driver temperature setting.

Changing the passenger temperature setting while in “SYNC” will automatically exit this function.

15. Climate air flow

With AUTO function on, the air flow can be set in three different ways: Intense, Normal and Gentle.

16. Driver's heated seat (if equipped)

Touch the soft-key on the Comfort Display to activate the seat heating. The seat is provided with three levels of heating. Every level is represented by the number of arrows on the seat image and red lines nearby.



Select the level of seat heating by touching more than once the soft key.

17. Passenger's heated seat (if equipped)

Touch the soft-key on the Comfort Display to activate the seat heating. The seat is provided with three levels of heating. Every level is represented by the number of arrows on the seat image and red lines nearby.

Select the level of seat heating by touching more than once the soft key.

18. Driver's ventilated seat (if equipped)

Touch the soft-key on the Comfort Display to activate the seat ventilation. The seat is provided with three levels of ventilation. Every level is represented by the number of arrows on the seat image and blue lines nearby.

Select the level of seat ventilation by touching more than once the soft key.

19. Passenger's ventilated seat (if equipped)

Touch the soft-key on the Comfort Display to activate the seat ventilation. The seat is provided with three levels of ventilation. Every level is represented by the number of arrows on the seat image and blue lines nearby.

Select the level of seat ventilation by touching more than once the soft key.

20. Heated steering wheel (if equipped)

Touch the soft-key on the Comfort Display to activate the steering wheel heating. The steering wheel is provided with one level of heating represented by a red line nearby.

Dual Zone Climate Control Functions

Air Conditioning (A/C)

The "A/C" soft-key allows to manually activate or deactivate the air conditioning system. When the air conditioning system is turned on, cool dehumidified air will flow through the vents into the cabin. For improved fuel economy, touch the "A/C" soft-key to turn off the air conditioning and manually adjust the blower and airflow mode settings.

When the A/C and automatic functions are switched off it is not possible to have air at a lower temperature than the outside.

Recirculation and Air Quality Sensor (AQS)

When outside air contains smoke, odors, or high humidity, or if rapid cooling is desired, you may wish to recirculate interior air by pressing the recirculation soft-key to activate the two different functionalities.

The recirculation function, that allows to open/close the A/C air inlet by operating

the soft-key, is integrated with the Air Quality Sensor.

This sensor, positioned upstream of the A/C filter, in front of the air intake of the A/C system, detects the presence of polluting substances and submits an electric signal to the A/C control unit, that closes the intake of the external air by activating the air recirculation. The soft-key can therefore enable 3 operating modes, switchable in sequence: "Auto", "Manual" and "Open". Starting from the outside air condition ("Open" mode) with soft-key not colored in amber, in which the external air is aspirated by the A/C system and treated to be introduced into the passenger compartment, subsequent actuations of the soft-key change the state as follows.

- First press - "Auto" mode : the A/C system activates the automatic recirculation control by using the signal transmitted from the AQS. The Comfort Display soft-key with the symbol "A" in white illuminates in amber
- Second press - "Manual" mode: the A/C system activates the recirculation, the soft-key with the symbol "M" in white illuminates in amber. The A/C system will stay this way up to a new actuation, or until the increased humidity could lead to windshield



fogging: in this case the recirculation automatically switches to external air.

- Third press - "Open" mode: the A/C system switches back to external air (default operating mode).

The next press of the soft-key restarts the operating cycle just described.

NOTE:

To avoid the risk of fogging, the AQS is disabled when the external temperature falls below 35 °F (2 °C).



NOTE:

In cold weather, use of recirculation mode may lead to window fogging. Select the MIX mode and increase the blower speed to prevent fogging.

MAX A/C

Activating this function, the system switches to exit automatic mode and enter A/C and recirculation functions. The minimum temperature (LO) in both zones, the maximum blower speed and

the "Dashboard" air distribution mode → are also selected.

The blower speed can be adjusted without exiting "MAX A/C". To exit "MAX A/C" touch the relevant Comfort Display soft-key or exit A/C or recirculation functions.

Selecting "MAX", "AUTO", or "OFF", will also exit "MAX A/C".

Automatic Temperature Control (ATC)

Automatic operation

The system activates automatic mode in the following ways:

- Press the "AUTO" soft-key of driver and/or passenger zone on the relevant soft-key button on the Comfort Display. The text "Auto" will appear inside the area usually occupied by the blower speeds.



- Set the desired temperature adjusting the driver and/or passenger

temperature control buttons or soft-keys. The system automatically work to maintain the best comfort level inside the passengers compartment.

- When the system is set up for your comfort level, it is not necessary to change the settings anymore, simply allow the system to function automatically.
- To provide you with maximum comfort in the automatic mode, during cold start-ups the blower speed will remain low until the engine warms up.
- AUTO mode can be deactivated by operating any airflow or blower controls and by pressing "AUTO", "A/C", "MAX AC", "MAX" or "OFF" soft-key.

Manual operation

The system allows manual selection of blower speed, air distribution mode, A/C status and recirculation control. The blower fan speed can be set to any fixed speed by using the blower control. In this case the blower will operate at a fixed speed until a different speed is selected. This allows the front occupants to control the volume of air circulated in the vehicle exiting the automatic mode. The user can also choose the direction of the airflow by selecting one of the available mode settings. A/C operation,



recirculation control and SYNC mode can also be manually selected.

Three-Zone Climate Controls (↔)

Air conditioning controls that allow rear passengers to adjust the temperature in the rear part of the passenger compartment are located at the rear end of the central tunnel above the adjustable air outlets.



Description of Controls

The following functions can be operated/adjusted by using the rear climate control panel.

1. Rear climate control on/off

Press the OFF icon to switch the rear climate control on/off. The LED on the button turns on when the rear A/C is off.



2. Rear display

In this centered display on the rear climate control panel, the current set temperature and blower speed are displayed.

3. temperature control

Provides the rear passengers with independent temperature control. Push the blue arrow for cooler temperature settings or the red arrow for warmer temperature; it is also possible to change the temperature swiping on the bars between the arrows. The set temperature value will be displayed in the centered rear display.

4. Lock item

This item illuminates in a white color when the rear climate controls are locked from the climate controls on the Comfort Display.

See Three-Zone Climate Control by the Driver in this chapter.

5. Blower control

Blower control is used to regulate the airflow of the rear climate system. There are eight blower speeds available. Adjusting the blower will cause the automatic mode to switch to manual. Press the “+” icon to increase blower speed.

Press the “-” icon for lower speed. It is also possible to change the blower speed swiping on the bars between the arrows.

Airflow distribution modes

The airflow distribution can be adjusted to let air come in from the adjustable and fixed central tunnel vents and floor vents. The set mode is recognizable through the lighting of the soft-key on the climate control panel.

6. “Bi-Level” mode

Air comes from the adjustable vents on the rear central tunnel and from the fixed ones under the front seats.

NOTE:

The Bi-Level mode is designed to provide comfort by sending cooler air out of the central tunnel vents and warmer air from the floor vents.

7. Left passenger heated seat (if equipped)

Touch the soft-key on the Rear Climate Control Panel to activate the seat



heating. The seat is provided with three levels of heating. Every level is represented by the number of arrows on the seat image and red lines nearby. Select the level of seat heating by touching more than once the soft key.

8. Right passenger heated seat (if equipped)

Touch the soft-key on the Rear Climate Control Panel to activate the seat heating. The seat is provided with three levels of heating. Every level is represented by the number of arrows on the seat image and red lines nearby. Select the level of seat heating by touching more than once the soft key.

9. AUTO

This function automatically controls the interior temperature by adjusting the air flow rate and the air distribution.

- Press the “AUTO” button: the automatic rear climate control switches from manual to automatic mode and vice-versa. The “AUTO” LED on the rear climate control panel illuminates when this function is activated.
- Adjust then the temperature you wish to maintain by regulating the temperature arrows. Once the desired temperature is set, the system will achieve and automatically maintain that comfort level.

- When the system is set up for your comfort level, it is not necessary to change the settings anymore: simply allow the system to function automatically.

To provide you with maximum comfort in the automatic mode, during cold start-ups the blower speed will remain low until the engine warms up.

NOTE:

If a fail of the three-zone climate controls panel occurs, one or more leds, except the rear display, will switch off. In this case, contact an Authorized Maserati Dealer.

Three-Zone Climate Control by the Driver

When the car is equipped with the additional three-zone module in the Comfort Display is present a Rear Menu on the side bars.

Once you have entered the rear menu, by touching the following soft-keys, the driver is able to:

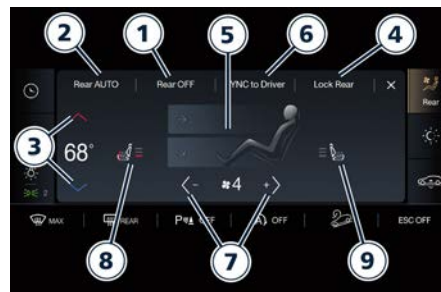

- 1 Turn off / re-activate the rear climate setting
- 2 The system switch the ATC between manual and automatic mode by controlling the interior temperature (controls 3) by adjusting the air flow rate and the air distribution (controls 5) of the rear passengers.
- 3 Adjust the temperature in the rear zone in the indicated mode for the front zones.
- 4 Block the settings of the rear climate
- 5 Set the airflow distribution in “Torso”, “Bi-Level” or “Floor” mode.
- 6 Synchronise the rear passenger temperature setting with the same one of the driver. If the driver adjust the temperature while SYNC mode is on, this will affect the rear passenger temperature. If the front or rear passengers adjust the



temperature setting the system automatically break the function and turn it off.

- 7 Set the blower speed through eight speed levels.
- 8 Left passenger heated seat (if equipped): Touch the soft-key to activate the seat heating. The seat is provided with three level of heating. Every level is represented by the number of arrows on the seat image and red lines nearby. Select the level of seat heating by touching more than once the soft key.
- 9 Right passenger heated seat (if equipped): Touch the soft-key to activate the seat heating. The seat is provided with three level of heating. Every level is represented by the number of arrows on the seat image and red lines nearby. Select the level of seat heating by touching more than once the soft key.

Operating Tips

- Continuous use of the air recirculation in winter, in rainy weather or humid climate is not recommended because it may cause window fogging.
- Interior fogging on the windshield can be quickly removed by fast defrosting/demisting. The “Mix”

mode can be used to maintain a clear windshield and provide sufficient heating. If side window fogging becomes a problem increase blower speed.

NOTE:

- **Recirculation mode without A/C should not be used for long periods of time, as fogging may occur.**
- **If inside the passenger compartment there are conditions of high temperature and humidity, when the A/C compressor is switched on there may be some cold steam at ventilation port outlet: this situation is normal and does not indicate air conditioning system malfunction.**
- **Automatic Temperature Controls (ATC) will automatically adjust the climate control settings to reduce or eliminate window fogging on the front windshield.**
- Make sure the external air intake grille, located directly in front of the windshield, is free of obstructions such as leaves or other objects. Leaves collected in the air intake may reduce airflow, and if they enter the plenum, they could plug the water drains. In winter make sure the air intake is clear of ice, slush, and snow.
- The temperature can be displayed in Metric or US units by selecting

the “Units” customer programmable function. See “Functions of Settings Menu on MIA” in this section.

- Any time you store your vehicle or keep it stationary (i.e., during vacation) for two weeks or more, run the air conditioning system at idle for about five minutes in the fresh air by high blower setting. This will ensure adequate system lubrication and minimize the possibility of compressor damage when the system is started again.



A/C Filter

The climate control system filters outside air containing dust, pollen and some odours. Strong odours cannot be totally removed from by A/C filter at the entrance of the air climate system. See “Maintenance Procedures” in section “Maintenance and Care” for filter replacement instructions.





5 - Starting and Driving

Normal Starting of the Engine	154
Remote Start System	156
Automatic Start&Stop System	157
Automatic Transmission	160
All-Wheel Drive	168
Drive Mode	169
Setting Ride Height 	172
Launch Control Mode (TROFEO version only)	175
Off-Road Drive	177
Parking Brake	180
Using the Brakes	183
Use of the Engine	184
Refueling	186
Driving Conditions	188
Trailer Towing 	190



Normal Starting of the Engine



WARNING!

It is dangerous to run the engine in an enclosed area. The engine consumes oxygen and discharges carbon dioxide, carbon monoxide and other toxic gases in the atmosphere.

When doors are opened, the instrument cluster displays the model logo in the center and the complete odometer plus the open doors indicator  in the lower right part of the cluster.



Before starting the engine, close the doors, adjust your seat, the inside and outside mirrors, fasten your seat belt and instruct all other occupants to buckle their seat belts.

The transmission must be in P (Park) or N (Neutral) mode before you can start the

engine. Apply the brakes before shifting into any driving gear (see “Automatic Transmission” in this section).



CAUTION!

- Before starting the engine, switch off the electrical devices with a high power consumption (air-conditioning and heating system, heated rear window, headlights, etc.).
- Do not start the engine if the fuel level in the tank is low.

The keyless ignition allows the driver to operate the ignition device by pushing the center button, as long as the key fob is within the passenger compartment (check “Keys” in section “Before Starting” for further information).

By pressing the brake pedal and pushing the **START/STOP** button the engine starts. Instrument cluster displays the initial sequence with warning light and analogue instruments test routine and switch-on of the engine temperature indicators and fuel level.

The current display subsequently sets up with the latest screenshot.

If the engine fails to start, the starter will disengage automatically after 10 seconds. If you wish to stop the cranking of the engine prior to starting it, press the button again.

NOTE:

Normal starting of either a cold or a warm engine is obtained without pumping or pressing the accelerator pedal.

Pressing again the **START/STOP** button the ignition device returns to **OFF** position and the display powers down. Pressing further the **START/STOP** button the screen will display the message that invites you to press the brake pedal and push the **START/STOP** button to start the engine.



NOTE:

If the ignition device is left in the **ON** position and the transmission is in P (Park) mode, the system will automatically time out after 30 minutes of inactivity and the ignition device will switch to the **STOP** position.



After starting the engine, the idle speed is controlled automatically and will decrease as the engine warms up.

Engine Start Failure



CAUTION!

- Do not attempt to push or tow your vehicle to get it started. Vehicles equipped with an automatic transmission cannot be started this way. Moreover, unburned fuel could enter the catalytic converter and once the engine has started, ignite and damage the converter and vehicle.
- If the vehicle has a discharged battery, booster cables may be used to obtain a start from a booster battery or the battery in another vehicle. This type of start can be dangerous if done improperly. See "Auxiliary Jump Start Procedure" in section "In an Emergency" for further information.

Flooded Engine Clearing

If the engine fails to start after you have followed the described procedures, it may be flooded. To clear any excess fuel, move the transmission in P (Park) mode. Press and hold the brake pedal, push the accelerator all the way to the floor and hold it, then press and release the **START/STOP** button once. The starter will engage automatically, run

for 10 seconds, and then disengage.

Once this occurs, release the accelerator pedal and the brake pedal, wait 10 to 15 seconds, then repeat the normal starting of the engine procedure.

Driving with a Cold Engine

Start-off slowly, avoiding sudden acceleration and rev the engine up at low medium speeds. High-performance driving should be avoided until the engine temperature reaches 149-158°F (65-70°C).

Engine Turn Off

- With the transmission in P (Park), D (Drive) or R (Reverse) mode (see "Automatic Transmission" in this section) and vehicle standstill, press and release the **START/STOP** button to switch off the engine. A burst on the accelerator pedal before turning off the engine has no purpose and increases fuel consumption.
- If the transmission is in N (Neutral) mode and the **START/STOP** button is pressed once, the instrument cluster will display a "Vehicle Not in Park" message and the ignition will remain ON (CarWash mode).



WARNING!

Never leave a vehicle without confirming the P (Park) mode; it could move and cause injuries to people nearby.

NOTE:

If the ignition device is left in the **ON** position and the transmission is in P (Park) mode, the system will automatically time out after 30 minutes of inactivity and the ignition device will switch to **STOP** position.

Engine Turn Off when in Automatic Start&Stop

When the engine has been turned off by the Start&Stop system, press and release the **START/STOP** button. The ignition device will return to the **STOP** position and the vehicle is off.

"Panic Stop" Strategy

In panic conditions, with engine running, the "Panic Stop" strategy can manage the situation stopping the engine in the following modes:

- Quickly pushing 3 times or one long press of the **START/STOP** button.
- The engine stops and the transmission moves in N (Neutral) mode under specific RPM. When in stop conditions, the gearbox moves automatically in P (Park) mode.



Remote Start System

This system enables the Maserati Connect App to start the engine conveniently from outside the vehicle while still maintaining security.

NOTE:

Changes or modifications not expressly approved by the party responsible for compliance could void the user's authority to operate the equipment.

How to use Remote Start

All of the following conditions must be met before the engine will remote start:

- System not disabled from previous remote start event.
 - Vehicle theft alarm not active.
 - Doors closed.
 - Hood closed.
 - Liftgate closed.
 - Hazard lights switched off.
 - Brake pedal not pressed by any passenger remained in the vehicle.
 - Battery at an acceptable charge level.
 - The transmission is in P (Park) or (D) mode.
 - The remote start has not been activated yet two consecutive times.
- If EPB (Electric Parking Brake) is not inserted, at key-off in some conditions the remote start system may not allow engine to start. We suggest to set "Auto Park On" function through the MIA screen (see chapter "Functions

of Settings Menu on MIA" in section "Instruments and Controls").



WARNING!

Do not start or run an engine in a closed garage or confined area. Exhaust gas contains Carbon Monoxide (CO) which is odorless and colorless.

Engine Remote Start Abort Message on Instrument Cluster

The following messages will display on the instrument cluster if the vehicle fails to remote start or exits remote start prematurely:

- "Remote Start Canceled Door Open".
- "Remote Start Canceled Liftgate Open".
- "Remote Start Canceled Fuel Low".
- "Remote Start Canceled Time Expired".
- "Remote Start Disabled Start Vehicle to Reset".
- "Remote Start Canceled Bonnet Open".
- "Remote Start Canceled Battery Conditioning".

The message on the instrument cluster stays active as long as the ignition device is in **ON** position.

To enter Remote Start Mode

Press and release the Remote Start soft-key on the Maserati Connect App twice within five seconds. The vehicle doors will lock, position lights

will flash and the horn will ring twice (if the "Sound Horn with Remote Start" function of the "Doors & Locks" submenu is activate using the MIA system, refer to "Functions of Settings Menu on MIA" in section "Dashboard Instruments and Controls"). Then, the engine will start and the vehicle will remain in the "Remote Start" mode for a 15-minute cycle.

NOTE:

- In case of an engine fault or low fuel level, the vehicle will start and then shut down in 10 seconds.
- The park lights will turn on and remain lighted up during "Remote Start" mode.
- For security reasons, power window and power sunroof operation (if equipped) are disabled when the vehicle is in the "Remote Start" mode.
- The engine can be started two consecutive times (two 15-minute cycles) with the Maserati Connect App. However, the ignition device must be cycled to **ON** position before you can repeat the start sequence for a third cycle.

To exit Remote Start Mode without Driving the Vehicle

Press and release the Remote Start soft-key on the Maserati Connect App one time or allow the engine to run for the entire 15-minute cycle.

**NOTE:**

To avoid unintentional shutdowns, the system will disable the one time press of the soft-key on the Maserati Connect App for two seconds after receiving a valid "Remote Start" request.

To exit Remote Start Mode and Drive the Vehicle

Before the end of the 15-minute cycle, press and release the button  on the key fob to unlock the doors and disarm the vehicle security alarm. Then, prior to the end of the 15-minute cycle, press and release the **START/STOP** button.

NOTE:

The message "Remote Start ON Push Start Button" will display in the instrument cluster until you push the **START/STOP** button.

Driver's Seat Comfort with Remote Start

The driver's heated and ventilated seat and the heated steering wheel (if foreseen) can be programmed to come on during a remote start. Refer to "Auto-on Comfort" function of the "Seats & Comfort" submenu in the "Settings" page (see chapter "Functions of Settings Menu on MIA" of section "Dashboard Instruments and Controls" for further information).

Radio Frequency RKE Transmitter - Regulatory Information

The "Regulatory Information" for all the radio frequency and radar devices can be consulted by accessing the section "Services" on the website www.maserati.com.

Automatic Start&Stop System

The Maserati Start&Stop system allows the engine to automatically switch off when the vehicle stops and to restart when the driver intends to drive. This function helps reduce fuel consumption. During the "Stop (AutoStop)" phase the ignition is still on and all security functions are available. In order for the Start&Stop to activate, the vehicle must be stationary and the brake pedal adequately pressed.

NOTE:

If the brake pedal is not sufficiently pressed the Start&Stop may not function even if the vehicle is stopped.

When the Start&Stop switches off the engine, the related light  illuminates on the instrument cluster.

As soon as the brake pedal is released, the engine turns on.

While the vehicle is stopped, the transmission can be placed in P (Park) pressing the "P" button on the dashboard. Releasing the brake pedal will cause a re crank of the engine.

(Continued)



Starting and Driving

NOTE:

When the EPB is engaged, the "AutoStop" condition will work without pressing the brake pedal.

Pressing the brake pedal and shifting transmission into D (Drive) or R (Reverse) mode will deactivate the "AutoStop" condition and restart the engine.



Start&Stop Deactivated

Start&Stop function is deactivated under the following conditions:

- When SPORT, CORSA or OFF ROAD (if available) drive mode is activated.
- If it has been disabled through the Comfort Display by pressing the "  OFF" soft-key on the bottom bar.

Start&Stop Not Active

For keeping driving safety, interior comfort and a correct functioning of engine and vehicle, the Start&Stop

function does not activate under the following conditions:

- When the driver's seat belt is unbuckled.
- When the driver door is open.
- When the vehicle is stopped on a very steep road.
- When the vehicle is stopped with steered wheels (over 135° of steering wheel angle for each part).
- When the vehicle is maneuvering: transmission in R (Reverse) mode.
- When the temperature conditions inside the vehicle do not correspond to the air conditioning setting.
- When the front and rear "defroster" function is activated.
- When the engine coolant and the engine oil temperature is not on proper functioning level.
- When the external temperature is too cold.
- When the battery charge is below safety value.
- When the previous stop had just happened (few seconds) and the minimum speed has not yet been achieved.
- Shortly after R (Reverse) mode has been set or when driving under a certain speed level.
- When the hood is open.
- The sensors managing the Start&Stop have been damaged.

- Start&Stop system faults are present.

Automatic Restarting of the Engine

The engine may automatically restart, before the brake pedal has been released, when one of the following conditions occurs:

- The SPORT drive mode is being activated.
- If the Start&Stop function has been disabled through the Start&Stop soft-key on the Comfort Display.
- If transmission is moved to R (Reverse) mode.
- If the steering wheel is moved to steer the wheels.
- When the temperature conditions inside the vehicle do not correspond to the air conditioning setting.
- When changing the temperature setting on the air conditioning.
- When the defroster function is being activated.
- When the battery charge is below safety value.
- When the accelerator pedal is being pressed (together with the brake pedal).
- If a long time has passed since the last automatic stop of the engine.

Occupants Safety Function

To enhance occupants safety, the Start&Stop system monitors if the driver is present and does not allow automatic restarting of the engine if one of the following maneuvers is being performed while in “AutoStop” condition:

- The driver opens the door and releases the brake pedal.
- The driver opens the door and unbuckles the seat belt.
- The driver opens the hood.

All the above-mentioned conditions deactivate the Start&Stop function (the “AutoStart” is deactivated and the engine remains off) and the transmission shift automatically in P (Park) mode.

The telltale will be disabled to indicate the Start&Stop function disabling. To restart the engine it is necessary to press the brake pedal and push the **START/STOP** button or shift into gear.

Push the D (Drive) button to drive away.



WARNING!

Even when the vehicle is stopped within the “Stop (AutoStop)” phase, the vehicle driver is responsible for the vehicle, the vehicle’s occupants and the vehicle’s surrounding area. Never leave the

vehicle unattended with the engine running; doing so poses a risk of danger. It is a good practice to always ensure to set the parking brake and place the transmission gear selector lever into the P (Park) position, thereby ensuring the vehicle will not move, when performing any vehicle checks, maintenance and/or service procedures on the vehicle.

Start&Stop Function Disabling

Start&Stop enabled is the default status. Under certain driving conditions, when frequent stops and restarts of the engine may become annoying, it is possible to turn off the Start&Stop function.

When the Start&Stop function is turned off in the all following ways, the white indicator on the cluster display indicated in the picture will turn on.

Touch the OFF on the bottom bar of the screen of the Comfort Display. Touch a second time the same soft-key to re-enable the function

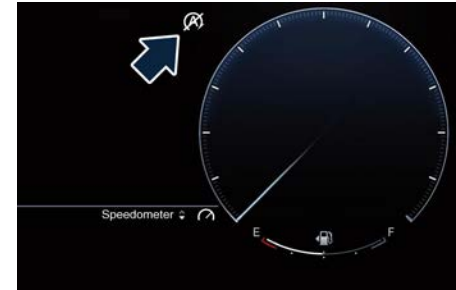

NOTE:

The highlighted and yellow soft-key indicates the disabled status of Start&Stop system and vice versa.



If the driving conditions allow it, the user can re-enable the Start&Stop function at any time.

Start&Stop System Failure

When the warning light and the related message illuminate on the cluster display (see chapter “Warning and Indicator Lights” in section “Dashboard



Instruments and Controls”) there is a malfunction in the Start&Stop system and the engine cannot be switched off and restarted automatically. To switch off or restart the engine it is necessary to push the **START/STOP**. Have the vehicle checked at an **Authorized Maserati Dealer**.

Automatic Transmission

The vehicle is equipped with an electronically controlled 8-speed automatic transmission, which automatically changes gear according to the vehicle's instantaneous usage parameters (vehicle speed, road gradient and accelerator pedal position).

It is possible to change gear manually pressing the "D/M" (Drive/Manual) button and using the shifting paddles (+/-).

The four button on the dashboard, between the two central screens, replaces the conventional mechanical lever and has no mechanical connection to the transmission. The transmission is operated by electrical actuators on the hydraulic system and all commands to the control system are transmitted by the CAN network.

The electronically-controlled transmission provides a precise shift schedule. The transmission electronics are self-calibrating, therefore the gearshift behavior could become perfect as expected after few hundreds of km.

NOTE:

Entering the car, pressing the ignition device in ON position, the engaged gear shift button LED will turn on.



CAUTION!

In order to properly use the automatic transmission, it is essential that you read through the whole chapter, so that you can understand right from the start what the correct and granted operations are. Damage to the transmission may occur if the following precautions are not observed:

- Shift into P (Park) only after the vehicle has come to a complete stop: this is the default gear mode. After engaged P (Park) it is possible set the ignition device to **OFF**.
- Shift into or out of R (Reverse) only after the vehicle has come to a complete stop and the engine is at idle speed.
- Do not shift between P (Park), R (Reverse), N (Neutral) or D (Drive) when the engine is above idle speed.
- To effect any change from vehicle stop to P (Park), N (Neutral), it is necessary to keep the brake pedal fully depressed.

**WARNING!**

- It is dangerous to move the shift lever out of P (Park) or N (Neutral) if the engine speed is higher than idle speed. Only shift into gear when the engine is idling normally and when your foot is firmly pressing on the brake pedal.
- As with all vehicles, you should never exit a vehicle while the engine is running. Before exiting a vehicle, always apply the electronic parking brake, shift the transmission into P (Park), and turn the engine off.
- When leaving the vehicle, always remove the key fob and lock your vehicle.
- Do not leave the key fob in or near the vehicle.

This vehicle is equipped with a function which requires the transmission to be placed in P (Park) before the engine can be turned off. This prevents the driver from inadvertently leaving the vehicle without having placed the transmission in P (Park). This system also locks the transmission in P (Park) whenever the ignition device is in the **STOP** position.

Automatic Transmission "Pulse Activation" Buttons

Automatic transmission is operated by four gear shift "pulse activation" buttons,

located on the dashboard, between the two central screens which can have the following operating positions:

- P (Park)
- R (Reverse);
- N (Neutral);
- D/M (Drive; Manual)

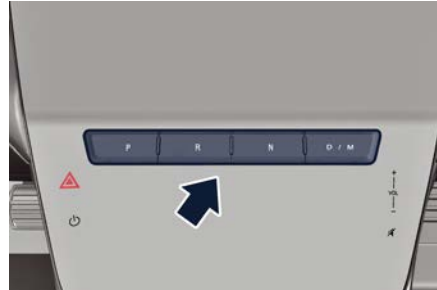
**NOTE:**

If all button LEDs are lit when the ignition device is in **ON** position, contact an **Authorized Maserati Dealer**.

Transmission status is visible on the central bottom left part of the instrument cluster display, except in Corsa mode, where it is located in the center.

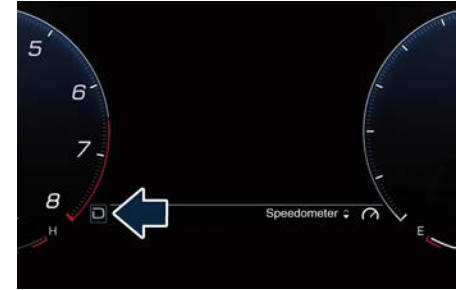
**To Engage a Mode (briefly)**

To select one of the operating modes, press one of the buttons previously indicated and press the brake pedal at the same time.

NOTE:

The engaged gear "pulse activation" button is also illuminated more than the other ones on the dashboard.

To engage "P" mode, driver must press the "P" button.

In order to engage "R" or "D" mode, driver have to push the related button on the dashboard.

- To engage the N (Neutral) mode from R (Reverse) or D (Drive) mode, the driver has to push the button.
- Normally, to engage R (Reverse) mode, press the related button.
- To pass from P (Park) mode directly to D (Drive) mode, press the brake pedal and the D (Drive) button.



Starting and Driving

- Normally, to pass from R (Reverse) mode directly to D (Drive) mode and vice versa, press the related button.
- The P (Park) mode can be automatically enabled by pressing the “P” button.
- To exit P (Park) mode, or to pass from N (Neutral) to D (Drive) or R (Reverse) position when the car is stopped or is moving at a low speed, press the brake pedal.



CAUTION!

- **DO NOT accelerate while shifting from P (Park) or N (Neutral) to another mode.**
- **After selecting a transmission mode, wait a few seconds before accelerating. This precaution is particularly important with a cold engine.**

Transmission Status on the Instrument Cluster Display

The current gear is displayed and enhanced on the instrument cluster in an area that changes according to the visualization layout:

- central bottom left side in Classic, Evolved and Relaxed layout
- central position in Corsa mode

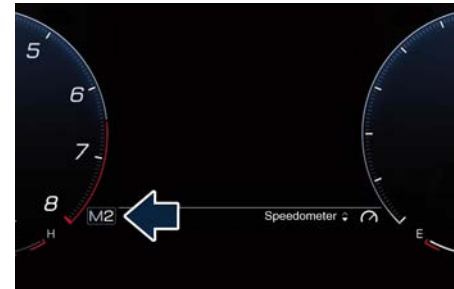
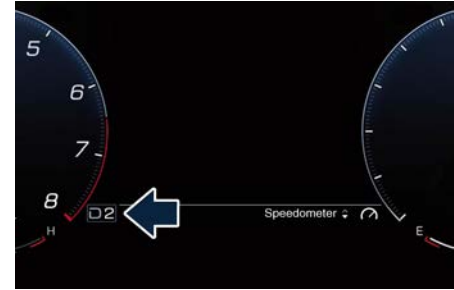
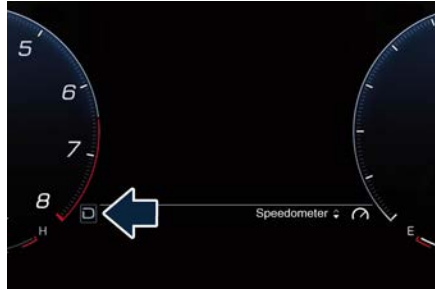

If the vehicle is in D (Drive) status, in M (Manual) or temporarily in manual drive mode, the gear position is indicated beside the transmission status (“D” or “M”).

Automatic Transmission Range P (Park)

Use this position to park the vehicle. The transmission can be shifted from “P” position only with the brake pedal pressed: then push another gear shift button. To move the transmission from “P” position to any other position, the engine must be switched on or in "AutoStop" condition. The engine can be regularly started in P (Park) range. Never attempt to use P (Park) while



the vehicle is in motion. When parking on a level surface, you may press the “P” button first, and then apply the electronic parking brake by pulling the trigger upwards.



The Instrument cluster will display the related indicator light **BRAKE** (United States market) or  (Canadian market) and the message for 5 seconds.

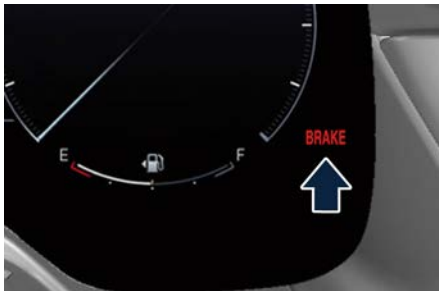

United States Market

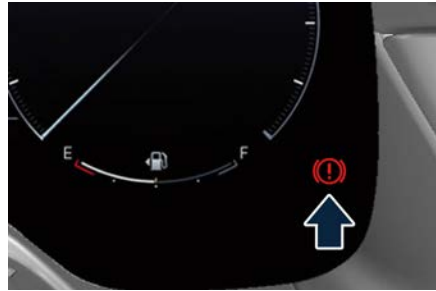

Canadian Market

When parking on a hill, apply the parking brake before pressing the “P” button. For enhanced security, turn the front wheels toward the curb on a downhill grade and away from the curb on an uphill grade.

WARNING!

- **Never use the P (Park) mode as a substitute for the electric parking brake. Always apply the parking brake fully when parked to prevent vehicle movement and possible injury or damage.**
- **Make sure the transmission is in P (Park) before leaving the vehicle.**

CAUTION!

DO NOT race the engine when shifting from P (Park) or N (Neutral) into another gear range, as this can damage the drivetrain.

The following indicators should be used to ensure that you have engaged the transmission into the “P” position:

- when shifting into P (Park), push the “P” button on the dashboard.
- with the brake pedal released, verify that “P” position is illuminated on the instrument cluster display.

R (Reverse)

This range is used to move the vehicle backward.

Switching to R (Reverse) starting from N (Neutral) is only possible if the vehicle is moving backwards. We recommend to shift into R (Reverse) only after the vehicle has come to a complete stop.

- Vehicle stationary: switching between R (Reverse) and D (Drive) requires the action on the buttons.
- Vehicle moving: the driver can switch from R (Reverse) to N (Neutral) acting on the button without pressing the brake pedal.

N (Neutral)

- Vehicle stationary and engine started: switching from N (Neutral) to P (Park)



Starting and Driving

requires "P" button pressed only. Switching from N (Neutral) to R (Reverse) and/or D (Drive) requires brake pedal.

- Vehicle moving: switching from N (Neutral) to R (Reverse) and/or D (Drive) requires pressing the action on the button. Switching to R (Reverse) starting from N (Neutral) is only possible if the vehicle is moving backwards, while switching to D (Drive) starting from N (Neutral) is only possible if the vehicle is moving forwards.

Set the parking brake and shift the transmission into P (Park) mode if you must leave the vehicle.

NOTE:

To move the car into tunnel washers, or to generally move with engine off, if foreseen use the "Car Wash" mode (see "Bodywork Maintenance and Cure" chapter in section "Maintenance and Care").



WARNING!

Do not switch to N (Neutral) or turn off the ignition to coast downhill. These are unsafe practices that limit driver's response to changing traffic or road conditions.



CAUTION!

Towing the vehicle, coasting, or driving for any other reason with the transmission in N (Neutral) can result in transmission damage. See "Towing a Disabled Vehicle" in section "In an Emergency" for further information.

D (Drive)

This range should be used for most city and highway driving. It provides the smoothest upshift and downshift and the best fuel economy. The transmission automatically shifts up and down through all gears. The D (Drive) mode provides optimum driving characteristics under all normal operating conditions of the vehicle.

- Vehicle stationary: to switch from D (Drive) to R (Reverse) requires brake pedal pressed and the action on the button: to reach N (Neutral) starting from D (Drive) is possible by only acting on the button.
- To enable special operations while the car is moving at a low speed, such as getting out of marsh or snow, it is possible to run quickly from D (Drive) to R (Reverse), and vice versa, acting on the buttons.
- Vehicle moving: switching to N (Neutral) from D (Drive) it is not necessary to press brake pedal.

- From D (Drive) selected mode it is always possible to switch to M (Manual) mode, by pressing the "D/M" button on the dashboard (see following paragraph); to return to "D" position, press again the "D/M" button. It is possible to shift from D (Drive) mode to M (Manual) mode regardless of car speed.

NOTE:

The transmission will return in D (Drive) or M (Manual) mode pressing again the "D/M" button if the transmission has been shifted in N (Neutral) or P (Park) mode in the same key cycle.

- When in D (Drive) mode, using the paddles behind the steering wheel, will cause the system to enter a temporary function and enable the manual shift mode. This range is indicated with a number that represents the current gear beside "D" letter on the cluster display. The system will then switch back to automatic mode according to time elapsed in "temporary" mode and driving conditions.

NOTE:

- To get out of "temporary" M (Manual) mode, hold the shift paddle "+".
- Holding the shift paddle "-" in "temporary" M (Manual) mode, the



transmission downshifts in the lower possible for that speed.

At extremely cold temperatures (-23°F / -30°C or below), transmission may be affected by the low temperature of the engine and transmission. Normal operation will resume once the transmission temperature has risen to a normal level.

M (Manual)

This mode is obtained by pressing the D/M (Drive/Manual) button on the central tunnel twice.

In this mode, the transmission interacts with the driver in order to allow manual shift and ensure increased control of the vehicle. The current mode allows the transmission system to optimize the engine brake action, remove undesired shifting into higher and lower gears and improve the overall performance of the vehicle.

This mode allows you to shift the transmission gear forward with the "+" shift paddle or backward with "-" paddle behind the steering wheel. The current transmission gear is displayed on the instrument cluster.



Manual mode can be activated at any time, with no need to release the brake pedal.

In M (Manual) mode, the transmission will shift up or down (+/-) if manually selected by the driver by using shift paddles on the steering wheel. The transmission remains in the engaged gear until the driver shifts into another higher or lower gear, except in the following cases.

- Lack of accelerator pedal activity will cause the transmission to revert to automatic operation. The transmission will also upshift automatically once maximum engine speed is reached.
- If in SPORT and CORSA mode, the transmission will remain in the selected gear even when maximum engine speed is reached. The transmission will upshift only if enabled by the driver. Manual upshift or downshift will be maintained as long as SPORT and

CORSA mode are selected, even by full stroke pedal press.

- If in "M" or in SPORT or CORSA mode, the transmission will automatically downshift as the vehicle slows to halt (to prevent engine lugging) and the current gear will display on the instrument cluster. Moving the right shift paddle "+" towards the steering wheel when stationary, will cause the vehicle to start in second gear. If the vehicle speed is too low, the system will ignore further upshifts. Avoid using speed control when the M (Manual) mode is engaged.

When the car stops in M (Manual) mode, the transmission automatically moves in (Park) mode.

Shift Paddles

The driver can change gears with the shift paddles behind the steering wheel when in D (Drive) and M (Manual) mode.

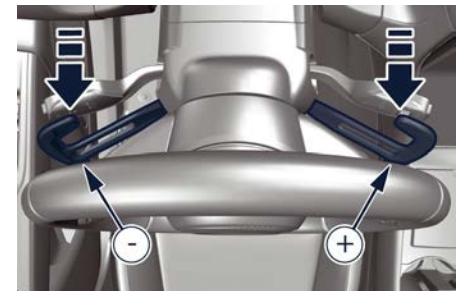



Starting and Driving

Pull the right shift paddle “+” towards the steering wheel and release it to enter the higher gear; do the same operation with the left shift paddle “-” to enter the lower gear.

- When in D (Drive) mode, by pressing “-” paddle the transmission shifts to “D1 - D2” temporary mode (or the “Launch Control” on the TROFEO version and in CORSA mode) (for first models).
- When in D (Drive) mode, by pressing “+” paddle the transmission shifts in “Launch Control” mode on the TROFEO version and in CORSA mode (for next models).

Gear Shift Indicator (GSI)

In order to improve fuel economy, we recommend that you shift gears when the GSI system prompts you to do so. This will help reduce fuel consumption without significantly affecting vehicle performance.

When in “M” (Manual) or “temporary” manual mode, GSI indicates when a gear shift is needed to change gear.

NOTE:

- Pressing R (Reverse) or P (Park) button when the vehicle is running forward will display a denial message together with the R or P letter blinking on the instrument cluster.

- Pressing “D/M” button when the vehicle is running rearward will display a denial message together with the D or M letter blinking on the instrument cluster.

GSI indicates when a gear shift is needed by adding one or two arrows beside the current gear on the cluster display.

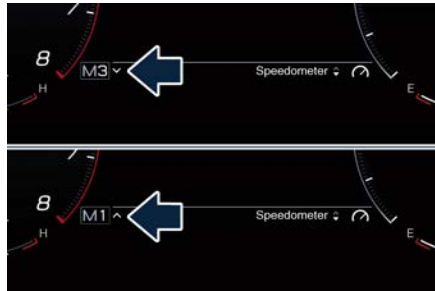

When the new gear is engaged, the GSI turns off. If the shift runs late or is not performed at all, the GSI remains lit for a few seconds then turns off. As soon as new conditions requiring further gear change occur, the GSI will illuminate again.

NOTE:

The GSI system will only work when the transmission is set in M (Manual), except when in CORSA mode.

When in CORSA mode, a sport gear SHIFT light will help the driver understanding when shifting the gear efficiently.



The graphic is composed by three slots; when it is completely filled, it suggests the performance gear shift to the user.

NOTE:

If the automatic transmission is in D (Drive) mode, the bar will always be displayed empty.

Transmission Malfunction and Overheating Conditions

Transmission Emergency Control

Transmission function is electronically monitored to detect abnormal conditions. If a condition that could result in transmission damage is detected, “Transmission Limp Home Mode” will be activated. In this situation, the transmission may operate only in certain gears, or may not shift at all.

Vehicle performance may be severely degraded and the engine may stall. In some situations, the transmission system may not re-engage if the engine is turned off and restarted.

A message in the instrument cluster will inform the driver about the more serious transmission conditions, and indicate what actions may be necessary.

Transmission Oil Over Temperature

If the transmission oil temperature exceeds the operating limit, the  amber warning light illuminates on the instrument cluster

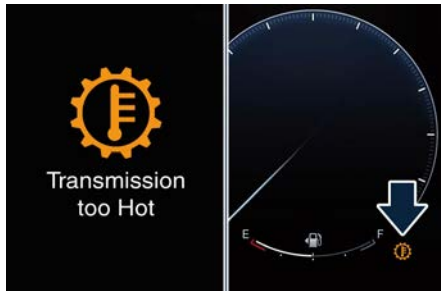

In this case, slow down until temperature returns to normal level (the light will turn off).

If this is not sufficient, we recommend to stop the vehicle, shift the transmission in P (Park) or N (Neutral) mode and keep the engine idle until the temperature warning light  turns off and the

message disappears from the display. Resume driving without demanding high engine performance.

If the warning light  and the related message turns on again, it is advisable to stop the vehicle, turn off the engine and wait for the engine/transmission assembly to fully cool down.

If the instrument cluster message indicates that the transmission may not re-engage after engine shutdown, perform the following procedure preferably at an **Authorized Maserati Dealer**.

In the event of a momentary problem, the transmission can be reset to regain all forward gears by performing the following steps.

- Stop the vehicle.
- Shift the transmission into P (Park) mode, if possible.
- Turn the engine off.
- Wait approximately 30 seconds.
- Restart the engine.
- Shift the transmission into D (Drive) mode and then into the desired gear range. If the problem is no longer detected, the transmission will return to normal operation.

NOTE:

Even if the transmission can be reset, we recommend that you visit an **Authorized**

Maserati Dealer at your earliest possible convenience, which has diagnostic equipment to determine if the problem could recur.

Transmission Manual Release of P (Park) Position

See chapter “Transmission Manual Release of P (Park) Position” in section “In an Emergency”.



All-Wheel Drive

The active on-demand All-Wheel Drive (AWD) system provides available optimum traction for a wide variety of road and off-road surface and driving conditions. The system minimizes wheel slip by automatically redirecting torque to the front and rear wheels as necessary.

To maximize fuel economy, the AWD system automatically disengages torque distribution on front axle when road and environmental conditions are such that wheel slip is unlikely to occur.

When specific road and environmental conditions require increased levels of road traction, the AWD system automatically distributes the torque between front and rear axle in order to grant the best driving experience. Torque distribution is displayed in the left dial on the instrument cluster when "Torque Management" widget is active (see "Widget Contents" in section "Dashboard Instruments and Controls").



WARNING!
There may be a slight delay for AWD engagement after a wheel slip condition occurs.



NOTE:
If the AWD system service warning message appears after engine start up, or during driving, it means that the AWD system is not functioning properly or is in recovery mode due to overheating caused by the excessive wheel spin. In this condition the vehicle can continue driving but only rear wheel drive is working. If the warning message is often activated, it is recommended to have the vehicle serviced at an **Authorized Maserati Dealer**.



Drive Mode

Controls Preview

Drive modes can be set using the selector on the steering wheel.

NOTE:

- "Comfort" is the default drive mode, optimized for the best balance between performances, fuel consumptions and emissions in the standard conditions use of the car.
- At key ON, with engine on, if any engine, transmission, brake or steering wheel failure is prompted on the instrument cluster, it is not possible to change drive mode; Comfort Mode is the only one available.

Drive modes are selectable only with the engine on.



With the selector on the steering wheel, you can choose the following drive modes:

- OFF ROAD (with air suspension only): to activate/deactivate the specific driving mode for off road conditions (uphill/downhill, cobblestone, mud, grass and sand). In this mode, the vehicle has a specific ESC/ASR calibration and shock absorbers skyhook damping curve. Activating this drive mode, will also change the EPS setting. When in "OFF ROAD" drive mode, hard suspension cannot be set through the button on the central console.
- COMFORT: to activate/deactivate the drive mode to ensure increased control on slippery surfaces as well as higher energy efficiency.
- GT: to activate a comfortable drive mode. In this mode, performance and comfort meet. It allows for smooth shifting and smooth suspension making its impressive strength easily steerable. Ideal for everyday driving, it offers unstoppable grand tourer comfort.
- SPORT: to activate/deactivate a sportier drive mode. In this mode, the vehicle has a faster throttle response and ESC sport calibration (not recommended on wet/slippery surfaces). Activating this drive mode, will also change the EPS setting.
- CORSA (TROFEO version only): to activate/deactivate the sportier and the race drive mode. When in

"CORSA" drive mode, in addition to what indicated for the sports mode, the transmission use a specific gear shift pattern and the traction is shifted more on the rear wheels with increased over steering behavior. Traction control with dedicated calibration to maximize traction vs stability and "Launch Control" start mode.

- ESC OFF: to exclude the ESC system.
- (Suspension) button (): to switch between the three suspensions setting modes: SOFT, SPORT and HARD.

By rotating clockwise or counterclockwise the Drive Mode selector, a pop-up is shown in the left dial of the instrument cluster displaying all the possible drive modes (the selected one is highlighted) together with the relative suspension soft key on the instrument cluster, if not in default mode.

Refer to chapter "Instrument Cluster Overview" in section "Dashboard Instruments and Controls" for further information.

Setting the Drive Mode

Drive modes can be set using the selector on the steering wheel.

Drive mode selector is a rotary knob that select each drive mode both clockwise and counterclockwise.



Selected mode lasts until changed or until key off. At key on default "GT" mode is always the predominant mode.

NOTE:

A different drive mode can be set even with engine running and vehicle in motion.

To activate a drive mode, switch the selector as indicated below.

COMFORT Mode

COMFORT Mode is set in "SOFT" trim. Pushing the  button, a white telltale will be displayed on the instrument cluster, switching in "SPORT" trim.

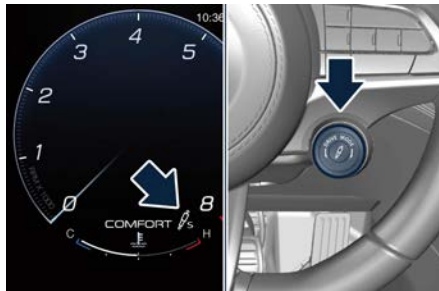

NOTE:

- Comfort Mode is selectable switching the drive mode selector from OFF ROAD rotating the knob once clockwise or GT rotating the knob once counterclockwise.
- SPORT and CORSA are not selectable starting from COMFORT Mode.

Sailing function (MHEV only)

The vehicle has a "sailing" function, which is available in driving mode Comfort and provides fuel savings. The function is automatically activated by the driver when the accelerator is released below a certain vehicle speed, without simultaneously pressing the brake pedal.

The sailing function is active when the accelerator pedal is released only if the speed is below 100 mph (160 km/h). In this condition, the engine returns to its idle state and the car decelerates without the engine applying resistance

to the wheels. The engine is reconnected to the transmission system the next time the accelerator pedal is pressed.

OFF ROAD Mode (with air suspension only)

Starting from COMFORT, OFF ROAD Mode is only selectable rotating the knob once counterclockwise. OFF ROAD mode is set in "SOFT" trim.

NOTE:

- Sport Suspensions are not available on OFF ROAD Mode.
- GT, SPORT and CORSA are not selectable starting from OFF ROAD Mode

GT Mode

At key on, "GT" mode is always the predominant mode.

GT Mode is selectable rotating the knob once clockwise starting form COMFORT and once counterclockwise from SPORT.

GT mode is set in "SOFT" trim.

Pushing the  button, a white telltale will be displayed on the instrument cluster, switching in "SPORT" trim.

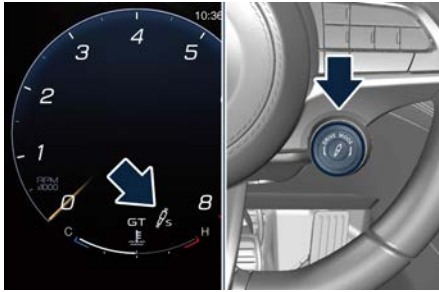

NOTE:
OFF ROAD and CORSA are not selectable starting from GT Mode.

SPORT Mode

NOTE:
When in SPORT Mode, the ambient lights will automatically switch in a red color.

SPORT Mode is selectable rotating the knob once clockwise starting from GT and once counterclockwise from CORSA.

SPORT mode is set in "SPORT" trim.

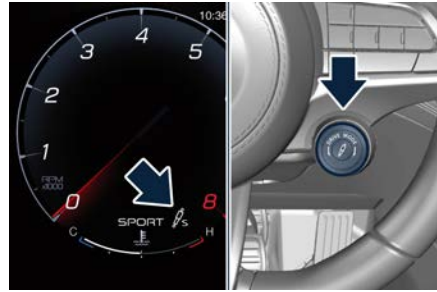

Pushing the  button, the telltale on the instrument cluster will be switched off.

NOTE:
OFF ROAD and COMFORT are not selectable starting from SPORT Mode.

CORSA Mode (TROFEO version only)

NOTE:

- When in CORSA Mode, the ambient lights will automatically switch in a yellow color.
- When in CORSA mode, a hard telltale "ESC OFF" will illuminate on the instrument cluster.

CORSA Mode is selectable rotating the knob once clockwise starting from SPORT.

CORSA mode is set in "HARD".

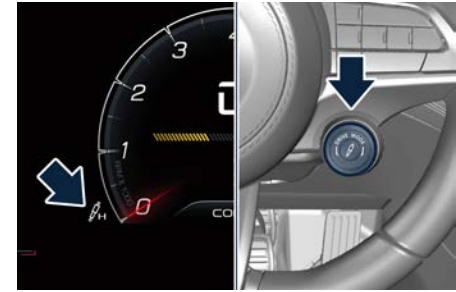

Pushing the  button, a white telltale will be displayed on the instrument cluster, switching in "SPORT" trim.

NOTE:

- OFF ROAD, COMFORT and GT are not selectable starting from CORSA Mode.
- In CORSA mode the ESC OFF soft telltale will turn on the instrument cluster, but the system is not in ESC OFF mode. To turn it on, push the soft-key on the Comfort Display.

ESC OFF Mode



WARNING!
Activating the ESC OFF Mode, the Electronic Stability Control will be automatically switched off.

To activate ESC OFF, long press the corresponding soft-key on the bottom bar of the Comfort Display: the icon will turn on in an amber color. The relative



Starting and Driving

hard telltale will be displayed on the instrument cluster.



To deactivate the drive mode, briefly press the same icon again: the icon will turn white and the telltale will turn off.



WARNING!

Never activate ESC OFF Mode if a compact spare wheel is mounted on the vehicle. Loss of control may occur and this could cause serious injuries or death.

Setting Ride Height (👉)

The pneumatic suspension system ensures vehicle continuous automatic leveling and allows setting ground clearance by entering the Suspension Menu on the Comfort Display. Suspensions can be set touching one of the five different heights. Every position is identified by the switch-on of the corresponding light at the left side of the car on the display and in the dedicated area underneath the left dial of the instrument cluster.

The table below shows the possible selector positions and the relevant symbols.

	Off Road 2
	Off Road 1
	Normal
	Aero 1

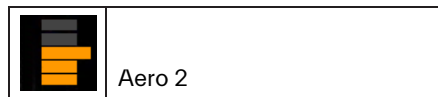

Aero 2



During transition from one position to another, the instrument cluster display will show a pop up indicator which reproduces the ride height symbols. On this soft-key, when vehicle is raising, an ▲ arrow starts blinking together with the corresponding target height indicator; in the same way, when vehicle is lowering, a ▼ arrow is displayed. When the target height indicator is reached, it stops blinking and the corresponding arrow will disappear. The new position will be displayed on the dedicated area underneath the left dial and the indicator will turn off after approximately 15 seconds when raising and 5 seconds when lowering by one level.



The system requires that the engine be running for all changes, except when lowering. When lowering the vehicle, all of the doors, including the liftgate, must be closed. If a door is opened at any time while the vehicle is lowering, the change will not be completed until the open door/s is/are closed within 5 seconds.

The pneumatic suspension system of this vehicle uses a lifting and lowering pattern preventing the headlights from incorrectly shining into oncoming traffic. When raising the vehicle, the rear of the vehicle will move up first and then the front.

When lowering the vehicle, the front will move down first and then the rear. After the engine is turned off, it may be noticed that the pneumatic suspension system operates briefly, this is normal. The system is correcting the position of the vehicle with little

suspension movements to ensure a proper appearance.

Display Messages

After changing position, a pop up message will indicate for 5 seconds when set position has been reached (after pneumatic suspension system intervention that might last up to 30 seconds).

This type of message will be displayed only if the option to view all pneumatic suspension system messages and not only the warnings was set. For further details, refer to “Functions of Settings Menu on MIA” in section “Dashboard Instruments and Controls”.



Set ride height can be monitored on Comfort display via “Suspension” menu. The change from one position to another can occur only if the following requirements are met.

- Lifting: speed lower than preset limit, etc.
 - Lowering: speed lower than preset limit, doors closed, etc.
- Ride height change can be temporarily suspended or disabled under the following conditions, as indicated in the pop up messages on instrument panel display.
- High speed: decrease speed to set new height.
 - Pneumatic suspension system overheat: wait for the system to cool down before changing height.
 - Door(s) and/or liftgate open: close door(s) and liftgate to lower or lift the vehicle.
 - Pneumatic suspension system temporarily disabled or in fault: wait a few minutes and repeat the operation or contact an **Authorized Maserati Dealer**.
 - Low battery: start the engine to recharge battery and change ride height.
 - Entry/Exit position not available: check the cause preventing this control.

Using the Ride Height Positions and Speed Thresholds

The different ride heights that can be set on the Comfort Display allow user to drive the vehicle on and off road, using the available drive modes and functions.



NOTE:

The indications below explain as a general rule which selector position has to be used in certain situations and which are the speed thresholds at which it is possible to set the available ride height. In any case, the driver must always assess and set the ride height and drive mode most suitable to the conditions of the current driving path on a case by case basis.

- **Normal:** normal ground clearance. This is the standard height position of the pneumatic suspension and is meant for normal road conditions.
- **Off Road 1:** raises the vehicle by approx. 0.8 in (20 mm). This is the height suitable for most off road driving conditions until the other off road option is needed. Select this height while the vehicle speed is below 43.5 mph (70 km/h). When in the "Off Road 1" height, if the vehicle speed remains between 43.5 mph (70 km/h) and 50 mph (80 km/h) for over 30 seconds or if vehicle speed exceeds 50 mph (80 km/h), the vehicle will be automatically lowered to "NORMAL" height. For further details, refer to "Off-road Drive" in this section.
- **Off Road 2:** raises the vehicle by approx. 1.2 in (30 mm).

This height is intended for off-road use only where maximum ground clearance is required. Select this height while the vehicle speed is below 16 mph (25 km/h). When in the "Off Road 2" height, if the vehicle speed remains between 16 mph (25 km/h) and 19 mph (30 km/h) for over 30 seconds or if vehicle speed exceeds 19 mph (30 km/h), the vehicle will be automatically lowered to "Off Road 1" height. For further details, refer to "Off-road drive" in this section.

- **Aero 1:** lowers the vehicle by approx. 0.6 in (15 mm). This height provides improved aerodynamics by lowering the vehicle. System automatically lowers the vehicle when speed remains between 75 mph (120 km/h) and 81 mph (130 km/h) for over 15 seconds or if the vehicle speed exceeds 81 mph (130 km/h). The system will return to "NORMAL" height when the vehicle speed remains between 50 mph (80 km/h) and 40 mph (65 km/h) for over 15 seconds or if the vehicle speed falls below 40 mph (65 km/h).
- **Aero 2:** lowers the vehicle by approx. 1.2 in (30 mm). It is the height ensuring excellent aerodynamics for top performance further lowering the vehicle. This ride height is always grayed out in the

suspension menu on the Comfort display. System automatically lowers the vehicle when speed exceeds 118 mph (190 km/h) or when it remains between 106 mph (170 km/h) and 118 mph (190 km/h) for over 15 seconds. The system will return to Aero 1 height when the vehicle speed remains between 96 mph (155 km/h) and 87 mph (140 km/h) for over 15 seconds or if the vehicle speed falls below 87 mph (140 km/h).

- **Easy/Entry:** lowers the vehicle by approx. 1.4 in (35 mm). This mode lowers the vehicle for easier passenger entry and exit as well as lowering the rear of the vehicle for easier loading and unloading of cargo from the trunk compartment. This ride height is not selectable from the menu on the Comfort display. Automatic lowering of the vehicle into "Entry/Exit" mode can be enabled through the MIA (refer to "Functions of Settings Menu on MIA" in section "Dashboard Instruments and Controls"). If this function is enabled, the vehicle will only lower if the transmission is in P (Park) mode, the engine is running, doors and liftgate are closed and the pneumatic suspension system should be either in "NORMAL" or "Aero". The Vehicle will not automatically lower if the pneumatic suspension system is in

“Off Road 2” or “Off Road 1” mode. The lowering will be suppressed when the ignition is switched off and a door is opened to prevent setting the alarm off.

Lowering Vehicle Height for Inactivity

Lowering of vehicle ground clearance after a long period of inactivity should be considered normal since it is due to a drop of pressure in the pneumatic suspension system.

To set off the drop of pressure due to inactivity, it is necessary to start the engine and allow some time until system reaches operating pressure and lifts the vehicle to set ride height. A message on instrument cluster display will warn driver when set ride height is reached.



Driving vehicle before the set riding height is reached is not safe and could damage suspension components.

NOTE:

After a long period of inactivity, drive the vehicle only when reaches set ride height to prevent any problems of the pneumatic suspension system.

Launch Control Mode (TROFEO version only)

"Launch Control" mode is a performance start procedure. By activating this procedure you get the best possible acceleration from standstill of the car. This mode allows you to ground the torque necessary to prevent the wheels from slipping during acceleration performance.

To make a performance start in "Launch Control" mode, the following conditions must be met:

- Water and transmission temperature in proper range.
- No engine, AWD and on board systems faults.
- "CORSA" drive mode on.
- Transmission in "D".
- The vehicle must be stationary on a level road surface.
- The driver door closed and the safety belt fastened.

Launch Control Sequence

NOTE:

- All the above mentioned conditions must be verified in order to activate "Launch Control" performance start procedure.

(Continued)



Starting and Driving

(Continued)

- During "Launch Control" ACC (if equipped), FCW and ADA (if equipped) are temporarily disabled.
- Each step displayed on the instrument cluster has a time out approximately of 5 seconds.
- "Launch Control" maneuver requires to use both feet, left foot to brake and right foot to accelerate at the same time.
- With engine on, parking brake disengaged, brake pedal pressed and steering wheel straight, pull "+" right paddle. The instrument cluster shows the "Launch Control" engaged page.



- To confirm the procedure, pull again the "+" paddle. To abort the procedure, pull "-" left paddle.
- To confirm the "Launch Control" sequence, press full the brake pedal as indicated in the message on the instrument cluster until the green zone

of the brake pressure percentage bar is reached.



- With brake pedal pressed full with left foot, fully press the accelerator pedal (with right foot) as indicated in the message on the instrument cluster.



- Release brake pedal. The launch of the vehicle starts with ESC that manages the maximum performance and engine torque calibrated to maximize performance. Maximum performance is achieved if driver let the engine rpm

stall above 2500 rpm before releasing brake pedal.



During the acceleration phase the "Launch Control" symbol appears at the left of the digital speed in the instrument cluster display.





Off-Road Drive

This vehicle is equipped with a specific Off Road driving mode which allows to drive through various terrain conditions (rock, mud, sand), also in uphill and downhill, eventually in condition of lateral inclination. To set the "OFF ROAD" drive mode, please see chapters "Drive Mode" and "Setting Ride Height" in this section.

NOTE:

It is recommended to use "OFF ROAD" drive mode when driving in off road conditions.

An advantage of the higher ground clearance is a better view of the road, allowing you to anticipate problems. A higher clearance and the longer travel of the suspension might allow the vehicle to overcome some obstacles.

A higher ground clearance means a higher center of gravity. If at all possible, avoid sharp turns or abrupt maneuvers.

Failure to operate this vehicle correctly may result in loss of control or vehicle rollover.

Although the pneumatic suspension system contributes to limiting these risks by setting precautionary speed thresholds, the driver must always pay utmost attention and drive carefully.



CAUTION!

"Off Road 2" ride height must always be selected in case of water fording. Water may enter in the intake system and damage the engine. Please remember water fording limits: max depth of the water must be lower than 19 in (50 cm) and crossing speed lower than 5 mph (8 km/h).

In "OFF ROAD" drive mode, also engine, transmission settings are changed in order to provide the most suitable level of torque and selected gear to improve traction on low-adherence condition and uphill climbing.



WARNING!

In the event of a descent, the use of Hill Descent Control (HDC) is recommended, especially on steep slopes and in poor grip conditions, in order to reduce the risk of loss of control or the vehicle rollover.

Also suspensions (Skyhook Continuous Damping Control) are set to a specific calibration in "OFF ROAD" drive mode, in order to obtain the right damping force provided by the shock absorbers, combined with the increased ride heights "Off Road 1" and "Off Road 2".

Driving Through Water

Set maximum ride height "Off Road 2" before driving through water.

Although your vehicle is capable of driving through water, there are a number of precautions that must be considered before entering the water.

NOTE:

Your vehicle is capable of water fording to a maximum of 19 in (50 cm) of water.

To maintain optimal performance of your vehicle's heating and ventilation system it is recommended to switch the system into recirculation mode during water fording.



CAUTION!

When driving through water, do not exceed 5 mph (8 km/h). Always check water depth before entering, as a precaution. Check all fluids afterwards: driving through water may cause damage to engine and driveline that may not be covered by the new vehicle limited warranty

Driving through water more than a few inches/centimeters deep will require extra caution to ensure safety and prevent damage to your vehicle. If you must drive through water, try to determine the depth and the bottom condition (and location of any obstacles)



Starting and Driving

prior to entering. Proceed with caution and maintain a steady controlled speed lower than 5 mph (8 km/h) while in water to minimize wave effects that might cause serious damage to all components, especially engine.



WARNING!

Avoid driving through flowing or standing water. Doing so can be highly dangerous and can be very difficult to determine the depth of the water you are driving through. If driving through water cannot be avoided, and after driving through it, apply the brakes lightly to ensure the brakes are operating correctly.

Flowing Water

If the water is swift flowing and rising (as in storm run-off), avoid crossing until the water level recedes and/or the flow rate is reduced. If you must cross flowing water avoid depths in excess of 9 in (25 cm).

Standing Water

Do not drive in standing water deeper than 19 in (50 cm), and reduce speed appropriately to minimize wave effects.

Maintenance

After driving through water, have your vehicle fluids and lubricants inspected at

an **Authorized Maserati Dealer** to assure the fluids have not been contaminated.

Driving in Snow and Wet Grass

In heavy snow, when pulling a load, or for additional control at slower speeds, set "Comfort" drive mode with transmission in M (Manual) and shift the transmission to a low gear. See "Drive Mode" in this section for further details. Do not shift to a lower gear than necessary to maintain forward motion. Over-revving the engine can spin the wheels and traction will be lost. Avoid abrupt downshifts on icy or slippery roads, because engine braking may cause skidding and loss of control. Follow these instructions even when driving through a path section covered with wet grass.

Driving in Mud and Sand

In general, when driving in mud and sand, if your wheels spin, always reduce the throttle in order to slow the tires and regain traction.

- When driving in mud, avoid using low gear that could cause wheel spin. Follow the tyre and vehicle manufacturer's advice on tire pressure.
- When driving in sand, adopt lowest gear possible.

Hill Climbing

Before climbing a hill, determine the conditions at the crest and/or on the other side and shift the transmission to a lower gear.

The vehicle is equipped with Hill Start Assist (HSA) that helps the driver to manage the brake intervention in acceleration when driving uphill ( : chapter "Brake and Stability Control Systems" in section "Safety").



WARNING!

If you lose forward motion, or cannot make it to the top of a hill or grade, never attempt to turn around. Always back carefully straight down a hill in R (Reverse) gear. Never back down a hill in N (Neutral) mode using only the brake.

Remember, never drive diagonally across a hill; always drive straight up or down.

Traction Downhill

When descending mountains or hills, use Hill Descend Control (HDC) to avoid repeated heavy braking (for further details, refer to "Hill Descent Control - HDC" in section "Driver Assistance Systems").

When descending mountains or hills, repeated braking can cause brake fade with loss of braking power. Avoid



response. Removing it will correct the situation.

repeated heavy braking and downshift the transmission whenever possible in order to cool down the brakes.

Warnings and Tips for Off-road Driving

When driving off-road, using the “OFF ROAD” drive mode which is specific for this use.

Before driving, always make sure that the vehicle reached the ride height set through the suspension menu on the Comfort Display.

When driving, always:

- limit driving speed as much as possible to tackle bends, bumpy sections and slopes;
- increase visual control in front and on the sides of the vehicle to quickly spot any obstacles on your path (potholes, branches, etc.);

Always consider these tips further to your experience gained in off-road driving.

After Driving Off-road

Off-road operation puts more stress on your vehicle than does most on-road driving. After going off-road, it is always a good idea to check for damage. That way you can get any problems taken care of right away and have your vehicle ready when you need it.

- Completely inspect the underbody of your vehicle. Check tires, body structure, steering, suspension, and exhaust system for damage.
- Inspect the radiator for mud and debris that might decrease sinking effect and clean as required.
- Check for accumulations of plants or brush in underbody. These things could be a fire hazard if they get in contact with the exhaust system.
- After extended operation in mud, sand, water, or similar dirty conditions, have all parts that got in contact with mud, sand and water inspected and cleaned as soon as possible.



WARNING!

Abrasive material in any part of the brakes may cause excessive wear or unpredictable braking operation. You might not have full braking power when you need it to prevent a collision. Do not drive if braking system is not perfectly efficient: get your brakes checked and cleaned as necessary by an Authorized Maserati Dealer.

- If you experience unusual vibration after driving in mud, slush or similar conditions, check the wheels and suspension linkages for impacted material. Impacted material can cause wheel imbalance and affect suspension



Parking Brake

The vehicle is equipped with an electric automatic parking brake, also called EPB (Electric Parking Brake). The EPB braking action is ensured by a power actuator directly working on the brake pad inside each caliper of the rear brake system.

It can be automatically engaged when the engine is turned off and disengaged with engine running, driver seatbelt latched and driver door closed, while pressing the brake pedal and operating the shift buttons only if the "Auto Park Brake" function is activated on the MIA screen (see paragraph "Functions of Settings Menu on MIA" in section "Dashboard Instruments and Controls"). Furthermore, EPB can be automatically engaged above a slope threshold with transmission in parking to avoid damage to the vehicle. EPB can be disengaged before to turn off the vehicle.

When the parking brake is applied, the warning light **BRAKE** (United States market) or  (Canadian market) lights up on the instrument cluster display and the related message is displayed on the instrument cluster for 5 seconds (see "Warning and Indicators Lights" in section "Dashboard Instruments and Controls").



United States Market



Canadian Market

In the above-mentioned condition, the automatic engagement function can be deactivated/activated by selecting the "Auto Park Brake" (refer to "Functions of Settings Menu on MIA" in section "Dashboard Instruments and Controls").

Manual Engagement/ Disengagement

The parking brake can also be manually engaged when the engine is not running

or the ignition device is in the **STOP** position, raising the lever located under the driver lower side of the dashboard. The disengagement is performed only when the engine is running or the ignition device is in the **ON** position, by pressing the brake pedal, pushing the lever located under the driver lower side of the dashboard.

The warning light **BRAKE** (United States market) or  (Canadian market) lights up on the cluster display for all the time it is applied.

If you attempt to disengage the parking brake without having pressed the brake pedal, a message will be displayed, warning you to press the brake pedal. If the engine was turned off when the automatic engagement device was deactivated it is possible to shift the parking brake simply by pulling the lever upward.



**CAUTION!**

The main function of the EPB is to allow safe parking of the vehicle, therefore it must only be applied when the vehicle is already stationary.

**WARNING!**

- Always hold the brake pedal pressed during disengagement of the parking brake.
- The EPB command activation while running generates a deceleration of the vehicle with strong deceleration (Dynamic Braking). It is therefore recommended to use this function only in case of emergency. When the handbrake is activated, the vehicle stability will not be affected when ESC is engaged.
- It is advisable to keep the “Auto Park Brake” function always active (On) so that the vehicle is properly secured with electric parking brake.

Failure Indication

In the event of electric parking brake system failure, the warning light (P)! on the display will light up.

In addition, the warning light **BRAKE** (United States market) or (!) (Canadian market)

(Canadian market) will flash for 10 seconds.

**WARNING!**

In the event of an EPB failure, take your vehicle to the nearest Authorized Maserati Dealer as soon as possible.

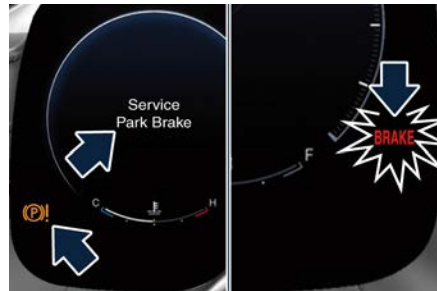

United States Market

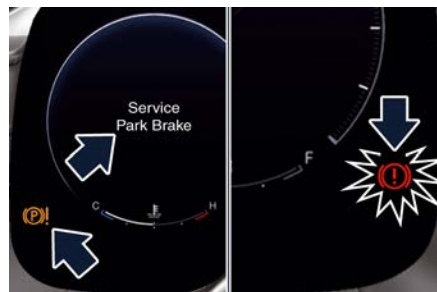

Canadian Market

Initialize the EPB System after Re-connecting the Vehicle Battery

After the detachment and the subsequent connection of the battery, on the instrument cluster display the warning light (P)! will be illuminated. To initialize the EPB system, lift, release and lift again the lever located under the driver lower side of the dashboard. After having initialized the EPB system, the error messages regarding the unavailability of the radar functions shown in the pictures will be displayed on the instrument cluster. In the next key cycle, the messages will no longer be present.

**Emergency Disengagement**

In case of brake lock with complete electrical system failure, it is necessary to force the electric actuator on the rear calipers (see “Emergency Release of the



Starting and Driving

Parking Brake” chapter in section “In an Emergency”).

EPB Operation with Overheated Brakes

Driving on mountain roads with steep slopes or a sports use of the vehicle could overheat the brake system components. In these conditions, parking brake must not be used since the push of the power actuator might not be sufficient to ensure vehicle braking, especially on a slope.

Drive normally without braking to allow the brakes to cool down a few minutes before stopping. In this way, the automatic or manual activation of the parking brake will ensure vehicle braking.

Parking

Before leaving the vehicle, **make sure that the parking brake is fully applied** in automatic or manual and move the transmission in P (Park) mode by pressing the brake pedal and the “P” button.



WARNING!

- **Always check that the vehicle is locked before leaving it.**
- **Never leave children unattended in the vehicle.**
- **Do not park the vehicle on paper, grass, dry leaves or other flammable materials.**
- **Do not leave the engine running while the vehicle is unattended.**



WARNING!

Never use the P (Park) position as a substitute for the parking brake. Always apply the parking brake firmly when parked, including when parked on an incline, to guard against vehicle movement and possible injury or damage.

When parking on hill roads, it is important to turn the front wheels toward the curb on a downhill grade and away from the curb on an uphill grade. Apply the parking brake before shifting the transmission in P (Park) mode, otherwise the load on the transmission locking mechanism may make it difficult to move out of P (Park) mode. In certain conditions, it is however advisable to disengage the parking brake manually and slightly apply the

service brake for starting off. This is advisable when there are obstacles very close to the vehicle in the direction in which you intend to move.



Using the Brakes

The pad wear limit is indicated by the illumination of the warning light , in an amber color for United States Market and in a red color for Canadian market, on the instrument cluster.

In this event, please contact an **Authorized Maserati Dealer**.

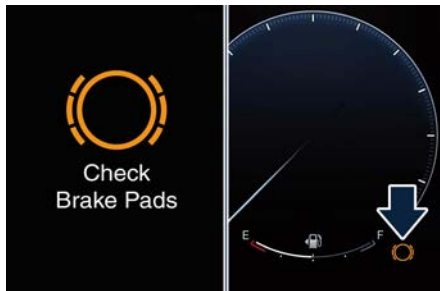

United States Market

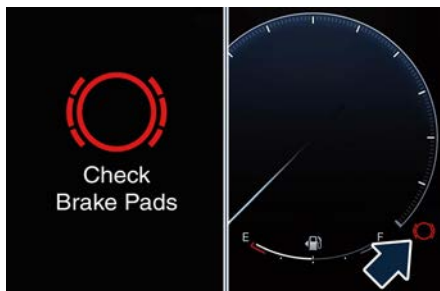

Canadian Market



WARNING!

Riding the brakes can lead to brake failure and possibly an accident. Driving with your foot resting or riding on the brake pedal can result in abnormally high brake temperatures, excessive lining wear, and possible brake damage. In an emergency full braking capacity may be impaired.

Brake Pads and Brake Discs

Wear on the brake pads and brake discs depends to a great extent on the driving style and the conditions of use and therefore cannot be expressed in actual kilometres/miles driven on the road.

The brake system is designed for optimal braking effect at all speeds and temperatures.

Certain speeds, braking forces and ambient conditions (e.g. temperature, humidity and long outdoor stopping periods) can therefore cause the brakes to "squeal". This is normal and will cease after a few brakings.

New Brake Pads and/or Brake Discs

New brake pads are already "bed in", and therefore only attain optimal friction to the brake disc.

During the first period, the braking system may make a noise, but it will disappear over time.

To obtain the maximum efficiency of the brake pads and discs, avoid sharp, repeated and prolonged braking during the first 310 mi (500 km).

Brake Overheating

Driving on mountain roads with steep slopes or a sports use of the vehicle could overheat the brake system components. In these conditions, parking brake must not be used since the push of the power actuator might not be sufficient to ensure vehicle braking, especially on a slope.

Drive normally without braking to allow the brakes to cool down a few minutes before stopping. In this way, the automatic or manual activation of the parking brake will ensure vehicle braking.

Brake overheating could also cause "squeals" and "vibrations".



Use of the Engine

Breaking-In

Today's most modern production methods are designed to provide extremely precise construction and assembly of components. However, moving parts do undergo a settling process, basically in the first hours of vehicle operation.

Do not drive keeping at a constant high speed rate for a prolonged time. While cruising, brief full-throttle acceleration within the limits of local traffic laws contributes to a good break-in. Wide-open throttle acceleration in low gear can be detrimental and should be avoided.

The engine oil installed in the engine at the factory is a high-quality energy conserving type lubricant. Oil changes should be consistent with anticipated climate conditions under which vehicle operations will occur. For the recommended viscosity and quality grades, see  "Refilling Table" in section "Technical Specifications".

A new engine may consume some oil during its first few thousand kilometers/miles of operation. This should be considered as a normal part of the break-in and not interpreted as an indication of malfunction.

Specific Requirements (2.0 L4 MHEV Engines)

Avoid exceeding 5000 rpm for the first 620 mi trip (1000 km).

After starting the vehicle, do not exceed 4000 rpm until the engine has warmed up sufficiently (coolant temperature: 149-158°F / 65-70°C).

Specific Requirements (V6 Engine)

Follow these recommended guidelines during the first 1500 mi (2414 km) of driving this vehicle. Parts have a break-in period and performance will be better in the long run.

For the first 200 mi (322 km):

- To break in tires, drive at moderate speeds and avoid hard cornering.
- New brake linings also need a break-in period. Avoid making hard stops. This is recommended every time brake linings are replaced.

For the first 500 mi (800 km):

- Avoid full throttle starts and abrupt stops.
- Do not exceed 4000 rpm.
- Avoid driving at any one constant speed, fast or low, including the use of cruise control.
- Avoid downshifting to break or slow the vehicle when the engine speed will exceed 4000 rpm.

- Do not let the engine labor. Never lug the engine. This rule applies at all times, not just the break-in period.

For the first 1500 mi (2414 km):

- Do not participate in track events, sport driving schools, or similar activities.
- Check engine oil with every refueling and add if necessary. Oil and fuel consumption may be higher than normal.

Trailer Towing

During the first 620 mi (1000 km) of a new vehicle it is advisable not to tow a trailer. This allows to limit the load on the engine and on the other parts of the vehicle.

While Driving

Never travel with the tachometer indicator approaching the peak rpm, not even downhill. When the tachometer indicator is approaching the peak rpm (red colored zone), take precautions to avoid exceeding that limit.

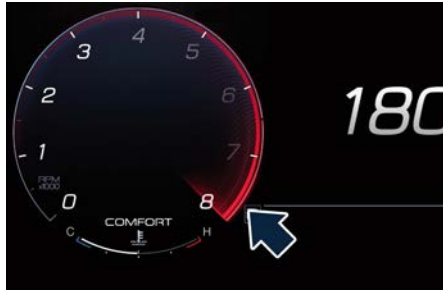

Specific Requirements (V6 Engine)

The following maneuvers can lead to a temporary and/or premature deterioration of the ignition system with consequent lighting of the  malfunction indicator light (MIL) and immediate request for service:

- repeated stops of the vehicle with the engine running at idle for more than 10 minutes
- stationary vehicle with engine running at idle for more than 1 hour
- repeated starts without reaching the engine operating temperature (white coolant gauge) (more than 10 starts)
- short journeys with ambient temperatures below 32° F (0° C) or with the engine not at operating temperature (white coolant gauge).

To keep the combustion system at maximum efficiency, it is advisable to regularly follow an extra-urban route with an average speed greater than 44

mph (70 km/h) (in compliance with the traffic code) for 15 minutes. Ensure proper operation of different devices checking their respective control telltales.



CAUTION!

Under normal conditions, all red warning lights on the instrument cluster display should be off. When they come on, they indicate a malfunction. Refer to “Warning and Indicator Lights” in section “Dashboard Instruments and Controls”.



WARNING!

Continuing to drive when a red warning light is on could cause serious damage to the vehicle and affect its performance.

On-Board Diagnostics (OBD)

Your vehicle is equipped with a sophisticated on-board diagnostic system. This system monitors the performance of the emissions, engine, and automatic transmission control systems. When these systems are operating properly, your vehicle will provide excellent performance and fuel economy, as well as engine emissions well within current local regulations of various countries.

If any of these systems require service, the system will turn on the  malfunction indicator light (MIL). It will also store diagnostic codes and other information to assist which your **Authorized Maserati Dealer** will use to service your vehicle. Although the vehicle will still be driveable and not need towing, contact an **Authorized Maserati Dealer** for service as soon as possible.



CAUTION!

- Prolonged driving with the  Malfunction Indicator Light (MIL) on could cause further damage to the emissions control system. It could also affect fuel economy and driveability. The vehicle must be serviced before any emissions tests can be performed.



Starting and Driving

- If the  Malfunction Indicator Light (MIL) is flashing while the engine is running, severe catalytic converter damage and power loss could occur. Immediate service is required at an **Authorized Maserati Dealer**.
- After the problem has been solved, an **Authorized Maserati Dealer** personnel will perform specific tests on the test bench for a complete check of the system and, if necessary, road tests.

Messages Concerning the Residual Life of Gasoline Engine Oil

According to the degradation that the engine oil has reached, according to the conditions of use of the vehicle, the instrument cluster can display the request to carry out the oil change in advance of the expected Service. A first warning will indicate to change the oil as soon as possible and a second will indicate to do it immediately. After this last warning, if the oil is not replaced, the warning message indicated in the picture will also come on.



When the warnings on the residual life of engine oil appear on the instrument cluster, it is advisable to go as soon as possible to an **Authorized Maserati Dealer** that will carry out the necessary checks.



Spare Parts

Use of genuine Maserati parts for normal or scheduled maintenance and repairs is highly recommended to ensure excellent performance.

Damage or failures caused by non-genuine spare parts used for maintenance and repairs will not be covered by the manufacturer's warranty.

Refueling

Fuel Filler Neck Access

To access the fuel filler neck, the filler door must be unlocked. From outside the vehicle, this can only be done by pressing the unlock  or the lock  button on the key fob, in the same way as if opening or closing the doors. If any of the door lock controls is pressed from inside the vehicle, the filler door will still remain closed.

- Press the indicated area on the filler door, which is located on the rear left side of the vehicle: the filler door will open completely.



NOTE:

In order to guarantee an easy fuel filler door opening, it has to be pressed in the middle right side; if pressed in any other position, it could remain locked.



Refill the Tank

The fuel filler neck is provided with external cap.

- Rotate counterclockwise and remove the fuel filler cap. The cap hermetic seal may result in a slight pressure increase inside the tank. Any hissing noise while the cap is being opened is therefore completely normal. The cap is linked to the filler neck with a strap, to prevent it from being lost while refueling.





- When refueling, place the cap in the proper seat on the filler door hinge.



- Insert the fuel nozzle fully into the filler.



WARNING!

- **To avoid the risk of fire, do not approach the filler with open flames or cigarettes!**
- **To avoid the risk of inhaling noxious fumes, do not breathe close to the fuel filler door, when opened.**
- **Never have any smoking materials lit in or near the vehicle when the fuel filler door is open or the tank is being filled.**
- **Never add fuel when the engine is running. This violates most fire-prevention regulations and may cause the Malfunction Indicator Light (MIL)  to turn on (see “Warning and Indicator Lights” in section “Dashboard Instruments and Controls”).**
- Fill the vehicle with fuel ( : chapter “Refilling Table in section Technical

Specifications”). When the fuel nozzle “clicks” or shuts off, the fuel tank is basically full: it is possible to further ensure refueling by enabling the fuel nozzle additional fuel supply until twofold clicks. After the two additional clicks, the amount of fuel allowed by the system is very low, we recommend therefore not to persist further.

- Wait approximately 10 seconds before removing the fuel nozzle in order to ensure completed supply of residual fuel and restrict the risk of fouling the fuel filler door area.
- Remove the fuel nozzle.
- Insert the cap on the fuel filler neck.
- Tighten the cap, turning it clockwise until it stops.
- Close the fuel filler door.



CAUTION!

To avoid fuel spillage and overfilling, do not “top off” the fuel tank after filling.

Fuel Filler Cap Open Warning Light



After refueling the car performs a check of the fuel filler cap and the amber warning light on the cluster display comes on if it is not correctly closed, after approximately 10 minutes also depending on driving conditions.



Starting and Driving

If the problem is in the fuel system, the Malfunction Indicator Light  also comes on.

If the fuel filler cap is locked and the issue remains in the system, at the next engine start only the Malfunction Indicator Light  comes on. In this case, contact an **Authorized Maserati Dealer**.

Driving Conditions

Before the Trip

Check the following at regular intervals and always before long trips:

- tire pressure and condition;
- levels of fluids and lubricants;
- conditions of the windshield wiper blades;
- clean the glass on the external lights and all other glass surfaces;
- proper operation of the warning lights and of the external lights.



CAUTION!

It is however advisable to perform these checks at least every 600 mi (1000 km) and always following the maintenance schedule reported in section “Maintenance and Care”.

Before you drive:

- adjust seat position, steering wheel and rear-view mirrors in order to have the best driving position;
- ensure that nothing (mat covers, etc.) is obstructing the pedals movement;
- carefully arrange and secure any objects in the trunk, to prevent them from moving forward in case of sudden stops;
- avoid heavy meals before a trip. A light snack helps keep your reflexes sharp. In particular, avoid drinking alcohol.



WARNING!

Passengers must only travel seated in the vehicle seats, with the seat belts fastened. Always check that the driver and all passengers have the seat belts correctly fastened.

Safe Driving

Although the vehicle is equipped with active and passive safety devices, the driver's conduct is always a decisive factor for road safety.

Some simple rules for traveling safely in different conditions are listed below. Some of them will probably already sound familiar but, in any case, it would be useful to read them carefully.

Driving at Night

The main guidelines to follow when driving at night are set out below.

- Drive carefully. Night conditions demand more focus and attention.
- Reduce your speed, especially on roads with no streetlights.
- Stop at early signs of drowsiness. Continuing to drive would be a risk for yourself and for others. Have a rest before continuing your trip.
- Keep the vehicle at a greater distance from vehicles in front of you than you would during the day: it is difficult to



assess the speed of other vehicles when you only see the lights.

- Use the high beams only outside of densely-populated areas and when you are sure that they will not disturb other drivers.
- When another vehicle is approaching, switch from high beams (if on) to low beams.
- Keep lights and headlights clean.
- Outside of densely-populated areas, beware of animals crossing the road.

Driving in the Rain

Rain and wet roads are dangerous.

On a wet road all maneuvers are more difficult since wheel grip on the road is significantly reduced. This means that the braking distances increase considerably and the road grip decreases.

Some recommendations for driving in the rain are listed below.

- Reduce your speed and keep a greater safety distance from the vehicles in front of you. High speed may result in a loss of vehicle control.
- When driving on wet or slushy roads, it is possible for a wedge of water to build up between the tire and road surface. This is known as hydroplaning and may cause partial or complete loss of vehicle control and stopping ability.

To reduce this possibility: slow down if the road has standing water or puddles.

- Heavy rain substantially reduces visibility. In these circumstances, even during the day, turn on the low beams, to be more visible to other drivers.
- Set the air conditioning and heating system controls on the demisting function, in order to avoid any visibility problem.
- Periodically check the conditions of the windshield wiper blades.
- In low grip conditions use “Comfort” driving mode (see chapters “Drive Mode” and “Off-road Drive” in this section).
- Avoid driving with ESC OFF as this could possibly cause a loss of control of the vehicle.

Driving in Fog

If the fog is dense, avoid traveling if possible.

When driving in mist, blanket fog or when there is the possibility of banks of fog, please consider some advice listed below.

- Keep a moderate speed.
- Even in daytime, turn on the low beams. Do not use the high beams.
- Remember that fog creates dampness on the asphalt and thus any type of maneuver is more difficult and braking distances are extended.

- Keep a safe distance from the vehicle in front of you.
- Avoid sudden changes in speed as much as possible.
- Whenever possible, avoid overtaking.
- If you are forced to stop the vehicle (breakdowns, impossibility of proceeding due to poor visibility, etc.), first of all, try to stop off of the travel lane. Then turn on the hazard warning lights and, if possible, the low beams.
- Sound the horn rhythmically if you hear another vehicle approaching.



WARNING!

Be aware that rear fog lights can bother the drivers following your vehicle: when visibility is back to normal, turn off these lights.

Driving in the Mountains

Mountain roads usually have many narrow turns and curves, tunnels and steep uphill or downhill slopes: please consider some advices listed below.

- Drive at a moderate speed, avoid “cutting” corners.
- When driving inside a tunnel in daylight turn on the low beams in advance; avoid high beams and be aware of the rapid brightness change. Avoid abrupt maneuvers that could be dangerous for the following vehicle.



Starting and Driving

- Never coast downhill with the engine off or in neutral.
- Remember that passing other vehicles when driving uphill is slower and thus requires more free distance on the road. If you are being overtaken on a hill, slow down and allow the other vehicle to pass.

Driving on Snow or Ice

Please consider some general advice for driving in these conditions, listed below.

- Maintain a very moderate speed.
- Fit snow chains or specific tires if the road is covered with snow,  : chapter "Tires Information" in section "Safety".
- We recommend you to activate the "Comfort" mode (see chapters "Drive Mode" and "Off-Road Drive" in this section).
- During the winter season, even apparently dry roads can have icy sections. Be careful when crossing bridges, viaducts and roads that have little exposure to the sun and are bordered by trees and rocks. They may be icy.
- Keep an ample safe distance from the vehicles in front of you.
- When driving on dirty roads (mud, snow or ice), clean you vehicle as described in the paragraph "Car Wash" (see chapter "Bodywork Maintenance and

- Care" in section "Maintenance and Care").
- Recover vehicle in closed area after drove on heavy snow road to prevent ice build-up.



WARNING!
Rapid acceleration on slippery surfaces is dangerous. Accelerate slowly and carefully whenever there is likely to be poor traction (ice, snow, wet mud, loose sand, etc.).

Driving through Flooded Sections

Driving through water sections will require extra caution to ensure passenger safety and prevent damage to your vehicle. For more details, see "Off-Road Drive" in this section.

Trailer Towing (OPT)

In this section you will find safety tips and information on limits to the type of towing you can reasonably do with your vehicle.

NOTE:

- Using original Maserati equipment offers an advantage, compared to aftermarket one, in terms of driving safety and utilizing the vehicle potential under all conditions, especially considering that ESC and AWD systems function specific settings for trailer towing. Further to this, if vehicle use conditions so allow, the original trailer tongue allows use of the driver assist systems present on-board.
- To maintain the new vehicle limited warranty coverage, follow the requirements and recommendations in this chapter.

Trailer Tongue Weight

Maximum load of tow vehicle is reduced by the trailer tongue weight and the load on the same due to the trailer. Trailer tongue weight increases vehicle weight. Do not exceed the maximum GVWR of the tow vehicle, the one for each axle (GAWR) and the mass that the vehicle is rated to tow (GTW) specified on the



nameplate located on the rear driver door's ledge.



WARNING!

It is important that you do not exceed the maximum allowed overall GVWR and GTW. A dangerous driving condition can result if either rating is exceeded. If you use aftermarket Kit for towing, refer to  : chapter "Weights" in section "Technical Specifications".

Arranging Load on Trailer

Arrange load at the bottom and as close as possible to trailer wheel axle.

In this way the trailer center of gravity will be lower, thereby increasing the driving safety of the vehicle-trailer assembly.

Always load a trailer with 60% of the weight in the front of the trailer.

Loads bearing more on wheel axle, or heavier in the rear of the trailer, can cause the trailer to sway severely side-to-side which could cause loss of control of vehicle and trailer.





WARNING!

Failure to load trailers heavier in front is the cause of many trailer accidents. Never exceed the maximum weight stamped on your trailer hitch.

Tire Pressure Adjustment

Proper tire inflation pressures of your vehicle and trailer are essential to the safe and satisfactory operation of your vehicle while driving and in maneuvers. Check for signs of tire wear or visible tire damage on trailer and vehicle before towing a trailer.

For more information on vehicle tires,  : chapter "Tires Information" in section "Safety".

When a trailer must be towed, inflate vehicle tires to full load recommended pressure (FLC),  : chapter "Tire Inflation Pressure" in section "Technical Specifications".

For pressure of trailer tires, follow the instructions given by the trailer manufacturer.

After adjusting vehicle tire pressure and connecting and disconnecting the trailer, initialize the Tire Pressure Monitoring System (TPMS),  : chapter "Tire Pressure Monitoring System (TPMS)" in section "Safety".

Field of Vision of External Rear View Mirrors

Law provisions require the field of vision of external rear-view mirrors to include the rear trailer corners.

If vehicle external rear-view mirrors cannot cover the required field of vision, it is possible to install additional rear-view mirrors sticking further out at the sides.

The **Authorized Maserati Dealer** can provide you with information about towing a trailer and about the approved components available in the "Genuine Accessories" range.

Trailer Lights

Law provisions require trailers to be equipped with an electrical lighting system that must include the following lights:

- Turn signals;
- Position lights;
- Stop lights;
- Reverse lights;
- Number plate lights;
- Side marker lights (for trailer width over 6.8 ft/2.1 m).

The power input of the trailer lights must not exceed the values in the following list.

- Position lights, side marker lights and number plate lights: 6 x 5W per side.
- Turn indicators: 2 x 21W



Starting and Driving

- Stop lights: 4 x 21W
- Reverse lights: 2 x 21W

Trailer Wiring Harness

Vehicle trailer tongue includes a 4-pin sealed connector powered at 12VDC for connection of the corresponding trailer wiring connector.

In addition to the electrical branches, the vehicle electrical system can only be connected to the supply cable for an electric brake and to the cable for an internal light for the trailer, not exceeding 15W.



CAUTION!

Do not cut or splice wiring into the vehicle wiring harness. Do not change cable connections on connectors. The table below indicates the function and color of cable corresponding to every connector pin as shown in the figure.

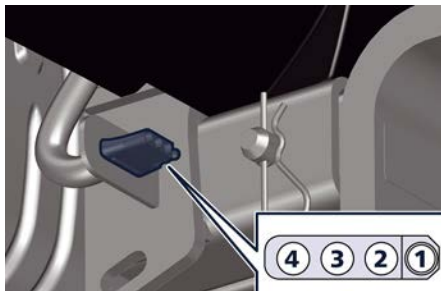

Pin N.	Function	Wire section (mm ²)
1	Lights ground (Lights GND)	1.5
2	Position light, side marker lights and license plate light	1
3	Left turn signal and stop light	1
4	Right turn signal and stop light	1

If the hooking and/or the electrical connection between vehicle and trailer is faulty, the warning light and the relevant message are displayed on instrument cluster display (see example in the figure).



In these cases please contact an **Authorized Maserati Dealer** and avoid using the vehicle with a trailer.

Install the Trailer Tongue

- Pull out the trailer tongue which is housed in a bag positioned on the right side of the trunk.
- Push the trailer tongue in the seat on the cross member of the car up to match the hole **A** on the trailer tongue with the one on the cross member support.

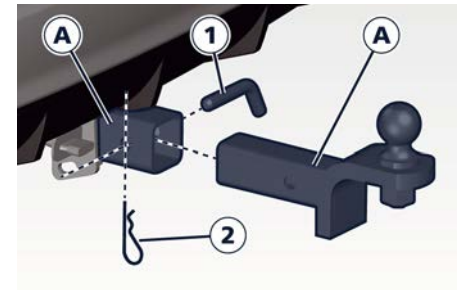

- Insert the pin **1** into the hole **A** and push it until it stops.
- Install the split pin **2** at the opposite end of the pin **1**.

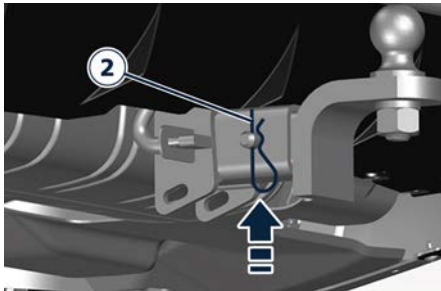
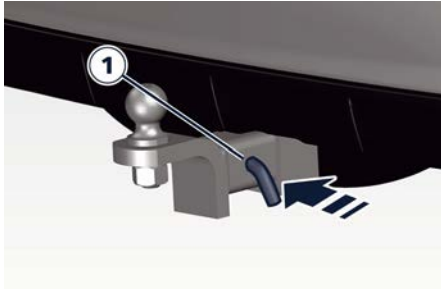

Connect the Electrical System of the Trailer

- For connection, remove the protective cover from the car connector which is found on the left-hand side of trailer tongue seat.

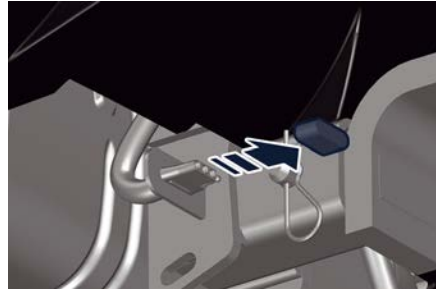

- Engage the trailer male connector into the car female connector.
- Push trailer connector fully home and engage the safety lock, if any.

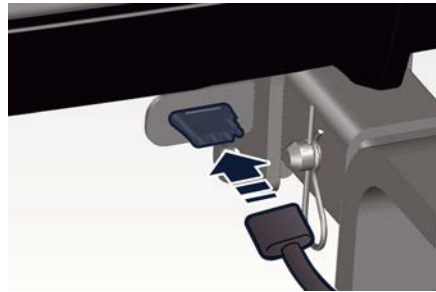

Remove the Trailer Tongue

When trailer tongue is no longer necessary, disconnect electrical connections and remove it from its seat as described below.

- Remove the split pin **2**.
- Grip the trailer tongue firmly and pull out the pin **1**.

- Remove the trailer tongue from its seat.
- Clean the trailer tongue and remove all residues, especially on the ends.
- Install the ball protection.
- Insert the pin **1** in the trailer tongue hole and install the split pin **2**.
- Set trailer tongue in its seat inside the trunk.

Towing Tips

- Before setting out on a trip, check operation of trailer rear lights and stop lights to ensure you do not jeopardise other road users' safety.
- Make certain that the load is secured in the trailer and will not shift during travel. When trailering cargo that is not fully secured, dynamic load shifts can occur that may be difficult for the driver to control.
- When hauling cargo or towing a trailer, do not overload your vehicle or trailer. Overloading can cause a loss of control, damage to brakes, driveline, steering, suspension or tires.
- Safety metal wire must always be used between your vehicle and trailer. Always connect the wire to the hook retainers of the trailer and vehicle hitch. Cross the wire under the trailer tongue and allow enough slack for turning corners.
- Comply with local applicable speed limits.



Starting and Driving

- Towing any trailer will increase your stopping distance. When towing, you should allow for additional space between your vehicle and the vehicle in front of you. Failure to do so could result in an accident.
- For towing use “Normal” ride height.
- Do not exceed maximum specified pressure for vehicle and trailer tires.
- Vehicles with trailers should not be parked on a steep grade. When parking, put the tow vehicle transmission in P (Park) and apply the parking brake on the tow vehicle. Always, block or "chock" the trailer wheels.
- Do not use Cruise Control (CC and/or ACC) when driving on slopes or when carrying heavy loads.
- The D (Drive) gear must be selected when towing. The transmission controls include a drive strategy to avoid frequent shifting when towing. However, if frequent shifting does occur while in D (Drive), you can use the paddle shift switches to manually select a lower gear.
- Using a lower gear while operating the vehicle under heavy loading conditions, will improve performance and extend transmission life by reducing excessive shifting and heat buildup. This action will also provide better engine braking.



6 - Driver Assistance Systems

General Notes	196
Park Assist	196
Rear Parking Camera	203
Surround View Camera System (OPT)	204
Hill Descent Control - HDC	207
Speed Limiter - SL.....	209
Cruise Control - CC	213
Adaptive Cruise Control - ACC (OPT)	215
Forward Collision Warning - FCW	225
Active Lane Management - ALM (OPT, with BSA only)	228
Blind Spot Assist - BSA (OPT).....	232
Drowsy Driver Detection - DDD (OPT)	237
Active Driving Assist – ADA (OPT)	238
Traffic Sign Assist – TSA (OPT)	242



General Notes

This section lists all the parking assistance systems and all the Advanced Driver Assistance Systems, synthetically called ADAS, available for this car.

Some ADAS are standard, others are optional and may vary depending on the equipment of the car and the target market.

Some of these systems activate or deactivate automatically, others can be activated or deactivated and set using the buttons on the steering wheel R/H side, the left multifunction lever or via the "Controls" and "Settings" menu on the "Vehicle" page or the "Apps" page of MIA display. For further information see "Functions of Controls Menu on MIA" and "Functions of Settings Menu on MIA" in section "Dashboard Instruments and Controls".

Park Assist

The Park Assist system provides visual and audible indications of the distance between the rear and/or front bumper and a detected obstacle when backing up or moving forward, e.g. during a parking maneuver.

Besides the use of the sensors available on the bumpers and of the rear parking camera, the vehicle may be equipped with surround view cameras (📷) to assist the driver during maneuvers on dead-ends/roads and on intersections. For more details on this option, see chapter "Surround View Camera System" in this section.

Refer to "Park Assist System Usage Precautions" in this chapter for limitations of this system and recommendations. Park Assist settings will retain the last system state (enabled or disabled) from the last ignition cycle when the ignition device is changed to the **ON** position.

Park Assist system can be active only when the transmission is in R (Reverse) or D (Drive) mode.

If Park Assist is enabled at one of these gear shift positions, the system will remain active under approximately 7 mph (11 km/h).

NOTE:

When in D (Drive) mode, no information about rear obstacles will be shown.

Park Assist Sensors

The four or six Park Assist sensors, depending on mounted optional, located in the rear bumper, monitor the area behind the vehicle that is within the sensor's field of view. The sensors can detect obstacles from the rear bumper in the horizontal direction, depending on the location, type and orientation of the obstacle.

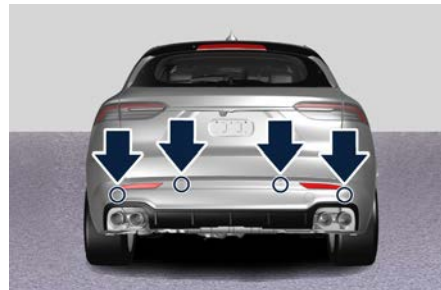

MHEV Version

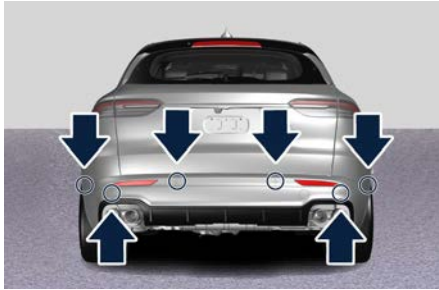

MHEV Version with Surround View (📷)

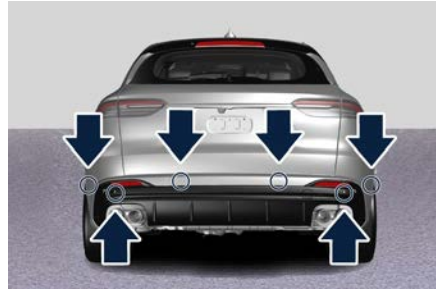

TROFEO Version with Surround View (📷)



TROFEO Version

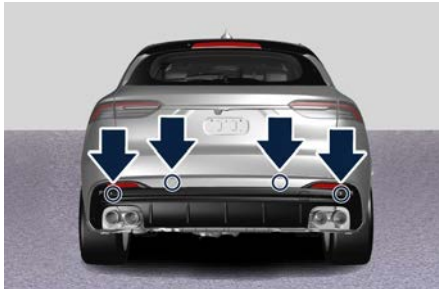

TROFEO Version

The six Park Assist sensors, located in the front bumper, monitor the area in front of the vehicle that is within the sensor's field of view.

The sensors can detect obstacles from the front bumper in the horizontal direction, depending on the location, type and orientation of the obstacle.



MHEV Version

Park Assist Warning Messages Display

The Park Assist warning screen is located on the MIA display.

It provides visual warnings to indicate the distance between the rear bumper and/or front bumper and the detected obstacle.

The warning display will turn on:

- in R (Reverse) mode indicating the system status (ready, idle or off) or when the Rear Parking Camera or the Surround View Camera (SVC) is manually activated;
- in D (Drive) mode when the system is active and detects an obstacle.

The detection area in front of the vehicle is divided into three parts with four arcs in the middle one and two arcs in the lateral one; while the three detection areas behind the car is divided into six



Driver Assistance Systems

arcs in the middle one and two arcs in the lateral ones.

The system will indicate a detected obstacle by displaying arcs with fixed color and a characteristic sound according to the obstacle distance. The color indicates the distance and the arc indicates the position of the detected obstacle. The yellow color of the outer arc indicates the maximum distance, the orange color of the middle arcs indicates the medium distance, while the red color of the nearest arc indicates the minimum distance. The front maximum detection distance is $3.9\text{ ft} \pm 0.3\text{ ft}$ ($1.2\text{ m} \pm 0.1\text{ m}$), while the rear maximum detection distance is $6.6\text{ ft} \pm 0.3\text{ ft}$ ($2\text{ m} \pm 0.1\text{ m}$).

NOTE:

When an obstacle is detected outside the vehicle path, the system displays grayed arcs and the chime will not be active.

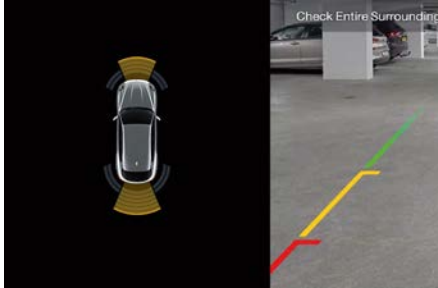
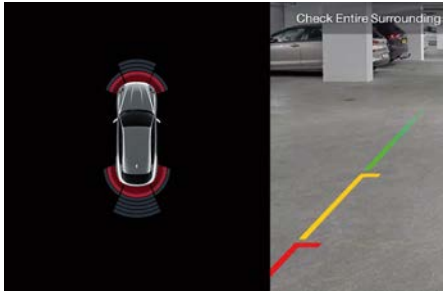
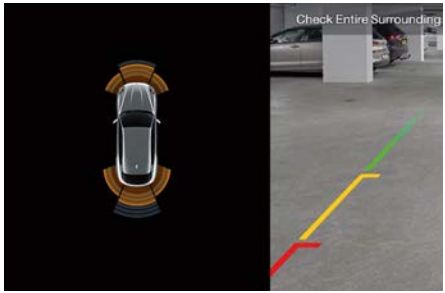

As the vehicle moves closer to the object the MIA screen will display the arc moving towards the vehicle and the sound tone will change from single to slow, to fast and to continuous. The vehicle is close to the obstacle when the MIA screen displays one red arc only, combined with a continuous sound.

NOTE:

- When in D (Drive) mode, if previously not in R (Reverse) mode, the front

detection system will active only the two arcs closer to the bumper.

- Park Assist will turn off the front park assist audible alert (chime) after approximately 3 seconds when an obstacle has been detected and the vehicle is stationary.

Enabling and Disabling Park Assist

By accessing the submenu "Safety & Driving Assistant" from MIA system, the "Park Assist" can be enabled or disabled (checkbox "On/Off"). The available options regarding the warning alerts sound are: "Low", "Medium" or "High". Also front sensors can be disabled unchecking the "Front Sensors Active in Drive" box in the setting list. Refer to "Functions of Settings Menu on MIA" in section "Dashboard Instruments and Controls" for further information.

NOTE:

If "Front Sensors Active in Drive" setting is not selected, but "Park Assist" is active, front sensors will be re-activated in the current maneuver when in R (Reverse) mode until the vehicle speed is below 7 mph (11 km/h) in Drive gear.

If the vehicle speed is below 7 mph (11 km/h), park sensors can be enabled or disabled for the current maneuver at



any time by pressing the soft-key on the bottom bar of the Comfort Display only if "Park Assist" is enabled on the MIA screen.



The soft-key will be on in an amber color when the entire Park Assist system is temporarily disabled or not activated in the setting list. The soft-key will turn white when the system is enabled again.

NOTE:

- If the "Park Assist" setting is deactivated, a pop up will appear on the Comfort Display if the user press the soft-key.
- When the system is in fault, the soft-key will be grayed and the user cannot change the system status using the soft-key.

When the transmission is into R (Reverse) or D (Drive) and the system is temporarily disabled or not active in the setting list, the MIA screen will display

the "PARK ASSIST Off" image until the transmission remains in R (Reverse) or when the transmission is moved in D (Drive), if "Rear View Camera Delay" is active in the setting list.



When the transmission is in P (Park), N (Neutral) mode and in standstill condition or the vehicle speed exceeds approximately 7mph (11 km/h) mode, the system status is in "idle state" and a grayed car is visualized on the MIA screen.

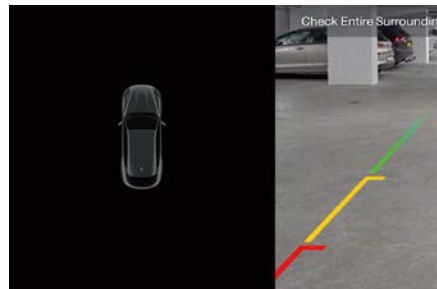

Active Park Braking

When a rear obstacle is detected and the Active Park Braking setting is activated on the MIA screen (see "Functions of Settings Menu on MIA" in section "Dashboard Instruments and Controls") and the vehicle is moving backwards (Reverse gear is engaged) at a speed lower than 7 mph (11 km/h), the system brakes automatically to prevent/mitigate collision and the following layout will be shown.

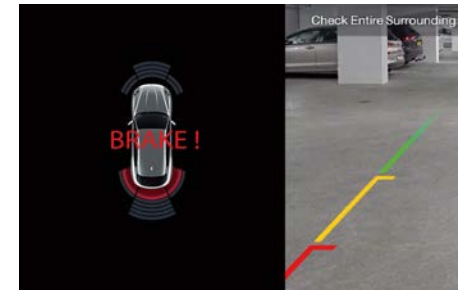

NOTE:

- This function must be enabled together with the Park Assist in the setting list to work properly. If deactivated, the Active Park Braking OFF is displayed on the car graphic on the MIA screen.
- Sensors fault, Park Assist system fault, braking system fault, trailer connection or CORSA mode on turn this function unavailable. In these cases, a pop-up (Continued)



(Continued)

- will appear on the cluster display to inform the driver.
- The Active Park Braking event will not hold the vehicle indefinitely. After a short period of about 3 seconds, the driver gets back the control of the vehicle.
- The braking system event can be overridden by applying the throttle or disabling the Park Assist.
- The Active Park Braking system will provide autonomous braking even when the driver may have partial brakes applied.
- When Active Park Braking is activated, additional Active Park Braking events will be suppressed until the ultrasonic sensors no longer detect any objects behind the car. Once this happens, the Active Park Braking system can activate again as needed for newly detected objects.

WARNING!

- Active Park Braking is not intended to avoid a collision on its own. The driver has the responsibility to avoid a collision by controlling the vehicle via braking and steering.
- The Active Park Braking system is not intended to be an emergency braking

- system; always control the vehicle via braking and steering.
- The system may not work properly on uneven roads, wet or icy roads.
- The Active Park Braking feature target is to avoid obstacle collision when speed is below 7 mph (11 km/h); however when speed is between 4-7 mph (6-11 km/h) the avoidance of a collision with the obstacle is not guaranteed.

Side Distance Warning (with Surround View only)

To let the side distance warning work, it must be activated on the MIA screen together with the Park Assist (see “Functions of Settings Menu on MIA” in section “Dashboard Instruments and Controls”). When the ignition device is turned ON and the Surround View screen is displayed on the MIA display, the system needs to initialize covering a minimum distance equal to the length of the vehicle; during this phase, hourglasses are shown on the sides of the car on the screen (see figure).

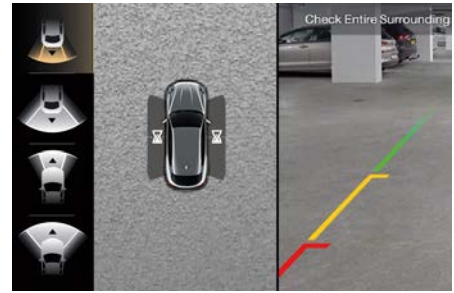

The side distance warning adds four more arcs on the vehicle sides in the top view. The color indicates the distance and the arc indicates the position of the detected obstacle. The orange color of the outer arc indicates the maximum distance (1 - 2.13 ft / 30 - 65 cm), while the red color of the nearest arc indicates the minimum distance (0 - 1 ft / 0 - 30 cm).

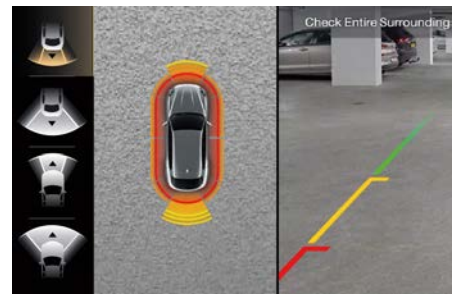

Service the Park Assist System

In case of malfunction of the Park Assist system, the instrument cluster will actuate a single sound, once per ignition cycle. The instrument cluster will display a message when any of the rear or front sensor(s) are blocked by snow, mud, or ice and the vehicle is into R (Reverse), D (Drive) or N (Neutral) mode.

The instrument cluster will display a message when any of the rear or front sensors are damaged and require service.

When the transmission is set to R (Reverse), D (Drive) or N (Neutral) mode and the system has detected a faulted condition, the instrument cluster will display the message and the corresponding soft telltale. Under this condition Park Assist will not operate. See “Warning and Indicator Lights” in section “Dashboard Instruments and Controls” for further information. A related graphic will also be displayed on the MIA screen.

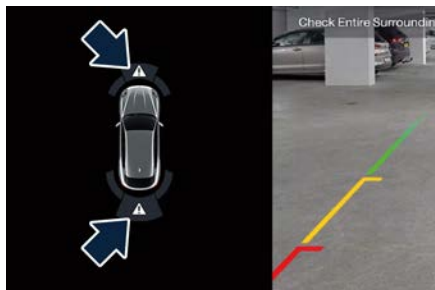

If the instrument cluster displays a message prompting you to clean the sensors, make sure the outer surface and the underside of the rear bumper and/or front bumper is clean and clear of snow, ice, mud, dirt or other obstruction and then cycle the ignition device. If the message continues to appear contact the **Authorized Maserati Dealer**.

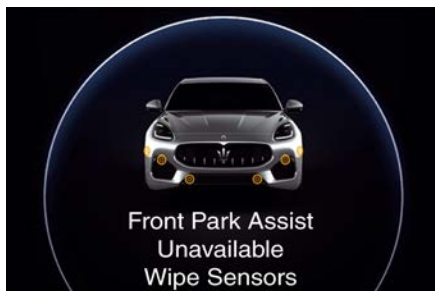

If a failure message is displayed on the instrument cluster, contact an **Authorized Maserati Dealer**.

Cleaning the Park Assist Sensors

When cleaning the sensors, take special care not to scratch or damage them; therefore, do not use dry, rough or hard cloths.

The sensors must be washed with clean water, possibly adding car shampoo. Should you need to repaint the bumper or in case of paint touch-ups in the sensor area, please contact exclusively an **Authorized Maserati Dealer**. Incorrect paint application could affect the parking sensors operation.

Park Assist System Usage Precautions

NOTE:

- Jackhammers, large trucks, and other vibrations could affect the performance of Park Assist.
- Objects such as bicycle carriers, trailer hitches, etc., must not be placed within 12 in (30 cm) from the rear bumper while driving the vehicle. Failure to do so can result in the system misinterpreting a close object as a sensor problem, causing the service Park Assist message to be displayed in the instrument cluster.



WARNING!

- **Park Assist is only a parking aid and it is unable to recognize every obstacle, including small obstacles. Parking curbs might only be temporarily detected or not detected at all. Obstacles located above or below the sensors might not be detected when they are in close proximity.**
- **The vehicle must be driven slowly when using Park Assist in order to be able to stop in time when an obstacle is detected. When backing up, it is recommended that the driver looks over his/her shoulder when using Park Assist.**



WARNING!

Drivers must be careful when backing up even when using the Park Assist system. Always check carefully behind your vehicle, look behind you, and be sure to check for pedestrians, animals, other vehicles, obstructions, and blind spots before backing up. You are responsible for safety and must continue to pay attention to your surroundings. Failure to do so can result in serious injury or death.

Park Assist Volume

The volume of the acoustic signal emitted by the front and rear parking sensors is set to the medium level. Three different level of volume can be selected the submenu “Safety & Driving Assistant” of the "Settings" page on MIA. Low level is useful in certain conditions when the parking sensor acoustic signal keeps coming on although there is no actual collision hazard. This may typically occur when driving in a queue or when the vehicle is overtaken by motorcycles or other vehicles on one or both sides in a queue of traffic. When you set the volume, only the parking sensor acoustic signal will be affected. The radio or any other devices connected to the vehicle sound system will not be affected. Refer to chapter “Functions of Settings Menu on MIA” in section “Dashboard Instruments and Controls” for further information.

Operation with a Trailer

The operation of the rear sensors is automatically deactivated when the trailer's electric plug is inserted in the vehicle's tow hook socket, while the front sensors stay active and can provide acoustic and visual warnings.

The rear sensors are automatically reactivated when the trailer's cable plug is removed.



Rear Parking Camera

Your vehicle is equipped with a rear parking camera that allows you to see an image on the MIA screen of the rear surroundings of your vehicle whenever the transmission is put into R (Reverse) mode.

When “Rear View Camera Delay” mode is enabled, the rear view image shall be displayed for about 10 seconds unless the vehicle speed exceeds 8 mph (13 km/h) after shifting out of R (Reverse) mode.

To assist the driver during maneuvers on dead-ends/roads and on intersections, the vehicle may be equipped with an optional surround view camera system. In this case, the rear parking camera is integrated into the surround view camera system. In both configurations (rear parking camera only or surround view camera system), you can always monitor the rear view. For more details on this option, see chapter "Surround View Camera System" in this section. The image will be displayed along with a caution note to “Check Entire Surroundings” across the top of the screen. After five seconds this note will disappear.

The rear parking camera is located on the rear of the vehicle above the rear license plate.



When the transmission is shifted out of R (Reverse), the rear camera mode is exited if “Rear View Camera Delay” is not selected in the setting list. Instead, when the transmission is set in P (Park), N (Neutral) or D (Drive) mode it is possible to activate the system by touching the “Rear View Camera” soft-key in "Controls" menu of the "Vehicle" or in the App page. If manually activated in these ways, Park Assist view will expire after 10 seconds that the vehicle speed exceeds 8 mph (13 km/h). With transmission in P (Park), N (Neutral) or D (Drive) mode, the upper right corner of the screen will show the “X” key: touch it to go back to the previous screen of MIA display.

The deactivation of the rear visualization via “X” soft-key is not possible when the transmission is in R (Reverse) mode.

NOTE:

Exiting the screen touching the "X" soft-key will not active again the Park Assist view in D (Drive) mode if the vehicle does not exceed 8 mph (13 km/h).

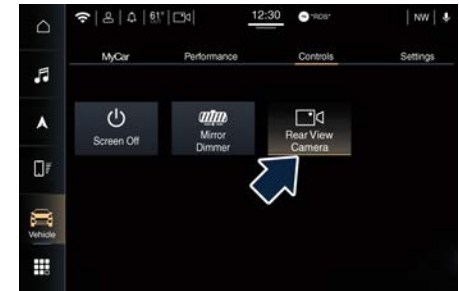

When displayed, dynamic grid lines (if the function is set to MIA through the "Settings" menu of the "Vehicle" page) will illustrate the width of the vehicle to assist with parking or aligning to a hitch/receiver. The dynamic grid lines will show separate zones in different color that will help indicate the distance to the rear of the vehicle. The following table shows the approximate distances for each zone and color:



Zone	Distance to the rear of the vehicle
Red	7 - 12 in (18 - 30 cm)
Yellow	12 - 39 in (30 cm - 1 m)
Green	39 - 118 in (1 - 3 m) or greater

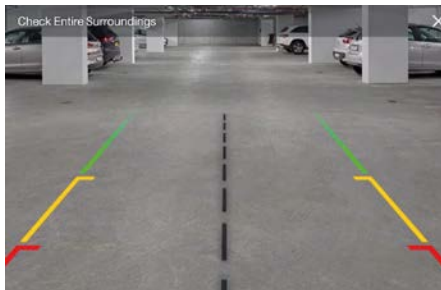

WARNING!

Drivers must be careful when reversing even when using the rear view camera. Always check carefully behind your vehicle, and be sure to check for pedestrians, animals, other vehicles, obstructions, or blind spots before reversing. You are responsible for the safety of your surroundings and must continue to be careful while reversing. Failure to do so can result in serious injury or death.

CAUTION!

- To avoid vehicle damage, the rear camera should only be used as a parking aid, as the rear camera is unable to view every obstacle or object in your drive path.
- To avoid vehicle damage, the vehicle must be driven slowly when using the rear camera to be able to stop in time when an obstacle is seen. It is recommended that the driver looks frequently over his/her shoulder when using the rear camera.

NOTE:

- If snow, ice, mud, or any other substance builds up on the camera lens, clean the lens, rinse with water, and dry with a soft cloth.
- When all the Rear View Camera system is unavailable, a blue screen appears to inform the driver of a loss of communication with the radio.

Surround View Camera System

System components

The system uses four cameras to monitor the area around the vehicle, placed on the front grid, under the side rear-view mirrors and on the liftgate, between the number plate lights.





When the transmission is set in R (Reverse) mode the top view and rear view of the surrounding scenario will be automatically displayed on MIA display. Image will be displayed with active guidelines, if activated in the setting list, as long as vehicle remains in R (Reverse) mode.



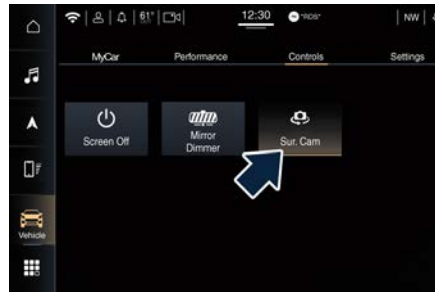

When vehicle is shifted into a different gear, if the camera delay is activated on the MIA screen, the image will remain displayed for about 10 seconds unless the vehicle speed exceeds 8 mph (13 km/h). If the transmission is shifted in P (Park) mode, the surround view screen will be immediately canceled and the radio will return to the last-viewed screen.

Instead, when the transmission is set in P (Park), N (Neutral) or D (Drive) mode it is possible to activate the system by touching the "Surround View Camera" soft-key in "Controls" menu of the

"Vehicle" or in the App page, if the vehicle speed is below 8 mph (13 km/h); otherwise the soft-key becomes grayed. If manually activated in these ways, the camera view will expire after 10 seconds the vehicle speed exceeds 8 mph (13 km/h).



Once the "Surround View Camera" screen is displayed, it is possible to choose which images to display according to 4 possible views.

-  Rear view and top view
-  Rear cross path view and top view
-  Front cross path view and top view
-  Front view and top view

In any gear shift mode, when "Surround View Camera" screen is displayed, a pop up message will appear in the upper

part for 5 seconds to advise the driver to check the surrounding scenario before any maneuver.

With transmission in P (Park), N (Neutral) or D (Drive) mode, the upper right corner of the screen will show the "X" key: touch it to go back to the previous screen of MIA display.

The deactivation of the rear visualization via "X" soft-key is not possible when the transmission is in R (Reverse) mode.

Choose the most suitable view for the situation and the maneuver you are performing or going to perform, by touching the soft-key present on the left of the display: the edges of the pressed button will highlight. The icon will highlight and the type of selected view will appear on each image.

In the top view, the vehicle is represented as it is during the maneuver (see example in the figure).

To display also the dynamic lines of the trajectory you are setting, it is necessary to set this function by accessing the "Settings" menu on "Vehicle" page of MIA, at "Camera" item, by using the dynamic gridlines activation menu.

For further information, see "Functions of Settings Menu on MIA" in section "Dashboard Instruments and Controls".



Driver Assistance Systems

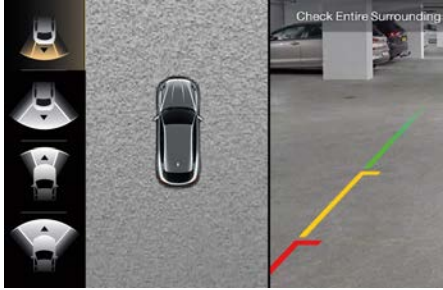

The following table shows the approximate distances for each zone and color:

Zone	Distance to the rear of the vehicle
Red	6 - 12 in (15 - 30 cm)
Yellow	12 - 39 in (30 cm - 1 m)
Green	39 - 118 in (1 - 3 m) or greater

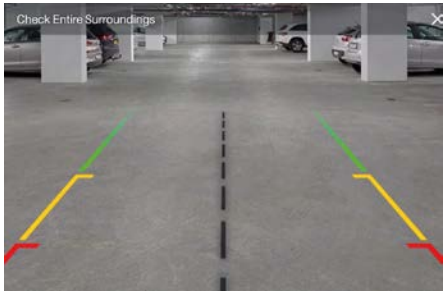

NOTE:

- When a camera fail occurs, the proper visualization and the top view will be blackened out.
- In fault conditions, when it is not possible to change view, the soft-key on the left of the display will be grayed out.
- When all the Surround View Camera system is unavailable, a blue screen appears to inform the driver of a loss of communication with the radio.



WARNING!

Failure to follow the precautions below might result in serious injury or even death.

- Drivers must be careful during maneuvers also when using the camera system with surround view.
- Always check carefully the areas around your vehicle, before proceeding forward or backward.
- Be sure to always check for any pedestrians, animals, other vehicles, obstructions, or blind spots.
- The driver must use the utmost caution while using the system to avoid damage to property or personal injury.
- The camera system with surround view is designed for use during the day or under good lighting conditions. Do

not use and rely on the system under poor lighting conditions.

- Distance lines and directional lines must be used only as a reference and only when vehicle is on a flat ground. The distance shown on MIA display must be interpreted as a reference and might be different from the distance actually present between the vehicle and any displayed objects.
- Any obstacles present above the cameras cannot be detected.



CAUTION!

- To avoid vehicle damage, the camera system with surround view should only be used as a parking aid, as the cameras are unable to view every obstacle or object in your drive path.
- To avoid vehicle damage, the vehicle must be driven slowly when using the camera system with surround view, to be able to stop in time when an obstacle is seen. It is recommended that the driver looks frequently over his/her shoulder when using this system.

NOTE:

If snow, ice, mud, or any other substance builds up on the camera lens,

clean the lens, rinse with water, and dry with a soft cloth. Do not cover the lens.

Hill Descent Control - HDC

HDC maintains vehicle speed while descending hills during various driving situations, by actively controlling the brakes.

HDC is part of the ESC system and has three possible states:

- Off: function is not enabled and will not activate.
- Enabled: function is enabled and ready but activation conditions are not met, or driver is actively overriding with throttle application.
- Active: function is enabled and actively controlling vehicle speed.

Displayed Information

HDC status is represented by icons at the top of the display, in the dedicated area. See "Instrument cluster overview" in section "Dashboard Instrument and Controls".

Enabling and Activating the System

HDC is enabled by pressing the HDC soft-key on the bottom bar of the Comfort Display.



The following conditions must also be met to enable HDC:

- Maximum activation speed: 20 mph (40 km/h).
- Parking brake is released.
- CC or ACC not engaged.
- SL not engaged.
- ESC ON.
- Drive mode not in CORSA.

HDC enabling is indicated by the white light with default set speed at 4 mph (4 km/h) on display coming steady on. The light remains white when driving on a flat stretch of road between two descents, or when the descent is over. Failed enabling is indicated by a message on display.

Once enabled, when driving the system automatically activates HDC.

When the vehicle is between a defined threshold of slope (from 8% to 3%), the light turns white with default set



Driver Assistance Systems

speed at 4 mph (4 km/h). In this stage, the driver can modify the HDC set speed. When the vehicle exceeds a defined threshold of slope (8%), the light turns green and the current set speed appears below it. Therefore, the vehicle speed is increased or decreased until it reaches the default value.

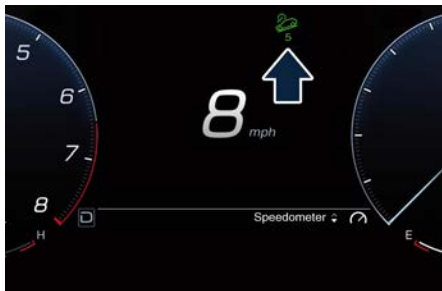

Setting

The set speed for HDC is selectable by the driver, and can be adjusted by using the brake pedal unit or the multifunction control on steering wheel, which is the same used to set the Cruise Control (see “Cruise Control - CC” or “Adaptive Cruise Control - ACC” in this section).

- If the driver brakes, the speed is reduced and the HDC set speed is updated according to the current vehicle speed, up to 1 mph (2 km/h)
- If the driver accelerates without exceeding the maximum limit value of

20 mph (40 km/h) the HDC set speed does not change; when s/he releases the accelerator pedal HDC reduces the vehicle speed to the previous HDC set speed. The set value appears under the green light on the display.

Or:

- Push (SET -) multifunction switch or press the brake pedal to decrease the speed up to 1 mph (2 km/h). The set value appears under the green light on the cluster display.



- Push (SET +) multifunction switch to increase speed until the required value is displayed below the green light on display.



HDC Deactivation

HDC is deactivated by pressing the HDC soft-key on the bottom bar of the Comfort Display.

Driver Override

If the driver pushes the accelerator and the vehicle speed exceeds the set speed, the white light will stay on.

- HDC will be deactivated but remain available when driver pushes the accelerator steadily, without exceeding 20 mph (40 km/h). A pop up message and the white light will stay on.
- When the vehicle speed exceeds 20 mph (40 km/h) but is lower than 40 mph (50 km/h) this function turns to stand-by mode, the light with below the set speed turns white. In this case, to reset the function it is necessary to reduce speed below 20 mph (40 km/h).
- While, if speed exceeds 40 mph (50 km/h), system will immediately disable

the function and the  light will turn off.

Brake Overheating with HDC

When HDC deactivates due to overheated brakes, the soft-key on the Comfort display is not active. The system will be activate again once the brakes have cooled sufficiently.



WARNING!

- Hill Descent Control (HDC) is only intended to assist the driver in controlling vehicle speed when descending hills. The driver must remain attentive to the driving conditions and is responsible for maintaining a safe vehicle speed.
- Prolonged use of the system might overheat the brakes. In case of brake overheating, the HDC, if active, will be progressively deactivated after warning the driver; function can be reactivated only after brake temperature has decreased sufficiently. Distance that can be traveled depends on brake temperature, load and vehicle speed.
- The performance of a vehicle equipped with HDC must never be exploited in a reckless or dangerous manner that

could jeopardise the driver's safety or the safety of others.

Speed Limiter - SL

Using the controls located on the right side of the steering wheel, the driver can set a maximum speed limit (SL function) or maintain a constant cruise control (CC function) speed without operating the accelerator pedal. If set, these two functions SL and CC will exclude each other according to the driver's maneuvers.

SL allows the driver to set the maximum speed limit to be reached by the vehicle. It is possible to exceed the set maximum speed by firmly pressing on the accelerator pedal. After that, if the SL function is still active, once the driving speed returns under the set value, the SL function will continue to limit the speed.

Controls

The controls are located on the right side of the steering wheel.

Control configuration depends on which driver assist systems are installed to the vehicle (see "Controls on Steering Wheel" in section Dashboard and Instruments and Controls).

There is a specific button to engage and disengage the SL.



Control "pulse activation" buttons have the following functions:

SLIM ON/OFF "pulse activation" button to engage/disengage SL system.

Multifunction switch:

- SET+ / SET-**
 - SET + / SET - : Increase / Decrease speed, set current speed
- RES**
 - RES: Resume previously set speed when system is in paused status
- CANC**
 - CANC: Pause (SL disengaged). The set limit is not deleted (see paragraph "Temporary Deactivation" in this chapter)

Displayed Information

Apart from the pop-up messages at the center of the display, SL system status is represented by icons at the top right of the display, in the dedicated area. See

Instrument cluster overview in section "Dashboard Instruments and Controls". Displayed information depends on system status: ready, set, temporarily canceled or override.

Activation

Push the **SLIM ON/OFF** button to engage the system. The **SLIM** white light in upper right sector of the display will illuminate and the last set speed is shown.



To disengage the system, push the same button a second time. The **SLIM** light will turn off and a new message pops up for 5 seconds, then the display returns to the previous setting.

When the SL function is activated, the system automatically disengage the CC function if it was active. See chapter "Cruise Control - CC" in this section for further information.

NOTE:

The system must be disengaged when not in use.

Speed Range of Use

Speed	mph (km/h)
Minimum	0
Engaged/activated	18 (30)
Maximum	130 (210)

Setting

Turn on the SL function when the vehicle has reached the desired speed, push the button (SET-) or (SET+) and the system sets and visualizes beside the **SLIM** green light the current speed limit (in the example shown 30 mph).



Pushing the button (SET +) or (SET -) once, or long pressing it will enable to increase or decrease the set speed by one unit (1 mph or 1 km/h).



If the car is equipped with ADAS Systems, the short press of the button will increase or decrease the set speed of 1 mph or 1 km/h; a long pressure of the same will increase or decrease the set speed of 3 mph.

Release the button when the desired speed is reached, and the new set speed will be visualized beside the green light. The set speed memory can only be erased by pressing the LIM ON/OFF button or by turning the ignition off.

Temporary Deactivation

A press of the button (CANC), with SL function on, erases temporarily the set speed memory, that will remain displayed beside the LIM white light.

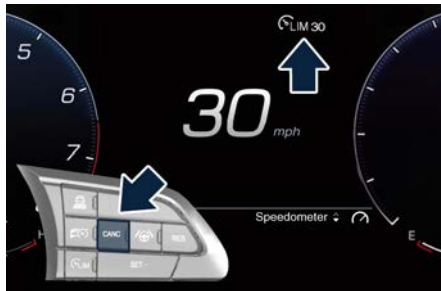

Pressing the brake pedal the SL function remains engaged, while the CC function, if it was active will be temporarily deactivated.

To resume the set speed, read the next paragraph.

Resume Speed

To resume a previously set speed, push the button (RES) and release it. If you resume the set speed, but driving at a higher speed, the message shown in the picture below appears on the display and a buzzer alerts the driver.



The system cuts the engine torque and the LIM green light with beside the set speed will turn on.

Drive Override

If the driver presses the accelerator pedal to overtake another vehicle and exceeds the set speed limit, the set speed and the LIM green light will blink until the speed returns below the set speed.

It is possible to do so at any driving speed, considering that it is possible to

set a minimum speed of 18 mph (30 km/h).

Intelligent Speed Assist - ISA

(OPT)

The ISA system, where provided, is combined with the Speed Limiter system and TSA (Traffic Sign Assist) system and suggests an automatic speed adjustment to the driver based on the speed limit for the road being traveled. You can decide whether to accept or reject the proposal to adjust the speed set by the SL to match the one suggested by the speed limit symbol, according to manual or automatic function set, by using the RES button located on the steering wheel.



A corresponding message will be shown on the instrument cluster display.



Activation / Deactivation

Activation

The system can be activated/deactivated by the Setting list on the MIA screen (see "Functions of Settings Menu on MIA" in section "Dashboard Instruments and Controls").

Deactivation

The system is deactivated under the following conditions:

- when the Traffic Sign Recognition system is deactivated;
- when the Speed Limiter device is deactivated.

NOTE:

Selecting "Traffic Sign Assist Sensitivity" it is possible to set the speed increment to which the ISA system will adjust, up to a maximum of 5 mph or 10 km/h above the speed limit sign detected by the system, or the speed decrement to which the ISA

system will adjust, down to a minimum of 5 mph or 10 km/h below the speed limit sign detected by the system. In these cases, the road sign information shown on the instrument panel display will remain that detected by the TSA system.

Indications on the Display

The system status is always shown by a dedicated green icon on the instrument cluster display, in the upper right of the screen.

Acceptance / Rejection of the Suggested Speed

The system can be activated if the driver has previously activated:

- the Speed Limiter device;
- the Traffic Sign Assist system.

When these systems are active, the instrument cluster display can show an icon that indicates the suggested speed (provided by the TSA system) which the driver can decide to accept or reject using the RES button on the steering wheel.



To accept the proposed speed and consequently adjust the speed set by the Speed Limiter, push the RES button. If ISA is set in "Manual" mode on the MIA screen, RES button confirm the suggested speed. If ISA is set in "automatic" mode on the MIA screen, the system will adapt automatically the speed, the driver can push RES within 5 seconds to reject the new speed. If the driver accepts the value suggested by the ISA or if the speed set using the



Speed Limiter device is the same as the that detected by the Traffic Sign Assist system, the speed limit sign on the instrument cluster display will be highlighted with a green circle.



Cruise Control - CC

The electronic Cruise Control (CC) enables the driver to maintain the desired vehicle speed without pressing the accelerator pedal, reducing driving fatigue on highways, especially long trips, as the set speed is automatically maintained. A firm press on the accelerator pedal will temporarily suspend the cruise control function, while a firm press on the braking pedal will temporarily deactivate the cruise control function.

NOTE:

The device can only be switched on at speeds exceeding 18 mph (30 km/h) and is temporarily suspended when the accelerator pedal is pressed.



WARNING!

The Cruise Control function must only be activated when traffic and the route permit a constant speed to be maintained safely for a sufficiently long distance.

Controls

The Cruise Control controls are located on the right side of the steering wheel. Control configuration depends on which driver assist systems are installed to the vehicle (see "Controls on

Steering Wheel" in section "Dashboard Instruments and Controls"). In the standard configuration there is a specific button to enable and disable the CC.



Control "pulse activation" buttons have the following functions:

Configuration

 ON/OFF "pulse activation" button to engage/disengage CC system.

SET+
SET-

- SET+ / SET - : Increase / Decrease speed, set current speed.

RES

- RES: Resume previously set speed when system is in cancelled status.

CANC

- CANC: Deletes the set speed.



Driver Assistance Systems

In order to ensure proper operation, the CC system has been designed to shut down if multiple systems are operated at the same time (example: CC and FCW). When conditions so allow, the CC system can be reactivated by pushing the RES button.

Displayed Information

Apart from the pop up messages at the center of the display, CC system status is represented by icons on the display, in the dedicated area. See "Instrument cluster overview" in section "Dashboard Instrument and Controls".

Displayed information depends on system status: ready, set, temporarily canceled or override.

Activation

To turn the system on, push the ON/OFF button. The white light with beside 3 dashes on the display will illuminate.



To turn the system off, push the ON/OFF button a second time. The white light will turn off.



WARNING!

Never leave the Cruise Control system on when not in use. You could accidentally set the system or cause it to go faster than you want. Always leave the system off when you are not using it.

Speed Range of Use

Speed	mph (km/h)
Minimum	20 (30)
Engaged/activated	20 (30)
Maximum	130 (210)

Setting Desired Speed

Turn on the CC function. When the vehicle has reached the desired speed

(in the example: 100 mph), push downward the multifunction switch (SET -) and release.

The green light with beside the desired speed will illuminate on the cluster display.



Release the accelerator and the vehicle will operate at the selected speed.

NOTE:

The vehicle should be traveling at a steady speed and on level ground before pushing the button (SET-).

Pressing the "ON/OFF" button or moving the ignition device in **STOP** position erases the set speed memory.

Changing Speed Setting

Pushing the button (SET +) or (SET -) once will enable to increase or decrease the set speed by one unit (1 mph or 1 km/h). If the car is equipped with ADAS Systems, the short press of the button



will increase or decrease the set speed of 1 mph or 1 km/h; a long pressure of the same will increase or decrease the set speed of 5 mph or 10 km/h.

Release the button when the desired speed is reached, and the new set speed will be visualized beside the green light. Each subsequent tap of the multifunction switch will increase or decrease the speed by 1 mph or 1 km/h.

Temporary Deactivation

A soft tap on the brake pedal, pressing the button (CANC), or normal brake pressure while slowing the vehicle will temporarily deactivate the CC without erasing the set speed memory. The  white light with beside the set speed will appear on the cluster display.

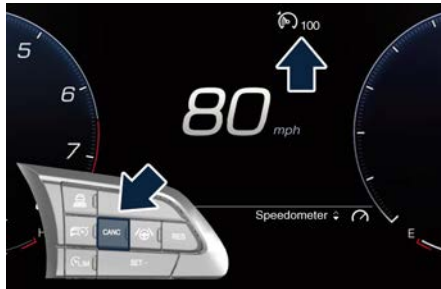

Driver Override

If the driver presses the accelerator pedal while the CC is on, such as to overtake another vehicle, and exceeds

the set speed limit, the system will temporarily suspend the CC. When the accelerator pedal is released, the vehicle will return to the set speed.

Resume Speed

To resume a previously set speed, push the button (RES +) and release. The  green light with beside the set speed will illuminate on the display. Resume can be used at any speed above 18 mph (30 km/h).

Using Cruise Control on Hill

The transmission may be downshifted and the brake may be used on hills to maintain the vehicle set speed. The CC system maintains set speed up and down hills. A slight speed change on moderate hills is normal. On steep slopes it is recommend to drive without CC.



WARNING!
Cruise Control (CC) can be dangerous where the system cannot maintain a constant speed. Do not use CC in heavy traffic or on winding, icy, snow-covered or slippery roads.

Adaptive Cruise Control - ACC

The Adaptive Cruise Control (ACC) is part of ADAS equipments.

Warnings and Cautions

The ACC further increases the drive comfort ensured by the Cruise Control (CC). ACC can work in any type of road; however, its use it is not recommended in urban scenario.

Always consider that ACC is not a safety system and is not designed to prevent accidents.

The ACC allows driver to keep CC active in limited or moderate traffic conditions with no need to constantly restore the CC.

The ACC uses a radar sensor, located on the front grille behind the trident, and the camera behind the internal rear-view mirror to detect the presence of a vehicle ahead at a close distance and moving in the same direction.



This vehicle, in this chapter, will be indicated as "target vehicle" or "vehicle ahead".

NOTE:

- If the sensor detects no vehicle ahead, the ACC system will maintain set steady speed.
- At the time instant the ACC sensors detect a target vehicle, the system keeps the time gap selected by the driver. In the same way, the ACC adapts the vehicle speed according to both time gap and set speed selected by the driver.



WARNING!

- **The Adaptive Cruise Control (ACC) is designed to increase vehicle driving comfort. It must not be considered as a means replacing the required attention of the driver. The driver is always required to drive carefully. The driver is always required to pay utmost attention to driving conditions (road, traffic, weather) and style (speed, distance from sensed vehicle ahead, brake use). Driver has the full responsibility of the vehicle therefore the driver's attention is crucial to keeping vehicle control in particular when approaching curves, rounds and situations with heavy traffic. Failure to follow these warnings can result in a collision and death or serious personal injury.**
- **In some driving scenarios, the ACC could have detection problems. In such cases, the ACC could kick in late or unexpectedly. The driver must be careful since his/her intervention could be necessary.**
- **It is always driver responsibility to obey to speed limits and to keep minimum legal distance to the preceding vehicle.**

- **ACC system can decelerate only with limited braking, it cannot execute emergency braking.**

The ACC system:

- Does not activate/react in the presence of pedestrians, bicycle and not licensable vehicle in general, incoming traffic from opposite direction.
- Is meant for the use on highways and well-build roads, not for city traffic or mountain roads.
- May not have enough time to react and/or decelerate sufficiently on vehicles when lane is changed too fast or the relative speed is too high. In such cases the driver has to react appropriately also without any acoustic/visual warning.
- Cannot consider road, traffic and weather conditions and might prove limited when visibility is poor.
- Does not always fully recognise complex driving conditions and this could cause wrong assessment of the required safety distance.

It is recommended to disable the ACC system in the following instances:

- When driving in the fog, heavy rain, heavy snow, slush, heavy traffic and similar complex situations such as for instance highway sections where there are men at work.



- When entering a junction lane or a slip road to leave the highway; when driving on narrow, icy, snowy, slippery roads, or on steep up and downhill roads.
- The system is designed and calibrated for car with no trailer.
- When circumstances do not allow to drive safely at constant speed.

Displayed Information

ACC condition, as well as the ALM and ADA status, is displayed on display after selecting "Driver Assist" menu (see "Main Menu Contents" in section "Dashboard Instruments and Controls"). Displayed information depends on system status: ready, set, temporarily canceled or override.

Apart from the image at the center of the display, ADAS systems status is represented by icons at the top left and right of the display. These icons remain displayed even when you exit the "Driver Assist" screen.

ADAS system status is also displayed in the right digital dial (ADAS area) when the main menu is not in "Driver Assist" screen.

The vehicle(s) and horizontal bars represent the ACC status as ready (white) or with sensed vehicle ahead (green); the white, gray, green or yellow

lines represent the ALM and ADA systems.

The ACC screen can be displayed any time driver changes system status or settings.

System Controls and Activation Conditions

The "pulse activation" buttons on steering wheel R/H side control ACC operation and the other functions/driver assist systems installed to this vehicle.

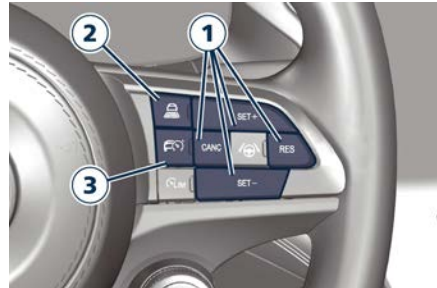

1. Multifunction control shared by all driver assist functions/systems:
 - SET+ / SET - : Increase / Decrease speed, set current speed.
 - RES: Resume previously set speed when system is in canceled status.
 - CANC: Cancel the function if it was in set status, going in a ready condition but remembering the previous set speed.

2. ACC time gap: pressed and released; set the distance to sensed vehicle ahead as horizontal bars (setting cycle starts to 4 bars).
3. ACC ON/OFF button.

NOTE:

Any change made to tire dimensions affects performance of Adaptive Cruise Control and Forward Collision Warning.

The ACC is not activated or engaged in the following conditions:

- When braking.
- Anti-Lock Brake (ABS) kicks in.
- When parking brake is activated.
- When automatic transmission is in P (Park), R (Reverse) or N (Neutral) mode.
- When vehicle speed is out of preset speed range.
- When brakes are too hot.
- When driver door is open below 5 mph (8 km/h).
- When the driver's seat belt is unbuckled below 5 mph (8 km/h).
- When the road is particularly steep (both uphill and downhill) at low speed.
- The Electronic Stability Control and the Traction Control System (ESC/TCS) activate.
- When there is an object too close in front of the vehicle.

It is possible that more than one system is active at the same time such as ACC and ADA just to mention some.



Driver Assistance Systems

While activation of ACC and CC at the same time is impossible.

Speed Range of Use

Speed	mph (km/h)
Minimum	0
Engaged/activated	20 (30)
Maximum	130 (210)

Activation/Deactivation

NOTE:

Pictures show status of ACC and ALM systems.

Press and release ON/OFF button to activate the ACC and enter the "Driver Assist" page. The display will show in the top right corner the white symbol with beside 3 dashes will illuminate indicating that system is ready to be set. In the main area the symbology of the other ADAS system set will be displayed.

When exiting the "Drive Assist" page, the ADAS symbology will remain on the top right corner and in the right digital dial.

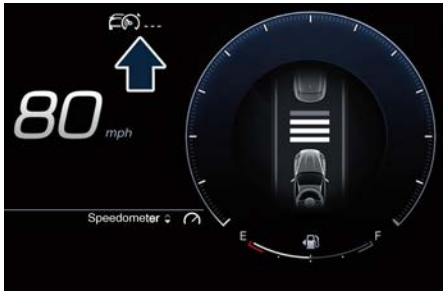

Push the ON/OFF button a second time and release to turn the system off. A pop up message is displayed for 2 seconds to indicate that ACC was disabled.



WARNING!

Leaving the Adaptive Cruise Control (ACC) system on when not in use is dangerous. You could accidentally activate the system or cause it to go faster than you want. Always leave the system off when you are not using it.

Setting the Speed

When vehicle reaches required speed, press and release the button (SET - / SET +). The display will show set speed corresponding to vehicle current one. Speed value will be indicated beside the green symbol and above the distance bars, in the center of the display.



Remove foot from accelerator pedal and vehicle will continue at set speed.



Driver Override

If driver accelerates beyond the set speed or faster than the car would do autonomously, the time gap bars will become grey to remember that in this condition the system cannot control the distance between vehicle and sensed vehicle ahead. Vehicle speed will be determined only by the accelerator pedal position.

Changing Speed Setting

Once speed is set, driver can increase or decrease it by respectively pressing the button (SET +) or down (SET -). Speed can be increased or decreased in two ways:

- Pressing control once, set speed will increase or decrease by one unit corresponding to 1 mph (1 km/h).
- Hold the control to increase or decrease set speed by 5 mph (10 km/h) at a time.

NOTE:

- When pressing the button (SET +) or (SET -), the new set speed will be the current speed of the vehicle.
- When using (SET -) control to decelerate, if the engine braking power does not slow down the vehicle sufficiently to reach the set speed, the

brake system will automatically slow down the vehicle.

- The ACC system applies the brake down to a full stop when following a target vehicle. If an ACC host vehicle follows a target vehicle to a standstill, after two seconds the system will not be able to resume driving the car autonomously. At this point it is necessary the intervention of the driver on the multifunction control (press RES) or press the accelerator pedal (see “ACC Operation Before and During Stop” in this chapter).
- The ACC system maintains set speed when driving up hill and down hill. However, a slight speed change on moderate hills is normal. In addition, downshifting or the use of the brake may occur while climbing uphill or descending downhill. This is normal operation and necessary to maintain set speed. When driving uphill and downhill and the brake is used, the ACC system will cancel if the braking temperature exceeds normal range.

Temporary Deactivation

A soft tap on the brake pedal, pushing the button (CANC), or normal brake pressure while slowing the vehicle will temporarily deactivate the ACC without erasing the set speed memory. The 

white light will appear on the display with beside the set speed.

Conditions for Disabling and Deactivation

Besides the cases specified in the previous paragraph, the following conditions will disable the system:

- When ride height is "Off Road 1" or "Off Road 2", or drive mode is "OFF ROAD".
- "CORSA" drive mode is set.
- The driver disabled the ESC using the ESC Off soft-key on the Comfort Display.

The system is deactivated and set speed is deleted from system memory, if the ACC ON/OFF button is pressed or if ignition device is turned to **STOP**.

Resuming Speed

If a speed setting is stored in system memory, press the button (RES) and take foot off the accelerator pedal. The last set speed will be displayed.



WARNING!

The resume function should be used only when road and traffic conditions allow it. Resuming a too high or too low speed for current traffic and road conditions could cause a harsh vehicle acceleration or deceleration which could



increase the risk of collisions and death or serious injury.

Setting the Time Gap

The specified time gap has four different settings, identified by 4 horizontal bars that represent 4 different time gaps:

- Maximum (longest) time: 4 bars (default time).
- Long time: 3 bars.
- Medium time: 2 bars.
- Short time: 1 bar.

Based on both time gap, selected by the driver, and the actual vehicle speed, ACC calculates the distance to keep from the vehicle ahead.



If another information covering ADAS visualization in the main area (textual pop ups, NAVI information, phone call, etc...) are displayed, the ACC time gap symbol shall be displayed in the top right corner for the time the ADAS in the main area is covered (see detail in picture).

If system does not detect the presence of any vehicles ahead, only the bars referred to set time gap will be displayed.

When system detects the presence of a vehicle ahead, it is displayed in front of the bars (see example in the figure).



To increase or decrease the number of bars, corresponding to the time gap from vehicle ahead, press and release the related setting "pulse activation" button.



Each press and release of the button changes the time gap starting from 4 bars (default time) and moving in a sequential way towards the minimum time: 4→3→2→1→4→3→2→1 and so on. If there is no vehicle ahead, the vehicle will maintain the set speed. If a slower moving vehicle is detected in the same lane, the system displays the target vehicle icon before the bars.

From that moment, the system adjusts vehicle speed automatically to maintain the time gap setting, regardless of the set speed.

The vehicle will then maintain the set time gap until:

- The vehicle ahead accelerates to a speed above the set speed.
- The vehicle ahead moves out of your lane or view of the sensor.
- The time gap setting is changed.
- The driver disables the system.

The maximum braking applied by ACC is limited; however, the driver can always apply the brakes manually, if necessary. Any time the ACC system automatically operates the brakes, the stop lights will turn on as if the driver was braking.

A Proximity Warning on display will alert the driver if ACC predicts that its maximum braking level is not sufficient to maintain the set time gap.



If this occurs, a visual alert will flash on the display and a chime will sound while ACC continues to apply its maximum braking capacity.

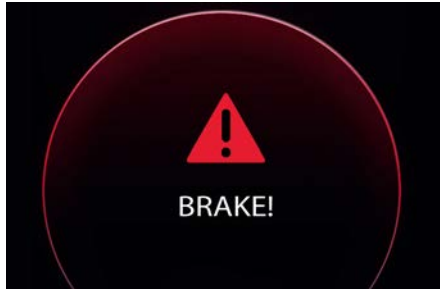

NOTE:

The displayed warning is a warning for the driver to take action and does not necessarily mean that the Forward Collision Warning system is applying the brakes autonomously.

Overtake Aid

When driving with ACC engaged and following a target vehicle, the system will provide an additional acceleration to assist in passing vehicles in front. This additional acceleration is triggered when the driver utilizes the left turn signal to start overtaking. In locations with left hand drive traffic, overtake aid is active only when passing on the left side of the target vehicle.

When a vehicle goes from a location with left hand drive traffic to a location with right hand drive traffic, the ACC system will automatically detect traffic direction. In this condition, overtake aid is active only when passing on the right side of the target vehicle. This additional acceleration is triggered when the driver utilizes the right turn signal to start overtaking. In this condition the ACC system will no longer provide Overtake Aid on the left side until it determines that the vehicle has moved back to a location with left hand drive.

System Operation Before and During Stop

If an ACC host vehicle follows a target vehicle to a standstill, after two seconds the system will not be able to autoresume.

In this condition, displays an instruction message pop up for 5 seconds and the driver have to press the accelerator pedal or resume the ACC speed by acting on the button (RES).

While ACC with Stop is holding your vehicle at a standstill, if the driver unbuckles the seatbelt or opens the door, the ESC system will activate the EPB and cancels the ACC status.



- WARNING!**
- When the Adaptive Cruise Control (ACC) system is resumed, the driver must ensure that there are no pedestrians, vehicles or objects in the path of the vehicle. Failure to follow these warnings can result in a collision and death or serious personal injury.
 - During the automatic stopping behind a vehicle in some rare cases it may happen that the system does not recognize the rearmost point of the vehicle ahead but a target under the vehicle ahead (e.g. the back axle of a truck with a high loading edge or a bumper of a vehicle although overhanging load is hanging over the vehicle's rear). In these cases the system cannot guarantee the appropriate stopping distance leading to collision in the worst case. For this reason the driver has to be attentive and ready to brake during automatic stops.

Display Warnings and Maintenance of ACC and FCW Systems

Wipe Front Radar Sensor Warning

This warning will display and also a chime will indicate when conditions temporarily limit system performance



Driver Assistance Systems

due to sensor poor or failed signal reception. This most often occurs at times of poor visibility, such as in snow or heavy rain. The ACC and FCW systems may also become temporarily blinded due to obstructions, such as mud, dirt or ice on the radar sensor. In these cases, the system will be disabled. This message can sometimes be displayed while driving in highly reflective areas (i.e. tunnels with reflective tiles, or ice and snow). The ACC and FCW systems will recover operation after the vehicle has left these areas. Under rare conditions, when the radar is not tracking any vehicles or objects in its path this warning may temporarily occur.

If weather conditions are not a factor, the driver should examine the sensor. It may require cleaning or removal of an obstruction. The sensor is located in the center of the front grille, behind the Maserati trident.

To keep the ACC System operating properly, it is important to note the following maintenance items:

- Always keep the sensor clean. Carefully wipe the sensor lens with a soft cloth. Be cautious not to damage it.
- Do not remove any screws from the sensor. Doing so could cause an ACC

system malfunction or failure and require a sensor realignment.

- If the sensor or front end of the vehicle is damaged due to a collision, see your authorized dealer for service.
- Do not attach or install any accessories near the sensor, including transparent material or aftermarket grilles. Doing so could cause an ACC system failure or malfunction. When the condition that deactivated the system is no longer present, the system will return to the “Adaptive Cruise Control Off” state and will resume function by simply reactivating it.

NOTE:

If the radar sensor wipe warning message occurs frequently (e.g. more than once on every trip) without any snow, rain, mud, or other obstruction, have the radar sensor realigned at an Authorized Maserati Dealer.

Clean Front Windshield Warning

This warning will display when conditions temporarily limit system performance due to camera poor or failed signal reception. This most often occurs at times of poor visibility, such as in snow or heavy rain and fog. The ACC and FCW systems may also become temporarily blinded due to obstructions, such as mud, dirt, or ice on windshield

and fog on the inside of glass or when driving in bad weather.

In these cases, the system will have degraded performance.

The ACC and FCW systems will recover operation after the vehicle has left these areas. Under rare conditions, when the camera is not tracking any vehicles or objects in its path this warning may temporarily occur.

If weather conditions are not a factor, the driver should examine the windshield and the camera. They may require cleaning or removal of an obstruction. When the condition that created limited functionality is no longer present, the ACC and FCW systems will return to full functionality.

NOTE:

If the windshield wiper warning message occurs frequently (e.g. more than once on every trip) without any snow, rain, mud, or other obstruction, have the windshield and forwardfacing camera inspected at the Authorized Maserati Dealer.

Service ACC/FCW Warning

If the ACC and FCW systems turn off, and the system displays a service warning, there may be an internal system fault or a temporary malfunction that limits functionality.



Although the vehicle is still driveable under normal conditions, ACC and FCW will be temporarily unavailable. If this occurs, try activating ACC and FCW again later, following an ignition cycle. If the problem persists, contact an **Authorized Maserati Dealer**.



Precautions while Driving with ACC

Towing a Trailer



WARNING!

Towing a trailer when using Adaptive Cruise Control (ACC) can lead to serious system failures which can cause severe accidents.

Offset Driving

ACC may not detect a vehicle in the same lane that is offset from your direct line of travel, or a vehicle merging in from a side lane. There may not be sufficient

distance to the vehicle ahead. The offset vehicle may move in and out of the line of travel, which can cause your vehicle to brake or accelerate unexpectedly.

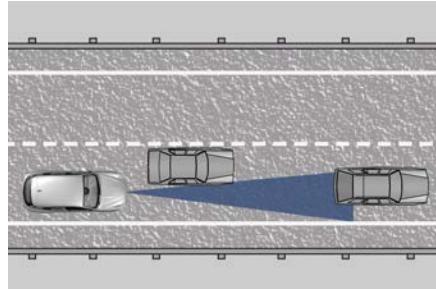

Turns and Bends

When driving on a curve with ACC engaged, the system may decrease the vehicle speed and acceleration for stability reasons, with no target vehicle detected. Once the vehicle is out of the curve the system will resume your original set speed. This is a part of normal ACC system functionality. Moreover, the radar sensor might detect a vehicle on a nearby lane or no longer detect the target vehicle.

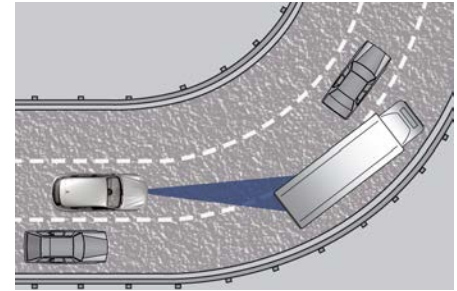

Using ACC on Hills

When driving on steep hills, ACC may not detect a vehicle in your lane when vehicle reaches the crest. Depending on the speed, vehicle load, traffic conditions, and the steepness of the hills, ACC performance may be limited.

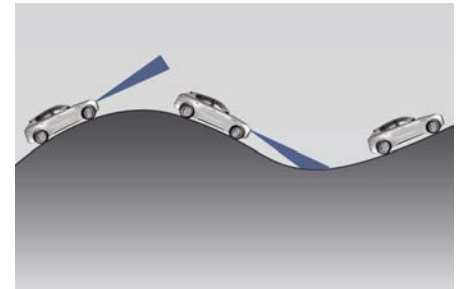

Lane Changing

ACC may not detect a vehicle until it is completely in the lane in which you are traveling.



Driver Assistance Systems

In the illustration shown, ACC has not yet detected the vehicle changing lane and it may not detect the vehicle until it is too late for the driver to take action. ACC may not detect a vehicle until it is completely in the lane. There may not be sufficient distance to the lane changing vehicle.

Always be attentive and ready to apply the brakes if necessary.

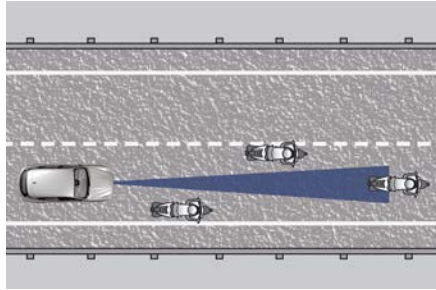

can be consulted by accessing the section “Services” on the website www.maserati.com.

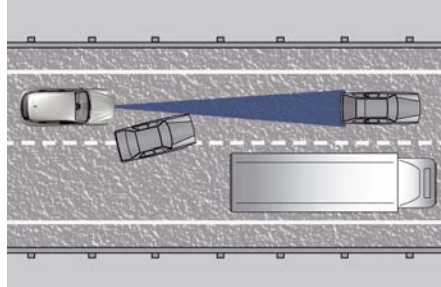

Narrow Vehicles

Some narrow vehicles (like motorcycles) traveling near the outer edges of the lane or edging into the lane are not detected until they have moved fully into the lane. There may not be sufficient distance to the vehicle ahead.

Stationary Objects and Vehicles

ACC reacts to stationary vehicles at low and medium speed. For example, ACC will react in situations where the vehicle you are following exits your lane and the vehicle ahead is stopped in your lane. Always be attentive and ready to apply the brakes if necessary.

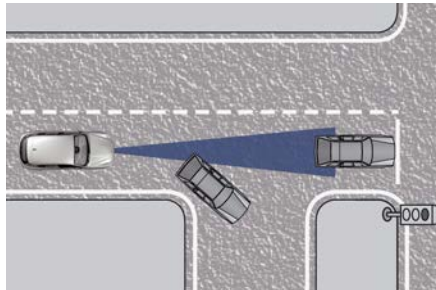

Radar Device - Regulatory Information

The “Regulatory Information” for all the radio frequency and radar devices

Forward Collision Warning - FCW

The Forward Collision Warning (FCW) system with braking action uses the same parts already described for Adaptive Cruise Control (ACC) for sensing vehicle ahead (hereinafter “target vehicle”) as well as part of the warnings/messages on system condition and activation status. Full performance can be reached only when both the sensing parts have detected a vehicle or a pedestrian.



AEB (Automated Emergency Braking)

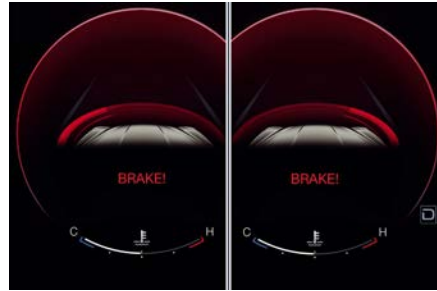

ICA (Intersection Collision Assist) (OPT)

Automated Emergency Braking System

Automated Emergency Braking provides the driver with audible warnings, visual warnings on the instrument cluster display, and may apply automatic braking when it detects a potential frontal collision with a pedestrian or an object.



WARNING!

Automated Emergency Braking is not intended to avoid a collision on its own, nor can it detect every type of potential collision with pedestrian. The driver has the responsibility to avoid a collision by controlling the vehicle via braking and steering. Failure to follow this warning could lead to serious injury or death.

System Limitations

Automated Emergency Braking may be impaired or may not function in the following situations:

- If there is poor visibility, e.g. due to insufficient illumination of the road, if there are highly variable shade conditions or in rain, snow or fog.
- If there is glare, e.g. from oncoming traffic, direct sunlight or reflections from other vehicles.
- If the windshield in the area of the camera is dirty, or if the camera is fogged up, damaged or covered.
- During air suspension transitions.

System Operation

The FCW provides audible and visual warnings when a potential collision is detected. Brake jerk and limited braking may also be applied depending on the specific scenario.

NOTE:

FCW system is not intended for towing; this could lead the system to malfunctions and/or to late reaction.

FCW monitors the information from the forward looking radar sensor and camera (2 more corner radar sensors are present in the front part of the car when ICA is equipped) to calculate the probability of a forward collision; the Electronic Brake Controller (EBC) will execute the brake request. When the system



Driver Assistance Systems

determines that a forward collision is probable, the driver will be provided with audible and visual warnings and may provide a warning brake jerk. If the driver does not take action based upon these progressive warnings, then the system will provide a limited level of active braking to help slow down the vehicle and mitigate the potential forward collision. If the driver reacts to the warnings by braking and the system determines that the driver intends to avoid the collision by braking but has not applied sufficient brake force, the system will compensate and provide additional brake force as required. When the system determines a collision with the vehicle in front of you is no longer probable, the warning messages will be deactivated.

NOTE:

- Bad weather conditions, like strong rain, snow, etc., can lead to reduced system performance. Under these conditions relevant objects will not be detected or detected late by the system.
- FCW is designed to react in specific situations in typical traffic scenarios with objects in the same lane driving in the same direction, but under certain conditions it can also react on

stationary objects in the same lane. The system is designed to react to oncoming traffic or crossing traffic (only with ICA (OPT)).

- The FCW alerts may be triggered on objects other than vehicles such as guard rails or sign posts based on the course prediction. This can occur but it is not part of normal FCW activation and functionality.
- It is unsafe to test the FCW system. To prevent such misuse of the system, after four Active Braking events within an ignition cycle, the Active Braking portion of FCW will be deactivated until the next ignition cycle. The limit of four events applies to the brake jerk too.
- The FCW system is intended for on-road use only. If the vehicle is taken off-road, the FCW system should be deactivated to prevent unnecessary warnings. If the vehicle ride height is set to "Off Road 1" or "Off Road 2", the FCW system will be automatically deactivated.
- FCW will automatically deactivated when ESC OFF button is pressed (LED light up) and when HDC is active.



WARNING!

- **Forward Collision Warning (FCW) is not intended to avoid a collision on its own, nor can FCW detect every type of potential collision. The driver has the responsibility to avoid a collision by controlling the vehicle via braking and steering. Failure to follow this warning could lead to serious injury or death. The driver is always in charge to safely drive and to avoid critical situations not relying on the support of the system. Driver has to keep in mind that the system and therefore its intervention is always subject to the prevailing physical limits.**
- **FCW is not intended either to warn or to apply any brake aid/brake intervention in case of collisions with pedestrians bicycles and smaller vehicles in general.**

Speed Range of Use

Speed	mph (km/h)
Minimum	0
Engaged/activated	3.1 (5)
Maximum	155 (250)

When the speed is outside the specified limits, the system automatically disables without turning on the corresponding warning light on the instrument cluster.



System Status

The driver can adjust FCW status and sensitivity by touching "Forward Collision Warning" soft-key on the "Apps" page or in the "Settings" list of the "Vehicle" page.

Setting options are described in the following paragraph.

When FCW status for some reason changes in off, the corresponding amber warning light on instrument cluster will light on.



This warning light informs the driver that FCW is disabled. This warning light will light even when the activation of another driver assistance function or drive mode disables the FCW.

NOTE:

The FCW system setting chosen by the User is kept in memory only for the current ignition cycle.

System Setting

FCW warning can be set in "On", "Off" or "Warning".

The default status of FCW sensitivity is the "Med (Medium)" setting. When the active braking function ("Forward Collision Warning") setting is on, the system warns you of a possible collision with the vehicle in front of you when you are farther away and it applies limited braking. When in "Near" setting, this gives you the most reaction time to avoid a possible collision.

Changing the sensitivity status to the "Near" setting, allows the system to warn you of a possible collision with the vehicle in front of you when you are much closer. This setting provides less reaction time than the "Warning & Active Braking" sensitivity setting, which allows for a more dynamic driving experience. "Med" is the intermediate status between the two described above.

NOTE:

- The default values shall appear at every new ignition cycle: Sensitivity = "Med" and Status = On.
- FCW may not react to irrelevant objects such as objects not in the path of the car, stationary objects that are far away, oncoming traffic, on cross

traffic vehicles, or leading vehicles with the same or higher rate of speed.

- The active braking (autonomous braking/braking aid) will not engage in case of potential collision with static object such as guard rails, walls, etc..
- If PEB setting is present in the setting list, it can be set on in "warning + active braking"; if PEB setting is not present in the setting list, it is always active.
- If FCW is set off on the MIA screen, but PEB setting is in "warning + active braking", the active brake will still be active.

Changing the FCW status to "Off" inhibits the system from providing limited autonomous braking or additional brake support if the driver is not braking adequately in the event of a potential frontal collision.

In this state the system disables the brake jerk.

Limited Operation and Service Warning

The messages indicating on display the limited functionality or service at an **Authorized Maserati Dealer** required are the same as for the ACC system. For further details, refer to "Adaptive Cruise Control - ACC" in this section.



NOTE:

- The adjustment of the sensor could be affected by strong shocks or light collisions. This could affect the system by reducing the systems performance or could increase the false positive rate. The adjustment of the radar system has to be proved or a new adjustment has to be performed by an **Authorized Maserati Dealer**.
- The radar system, together with the camera, requires specific function to detect objects. The detection could be disturbed/ reduced by environmental influences, for example by electrical field or the object itself. Object with small radar reflection properties could not be detected or detected late.
- When in "CORSA" mode, the FCW function is deactivated.

Radar Device - Regulatory Information

The "Regulatory Information" for all the radio frequency and radar devices can be consulted by accessing the section "Services" on the website www.maserati.com.

Active Lane Management - ALM (OPT, with BSA only)

This system was designed especially for highway or freeway driving, to reduce the risk that the vehicle, under particular circumstances, accidentally departs from the lane in use. When this happens, graphic instructions on instrument cluster display together with steering torque application and steering wheel vibration (depending on the distance to the line and the setting that the driver has chosen from the "Settings" menu on MIA as described in "Customized Settings" of this chapter) warn the driver that the vehicle is going out of the lane initiates a steering maneuver to try to prevent the lane exit.

To detect lane lines, the system uses the forward-facing camera behind of the rear-view mirror, which is the same one used also by the lighting system to manage automatic high beam. The logic core is in the front radar.

ALM system can be enabled or disabled pushing the button located at the end of the left multifunction lever, behind the steering wheel.

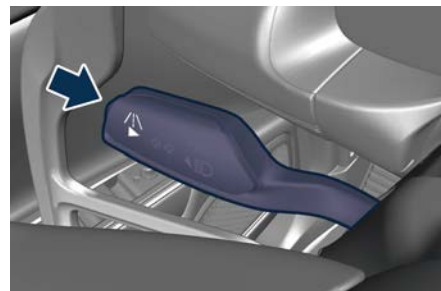

ALM system remembers the condition it was in before turning off the vehicle. Refer to "Functions of Controls Menu on MIA" in section "Dashboard Instruments and Controls" for further information.

NOTE:

In case of wet road or raining conditions the function could be disabled by the system in order to minimize the risks.

Active Blind Spot Assist (ABSA) Intervention

When the system is enabled pushing the button at the end of the left multifunction lever and the driver intends to change lane, using or not the turning light, an active steering maneuver will be performed if another vehicle is detected in the Blind Spot detection zones (see "Blind Spot Assist - BSA" in this section for further information).



Emergency Lane Keeping (ELK) Intervention



WARNING!

In special cases like vehicle oncoming, vehicle overtaking, newjerseys or guardrails, Active Lane Management (ALM) may make an unexpected steering torque application. Lack of attention may lead to serious injury or death.

Speed Range of Use

Speed	mph (km/h)
Minimum	39 (63)
Engaged/activated	39 (63)
Maximum	116 (186)

Customised Settings

ALM is configurable by the customer in order to maximize its efficiency based on the driver driving style and his expectation of the system, reducing at the same time the possible invasiveness. Entering "Settings" menu of the "Vehicle" page on MIA display the driver can see the current setting beside the "Active Lane Management" soft-key. Touching "Active Lane Management" soft-key to enter the setting page.

The system can be set to "Vibration only", "Steering Assist only" and "Vibration + Steering Assist". lane Warning can be set to "Early" (default mode), "Medium" and "Late". Vibration Strength can be set to "Low" (default mode), "Medium" and "High". Steering Assist Strength can be set to "Low" (default mode), "Medium" and "High".

Meanings of Settings

"Vibration and Steering Assist": the system will apply steering torque when lane departure is detected showing at the same time the proper cluster indication, adding to this steering vibration when the departure is very imminent.

When "Vibration and Steering Assist" is selected and of course ALM is enabled then two following menu will be used by the system.

- "ALM Lane Warning": it tunes the distance to the lane boundary interested where the system will start to apply steering torque.
- "ALM Vibration and Steering Assist Strength": it tunes the vibration, steering torque and speed value increasing or decreasing it to have a stronger or weaker trajectory correction/deviation.



WARNING!

In rare cases, Active Lane Management (ALM) may make an inappropriate steering torque application. ALM may be interrupted at any time by counter steering. Lack of attention may lead to serious injury or death.

System Availability

The ADAS systems help the driver while driving. These systems can be set and monitored simultaneously on the display, after opening "Driver Assist" menu (see "Main Menu Contents" in section "Dashboard Instruments and Controls"). When you are not in the "Driver Assist" page, the system status is displayed in the right digital dial (ADAS area). ALM is designed for an attentive driver therefore the system is available only when his/her hands are on the steering wheel or with hands off for a very limited amount of time. When the system is enabled it will trigger cluster warning in case hands are not detected on the steering wheel.

The torque application as well as the vibration are suppressed/inhibited in case of: high driver torque in the steering wheel, high lateral acceleration, hands not on the steering wheel detected for more than a certain time.



Driver Assistance Systems

High dynamic behaviors, driving on the lane boundary, off course will prevent the function from working.

FCW braking and stability system interventions (ESC, ABS) will also prevent the system from operating.

Changing lane results in system inhibition for a certain time. In addition, the road must respect some characteristics such as minimum maximum width, lane clearly defined by two lane boundaries and only in limited cases for a limited time at least one.

The ALM system is active both in the case of both lines visible and available for the system, and in case of the only line available on the road.

Each ALM intervention is notified to the driver with the relative graphics which is shown for the entire duration of the system intervention and for a minimum time of 1 second.

Multiple interventions are allowed both in terms of visual and acoustic signals and in terms of steering torque.

If more than three consecutive interventions are required within a period of 180 seconds, starting from the second intervention the acoustic signal will last 10 seconds longer the previous one.

Starting from the third acoustic signal the system will emit a continuous sound

and a message on the display will indicate to keep the center line.

NOTE:

- **In case of wet road or raining conditions the function could be disabled by the system in order to minimize any risks.**
- **The system is developed to work only on the lines painted on the road surfaces, but it may happen that shadows, traces of old lines, road edges, etc. are also interpreted as such.**
- **The system warns the driver with a pop-up if the vehicle stays near the lane for more than 10 seconds.**
- **The system is not available when in CORSA mode.**

Being this function used to prevent unintentional lane change/lane drift, it will be temporary suppressed/inhibited by a turn indicator activation, therefore, graphic warning, steering torque application and vibration will be terminated. In these conditions the graphics turn gray.

Function Description and Operating Mode

The function intent is to prevent the lane departure by warning the driver through indication on the cluster and if set applying steering torque and vibration.

The graphic intent is to represent at the glance the system knowledge of the lane in front of the car, the system suppression status and warning.

For this a simple color code has been adopted for each line (of the two presented):

- Both gray lines means system enable, not able to operate (suppression condition present or lane detection system not able to estimate properly the lane);
- Left/right gray line: the lane detection system is not able to detect that specific lane boundary;
- Yellow line: there is a steering torque intervention in progress that tries to prevent a departure on that side, in this situation the warning should increase the driver attention requiring him to properly handle the situation;
- Yellow flashing line: the graphic is shown whenever the system detects a very imminent lane departure, at this can be added torque and steering vibration if configured by the customer.

The white lines (one or both) indicates that the corresponding lane boundary is detected and the system is capable to intervene on it.

Whenever the system is enabled there will be graphic on the dedicated screen of the "Driver Assist" page.



An example of this screen with ALM system activated, can be found in the following figures.

ALM system is activated, car is crossing the lane boundary, steering torque and vibration if configured are in progress when this graphic is shown.



The icons that represent the status of the ADAS systems remain displayed in the right digital dial when exiting the "Driver Assist" screen.



System Limitations

Because of physical limits the system to properly operate needs good visibility (it might not work or not properly operate in case of heavy rain, snow, wet roads, fog, direct sun on the camera, etc.).

NOTE:

The sensors are not able to detect the presence of the hands on the steering wheel areas covered in wood, plastic bezels or carbon inserts (where present).

Sharp turns, slopes and change in slopes, poor lane boundaries, as well as construction areas and all the scenario described in this paragraph may challenge the system, therefore be always ready to prevent any unexpected behavior of the car.

Damaged front bumper, windshield replaced without proper technical intervention may also lead to system malfunction or system unavailability.

Other conditions such as fault, but not explicitly indicated here may also prevent/interrupt the system intervention.



WARNING!
If the driver fails to adapt his/her driving style, Active Lane Management (ALM) can neither reduce the risk of an accident nor override the laws of physics. It cannot take into account road, weather or traffic conditions. Active ALM is only an aid. The driver remains responsible for maintaining a safe distance from the vehicle in front, for maintaining a safe vehicle speed for the conditions, for ensuring enough space for safe braking and for staying safely within the designated lane.

System in Faulty

When the ALM cannot properly operate due to a fault of its components or because the windshield in front of the forward facing camera is dirty, the amber light and/or the corresponding message will be displayed.





Driver Assistance Systems

If message suggestion does not allow fixing the fault, avoid using the system and have the vehicle inspected at an **Authorized Maserati Dealer**.

Radar Device - Regulatory Information

The “Regulatory Information” for all the radio frequency and radar devices can be consulted by accessing the section “Services” on the website www.maserati.com.

Blind Spot Assist - BSA (OPT)

System Operation

The Blind Spot Assist (BSA) system uses two or four radar-based sensors, depending on the optional mounted on the vehicle, located inside the bumper fascias, to detect highway licensable vehicles (cars, lorries, motorbikes, etc.) that enter the blind spot zones from the rear/front/side of the vehicle in adjacent lines.

The example shown in the figure highlights the blind spots on either side of the vehicle when overtaking traffic is approaching from behind.

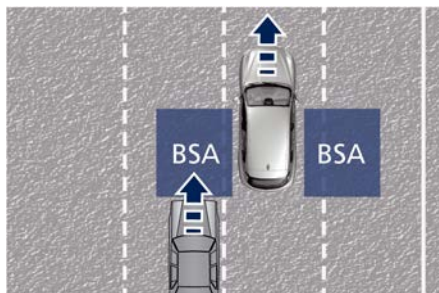

When the vehicle is started, the BSA warning light will momentarily illuminate in both outside rear view mirrors to let the driver know that the system is operational and on. The BSA system sensors operate when the vehicle is in any forward gear and enters standby

mode when the transmission is in (P) Park mode.



The BSA detection zone shown in figure covers approximately one lane on both sides of the vehicle. The blind spot area extends from immediately behind the exterior rear-view mirrors up to behind the rear bumper.

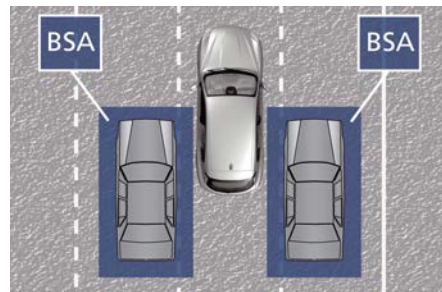

The BSA system monitors the detection zones on both sides of the vehicle to detect the presence of vehicles and begins to warn the driver by flashing the



warning light in the rear view when the vehicle speed reaches approximately 6 mph (10 km/h) or higher.

On the instrument cluster, in the main menu area, vehicles in blind spot while the turn indicator is active on the same side of the detected object shall trigger a bigger yellow glow appearing on the same side of the detected object (corresponds to feedback on the external LED of rear view mirror lights up flashed).



WARNING!

- The Blind Spot Assist (BSA) system does NOT alert the driver about rapidly approaching vehicles that are outside the detection zones.
- The BSA might alert the driver too late especially in case of rapidly approaching vehicles.

- The driver must always pay utmost attention and drive carefully.



WARNING!

Risk of accident despite Blind Spot Assist (BSA). BSA does not detect/react to the following:

- Overtaking vehicles close on the side, placing them in the blind spot area. As a result, BSA may neither give warnings nor intervene in such situations.
- Always pay attention to the traffic situation and maintain a safe distance at the side of the vehicle.

NOTE:

If your vehicle has experienced any damage in the area where the sensor is located, even if the fascia is not damaged, the sensor may have become misaligned. Take your vehicle at an **Authorized Maserati Dealer** to verify sensor alignment. Having a sensor that is misaligned will result in the BSA not operating to specification.

The area on the rear bumper fascia where the radar sensors are located must remain free of snow, ice, and dirt/road contamination so that the BSA system can function properly. Do not cover or block the area of the rear bumper fascia where the radar sensors

are located with foreign objects (bumper stickers, spoilers, bicycle racks, etc.). The BSA system notifies the driver of vehicles or objects in the detection zones by illuminating the BSA warning light located in the outside mirrors in addition to sounding an audible (chime) alert and reducing the radio volume (if the radio is on). Refer to “BSA and RCP Setting” in this chapter for further information.

The BSA system monitors the detection zone from three different entry points (side, rear, overtaking traffic) while driving to see if an alert is necessary. The BSA system will issue an alert whenever a vehicle enters any one detection zone as outlined below.

Speed Range of Use

Speed	mph (km/h)
Minimum	6 (10)
Engaged/activated	6 (10)
Maximum	–

NOTE:

Performance is guaranteed up to a maximum speed of 112 mph (180 km/h).

Entering from the Side

Vehicles that move into your adjacent lanes from either side of the vehicle.



Driver Assistance Systems

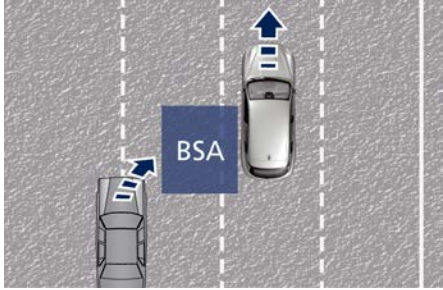

Entering from the Rear

The alert will turn on when the vehicles that come up from behind your vehicle on either side and enter the rear detection zone with a relative speed of more than 27 mph (43 km/h).

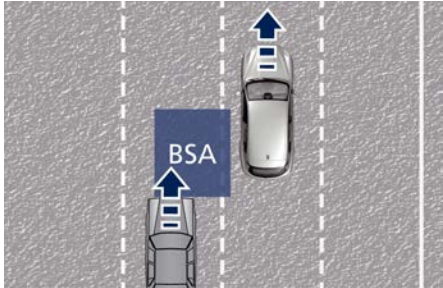

Overtaking Traffic

The figures show the vehicle approaching (A) and passing (O) another vehicle in the overtaking lane. If you pass another vehicle slowly, the vehicle remains in the blind spot for

approximately 2 seconds, the BSA warning light in the outside mirror will illuminate after 1.5 seconds. If the difference in speed between the two vehicles is greater, the warning light will not illuminate.

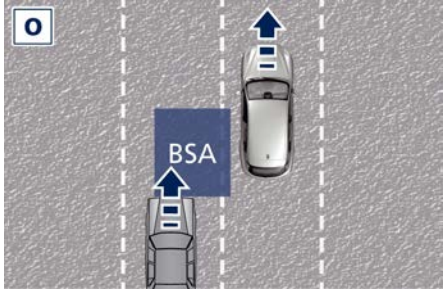
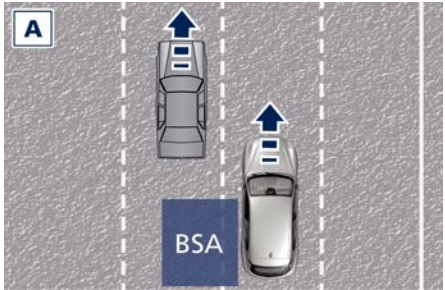

Other Cases

The BSA system is not designed to issue an alert on stationary objects such as guardrails, posts, walls, foliage heaps, berms, etc. However, occasionally the system may alert on such objects. This is

normal operation and your vehicle does not require service.

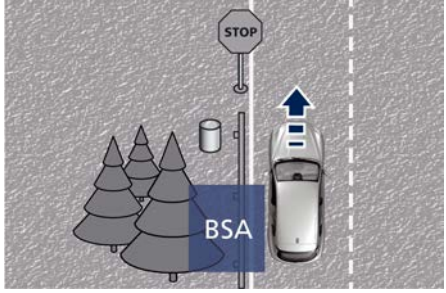

The BSA system will not alert you of objects that are traveling in the opposite direction of the vehicle in adjacent lanes.

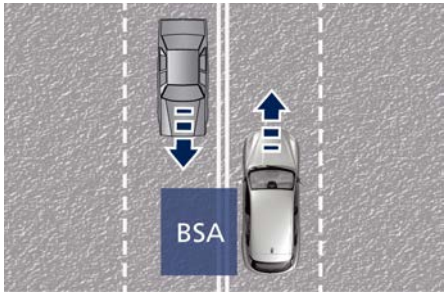

**WARNING!**

- The Blind Spot Assist (BSA) system is only an aid to help detect vehicles in the blind spot zones.
- The BSA system is not designed to detect pedestrians, cyclists, or animals.
- Even if your vehicle is equipped with the BSA system, always check your vehicle's outside and rear-view mirrors for any vehicles approaching from behind or overtaking.
- Use your turn signal before changing lanes.

RCP - Rear Cross Path (RCP)

The Rear Cross Path (RCP) function is intended to aid the drivers when gear in reverse of parking spaces where their vision of oncoming vehicles may be blocked.

The RCP system monitors the rear detection zones on both sides of the vehicle. Using sensors located on either side of the rear bumper, it detects vehicles or objects that are moving toward the side of the vehicle with a minimum speed of approximately 1 to 2 mph (1 km/h to 3 km/h) to a maximum of approximately 10 mph (16 km/h), such as in parking lot situations.

NOTE:

In a parking lot situation, oncoming vehicles can be obscured by vehicles parked on either side. If the sensors are blocked by other structures or vehicles, the system will not be able to alert the driver.

Proceed slowly and cautiously out of the parking space until the rear end of the vehicle is moderately exposed.

The RCP system will then have a clear view of the cross traffic. If an oncoming vehicle is detected, the RCP system will alert the driver using both the visual and audible alarms. If the radio is on, it will also reduce the radio volume.

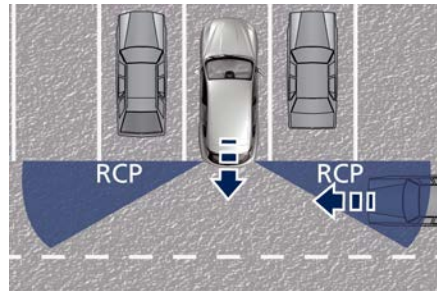
**WARNING!**

Rear Cross (RCP) is not a Back Up Aid system. More specifically, it is intended to be used to help a driver detect an oncoming vehicle in a parking lot situation. Drivers must be careful when backing up, even when using RCP. Always check carefully behind your vehicle, look behind you, and be sure to check for pedestrians, animals, other vehicles, obstructions, and blind spots before backing up. Failure to do so can result in serious injury or death.

BSA and RCP Setting

Setting modes can be selected from the MIA system.

Touch “Settings” soft-key on “Vehicle” page and then select “Blind Spot Assist” soft-key to enter the setting page.

Refer to chapter “Functions of Controls Menu on MIA” in section “Dashboard Instruments and Controls” for further information.

BSA in Visual Mode

When operating in “Visual” mode, the BSA system will provide a visual alert in the appropriate side view mirror when it detects a vehicle or an object in the detection areas monitored by its sensors: depending on the status of the relative turn indicator, the warning light



Driver Assistance Systems

can be fixed or flashing. However, when the system is operating in RCP mode, it will respond with both visual and audible alerts when an oncoming vehicle or an object approaching the rear end side of the vehicle is detected.

Whenever an audible alert is requested, the radio is muted (if the radio is on).

BSA in Visual and Acoustic Mode

When operating in “Visual & Acoustic” mode, the BSA system will provide a visual alert in the appropriate side view mirror based on a detected vehicle or object.

If the turn signal is then activated, and it corresponds to an alert present on that side of the vehicle, an audible chime will also be sounded: in the same moment the warning light will start flashing.

Whenever a turn signal and detected vehicle or object are present on the same side at the same time, both the visual and audio alerts will be issued. In addition to the audible alert, the radio volume will be reduced (if the radio is on).

NOTE:

If the hazard flashers are on, the BSA system will issue the appropriate visual alert only.

When the system is in RCP mode, the system shall respond with both visual

and audible alerts when a detected vehicle or object is present. Whenever an audible alert is requested, the radio (if on) is also muted.

Right/left turn/hazard signal status is ignored; the RCP status always requests the chime when needed.

Blind Spot Assist Off

When this function is turned off from the MIA, there will be no visual or audible alerts from either the BSA or RCP subsystems.

NOTE:

The BSA system will store the current operating mode when the vehicle is shut off. Each time the vehicle is started, the previously-stored mode will be recalled and used.

System in Faulty

The BSA system cannot properly operate due to a fault of its components, or because the area on the rear bumper fascia where the radar sensors are located is dirty. In these cases the related message will be displayed on the instrument cluster.



In these cases avoid using the system and have the vehicle inspected at an **Authorized Maserati Dealer.**

Radar Device - Regulatory Information

The “Regulatory Information” for all the radio frequency and radar devices can be consulted by accessing the section “Services” on the website www.maserati.com.

Drowsy Driver Detection - DDD (DPT)

System Intervention

Using information from the front camera and the steering wheel, the system implements the following operating logic:

It takes the driving style into account, observing the road and detecting to what extent the driver can continue driving with few oscillations and few lane marking crossing events; the system works when the vehicle speed is above 43.5 mph (70 km/h) and below 100 mph (160 km/h).

NOTE:

If the driving style indicates that the driver is unable to follow the road trajectory and respect the horizontal lane markings, the red symbol  with a cup will appear on the instrument cluster display to suggest that the driver should stop for a break. An auditory signal is also emitted.

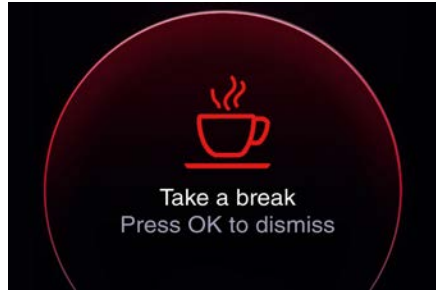

- If the driver accepts the suggestion provided by the system by pressing the OK button on the left steering wheel spoke and stopping for a pause, the message will disappear from the display and the symbol  will be displayed in the dedicated area of the instrument cluster display up to the next engine shutdown/restart.
- If the driver ignores the warning provided by the system and does not stop, the message will continue to remain on the display.



NOTE:

- In the event of a system fault, the amber  symbol appears on the instrument panel display together with a dedicated message.
- In the case of camera failure, the system sensitivity cannot be changed.



WARNING!
The DDD system is an aid for driving and does not relieve the driver of responsibility for driving the car. If you experience fatigue while driving, pull over safely for a break without waiting for the DDD to intervene.

Only get back on the road when you are in the right physical and mental condition to prevent endangering yourself and other road users.



Active Driving Assist – ADA



The Active Driving Assist (ADA) is a level 2 autonomy system (in reference to SAE standards) that is designed to aid the driver in the steering, acceleration, and braking functions of the vehicle.

ADA can work in any type of road. However, its use is not recommended in urban scenarios. ADA centers the vehicle by controlling the EPS system based on lane line information from the forward-facing camera and data from the front radar sensor.

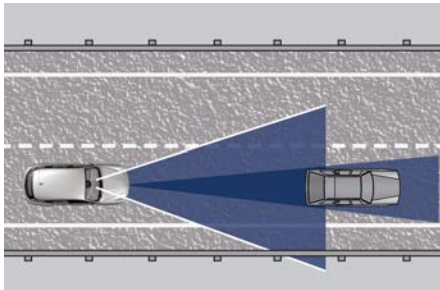

ADA combines ACC and lateral control to manage the steering and speed of the vehicle under specific conditions. The conditions to engage ADA are listed in the next paragraph. If a lane line cross is imminent, the steering wheel will vibrate (if enabled on the MIA screen) and a

graphic will display on the instrument cluster.



WARNING!

- In case the vehicle approaches a curve that is too tight the driver must be prepared to take over control of the vehicle immediately at any time. To avoid this situation it is important that the vehicle speed is not set higher than the current speed limit of the road.
- Active Driving Assist (ADA) is a hands-on function! You must keep your hands on the steering wheel at all times. The ADA system will disengage and ACC will cancel if your hands are removed from the steering wheels for a set amount of time.
- ADA is intended for use only on highways or limited access freeways, freeways, etc. with a fully attentive driver. When using ADA, hold the steering wheel and be aware of surrounding traffic, traffic roundabout, road conditions and different scenarios where the system could not be effective. Always be prepared to immediately take over control of the vehicle from the ADA system. Failure to follow these instructions could result in serious injury or death.

- The following list does not fully represent all situations in which ADA may not function as intended. Do NOT solely rely on the ADA system to control the vehicle. It is the driver's responsibility to stay alert and safely control the vehicle at all times.
- If the windshield is replaced, you must have the forward-facing camera remounted and aligned by an Authorized Maserati Dealer.

Many factors can impact the performance of ADA causing the system to be unable to function as intended.

These include (but are not limited to):

- Narrow, winding or curvy roads.
- Poor visibility (due to heavy rain, snow, fog, etc.).
- Bright light (oncoming headlights or direct sunlight) or shadows.
- Damage or obstruction caused by mud, ice, snow, etc.
- A damaged or misaligned bumper.
- Interference from other equipment that generates electromagnetic waves.
- Wet roads, roads covered or partially covered by snow.
- Construction zones.

System Operation

With ACC set (see "Adaptive Cruise Control – ACC" in this section), ADA system activates by simply pressing the  "pulse activation" button on the



steering wheel. Once the conditions are met, ADA will engage. The system will engage even pressing ADA  button and then set ACC.



WARNING!

The Active Driving Assist (ADA) system may take up to 5 seconds to engage once all conditions are met.

The conditions for ADA to engage are as follows:

- ADA must be turned on or enabled.
- ACC must be engaged.
- Left and right visible lane lines.
- Vehicle speed must be between 0 and 93 mph (0 to 150 km/h).
- No faults in the forward facing camera, radar, EPS, or MIA.
- Lane width between 2.95 and 4.6 yds (2.7 to 4.2 m).
- Turn signal not activated.
- No faults related to this system.

Speed Range of Use

Speed	mph (km/h)
Minimum	0
Engaged/activated (with ACC engaged)	0
Engaged/activated (with ACC not engaged)	20 (30)
Maximum	93 (150)

- If set above the maximum speed, ADA will not function after the vehicle speed will reach the maximum speed.
- If set below the maximum speed and the ACC target speed is increased, ADA will function up to the maximum speed and then the system will turn off automatically.
- When the ACC target speed is reduce and speed is lower than the maximum speed, the system will start automatically.
- If the ACC target speed is set under the maximum speed, ADA is active and vehicle speed increases above the maximum speed due to slope, ADA will continue to function.

Monitoring on Cluster Display

ADA and the other ADAS systems conditions can be monitored on display by accessing the “Driver Assist” page with the buttons on the steering wheel

(see “Instrument Cluster Settings and Menu Overview” in section “Dashboard Instruments and Controls”).

The  symbol in gray indicates that the ADA system is active, but not engaged and is shown at the center of the display when the “Driver Assist” page is displayed.

When exiting the "Driver Assist" page, the ADA information is displayed in the right digital dial (ADAS area).



In addition to these symbols, on the left and right edge a colored glow may appear (further referred to as "attention level color"). Attention level color together with the outline of the symbol  represent a further indication of the system status.

When exiting the “Driver Assist” page, the attention level color will always be displayed until the system is disabled



by pressing the button on the steering wheel.

The ADA system uses sensors in the steering wheel outer crown to detect if the driver's hands are on the steering wheel. If the driver's hands are not detected on the steering wheel, the instrument cluster or the Head Up Display (HUD) if activated, will display a series of warnings to alert the driver to return their hands to the steering wheel. There will also be audible chimes. After a set amount of time, ADA will cancel if the driver's hands are not returned to the steering wheel.

When the system does not sense the hands on the steering wheel after 1 second or more (up to 29 seconds + 6 seconds of chime after deactivation), it tries to draw the attention of the driver by showing, even when the display is not in the "Driver Assist" page, the  symbol with the figure of the hands in the center of the display and on the HUD, if activated. According to such time frames, the system will change the attention level color, silence the audio in the vehicle (if it is active) and emit audible chimes to notify the driver to take the control of the vehicle again. This is the only way to reengage the system.

Hands Detection on Steering Wheel

The steering wheel is able to detect the presence of the hands on it.

In order to be able to use the ADA system, place your hands around the steering wheel outer crown.

NOTE:

The sensors are not able to detect the presence of the hands on the steering wheel areas covered in wood, plastic bezels or carbon inserts (where present).

ADA is deactivated if the steering wheel is no longer being touched.

System Statuses

The active status of the ADA system is indicated by the green attention level color which is maintained even if the driver releases his/her grip from the steering wheel for more than 3 seconds. The graphic information changes as soon as (max 1 second) the driver releases the steering wheel:

- glow color: green;
- lines: green;
- car: centered;
- steering wheel: yellow small in the center.

The yellow attention level color appears when the driver removes his/her hands from the steering wheel for 8 seconds and the  symbol with the figure of

the hands will occupy the pop-up area of the instrument cluster for 8 seconds or the HUD, if activated.



The red attention level color appears when the driver releases his/her grip from the steering wheel for 16 seconds: in this case a single audible chime is repeated until he/she will take the control of the vehicle again. The red attention level color and the chime remains even when the steering wheel is released for more than 16 seconds.



If the driver keeps his/her hands away from the steering wheel (for more than 29 seconds), also the ACC system is deactivated ( white ACC symbol on the display) and will have to be reset. In these cases the display will not show the attention level color anymore and the vehicle will be controlled by the driver only.

System Disengage

To disengage ADA you can do any of the following actions:

- Press the  ADA enable button on the steering wheel.
- Begin steering manually.
- Press brake pedal.
- Turn off ACC.
- Unbuckle the driver's seat belt.
- Shift out of the (D) or (M) Drive mode.
- Enter an Autonomous Emergency Braking (AEB) event (See chapter

"Forward Collision Warning - FCW" in this section).

- Turn signal activated.
- ACC cancellation.

System Cancellation

The ADA system will cancel (without driver intervention) if either of the following actions occur:

- When removing the hands from the steering wheel.
- Lane line markers aren't detected by the forward facing camera.
- The lane intersection or roundabout (traffic circle).
- Any ADAS system faults.
- Vehicle speed exceeds the maximum limit.

NOTE:

When ADA cancels, the  symbol will turn grey.

System Limitations

ADA is unable to guide the vehicle when the following conditions occur.

- Lane markings are not clear or visibility is poor (i.e. heavy rain, snow, fog, etc.).
- Obstructed, covered or damaged forward-facing camera or sensor.
- When driving on hills or sharp curves.
- When approaching toll booths.
- When the highway entrance or exit is wider than 13.8 ft (4.2 meters).
- Bright light (ex. direct sunlight or glare) facing the forward camera.



WARNING!
Many unforeseen conditions can occur that can affect the performance of Active Driving Assist (ADA). Always keep this in mind and drive attentively. It is the drivers responsibility to keep control of the vehicle at all times.

System in Faulty

The ADA system cannot properly operate due to a fault of its components, or because the components themselves or their detection area is obstructed. In these cases the amber warning light and the related message will be displayed on the instrument cluster. In this condition avoid using the system and have the vehicle inspected at an **Authorized Maserati Dealer**.

Radar Device - Regulatory Information

The "Regulatory Information" for all the radio frequency and radar devices can be consulted by accessing the section "Services" on the website www.maserati.com.



Traffic Sign Assist – TSA



TSA detects traffic signs through the use of a forward-facing digital camera mounted on windshield, behind the rear-view mirror and assists the driver by displaying detected speed limits and overtaking restrictions in the instrument cluster. The camera also detects traffic signs with a restriction indicated by an additional sign (e.g. in snow conditions). TSA also uses data of navigation system to retrieve the speed limits when the camera is not able to detect the road where the car is traveling.

Some examples of these are: due to low visibility, light reflection, damaged traffic signs, traffic signs in wrong position like rotated or fallen poles.

NOTE:

- **Overtaking restriction sign will be displayed only in markets where this is allowed.**
- **TSA provides a visual warning + chime to the driver when he/she reaches the speed limit plus the set “Sensitivity” value (+0, +5, +10) depending on the signal tolerance of the indicated speed.**
- **The performance of TSA does not depend on the update degree of navigation system’s maps.**

- **TSA is enabled when in CORSA drive mode.**

Customized Settings

TSA is configurable by the customer regarding the display mode on the MIA screen and the warning sensitivity. Entering "Vehicle" page on MIA display and select the "Traffic Sign Assist" soft-key of the "Settings" menu to enter the setting page.

The check mark on the "Warning Mode" box can be set in "Off", "Visual" and "Visual + Chime".

The display of the traffic signs can be blinking or static.

Signs Monitoring on Instrument Cluster

If TSA function is set and a sign or a speed limit is detected, the related icons are displayed in the upper area of the instrument cluster beside the digital speedometer or they can be visualized even on the Head Up Display, if activated.

The display area is divided in two different sectors:

- 1** No Overtaking + Conditional Unverified Speed Limit area
- 2** Unconditioned Speed Limit or Conditional Verified Speed Limit + arrows up/down

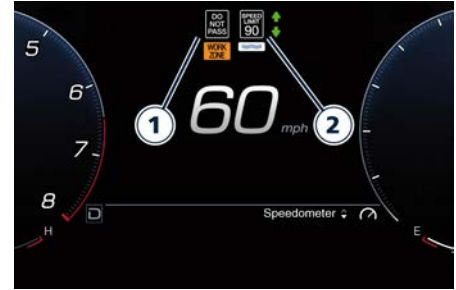

NOTE:

Overtaking restriction sign will be displayed only in markets where this is allowed.

If “Visual or Visual + Chime” warning mode is set, when the visual warning is provided all icons (in sector **2**) will start blinking when the vehicle speed exceeds the speed limit in area **2** plus the set sensitivity value (“+0 mph” - “+0 km/h” or “+5 mph” - “+5 km/h” or “+10 mph” - “+10 km/h” options). If the vehicle speed stays under the speed limit the speed limit sign will stop blinking. If the TSA is not able to determine any kind of valid speed limit neither from camera nor from digital maps, the icons will be grayed out.

Since TSA also uses the data provided by the navigation system, it can update the sector **2** of the display in the following situations without detecting traffic signs:



- When the vehicle changes road.
- Highway enter/exit.
- Urban area stored in the digital map enter/exit.
- No data from the camera.
- Country change.

System Limitations

TSA may be impaired or may not function in the following situations:

- If there is poor visibility, e.g. due to insufficient illumination of the road, if there are highly variable shade conditions or in rain, snow or fog.
- If there is glare, e.g. from oncoming traffic, direct sunlight or reflections from other vehicles.
- If the windshield in the area of the camera is dirty, or if the camera is fogged up, damaged or covered.
- If the traffic signs are hard to detect, e.g. due to dirt or snow, or because they are covered or because of insufficient lighting.
- If the information in the navigation system's digital map is incorrect or out-of-date or changing country.
- If the signs are ambiguous, e.g. traffic signs on construction sites or in adjacent lanes.
- When passing buses or trucks with a speed sticker.

System in Faulty

When the TSA cannot properly operate due to a fault of its components or because the windshield in front of the forward facing camera is dirty, the amber light and/or the corresponding message will be displayed.

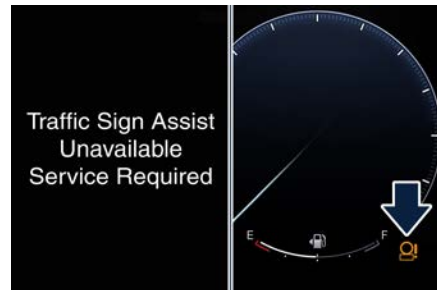

If message suggestion does not allow fixing the fault, avoid using the system and have the vehicle inspected at an **Authorized Maserati Dealer**.





7 - In an Emergency

Tool Kit	246
Hazard Warning Flashers	246
In the Event of an Accident	247
SOS and Assist Call 	247
Engine Overheating	248
In case of a Punctured Tire	248
If a Fuse Blows	249
In Case of External Lights Fault Signal	256
Emergency Release of the Parking Brake	256
Transmission Manual Release of P (Park) Position	257
Freeing the Stuck Vehicle	257
Auxiliary Jump-Start Procedure	258
Towing a Disabled Vehicle	260



In an Emergency

Tool Kit

The tools and other first-aid equipment are located in the trunk inside a preformed containers.

To access the tools, lift the trunk ground coverage, by acting on the handle.



TROFEO Model



MHEV Models

The tools inserted in the trunk containers are the following:

Ref.	Description
1	Double torx + cross-head screwdriver
2	Emergency tow hook
3	Tire repair kit
4	Trailer tongue (OPT)

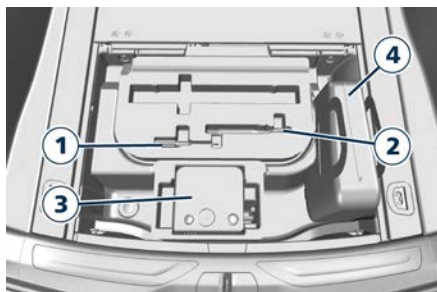

Hazard Warning Flashers

The hazard warning flasher capacitive touch button is located on the left side of the Comfort Display.



Press the soft-key to turn on the hazard warning flashers to warn oncoming traffic of an emergency. When these lights illuminate, the turn signals, the related illuminator lights on the instrument cluster and the button start flashing. Press the soft-key a second time to turn off the hazard warning flashers.

This is an emergency warning system and it should not be used when the vehicle is in motion. Use it when your vehicle is disabled and it is creating a safety hazard for other motorists. When you must leave the vehicle to seek assistance, the hazard warning flashers will continue to operate even though the ignition device is set in **STOP** position.

**CAUTION!**

- When the hazard warning flashers are activated, the turn signals control is disabled.
- The extended use of the hazard warning flashers may wear down your battery.

In the Event of an Accident

It is important always to keep calm.

- If not directly involved, stop at a safe distance of at least ten meters away from the accident area.
- Turn off the engine and switch on the hazard warning flashers.
- At night, illuminate the accident area with the headlights.
- Always act with caution to avoid the risk of being crashed into by other drivers.
- Call the emergency services, providing as much information as possible. On the motor way, use the special call boxes.
- Remove the ignition key (if present) from the vehicles involved.
- If fuel or other chemical products can be smelled, do not smoke and ask people around you to put their cigarettes out.
- To extinguish fires, even small ones, use a fire extinguisher, blankets, sand or earth. Never use water.
- In multiple accidents occurred on motorways, particularly where visibility is poor, there is a high risk of being involved in other collisions. Leave the vehicle immediately and move away from the area.

SOS and Assist Call

For further information  : chapter “SOS and Assist Call” in section “In an Emergency”.



Engine Overheating

To reduce potential overheating of the engine in city traffic, while stationary, place the transmission in N (Neutral) mode, but do not increase the engine idle speed.

NOTE:

There are steps that you can take to slow down an impending overheat condition:

- If your air conditioner (A/C) is on, turn it off. The A/C system adds heat to the engine cooling system and turning the A/C off can help remove this heat.
- You can also turn the temperature control to maximum heat, the mode control to floor and the blower control to high. This allows the heater core to act as a supplement to the radiator and aids in removing heat from the engine cooling system.



CAUTION!

Driving with a hot cooling system could damage the engine. If the temperature gauge is positioned on the red zone “H” (refer to “Instrument Cluster Overview” in section “Dashboard Instruments and Controls”) and the red  warning light comes on, pull over and stop the vehicle. Idle the vehicle with the air conditioner

turned off until the temperature gauge drops back into the normal range. If the temperature gauge remains on the red zone “H” and the red  warning light stays on, turn the engine off immediately and contact an **Authorized Maserati Dealer**.



WARNING!

You or others can be badly burned by hot engine coolant (antifreeze) or steam from your radiator. If you see or hear steam coming from under the hood, do not open it until the radiator has had time to cool.

Never try to open a coolant bottle pressure cap (refer to “Maintenance Procedures” in section “Maintenance and Care”) when the radiator is overheated.

In case of a Punctured Tire

The vehicle is equipped with a tire repair kit.



WARNING!

An unsecured or incorrectly positioned load increases the risk of injury during sharp braking, a sudden change of direction or an accident.

Using Tire Repair Kit

Small punctures up to 1:4” (6 mm) in the tire tread can be sealed using the tire repair kit, fitted beneath the ground coverage of the trunk compartment (see chapter “Tool Kit” in this section).

The kit consists of two parts:

- an electric compressor with pressure gauge and power cable;
- a bottle containing sealant with hose to be connected to the punctured tire.

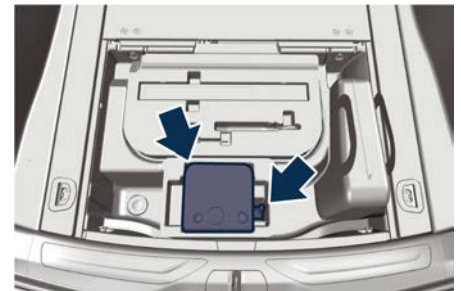

**NOTE:**

For the tire repair procedures with tire repair kit see instructions included in the kit.

This kit will provide a temporary tire seal, allowing you to drive your vehicle up to 6 miles (10 km) with a maximum speed of 50 mph (80 km/h).

**CAUTION!**

- Intruding objects (e.g., screws or nails) should not be removed from the tire, which could compromise the repair with the tire repair kit.
- Do not use the tire repair kit if the tire shows lateral damages and/or the rim is damaged by driving with flat tire.
- Tire repair kit can be used in outside temperatures down to approximately -4°F (-20°C).
- Replace the tire repair kit sealant bottle prior to the expiration date (printed on the bottle label) to assure optimum operation of the system.

NOTE:

- The compressor power plug can be inserted either in the 12 V power outlet housed in the trunk or inside the passenger compartment (see “Internal Equipment” in section “Understanding the Vehicle”).

- When having the tire serviced at an **Authorized Maserati Dealer** or to a tires service center, advise who performs the operation that the tire has been sealed using the tire repair kit.

If a Fuse Blows

Used Fuses Characteristics

When an electrical device is not functioning, check that the corresponding fuse is in proper working order (intact).

A Fuse intact

B Fuse blown



On the vehicle are mainly used with mini-and maxi-fuses with blade engagement.

Besides these there are other types of the fuse provided with holes for fixing to the cable connection terminals. For the replacement of these fuses contact an **Authorized Maserati Dealer**.

Replace the faulty fuse with a new one featuring the same rating, by using appropriate forceps.



In an Emergency

The color identifies the value of the fuses in amperes which is also reported on them.

The table shows the match between color and amperage of mini and maxi fuses.

Type	
Mini Fuse	Maxi Fuse
Beige - 5	Yellow - 20
Brown - 7,5	Green - 30
Red - 10	Orange - 40
Blue - 15	Red - 50
Yellow - 20	Blue - 60
White - 25	
Green - 30	



CAUTION!

- Never replace a blown fuse with anything other than a new and suitable fuse (same rating).
- After replacing a fuse, if the fault recurs, contact an **Authorized Maserati Dealer**.

Position of Fuses

The fuses are located in three parts of the vehicle, namely:

- inside the fuse and relay box, on the front right hand side of the engine

compartment (figures show a MHEV engine);

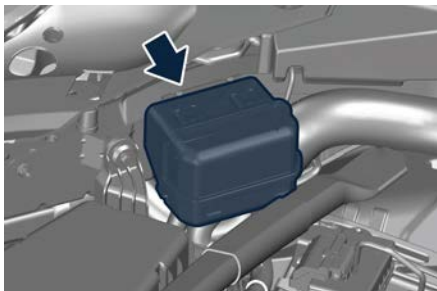

- inside the remote positive post, on right hand side of the engine compartment (figures show a MHEV engine);

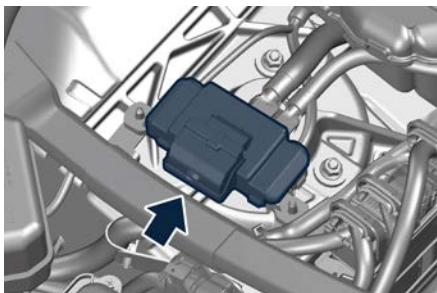

- inside the fuse and relay box, on the rear right hand side of the engine compartment (figures show a MHEV engine);



- in the fuse and relay box located in a covered area, inside the trunk compartment right side.



- on the positive post of the battery, inside the inner central side of the trunk compartment.

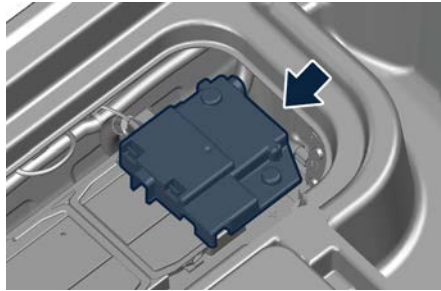

Fuses Box on the Front Right Hand Side of the Engine Compartment

- To access the module it is necessary to lift the hood (see “Open and Close the Hood” in section “Before Starting”).
- To access the fuses remove the module cover unhooking the frontal locks as shown in the picture. To recognize the reference number of the fuses in the table below, see the diagram inside the cover just removed.

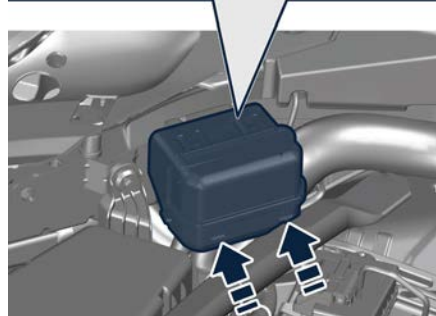
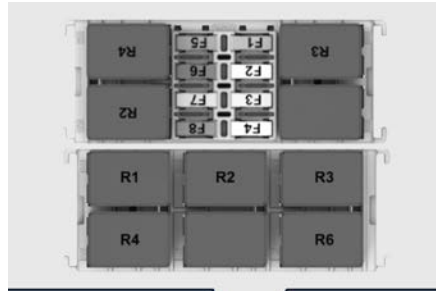

The table points out the position as featured in the cover, the type and function of the fuses included in the box.



- After replacement, refit the protective cover of the module.
- If you need to wash the engine compartment, do not direct the water for too long directly on the module.

Ref.	Type	Function
F1	Mini – 25A	ECM input
F2	Mini – 10A	48 V Loads (DC/DC & E-Booster) (MHEV only)
	Mini – 5A	Eldor Battery input (3.0 V6 Engine)
F3	Mini – 20A	Primary Loads ECM (MHEV only)
	Mini – 25A	Primary Loads ECM LT input (3.0 V6 engine)
F4	Mini – 15A	Fan Battery 48 V (MHEV only)
	Mini – 15A	Secondary Loads LT input (3.0 V6 Engine)



Ref.	Type	Function
F5	Mini – 20A	Secondary Loads input (MHEV only)
	Mini – 20A	Secondary Loads RT input (3.0 V6 engine)
F6	Mini – 7,5A	48 V Pyro (MHEV only)
	Mini – 20A	Primary Loads ECM RT input (3.0 V6 engine)
F7	Mini – 7,5A	Radio Frequency HUB input
F8	Mini – 7,5A	Dome console input
R2	Micro – 30A	Electrical Water Pump input
R3	Micro – 30A	HVAC Blower input
R4	Micro – 30A	Rear HVAC Blower input

Ref.	Type	Function
R1	Micro – 30A	Horn relay
R2	Micro – 30A	Start&Stop relay
R3	Micro – 30A	Starter relay

Ref.	Type	Function
R4	Micro – 30A	ADAS relay
R6	Micro – 30A	Cigarette Lighter relay

Fuses Box on the Rear Right Hand Side of the Engine Compartment

- To access the module it is necessary to lift the hood (see “Open and Close the Hood” in section “Before Starting”).
- To access the fuses remove the module cover unhooking the lateral locks as shown in the picture. To recognize the reference number of the fuses in the table below, see the diagram inside the cover just removed.

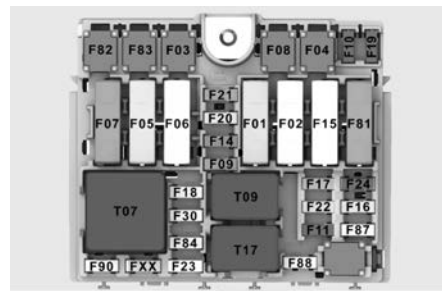



The table points out the position as featured in the cover, the type and function of the fuses included in the box.

Ref.	Type	Function
F01	Maxi – 60A	EPS module
F02	Maxi – 60A	IBS module
F03	Maxi – 20A	Cigarette Lighter / Power Outlet input
F04	Maxi – 40A	IBS valves module
F05	Maxi – 60A	EPS module
F06	Maxi – 30A	ETM R1 module
F07	Maxi – 50A	Engine main input
F08	Maxi – 40A	HVAC Blower input
F09	Mini – 20A	BCM module
F10	Mini – 10A	Horn input
F11	Mini – 10A	EPS module
F14	Mini – 15A	TCM module
F15	Maxi – 20A	Starter input
F16	Mini – 3A	Clockspring input
F17	Mini – 10A	EPS module
F18	Mini – 10A	BCM module

Ref.	Type	Function
F19	Mini – 15A	Devio, HUD & ICS module
F20	Mini – 20A	Top LT Head-lamp input
F21	Mini – 20A	Top RT Head-lamp input
F22	Mini – 20A	Master F24, F87, F90, FXX
F23	Mini – 20A	Electrical Water Pump input
F24	Mini – 10A	DLC module
F30	Mini – 25A	Rear window wiper input
F81	Maxi – 25A	DTCM AWD module
F82	Maxi – 20A	Wiper input
F83	Maxi – 20A	HVAC Rear Blower input
F84	Mini – 7,5A	ECM Module (MHEV only)
F87	Mini – 5A	ADAS input
F88	Mini – 10A	A/C Compressor module
F90	Mini – 10A	ECM/DTCM module

Ref.	Type	Function
FXX	Mini – 10A	ECU HVAC / AQS / RLS module
T07	Maxi – 50A	Engine main relay
T09	Micro – 30A	BCM module relay
T17	Micro – 30A	A/C Compressor relay

Fuse Box in the Trunk Compartment

This box is located in a covered area inside the trunk compartment right side. To access the fuses, remove the cover in the trunk compartment, then remove the module cover unhooking the lateral locks as shown in the picture. To recognize the reference number of the fuses in the table below, see the diagram inside the cover just removed.



In an Emergency

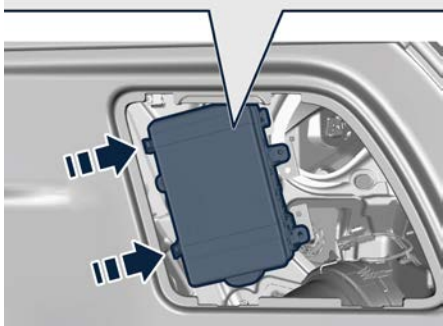
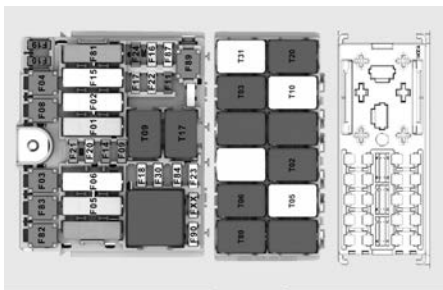
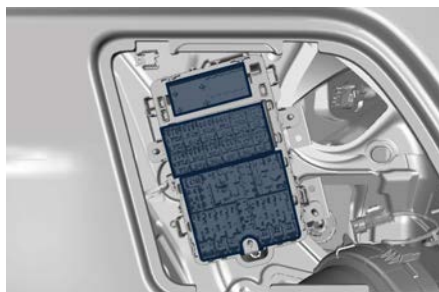

Ref.	Type	Function
F1	Mini – 7,5A	E-Latch Rear Left side input
F2	Mini – 7,5A	E-Latch Passenger side input
F3	Mini – 7,5A	E-Latch Driver side input
F4	Mini – 7,5A	E-Latch Rear Right side input
F5	Mini – 20A	Motor H001 input
F6	Mini – 20A	Motor H002 input
F7	Mini – 30A	Rear Seat Heater input
F8	Mini – 25A	220-110 Power Outlet

Ref.	Type	Function
F9	Mini – 25A	Window Lifter Rear Left input
F10	Mini – 25A	Window Lifter Rear Right input
R1	Maxi – 50A	VDCM Air Spring relay

Ref.	Type	Function
T02	Micro – 30A	ECU VDCM Relay
T03	Micro – 30A	Rear relay
T05	Micro – 30A	Power Seats relay
T06	Micro – 30A	Steering Wheel Heater relay
T10	Micro – 30A	Fuel Pump Relay
T20	Micro – 30A	CADM BCM coil relay
T31	Micro – 30A	Power LG Seats relay
T89	Micro – 30A	Seat heater relay

Ref.	Type	Function
F01	Maxi – 60A	MCO Seats / Inverter / F24 / FXX input



Ref.	Type	Function
F02	Maxi – 30A	BCM1 module
F03	Maxi – 30A	TVM Power module (3.0 V6 only)
F04	Maxi – 30A	Passenger Door module
F05	Maxi – 30A	Driver Door module
F06	Maxi – 25A	BCM2 module
F08	Maxi – 30A	HI-FI module
F09	Mini – 20A	ECU VDCM module
F10	Mini – 10A	ORC module
F11	Mini – 5A	Wireless Charger input
F14	Mini – 10A	ITM module
F15	Maxi – 40A	VDCM module
F16	Mini – 10A	SOC & SOH Battery Sensor input
F17	Mini – 7,5A	USB Charger input
F18	Mini – 15A	CADM module
F19	Mini – 10A	Steering Wheel Heater input

Ref.	Type	Function
F20	Mini – 15A	Rear & CADM relay
F21	Mini – 20A	Sunroof module
F22	Mini – 20A	12 V Trunk Compartment Power Outlet
F23	Mini – 25A	H001 Heated & Comfort input
F24	Mini – 25A	MCO E-Latch input
F30	Mini – 30A	PLGM module
F81	Maxi – 40A	Rear Right & Left Power Window input
F82	Maxi – 30A	HI-FI module
F83	Maxi – 30A	Fuel Pump module
F84	Mini – 10A	VDCM module
F87	Mini – 10A	ORC module
F89	Maxi – 30A	Rear Window Defroster module
F90	Mini – 15A	CVPAM / H001 / H002 / I025 / ALM module
FXX	Mini – 25A	H002 Heated & Comfort input

Ref.	Type	Function
T09	Micro – 30A	Power Outlet relay
T17	Micro – 30A	Defrost relay



In an Emergency

In Case of External Lights Fault Signal

The signal failure of an external light is communicated to the instrument cluster that displays on the screen in a graphical form and with a text message which light is faulty and a telltale (see example in the figure).



by the owner. Contact an **Authorized Maserati Dealer** to replace them.

Emergency Release of the Parking Brake

For further information : chapter "Emergency Release of the Parking Brake" in section "In an Emergency".

Replacement of LED Lights



CAUTION!

The front and rear light clusters are equipped with LEDs.

It is not possible to replace a single LED of the cluster, we recommend that you contact an **Authorized Maserati Dealer** for the replacement of the entire cluster.

All of the bulbs of the other devices are LED powered and cannot be replaced



Transmission Manual Release of P (Park) Position

For further information  : chapter “Transmission Manual Release of P (Park) Position” in section “In an Emergency”.

Freeing the Stuck Vehicle

If your vehicle is stuck in mud, sand, or snow, it can probably be moved backward and forward by a simple rocking motion.

Steer the wheel right and left to clear the area around the front wheels. Shift then between D (Drive) or M (Manual) and R (Reverse) mode (see chapter “Automatic Transmission” in section “Starting and Driving”). Shifting to M (Manual) mode, try to free the car starting in second gear.

At low speed motion of the vehicle, you can switch quickly from D (Drive) to R (Reverse), and vice versa, just by pressing the corresponding buttons.

For more effectiveness press lightly on the accelerator pedal in order to avoid wheel slippage.

If unable to release the vehicle in one of the previously described ways, enter the low-grip driving mode, by choosing the Comfort mode, and completely exclude the yaw and slip control system, by pressing the ESC OFF soft-key on the Comfort display for at least 3 seconds.

Move the transmission between D (Drive) and R (Reverse) mode to start.



CAUTION!

Racing the engine or spinning the drive wheels may lead to transmission overheating and failure. Allow the engine to idle with the transmission in N (Neutral) mode for at least one minute after every five rocking-motion cycles. This will minimize overheating and reduce the risk of transmission failure during prolonged efforts to free a stuck vehicle.



WARNING!

Fast spinning tires can be dangerous. Forces generated by excessive drive wheel speeds may cause damage, or even failure, of the drivetrain and tires. A tire could explode and injure someone. Do not spin your vehicle's wheels continuously without stopping when you are stuck and do not let anyone near a spinning wheel, no matter what the speed.



Auxiliary Jump-Start Procedure

If your vehicle has a discharged battery it can be jump-started using a set of jumper cables and a battery of another vehicle or by using a portable battery booster. It is necessary to have proper jumper cables in order to connect the booster battery to the remote posts of the discharged battery. Booster cables have positive and negative terminal clamps and are identified by the sheath color (red = positive, black = negative). Maserati provides on request jumper cables created for its models in a practical case.

Jump-starting can be dangerous if done improperly so please follow the procedures in this section carefully.

NOTE:

When using a portable battery booster pack, follow the battery manufacturer's operating instructions and precautions.



CAUTION!

- To jump start a vehicle do not use a portable battery, a booster pack or any other booster source with a system voltage greater than 14 Volts or damage to the battery, starter motor, alternator or electrical system of the vehicle with the discharged battery may occur.
- Do not use a battery charger for emergency starting under any circumstances. You could damage the electronic systems, particularly the control units managing the ignition and fuel supply functions.



WARNING!

- Always perform jump-starting operations with appropriate tools and environmental conditions, taking all necessary precautions.
- Do not attempt jump-starting if the discharged battery is frozen.
- To avoid the risk of explosion or fire, do not approach the battery with open flames or cigarettes that could generate sparks.

NOTE:

If you need to disconnect the battery from the vehicle electrical system, see

“Battery Status and Maintenance” in section “Maintenance and Care”.

Battery Remote Posts Position

For easier operation, remote battery posts for jump starting are located in the engine compartment while the battery is stored in the trunk.

After lifting the hood (see “Open and Close the Hood” in section “Before Starting”) the positive remote post (+) and the negative remote post (-) are shown in the picture and are easily recognizable by the icons labeled on them.

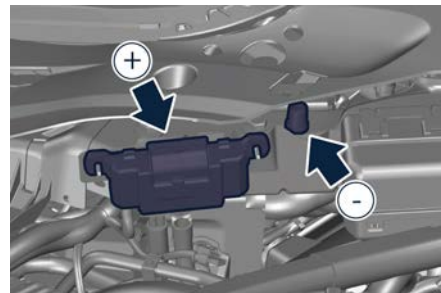

3.0 V6

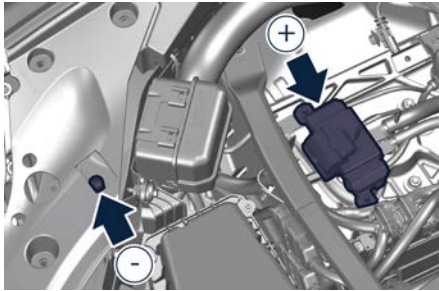

2.0 L4 MHEV

Jump-Start Procedure



WARNING!

- Stay clear of the radiator cooling fan whenever the hood is raised. It can start anytime the ignition device is on. You could be injured by the moving fan blades.
- Remove any metal jewelry such as watch bands or bracelets that might make an inadvertent electrical contact. You could be seriously injured.
- Do not allow the vehicles involved in the jumpstarting operation to touch each other as this could establish a ground connection and cause personal injury.
- Turn off the heater, radio, and all unnecessary electrical accessories.
- Set the parking brake, shift the automatic transmission into P (Park)

mode and set the ignition device to **STOP**.

- If using another vehicle to jumpstart the battery, park the vehicle within the jumper cables reach and set the parking brake and make sure the ignition is off.
- Connect one terminal clamp of the positive (+) jumper cable to the positive (+) remote post of the vehicle with the discharged battery after lifting the protection cap of the cable indicated.
- Connect the opposite terminal clamp of the positive (+) jumper cable to the positive (+) post of the booster battery.
- Connect one terminal clamp of the negative (-) jumper cable to the negative (-) post of the booster battery.
- Connect the opposite terminal clamp of the negative (-) jumper cable to the remote negative (-) post of the vehicle with the discharged battery as rendered.

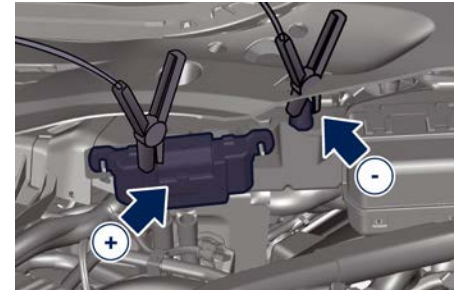

3.0 V6

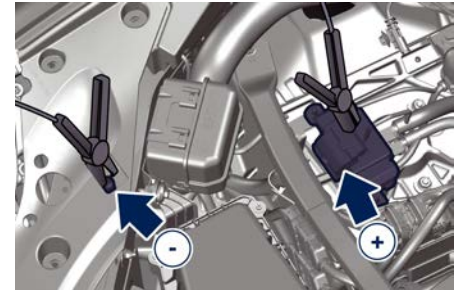

2.0 L4 MHEV

- Start the engine in the vehicle that has the booster battery, let the engine idle a few minutes, and then start the engine in the vehicle with the discharged battery. If using a portable battery booster, wait a few seconds after connecting the cables, before starting the booster vehicle.
- Once the engine is started, remove the jumper cables in the reverse sequence.



In an Emergency

- Disconnect the terminal clamp of the negative (–) jumper cable from the remote negative (–) post of the vehicle with the discharged battery.
- Disconnect the opposite terminal clamp of the negative jumper cable from the negative (–) post of the booster battery.
- Disconnect the terminal clamp of the positive (+) jumper cable from the positive (+) post of the booster battery.
- Disconnect the opposite terminal clamp of the positive jumper cable from the remote positive (+) post of the discharged vehicle.

NOTE:

If frequent jump-starting is required to start your vehicle you should have the battery and charging system inspected at an **Authorized Maserati Dealer**.

Towing a Disabled Vehicle

For further information see  : chapter "Towing a Disabled Vehicle" in section "In an Emergency".



8 - Maintenance and Care

Scheduled Maintenance Service	262
Scheduled Service Plan	263
Maintenance Service Components	273
Maintenance Procedures	275
Battery Status and Maintenance	281
A/C System Maintenance	285
Wheels Maintenance	286
Bodywork Maintenance and Care	288
Interior Maintenance and Care	291
Vehicle Stored for Long Periods	293
Restarting the Vehicle after a Long Inactivity	294



Scheduled Maintenance Service

Correct maintenance is clearly the best way to guarantee vehicle performance and safety functions, ensure respect for the environment and low operating costs.

NOTE:

Also remember that the observance of the maintenance procedures is essential for keeping your vehicle operating properly. Not adhering to the “Scheduled Service Plan” can impact your vehicle’s warranty.

Interval Running Coupons

Maserati has therefore provided for a series of checks and maintenance operations involving the 1st service and subsequent when the vehicle reaches mileage/years reported on the “Scheduled Service Plan” in this section. After the last service, maintenance must be restarted with the operations scheduled for the 1st, 2nd and 3rd service.



CAUTION!

The Scheduled Maintenance services are prescribed by the Manufacturer. Failure to have the services carried out can affect your warranty.

The Scheduled Maintenance service is provided by an **Authorized Maserati Dealer**. In the event that, when a service is performed, further replacements or repairs are found to be necessary in addition to the scheduled operations, these can be carried out only with the specific consent of the Customer.



CAUTION!

You are advised to notify the **Authorized Maserati Dealer** of any minor operating problem, without waiting for the next scheduled service.

NOTE:

- Change your engine oil more often if you drive your vehicle off-road for an extended period of time or short trips without reaching operating temperature. Even the use of the vehicle with extremely hot or cold ambient temperature and with trailer tow may make necessary change engine oil more often.

- Under no circumstances should oil change intervals exceed mileage/years reported on the “Scheduled Service Plan” in this section.



CAUTION!

Failure to perform the required maintenance items may result in damage to the vehicle.

Scheduled Maintenance (Service) Indicator

The service indicator system will remind you the deadline for the maintenance program.

The service message will appear on instrument cluster after the key-on approximately from 620 mi (1000 km) or 30 days to the next scheduled maintenance.

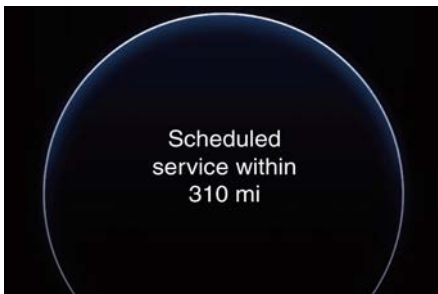



Have your vehicle serviced as soon as possible.

NOTE:

The service indicator will not monitor the time elapsed from the last scheduled maintenance.

To check the km/mi and the days that remain at the inspiration of the next scheduled maintenance, consult the "Overview" submenu of "Vehicle" main menu (see "Function of My Car Menu on MIA" in section "Dashboard Instruments and Controls" for more details).

An **Authorized Maserati Dealer** will reset the service indicator message after completing the scheduled maintenance operations.

Scheduled Service Plan

The Scheduled Maintenance services listed in this manual must be done within the times or mileages specified to protect your vehicle warranty and ensure the best vehicle performance and reliability.

More frequent maintenance may be needed for vehicles in operating conditions, such as dusty areas, extremely hot or cold ambient temperature and very short trip driving. Inspection and service should also be done anytime a malfunction is suspected.

Maserati recommends that these maintenance intervals be performed at an **Authorized Maserati Dealer**. The technicians at your dealership know your vehicle best, and have access to factory-approved information, genuine Maserati parts, and specially designed electronic and mechanical tools that can help prevent future costly repairs.



Main Operations/Service Coupons - Excluding 2.0 L4 MHEV Engines

Service coupons	1°	2°	3°	4°	5°	6°	7°	8°	9°	10°	11°	12°
Main operations	Interval running coupons: every 9.321 mi (15.000 km) or 1 year											
Vehicle road test												
Check with Maserati Diagnosis												
Engine oil and filter (1)	R	R	R	R	R	R	R	R	R	R	R	R
Engine coolant level												
Engine check for leaks												
Cooling system connections and lines (check for leaks)												
Air filter	(2)											
Belt for water pump, air conditioning compressor and alternator	(3)											
Spark plugs				R				R				R
Brake fluid level check												
Brake fluid replacement	(4)											
Brake system: lines, calipers, pads, discs, connections - Instrument panel warning light efficiency - Parking brake operation												
Tire wear, tire and spare tire (if equipped) pressure check												
Joints, rods for front and rear suspensions, front and rear under-chassis												



Service coupons	1°	2°	3°	4°	5°	6°	7°	8°	9°	10°	11°	12°
Main operations	Interval running coupons: every 9.321 mi (15.000 km) or 1 year											
Correct operation and reliability of the seats and seat belts												
Pollen filter	(5)											
Windshield fluid level - Windshield washer												
Battery change TBM 	(6)											
Headlight levelling												
Controls and adjustment systems in general, hinges, doors, engine compartment lid and luggage compartment												
Condition of the leather interiors												
Transfer case oil	(7)											



Service coupons	1°	2°	3°	4°	5°	6°	7°	8°	9°	10°	11°	12°
Main operations	Interval running coupons: every 9.321 mi (15.000 km) or 1 year											
<p>I = Inspect and carry out any other necessary operation R = Replace</p> <p>(1) The actual interval for changing engine oil and replacing the engine oil filter depends on the vehicle usage conditions and is signaled by the warning light or message in the instrument panel. In all cases, never exceed 1 year or 9.321 mi (15.000 km).</p> <p>(2) The change interval of the engine air filter in no dusty areas is every 18.641 mi (30.000 km) or every 2 years. If the vehicle is used in dusty areas (see paragraph "Dusty Areas" in this chapter), the filter must be replaced every 9.321 mi (15.000 km) or every year.</p> <p>(3) The change interval of belt for water pump, air conditioning compressor and alternator in no dusty areas is every 37.282 mi (60.000 km) or every 4 years. If the vehicle is used in dusty areas (see paragraph "Dusty Areas" in this chapter), the belt must be replaced every 18.641 mi (30.000 km) or every 2 years.</p> <p>(4) The brake fluid, regardless of the mileage, must be replaced every 2 years.</p> <p>(5) The change interval of the pollen filter in no dusty areas is every 18.641 mi (30.000 km) or every 2 years. If the vehicle is used in dusty areas (see paragraph "Dusty Areas" in this chapter), the filter must be replaced every 9.321 mi (15.000 km) or every year.</p> <p>(6) The TBM's battery must be replaced every 5 years.</p> <p>(7) Transfer case oil must be replaced every 74.564 mi (120.000 km), regarding the mileage.</p>												



Main Operations/Service Coupons - 2.0 L4 MHEV Engines

Service coupons	1°	2°	3°	4°	5°	6°	7°	8°	9°	10°	11°	12°
Main operations	Interval running coupons: every 9.321 mi (15.000 km) or 1 year											
Vehicle road test		I		I		I		I		I		I
Check with Maserati Diagnosis	I	I	I	I	I	I	I	I	I	I	I	I
Engine oil and filter (1)	R	R	R	R	R	R	R	R	R	R	R	R
Engine coolant level	I	I	I	I	I	I	I	I	I	I	I	I
Engine check for leaks	I	I	I	I	I	I	I	I	I	I	I	I
Cooling system connections and lines (check for leaks)		I		I		I		I		I		I
Air filter	(2)											
Belt for BSG (3)		R		R		R		R		R		R
Belt for water pump and air conditioning compressor (3)		R		R		R		R		R		R
Spark plugs	(4)											
Brake fluid level check	I	I	I	I	I	I	I	I	I	I	I	I
Brake fluid replacement	(5)											
Brake system: lines, calipers, pads, discs, connections - Instrument panel warning light efficiency - Parking brake operation	I	I	I	I	I	I	I	I	I	I	I	I
Tire wear, tire and spare tire (if equipped) pressure check	I	I	I	I	I	I	I	I	I	I	I	I
Joints, rods for front and rear suspensions, front and rear under-chassis		I		I		I		I		I		I



Maintenance and Care

Service coupons	1°	2°	3°	4°	5°	6°	7°	8°	9°	10°	11°	12°
Main operations	Interval running coupons: every 9.321 mi (15.000 km) or 1 year											
Correct operation and reliability of the seats and seat belts												
Pollen filter	(6)											
Windshield fluid level - Windshield washer												
Battery change TBM 	(7)											
Headlight leveling												
Controls and adjustment systems in general, hinges, doors, engine compartment lid and luggage compartment												
Condition of the leather interiors												
Transfer case oil	(8)											



Service coupons	1°	2°	3°	4°	5°	6°	7°	8°	9°	10°	11°	12°
Main operations	Interval running coupons: every 9.321 mi (15.000 km) or 1 year											

I = Inspect and carry out any other necessary operation
R = Replace

(1) The actual interval for changing engine oil and replacing the engine oil filter depends on the vehicle usage conditions and is signaled by the warning light or message in the instrument panel. If oil degradation ratio (data collectable from diagnostic device) is more than 80% (oil quality less than 20%) engine oil and filter replacement is recommended. In all cases, never exceed 1 year/9.321 mi (15.000 km).

(2) The change interval of the engine air filter in no dusty areas is every 37.282 mi (60.000 km) or every 4 years. If the vehicle is used in dusty areas (see paragraph "Dusty Areas" in this chapter), the filter must be replaced every 9.321 mi (15.000 km) or every year.

(3) MHEV engines feature two belts. One drives the water pump and the air condition compressor pump; the other belt drives the BSG.

(4) The spark plug change interval is mileage-based only 27.962 mi (45.000 km). Yearly intervals not applicable.

(5) The brake fluid, regardless of the mileage, must be replaced every 2 years.

(6) The change interval of the pollen filter in no dusty areas is every 18.641 mi (30.000 km) or every 2 years. If the vehicle is used in dusty areas (see paragraph "Dusty Areas" in this chapter), the filter must be replaced every 9.321 mi (15.000 km) or every year.

(7) The TBM's battery must be replaced every 5 years.

(8) Transfer case oil must be replaced every 74.564 mi (120.000 km), regarding the mileage.



Maintenance and Care

Dusty Areas

In the following table there is the list of all dusty countries:

Canada
Puerto Rico
USA

Periodic Maintenance

Every 600 mi (1000 km) or before long journeys

Check:

- engine coolant;
- brake fluid;
- windshield washer fluid level;
- tire inflation pressure and condition;
- operation of lighting system (headlights, turn signals, hazard warning lights, etc.);
- operation of windshield washer/wiper system and wear of windshield wiper blades.

Every 1900 mi (3000 km)

Check and top up, if required, the engine oil level.

Heavy-Duty Vehicle Use

If the car is mainly used under one of the following conditions:

- towing a trailer;
- off-road;
- short, repeated journeys (less than 4-5 mi / 7-8 km) at sub-zero outside temperatures;

- engine often idling or driving long distances at low speeds or long periods of idleness;

you should perform the following inspections more frequently than recommended on the “Scheduled Service Plan”:

- check front disc brake pad conditions and wear;
- check cleanliness of hood and trunk locks, cleanliness and lubrication of linkage;
- visually inspect conditions of: engine, transmission, pipes and hoses (exhaust - fuel system - brakes) and rubber elements (boots - sleeves - bushes - etc.);
- check battery charge;
- visually inspect condition of the accessory drive belts;
- check and, if necessary, change engine oil and replace oil filter;
- check and, if necessary, replace pollen filter of the A/C system;
- check and, if necessary, replace air cleaner filter.



CAUTION!

All maintenance operations for the vehicle must be carried out by an **Authorized Maserati Dealer**. For routine and minor maintenance operations which you can carry out yourself, make sure that you have the necessary experience and always use suitable equipment, original **Maserati** spare parts (or equivalent) and the prescribed fluids. Shall this not be the case, do not carry out any operation on your own and contact an **Authorized Maserati Dealer**.

On-Board Diagnostics (OBD)

Your vehicle is equipped with a sophisticated on-board diagnostic system called OBD II. This system monitors the performance of the emissions, engine, and automatic transmission control systems. When these systems are operating properly, your vehicle will provide excellent performance and fuel economy, as well as engine emissions suited to current government regulations.

If any of these systems require service, the OBD II system will turn on the Malfunction Indicator Light  on the instrument cluster display (refer to “Warning and Indicator Lights” in section “Dashboard Instruments and Controls”).





The system stores as well diagnostic codes and other information to assist your service technician by performing repairs.

Although the vehicle will be driveable and will not need towing, contact an **Authorized Maserati Dealer** for service as soon as possible.



CAUTION!



- Prolonged driving with the MIL  on could cause further damage to the emissions control system. It could also affect fuel economy and driveability. The vehicle must be serviced before any emissions tests can be performed.
- If the MIL  is flashing while the engine is running, severe catalytic converter damage and power loss could occur. Immediate service at an **Authorized Maserati Dealer** is required.

Emissions Inspection and Maintenance Programs



In some localities, it may be a legal requirement to pass an inspection of your vehicle's emissions control system. Failure to pass could prevent vehicle registration. For states that require an Inspection and Maintenance (I/M), this check verifies the "Malfunction Indicator Light 

when the engine is running, and that the OBD II system is ready for testing. Normally, the OBD II system will be ready. The OBD II system may not be ready if your vehicle was recently serviced, recently had a dead battery or a battery replacement. If the OBD II system should be determined not ready for the I/M test, your vehicle may fail the test.

To check if your vehicle's OBD II system is ready, you must do the following:

1. Press the ignition device to the **ON** position, but do not crank or start the engine.
2. As soon as you press the ignition device to turn the engine On, you will see the MIL remain illuminated for 15 seconds, this is a normal bulb check.
3. Approximately 15 seconds later, one of two things will happen:
 - The MIL  will remain illuminated and a message error will appear on your instrument cluster. This means that your vehicle's OBD II system is not ready and you should not proceed to the I/M station.
 - The MIL  will turn Off. This means that your vehicle's OBD II system is ready and you can proceed to the I/M station.

If your OBD II system is not ready, you should see an **Authorized Maserati Dealer** or repair facility. If your vehicle was recently serviced or had a battery failure or replacement, you may need to do nothing more than drive your vehicle as you normally would in order for your OBD II system to update. A recheck with the above test routine may then indicate that the system is now ready.

Regardless of whether your vehicle's OBD II system is ready or not, if the MIL  is illuminated during normal vehicle operation you should have your vehicle serviced before going to the I/M station. The I/M station can fail your vehicle because the MIL  is on with the engine running.

Spare Parts

Use of genuine Maserati parts for normal or scheduled maintenance and repairs is highly recommended to ensure excellent performance.

Damage or failures caused by non-genuine spare parts used for maintenance and repairs will not be covered by the manufacturer's warranty.

Dealer Service

An **Authorized Maserati Dealer** has the qualified service personnel, special tools, and equipment to perform all service operations in an expert manner. Service



Maintenance and Care

Manuals are available which include detailed service information for your vehicle. Refer to these Service Manuals before attempting any procedure yourself.

Intentional tampering with emissions control systems may void your warranty and could result in civil penalties.



WARNING!

You could be injured working on or around a motor vehicle. Take your vehicle to an Authorized Maserati Dealer.



Maintenance Service Components

The following images show the position of the components involved in the maintenance service.

3.0 V6 Engine

1. Engine oil dipstick (for **Authorized Maserati Dealer** use only).
2. Engine oil filler neck.
3. Air cleaner filter.
4. Primary engine cooling reservoir plug.
5. Secondary engine cooling reservoir plug.
6. Windshield washer fluid reservoir cap.
7. Brake fluid reservoir access cover.
8. Fuses boxes.

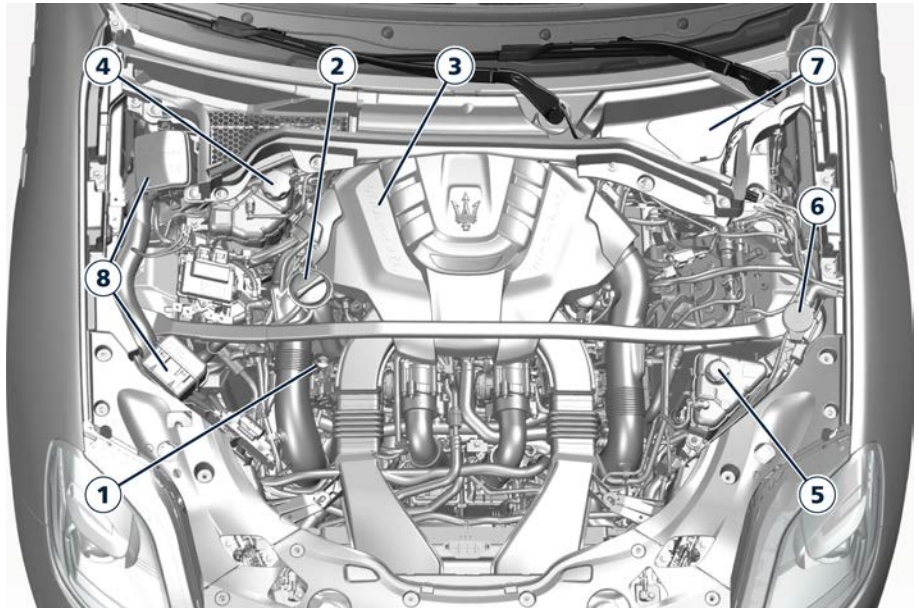

3.0 V6 Engine



Maintenance and Care

2.0 L4 MHEV Engines

1. Fuses boxes.
2. Engine oil filler neck.
3. Air cleaner filters.
4. Primary engine cooling reservoir plug.
5. Secondary engine cooling reservoir plug.
6. Windshield washer fluid reservoir cap.
7. Brake fluid reservoir access cover.

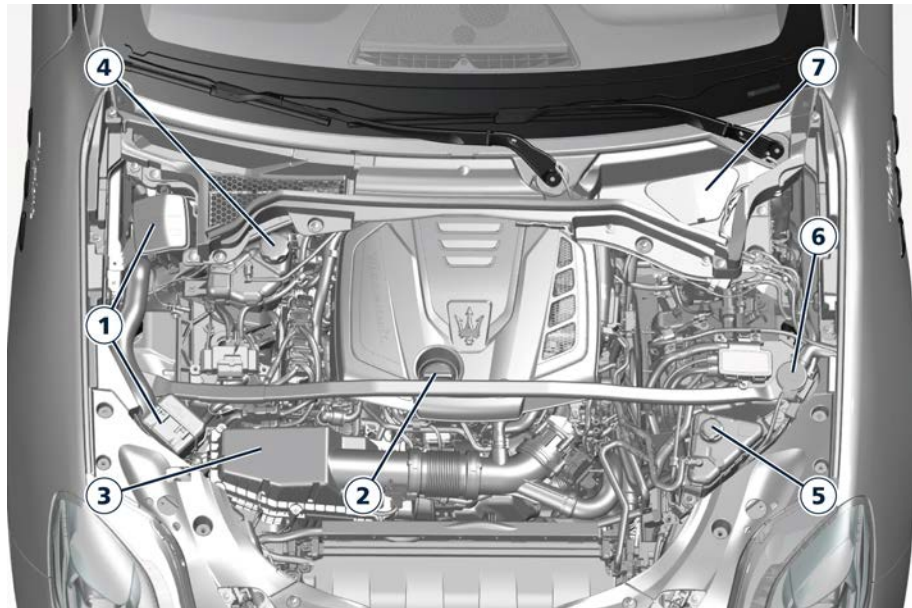

2.0 L4 MHEV Engines



Maintenance Procedures

The following pages contain the “required” maintenance standards determined by Maserati engineers. Besides those maintenance items specified in the “Scheduled Service Plan”, there are other components which may require service or replacement in the future.

To perform most of the services, it is necessary to open the hood (see “Open and Close the Hood” in section “Before Starting”).



CAUTION!

- Failure to properly maintain your vehicle or perform repairs and service when necessary could result in more costly repairs, damage to other components or negatively impact vehicle performance. Immediately have potential malfunctions checked by an **Authorized Maserati Dealer** or a qualified repair center.
- Your vehicle has been equipped with improved fluids that protect the performance and durability of your vehicle and also allow extended maintenance intervals. Do not use chemical flushes for washing as the chemicals can damage your engine,

transmission, electric power steering or air conditioning. Such damages are not covered by the New Vehicle Limited Warranty. If a flush is needed because of component malfunction, use only a specific product for the flushing procedure.

Level Checks



ENVIRONMENTAL!

- The engine oils and fluids used contain substances that are dangerous for the environment. For replacement you are advised to contact an **Authorized Maserati Dealer**, where all the necessary equipment is available to dispose of the used oil and fluids in compliance with the regulations in force and in an environmentally-friendly manner.
- All equipment used for fluids replacement (gloves, cloths, containers, etc) must be disposed of in compliance with the regulations in force.

Engine Coolant Level Check

Your vehicle has been equipped with an improved engine coolant (antifreeze) that offers high protection against corrosion, freezing and allows extended maintenance intervals. To prevent reducing extended maintenance periods,

it is important to use original engine coolant (antifreeze) when adding coolant throughout the life of your vehicle. When adding engine coolant (antifreeze) use pure water only, such as distilled or deionized water when mixing the water/engine coolant (antifreeze) solution. The use of impure water will reduce the amount of corrosion protection in the engine cooling system.

- Mix a minimum solution of 50% engine coolant (antifreeze) and distilled water. Use higher concentrations (do not exceed 70%) if temperatures below -35°F (-37°C) are forecasted. (see  : “Refilling Table” in section “In an Emergency”)

Please note that it is the owner's responsibility to maintain the proper level of protection against freezing according to the temperatures occurring in the circulation area of the vehicle.

The coolant reservoirs provide a quick visual method to determine that the coolant level is adequate. As long as the engine operating temperature is satisfactory, the coolant reservoirs only need to be checked once a month. With the engine off and cold, the level of the coolant in the reservoir on the left and right side of the engine compartment should be between the



Maintenance and Care

ranges indicated on the reservoir and inside the filler neck.

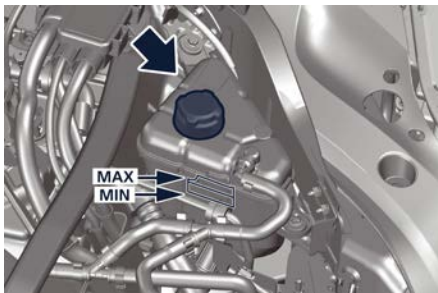

- When additional engine coolant (antifreeze) is needed to maintain the proper level, it should be added to the coolant reservoir after removing the cap. Do not overfill.
- Once the desired level is reached, reassemble and firmly close cap of the reservoir.
- If frequent engine coolant (antifreeze) additions are required, or if the level in

the coolant recovery reservoirs does not drop when the engine cools, the cooling system should be tested by an **Authorized Maserati Dealer**.

- Keep the front of the radiator and the condenser clean.

WARNING!

- **Never add engine coolant (antifreeze) when the engine is hot. Do not loosen or remove the cap of the engine coolant reservoir to cool a hot engine. Heat causes pressure to build up in the cooling system. To prevent scalding or injury, do not remove the pressure cap while the system is hot or under pressure.**
- **When adding coolant do not use a pressure cap other than the one specified for your vehicle. Personal injury or engine damage may result.**

Brake Fluid Level Check

Check the fluid level immediately if the brake system warning light **BRAKE** (United States market) or (Canadian market) and the related message turn on indicating a low level of brake fluid.

- Remove the brakes fluid reservoir access cover.

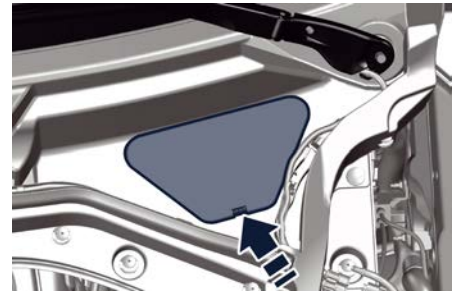

- Clean the top of the master cylinder reservoir before removing the cap.
- Add fluid to bring the level up to the "MAX" mark on the side of the master cylinder reservoir. Use only manufacturer's recommended brake fluid (see : "Refilling Table" in section "In an Emergency").
- Once the correct level is reached, firmly close the cap.

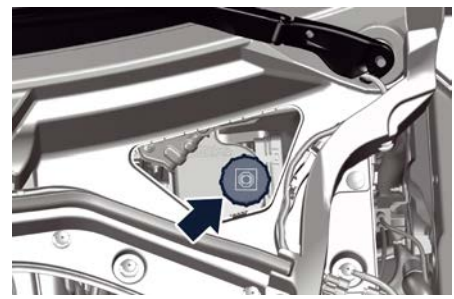

Normal brake pad wear could cause the fluid level to fall. However, low fluid



level may be caused by a leak too, and requires accurate checkup of the braking system.

If necessary, contact an **Authorized Maserati Dealer**.



CAUTION!

The symbol  on the tank cap identifies the synthetic type of brake fluid, distinguishing it from the mineral type. Using mineral fluids damages the special rubber linings of the brake system irreparably.



CAUTION!

- To avoid contamination from foreign materials or moisture, use only new brake fluid or fluid that has been in a tightly closed container. Keep the master cylinder reservoir cap secured at all times.
- Overfilling the brake fluid reservoir can result in spilling brake fluid. Brake fluid can also damage painted and vinyl surfaces, make sure it does not spill over these surfaces.
- Do not allow petroleum based fluid to contaminate the brake fluid. Brake seal components could be damaged.

Adding Windshield Washer Fluid

The reservoir on the left side of the engine compartment contains the fluid

to wash the windshield and the window liftgate.

During scheduled services or when the message of low level of the washer fluid appears together with the related telltale  add more fluid as soon as possible.

The fluid reservoir may contain nearly 4,33 Quarts (4,1 liters) of washer fluid.

- Lift the reservoir cap in the engine compartment.



- Fill the reservoir with windshield washer solvent (refer to  "Refilling Table" in section "Technical Specifications") and operate the system for a few seconds to flush out the residual water.
- When refilling the washer fluid reservoir, apply some washer fluid to a cloth or towel and wipe the wiper blades clean. This will help blade performance.

To prevent freeze-up of your windshield washer system in cold weather, select a solution or mixture that meets or exceeds the temperature range of your climate.

This rating information can be found on most washer fluid containers.



WARNING!

- **Commercially available windshield washer solvents are flammable. They could ignite and burn you. Care must be exercised when filling or when working around the windshield washer system.**
- **Do not drive with the windshield washer reservoir empty: the action of the washer is essential for improving visibility when driving.**

Engine Oil Level Check

To assure proper lubrication of your vehicle's engine, the engine oil must be maintained at the correct level.

If the  warning light illuminates and the related message of low oil level displays, or during scheduled services (see "Scheduled Maintenance Service" in this section) it is necessary to check the engine oil level.

The engine is equipped with a sensor that can detect the oil level which can be viewed on the MIA display by entering



Maintenance and Care

the "Vehicle" menu and choosing the "Oil Level" submenu in "Functions of MyCar Menu on MIA". A critical condition (e.g.: critical level, oil sensor failure, etc.) is signaled by the lighting of the dedicated warning light and by pop up messages (see "Instrument Cluster Pop Up Messages" in section "Dashboard Instruments and Controls").

The vehicle should be parked on level ground and then follow the instructions on the MIA display.



CAUTION!

- Do not top up with oil with different characteristics than the engine one (refer to  : "Refilling Table" in section "In an Emergency").
- Overfilling or underfilling the sump will cause aeration or loss of oil pressure. This could damage your engine.
- Do not add any supplemental materials to the engine oil. Engine oil is an engineered product, and its performance may be impaired by supplemental additives.

NOTE:

Dipstick check is only allowed by the **Authorized Maserati Dealer** (not a reference for oil level check).

- The oil level should maintain between the "min" and "max" marks indicated at

the ends of the bar of the "Oil Level" submenu (refer to  : "Refilling Table" in section "In an Emergency").

- If a refilling is necessary: unscrew the filler neck cap.

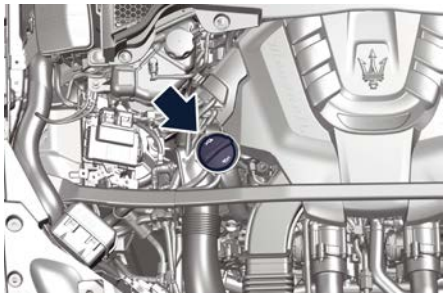

3.0 V6 Engine

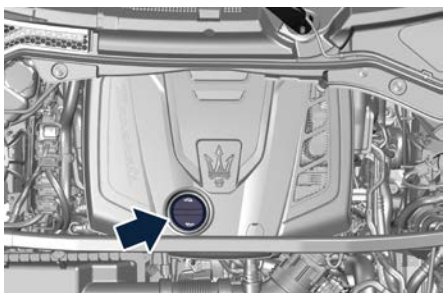

2.0 L4 MHEV Engines

- Adding 1 Quart/1 liter (3.0 V6 Engine) of oil when the level is at the bottom of the Safe range will result in the level being at the top of the SAFE range.

- Return the cap to his position and wait for a few minutes to allow the oil to reach the sump.
- Check the level again.

Engine Oil Filter Replacement

The engine oil filter should be replaced with a new filter at every oil change. Contact an **Authorized Maserati Dealer** to perform this service.

Automatic Transmission Oil Check

Contact an **Authorized Maserati Dealer** for the oil level check.

Fluid Level Check for Transmission Cooling System

The coolant contained in the reservoir of this system is the same as the one used for the cooling system of the engine. For the preparation of the mixture of water and antifreeze and for the control of the level, proceed as shown in the "Engine Coolant Level Check" of this chapter.

Engine Air Filters Replacement

Contact an **Authorized Maserati Dealer** to have the air filters replaced.

A/C Air Filter Replacement

Contact an **Authorized Maserati Dealer** to have the A/C air filter replaced.



Wiper Maintenance and Blades Replacement

Windshield Wiper Arms Lifting

When the windshield wiper arms are in rest position it is not possible to check or replace the blades as they remain under the engine hood.

To service the blades it is necessary to move the wiper arms in "Service" position. To activate this function, deactivate the windscreen wiper (ring in position **0**) before setting the ignition device to **STOP**.

This function can only be activated within 2 minutes of setting the ignition device to **STOP**.

To activate this function, move the lever upwards (unstable position) for at least three seconds.



In this way it is possible to lift the arms for cleaning or replacing the wiper blades.

If, after using the function, the ignition device is set back to **ON** with the blades in a position other than rest position (at the base of the windscreen), they will only return to rest position following a command given using the stalk (stalk upwards, into unstable position) or when a speed of 3 mph (5 km/h) is exceeded.



WARNING!

It is dangerous to operate or service the wiper blades with the windshield wipers in an active position (any position different from "0") and with the ignition device in the ON position. The rain sensors may suddenly activate the wipers. Always use the "Service" position for any intervention on the windshield wiper blades.



CAUTION!

Do not operate the wipers with the blade lifted from the glass. This could damage the wiper system.

Windshield Wiper Maintenance

Life expectancy of wiper blades varies depending on the geographical area's weather conditions where the car is used and frequency of use. Poor performance of blades may be present with chattering, marks on the glass, water lines or wet spots. If any of these

conditions are present, clean the wiper blades or replace if necessary.

Clean the rubber edges of the wiper blades and the windshield/rear window glasses periodically with a sponge or soft cloth and a mild nonabrasive cleaner. This will remove accumulations of salt or road film.

Operation of the wipers on dry glass for long periods may cause deterioration of the wiper blades.

Always use washer fluid when using the wipers to remove salt or dirt from a dry windshield.

Avoid using the wiper blades to remove frost or ice from the windshield. Keep the blade rubber out of contact with petroleum products such as engine oil, gasoline, etc.

Spray nozzles

If the jet does not work, first check that there is fluid in the tank (see paragraph "Level checks" in this section) then check that the nozzles are not clogged.

Windshield Wiper Blades Replacement

- Move the wiper arms into "Service" position, (see "Windshield Wiper Arms Lifting" in this section) and lift them.
- Press the indicated button, slip off the blade support from the arm and replace it.



- Return the blade to its original position on the windshield.
- Turn the multifunction lever to one of the automatic settings (see chapter “Wipers and Washers Control” in section “Dashboard Instruments and Controls”) and move the ignition device in **ON** position: the wiper arms will return to the resting position.

NOTE:

Due to the difficulty of this operation, we recommend that you contact an **Authorized Maserati Dealer** for replacement of the blades.

Rear Window Blade Replacement

- To replace the rear window wiper blade on the liftgate, remove the cap at the bottom of the wiper arm.
- Lift the wiper arm with blade up to the stop position



- Turn the blade to the position indicated in the figure.
- Hold the arm steady and pull the blade, by holding it from the central support, until it is removed.

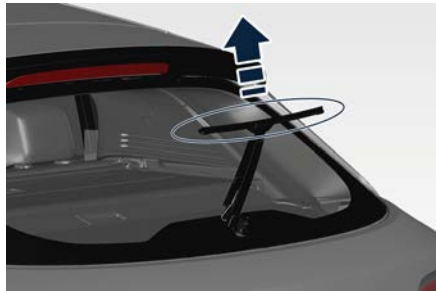

- Replace the blade.
- Insert the pivot, present inside the blade central support, in the fork-shaped end of the arm until hearing the click indicating that it is engaged.



- Stretch the arm and put the blade back in contact with the liftgate window repositioning the cap at the bottom of the wiper arm.



Battery Status and Maintenance

This vehicle is equipped with a 12 V sealed type maintenance-free battery. You will never have to add water, nor is periodic maintenance required.

In addition to the 12 V battery, the **MHEV models** are equipped with another 48 V Li-Ion battery that does not require any type of maintenance. Its charge status is visible by entering the "Vehicle" menu on the MIA screen and choosing "Electric Vehicle" submenu, or visualizing the "Hybrid Info" widget on the left digital dial.

Any work on this battery must be performed by the technicians of an **Authorized Maserati Dealer**.

NOTE:

All the descriptions/operations of this chapter refer only to the 12 V battery which will be simply called "battery".



WARNING!

- **Battery fluid is a corrosive acid solution and can burn or damage the eyes. Do not allow battery fluid to contact your eyes, skin, or clothing. Do not lean with the face over a battery. If acid splashes in eyes or on skin,**

flush the area immediately with large amounts of water.

- **Battery gas is flammable and explosive. Keep flame or sparks away from the battery. Do not use a booster battery or any other booster source with an output greater than 12 Volts. Do not allow cable clamps to touch each other.**
- **Battery posts, terminals, and related accessories contain lead and lead compounds. Wash hands after handling the battery.**
- **The battery in this vehicle has a vent hose that should not be disconnected and should only be replaced with a component of the same type (vented).**

NOTE:

Remote battery terminals for start are located in the engine compartment for jump starting to be used with an auxiliary battery or a battery from another vehicle (see "Auxiliary Jump-Start Procedure" chapter in section "In an Emergency").

Battery State of Charge

To avoid problems with ignition and/or the electrical system in general when you are driving, the battery charge status is constantly maintained and guaranteed by the vehicle's recharge circuit; the main component of which is

the alternator. This circuit is only able to supply voltage to the battery when the vehicle is traveling.

The warning light  on the instrument cluster, will indicate any malfunctions in the recharge circuit or an insufficient battery charge status (example in figure).



The vehicle contains advanced electronic systems, such as, for example, the alarm system  and various electronic control modules, which consume power even when the ignition device is in **STOP** position and the vehicle is not being used.

Therefore, it is fundamental that the battery is properly charged to ensure that the engine starts properly and that all the electrical/electronic systems in the vehicle work efficiently.



Maintenance and Care

To Disconnect the Battery

The battery is located on the inner central side of the trunk compartment. To access the battery it is necessary to lift the ground coverage of the trunk compartment (see chapter “Tool Kit” in section “In an Emergency”) and remove the battery cover.

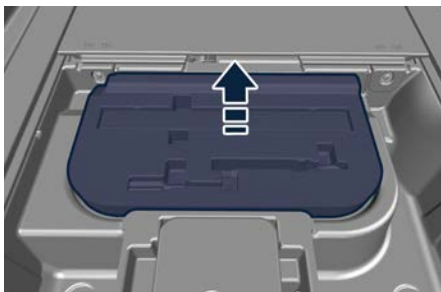

CAUTION!

- Before disconnecting the battery, open the liftgate. The liftgate must remain open until the charged battery is reconnected.
- Never disconnect the battery from the electrical system when the engine is running.
- To temporarily disconnect the vehicle electrical system from the battery, simply remove the cable end with

quick coupling from the negative post (–) of the battery.

- If the battery needs to be removed from its compartment, you must first detach the terminal clamp to the negative post (–) and then the other terminal clamp to the positive post (+), after removing the protective cover. Battery posts are marked positive (+) and negative (–) and are identified on the battery case.

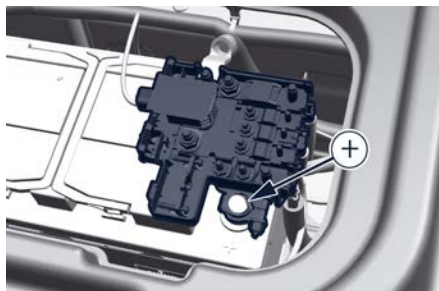
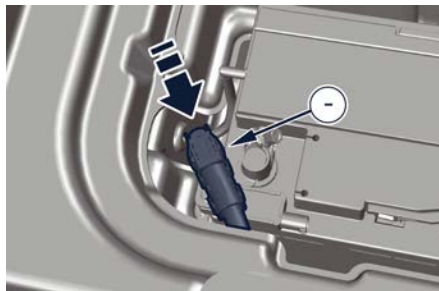

To Reconnect the Battery



CAUTION!

- It is essential when replacing the cables on the battery that the positive cable is precisely attached to the positive post (+) and the negative cable is attached to the negative post (–).
- Cable clamps should be tight on the terminal posts and free of corrosion.

After the battery has been disconnected and re-connected and before starting the engine it is necessary to proceed as follows:

- Unlock and lock the doors using the key fob.
- Close manually the liftgate, unlock it with the key fob and then lock it manually on more time. Then move the liftgate automatically, using the buttons on the right side of the outer edge of the liftgate, performing a complete cycle of opening and closing. If the limit of maximum power liftgate opening has been set, it is necessary to reset it (see “Open and Close the Liftgate” in section “Before Starting”).
- Initialize the climate control system by activating the system and pressing the “AUTO” control as described in chapter “Air Conditioning Controls” in section “Dashboard Instruments and Controls”.



- Turn on the MIA and set the date and time.
- Lift, release and lift again the lever under the driver lower side of the dashboard to initialize the electric parking brake. Following this operation, at the next key cycle, the warning light on the instrument cluster will turn off and the error messages regarding the unavailability of the radar functions will also no longer be present.
- Start the engine and perform the end-stop learning of EPS, steering fully to the left and then to the right. The EPS failure warning light and message should disappear on the cluster display.



CAUTION!

- Every time the battery is reconnected, wait at least 30 seconds with the ignition device set in **ON** before starting the engine, in order to allow the electronic system that manages the motor-driven throttles to run a self-learning cycle. At the same time, you can run the date and time set up procedure for the MIA.
- Every time the battery is reconnected the warning lights **BRAKE** (on vehicles of United States market) or (on vehicles of Canadian market) and .

flash for about 10 seconds and then go off.

Useful Advice to Extend Battery Life

When parking the vehicle, make sure that the doors, hood, liftgate and flaps are properly closed. All interior lights should be off.

When the engine is turned off, do not keep the connected devices switched on for a long time (such as radio, hazard warning lights, fan, etc.).



CAUTION!

If the battery charge remains below 50% for a long period of time, it will be damaged due to sulphation; its performance and starting power will be reduced and it will be more subject to freezing.

We recommend you to have the battery charge condition checked, preferably at the beginning of the cold season, to prevent the electrolyte from freezing. This check should be carried out more frequently if the vehicle is used mainly for short trips or if it is equipped with power-absorbing devices that remain permanently on even when the ignition device is off. This applies above all if

these devices have been retrofitted ("Aftermarket" services).
If the vehicle is not used for long periods of time, please see "Vehicle Stored for Long Periods" in this section.

Battery Recharge



WARNING!

The process of charging or recharging the battery produces hydrogen, a flammable gas that can explode and cause serious injuries. When charging or recharging the battery, follow the recommended precautions at all times.

- Before using a charger device always check that this tool is suitable for the installed battery, with constant voltage (lower than 14.0 V) and low amperage (maximum limit 15 A).
- Recharge the battery in a well-ventilated environment.
- Never charge or recharge a frozen battery.
- Ensure that any sparks or open flames are kept well away from the battery while it is charging.
- Before using a charger to charge or maintain the battery charge status, carefully follow the instructions provided to ensure the charger is



connected to the battery safely and correctly.

It is possible to recharge the battery without disconnecting the cables of the vehicle electrical system.

- To access the battery lift the ground coverage of the trunk compartment (see chapter “Tool Kit” section “In an Emergency”) and remove the battery cover.
- Remove the protection cover and connect the terminal clamp of the charger positive cable (typically in red) to the positive post (+) of the battery.
- Connect the terminal clamp of the charger negative cable (typically in black) to the nut located by the negative post (–) on the battery, indicated in the picture.

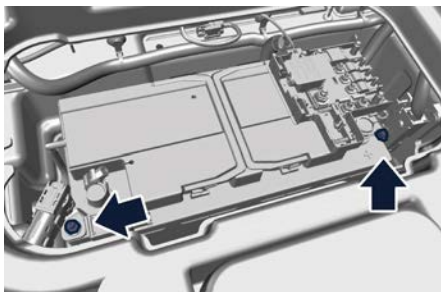

The vehicle is equipped with a IBS (Intelligent Battery Sensor) sensor able to measure charging and discharging

currents and to calculate the state of charge and state of health of the battery. This sensor is located in at the negative post (–) of the battery.

For a successful charge/recharge operation, the charging current must flow through the IBS sensor as shown in the picture.

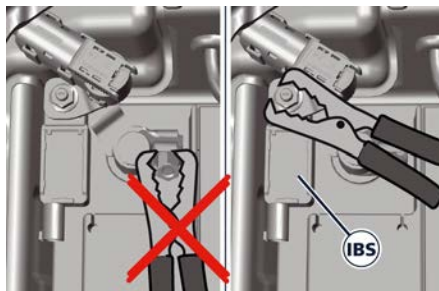

- Turn the charger on and follow the instructions on its user manual to completely recharge the battery.
- When the battery is recharged, turn off the battery charger before disconnecting it from the battery.
- Disconnect first the terminal clamp of the charger black cable from the battery and then the terminal clamp of the red cable.
- Reassemble the protection cover on the battery positive post and the other parts removed for this operation.

Maintaining Battery Charge

If you perform short daily trips (approximately 10 miles/16 km), which correspond to an annual total of 4000 miles/6000 km, or when the vehicle is not going to be used for one week or more, Maserati recommends connecting the vehicle to a battery charger, to save you the trouble of having to recharge the battery. The battery charger will keep the battery charged properly and at the correct voltage levels required by the systems and devices in the vehicle. Before using the battery charger, carefully follow the instructions provided.

If you do not use a battery charger to prevent the battery from going flat when you are not going to use the vehicle for long periods of time, you need to check and recharge the battery at least once every three weeks. Make this check if you perform short daily trips (approximately 10 mi/16 km) which correspond to an annual total of 4000 miles/6000 km. Please note that allowing the battery to go flat repeatedly can cause premature wear on the internal cells and greatly reduce their life, leading to problems with the ignition system and other electrical/electronic systems.



The **Authorized Maserati Dealer** is available to advise you on how to recharge your battery correctly and give you useful information on battery care and maintenance.

NOTE:

The **Authorized Maserati Dealer** can provide you with any information about the Maserati approved “Battery Charger and Conditioner”, available in the “Genuine Accessories” range.



WARNING!

The process of charging or recharging the battery produces hydrogen, a dangerous gas that can explode and cause serious injuries. When charging or recharging the battery, follow the recommended precautions at all times:

- always charge or recharge the battery in a well-ventilated environment;
- never charge or recharge a battery that has frozen;
- ensure that any sparks or open flames are nowhere near the battery while it is charging;
- before using a charger to charge or maintain the battery charge status, carefully follow the instructions provided to ensure the charger is

connected to the battery safely and correctly.

A/C System Maintenance

For best performances, the air conditioning system should be checked and serviced by an **Authorized Maserati Dealer** at the beginning of the warm season.

This service should include cleaning of the condenser check of the drive belt tension and a performance test. During the winter, the air conditioning system should be operated at least once a month for about 10 minutes.



CAUTION!

Do not use chemical flushes in your air conditioning system as the chemicals can damage your air conditioning components. Such damage is not covered by the New Vehicle Limited Warranty.



WARNING!

- Use only refrigerants and compressor lubricants approved by the manufacturer for your air conditioning system. Some refrigerants are flammable and can explode, causing injuries. Other unapproved refrigerants or lubricants can cause the system to fail, requiring costly repairs.



- **The air conditioning system contains refrigerant under high pressure. To avoid risk of personal injury or damage to the system, adding refrigerant or any repair requiring lines to be disconnected should be done by an Authorized Maserati Dealer.**

Periodically remove any leaves and insects that may build up and obstruct the inlet of external air in the air conditioning system through the grille present underneath the rear part of the hood.

To access the grille, lift the hood as described in “Open and Close the Hood” in section “Before Starting”.

Wheels Maintenance

Tires Maintenance



CAUTION!

To obtain the best performances and the longest mileage from the tires, take following precautions during the first 310 mi (500 km):

- do not drive at the vehicle's maximum speed;
- drive at low speed on curves;
- avoid sudden steering;
- avoid sudden braking;
- avoid sudden acceleration;
- do not drive at high speeds for too long.

The tires inflation pressure must correspond to the prescribed values ( : chapter “Tire Inflation Pressure” in section “Technical Specifications”) and should be checked only when the tires have cooled down. In fact, the pressure increases as the tire temperature progressively increases.

Never reduce the pressure if tires are hot ( : chapter “Tires Information” chapter in section “Safety”).

Insufficient tire inflating pressure can cause tire overheating and possible internal damage, which may even lead to the tire destruction.



CAUTION!

After inspecting or adjusting the tire pressure, always reinstall the valve stem cap. This will prevent moisture and dirt from entering the valve stem, which could damage it.

Impacts with curbs, holes, and obstacles in the road, and prolonged trips on rough roads or off-road trails can cause tire damage which may not be visible to the naked eye.

Check your tires regularly for any signs of damage (e.g. scratches, cuts, cracks, bulges, etc.). If sharp objects penetrate the tires, they can cause structural damage which is only visible when the tire is removed.

In any case, any possible damage must be inspected by an experienced technician, as it may seriously reduce the tire life.

Remember that tires deteriorate with time, even if used little or not at all. Cracks in the tire tread and sides, alongside possible bulging, are a sign of deterioration.

**WARNING!**

- Check the inflating pressure of the tires when cold, at least every two weeks and before long trips.
- If the same tire has been on your vehicle for four years, have it replaced by an experienced technician. The spare tire (if equipped) must be replaced after 2000 km / 1243 mi (for MHEV models only), regardless of the remaining tread. Failure to follow this warning can result in tire failure.
- Never fit tires of uncertain origin.
- “Directional” tires have an arrow on their side showing the rolling direction. To keep the best performance when replacing a tire, make sure that the rolling direction corresponds to the one shown by the arrow.
- During the tire life, the rolling direction used for the first fitting shall always be observed, also in case of “nondirectional” tires.
- Check the depth of the tire tread at regular intervals. The minimum allowed value is 0.067 in (1.7 mm) or 0.073 in (1.86 mm) for winter, all-season and snow tires, at that point the wear indicators on the tire will be visible ( : chapter “Tires Information” in section “Safety”). The

thinner is the tread, the greater is the risk of skidding.

- Drive carefully on wet roads to decrease the risk of hydroplaning.

Winter Tires

These tires are specially designed for driving on snow and ice and are fitted to replace the ones supplied with the vehicle.

The functions of these tires are significantly reduced in winter when tread depth is less than 0.073 in (1.86 mm). In this case, they should be replaced.

The specific functions of the winter tires lead to lower performance under normal environmental conditions or on long highway trips, compared to the standard tires.

Therefore, their use should be limited to the situations and performance for which they have been type-approved.

The **Authorized Maserati Dealer** can provide all necessary information about fitting winter tires on the vehicle.

NOTE:

- We recommend fitting winter tires on the vehicle at temperatures below 45 °F (7 °C) since the driving performance of summer tires is reduced at low temperatures. Summer tires may be

permanently damaged at extremely low temperatures.

- Comply with all state and local laws governing snow tire and tread depth requirements.

Wheel Rims Maintenance

All wheel rims should be cleaned regularly with a mild soap and water. To remove heavy soil and/or excessive brake dust, use a nonabrasive, non-acidic cleaner.

Do not use scouring pads, steel wool, a bristle brush, or metal polishes. Do not use oven cleaner that may involve and damage the brake calipers.

Avoid automatic car washes that use acidic solutions or harsh brushes that may damage the wheel rim protective finish.



Bodywork Maintenance and Care

Protection from Atmospheric Agents

The main causes of corrosion are:

- atmospheric pollution;
- salinity and humidity in the atmosphere (marine areas or a damp climate);
- seasonal environmental conditions;
- salt scattered on the roadbed to melt ice and snow.

The abrasive action of wind-carried atmospheric dust and sand, mud and stones should not be underestimated.

On this vehicle, Maserati has adopted the best technological solutions to protect the bodywork from corrosion.

The main measures are:

- paint products and systems that give the vehicle particular resistance to corrosion and abrasion;
- use of galvanized (or pre-treated) metal sheets which are highly resistant to corrosion in the most exposed parts;
- spraying of the underbody, engine compartment, insides of wheel housings, and other structures with wax products having high protective power;
- spraying of plastic materials, with a protective function, in the most exposed points: underneath the doors,

inside part of the mud guards, edges, etc.;

- use of ventilated box sections, coated with protective wax products, to avoid condensation and trapped water which could encourage the formation of internal rust.

Useful Advice to Keep the Bodywork in Good Condition

NOTE:

The Authorized Maserati Dealer can provide you with any information about the Maserati approved Protective Films Kit, available in the "Genuine Accessories" range.

Paint

The paintwork does not only have an aesthetic function but also protects the underlying metal sheets. In the event of abrasions or deep scratches, we recommend to have the necessary touch-ups made immediately, to avoid any rust formation. Touch-ups do not feature particular difficulties, even on metallic and matte finishes. For all paint touch-ups, use only original products indicated on the label fitted on the rear driver door's ledge.



Normal paint maintenance consists in washing, the frequency of which depends on the conditions of use and of the environment. For example, if driving the vehicle in areas where there is high atmospheric pollution or the roads are spread with anti-freeze salt, it is advisable to wash the vehicle more frequently.



ENVIRONMENTAL!
Detergents pollute water. Therefore the vehicle should be washed in areas equipped for the collection and purification of the fluids used for washing.

NOTE:

The use of alcohol-based products for cleaning the metal surfaces in the engine compartment and/or the trunk may deteriorate the protective paint. It



is recommended to use water-based products and neutral surfactants.

Car Wash

For correct washing:

- wet the bodywork with a low pressure water jet;
- clean the underbody with a low pressure water jet, including wheelhouses and bumpers;
- pass a sponge with a light detergent solution over the bodywork, frequently rinsing the sponge;
- rinse well with water and dry with an air jet or chamois leather.

When drying, take particular care with the parts that are less visible, such as the door, liftgate and lid bays, headlight edges, in which water can be trapped more easily.

You are recommended not to take the vehicle immediately into an enclosed environment, but leave it in the open air so as to allow the water to evaporate. Do not wash the vehicle after it has been left in the sun or when the hood is hot: the paint gloss could be affected. External plastic parts must be cleaned with the same procedure followed for the normal washing of the bodywork. Avoid, as far as possible, parking the vehicle under trees; the resinous substances that very often drop from the

trees give the paint a dull appearance and increase the possibility of originating corrosive processes.

It is important that the drain holes in the lower sides of the doors, rocker panels, and trunk bottom be kept clear and open.

NOTE:

Make sure that Hands free, Proximity system and Passive Entry system settings are deactivated while washing your car.



CAUTION!

- Bird droppings must be washed off immediately and thoroughly, since their acidity is particularly corrosive.
- To provide better protection for the paint, polish the vehicle at intervals with a suitable product leaving a protective film on the paint.
- If the vehicle is washed using high-pressure water jets or cleaners, it is important that the nozzle of the jet be kept at a distance of at least 16 in (40 cm) from the bodywork to avoid damaging it.

Washing Vehicles with Matte Finish Paint

- It is recommended to hand wash vehicles with matte-finish paint.

- Before washing, first remove from the bodywork dust and other particles that could damage the paint. Preferably use an air pressure jet.
- When grease spots and fingerprints are present, it is recommended using a special cleaner for matte finish paint. Apply the product using a microfiber cloth. To avoid damaging the paint surface, do not use too much pressure.
- Wet the bodywork with plenty of water and clean it using a soft sponge and a neutral wax-free shampoo, starting from the top and working down. Dry the bodywork using an air pressure jet.
- Rinse all the parts of the vehicle thoroughly with plenty of water. Keep the sponge or the washing mitt in use always wet and clean.
- At last, using a different sponge or washing mitt, clean the wheels, the door sill plates and the other parts that are less visible.



CAUTION!

- It is recommended not to wash the vehicle in direct sunlight. The little drops of water, acting as small focal lenses, could damage the paint.
- Always and only wash the vehicle by hand. Avoid using abrasive sponges



Maintenance and Care

or mitts that could damage the matte finish paint.

- Never polish and never use polishing agents on the vehicle with matte finish paint or on parts of it.
- Hard water (over 86 °F) could leave limestone residues.

Glass Surfaces

All glass surfaces should be cleaned on a regular basis with any commercial household-type glass cleaner.

Never use an abrasive type cleaner.

Use caution when cleaning the inside rear window on the liftgate equipped with electric defrosters. Do not use scrapers or other sharp instrument that may scratch the elements.

When cleaning the rear view mirror, spray cleaner on the towel or rag that you are using. Do not spray cleaner directly on the mirror.

Labels can be peeled off after soaking with warm water.

When cleaning is performed, keep all metal objects at a safe distance from the window.

Cleaning Headlights

Your vehicle has plastic headlights that are lighter and less susceptible to stone breakage than glass headlights.

Plastic is not as scratch-resistant as glass and therefore different lens cleaning procedures must be followed.

To minimize the possibility of scratching the lenses and reducing light output, avoid wiping with a dry cloth. To remove road dirt, wash with a mild soap solution followed by rinsing.

Do not use abrasive cleaning components, solvents, steel wool or other aggressive material to clean the lenses.

Condensation and Fogging on the Light Clusters

With cold or humid climate, after a driving rain or after cleaning the car, the surface of the front and rear light clusters could fog and/or form condensate drops on the inside. This is a natural phenomenon due to the temperature and humidity difference between the lens internal and external surface, which nevertheless does not indicate a fault and does not compromise the regular operation of the lights.

The fogging/condensate disappear when switching on the lights, starting from the center of the diffuser and going gradually to the edges.

Mouldings and Aluminium Trims

- For cleaning mouldings and aluminium trims, avoid the use of acidic or

alkaline cleaning agents that can destroy the protecting surface treatment.

- After washing aluminium trim with warm water, apply the cleaning agent with a clean tissue or a soft sponge on the surface. Do not use any other equipment such as brushes, steel wool, abrasives or any other equipment for cleaning.
- After cleaning, please rinse the aluminium trim with a lot of clear water.
- While cleaning in the car wash please make sure that the mouldings and aluminium trims only gets contact with soft brushes or textiles.

Engine Compartment

At the end of each winter season, carefully wash the engine compartment, remembering to avoid directing the jet of water for too long on the electric parts.

To perform this operation, you must contact an **Authorized Maserati Dealer**.

“Car Wash” Mode

To move the vehicle in tunnel washers, or generally move with engine off, you can use the following mode.

- Vehicle must be on level ground, stationary or moving up to 0.6 mph (1 km/h).
- Move the transmission in N (Neutral) mode.



- The brake pedal can be pressed or not pressed.
- Turn the engine off by pressing the **START/STOP** button for 5 seconds. Through these steps, the driver's door must be closed. This condition will persist for about 15 minutes, the transmission will switch to P (Park) mode once time has expired. In case of low-battery voltage the transmission can be placed in P (Park) mode before this time has expired.

NOTE:

If the driver wants to leave the vehicle, the EPB should be released if automatically applied leaving the vehicle.

**WARNING!**

The vehicle will always stay in N (Neutral) mode during this procedure without pressing the brake pedal. To avoid accidental movement, always check that the movement of the vehicle take place only on a flat surface.

**CAUTION!**

DO NOT USE this mode to haul the vehicle because after a period of time the transmission will be set automatically in P (Park) mode. If this occurs when the vehicle is moving the transmission can be damaged.

Interior Maintenance and Care

Interior trim should be cleaned starting with a damp cloth. Do not use harsh cleaners.

The leather upholstery can be best preserved by regular cleaning with a damp soft cloth. Small particles of dirt can act as an abrasive and damage the leather upholstery and should be removed promptly with a damp cloth. Stubborn soils stains can be removed easily with a soft cloth and appropriate products. Avoid soaking the leather upholstery with any liquid. Please do not use polishes, oils, cleaning fluids, solvents, detergents, or ammonia-based cleaners to clean your leather upholstery. Application of a leather conditioner is not required to maintain the original condition.

Check at regular intervals that there is no water trapped under the mats (due to drips off shoes, umbrellas etc.) which may cause the metal parts to oxidize.

NOTE:

Use neutral soap and non-aggressive solvents to clean light mats.



CAUTION!

Do not use alcohol, petrol or solvents to clean the instrument cluster's transparent dome, the MIA display, the digital clock and the leather upholstery. We recommended the use of "Car Care" products approved by Maserati for the maintenance and care of the interior.

Leather Upholstery Treatment

Have the leather upholstery only treated, as provided in the Scheduled Service Plan, by an **Authorized Maserati Dealer** which has the required specific products.

Parts in Premium Quality Wood

Remove any dirt with a buckskin leather or damp cloth.

Maserati Intelligent Assistant™ and Comfort Display Touch Screen

- Do NOT attach any object to the touch screen, doing so can result in damage to the touch screen.
- Do not touch the screen with any hard or sharp objects (pen, USB stick, jewelry, etc.) which could scratch the touch screen surface.
- Do not spray any liquid or caustic chemicals directly on the screen! Use a clean and dry micro fibre lens

cleaning cloth in order to clean the touch screen. If necessary, use a lint-free cloth dampened with a cleaning solution, such as isopropyl alcohol, or an isopropyl alcohol and water solution ratio of 50:50. Be sure to follow the solvent manufacturer's precautions and directions.

- Prevent any liquid from entering the system: this could damage it beyond repair.

NOTE:

The Authorized Maserati Dealer can provide you with any information about the Maserati approved "Microfiber Cloth", available in the "Genuine Accessories" range.

Car Cleaning and Sanitizing

According to what is prescribed by the health authorities in each country, after using the car it is necessary to clean all surfaces that may have been touched by other people (example: steering wheel, transmission buttons, air vents, seat belts, keys, handles, etc.).

To carry out this operation safely and correctly, trying to avoid possible damage to the internal surfaces of the car, here are some useful tips:

- perform the operation if possible outdoors or in any case in a sufficiently ventilated area;

- wear all personal safety devices: gloves, mask and goggles using new or sanitized devices;
- clean the surfaces with a microfiber cloth moistened with an alcoholic sanitizing solution, avoiding to apply or spray said solution directly on the surface. The use of hydrogen peroxide, bleach and disinfectant is not recommended as they can develop too aggressive action on leather and plastic;
- sanitize the vents that circulate the air in the passenger compartment;
- vacuum the dust from the upholstery and the mats, or wash them with the appropriate detergent products.

A good habit to take, is to always have clean hands, both before and after driving, as it will help to keep the steering wheel and other surfaces more frequently touched inside cleaner car.



Vehicle Stored for Long Periods

If the vehicle is going to be stored for long period of time, you need to check first the 12 V battery charge status and that of the 48 V battery on the **MHEV models** (see "Functions of Electric Vehicle Menu on MIA" in section "Dashboard Instruments and Controls", or check the status on the "Hybrid Info" widget on the left digital dial). If the charge status of the 48 V battery is below 50% (value represented in picture), avoid stopping the engine in this condition, but keeping it running at idle in order to recharge the 48 V battery at least up to 50%, in the case of stops within 3 months, or 100% for longer stops.



After this check, follow the below precautions:

- Wash and dry the vehicle thoroughly.
- Store the vehicle on a level surface in a covered, dry and, if possible, ventilated area.
- Select P (Park) mode and turn off the engine.
- Check that the parking brake is NOT engaged.
- Disconnect the battery or connect a battery charger (refer to paragraph "Maintaining Battery Charge" of chapter "Battery Status and Maintenance" in this section).
- Check the battery charge status. During parking, batterie's charge status must be carried out every three weeks. Recharge the battery if the open circuit voltage is lower than 12.2 V.
- Check that the parking brake is NOT engaged.
- Do not empty the engine cooling system.
- Clean and protect the painted parts applying protective wax.
- Clean and protect polished metal parts with special products available on the market.
- Cover the vehicle with a long cloth in breathable fabric (available from an **Authorized Maserati Dealer**). Do not use thick plastic sheets, which do not allow the humidity on the vehicle surface to evaporate.
- Inflate the tires up to a pressure which must be 14.5 psi (1 bar) higher than the normally prescribed one, and check it at regular intervals.
- If vehicles are left stationary for a few days, the ride height may be reduced. Due to that is recommended to park the vehicle on flat surface without uneven surface (Rocks, sidewalks, steps, etc.) under it.

NOTE:

The **Authorized Maserati Dealer** can provide you with any information about the available "Indoor and Outdoor Car Covers", available in the "Genuine Accessories" range.



WARNING!

The tire pressure must be brought back to the prescribed value before operating the vehicle ( : chapter "Tire Inflation Pressure" in section "Technical Specifications").



Restarting the Vehicle after a Long Inactivity

Before restarting the vehicle after a long period of inactivity, we recommend that you carry out the following operations.

- Check the tires for pressure and for any damages, cuts or cracks. If this is the case, have them replaced.
- Do not dry-rub the external surface of the vehicle: use a damp cloth.
- Visually inspect if there are any fluid leaks (oil, brake and transmission fluid, engine coolant etc.).
- Have the engine oil and filter replaced.
- Check the fluid levels in the brake system, as well as the engine coolant level.
- Check the air filters and have them replaced if necessary.
- Reconnect the battery after checking the charge status (refer to “Battery Status and Maintenance” in this section) and perform the initialising procedure if applicable.
- If vehicles are left stationary for a few days, the ride height may be reduced. The vehicle automatically re-adjusts to the correct ride height when operational readiness is established. This can take several minutes depending on the vehicle state.

- With the transmission in N (Neutral) mode, let the engine idle for several minutes.

In this way, the pneumatic suspension system will be able to reach the operating pressure and lift the car to the Entry/Exit height (for further details, see “Drive Mode” in section “Starting and Driving”).



WARNING!

The engine idle must be performed outdoors. Exhaust gases contain carbon monoxide which is strongly toxic and potentially lethal.







Index



A bbreviations	8	Display Warnings and Maintenance of ACC and FCW Systems	221	Air Conditioning System Maintenance	285
Access the Glove Box Compartment	43	Displayed Information	217	Audio System	44
Active Driving Assist – ADA	238	Driver Override	219	Base System	44
Hands Detection on Steering Wheel	240	Overtake Aid	221	Sonus Faber High Premium Audio System	45
Monitoring on Cluster Display	239	Precautions while Driving with ACC	223	Sonus Faber Premium Audio System	44
Radar Device - Regulatory Information	241	Radar Device - Regulatory Information	224	Automatic Start&Stop System	157
Speed Range of Use	239	Resuming Speed	219	Automatic Restarting of the Engine	158
System Cancellation	241	Setting the Speed	218	Occupant Safety Function	159
System Disengage	241	Setting the Time Gap	220	Start&Stop Deactivated	158
System in Faulty	241	Speed Range of Use	218	Start&Stop Function Disabling	159
System Limitations	241	System Controls and Activation Conditions	217	Start&Stop Not Active	158
System Operation	238	System Operation Before and During Stop	221	Start&Stop System Failure	159
System Statuses	240	Temporary Deactivation	219	Automatic Transmission	160
Active Lane Management - ALM	228	Warnings and Cautions	215	Automatic Transmission "Pulse Activation" Buttons	161
Customised Settings	229	Air Conditioning Controls	144	Automatic Transmission Range	162
Function Description and Operating Mode	230	A/C Filter	151	Transmission Malfunction and Overheating Conditions	166
Radar Device - Regulatory Information	232	Automatic Temperature Control (ATC)	148	Auxiliary Jump-Start Procedure	258
Speed Range of Use	229	Dual Zone Climate Control Functions	147	Battery Remote Posts Position	258
System Availability	229	Dual-zone Climate Controls	144	Jump-Start Procedure	259
System in Faulty	231	Operating Tips	151	AWD, All-Wheel Drive	168
System Limitations	231	Three-Zone Climate Controls	149	B attery Status and Maintenance	281
Adaptive Cruise Control - ACC	215	Air Conditioning Distribution	55	Battery Recharge	283
Activation/Deactivation	218	Adjustable Air Vents	55	Battery State of Charge	281
Changing Speed Setting	219	Fixed Air Vents	55	Maintaining Battery Charge	284
Conditions for Disabling and Deactivation	219				



Index

To Disconnect the Battery	282	Phone and Voice Controls	133	External Lighting	29
To Reconnect the Battery	282	Cruise Control - CC	213	Adaptive “Full-LED” Headlight	
Useful Advice to Extend Battery		Activation	214		30
Life	283	Changing Speed Setting	214	Automatic High Beam (DPT)	32
Blind Spot Assist - BSA	232	Displayed Information	214	External Lights Equipment	29
BSA and RCP Setting	235	Driver Override	215	High Beam with “Glare Free”	
Radar Device - Regulatory		Resume Speed	215	Function (for “Full-LED” headlight	
Information	236	Setting Desired Speed	214	with AFS) 	33
RCP - Rear Cross Path	235	Speed Range of Use	214	SmartBeam™ System 	30
System Operation	232	Temporary Deactivation	215	External Lights Controls	136
Bodywork Maintenance and Care	288	Using Cruise Control on Hill	215	Controls on Comfort Display	136
Protection from Atmospheric				Daytime Running Lights	
Agents	288	D rive Mode	169	(DRL)	138
Useful Advice to Keep		Controls Preview	169	Direction Indicators	138
the Bodywork in Good		Setting the Drive Mode	169	External Lights Switch	
Condition	288	Driving Conditions	188	Operation	137
Brake Pads and Brake Discs		Before the Trip	188	Lights Failure Messaging	139
New Brake Pads and/or Brake		Driving at Night	188	Parking Lights	138
Discs	183	Driving in Fog	189		
		Driving in the Mountains	189	F orward Collision Warning - FCW	225
C argo Area	46	Driving in the Rain	189	Automated Emergency Braking	
Cargo Area Extension	49	Driving on Snow or Ice	190	System	225
Loading with Rear Seatbacks		Driving through Flooded		Limited Operation and Service	
Folded Down	47	Sections	190	Warning	227
Luggage Fasteners and		Safe Driving	188	Radar Device - Regulatory	
Retainers	47	Drowsy Driver Detection - DDD	237	Information	228
Ski and Snowboard Bag				Speed Range of Use	226
Compartment	48	E mergency Release of the Parking		System Operation	225
Trunk Compartment Cover	48	Brake	256	System Setting	227
Vehicle Load Carrying		Engine Overheating	248	System Status	227
Capacity	46	Exiting the Car	70	Freeing the Stuck Vehicle	257
Consulting the manual	7	Open a Door	70	Front Seats	18
Controls on Steering Wheel	133			Front Heated Seats ()	19
Audio System Controls	135				





Front Power Seats	18	Phone/Bluetooth	126	Fuses Box on the Rear Right	
Front Ventilated Seats ()	20	Reset	132	Hand Side of the Engine	
Front to Back Roof Rails ()	50	Safety & Driving Assistant	124	Compartment	252
Functions of Controls Menu on		Seat & Comfort	129	Position of Fuses	250
MIA	121	SiriusXM Setup	131	Used Fuses Characteristics	249
Functions of Electric Vehicle Menu		Software Updates	131	Ignition Device	62
on MIA	119	Suspension	129	Ignition Device States	63
Functions of My Car Menu on MIA	118	System Information	131	Illuminated Entry/Exit	64
Drive Mode Explorer	118	Voice	126	Use of Light Switch for Vehicle	
Oil Level	118	H azard Warning Flashers	246	Lighting	66
Overview	118	Hill Descent Control - HDC	207	Vehicle Lighting with	
Tire Pressure	118	HomeLink®		Open/Closed Doors	65
Functions of Performance Menu on		Before You Start Programming		In case of a Punctured Tire	248
MIA	120	HomeLink®	51	Using Tire Repair Kit	248
Accessory Gauges	121	Canadian/Gate Operator		In Case of External Lights Fault	
Consumption History	120	Programming	53	Signal	256
Drag Race	120	Radio Frequency RKE Transmitter		In the Event of an Accident	247
Off Road	121	- Regulatory Information	54	Instrument Cluster Overview	85
Technical Gauges	120	Security	54	Central Sector Layout	86
Torque Management	120	System with Devices Provided		Instrument Cluster Pop Up	
Functions of Settings Menu on MIA	122	with Rolling Codes	52	Messages	90
Audio	130	System with Devices Without		Instrument Cluster Settings and	
Brakes	128	Rolling Code	53	Menu Overview	91
Camera	127	Troubleshooting Tips	54	Integrated External Rear View Mirror	
Clock & Date	126	Using HomeLink®	54	Lights	29
Display	123	I f a Fuse Blows	249	Interior Lighting	34
Doors & Locks	128	Fuse Box in the Trunk		Cargo Lights	36
Geolocation	131	Compartment	253	Dome Lights	34
Key Off Options	129	Fuses Box on the Front Right		Interior Maintenance and Care	291
Lights	127	Hand Side of the Engine		Car Cleaning and Sanitizing	292
Mirrors & Wipers	127	Compartment	251	Leather Upholstery	
My Profile	124			Treatment	292
Navigation	127				
Notification	130				



Index

Maserati Intelligent Assistant™ and Comfort Display Touch Screen	292	Main Menu Overview	92	Engine Start Failure	155
Parts in Premium Quality Wood	292	Maintenance Procedures	275	Engine Turn Off	155
Internal Equipment	36	A/C Air Filter Replacement	278	O ff-road Drive	177
Cigarette Lighter (OPT)	41	Engine Air Filters Replacement	278	After Driving Off-road	179
Cupholders	38	Level Checks	275	Driving in Mud and Sand	178
Electric Power Outlets	36	Wiper Maintenance and Blades Replacement	279	Driving in Snow and Wet Grass	178
Handholds and Cloth Hooks	42	Maintenance Service Components	273	Driving Through Water	177
iPod® Connection	40	Maserati Intelligent Assistant Operation Customising the Main Status and Category Bar	117	Hill Climbing	178
Mesh Pockets (🔗)	42	Main Category Bar on MIA Display	116	Traction Downhill	178
Multimedia Ports	38	Main Status Bar on MIA Display	116	Warnings and Tips for Off-road Driving	179
Sun Visors	41	Manual Controls and Devices	114	On-board Documentation Kits	6
Wi-Fi Hotspot (🔗)	43	Memorize the Driver's Seat Position	21	On-Board Instrumentation Overview	84
Wireless Charger	39	Memorize the Driver's Seat Position (🔗) Memory Position Recall	22	Open and Close the Hood Closing	81
Internal Light Controls	139	Memory Profiles Setting	21	Opening	80
K eys	58	Pairing Remote Keyless Entry Transmitter to Seats Memory	22	Open and Close the Liftgate Liftgate Emergency Release	80
Key fob Operation	58	Memorize the Driver's Seat Position (🔗) Easy Entry/Exit Seats	22	Power Liftgate/Hands free Operation (🔗)	75
Remove the Emergency Key from the Key fob	61	Mild Hybrid System Information (2.0 L4 MHEV only)	14	Owner's Information Online	7
L aunch Control Mode (TROFEO version only)	175	N ormal Starting of the Engine	154	P ark Assist	196
Low and High Beam Lights	138	"Panic Stop" Strategy	155	Active Park Braking	199
M ain Controls Overview	12			Cleaning the Park Assist Sensors	201
On Central Console	12			Enabling and Disabling Park Assist	198
On Dashboard	12			Operation with a Trailer	202
On Front Dome Console	13			Park Assist Sensors	196
On Front Doors	13				
On Rear Doors	13				
Main Menu Contents	92				



Park Assist System Usage		Remote Start System	156
Precautions	201	Driver's Seat Comfort with Remote Start	157
Park Assist Volume	202	Engine Remote Start Abort Message on Instrument Cluster	156
Park Assist Warning Messages Display	197	How to use Remote Start	156
Service the Park Assist System	201	Radio Frequency RKE Transmitter - Regulatory Information	157
Side Distance Warning (with Surround View  only)	200	To enter Remote Start Mode	156
Parking Brake	180	To exit Remote Start Mode and Drive the Vehicle	157
EPB Operation with Overheated Brakes	182	To exit Remote Start Mode without Driving the Vehicle	156
Failure Indication	181	Requiring and setting Additional Key Fobs	60
Manual Engagement/Disengagement	180	Key Fob Battery Replacement	60
Parking	182	Radio Frequency RKE Transmitter - Regulatory Information	62
Passive Entry System	67	Responsible Use of Digital Instrumentation	84
Door Lock from Outside	68	Restarting the Vehicle after a Long Inactivity	294
Preventing Inadvertent Locking of key fob Inside the Vehicle	67	S cheduled Maintenance Service	262
Radio Frequency RKE Transmitter - Regulatory Information	69	Interval Running Coupons	262
Release the Liftgate and Enter the Trunk	68	Scheduled Maintenance (Service) Indicator	262
Unlock Door from the Driver Side	67	Scheduled Service Plan	263
Unlock Door from the Passenger Side	67	Dealer Service	271
Power Sunroof with Sunshade	73	Dusty Areas	270
Ignition STOP Operation	75		
Initialization Procedure	74		
Pinch Protect Function	74		
Slide Opening Sunroof	73		
Sunroof Maintenance	75		
Sunshade	74		
Venting Sunroof	74		
Wind Buffeting	75		
Power Windows	71		
Auto-Down Function	72		
Auto-Up Function with Anti-Pinch Protection	72		
Open and Close the Windows with Key fob and Ignition STOP	72		
Rear Window and Door Lockout Button	72		
Reset Auto-Up/Down	72		
Wind Buffeting	72		
Proximity System	69		
Walk Away Lock	69		
Welcome Lights	69		
Q uick Actions Contents	97		
Quick Actions Overview	92		
R ear Parking Camera	203		
Rear Seats	23		
Rear Armrest	23		
Rear Seat Folding Seatback	23		
Rear Side Heated Seats ()	24		
Rear-View Mirrors	26		
External Mirrors	26		
Internal Rear-View Mirror	28		
Refueling	186		
Fuel Filler Cap Open Warning Light	187		
Fuel Filler Neck Access	186		
Refill the Tank	187		



Emissions Inspection and Maintenance Programs	271	Connect the Electrical System of the Trailer	193	Widgets Contents	99
Heavy-Duty Vehicle Use	270	Field of Vision of External Rear View Mirrors	191	Windshield Wipers and Washers Control Operation of Control	141
Main Operations/Service Coupons - 2.0 L4 MHEV Engines	267	Install the Trailer Tongue	192	Rain Sensor Operation	141
Main Operations/Service Coupons - Excluding 2.0 L4 MHEV Engines	264	Remove the Trailer Tongue	193	Wipers and Washers Control	140
On-Board Diagnostics (OBD)	270	Tire Pressure Adjustment	191	Rear Window Wiper/Washer	142
Periodic Maintenance	270	Towing Tips	193		
Setting Ride Height	172	Trailer Lights	191		
Smart Clock	143	Trailer Tongue Weight	190		
SOS and Assist Call	247	Transmission Manual Release of P (Park) Position	257		
Spare Parts	271				
Speed Limiter - SL	209	U dating	6		
Controls	209	Use of the Engine	184		
Displayed Information	210	Breaking-In	184		
Steering Wheel Adjustment	25	Messages Concerning the Residual Life of Gasoline Engine Oil	186		
Heated Steering Wheel (Ⓢ)	25	On-Board Diagnostics (OBD)	185		
Power Adjustment	25	Spare Parts	186		
Surround View Camera System	204	While Driving	184		
System components	204	Using the Brakes	183		
		Brake Overheating	183		
T ool Kit	246	Brake Pads and Brake Discs	183		
Towing a Disabled Vehicle	260				
Traffic Sign Assist – TSA	242	V ehicle Stored for Long Periods	293		
Customized Settings	242				
Signs Monitoring on Instrument Cluster	242	W arning and Indicator Lights	104		
System in Faulty	243	Wheels Maintenance	286		
System Limitations	243	Tires Maintenance	286		
Trailer Towing	190	Wheel Rims Maintenance	287		
Arranging Load on Trailer	191	Widget Overview	92		



Maserati S.p.A. & Maserati North America, Inc. reserve the right to make changes and/or modifications to the content and all technical information and specifications without prior notification.

Therefore, the user is not entitled to any claims based on the contents (texts, data, illustrations, explanations and regulations) in this manual, which are based on the data known at the time of going to print.

© 2023. Maserati S.p.A. All rights reserved.

Publication no. 910044544 - 1st Edition - 07/2023

This document may not be reproduced, printed or translated, even partially, without the written consent of MASERATI S.p.A.

910044544



WWW.MASERATI.COM

MASERATI SPA · VIALE CIRO MENOTTI, 322 · I-41121 MODENA