



**CT5**  
**OWNER'S MANUAL**

2025



## Contents

Introduction .....	1
Keys, Doors, and Windows .....	6
Seats and Restraints .....	34
Storage .....	81
Instruments and Controls .....	84
Lighting .....	124
Infotainment System .....	133
Climate Controls .....	167
Driving and Operating .....	172
Vehicle Care .....	286
Service and Maintenance .....	364
Technical Data .....	373
Customer Information .....	379
Reporting Safety Defects .....	388
OnStar .....	391
Connected Services .....	396
Index .....	399

## Introduction

### California Proposition 65 Warning



# WARNING

**Operating, servicing and maintaining a passenger vehicle or off-highway motor vehicle can expose you to chemicals including engine exhaust, carbon monoxide, phthalates, and lead, which are known to the State of California to cause cancer and birth defects or other reproductive harm. To minimize exposure, avoid breathing exhaust, do not idle engine except as necessary, service your vehicle in a well-ventilated area and wear gloves or wash your hands frequently when servicing your vehicle. For more information go to [www.P65Warnings.ca.gov/passenger-vehicle](http://www.P65Warnings.ca.gov/passenger-vehicle).**

## Introduction



The names, logos, emblems, slogans, vehicle model names, and vehicle body designs appearing in this manual including, but not limited to, GM, the GM logo, CADILLAC, the CADILLAC Emblem, and CT5, are trademarks and/or service marks of General Motors LLC, its subsidiaries, affiliates, or licensors.

For vehicles first sold in Canada, substitute the name “General Motors of Canada Company” for Cadillac Motor Car Division wherever it appears in this manual.

This manual describes features that may or may not be on the vehicle because of optional equipment that was not purchased on the vehicle, model variants, country specifications, features/applications that may not be available in your region, or

changes subsequent to this publication’s release, including changes in standard or optional content.

Refer to the purchase documentation relating to your specific vehicle to confirm the features.

### Canadian Vehicle Owners

A French language manual can be obtained from your dealer, at [www.helminc.com](http://www.helminc.com), or from:

#### Propriétaires Canadiens

On peut obtenir un exemplaire de ce guide en français auprès du concessionnaire ou à l'adresse suivante:

Helm, Incorporated  
Attention: Customer Service  
47911 Halyard Drive  
Plymouth, MI 48170  
USA

### Danger, Warning, and Caution

Warning messages found on vehicle labels and in this manual describe hazards and what to do to avoid or reduce them.

#### Danger

Danger indicates a hazard with a high level of risk which will result in serious injury or death.

#### Warning

Warning indicates a hazard that could result in injury or death.

#### Caution

Caution indicates a hazard that could result in property or vehicle damage.





A circle with a slash through it is a safety symbol which means “Do not,” “Do not do this,” or “Do not let this happen.”

## Symbols

The vehicle has components and labels that use symbols instead of text. Symbols are shown along with the text describing the operation or information relating to a specific component, control, message, gauge, or indicator.

 : Shown when the owner's manual has additional instructions or information.

 : Shown when the service manual has additional instructions or information.

 : Shown when there is more information on another page — “see page.”

### Vehicle Symbol Chart

Here are some additional symbols that may be found on the vehicle and what they mean. See the features in this manual for information.

 : Air Conditioning System

 : Air Conditioning Refrigerant Oil

 : Airbag Readiness Light

 : Antilock Brake System (ABS)

 : Brake System Warning Light

 : Dispose of Used Components Properly

 : Do Not Apply High Pressure Water

 : Engine Coolant Temperature

 : Flame/Fire Prohibited

 : Flammable

 : Forward Collision Alert

 : Fuse Block Cover Lock Location

 : Fuses

 : ISOFIX/LATCH System Child Restraints

 : Keep Fuse Block Covers Properly Installed

 : Lane Change Alert

 : Lane Departure Warning

 : Lane Keep Assist

 : Malfunction Indicator Lamp

 : Oil Pressure

 : Park Assist

 : Pedestrian Ahead Indicator

 : Power

 : Rear Cross Traffic Alert

 : Registered Technician

 : Remote Start

 : Risk of Electrical Fire

 : Seat Belt Reminders

 : Side Blind Zone Alert

 : Stop/Start

 : Tire Pressure Monitor

 : Traction Control/StabiliTrak/Electronic Stability Control (ESC)

 : Under Pressure

 : Vehicle Ahead Indicator

## Instrument Panel Overview

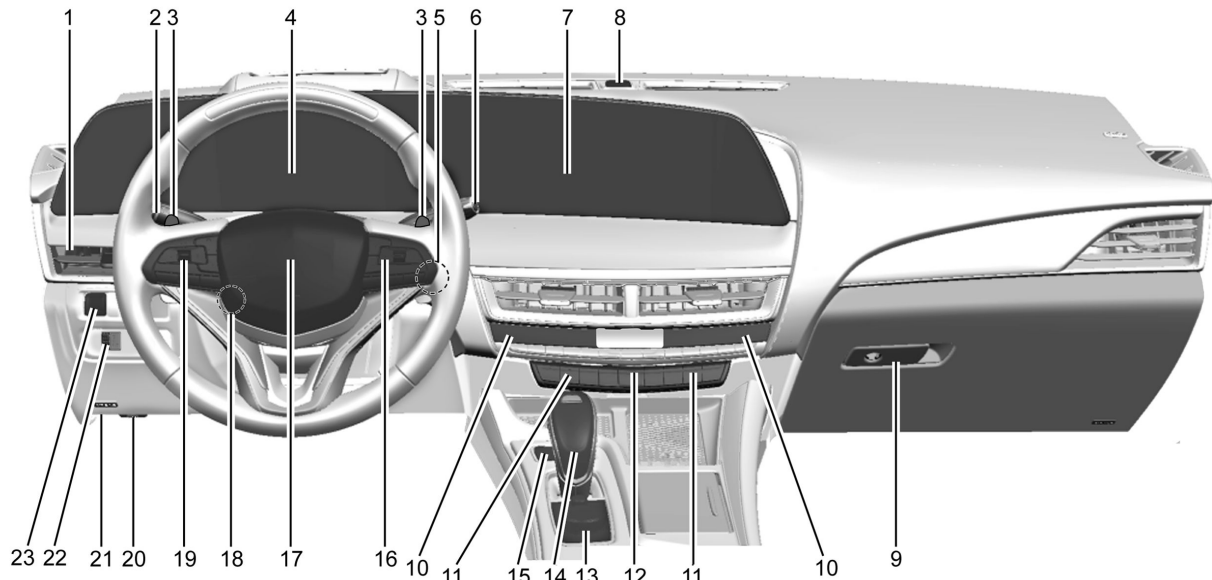

1. Air Vents ⇨ 170.
2. Turn Signal Lever. See *Turn and Lane-Change Signals* ⇨ 128.

*Exterior Lamp Controls* ⇨ 124.  
*IntelliBeam System Button (If Equipped).*  
 See *Exterior Lamp Controls* ⇨ 124.

3. Tap Shift Controls (If Equipped). See *Manual Mode* ⇨ 203.
4. Instrument Cluster ⇨ 92.

5. ENGINE START/STOP Button. See *Ignition Positions* ⇨ 192.
6. *Windshield Wiper/Washer* ⇨ 86.
7. Infotainment Display. See *Using the System* ⇨ 136.
8. Light Sensor. See *Automatic Headlamp System* ⇨ 126.
9. *Glove Box* ⇨ 81.
10. *Dual Automatic Climate Control System* ⇨ 167.
11. *Heated and Ventilated Front Seats* ⇨ 42 (If Equipped).  
*Lane Keep Assist (LKA)* ⇨ 272 (If Equipped).  
*Automatic Park Assist Button (If Equipped)*. See *Assistance Systems for Parking or Backing* ⇨ 251.  
*Park Assist Button*. See *Assistance Systems for Parking or Backing* ⇨ 251.
12. *Hazard Warning Flashers* ⇨ 128.
13. Infotainment Controls. See *Overview* ⇨ 134 (If Equipped).
14. Shift Lever. See *Automatic Transmission* ⇨ 200.  
See *Manual Transmission* ⇨ 204.
15. *Traction Control/Electronic Stability Control* ⇨ 210.  
*Automatic Vehicle Hold (AVH)* ⇨ 209.  
*Auto Engine Stop/Start Switch*. See *Starting the Engine* ⇨ 193.  
*MODE Switch*. See *Driver Mode Control* ⇨ 211.
16. *Steering Wheel Controls* ⇨ 135.  
*Driver Information Center (DIC) Controls*. See *Driver Information Center (DIC)* ⇨ 111.
17. *Horn* ⇨ 86.
18. *Steering Wheel Adjustment* ⇨ 85.
19. *Cruise Control* ⇨ 221 (If Equipped).  
*Adaptive Cruise Control (Advanced)* ⇨ 225 (If Equipped).  
*Forward Collision Alert (FCA) System* ⇨ 259 (If Equipped).  
*Heated Steering Wheel* ⇨ 85 (If Equipped).
20. *Hood Release*. See *Hood* ⇨ 288.
21. *Data Link Connector (DLC) (Out of View)*. See *Malfunction Indicator Lamp (Check Engine Light)* ⇨ 101.
22. *Instrument Panel Illumination Control* ⇨ 129.
23. *Electric Parking Brake (EPB) Switch*. See *Electric Parking Brake* ⇨ 208.

## Keys, Doors, and Windows

### Keys and Locks

Keys .....	6
Remote Key .....	7
Remote Key Operation .....	7
Remote Start .....	12
Door Locks .....	13
Power Door Locks .....	16
Delayed Locking .....	16
Automatic Door Locks .....	16
Lockout Protection .....	16
Safety Locks .....	17

### Doors

Trunk .....	17
-------------	----

### Vehicle Security

Vehicle Security .....	22
Vehicle Alarm System .....	22
Steering Column Lock .....	24
Immobilizer .....	24
Immobilizer Operation .....	24

### Exterior Mirrors

Convex Mirrors .....	25
Power Mirrors .....	26
Folding Mirrors .....	26
Heated Mirrors .....	27

Automatic Dimming Mirror .....	27
Reverse Tilt Mirrors .....	27

### Interior Mirrors

Interior Rearview Mirrors .....	28
Manual Rearview Mirror .....	28
Automatic Dimming Rearview Mirror .....	28
Rear Camera Mirror .....	28

### Windows

Windows .....	30
Power Windows .....	30
Sun Visors .....	32

### Roof

Sunroof .....	32
---------------	----

## Keys and Locks

### Keys

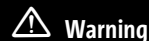

#### Warning

Leaving children in a vehicle with a remote key is dangerous and children or others could be seriously injured or killed. They could operate the power windows or other controls or make the vehicle move. The windows will function with the remote key in the vehicle, and children or others could be caught in the path of a closing window. Do not leave children in a vehicle with a remote key.



The key inside the remote key is used for the driver door and glove box.

To remove the mechanical key, press the button on the side of the remote key near the bottom, and pull the mechanical key out. Never pull the mechanical key out without pressing the button.

If it becomes difficult to turn the key, inspect the key blade for debris. Periodically clean with a brush or pick.

See your dealer if a new mechanical key is needed.

Contact Roadside Assistance if locked out of the vehicle. See *Roadside Assistance Program* ⇨ 382.

With an active OnStar or connected service plan, an OnStar Advisor may remotely unlock the vehicle. See *OnStar Overview* ⇨ 391.

## Remote Key

See *Radio Frequency Statement* ⇨ 387.

If there is a decrease in the remote key operating range:

- Check the distance. The remote key may be too far from the vehicle.
- Check the location. Other vehicles or objects may be blocking the signal.

- Check the remote key battery. See “Battery Replacement” later in this section.
- If the remote key is still not working correctly, see your dealer or a qualified technician for service.

## Remote Key Operation

The Keyless Access system allows for vehicle entry when the remote key is within 1 m (3 ft). See “Keyless Access Operation” later in this section.

The remote key functions may work up to 60 m (197 ft) away from the vehicle.

Other conditions can impact the performance of the remote key. See *Remote Key* ⇨ 7.







: Press to lock all doors and the fuel door, if equipped. The turn signal indicators may flash and/or the horn may sound on the second press to indicate locking. To view available settings for this feature, on the infotainment home screen, select Settings > Vehicle > Remote Lock, Unlock, Start.

Pressing  may also arm the alarm system. See *Vehicle Alarm System* ⇨ 22.

If equipped and enabled, double press and hold  for about three seconds to remotely close the windows. To view available settings for this feature, on the infotainment home screen, select Settings > Vehicle > Remote Lock, Unlock, Start. See *Power Windows* ⇨ 30.

If equipped with remote folding mirrors, double pressing and holding  on the remote key may fold the mirrors. See *Folding Mirrors* ⇨ 26.



: Press to unlock the driver door and the fuel door, if equipped. Press again within five seconds to unlock all doors. The remote key can be programmed to unlock all doors on the first button press. To view available settings for this feature, on the infotainment home screen, select Settings > Vehicle > Remote Lock, Unlock, Start. When remotely unlocking the vehicle at



night, the headlamps and back-up lamps may come on for about 30 seconds to light your approach to the vehicle. The turn signal indicators may flash to indicate unlocking.

Pressing  will disarm the alarm system. See *Vehicle Alarm System* ⇨ 22.

If equipped and enabled, double press and hold  for about three seconds to remotely open the windows. To view available settings for this feature, on the infotainment home screen, select Settings > Vehicle > Remote Lock, Unlock, Start. See *Power Windows* ⇨ 30.

If equipped with remote folding mirror, double pressing and holding  on the remote key may unfold the mirrors. See *Folding Mirrors* ⇨ 26.

: Press  twice to start the engine from outside the vehicle using the remote key. See *Remote Start* ⇨ 12.

: Press and release one time to initiate vehicle locator. The exterior lamps flash and the horn chirps three times. Press and hold  for more than three seconds to sound the panic alarm. The horn sounds and the turn signal lamps flash for 30 seconds, or until  is pressed again or the vehicle is started.

: Press twice to release the trunk.

## Keyless Access Operation

The Keyless Access system lets you lock and unlock the doors and access the trunk without removing the remote key from your pocket, purse, briefcase, etc. The remote key must be within 1 m (3 ft) of the trunk or door being opened. The button is on the outside door handle.

The Keyless Access system can be programmed to be turned off or to unlock all doors on the first door handle press from the driver door. Keyless unlocking can also be turned off. To view available settings for this feature, on the infotainment home screen, select Settings > Vehicle > Remote Lock, Unlock, Start.

If equipped with memory seats, remote keys 1 and 2 are linked to seating positions of memory 1 or 2. See *Memory Seats* ⇨ 39.

## Keyless Unlocking/Locking from the Driver Door

When the doors are locked and the remote key is within 1 m (3 ft) of the door handle, pressing the door handle button on the inside of the

driver door handle will unlock the driver door. If the door handle button is pressed again within five seconds, all passenger doors will unlock.

If equipped with remote folding mirror, pressing the driver door handle button may fold and unfold the mirrors. See *Folding Mirrors* ⇨ 26.

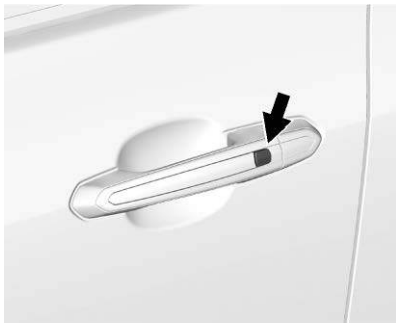

**Driver Door Shown, Passenger Similar**

Pressing the door handle button will cause all doors to lock if any of the following occur:

- It has been more than five seconds since the first door handle button press.
- Two door handle button presses were used to unlock all doors.

- Any vehicle door has opened and all doors are now closed.

### Keyless Unlocking/Locking from the Passenger Doors



When the doors are locked and the remote key is within 1 m (3 ft) of the door handle, pressing the door handle button on a passenger door handle will unlock all doors. Pressing the door handle button will cause all doors to lock if any of the following occur:

- The door handle button was used to unlock all doors.
- Any vehicle door has opened and all doors are now closed.

### Disable/Enable Keyless Unlocking of Exterior Door Handles and Trunk

If equipped, keyless unlocking of the exterior door handles and trunk can be disabled and enabled.



### Disabling Keyless Unlocking:

With the vehicle off, press and hold  and  on the remote key at the same time for approximately four seconds. The turn signal lamps will flash four times quickly to indicate access is disabled. Using any exterior handle to

unlock the doors or open the trunk will cause the turn signal lamps to flash four times quickly, indicating access is disabled. If disabled, disarm the alarm system before starting the vehicle.

Disabling Keyless Unlocking may also be configured under Vehicle settings. To view available settings for this feature, on the infotainment home screen, select Settings > Vehicle > Remote Lock, Unlock, Start.

### Enabling Keyless Unlocking:

With the vehicle off, press and hold  and  on the remote key at the same time for approximately four seconds. The turn signal lamps will flash twice quickly to indicate access is enabled.

Enabling Keyless Unlocking may also be configured under Vehicle settings. To view available settings for this feature, on the infotainment home screen, select Settings > Vehicle > Remote Lock, Unlock, Start.

### Passive (Walkaway) Locking

The Keyless Access system will lock the vehicle several seconds after all doors are closed if the vehicle is off and at least one remote key has been removed or none remain in the vehicle.

If equipped, the fuel door will also lock.

If other electronic devices interfere with the remote key signal, the vehicle may not detect the remote key inside the vehicle. If passive (walkaway) locking is enabled, the doors may lock with the remote key inside the vehicle. Do not leave the remote key in an unattended vehicle.

To view available settings for this feature, on the infotainment home screen, select Settings > Vehicle > Power Door Locks.

If equipped with remote folding mirror, passive (walkaway) locking may fold the mirrors. See *Folding Mirrors* ⇨ 26.

### Temporary Disable of Passive (Walkaway) Locking

Temporarily disable passive locking by pressing and holding  on the interior door switch with a door open for at least four seconds, or until three chimes are heard. Passive (walkaway) locking will then remain disabled until the vehicle is turned on.

### Remote Key Left In Vehicle Alert

When the vehicle is turned off and a remote key is left in the vehicle, the horn will chirp three times after all doors are closed. To

view available settings for this feature, on the infotainment home screen, select Settings > Vehicle > Remote Lock, Unlock, Start.

### Remote Key No Longer In Vehicle Alert

If the vehicle is on, with a door open, and then all doors are closed, the vehicle will check for a remote key inside. If a remote key is not detected, the Driver Information Center (DIC) will display NO KEY FOUND and the horn will chirp three times.

This occurs only once each time the vehicle is driven. To view available settings for this feature, on the infotainment home screen, select Settings > Vehicle > Remote Lock, Unlock, Start.

### Keyless Trunk Opening

Press the touch pad on the rear of the trunk above the license plate if the remote key is within 1 m (3 ft).

### Mechanical Key Access

To access a vehicle with a weak remote key battery, see *Door Locks* ⇨ 13.

## Programming Remote Keys to the Vehicle

Only remote keys programmed to the vehicle will work. If a remote key is lost or stolen, a replacement can be purchased and programmed through your dealer. The vehicle can be reprogrammed so that lost or stolen remote keys no longer work. Each vehicle can have up to eight remote keys matched to it.

### Starting the Vehicle with a Low Remote Key Battery

For improved vehicle security, the remote key is equipped with a motion sensor. When starting the vehicle, if the remote key has been idle for a while, the DIC may display KEY IN SLEEP MODE, MOVE KEY, THEN START. Move the remote key slightly and try starting the vehicle. When starting the vehicle, if the remote key battery is depleted or there is signal interference, the DIC may display NO KEY FOUND, REPLACE BATTERY IN KEY or NO REMOTE KEY WAS DETECTED PLACE KEY IN KEY POCKET THEN START YOUR VEHICLE, follow the steps shown below:

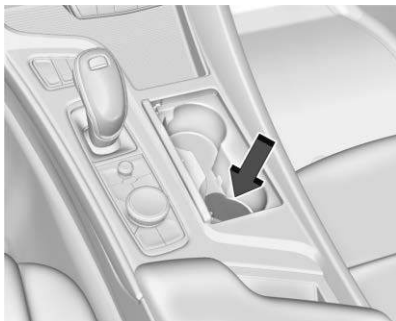

1. Place the remote key into the rear cupholder.
2. With the vehicle in P (Park) or N (Neutral) press the brake pedal and ENGINE START/STOP.  
Replace the remote key battery as soon as possible.

### Battery Replacement

#### Warning

Never allow children to play with the remote key. The remote key contains a small battery, which can be a choking hazard. If swallowed, internal burns can occur, resulting in severe injury or death. Seek medical attention immediately if a battery is swallowed.

#### Warning

To avoid personal injury, do not touch metal surfaces on the remote key when it has been exposed to extreme heat. These surfaces can be hot to the touch at temperatures above 59 °C (138 °F).

#### Caution

When replacing the battery, do not touch any of the circuitry on the remote key. Static from your body could damage the remote key.

#### Caution

Always replace the battery with the correct type. Replacing the battery with an incorrect type could potentially create a risk of battery explosion. Dispose of used batteries according to instructions and local laws. Do not attempt to burn, crush, or cut the used battery, and avoid exposing the battery to environments with extremely low air pressures or high temperatures.

#### Caution

If the remote key is not reassembled properly, liquids could enter the housing and damage the circuitry, resulting in a remote key malfunction and/or failure. To prevent damage, always follow the steps for remote key reassembly in this manual to ensure the remote key is sealed properly whenever the remote key is opened.

Replace the battery if the DIC displays REPLACE BATTERY IN KEY.



1. Press the button on the side of the remote key and pull the mechanical key out. Never pull the mechanical key out without pressing the button.



2. Use the mechanical key blade in the slot to remove the battery cover by hand.

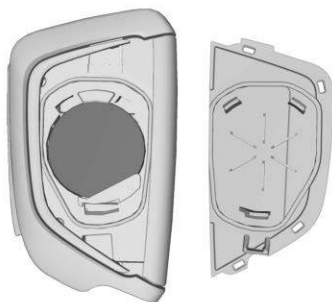

3. Remove the seal by pulling on the tab to access the battery.
4. Remove the old battery. Do not use a metal object.
5. Insert the new battery, positive side toward the back cover. Replace with a CR2450 Lithium or equivalent battery.
6. Place the seal back into the groove around the battery compartment.
7. Reassemble the battery cover by snapping it back on the remote key.
8. Reinsert the mechanical key.

## Remote Start

This feature allows the engine to be started from outside the vehicle. It is not available on vehicles with a manual transmission.

: This button on the remote key is for remote start.

The climate control system will use the previous settings during a remote start. The rear window defogger may come on during remote start based on cold ambient conditions. The rear defog indicator light does not come on during remote start.

If equipped, the heated and ventilated front seats may also come on when the vehicle personalization setting is enabled. See *Heated and Ventilating Front Seats* ⇨ 45.

If equipped with a remote start heated steering wheel, it may come on during a remote start. See *Heated Steering Wheel* ⇨ 85.

Laws in some local communities may restrict the use of remote starters. For example, some laws may require a person using remote start to have the vehicle in view. Check local regulations for any requirements.

If your vehicle is low on fuel, do not use the remote start feature. The vehicle may run out of fuel.

The remote key range may be shorter while the vehicle is running.

Other conditions can affect the performance of the remote key. See *Remote Key* ⇨ 7.

You are allowed multiple starts totaling 30 minutes of engine run time. The maximum run time of a single start is 15 minutes, and it will shut off automatically. You could do three 10 minute starts, if you manually shut off after 10 minutes. The last 10 minute start would shut off automatically as your total 30 minutes will have been used.

### Starting the Engine Using Remote Start

1. Press  twice on the remote key. The turn signal lamps will flash. The lamps flash to confirm the request to remote start the vehicle has been received. During the remote start, the parking lamps will remain on as long as the engine is running.

2. The engine will shut off after 15 minutes or after the remainder of the 30 minute total running time is used, unless you stop the remote start before engine running has completed or the vehicle is turned on.
3. Press the brake pedal and turn the ignition on to drive the vehicle.

### Additional Engine Run Time

Remote start can be used for up to 30 minutes of total engine run time.

After two remote starts of 15 minutes, or multiple shorter time starts totaling 30 minutes have been used, the vehicle must be started and then turned off before the remote start can be used again.

### Canceling a Remote Start

To cancel a remote start, do any of the following:

- Press  once. The parking lamps will turn off.
- Turn on the hazard warning flashers.
- Turn the vehicle on and then back off.

### Conditions in Which Remote Start Will Not Work

The remote start will not operate if any of the following occur:

- The ignition is in any mode other than off.
- A remote key is in the vehicle.
- The hood is not closed.
- The hazard warning flashers are on.
- There is an emission control system malfunction.
- The engine coolant temperature is too high.
- The oil pressure is low.
- The 30 minutes of engine run time have been used.
- The vehicle is not in P (Park).

### Door Locks

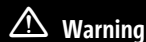

#### Warning



Unlocked doors can be dangerous.

(Continued)



**Warning (Continued)**

- Passengers, especially children, can easily open the doors and fall out of a moving vehicle. The doors can be unlocked and opened while the vehicle is moving. The chance of being thrown out of the vehicle in a crash is increased if the doors are not locked. So, all passengers should wear seat belts properly and the doors should be locked whenever the vehicle is driven.
- Young children who get into unlocked vehicles may be unable to get out. A child can be overcome by extreme heat and can suffer permanent injuries or even death from heat stroke. Always lock the vehicle whenever leaving it.
- Outsiders can easily enter through an unlocked door when you slow down or stop the vehicle. Locking the doors can help prevent this from happening.

Always take your remote key with you when exiting the vehicle to prevent being locked out. To lock or unlock the doors from outside the vehicle:

- Press  or  on the remote key. See *Remote Key Operation* ⇨ 7.
- Use the mechanical key in the driver door. The key lock cylinder is covered with a cap. See “Driver Door Key Lock Cylinder Access (In Case of Dead Battery)” later in this section.

To lock or unlock the doors from inside the vehicle:

- Press  or  on the power door lock switch.
- Pull the front door handle once to open the door. Pull the rear door handle once to unlock and once more to open the door.

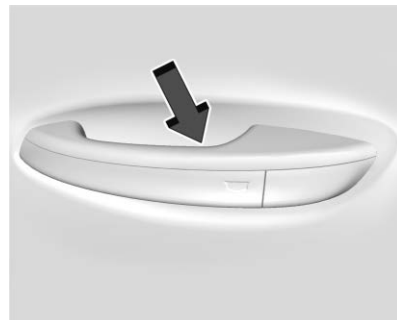
**Keyless Access**

The remote key must be within 1 m (3 ft) of the trunk or door being opened or locked. To unlock and unlatch any door, press the release button on the inside grip area of the outside door handle. Touch the sensor on the front outside door handle to lock. See “Keyless Access Operation” in *Remote Key Operation* ⇨ 7.

### Driver Door Key Lock Cylinder Access (In Case of Dead Battery)

To access the driver door key lock cylinder and unlatch the door:

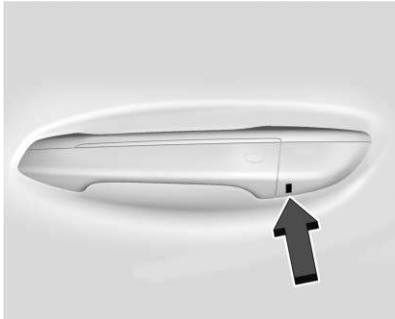

1. Insert the mechanical key into the slot at the bottom of the handle and push upward all the way until the cover frees. Do not pry or pull on the key.

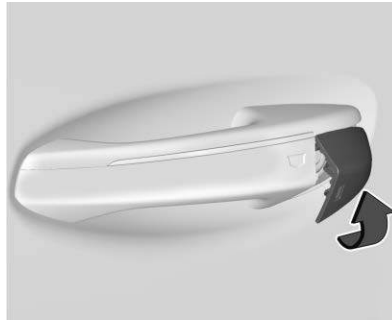

2. Remove the cover.

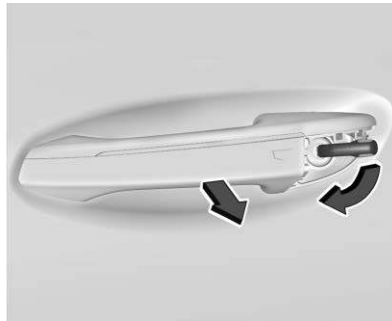

3. Insert the mechanical key in the cylinder.

4. Turn the mechanical key clockwise until it stops.
5. Slowly turn the mechanical key counterclockwise while pulling the handle to unlatch the door.
6. Repeat steps 4 and 5 if the door does not fully open.

To replace the cap:

1. Align the top edge of the cover to the handle.

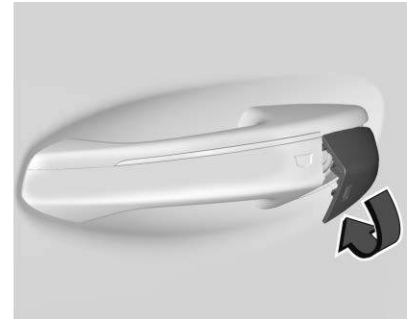

2. Turn downward to snap cover into position.
3. Check to ensure cap is fully seated.





### Free-Turning Locks

The door key lock cylinder turns freely when either the wrong key is used, or the correct key is not fully inserted. The free-turning door lock feature prevents the lock cylinder from being forced open. To reset the lock cylinder, ensure the correct key is fully inserted into the lock cylinder. Rotate the key until you feel the lock cylinder click back into place. Remove the key and reinsert fully, rotate the key to unlock the vehicle.

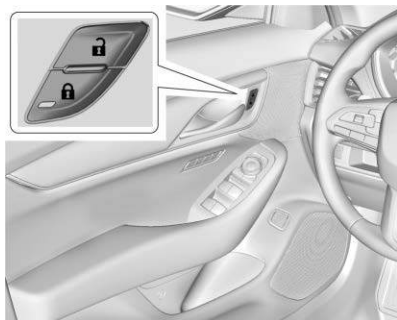
### Power Door Locks



: Press to lock the doors. The indicator light in the switch will illuminate when locked.

: Press to unlock the doors.



If equipped, the fuel door is also locked or unlocked using these features.

### Delayed Locking

This feature delays the actual locking of the doors until five seconds after all doors are closed.

When  is pressed on the power door lock switch with the door open, a chime will sound three times indicating that delayed locking is active.

The doors will then lock automatically five seconds after all doors are closed. If a door is reopened before five seconds have elapsed, the five-second timer will reset once all the doors are closed again.

Press  on the door lock switch again, or press  on the key, to override this feature and lock the doors immediately.

Delayed locking can be programmed. To view available settings for this feature, touch the Settings icon on the infotainment home page. Select “Vehicle” to display the list of available options and select “Power Door Locks”.

### Automatic Door Locks

The doors will lock automatically when all doors are closed, the ignition is on, and the vehicle is shifted out of P (Park).

If a vehicle door is unlocked, and then opened and closed, the doors will lock either when your foot is removed from the brake or the vehicle speed becomes faster than 13 km/h (8 mph).

To unlock the doors:

- Press  on the power door lock switch.
- Shift the transmission into P (Park).

Automatic door locking cannot be disabled. Automatic door unlocking can be programmed. To view available settings for this feature, touch the Settings icon on the infotainment home page. Select “Vehicle” to display the list of available options and select “Power Door Locks”.

### Lockout Protection

If the vehicle is on or in accessory mode and the power door lock switch is pressed with the driver door open, all the doors will lock and only the driver door will unlock.

If the vehicle is off and locking is requested while a door is open, when all doors are closed the vehicle will check for keys inside. If any remote key programmed to the vehicle is detected and the number of keys inside has not reduced, the driver door will unlock and the horn will chirp three times.

Lockout Protection can be manually overridden with the driver door open by pressing and holding  on the power door lock switch.

## Safety Locks

### Manual Safety Locks



The safety lock is on the inside edge of the rear doors. To use the safety lock:

1. Move the lever forward to the lock position.
2. Close the door.
3. Repeat for the other rear door.

To open a rear door when the safety lock is on:

1. Unlock the door by activating the inside handle, by pressing the power door lock switch, or by using the remote key.
2. Open the door from the outside.

When the safety lock is enabled, adults and older children will not be able to open the rear door from the inside. Cancel the safety locks to enable the doors to open from the inside.

To cancel the safety lock:

1. Unlock the door and open it from the outside.
2. Move the lever rearward to unlock. Repeat for the other door.

## Doors

### Trunk

#### Warning

Exhaust gases can enter the vehicle if it is driven with the liftgate or trunk/hatch open, or with any objects that pass through the seal between the body and the trunk/hatch or liftgate. Engine exhaust contains carbon monoxide (CO) which cannot be seen or smelled. It can cause unconsciousness and even death.

If the vehicle must be driven with the liftgate or trunk/hatch open:

- Close all of the windows.
- Fully open the air outlets on or under the instrument panel.
- Adjust the climate control system to a setting that brings in only outside air and set the fan speed to the highest setting. See “Climate Control Systems” in the Index.

(Continued)

**Warning (Continued)**



- If the vehicle is equipped with a power liftgate, disable the power liftgate function.

See *Engine Exhaust* ⇨ 199.

**Manual Trunk**

To release the trunk, the vehicle must be off or in P (Park).



- Press  on the driver door.
- Press  twice quickly on the remote key.



- Press the touch pad on the rear of the trunk above the license plate when all doors are unlocked.

The trunk can be opened while the vehicle is locked by pressing the touch pad above the license plate while the remote key is within 1 m (3 ft) of the rear of the vehicle. See *Remote Key Operation* ⇨ 7.



Close the trunk by pulling on the handle. Do not use the handle as a tie-down. Do not press the touch pad while closing the trunk; this will cause the trunk lid to be unlatched.

The trunk has an electric latch. If the vehicle has lost power or the battery is disconnected, the trunk will not open. If this happens, enter the rear compartment by folding the rear seats down, and pull the emergency release handle to open the trunk.

## Hands-Free Trunk



If equipped, the trunk may be opened with a kicking or swiping motion under the rear bumper at the location of the projected logo. The remote key must be within 1 m (3 ft). See *Radio Frequency Statement* ⇨ 387.

The hands-free feature can be customized. To view available settings for this feature, touch the Settings icon on the infotainment home page. Select “Vehicle” to display the list of available options and select “Comfort and Convenience.” Choose from the following:

**On-Open Only:** The kicking motion is activated to open the trunk.

**Off:** The feature is disabled.

To operate, kick your foot straight up in one swift motion under the center of the rear bumper at the location of the projected logo, then pull it back. Alternatively, swipe your foot in one swift motion below the center of the rear bumper at the location of the projected logo.

- Do not keep your foot under the bumper; it will not activate.
- This feature may be temporarily disabled under some conditions. If it does not respond to the kick, open the trunk by another method or start the vehicle and the feature will be re-enabled.

## Projected Logo

If equipped with this feature, a vehicle logo will be projected for one minute onto the ground near the rear bumper when a remote key is detected within approximately 2 m (6 ft). The projected logo may not be visible under brighter daytime conditions.

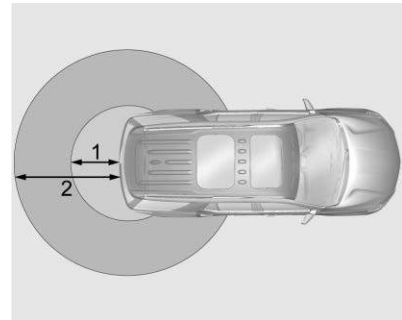

1. 1 m (3 ft) Hands-Free Operation Detection Zone
2. 2 m (6 ft) Projected Logo Detection Zone

The projected logo shows where the kicking motion is to take place.

The projected logo will only be available for this remote key after it has been out of range for at least 20 seconds.

If a remote key is again detected within approximately 2 m (6 ft) of the trunk, or another hands-free operation has been detected, the one-minute timer will be reset.

The projected logo will not work under these conditions:

- The vehicle battery is low.
- The transmission is not in P (Park).
- Hands Free Trunk Control is set to Off in vehicle personalization. To view available settings for this feature, touch the Settings icon on the infotainment home page. Select "Vehicle" to display the list of available options and select "Comfort and Convenience."
- The vehicle remains parked for 72 hours or more, with no remote key use or Keyless Access operation. To re-enable, press any button on the remote key or open and close a vehicle door.

The projected logo will not work for a single remote key when a remote key:

- Has been left within approximately 5 m (15 ft) of the trunk for several minutes.
- Has been left inside the vehicle and all vehicle doors are closed.
- Has approached the area outside of the trunk five times within 10 minutes.

### Lens Cleaning



Clean the recessed lens with a cotton swab.

**Hands-Free Trunk and Projected Logo Availability**

<b>Action</b>	<b>Hands-Free Trunk</b>	<b>Projected Logo</b>
Remote key entering projected logo detection zone	Operative	On for one minute
Remote key left inside projected logo detection zone for minimum of 5 minutes	Operative	Off until remote key button press or a door is opened and closed
Remote key brought in and out of projected logo detection zone five times or more within 5 minutes	Operative	Off for one hour or until remote key button press or a door is opened and closed
Vehicle remains parked for 10 days or more	Operative	Off until remote key button press or a door is opened and closed
Vehicle battery is low	Non-operative	Off
Transmission is not in P (Park)	Non-operative	Off
Hands-free trunk is disabled in vehicle personalization	Non-operative	Off

### Emergency Trunk Release Handle

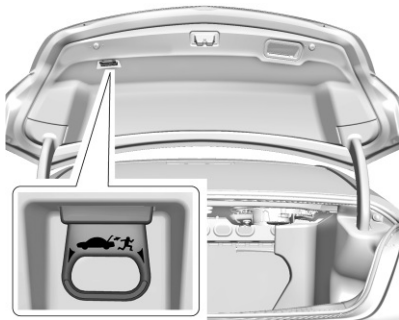

#### Caution

Do not use the emergency trunk release handle as a tie-down or anchor point when securing items in the trunk as it could damage the handle.

There is a glow-in-the-dark emergency trunk release handle on the trunk lid. This handle will glow following exposure to light. Pull the release handle to open the trunk from the inside.



### Vehicle Security

This vehicle has theft-deterrent features; however, they do not make the vehicle impossible to steal.

### Vehicle Alarm System

This vehicle has an anti-theft alarm system.

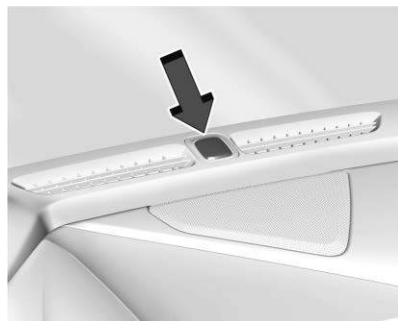

The indicator light, on the instrument panel near the windshield, indicates the status of the system.

**Off:** Alarm system is disarmed.



**On Solid:** Vehicle is secured during the delay to arm the system.

**Fast Flash:** Vehicle is unsecured. A door, the hood, or the trunk is open.

**Slow Flash:** Alarm system is armed.

### Arming the Alarm System

1. Turn off the vehicle.
2. Lock the vehicle in one of three ways:
  - Use the remote key.

- Use the Keyless Access system.
  - With a door open, press  on the interior of the door.
3. After 30 seconds the alarm system will arm, and the indicator light will begin to slowly flash indicating the alarm system is operating. Pressing  on the remote key a second time will bypass the 30-second delay and immediately arm the alarm system.

The vehicle alarm system will not arm if the doors are locked with the mechanical key.

If the driver door is opened without first unlocking with the remote key, the horn will chirp and the lights will flash to indicate pre-alarm. If the vehicle is not started, or the door is not unlocked by pressing  on the remote key during the 10-second pre-alarm, the alarm will be activated.

The alarm will also be activated if a passenger door, the trunk, or the hood is opened without first disarming the system. When the alarm is activated, the turn signals flash and the horn sounds for about 30 seconds. The alarm system will then re-arm to monitor the next unauthorized event.

### Disarming the Alarm System

To disarm the alarm system or turn off the alarm if it has been activated:

- Press  on the remote key.
- Unlock the vehicle using the Keyless Access system.
- Start the vehicle.

To avoid setting off the alarm by accident:

- Lock the vehicle after all occupants have left the vehicle and all doors are closed.
- Always unlock a door with the remote key or use the Keyless Access system.

Unlatching the driver door with the mechanical key will not disarm the system or turn off the alarm.

### How to Detect a Tamper Condition

If  is pressed on the remote key and the horn chirps and the lights flash three times, a previous alarm occurred while the system was armed.

If the alarm has been activated, a message will appear on the DIC.

### Power Sounder, Inclination Sensor, and Intrusion Sensor

In addition to the standard theft-deterrent system features, this system may also have a power sounder, inclination sensor, and intrusion sensor.

The power sounder provides an audible alarm which is distinct from the vehicle's horn. It has its own power source, and can sound an alarm if the vehicle's battery is compromised.

The inclination sensor can set off the alarm if it senses movement of the vehicle, such as when a tire is removed. Make sure the vehicle's alarm is not armed prior to any jacking.

The intrusion sensor monitors the vehicle interior, and can activate the alarm if it senses unauthorized entry into the vehicle's interior. Do not allow passengers or pets to remain in the vehicle when the intrusion sensor is activated.

Before arming the theft-deterrent system and activating the intrusion sensor:

- Make sure all doors and windows are completely closed.
- Secure any loose items such as sun glasses.



- Make sure there are no obstructions blocking the sensors in the front overhead console.
- Close DVD screens before leaving the vehicle.

### Inclination and Intrusion Sensor Disable Switch

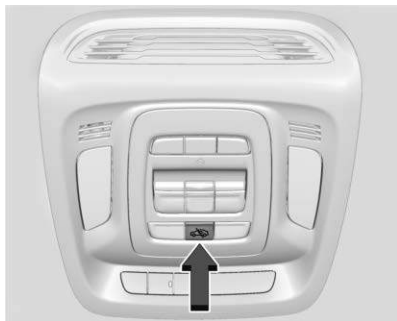

It is recommended that the intrusion and inclination sensor be deactivated if pets are left in the vehicle or the vehicle is being transported. With the vehicle turned off, press  in the front overhead console. The indicator light will come on momentarily,

indicating that these sensors have been disabled for the next alarm system arming cycle.

### Steering Column Lock

If equipped, the steering column lock is a theft-deterrent device. This feature locks the steering column when the vehicle is turned off and the driver door is opened, or when the driver door is opened and then the vehicle is turned off. The steering column unlocks when the vehicle is turned on.

The Driver Information Center (DIC) may display one of these messages:

- A message to service the steering column lock indicates that an issue has been detected with the column lock feature and the vehicle should be serviced.
- A message that the steering column is locked indicates that the engine is running, but the steering column is still locked. It is normal for the column to be locked during a remote start, but the column should unlock after the brake pedal is pressed and the vehicle is started. No message will display during a remote start.

- A message that the steering wheel must be turned and the vehicle must be started again indicates that the column lock mechanism is bound, the column locking device was unable to unlock the steering column, and the vehicle did not start. If this happens, immediately turn the steering wheel from side to side to unbind the column lock. If this does not unlock the steering column, turn the vehicle off and open the driver door to reset the system. Then turn the vehicle on and immediately turn the steering wheel side to side for about 15 seconds. In some cases, it may take significant force to unbind the column.

To keep the steering column from binding, straighten the front wheels before turning off the vehicle.

### Immobilizer

See *Radio Frequency Statement* ⇨ 387.

### Immobilizer Operation

This vehicle has a passive theft-deterrent system.

The system does not have to be manually armed or disarmed.

The vehicle is automatically immobilized when the vehicle is turned off.

The immobilization system is disarmed when the ignition is turned on or to accessory mode and a valid remote key is present in the vehicle.



The security light, in the instrument cluster, comes on if there is a problem with arming or disarming the theft-deterrent system.

The system has one or more remote keys matched to an immobilizer control unit in the vehicle. Only a correctly matched remote key will start the vehicle. If the remote key is ever damaged, you may not be able to start your vehicle.

When trying to start the vehicle, the security light may come on briefly.

If the engine does not start and the security light stays on, there is a problem with the system. Turn the ignition off and try again.

If the vehicle will not change ignition modes (accessory mode, on, off), and the remote key appears to be undamaged, try another remote key. Or, you may try placing the remote key in the backup location. See *Remote Key Operation* ⇨ 7.

If the ignition modes will not change with the other remote key or in the backup location, the vehicle needs service. If the ignition does change modes, the first remote key may be faulty. See your dealer.

It is possible for the immobilizer system to learn new or replacement remote keys. Up to eight remote keys can be programmed for the vehicle. To program additional remote keys, see “Programming Remote Keys to the Vehicle” under *Remote Key Operation* ⇨ 7.

Do not leave the remote key or device that disarms or deactivates the theft-deterrent system in the vehicle.

## Exterior Mirrors

### Convex Mirrors

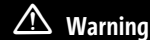

#### Warning





A convex mirror can make things, like other vehicles, look farther away than they really are. If you cut too sharply into the right lane, you could hit a vehicle on the right. Check the inside mirror or glance over your shoulder before changing lanes.

The passenger side mirror is convex shaped. A convex mirror's surface is curved so more can be seen from the driver seat.

## Power Mirrors



To adjust each mirror:

1. Press  or  to select the driver or passenger side mirror. The indicator light will illuminate.
2. Press the arrows on the control pad to move the mirror in the desired direction.
3. Adjust each outside mirror so that a little of the vehicle and the area behind it can be seen.
4. Press  or  again to deselect the mirror.

## Memory Mirrors

The vehicle may have memory mirrors. See *Memory Seats* ⇨ 39.

## Side Blind Zone Alert (SBZA)

The vehicle may have SBZA. See *Side Blind Zone Alert (SBZA)* ⇨ 266.

## Lane Change Alert (LCA)

The vehicle may have LCA. See *Lane Change Alert (LCA)* ⇨ 266.



## Folding Mirrors

### Manual Folding Mirrors

The mirrors can be folded inward toward the vehicle to prevent damage when going through an automatic car wash. Push the mirror outward to return it to the original position.

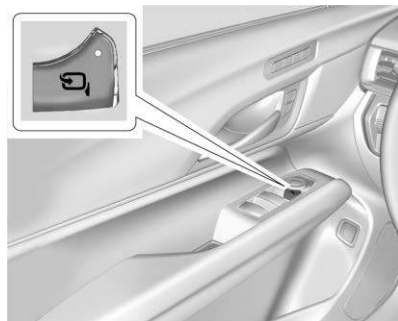
## Power Folding Mirrors



If equipped, press  to power fold the mirrors. Press  again to unfold.

The outside mirrors may automatically unfold when the vehicle is driven above 20 km/h (12 mph), but may be folded with the power folding mirror switch. If the vehicle speed is driven above 40 km/h (25 mph), they may automatically unfold and may not be refolded with the power folding mirror switch.

### Resetting the Power Folding Mirrors

Reset the power folding mirrors if:

- The mirrors are accidentally obstructed while folding.



- They are accidentally manually folded/unfolded.
- The mirrors do not stay in the unfolded position.
- The mirrors vibrate at normal driving speeds.

Fold and unfold the mirrors one time using the mirror controls to reset them to their normal position. A noise may be heard during the resetting of the power folding mirrors. This sound is normal after a manual folding operation.

### Remote Mirror Folding

If equipped with power folding mirrors, and the mirrors have been folded with the power folding mirror switch, they may not be automatically unfolded by the Remote Mirror Folding feature.

If equipped with power folding mirrors, and the mirrors have not been folded with the power folding mirror switch and the vehicle is in P (Park), they may be automatically folded/unfolded as follows:

1. If doors are locked by pressing  on the remote key, the mirrors will fold. If doors are unlocked by pressing  on the remote key, the mirrors will unfold. See *Remote Key Operation* ⇨ 7.
2. If doors are locked by pressing the door handle button, the mirrors will fold. If doors are unlocked by pressing the door handle button, the mirrors will unfold. See “Keyless Unlocking/Locking from the Driver Door” in *Remote Key Operation* ⇨ 7.
3. If passive locking is enabled and doors are locked by that feature, the mirrors will fold. See “Passive Locking” in *Remote Key Operation* ⇨ 7.

### Heated Mirrors

If equipped with heated mirrors:

 REAR : The rear window defogger also heats the outside mirrors.

See *Dual Automatic Climate Control System* ⇨ 167.

### Automatic Dimming Mirror

If the vehicle has the automatic dimming mirror, the driver outside mirror automatically adjusts for the glare of headlamps behind you.

Do not spray glass cleaner or chrome cleaner directly onto the mirror. Only use a soft towel dampened with water.

### Reverse Tilt Mirrors

If equipped with reverse tilt mirrors and memory seats, the passenger and/or driver mirror tilts to a preselected position when the vehicle is in R (Reverse). This allows the curb to be seen when parallel parking.

The mirror(s) may move from their tilted position when:

- The vehicle is shifted out of R (Reverse) or remains in R (Reverse) for about 30 seconds.
- The vehicle is turned off.
- The vehicle is driven in R (Reverse) above a set speed.

To view available settings from the infotainment screen, touch Settings > Vehicle > Comfort and Convenience.

## Interior Mirrors

### Interior Rearview Mirrors

Adjust the rearview mirror for a clear view of the area behind the vehicle.

Do not spray glass cleaner directly on the mirror. Use a soft towel dampened with water.

### Manual Rearview Mirror

If equipped, push the tab forward for daytime use and pull it rearward for nighttime use to avoid glare of the headlamps from behind.

### Automatic Dimming Rearview Mirror

If equipped, automatic dimming reduces the glare of headlamps from behind. The dimming feature comes on when the vehicle is started.

### Rear Camera Mirror

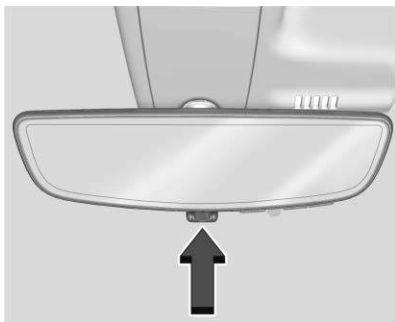

If equipped, this automatic dimming mirror provides a wide angle camera view of the area behind the vehicle.

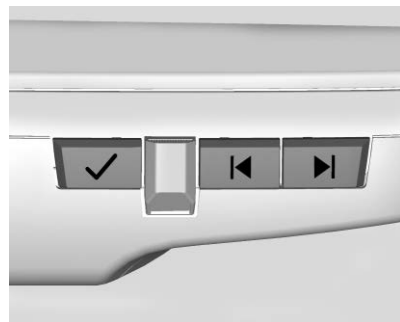

Pull the tab to turn on the display. Push the tab to turn it off. When off the mirror is automatic dimming. Adjust the mirror for a clear view of the area behind the vehicle while the display is off.



Press  to scroll through the adjustment options.

Press  and  to adjust the settings using the indicators on the mirror. The indicators will remain visible for five seconds after the last button activation, and the settings will remain saved.

The adjustment options are:

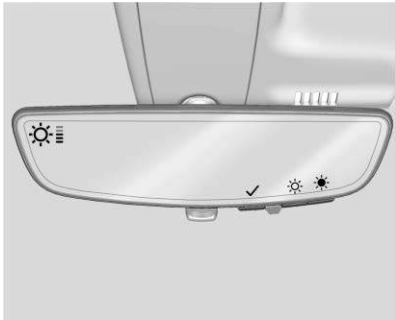

- Brightness

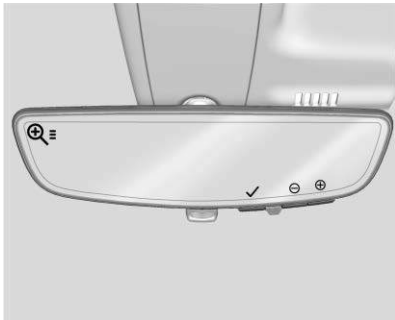

- Zoom

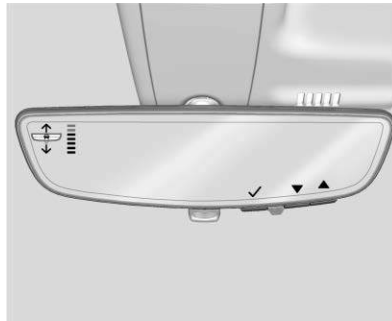

- Tilt

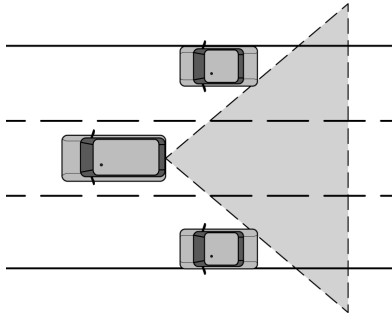

### Warning

The Rear Camera Mirror (RCM) has a limited view. Portions of the road, vehicles, and other objects may not be seen. Do not drive or park the vehicle using only this camera. Objects may appear closer than they are. Check the outside mirrors or glance over your shoulder when making lane changes or merging. Failure to use proper care may result in injury, death, or vehicle damage.

### Troubleshooting

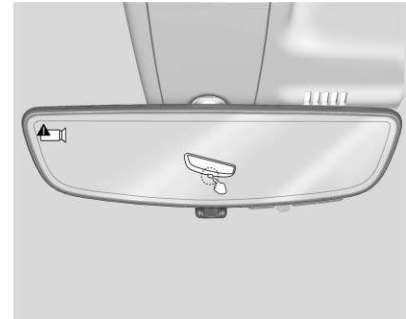

See your dealer for service if a blue screen and  are displayed in the mirror, and the display shuts off. Also, push the tab as indicated to return to the automatic dimming mode.

The Rear Camera Mirror may not work properly or display a clear image if:

- There is glare from the sun or headlamps. This may obstruct objects from view. If needed, push the tab to turn off the display.
- Dirt, snow, or other debris blocks the camera lens. Clean the lens with a soft damp cloth.



- The camera's mounting on the vehicle has been damaged, and/or the position or the mounting angle of the camera has changed.

## Windows

### Warning

Never leave a child, a helpless adult, or a pet alone in a vehicle, especially with the windows closed in warm or hot weather. They can be overcome by the extreme heat and suffer permanent injuries or even death from heat stroke.



The vehicle aerodynamics are designed to improve fuel economy performance. This may result in a pulsing sound when either rear

window is down and the front windows are up. To reduce the sound, open either a front window or the sunroof, if equipped.

## Power Windows

### Warning

Children could be seriously injured or killed if caught in the path of a closing window. Never leave the remote key in a vehicle with children. When there are children in the rear seat, use the window lockout switch to prevent operation of the windows. See *Keys* ⇨ 6.

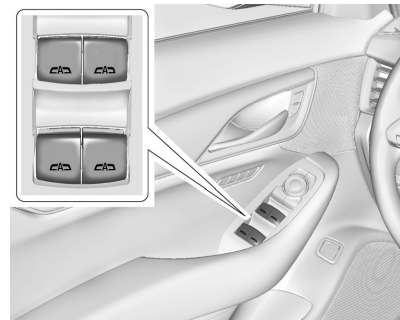

The power windows work when the vehicle is on, in accessory mode, or when Retained Accessory Power (RAP) is active. See *Retained Accessory Power (RAP)* ↗ 197.



Using the window switch, press to open or pull to close the window.

The windows may be temporarily disabled if they are used repeatedly within a short time.

### Rear Window Lockout

If equipped, this feature prevents rear seat passengers from opening the rear windows.

To enable or disable the feature:

- Press  to engage the rear window lockout feature. The indicator light is on when engaged.
- Press  again to disengage.

### Window Express Movement

This feature allows you to open all windows fully without holding the switches down. Press the switch down fully, then release to express open the window.

If equipped, pull the window switch up fully and quickly release to express close the window.

Briefly press or pull the window switch in the same direction to stop that window's express movement.

### Express Window Down

If equipped, press and release  to open all windows.

Use the window switches to close each window.

### Window Automatic Reversal System

If equipped, the window automatic reversal system reverses and stops window movement if it detects an object in its path. Extreme cold or ice may cause the window to auto-reverse. The window will operate normally after the object or condition is removed.

### Automatic Reversal System Override

#### Warning

If automatic reversal system override is active, the window will not reverse automatically. You or others could be injured and the window could be damaged.

(Continued)

### Warning (Continued)

Before using automatic reversal system override, make sure that all people and obstructions are clear of the window path.

When the vehicle is on, override the automatic reversal system by pulling and holding the window switch if conditions prevent the window from closing.

### Programming the Power Windows

Programming may be necessary if the vehicle battery is disconnected or discharged. If the window is unable to express-close, to program each express-close window:

1. Close all doors.
2. Turn the vehicle on.
3. Partially open the window you want to program, then close it and continue to pull the switch briefly after the window has fully closed.
4. Open the window and continue to press the switch briefly after the window has fully opened.



## Remote Window Operation

If equipped, this feature allows you to open all the windows remotely.

To view available settings and enable Remote Window Operation, from the infotainment home screen, touch Settings > Vehicle > Remote Lock, Unlock, Start.

If enabled, double-press and hold  on the remote key.

If equipped, all windows can also be closed using the remote key. To close, double-press and hold  on the remote key.

## Sun Visors

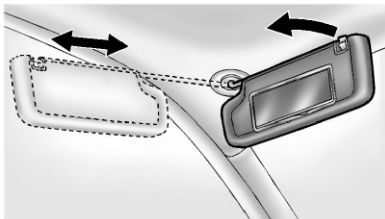

Pull the sun visor down to block glare. Detach the sun visor from the center mount to pivot to the side window and, if equipped, extend along the rod.

## Roof

### Sunroof

If equipped, the ignition must be on or in accessory mode, or Retained Accessory Power (RAP) must be active to operate the sunroof. See *Ignition Positions* ⇨ 192 and *Retained Accessory Power (RAP)* ⇨ 197.



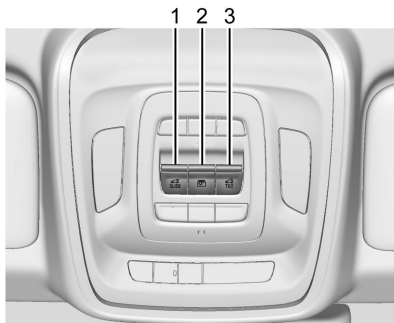

While operating in express, movement can be stopped by pressing the switch again.

The sunroof cannot be opened or closed if the vehicle has an electrical failure.





1. SLIDE Switch
2. TILT Switch

### Sunroof Operation:

- Press and release  (1) to express-open to the fully open position.
- Pull and release  (1) to express-close.
- Press or pull and hold  (1) to open or close without express. Release  (1) at the desired position.

### Sunroof Vent Operation:

- Press and release  (2) to vent the sunroof.
- Pull and release  (2) to close the sunroof vent.

This sunroof also has a sunshade, which must be opened and closed manually.

### Automatic Reversal System

The sunroof, if equipped, has an automatic reversal system that is only active when the sunroof is operated in express-close mode.

If an object is in the path while express-closing, the reversal system will detect an object, stop, and open the sunroof slightly.

If this condition occurs, attempt to remove the object, then pull and release the switch to express close. If the reversal occurs multiple

times, the DIC message OPEN THEN CLOSE SUNROOF will display, and express is disabled. To operate sunroof while express is disabled, the switch must be either pressed or pulled and held.

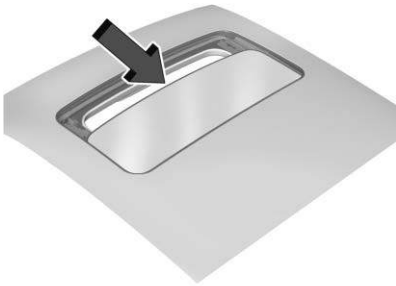

Dirt and debris may collect on the sunroof seal or in the track. This could cause an issue with sunroof operation or noise. It could also plug the water drainage system. Periodically open the sunroof and remove any obstacles or loose debris. Wipe the sunroof seal and roof sealing area using a clean cloth, mild soap, and water. Do not remove grease from the sunroof.

## Seats and Restraints

### Head Restraints

Head Restraints .....	34
-----------------------	----

### Front Seats

Power Seat Adjustment .....	36
Thigh Support Adjustment .....	37
Reclining Seatbacks .....	37
Lumbar Adjustment .....	38
Massage .....	39
Memory Seats .....	39
Heated and Ventilated Front Seats .....	42

### Rear Seats

Rear Seats .....	43
------------------	----

### Seat Belts

Seat Belts .....	45
Buckle To Drive .....	46
How to Wear Seat Belts Properly .....	46
Lap-Shoulder Belt .....	48
Seat Belt Use During Pregnancy .....	51
Seat Belt Extender .....	51
Safety System Check .....	52
Seat Belt Care .....	52
Replacing Seat Belt System Parts after a Crash .....	52

### Airbag System

Airbag System .....	53
---------------------	----

Where Are the Airbags? .....	54
When Should an Airbag Inflate? .....	56
What Makes an Airbag Inflate? .....	57
How Does an Airbag Restrain? .....	57
What Will You See after an Airbag Inflates? .....	57
Passenger Sensing System .....	58
Servicing the Airbag-Equipped Vehicle .....	61
Adding Equipment to the Airbag- Equipped Vehicle .....	62
Airbag System Check .....	62
Replacing Airbag System Parts after a Crash .....	63

### Child Restraints

Older Children .....	63
Infants and Young Children .....	65
Child Restraint Systems .....	67
Where to Put the Restraint .....	69
Lower Anchors and Tethers for Children (LATCH System) .....	70
Replacing LATCH System Parts After a Crash .....	76
Securing Child Restraints (With the Seat Belt in the Rear Seat) .....	76
Securing Child Restraints (With the Seat Belt in the Front Seat) .....	78

## Head Restraints

If equipped with base seats, the vehicle's front seats have adjustable head restraints in the outboard seating positions.

If equipped with high performance seats, the vehicle's front seats have head restraints in the outboard seating positions that cannot be adjusted.



### Warning

With head restraints that are not installed and adjusted properly, there is a greater chance that occupants will suffer a neck/spinal injury in a crash. Do not drive until the head restraints for all occupants are installed and adjusted properly.



If equipped with base seats, adjust the head restraint so that the top of the restraint is at the same height as the top of the occupant's head. This position reduces the chance of a neck injury in a crash.

### Front Seats

The vehicle's front seats have adjustable head restraints in the outboard seating positions.

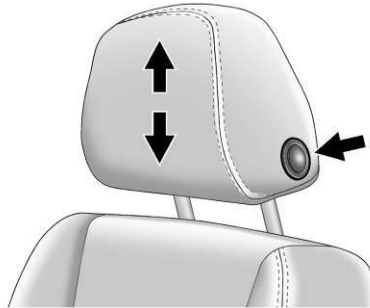

The height of the head restraint can be adjusted.

To raise or lower the head restraint, press the button located on the side of the head restraint, and pull up or push the head restraint down and release the button. Pull and push on the head restraint after the button is released to make sure that it is locked in place.

The front seat outboard head restraints are not removable.

### Rear Seats

The vehicle's rear seats have adjustable head restraints in the outboard seating positions.

The height of the head restraint can be adjusted. Pull the head restraint up to raise it. Try to move the head restraint to make sure that it is locked in place.

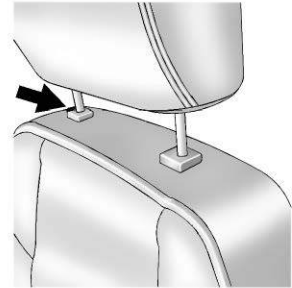

To lower the head restraint, press the button, located on the top of the seatback, and push the head restraint down. Try to move the head restraint after the button is released to make sure that it is locked in place.

The rear seat outboard head restraints are not intended to be removed. If removal is required see your dealer for assistance with removal.

## Front Seats

### Power Seat Adjustment

#### Warning

You can lose control of the vehicle if you try to adjust a driver seat while the vehicle is moving. Adjust the driver seat only when the vehicle is not moving.

#### Warning

The power seats will work with the ignition off. Children could operate the power seats and be injured. Never leave children alone in the vehicle.

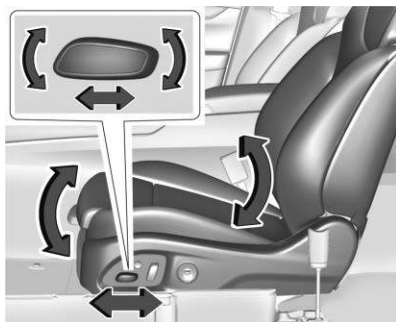

To adjust the seat:

- Move the seat forward or rearward by sliding the control forward or rearward.
- Raise or lower the seat by moving the rear of the control up or down.
- If equipped, raise or lower the front part of the seat cushion by moving the front of the control up or down.

For vehicles not equipped with front cushion tilt, the front part of the control will raise and lower the seat.

If the vehicle is not in P (Park), seat travel may be limited. Release and press the seat switch again to continue movement.

To adjust the seatback, see *Reclining Seatbacks* ⇨ 37.

To adjust the lumbar support, see *Lumbar Adjustment* ⇨ 38.

Some vehicles are equipped with a Safety Alert Seat. This feature activates a vibrating pulse alert in the driver seat to help the driver avoid crashes.

#### Obstructions

If something has blocked the seat during movement, the movement may stop. Remove the obstruction and try the adjustment again. If movement is still not available, see your dealer.

## Thigh Support Adjustment

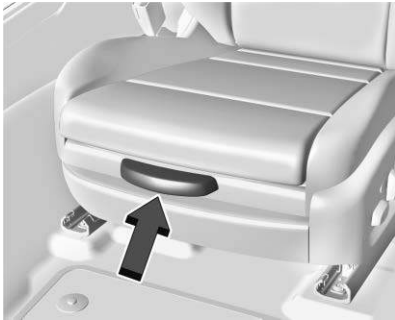

If equipped, pull up on the lever. Then pull or push on the support to lengthen or shorten. Release the lever to lock in place.

## Reclining Seatbacks

### Warning

Sitting in a reclined position when the vehicle is in motion can be dangerous. Even when buckled up, the seat belts cannot do their job.

(Continued)

### Warning (Continued)

The shoulder belt will not be against your body. Instead, it will be in front of you. In a crash, you could go into it, receiving neck or other injuries.

The lap belt could go up over your abdomen. The belt forces would be there, not at your pelvic bones. This could cause serious internal injuries.

For proper protection when the vehicle is in motion, have the seatback upright. Then sit well back in the seat and wear the seat belt properly.



Do not have a seatback reclined if the vehicle is moving.



To adjust the seatback:

- Tilt the top of the control rearward to recline.
- Tilt the top of the control forward to raise.

## Lumbar Adjustment

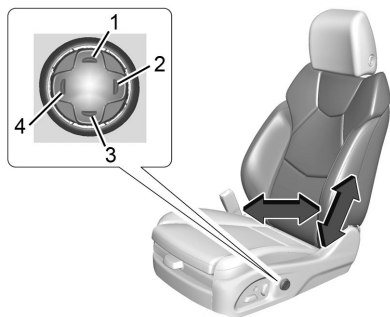

- To adjust lumbar support, if equipped:
  - If equipped, press Up (1) to move lumbar support upward.
  - Press Rearward (2) to move lumbar support rearward.
  - If equipped, press Down (3) to move lumbar support down.
  - Press Forward (4) to move lumbar support forward.

## Uplevel Lumbar Adjustment

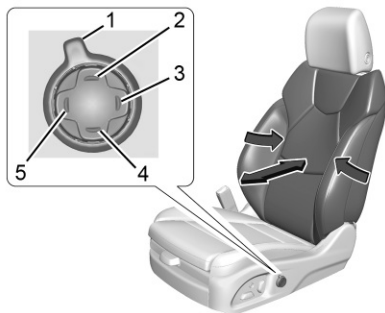

To adjust uplevel lumbar support, if equipped:

- Press and release or hold Feature Select (1) to scroll to lumbar support on the infotainment display.
- Press Forward (5) or Rearward (3) to adjust lumbar forward or rearward.
- Press Up (2) or Down (4) to adjust lumbar up or down.

## Bolster Support Adjustment

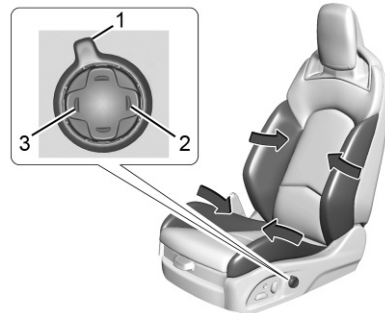

**High Performance Seat Shown, Others Similar**

### Back Bolster Support

To adjust back bolster support, if equipped: Press and release or hold Feature Select (1) to scroll to bolster support on the infotainment display. Press Forward (3) or Rearward (2) to adjust back bolster support inward or outward.

### Cushion Bolster Support

To adjust cushion bolster support, if equipped:

Press and release or hold Feature Select (1) to scroll to bolster support on the infotainment display. Press Forward (3) or Rearward (2) to adjust cushion bolster support inward or outward.

## Massage

Driver Seat Shown, Passenger Seat Similar

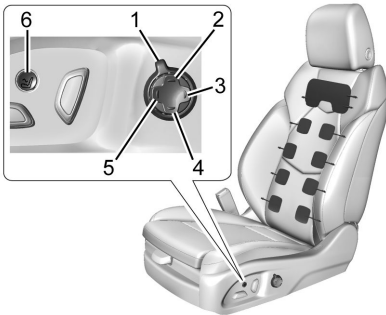

If equipped, the vehicle must be on to use the massage feature.

To activate and adjust massage:

- Turn the Feature Select (1) to scroll to massage on the infotainment display.

- Press Up (2) or Down (4) to adjust massage type.
- Press Forward (5) or Rearward (3) to adjust the intensity.
- To turn massage off or to activate massage at last massage type and intensity settings, press the massage On/Off Control (6).

The massage feature will turn off after approximately 20 minutes. Press the massage On/Off Control (6) to restart the massage feature.

## Memory Seats

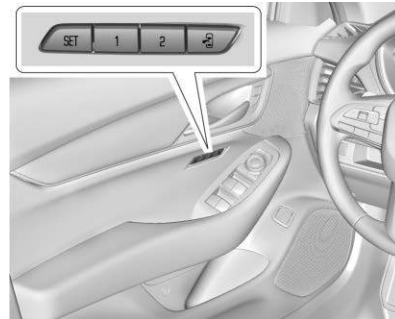

### Overview

If equipped, the memory seat feature allows drivers to save their unique driving positions and a shared exit position. See “Saving Seating Positions” later in this section. The saved positions can be recalled manually by all drivers, see “Manually Recalling Seating Positions” later in this section, and drivers with remote keys 1 and 2 can also recall them automatically. See “Auto Seat Entry Memory Recall” or “Auto Seat Exit Memory Recall” later in this section. To enable automatic recalls, turn on Seat Entry Memory and/or Seat Exit Memory. See “Enabling Automatic Recalls” later in this section. The memory recalls may be cancelled at any time during the recall. See “Cancel Memory Seating Recalls” later in this section.

### Identifying Driver Number

The vehicle identifies the current driver by their remote key number 1–8. The current remote key number may be identified by Driver Information Center (DIC) welcome message, “You are driver x for memory recalls.” This message is displayed the first few times the vehicle is turned on when a different remote key is used. For Seat Entry Memory to work properly, save positions to the 1 or 2 memory



button matching the driver number of this welcome message. To aid in identifying remote key IDs, it is recommended to only carry one remote key when entering the vehicle. Perform the following if the welcome message is not displayed:

1. Move all keys and remote keys away from the vehicle.
2. Start the vehicle with another remote key. A DIC welcome message should display indicating the driver number of the other remote key. Turn the vehicle off and remove the other key or remote key from the vehicle.
3. Start the vehicle with the initial key or remote key. The DIC welcome message should display the driver number of the initial remote key.



### Saving Seating Positions

Read these instructions completely before saving memory positions.

To save preferred driving positions to 1 and 2:

1. Turn the vehicle on or to accessory mode. A DIC welcome message may indicate the driver number of the current remote key. See “Identifying Driver Number” previously in this section.
2. Adjust all available memory features to the desired driving position.
3. Press and release SET; a beep will sound.
4. Immediately upon releasing SET, press and hold memory button 1 or 2 matching the current Driver’s remote key number until two beeps sound. If too much time passes between releasing SET and pressing 1 or 2, the two beeps will not sound indicating memory position were not saved. Repeat Steps 3 and 4 to try again.
5. Repeat Steps 1–4 for the other remote key 1 or 2 using the other 1 or 2 memory button.

It is recommended to save the preferred driving positions to both 1 and 2 if you are the only driver.

To save the common exit seating position to  that is used by all drivers for Manually Recalling Seating Positions and Auto Seat Exit Memory Recall features, repeat Steps 1–4 using , the exit button.

### Manually Recalling Seating Positions

Press and hold 1, 2, or  button until the recall is complete, to recall the positions previously saved to that button.

Manual Memory recall movement for 1, 2 or  buttons may be initiated and will complete to the saved memory position if the vehicle is in or out of P (Park).

If manual transmission equipped, Manual Memory recall movement for 1, 2, or  buttons may be initiated and will complete to the saved memory position if the vehicle parking brake is set or released.

### Enabling Automatic Recalls

- Seat Entry Memory moves the driver seat to the selected 1 or 2 position when the vehicle is started. Select Settings > Vehicle > Seating Position > Seat Entry Memory > ON or OFF. See “Auto Seat Entry Memory Recall” later in this section.

- Seat Exit Memory moves the driver seat to the preferred exit position of the  button when the vehicle is turned off and the door is opened. Select Settings > Vehicle > Seating Position > Seat Exit Memory > Select ON or OFF. See “Auto Seat Exit Memory Recall” later in this section.

### Auto Seat Entry Memory Recall

Seat Entry Memory will automatically begin movement to the seating positions of the 1 or 2 button corresponding to the driver’s remote key number 1 or 2 detected by the vehicle when:

- The vehicle is turned ON.
- Seating positions have been previously saved to the same 1 or 2 button. See “Saving Seating Positions” previously in this section.
- Seat Entry Memory is enabled. See “Enabling Automatic Recalls” previously in this section.
- The shift lever is in P (Park).
- If manual transmission equipped, the parking brake must be set.

Seat Entry Memory Recall will continue if the vehicle is shifted out of P (Park) prior to reaching the saved memory position.

If manual transmission equipped, Seat Entry Memory Recall will continue if the parking brake is released prior to reaching the saved memory position.

If the saved memory seat position does not automatically recall, verify the recall is enabled. See “Enabling Automatic Recalls” previously in this section.

If the memory seat recalls to the wrong position, the driver’s remote key number 1 or 2 may not match the memory button number positions they were saved to. Try the other remote key or try saving the positions to the other 1 or 2 memory button. See “Saving Seating Positions” previously in this section.

Automatic Seat Entry Memory recalls are only available for driver’s remote key numbers 1 and 2. Remote key 3–8 will not provide Seat Entry Memory recalls.

### Auto Seat Exit Memory Recall

Seat Exit Memory will begin movement to the seating position of the  button when:



- The vehicle is turned off and the driver door is open or opened within a short time.
- A seating position has been previously been saved to the  memory button. See “Saving Seating Positions” previously in this section.
- Seat Exit Memory is enabled. See “Enabling Automatic Recalls” previously in this section.
- The shift lever is in P (Park).
- If manual transmission equipped, the parking brake must be set.

Seat Exit Memory recall will continue if the vehicle is shifted out of P (Park) prior to reaching the saved memory position.

If manual transmission equipped, Seat Exit Memory will continue if the parking brake is released prior to reaching the save memory position.

Seat Exit Memory is not linked to the driver’s remote key. The seating position saved to  is used for all drivers.

### Cancel Memory Seating Recalls

- During any memory recall:  
Press a power seat control  
Press SET memory button
- During Manual memory recall:  
Release 1, 2, or  memory button
- During Auto Seat Entry Memory Recall:  
Turn vehicle off  
Press SET, 1, 2, or  memory buttons
- During Auto Seat Exit Memory Recall:  
Press SET, 1, 2, or  memory buttons

### Obstructions

If something has blocked the seat while recalling a memory position, the recall may stop. Remove the obstruction and try the recall again. If the memory position still does not recall, see your dealer.

## Heated and Ventilated Front Seats

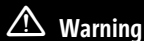





### Warning

If temperature change or pain to the skin cannot be felt, the seat heater may cause burns. To reduce the risk of burns, use care when using the seat heater, especially for long periods of time. Do not place anything on the seat that insulates against heat, such as a blanket, cushion, cover, or similar item. This may cause the seat heater to overheat. An overheated seat heater may cause a burn or may damage the seat.



If equipped, the buttons are near the climate controls on the center stack. To operate, the engine must be running.

Press  or  to heat the driver or passenger seat cushion and seatback.

Press  or  to ventilate the driver or passenger seat.

Press the button once for the highest setting. With each press of the button, the seat will change to the next lower setting, and then to the off setting. The indicator lights next to the buttons indicate three for the highest setting and one for the lowest. If the front heated seats are on high, the level may automatically be lowered after approximately 30 minutes.

When this feature is off, the heated and ventilated seat symbols on the buttons are white. A ventilated seat has a fan that pulls air through the seat. The air is not cooled. When a heated or ventilated seat is turned on, the symbol turns red.

The passenger seat may take longer to heat up.

### Auto Heated and Ventilated Seats

If the vehicle is equipped with auto heated or ventilated seats, and the engine is running, this feature will automatically activate the heated or ventilated seats at the level required by the vehicle's interior temperature.

The active high, medium, low, or off heated or ventilated seat level will be indicated by the manual heated and ventilated seat buttons on the center stack. Use the manual heated and ventilated seat buttons on the center stack to turn auto heated or ventilated seats off. If the passenger seat is unoccupied, the auto heated or ventilated seats feature will not activate that seat. If equipped with a heated steering wheel, the auto heated steering wheel activation will follow the heated seat auto activation and the heated wheel indicator will follow the state of the steering wheel heat.

To enable or disable auto heated or ventilated seats, select Settings > Vehicle > Climate and Air Quality > Cooled/Ventilated Seats on Startup > ON or OFF.

### Remote Start Heated and Ventilated Seats

If equipped, the heated seats will turn on automatically during a remote start if it is cold outside and the ventilated seats will

turn on automatically if it is hot outside. If equipped, the heated steering wheel will turn on automatically during a remote start if it is cold outside. The heated and ventilated seat indicators and heated steering wheel indicator may come on during this operation.

The heated and ventilated seats and heated steering wheel may cancel when the vehicle is started. These features can be manually selected after the ignition is turned on.

The temperature performance of an unoccupied seat may be reduced. This is normal.

To enable or disable remote start heated or ventilated seats, select Settings > Vehicle > Remote Lock, Unlock, and Start > Remote Start Auto Heated or Cooled/Ventilated Seats > ON or OFF. See *Remote Start* ⇨ 12.

## Rear Seats

### Rear Seat Reminder

If equipped, the message REAR SEAT REMINDER LOOK IN REAR SEAT displays under certain conditions indicating there may be an item or passenger in the rear seat. Check before exiting the vehicle.

This feature will activate when a second row door is opened while the vehicle is on or up to 10 minutes before the vehicle is turned on. There will be an alert when the vehicle is turned off. The alert does not directly detect objects in the rear seat; instead, under certain conditions, it detects when a rear door is opened and closed, indicating that there may be something in the rear seat.

The feature is active only once each time the vehicle is turned on and off, and will require reactivation by opening and closing the second row doors. There may be an alert even when there is nothing in the rear seat; for example, if a child entered the vehicle through the rear door and left the vehicle without the vehicle being shut off.

The feature can be turned on or off. Select Settings > Vehicle > Rear Seat Reminder > ON or OFF.

### Folding the Seatback

Either side of the seatback can be folded for more cargo space. Fold a seatback only when the vehicle is not moving.

### Warning

Folding a rear seat with the seat belts still fastened may cause damage to the seat or the seat belts. Always unbuckle the seat belts and return them to their normal stowed position before folding a rear seat.

To fold the seatback:

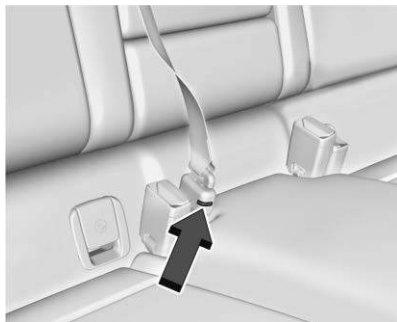

1. Disconnect the rear seat belt mini-latch using a key in the slot on the mini-buckle, and let the belt retract.

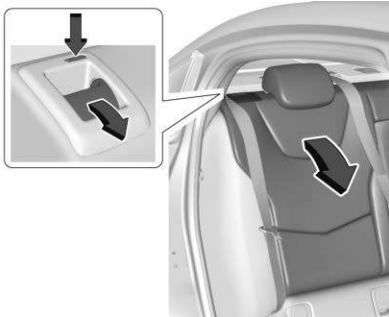

2. Pull the lever on top of the seatback toward you to unlock the seatback.  
A red tab near the seatback lever raises when the seatback is unlocked.
3. Fold the seatback forward.  
Repeat Steps 2 and 3 to fold the other seatback, if desired.

### Raising the Seatback

#### Warning

If either seatback is not locked, it could move forward in a sudden stop or crash. That could cause injury to the person sitting there. Always push and pull on the seatbacks to be sure they are locked.

#### Warning

A seat belt that is improperly routed, not properly attached, or twisted will not provide the protection needed in a crash. The person wearing the belt could be seriously injured. After raising the rear seatback, always check to be sure that the seat belts are properly routed and attached, and are not twisted.

To raise a seatback:

1. Lift the seatback up. Make sure the center seat belt and latch do not get trapped behind the seat. Push the seatback rearward to lock it in place.

A red tab near the seatback lever retracts when the seatback is locked in place.

2. Push and pull the top of the seatback to be sure it is locked into position.
3. Reconnect the center seat belt mini-latch to the mini-buckle. Do not let the belt twist.
4. Pull on the center seat belt to make sure the mini-latch is secure.
5. Repeat the steps to raise the other seatback, if necessary.

When the seat is not in use, it should be kept in the upright, locked position.

## Seat Belts

This section describes how to use seat belts properly, and some things not to do.

### Warning

Do not let anyone ride where a seat belt cannot be worn properly. In a crash, if you or your passenger(s) are not wearing seat belts, injuries can be much worse than if you are wearing seat belts. You can be seriously

(Continued)

### Warning (Continued)

injured or killed by hitting things inside the vehicle harder or by being ejected from the vehicle. In addition, anyone who is not buckled up can strike other passengers in the vehicle.

It is extremely dangerous to ride in a cargo area, inside or outside of a vehicle. In a collision, passengers riding in these areas are more likely to be seriously injured or killed. Do not allow passengers to ride in any area of the vehicle that is not equipped with seats and seat belts.

Always wear a seat belt, and check that all passenger(s) are restrained properly too.

This vehicle has indicators as a reminder to buckle the seat belts. See *Seat Belt Reminders* ⇨ 99.

## Why Seat Belts Work

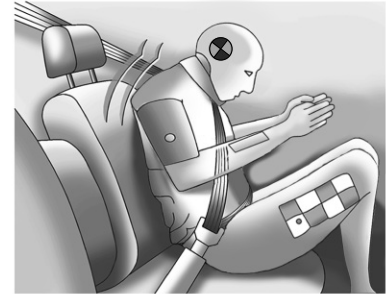

When riding in a vehicle, you travel as fast as the vehicle does. If the vehicle stops suddenly, you keep going until something stops you. It could be the windshield, the instrument panel, or the seat belts!

When you wear a seat belt, you and the vehicle slow down together. There is more time to stop because you stop over a longer distance, and when worn properly, your strongest bones take the forces from the seat belts. That is why wearing seat belts makes such good sense.

### Questions and Answers About Seat Belts

- Q:** Will I be trapped in the vehicle after a crash if I am wearing a seat belt?
- A:** You *could* be — whether you are wearing a seat belt or not. Your chance of being conscious during and after a crash, so you *can* unbuckle and get out, is *much* greater if you are belted.
- Q:** If my vehicle has airbags, why should I have to wear seat belts?
- A:** Airbags are supplemental systems only. They work *with* seat belts — not instead of them. Whether or not an airbag is provided, all occupants still have to buckle up to get the most protection.
- Also, in nearly all states and in all Canadian provinces, the law requires wearing seat belts.

### Buckle To Drive

If equipped, this feature delays the vehicle from shifting out of P (Park) when the driver seat belt is not buckled. The Buckle to Drive feature must be turned ON in the infotainment system to

work. To turn the Buckle to Drive feature on or off, select Settings > Vehicle > Buckle to Drive. See *Teen Driver* ⇨ 161, if equipped.

If the vehicle is on and the brake pedal is pressed with the vehicle in P (Park) but the driver seat belt is not buckled, a message displays in the Driver Information Center (DIC) and the vehicle will be delayed from shifting out of P (Park). Buckle the driver seat belt to clear the message and shift out of P (Park). Shifting from P (Park) will be delayed once for each time the vehicle is started.

For some fleet vehicles, the feature is always ON and cannot be turned OFF in the infotainment system. The vehicle will be delayed from shifting from P (Park) each time the driver attempts to do so while the driver seat belt is not buckled. Turning the vehicle off then on will not change this condition.

On some models, Buckle to Drive may also delay shifting out of P (Park) if a front passenger seat belt is unbuckled. A message displays in the DIC. Buckle the front passenger seat belt to shift out of P (Park). This feature may delay the vehicle from shifting out of P (Park) if an object, such as a briefcase, handbag, grocery bag, laptop, or other electronic device,

is on the front passenger seat. If this happens, remove the object from the seat or buckle the seat belt to shift out of P (Park).

If the driver, or on some vehicles, the present front passenger remains unbuckled, the DIC message will turn off after several seconds and the vehicle can be shifted out of P (Park). See “Seat Belts” and “Child Restraints” in the Index for information about the importance of proper restraint use.

If the driver seat belt or the front passenger seat belt is unbuckled when driving, the seat belt reminder chime and light(s) will come on. See *Seat Belt Reminders* ⇨ 99. This feature may not function properly if the airbag readiness light is on. See *Airbag Readiness Light* ⇨ 100.

### How to Wear Seat Belts Properly

Follow these rules for everyone’s protection.

There are additional things to know about seat belts and children, including smaller children and infants. If a child will be riding in the vehicle, see *Older Children* ⇨ 63 or *Infants and Young Children* ⇨ 65. Review and follow the rules for children in addition to the following rules.

It is very important for all occupants to buckle up. Statistics show that unbelted people are hurt more often in crashes than those who are wearing seat belts.

There are important things to know about wearing a seat belt properly.

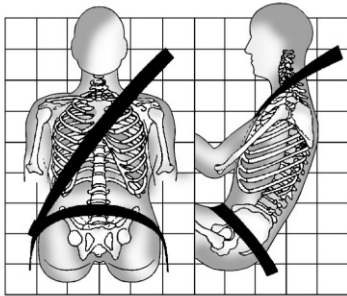

- Sit up straight and always keep your feet on the floor in front of you (if possible).
- Wear the lap part of the belt low and snug on the hips, just touching the thighs. In a crash, this applies force to the strong pelvic bones and you would be less likely to slide under the lap belt. If you slid under it, the belt would apply force on your abdomen. This could cause serious or even fatal injuries.

- Wear the shoulder belt over the shoulder and across the chest. These parts of the body are best able to take belt restraining forces. The shoulder belt locks if there is a sudden stop or crash.

**Warning**

You can be seriously injured, or even killed, by not wearing your seat belt properly.

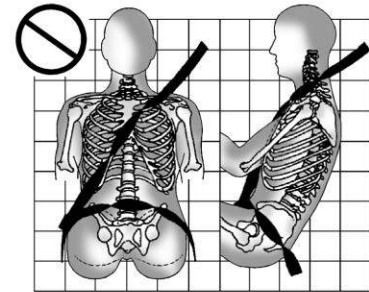
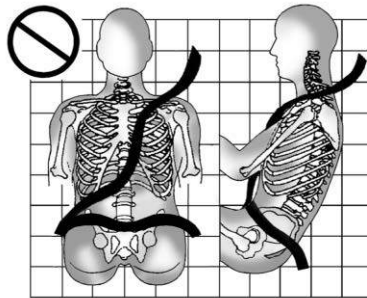

Never allow the lap or shoulder belt to become loose or twisted.

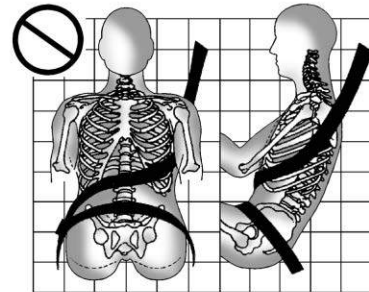



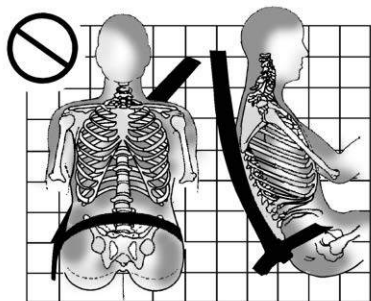

Never wear the shoulder belt under both arms or behind your back.

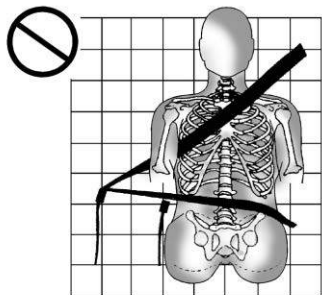

Always use the correct buckle for your seating position.

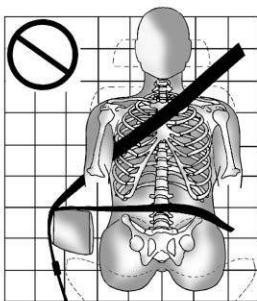

Never route the lap or shoulder belt over an armrest.

### Warning

The seat belt can be pinched if it is routed under plastic trim on the seat, such as trim around the rear seatback folding handle or side airbag. In a crash, pinched seat belts might not provide adequate protection. Never allow seat belts to be routed under plastic trim pieces.

### Warning

You can be seriously injured or killed if the shoulder belt is worn behind your back, under your legs, or wrapped around your neck. The shoulder belt can tighten but cannot be loosened if it is locked. The shoulder belt locks when it is pulled all the way out of the retractor. It unlocks when the shoulder belt is allowed to go all the way back into the retractor, but it cannot do this if it is wrapped around you. You may have to cut the seat belt if it is locked and tightened around you.

### Lap-Shoulder Belt

All seating positions in the vehicle have a lap-shoulder belt.

If you are using a rear seating position with a detachable seat belt and the seat belt is not attached, see *Rear Seats* ⇨ 43 for instructions on reconnecting the seat belt to the mini-buckle.

The following instructions explain how to wear a lap-shoulder belt properly.

1. If the seat has a seat belt guide, the seat belt must be routed through the guide to properly position the shoulder belt. If the seat belt is not routed through the guide, slide the edge of the belt webbing through the opening on the guide. Be sure the belt is not twisted.
2. Adjust the seat, if the seat is adjustable, so you can sit up straight. To see how, see “Seats” in the Index.

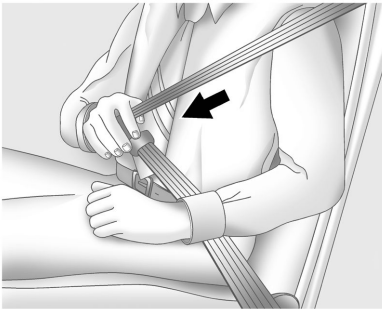

3. Pick up the latch plate and pull the belt across you. Do not let it get twisted.

The lap-shoulder belt may lock if you pull the belt across you very quickly. If this happens, let the belt go back slightly to unlock it. Then pull the belt across you more slowly.

If the shoulder portion of a passenger belt is pulled out all the way, the child restraint locking feature may be engaged. See *Child Restraint Systems* ⇨ 67. If this occurs, let the belt go back all the way and start again. If the locking feature stays engaged after letting the belt go back to stowed position on the seat, move the seat rearward or recline the seat until the shoulder belt retractor lock releases.

Engaging the child restraint locking feature in the front outboard seating position may affect the passenger sensing system. See *Passenger Sensing System* ⇨ 58.

If the shoulder portion of the driver belt is pulled out all the way, the shoulder belt retractor lock feature may be engaged. If this happens, let the belt go back all the way and start again. If the locking feature stays engaged after letting the belt go back to stowed position on the seat, move the seat rearward or recline the seat until the shoulder belt retractor lock releases.

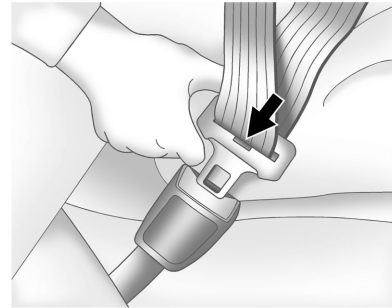

4. Push the latch plate into the buckle until it clicks.  
Pull up on the latch plate to make sure it is secure. If the belt is not long enough, see *Seat Belt Extender* ⇨ 51.  
Position the release pushbutton on the buckle so that the seat belt could be quickly unbuckled if necessary.
5. If equipped with a shoulder belt height adjuster, move it to the height that is right for you. See “Shoulder Belt Height Adjuster” later in this section for instructions on use and important safety information.

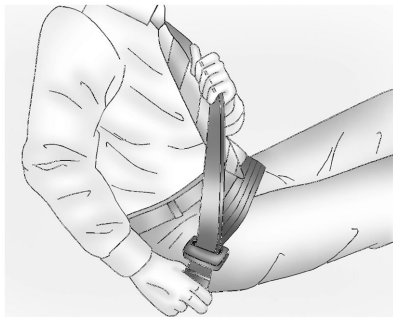

6. To make the lap part tight, pull up on the shoulder belt.

It may be necessary to pull the webbing firmly, through the adjustable stop, or move the adjustable stop along the webbing toward the outboard floor anchor, to fully tighten the lap belt across the lap.

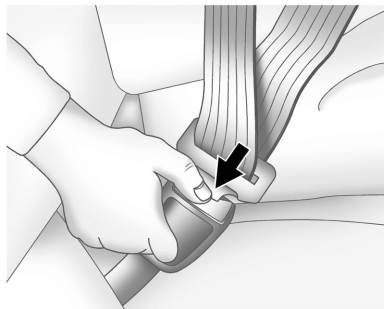

To unlatch the belt, push the release pushbutton on the buckle. The belt should return to its stowed position.

Slide the adjustable stop along the webbing toward the guide loop when the seat belt is not in use to prevent the latch plate from rattling against the interior trim.

Always stow the seat belt slowly. If the seat belt webbing returns quickly to the stowed position, the retractor may lock and cannot be pulled out. If this happens, pull the seat belt straight out firmly to unlock the webbing, and then release it. If the webbing is still locked in the retractor, see your dealer.

Before a door is closed, be sure the seat belt is out of the way. If a door is slammed against a seat belt, damage can occur to both the seat belt and the vehicle.

### Shoulder Belt Height Adjuster

The vehicle has a shoulder belt height adjuster for the driver and front outboard passenger seating positions.

Adjust the height so the shoulder portion of the belt is on the shoulder and not falling off of it. The belt should be close to, but not contacting, the neck. Improper shoulder belt height adjustment could reduce the effectiveness of the seat belt in a crash. See *How to Wear Seat Belts Properly* ⇨ 46.

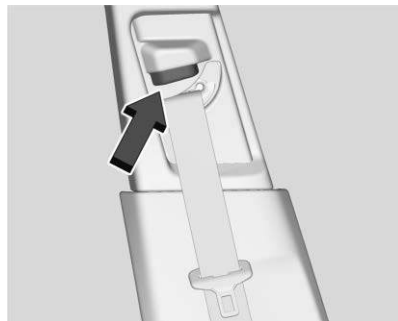

Press the release button and move the height adjuster to the desired position. The adjuster can be moved up by pushing the slide/trim up. After the adjuster is set to the desired position, try to move it down without pressing the release button to make sure it has locked into position.

### Seat Belt Pretensioners

This vehicle has seat belt pretensioners for the front outboard occupants. Although the seat belt pretensioners cannot be seen, they are part of the seat belt assembly. They can help tighten the seat belts during the early stages of a moderate to severe frontal, near frontal, or rear crash if the threshold conditions for pretensioner activation are met. Seat belt pretensioners can also help tighten the seat belts in a side crash or a rollover event.

Pretensioners work only once. If the pretensioners activate in a crash, the pretensioners and probably other parts of the vehicle seat belt system will need to be replaced. See *Replacing Seat Belt System Parts after a Crash* ⇨ 52.

Do not sit on the outboard seat belt while entering or exiting the vehicle or at any time while sitting in the seat. Sitting on the seat belt can damage the webbing and hardware.

### Rear Seat Belt Comfort Guides

Rear seat belt comfort guides may provide added seat belt comfort for older children who have outgrown booster seats and for some adults. When installed on a shoulder belt, the comfort guide positions the shoulder belt away from the neck and head.

Comfort guides are available through your dealer for the rear outboard seating positions. Instructions are included with the guides.

### Seat Belt Use During Pregnancy

Seat belts work for everyone, including pregnant women. Like all occupants, they are more likely to be seriously injured if they do not wear seat belts.



A pregnant woman should wear a lap-shoulder belt, and the lap portion should be worn as low as possible, below the rounding, throughout the pregnancy.

The best way to protect the fetus is to protect the mother. When a seat belt is worn properly, it is more likely that the fetus will not be hurt in a crash. For pregnant women, as for anyone, the key to making seat belts effective is wearing them properly.

### Seat Belt Extender

If the vehicle seat belt will fasten around you, you should use it.

But if a seat belt is not long enough, your dealer will order you an extender. Only a GM issued extender should be used. When you go in to order it, take the heaviest coat you will wear, so the extender will be long enough for you. To help avoid personal injury, do not let someone else use it, and use it only for the seat it is made to fit. The extender has been designed for adults. Never use it for securing child restraints. For more information on the proper use and fit of seat belt extenders see the instruction sheet that comes with the extender.

## Safety System Check

Periodically check the seat belt reminder, seat belts, buckles, latch plates, retractors, shoulder belt height adjusters (if equipped), and seat belt anchorages to make sure they are all in working order. Look for any other loose or damaged seat belt system parts that might keep a seat belt system from performing properly. See your dealer to have it repaired. Torn, frayed, or twisted seat belts may not protect you in a crash. Torn or frayed seat belts can rip apart under impact forces. If a belt is torn or frayed, have it replaced immediately. If a belt is twisted, it may be possible to untwist

by reversing the latch plate on the webbing. If the twist cannot be corrected, ask your dealer to fix it.

Make sure the seat belt reminder light is working. See *Seat Belt Reminders* ⇨ 99.

Keep seat belts clean and dry. See *Seat Belt Care* ⇨ 52.

## Seat Belt Care

Keep belts clean and dry.

Seat belts should be properly cared for and maintained.

Seat Belt hardware should be kept dry and free of dust or debris. As necessary exterior hard surfaces and seat belt webbing may be lightly cleaned with mild soap and water. Ensure there is not excessive dust or debris in the mechanism. If dust or debris exists in the system after proper cleaning please see the dealer. Parts may need to be replaced to ensure proper functionality of the system.



### Warning

Do not bleach or dye seat belt webbing. It may severely weaken the webbing. In a crash, they might not be able to provide adequate protection. Clean and rinse seat belt webbing only with mild soap and lukewarm water. Allow the webbing to dry.

## Replacing Seat Belt System Parts after a Crash



### Warning

A crash can damage the seat belt system in the vehicle. A damaged seat belt system may not properly protect the person using it, resulting in serious injury or even death in a crash. To help make sure the seat belt systems are working properly after a crash, have them inspected and any necessary replacements made as soon as possible.

After a minor crash, replacement of seat belts may not be necessary. But the seat belt assemblies that were used during any crash

may have been stressed or damaged. See your dealer to have the seat belt assemblies inspected or replaced.

New parts and repairs may be necessary even if the seat belt system was not being used at the time of the crash.

Have the seat belt pretensioners checked if the vehicle has been in a crash, or if the airbag readiness light stays on after you start the vehicle or while you are driving. See *Airbag Readiness Light* ⇨ 100.

## Airbag System

The vehicle has the following airbags:

- A frontal airbag for the driver
- A frontal airbag for the front outboard passenger
- A knee airbag for the driver.
- A knee airbag for the front outboard passenger.
- A seat-mounted side impact airbag for the driver
- A seat-mounted side impact airbag for the front outboard passenger

- A roof-rail airbag for the driver and the passenger seated directly behind the driver
- A roof-rail airbag for the front outboard passenger and the passenger seated directly behind the front outboard passenger

All vehicle airbags have the word AIRBAG on the trim or on a label near the deployment opening.

For frontal airbags, the word AIRBAG is on the center of the steering wheel for the driver and on the instrument panel for the front outboard passenger.

For knee airbags, the word AIRBAG is on the lower part of the instrument panel.

For seat-mounted side impact airbags, the word AIRBAG is on the side of the seatback or side of the seat closest to the door.

For roof-rail airbags, the word AIRBAG is on the ceiling or trim.

Airbags are designed to supplement the protection provided by seat belts. Even though today's airbags are also designed to help reduce the risk of injury from the force of an inflating bag, all airbags must inflate very quickly to do their job.

Here are the most important things to know about the airbag system:

### Warning

You can be severely injured or killed in a crash if you are not wearing your seat belt, even with airbags. Airbags are designed to work with seat belts, not replace them. Also, airbags are not designed to inflate in every crash. In some crashes seat belts are the only restraint. See *When Should an Airbag Inflate?* ⇨ 56.

Wearing your seat belt during a crash helps reduce your chance of hitting things inside the vehicle or being ejected from it. Airbags are “supplemental restraints” to the seat belts. Everyone in the vehicle should wear a seat belt properly, whether or not there is an airbag for that person.

### Warning

Because airbags inflate with great force and faster than the blink of an eye, anyone who is up against, or very close to, any airbag

(Continued)

**Warning (Continued)**

when it inflates can be seriously injured or killed. Do not sit unnecessarily close to any airbag, as you would be if sitting on the edge of the seat or leaning forward. Seat belts help keep you in position before and during a crash. Always wear a seat belt, even with airbags. The driver should sit as far back as possible while still maintaining control of the vehicle. The seat belts and the front outboard passenger airbags are most effective when you are sitting well back and upright in the seat with both feet on the floor.

Occupants should not lean on or sleep against the door or side windows in seating positions with seat-mounted side impact airbags and/or roof-rail airbags.

**Warning**

Children who are up against, or very close to, any airbag when it inflates can be seriously injured or killed. Always secure

(Continued)

**Warning (Continued)**

children properly in the vehicle. To read how, see *Older Children* ⇨ 63 or *Infants and Young Children* ⇨ 65.



There is an airbag readiness light on the instrument cluster, which shows the airbag symbol.

The system checks the airbag electrical system for malfunctions. The light tells you if there is an electrical problem. See *Airbag Readiness Light* ⇨ 100.

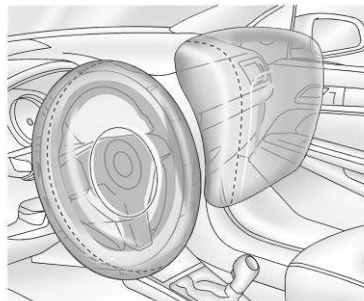
**Where Are the Airbags?**

The driver frontal airbag is in the center of the steering wheel.

The front outboard passenger frontal airbag is in the passenger side instrument panel.

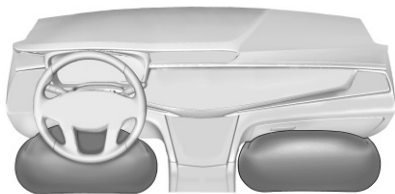

The driver knee airbag is below the steering column. The front outboard passenger knee airbag is below the glove box.



#### Driver Side Shown, Passenger Side Similar

The driver and front outboard passenger seat-mounted side impact airbags are in the side of the seatbacks closest to the door.



#### Driver Side Shown, Passenger Side Similar

The roof-rail airbags for the driver, front outboard passenger, and second row outboard passengers are in the ceiling above the side windows.

#### Warning

If something is between an occupant and an airbag, the airbag might not inflate properly or it might force the object into that person causing severe injury or even death. The path of an inflating airbag must be kept clear. Do not put anything

(Continued)



**Warning (Continued)**

between an occupant and an airbag, and do not attach or put anything on the steering wheel hub or on or near any other airbag covering.

Do not use seat accessories that block the inflation path of a seat-mounted side impact airbag.

Never secure anything to the roof of a vehicle with roof-rail airbags by routing a rope or tie-down through any door or window opening. If you do, the path of an inflating roof-rail airbag will be blocked.

**When Should an Airbag Inflate?**

This vehicle is equipped with airbags. See *Airbag System* ⇨ 53. Airbags are designed to inflate if the impact exceeds the specific airbag system's deployment threshold. Deployment thresholds are used to predict how severe a crash is likely to be in time for the airbags to inflate and help restrain the occupants. The vehicle has electronic sensors that help the airbag system determine the severity of the impact. Deployment thresholds can vary with specific vehicle design.

Frontal airbags are designed to inflate in moderate to severe frontal crashes to help reduce the potential for severe injuries, mainly to the driver's or front outboard passenger's head and chest.

Whether the frontal airbags will or should inflate is not based primarily on how fast the vehicle is traveling. It depends on what is hit, the direction of the impact, and how quickly the vehicle slows down.

Frontal airbags may inflate at different crash speeds depending on whether the vehicle hits an object straight on or at an angle, and whether the object is fixed or moving, rigid or deformable, narrow or wide.

Frontal airbags are not intended to inflate during vehicle rollovers, in rear impacts, or in many side impacts.

In addition, the vehicle has advanced technology frontal airbags. Advanced technology frontal airbags adjust the restraint according to either crash severity or occupant interaction.

Knee airbags are designed to inflate in moderate to severe frontal impacts. Knee airbags are not designed to inflate during vehicle rollovers, in rear impacts, or in many side impacts.

Seat-mounted side impact airbags are designed to inflate in moderate to severe side crashes depending on the location of the impact. These airbags may also inflate in some moderate to severe frontal impacts. Seat-mounted side impact airbags are not designed to inflate in rollovers or rear impacts. A seat-mounted side impact airbag is designed to inflate on the side of the vehicle that is struck.

Roof-rail airbags are designed to inflate in moderate to severe side crashes depending on the location of the impact. In addition, these roof-rail airbags may inflate during a rollover or in a severe frontal impact. Roof-rail airbags are not designed to inflate in rear impacts. Both roof-rail airbags may inflate when either side of the vehicle is struck, if the sensing system predicts that the vehicle is about to roll over on its side, or in a severe frontal impact.

In any particular crash, no one can say whether an airbag should have inflated simply because of the vehicle damage or repair costs.

## What Makes an Airbag Inflate?

In a deployment event, the sensing system sends an electrical signal triggering a release of gas from the inflator. Gas from the inflator fills the airbag causing the bag to break out of the cover. The inflator, the airbag, and related hardware are all part of the airbag module.

For airbag locations, see *Where Are the Airbags?* ⇨ 54.

## How Does an Airbag Restrain?

In moderate to severe frontal collisions, even belted occupants can contact the steering wheel or the instrument panel. In moderate to severe side collisions, even belted occupants can contact the inside of the vehicle.

Airbags supplement the protection provided by seat belts by distributing the force of the impact more evenly over the occupant's body.

Rollover capable roof-rail airbags are designed to help contain the head and chest of occupants in the outboard seating positions in the first and second rows. The rollover capable roof-rail airbags are designed to help reduce the risk of full or partial ejection in rollover events, although no system can prevent all such ejections.

But airbags would not help in many types of collisions, primarily because the occupant's motion is not toward those airbags. See *When Should an Airbag Inflate?* ⇨ 56.

Airbags should never be regarded as anything more than a supplement to seat belts.

## What Will You See after an Airbag Inflates?

After frontal, knee, and seat-mounted side impact airbags inflate, they quickly deflate, so quickly that some people may not even realize the airbags inflated. Roof-rail airbags may still be at least partially inflated for some time after they inflate. Some components of the airbag module may be hot for several minutes. For location of the airbags, see *Where Are the Airbags?* ⇨ 54.

The parts of the airbag that come into contact with you may be warm, but not too hot to touch. There may be some smoke and dust coming from the vents in the deflated airbags. Airbag inflation does not prevent people from leaving the vehicle.

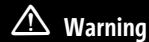

### Warning

When an airbag inflates, there may be dust in the air. This dust could cause breathing problems for people with a history of asthma or other breathing trouble. To avoid this, everyone in the vehicle should get out as soon as it is safe to do so. If you have breathing problems but cannot get out of the vehicle after an airbag inflates, then get fresh air by opening a window or a door. If you experience breathing problems following an airbag deployment, you should seek medical attention.

The vehicle has a feature that may automatically unlock the doors, turn on the interior lamps and hazard warning flashers, and shut off the fuel system after the airbags inflate. The feature may also activate, without airbag inflation, after an event that exceeds a predetermined threshold. After turning the vehicle off and then on again, the fuel system will return to normal operation; the doors can be locked, the interior lamps can be turned off, and the hazard warning flashers can be turned

off using the controls for those features. If any of these systems are damaged in the crash they may not operate as normal.

### Warning

A crash severe enough to inflate the airbags may have also damaged important functions in the vehicle, such as the fuel system, brake and steering systems, etc. Even if the vehicle appears to be drivable after a moderate crash, there may be concealed damage that could make it difficult to safely operate the vehicle.

Use caution if you should attempt to restart the engine after a crash has occurred.

In many crashes severe enough to inflate the airbag, windshields are broken by vehicle deformation. Additional windshield breakage may also occur from the front outboard passenger airbag.

- Airbags are designed to inflate only once. After an airbag inflates, you will need some new parts for the airbag system. If you do not get them, the airbag system will not be there to help protect you in another crash. A new system will include airbag modules and possibly other parts. The service manual for the vehicle covers the need to replace other parts.
- The vehicle has a crash sensing and diagnostic module which records information after a crash. See *Vehicle Data Recording and Privacy* ⇨ 388 and *Event Data Recorders* ⇨ 389.
- Let only qualified technicians work on the airbag system. Improper service can mean that an airbag system will not work properly. See your dealer for service.

## Passenger Sensing System

The vehicle has a passenger sensing system for the front outboard passenger position. The passenger airbag status indicator will light on the overhead console when the vehicle is started.

## PASS AIR BAG



The words ON and OFF, and the symbols for on and off, will be visible during the system check. When the system check is complete, either the word ON or OFF, and the symbol for on or off, will be visible. See *Passenger Airbag Status Indicator* ⇨ 100.

The passenger sensing system turns off the front outboard passenger frontal airbag and knee airbag under certain conditions. No other airbag is affected by the passenger sensing system.

The passenger sensing system works with sensors that are part of the front outboard passenger seat and seat belt. The sensors are designed to detect the presence of a properly seated occupant and determine if the front outboard passenger frontal airbag and knee airbag should be allowed to inflate or not.

According to accident statistics, children are safer when properly secured in a rear seat in the correct child restraint for their weight and size.

Whenever possible, children aged 12 and under should be secured in a rear seating position.

Never put a rear-facing child seat in the front. This is because the risk to the rear-facing child is so great, if the airbag inflates.



### Warning

A child in a rear-facing child restraint can be seriously injured or killed if the passenger frontal airbag inflates. This is because the back of the rear-facing child restraint would be very close to the inflating airbag. A child in a forward-facing child restraint can be seriously injured or killed if the passenger frontal airbag inflates and the passenger seat is in a forward position.

Even if the passenger sensing system has turned off the front outboard passenger airbag(s), no system is fail-safe. No one can guarantee that an airbag will not deploy under some unusual circumstance, even though the airbag(s) are off.

Never put a rear-facing child restraint in the front seat, even if the airbag is off. If securing a forward-facing child restraint in

(Continued)

### Warning (Continued)

the front outboard passenger seat, always move the seat as far back as it will go. It is better to secure child restraints in the rear seat. Consider using another vehicle to transport the child when a rear seat is not available.

The passenger sensing system is designed to turn off the front outboard passenger frontal airbag and knee airbag if:

- The front outboard passenger seat is unoccupied.
- The system determines an infant is present in a child restraint.
- A front outboard passenger takes his/her weight off of the seat for a period of time.

When the passenger sensing system has turned off the front outboard passenger frontal airbag and knee airbag, the OFF indicator will light and stay lit as a reminder that the airbags are off. See *Passenger Airbag Status Indicator* ⇨ 100.

The passenger sensing system is designed to turn on the front outboard passenger frontal airbag and knee airbag, anytime the system senses that a person of adult size is sitting properly in the front outboard passenger seat.

When the passenger sensing system has allowed the airbag to be enabled, the ON indicator will light and stay lit as a reminder that the airbags are active.

For some children, including children in child restraints, and for very small adults, the passenger sensing system may or may not turn off the front outboard passenger frontal airbag and knee airbag, depending upon the person's seating posture and body build. Everyone in the vehicle who has outgrown child restraints should wear a seat belt properly — whether or not there is an airbag for that person.



### Warning

If the airbag readiness light ever comes on and stays on, it means that something may be wrong with the airbag system. To help avoid injury to yourself or others, have the vehicle serviced right away. See *Airbag Readiness Light* ⇨ 100 for more information, including important safety information.

### If the On Indicator Is Lit for a Child Restraint

The passenger sensing system is designed to turn off the front outboard passenger frontal airbag and knee airbag, if the system determines that an infant is present in a child restraint. If a child restraint has been installed and the ON indicator is lit:

1. Turn the vehicle off.
2. Remove the child restraint from the vehicle.
3. Remove any additional items from the seat such as blankets, cushions, seat covers, seat heaters, or seat massagers.
4. Reinstall the child restraint following the directions provided by the child restraint manufacturer and refer to *Securing Child Restraints (With the Seat Belt in the Rear Seat)* ⇨ 76 *Securing Child Restraints (With the Seat Belt in the Front Seat)* ⇨ 78.

Make sure the seat belt retractor is locked by pulling the shoulder belt all the way out of the retractor when installing the child restraint, even if the child restraint is equipped with a seat belt lock off. When the retractor lock is set, the belt can be tightened but not pulled out of the retractor.

5. If, after reinstalling the child restraint and restarting the vehicle, the ON indicator is still lit, turn the vehicle off. Then slightly recline the vehicle seatback and adjust the seat cushion, if adjustable, to make sure that the vehicle seatback is not pushing the child restraint into the seat cushion.

Also make sure the child restraint is not trapped under the vehicle head restraint. If this happens, adjust the head restraint. See *Head Restraints* ⇨ 34.

6. Restart the vehicle.

The passenger sensing system may or may not turn off the airbags for a child in a child restraint depending upon the child's size. It is better to secure the child restraint in a rear seat. Never put a rear-facing child restraint in the front seat, even if the ON indicator is not lit.

### If the Off Indicator Is Lit for an Adult-Sized Occupant



If a person of adult size is sitting in the front outboard passenger seat, but the OFF indicator is lit, it could be because that person is not sitting properly in the seat or that the child restraint locking feature is engaged. Use the following steps to allow the system to detect that person and enable the front outboard passenger frontal airbag and knee airbag:

1. Turn the vehicle off.
2. Remove any additional material from the seat, such as blankets, cushions, seat covers, seat heaters, or seat massagers.

3. Place the seatback in the fully upright position.
4. Have the person sit upright in the seat, centered on the seat cushion, with legs comfortably extended.
5. If the shoulder portion of the belt is pulled out all the way, the child restraint locking feature will be engaged. This may unintentionally cause the passenger sensing system to turn the airbag off for some adult-sized occupants. If this happens, unbuckle the belt, let the belt go back all the way, and then buckle the belt again without pulling the belt out all the way.
6. Restart the vehicle and have the person remain in this position for two to three minutes after the ON indicator is lit.

 **Warning**

If the front outboard passenger airbag is turned off for an adult-sized occupant, the airbag will not be able to inflate and help protect that person in a crash, resulting in an increased risk of serious injury or even

(Continued)

**Warning (Continued)**

death. An adult-sized occupant should not ride in the front outboard passenger seat, if the passenger airbag OFF indicator is lit.

**Additional Factors Affecting System Operation**

Seat belts help keep the passenger in position on the seat during vehicle maneuvers and braking, which helps the passenger sensing system maintain the passenger airbag status. See “Seat Belts” and “Child Restraints” in the Index for additional information about the importance of proper restraint use.

A thick layer of additional material, such as a blanket or cushion, or aftermarket equipment such as seat covers, seat heaters, and seat massagers can affect how well the passenger sensing system operates. We recommend that you not use seat covers or other aftermarket equipment except when approved by GM for your specific vehicle. See *Adding Equipment to the Airbag-Equipped Vehicle* ⇨ 62 for more information about modifications that can affect how the system operates.

The ON indicator may be lit if an object, such as a briefcase, handbag, grocery bag, laptop, or other electronic device, is put on an unoccupied seat. If this is not desired, remove the object from the seat.

 **Warning**

Stowing articles under the passenger seat or between the passenger seat cushion and seatback may interfere with the proper operation of the passenger sensing system.

**Servicing the Airbag-Equipped Vehicle**

Airbags affect how the vehicle should be serviced. There are parts of the airbag system in several places around the vehicle. Your dealer and the service manual have information about servicing the vehicle and the airbag system. To purchase a service manual, see *Publication Ordering Information* ⇨ 387.

 **Warning**

For up to 10 seconds after the vehicle is turned off and the battery is disconnected, an airbag can still inflate during improper service. You can be injured if you are close to an airbag when it inflates. Avoid yellow connectors. They are probably part of the airbag system. Be sure to follow proper service procedures, and make sure the person performing work for you is qualified to do so.

## Adding Equipment to the Airbag-Equipped Vehicle

Adding accessories that change the vehicle's frame, bumper system, height, front end, or side sheet metal may keep the airbag system from working properly.

The operation of the airbag system can also be affected by changing, including improperly repairing or replacing, any parts of the following:

- Airbag system, including airbag modules, front or side impact sensors, sensing and diagnostic module, or airbag wiring

- Front seats, including stitching, seams or zippers
- Seat belts
- Steering wheel, instrument panel, overhead console, ceiling trim, or pillar garnish trim
- Inner door seals, including speakers

Your dealer and the service manual have information about the location of the airbag modules and sensors, sensing and diagnostic module, and airbag wiring along with the proper replacement procedures.

In addition, the vehicle has a passenger sensing system for the front outboard passenger position, which includes sensors that are part of the passenger seat. The passenger sensing system may not operate properly if the original seat trim is replaced with non-GM covers, upholstery, or trim; or with GM covers, upholstery, or trim designed for a different vehicle. Any object, such as an aftermarket seat heater or a comfort-enhancing pad or device, installed under or on top of the seat fabric, could also interfere with the operation of the passenger sensing system. This could either prevent proper deployment of the passenger airbag(s) or prevent the passenger

sensing system from properly turning off the passenger airbag(s). See *Passenger Sensing System* ⇨ 58.

If the vehicle has rollover roof-rail airbags, see *Different Size Tires and Wheels* ⇨ 340 for additional important information.

If the vehicle must be modified because you have a disability and have questions about whether the modifications will affect the vehicle's airbag system, or if you have questions about whether the airbag system will be affected if the vehicle is modified for any other reason, call Customer Assistance. See *Customer Assistance Offices* ⇨ 381.

## Airbag System Check

The airbag system does not need regularly scheduled maintenance or replacement. Make sure the airbag readiness light is working. See *Airbag Readiness Light* ⇨ 100.

**Caution**

If an airbag covering is damaged, opened, or broken, the airbag may not work properly. Do not open or break the airbag coverings. If there are any opened or broken airbag coverings, have the airbag covering and/or airbag module replaced. For the location of the airbags, see *Where Are the Airbags?* ⇨ 54. See your dealer for service.

## Replacing Airbag System Parts after a Crash

 **Warning**

A crash can damage the airbag systems in the vehicle. A damaged airbag system may not properly protect you and your passenger(s) in a crash, resulting in serious injury or even death. To help make sure the airbag systems are working properly after a crash, have them inspected and any necessary replacements made as soon as possible.

If an airbag inflates, you will need to replace airbag system parts. See your dealer for service.

If the airbag readiness light stays on after the vehicle is started or comes on when you are driving, the airbag system may not work properly. Have the vehicle serviced right away. See *Airbag Readiness Light* ⇨ 100.

## Child Restraints

### Older Children

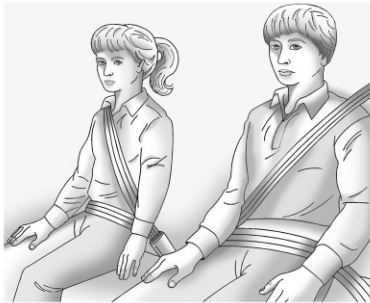

Older children who have outgrown booster seats should wear the vehicle seat belts. See *How to Wear Seat Belts Properly* ⇨ 46.

The manufacturer instructions that come with the booster seat state the weight and height limitations for that booster. Use a booster seat with a lap-shoulder belt until the child passes the fit test below:

- Sit all the way back on the seat. Do the knees bend at the seat edge? If yes, continue. If no, return to the booster seat.
- Buckle the lap-shoulder belt. Does the shoulder belt rest on the shoulder? If yes, continue. If no, try using the rear seat belt comfort guide, if available. See “Rear Seat Belt Comfort Guides” under *Lap-Shoulder Belt* ⇨ 48. If a comfort guide is not available, or if the shoulder belt still does not rest on the shoulder, then return to the booster seat.
- Does the lap belt fit low and snug on the hips, touching the thighs? If yes, continue. If no, return to the booster seat.
- Can proper seat belt fit be maintained for the length of the trip? If yes, continue. If no, return to the booster seat.



**Q:** What is the proper way to wear seat belts?

**A:** An older child should wear a lap-shoulder belt and get the additional restraint a shoulder belt can provide. The shoulder belt should not cross the face or neck. The lap belt should fit snugly below the hips, just touching the top of the thighs. This applies belt force to the child's pelvic bones in a crash. It should never be worn over the abdomen, which could cause severe or even fatal internal injuries in a crash.

Also see "Rear Seat Belt Comfort Guides" under *Lap-Shoulder Belt* ⇨ 48.

According to accident statistics, children are safer when properly restrained in a rear seating position.

In a crash, children who are not buckled up can strike other people who are buckled up, or can be thrown out of the vehicle. Older children need to use seat belts properly.

 **Warning**

Never allow more than one child to wear the same seat belt. The seat belt cannot properly spread the impact forces. In a crash, they can be crushed together and seriously injured. A seat belt must be used by only one person at a time.



 **Warning**

Never allow a child to wear the seat belt shoulder belt under both arms or behind their back. A child can be seriously injured by not wearing the lap-shoulder belt properly. In a crash, the child would not be restrained by the shoulder belt. The child could move too far forward increasing the chance of head and neck injury. The child might also slide under the lap belt. The belt force would then be applied right on the abdomen. That could cause serious or fatal injuries. The shoulder belt should go over the shoulder and across the chest.



 **Warning**

Children can be seriously injured or killed if the shoulder belt is worn behind their back, under their legs, or wrapped around their neck. The shoulder belt can tighten but cannot be loosened if it is locked. The shoulder belt locks when it is pulled all the way out of the retractor. It unlocks when the shoulder belt is allowed to go all the way back into the retractor, but it cannot do this if it is wrapped around the child. Never leave children unattended in a vehicle and never allow children to improperly wear, or play with, the seat belts.

 **Warning**

Children can be seriously injured or killed if the shoulder belt is worn behind their back, under their legs, or wrapped around their neck. The shoulder belt can tighten but cannot be loosened if it is locked. The shoulder belt locks when it is pulled all the way out of the retractor. It unlocks when the shoulder belt is allowed to go all the way back into the retractor, but it cannot do this if it is wrapped around the child. Never leave children unattended in a vehicle and never allow children to improperly wear, or play with, the seat belts.

 **Warning**

Never hold an infant or a child while riding in a vehicle. Due to crash forces, an infant or a child will become so heavy it is not possible to hold it during a crash. For example, in a crash at only 40 km/h (25 mph), a 5.5 kg (12 lb) infant will suddenly become a 110 kg (240 lb) force on a person's arms. An infant or child should be secured in an appropriate child restraint.

## Infants and Young Children

Everyone in a vehicle needs protection! This includes infants and all other children. Neither the distance traveled nor the age and size of the traveler changes the need, for everyone, to use safety restraints. In fact, the law in every state in the United States and in every Canadian province says children up to some age must be restrained while in a vehicle.

Every time infants and young children ride in vehicles, they should have the protection provided by appropriate child restraints. Neither the vehicle seat belt system nor its airbag system is designed for them.

Children who are not restrained properly can strike other people, or can be thrown out of the vehicle.



 **Warning**

Children who are up against, or very close to, any airbag when it inflates can be seriously injured or killed. Never put a rear-facing child restraint in the front outboard seat. Secure a rear-facing child restraint in a rear seat. It is also better to secure a forward-facing child restraint in a rear seat. If you must secure a forward-facing child restraint in the front outboard seat, always move the front passenger seat as far back as it will go.



Child restraints are devices used to restrain, seat, or position children in the vehicle and are sometimes called child seats or car seats.

**There are three basic types of child restraints:**

- Forward-facing child restraints
- Rear-facing child restraints
- Belt-positioning booster seats

The proper child restraint for your child depends on their size, weight, and age, and also on whether the child restraint is compatible with the vehicle in which it will be used.

For each type of child restraint, there are many different models available. When purchasing a child restraint, be sure it is designed to be used in a motor vehicle and is designed by a genuine child restraint manufacturer. If it is, the child restraint will have a label saying that it meets federal motor vehicle safety standards.

The instruction manual that is provided with the child restraint states the weight and height limitations for that particular child restraint. In addition, there are many kinds of child restraints available for children with special needs.

 **Warning**

To reduce the risk of neck and head injury in a crash, infants and toddlers should be secured in a rear-facing child restraint until age two, or until they reach the maximum height and weight limits of their child restraint.

 **Warning**

A young child's hip bones are still so small that the vehicle seat belt may not remain low on the hip bones, as it should. Instead, it may settle up around the child's abdomen. In a crash, the belt would apply force on a body area that is unprotected by any bony structure. This alone could cause serious or fatal injuries. To reduce the risk of serious or fatal injuries during a crash, young children should always be secured in an appropriate child restraint.

## Child Restraint Systems

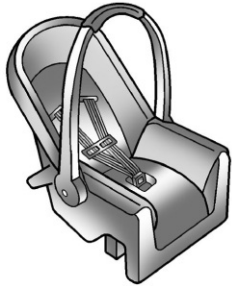

### Rear-Facing Infant Restraint

A rear-facing child restraint provides restraint with the seating surface against the back of the infant.

The harness system holds the infant in place and, in a crash, acts to keep the infant positioned in the restraint.



### Forward-Facing Child Restraint

A forward-facing child restraint provides restraint for the child's body with the harness.

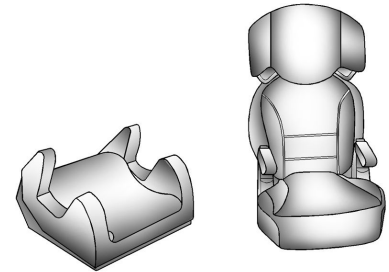

### Booster Seats

A belt-positioning booster seat is used for children who have outgrown their forward-facing child restraint. Boosters are designed to improve the fit of the vehicle seat belt system until the child is large enough for the vehicle seat belts to fit properly without a booster seat. See the seat belt fit test in *Older Children* ⇨ 63.

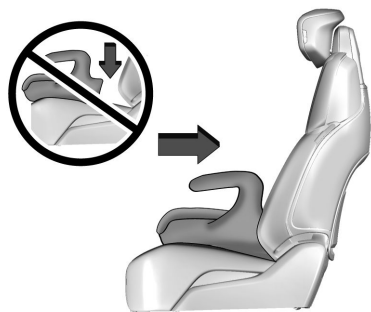

**Backless Booster**

**Backless booster fitment requirement:**

Some backless booster seats are not suitable for rear seats that have oversized side seat bolsters, as they can push the backless booster forward from the seat back.

To use a backless booster:

1. Center the booster on the seat cushion.
2. Ensure the backless booster seat contacts the seat back.

If the backless booster does not meet the fit test described in Steps 1–2, select another booster seat.

### Securing an Add-On Child Restraint in the Vehicle

#### **Warning**

A child can be seriously injured or killed in a crash if the child restraint is not properly secured in the vehicle. Secure the child restraint properly in the vehicle using the vehicle seat belt or LATCH system, following the instructions that came with that child restraint and the instructions in this manual.

To help reduce the chance of injury, the child restraint must be secured in the vehicle. Child restraints must be secured in vehicle seats by the lap belt portion of a lap-shoulder belt, or by the LATCH system. See *Lower Anchors and Tethers for Children (LATCH System)* ⇄ 70 for more information. Never use a seat belt extender when installing a child restraint. Never use non-regulated aftermarket anchors or attachments to secure a child restraint. Children can be endangered in a crash if the child restraint is not properly secured in the vehicle.

When securing an add-on child restraint, see the following:

- Instruction labels provided on the child restraint
- Instruction manual provided with the child restraint
- This vehicle owner's manual

The child restraint instructions are important, so if they are not available, obtain a replacement copy from the manufacturer.

Keep in mind that an unsecured child restraint can move around in a collision or sudden stop and injure people in the vehicle. Be sure to properly secure any child restraint in the vehicle — even when no child is in it.

In some areas Certified Child Passenger Safety Technicians (CPSTs) are available to inspect and demonstrate how to correctly use and install child restraints. In the U.S., see the National Highway Traffic Safety Administration (NHTSA) website to locate the nearest child safety seat inspection station. For CPST availability in Canada, check with Transport Canada or the Provincial Ministry of Transportation office.

## Securing the Child Within the Child Restraint

### Warning

A child can be seriously injured or killed in a crash if the child is not properly secured in the child restraint. Secure the child properly following the instructions that came with that child restraint.

## Where to Put the Restraint

According to accident statistics, children and infants are safer when properly restrained in an appropriate child restraint secured in a rear seating position.

Whenever possible, children aged 12 and under should be secured in a rear seating position.

Never put a rear-facing child restraint in the front. This is because the risk to the rear-facing child is so great if the airbag deploys.

### Warning

A child in a rear-facing child restraint can be seriously injured or killed if the front passenger airbag inflates. This is because the back of the rear-facing child restraint would be very close to the inflating airbag. A child in a forward-facing child restraint can be seriously injured or killed if the front passenger airbag inflates and the passenger seat is in a forward position.

Even if the passenger sensing system has turned off the front passenger frontal airbag, no system is fail-safe. No one can guarantee that an airbag will not deploy under some unusual circumstance, even though it is turned off.

Secure rear-facing child restraints in a rear seat, even if the airbag is off. If you secure a forward-facing child restraint in the front seat, always move the front passenger seat as far back as it will go. It is better to secure the child restraint in a rear seat.

See *Passenger Sensing System* ⇨ 58 for additional information.

When securing a child restraint with the seat belts in a rear seat position, study the instructions that came with the child restraint to make sure it is compatible with this vehicle.

Child restraints and booster seats vary considerably in size, and some may fit in certain seating positions better than others. Do not install a child restraint in any rear seating position where it cannot be installed securely.

Depending on where you place the child restraint and the size of the child restraint, you may not be able to access adjacent seat belts or LATCH anchors for additional passengers or child restraints. Adjacent seating positions should not be used if the child restraint prevents access to or interferes with the routing of the seat belt.

Adjust the seat in front of a child restraint to ensure proper installation according to the child restraint manual. Move the front seat forward to avoid contact between the child restraint and the seat or any accessories mounted to the seat.

Wherever a child restraint is installed, be sure to follow the instructions that came with the child restraint and secure the child restraint properly.

Keep in mind that an unsecured child restraint can move around in a collision or sudden stop and injure people in the vehicle. Be sure to properly secure any child restraint in the vehicle — even when no child is in it.

### **Lower Anchors and Tethers for Children (LATCH System)**

The LATCH system secures a child restraint during driving or in a crash. LATCH attachments on the child restraint are used to attach the child restraint to the anchors in the vehicle. This system is designed to make installation of a child restraint easier.

In order to use the LATCH system in your vehicle, you need a child restraint that has LATCH attachments. LATCH-compatible rear-facing and forward-facing child seats can be properly installed using either the LATCH anchors or the vehicle's seat belts. Do not use both the seat belts and the LATCH anchorage system to secure a rear-facing or forward-facing child restraint.

Booster seats use the vehicle's seat belts to secure the child and the booster seat. If the manufacturer recommends that the booster seat be secured with the LATCH system, this

can be done as long as the booster seat can be positioned properly and there is no interference with the proper positioning of the lap-shoulder belt on the child.

Make sure to follow the instructions that came with the child restraint, and also the instructions in this manual.

When installing a child restraint with a top tether, you must also use either the lower anchors or the seat belts to properly secure the child restraint. A child restraint must never be installed using only the top tether.

For a forward-facing 5-pt harness child restraint where the combined weight of the child and restraint are up to 29.5 kg (65 lb), use either the lower LATCH anchorages with the top tether anchorage, or the seat belt with the top tether anchorage. Where the combined weight of the child and restraint are greater than 29.5 kg (65 lb), use the seat belt with the top tether anchorage only.

### Recommended Methods for Attaching Child Restraints

Restraint Type	Combined Weight of the Child + Child Restraint	Use Only Approved Attachment Methods Shown with an X			
		LATCH – Lower Anchors Only	Seat Belt Only	LATCH – Lower Anchors and Top Tether Anchor	Seat Belt and Top Tether Anchor
Rear-Facing Child Restraint	Up to 29.5 kg (65 lb)	X	X		
Rear-Facing Child Restraint	Greater than 29.5 kg (65 lb)		X		
Forward-Facing Child Restraint	Up to 29.5 kg (65 lb)			X	X
Forward-Facing Child Restraint	Greater than 29.5 kg (65 lb)				X

See *Securing Child Restraints (With the Seat Belt in the Rear Seat)* ⇨ 76 *Securing Child Restraints (With the Seat Belt in the Front Seat)* ⇨ 78.

Child restraints built after March 2014 are labeled with the maximum child weight, with which the LATCH system can be used for installing the child restraint.

The following explains how to attach a child restraint with these attachments in the vehicle.

Not all vehicle seating positions have lower anchors. In this case, the seat belt must be used (with top tether where available) to secure the child restraint. See *Securing Child*



*Restraints (With the Seat Belt in the Rear Seat)*

⇨ 76 *Securing Child Restraints (With the Seat Belt in the Front Seat)* ⇨ 78.

### Lower Anchors

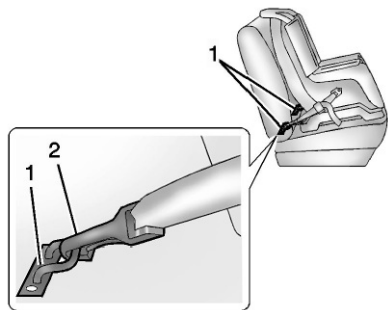

Lower anchors (1) are metal bars built into the vehicle. There are two lower anchors for each LATCH seating position that will accommodate a child restraint with lower attachments (2).

### Top Tether Anchor

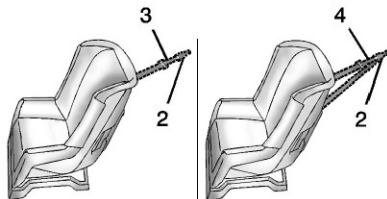

A top tether (3,4) is used to secure the top of the child restraint to the vehicle. A top tether anchor is built into the vehicle. The top tether attachment hook (2) on the child restraint connects to the top tether anchor in the vehicle in order to reduce the forward movement and rotation of the child restraint during driving or in the event of a crash.

The child restraint may have a single tether (3) or a dual tether (4). Either will have a single attachment hook (2) to secure the top tether to the anchor.

Some child restraints with a top tether are designed for use with or without the top tether being attached. Others require the top tether always to be attached. In Canada, the law requires that forward-facing child restraints have a top tether, and that the tether be attached. Be sure to read and follow the instructions for your child restraint.

### Lower Anchor and Top Tether Anchor Locations

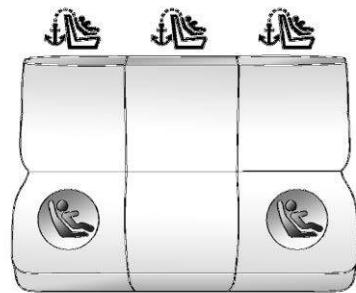

Rear Seat

 : Seating positions with top tether anchors.

 : Seating positions with two lower anchors.



To assist in locating the lower anchors, each seating position with lower anchors has two labels, near the crease between the seatback and the seat cushion.

Do not install a child restraint that requires lower anchors in the center rear seating position. See *Securing Child Restraints (With the Seat Belt in the Rear Seat)* ⇨ 76 *Securing Child Restraints (With the Seat Belt in the Front Seat)* ⇨ 78.

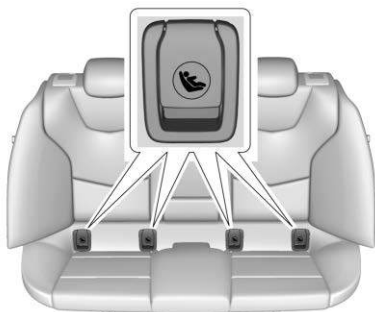

The lower anchors are located under the labeled covers on the seat cushion near the crease between the seatback and the seat cushion.



To assist in locating the top tether anchors, the top tether anchor symbol is on the cover.

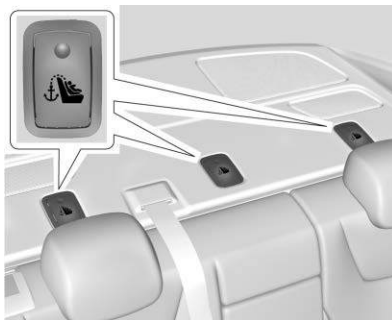

The top tether anchors are behind the rear seat, on the filler panel. Open the covers to access the anchors. Be sure to use an anchor located directly behind the seating position where the child restraint will be placed.

Do not secure a child restraint in a position without a top tether anchor if a national or local law requires that the top tether be attached, or if the instructions that come with the child restraint say that the top tether must be attached.

According to accident statistics, children and infants are safer when properly restrained in a child restraint system or infant restraint system secured in a rear seating position. See *Where to Put the Restraint* ⇨ 69 for additional information.

### Securing a Child Restraint Designed for the LATCH System

#### Warning

A child could be seriously injured or killed in a crash if the child restraint is not properly attached to the vehicle using

(Continued)

**Warning (Continued)**

either the LATCH anchors or the vehicle seat belt. Follow the instructions that came with the child restraint and the instructions in this manual.

 **Warning**

To reduce the risk of serious or fatal injuries during a crash, do not attach more than one child restraint to a single anchor. Attaching more than one child restraint to a single anchor could cause the anchor or attachment to come loose or even break during a crash. A child or others could be injured.

 **Warning**

Children can be seriously injured or strangled if a shoulder belt is wrapped around their neck. The shoulder belt can tighten but cannot be loosened if it is locked. The shoulder belt locks when it is

(Continued)

**Warning (Continued)**

pulled all the way out of the retractor. It unlocks when the shoulder belt is allowed to go all the way back into the retractor, but it cannot do this if it is wrapped around a child's neck. If the shoulder belt is locked and tightened around a child's neck, the only way to loosen the belt is to cut it.

Buckle any unused seat belts behind the child restraint so children cannot reach them. Pull the shoulder belt all the way out of the retractor to set the lock, and tighten the belt behind the child restraint after the child restraint has been installed.

 **Warning**

The power seats will work with the ignition off. Children could operate the power seats and be injured. Never leave children alone in the vehicle.

**Caution**

Do not let the LATCH attachments rub against the vehicle's seat belts. This may damage these parts. If necessary, move buckled seat belts to avoid rubbing the LATCH attachments.

If you need to secure more than one child restraint in the rear seat, see *Where to Put the Restraint* ⇨ 69.

1. Attach and tighten the lower attachments to the lower anchors. If the child restraint does not have lower attachments or the desired seating position does not have lower anchors, secure the child restraint with the top tether and the seat belt. Refer to the child restraint manufacturer instructions and the instructions in this manual.
  - 1.1 Find the lower anchors for the desired seating position.
  - 1.2 Put the child restraint on the seat.
  - 1.3 Attach and tighten the lower attachments on the child restraint to the lower anchors.

2. If the child restraint manufacturer recommends that the top tether be attached, adjust the top tether to its full length and attach it to the anchor. Refer to the child restraint instructions and the following steps:

- 2.1 Find the top tether anchor.
- 2.2 Open the top tether anchor cover to expose the anchor.
- 2.3 Route, attach, and tighten the top tether according to your child restraint instructions and the following instructions:

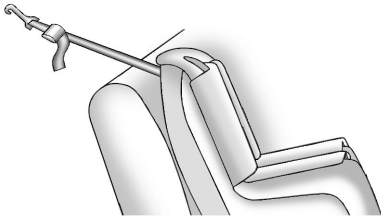

- If the position you are using does not have a headrest or head restraint and you are using a single tether, route the tether over the seatback.

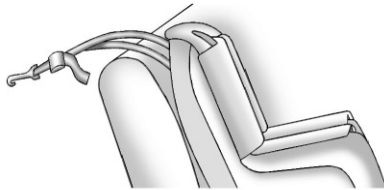

- If the position you are using does not have a headrest or head restraint and you are using a dual tether, route the tether over the seatback.

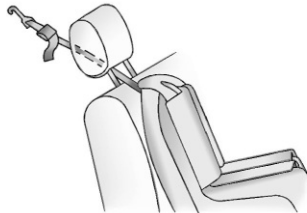

- If the position you are using has an adjustable headrest or head restraint, adjust it accordingly to allow proper fit. If you are

using a single tether, route the tether in between the headrest or head restraint posts.

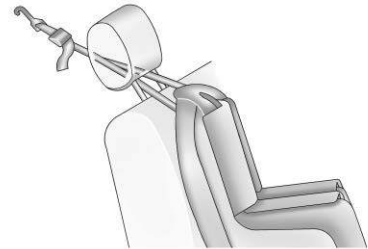

- If the position you are using has an adjustable headrest or head restraint, adjust it accordingly to allow proper fit. If you are using a dual tether, route the tether in between the headrest or head restraint posts.

3. Before placing a child in the child restraint, make sure it is securely held in place. To check, firmly grip the child restraint at the LATCH path and attempt to move it side to

side and back and forth. There should be no more than 2.5 cm (1 in) of movement for proper installation.

## Replacing LATCH System Parts After a Crash

### Warning

A crash can damage the LATCH system in the vehicle. A damaged LATCH system may not properly secure the child restraint, resulting in serious injury or even death in a crash. To help make sure the LATCH system is working properly after a crash, see your dealer to have the system inspected and any necessary replacements made as soon as possible.

If the vehicle has the LATCH system and it was being used during a crash, new LATCH system parts may be needed.

New parts and repairs may be necessary even if the LATCH system was not being used at the time of the crash.

## Securing Child Restraints (With the Seat Belt in the Rear Seat)

When securing a child restraint with the seat belts in a rear seat position, study the instructions that came with the child restraint to make sure it is compatible with this vehicle.

If the child restraint has the LATCH system, see *Lower Anchors and Tethers for Children (LATCH System)* ⇨ 70 for how and where to install the child restraint using LATCH. If a child restraint is secured in the vehicle using a seat belt and it uses a top tether, see *Lower Anchors and Tethers for Children (LATCH System)* ⇨ 70 for top tether anchor locations.

Do not secure a child seat in a position without a top tether anchor if a national or local law requires that the top tether be anchored, or if the instructions that come with the child restraint say that the top strap must be anchored. Refer to the instructions that came with the child restraint and see *Lower Anchors and Tethers for Children (LATCH System)* ⇨ 70.

In Canada, the law requires that forward-facing child restraints have a top tether, and that the tether be attached.

If the child restraint or vehicle seat position does not have the LATCH system, you will be using the seat belt to secure the child restraint. Be sure to follow the instructions that came with the child restraint.

If more than one child restraint needs to be installed in the rear seat, be sure to read *Where to Put the Restraint* ⇨ 69.

1. Put the child restraint on the seat.
  - If the head restraint interferes with the proper installation of the child restraint, see your dealer for assistance.
2. Pick up the latch plate and run the lap and shoulder portions of the vehicle seat belt through or around the child restraint. Ensure the seat belt webbing is routed as directly as possible and is not caught on seat handles or plastic trim. The child restraint instructions will show you how.

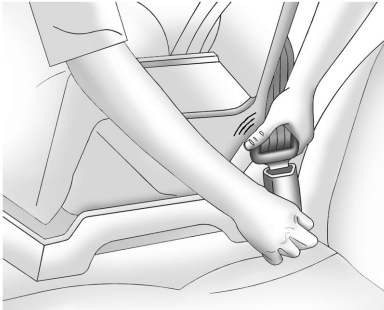

3. Push the latch plate into the buckle until it clicks.

Position the release pushbutton on the buckle, away from the child restraint, so that the seat belt could be quickly unbuckled if necessary.



4. Pull the shoulder belt all the way out of the retractor to set the lock. When the retractor lock is set, the belt can be tightened but not pulled out of the retractor.

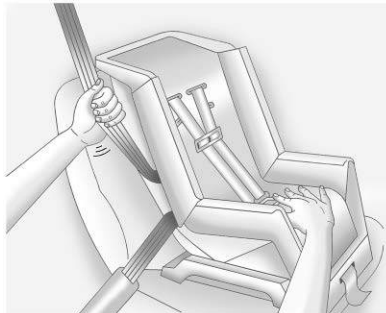

5. To tighten the belt, push down on the child restraint, pull the shoulder portion of the belt to tighten the lap portion of the belt, and feed the shoulder belt back into the retractor. When installing a forward-facing child restraint, it may be helpful to use your knee to push down on the child restraint as you tighten the belt.

There must not be direct contact of the child restraint to the buckle release pushbutton. If there is contact, reposition the child restraint using the instructions that came with the child restraint. If there is still contact, use another seating position or child restraint.

Try to pull the belt out of the retractor to make sure the retractor is locked. If the retractor is not locked, repeat Steps 4 and 5.

6. Tighten the top tether. See *Lower Anchors and Tethers for Children (LATCH System)* ⇨ 70.
7. If the child restraint has a top tether, follow the child restraint manufacturer's instructions regarding the use of the top tether. See *Lower Anchors and Tethers for Children (LATCH System)* ⇨ 70.

8. Before placing a child in the child restraint, make sure it is securely held in place. To check, firmly grip the child restraint at the seat belt path and attempt to move it side to side and back and forth. When the child restraint is properly installed, there should be no more than 2.5 cm (1 in) of movement.

To remove the child restraint, unbuckle the vehicle seat belt and let it return to the stowed position. If the top tether is attached to a top tether anchor, disconnect it.

Many child restraints are too wide to be correctly secured in the center rear seat, although some will fit there. If the center seat position is too narrow for the child restraint, secure it in a rear outboard seat position.

If a rear-facing child restraint is installed in the rear center seat, ensure that the second-row arm rest remains in the stowed (closed) position. If the arm rest cannot be stowed, install the child restraint in another seating position.

## Securing Child Restraints (With the Seat Belt in the Front Seat)

This vehicle has airbags. A rear seat is a safer place to secure a forward-facing child restraint. See *Where to Put the Restraint* ⇨ 69.

In addition, the vehicle has a passenger sensing system which is designed to turn off the front outboard passenger frontal airbag and knee airbag under certain conditions. See *Passenger Sensing System* ⇨ 58 and *Passenger Airbag Status Indicator* ⇨ 100 for more information, including important safety information.

Never put a rear-facing child seat in the front. This is because the risk to the rear-facing child is so great if the airbag deploys.

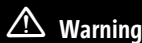

### Warning

A child in a rear-facing child restraint can be seriously injured or killed if the front outboard passenger frontal airbag inflates. This is because the back of the rear-facing child restraint would be very close to the inflating airbag. A child in a forward-facing child restraint can be seriously injured

(Continued)

### Warning (Continued)

or killed if the front outboard passenger frontal airbag inflates and the passenger seat is in a forward position.

Even if the passenger sensing system has turned off the front outboard passenger airbag(s), no system is fail-safe. No one can guarantee that an airbag will not deploy under some unusual circumstance, even though the airbag(s) are off.

Secure rear-facing child restraints in a rear seat, even if the airbag(s) are off. If you secure a forward-facing child restraint in the front outboard passenger seat, always move the seat as far back as it will go. It is better to secure the child restraint in a rear seat.

See *Passenger Sensing System* ⇨ 58 for additional information.

If the child restraint uses a top tether, see *Lower Anchors and Tethers for Children (LATCH System)* ⇨ 70 for top tether anchor locations.

Do not secure a child seat in a position without a top tether anchor if a national or local law requires that the top tether be anchored,

or if the instructions that come with the child restraint say that the top tether must be anchored.

In Canada, the law requires that forward-facing child restraints have a top tether, and that the tether be attached.

When using the lap-shoulder belt to secure the child restraint in this position, follow the instructions that came with the child restraint and the following instructions:

1. Move the seat as far back as it will go before securing the forward-facing child restraint. Move the seat upward or the seatback to an upright position, if needed, to get a tight installation of the child restraint.

When the passenger sensing system has turned off the front outboard passenger frontal airbag and knee airbag, the OFF indicator on the passenger airbag status indicator should light and stay lit when you start the vehicle. See *Passenger Airbag Status Indicator* ⇨ 100.

2. Put the child restraint on the seat.
3. Pick up the latch plate and run the lap and shoulder portions of the vehicle seat belt through or around the restraint. Ensure the seat belt webbing is routed as direct

as possible and is not caught on seat handles or plastic trim. The child restraint instructions will show you how.

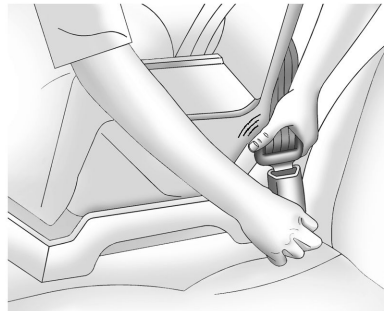

4. Push the latch plate into the buckle until it clicks.

Position the release pushbutton on the buckle, away from the child restraint, so that the seat belt could be quickly unbuckled if necessary.

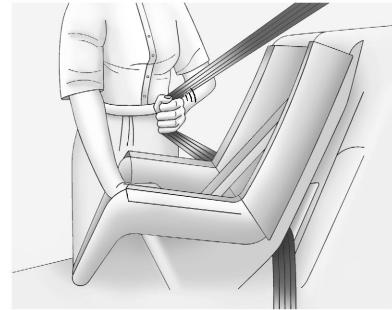

5. Pull the shoulder belt all the way out of the retractor to set the lock. When the retractor lock is set, the belt can be tightened but not pulled out of the retractor.

It may be necessary to slide the adjustable stop along the webbing toward the outboard anchor to fully tighten the seat belt around the child restraint. While a child restraint is installed, the adjustable stop should be positioned on the portion of the webbing that does not interact with the child restraint.



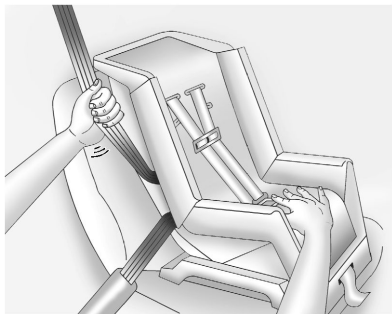

6. To tighten the belt, push down on the child restraint, pull the shoulder portion of the belt to tighten the lap portion of the belt, and feed the shoulder belt back into the retractor.

When installing a forward-facing child restraint, it may be helpful to use your knee to push down on the child restraint as you tighten the belt.

There must not be direct contact of the child restraint to the buckle release pushbutton. If there is contact, move the seat upward and repeat prior installation steps. If there is still contact, reposition the child restraint

using the instructions that came with the child restraint. If there is still contact, use another seating position or child restraint.

Try to pull the belt out of the retractor to make sure the retractor is locked. If the retractor is not locked, repeat Steps 5 and 6.

7. Before placing a child in the child restraint, make sure it is securely held in place. To check, firmly grip the child restraint at the seat belt path and attempt to move it side to side and back and forth. When the child restraint is properly installed, there should be no more than 2.5 cm (1 in) of movement.

If the airbags are off, the OFF indicator in the passenger airbag status indicator will come on and stay on when the vehicle is started.

If a child restraint has been installed and the ON indicator is lit, see “If the On Indicator Is Lit for a Child Restraint” under *Passenger Sensing System* ⇨ 58.

To remove the child restraint, unbuckle the vehicle seat belt and let it return to the stowed position.

## Storage

### Storage Compartments

Storage Compartments .....	81
Glove Box .....	81
Cupholders .....	81
Center Console Storage .....	82
Umbrella Storage .....	82

### Additional Storage Features

Cargo Tie-Downs .....	83
-----------------------	----

## Storage Compartments

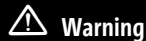

### Warning

Do not store heavy or sharp objects in storage compartments. In a crash, these objects may cause the cover to open and could result in injury.

## Glove Box



Pull the handle from the side to open the glove box. Close until it latches. Use the mechanical key in the remote key to lock or unlock. See *Keys* ⇨ 6.

## Cupholders

Cupholders in the center console have a retractable cover. Do not place items on the cover.

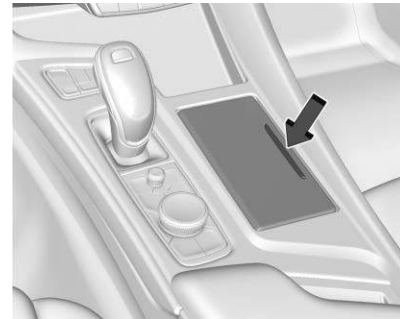

Press the button to open the cover.

### Rear Seat Cupholders



If equipped, pull down the rear seat armrest to use the cupholders.

### Center Console Storage

If equipped, the SD card is used for navigation. Do not remove the card from the holder.

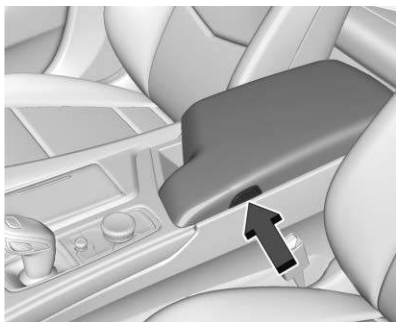

#### Automatic Transmission Shown, Manual Transmission Similar

Press the button and lift to access the storage area. There is an accessory power outlet, two USB ports, and an SD card slot inside. See *Power Outlets* ⇨ 88 or *USB Port* ⇨ 141.

If equipped, there is a removable phone holder to store a phone and the cord while charging.

### Umbrella Storage



Slide a compact umbrella no larger than 6 cm (2.36 in) in diameter into the opening on the driver or passenger door.

## Additional Storage Features

### Cargo Tie-Downs

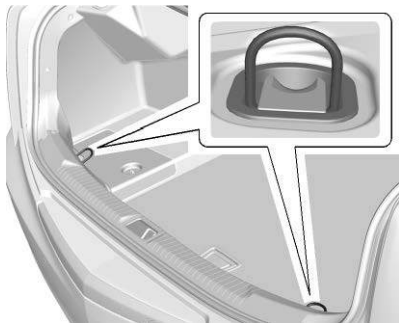

The cargo tie-downs can be used to secure small loads inside the trunk.

## Instruments and Controls

### Controls

Steering Wheel Adjustment .....	85
Heated Steering Wheel .....	85
Horn .....	86
Windshield Wiper/Washer .....	86
Compass .....	87
Clock .....	88
Power Outlets .....	88
Wireless Charging .....	88

### Warning Lights, Gauges, and Indicators

Warning Lights, Gauges, and Indicators ...	90
Instrument Cluster .....	92
Speedometer .....	94
Odometer .....	94
Trip Odometer .....	94
Tachometer .....	94
Fuel Gauge .....	95
Speed Limiter Indicator .....	95
Engine Oil Pressure Gauge .....	96
Engine Oil Temperature Gauge .....	97
Engine Coolant Temperature Gauge .....	97
Transmission Temperature Gauge .....	98
Seat Belt Reminders .....	99
Airbag Readiness Light .....	100
Passenger Airbag Status Indicator .....	100
Charging System Light .....	101

Malfunction Indicator Lamp (Check Engine Light) .....	101
Brake System Warning Light .....	103
Electric Parking Brake Light .....	103
Service Electric Parking Brake Light .....	103
Antilock Brake System (ABS) Warning Light .....	104
Performance Shifting Light .....	104
All-Wheel-Drive Light .....	104
Automatic Vehicle Hold (AVH) Light .....	104
Lane Keep Assist (LKA) Light .....	105
Automatic Emergency Braking (AEB) Disabled Light .....	105
Vehicle Ahead Indicator .....	105
Pedestrian Ahead Indicator .....	105
Traction Off Light .....	106
Traction Control System (TCS)/Electronic Stability Control Light .....	106
Electronic Stability Control (ESC) Off Light .....	106
Engine Coolant Temperature Warning Light .....	107
Driver Mode Control Light .....	107
Tire Pressure Light .....	108
Engine Oil Pressure Light .....	109
Low Fuel Warning Light .....	109
Auto Stop Indicator .....	109
Security Light .....	109
High-Beam On Light .....	110

Adaptive Forward Lighting (AFL) Light .....	110
Lamps On Reminder .....	110
Cruise Control Light .....	110
Adaptive Cruise Control Light .....	110
Super Cruise Light .....	111
Driver Attention Assist Light .....	111
Door Ajar Light .....	111

### Information Displays

Driver Information Center (DIC) .....	111
Vehicle Status .....	115
Head-Up Display (HUD) .....	117

### Vehicle Messages

Vehicle Messages .....	120
Engine Power Messages .....	121
Vehicle Speed Messages .....	121

### Universal Remote System

Universal Remote System .....	121
Universal Remote System Programming .....	121
Universal Remote System Operation .....	123

## Controls

### Steering Wheel Adjustment



To adjust the steering wheel:

1. Pull the lever down.
2. Move the steering wheel up or down.
3. Pull or push the steering wheel closer or away from you.
4. Pull the lever up to lock the steering wheel in place.

### Power Tilt and Telescoping Wheel



If equipped, the control is on the left side of the steering column.

- Push the control up or down to tilt the steering wheel up or down.
- Push the control forward or rearward to move the steering wheel toward the front or rear of the vehicle.

Do not adjust the steering wheel while driving.

To set the power tilt wheel memory position, see *Memory Seats* ⇨ 39.

### Heated Steering Wheel

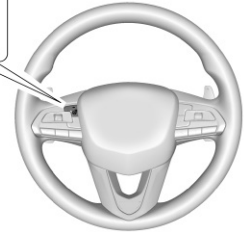

 : If equipped, press to turn the heated steering wheel on or off. An indicator light next to the button displays when the feature is turned on.

The steering wheel takes about three minutes to be fully heated.

If equipped with a remote start heated steering wheel, the heated steering wheel and indicator will turn on automatically.

If equipped with auto heated seats, the heated steering wheel will turn on along with the heated seats when it is cold outside. The heated steering wheel indicator light may not come on. See *Heated and Ventilated Front Seats* ⇨ 42.

## Horn

Press  on the steering wheel pad to sound the horn.

## Windshield Wiper/Washer



With the ignition on or in accessory mode, move the windshield wiper lever to select the wiper speed.

**HI:** Use for fast wiper.

**LO:** Use for slow wiper.



**INT:** Use this setting for intermittent wipes or for Rainsense wipes, when Rainsense is enabled. For intermittent wipes, move the lever up to INT, then turn the  INT band up for more frequent wipes or down for less frequent wipes. If Rainsense is enabled, see “Rainsense” later in this section.

If the windshield wipers are in use for a while when driving, the exterior lamps come on automatically if the exterior lamp control is in AUTO. See “Wiper-Activated Headlamps” later in this section.

**OFF:** Use to turn the wipers off.

**1X:** For a single wipe, briefly move the wiper lever down. For several wipes, hold the wiper lever down.

↓  : Pull the windshield wiper lever toward you to spray windshield washer fluid and activate the wipers. The wipers will continue until the lever is released or the maximum wash time is reached. When the windshield wiper

lever is released, additional wipes may occur depending on how long the windshield washer had been activated. See *Washer Fluid* ⇨ 307 for information on filling the windshield washer fluid reservoir.

### Warning

In freezing weather, do not use the washer until the windshield is warmed. Otherwise the washer fluid can form ice on the windshield, blocking your vision.

### Warning

Before driving the vehicle, always clear snow and ice from the hood, windshield, washer nozzles, roof, and rear of the vehicle, including all lamps and windows. Reduced visibility from snow and ice buildup could lead to a crash.

Clear snow and ice from the wiper blades and windshield before using them. If frozen to the windshield, carefully loosen or thaw them. Damaged blades should be replaced. See *Wiper Blade Replacement* ⇨ 313.

## Wiper Parking

If the ignition is turned off while the wipers are on LO, HI, or INT, they will immediately stop.

If the windshield wiper lever is then moved to OFF before the driver door is opened or within 10 minutes, the wipers will restart and move to the base of the windshield.

If the ignition is turned off while the wipers are performing wipes due to windshield washing or Rainsense wipes, the wipers continue to run until they reach the base of the windshield.

## Rainsense

There is a sensor near the top center of the windshield that detects the amount of water on the windshield and controls the frequency of the windshield wiper.

To turn the Rainsense feature on or off, select Settings > Vehicle > Comfort and Convenience > Rainsense Wipers > Select ON or OFF.

Keep this area of the windshield clear of debris to allow for best system performance.

**AUTO:** When enabled, move the windshield wiper lever to AUTO. Turn the  AUTO band on the wiper lever to adjust the sensitivity.



- Turn the band up for more sensitivity to moisture.
- Turn the band down for less sensitivity to moisture.
- Move the windshield wiper lever out of the AUTO position to deactivate Rainsense.

## Wiper Arm Assembly Protection

If equipped with wiper arm assembly protection, when using an automatic car wash, move the windshield wiper lever to OFF. This disables the automatic Rainsense windshield wipers.

With Rainsense, if the transmission is in N (Neutral) and the vehicle speed is very slow, the wipers will automatically stop at the base of the windshield.

The wiper operations return to normal when the transmission is no longer in N (Neutral) or the vehicle speed has increased.

## Wiper-Activated Headlamps

This feature activates the headlamps and parking lamps after the windshield wipers have been in use for a while. The transition time for the lamps coming on varies based on the wiper speed. For this feature to work, the exterior lamp control must be in AUTO.

The wiper-activated headlamps immediately turn off when the ignition is turned off, or the windshield wiper control is turned off.

## Compass

The vehicle may have a compass display on the Driver Information Center (DIC). The compass receives its heading and other information from the Global Positioning System (GPS) antenna, StabiliTrak/Electronic Stability Control (ESC), and vehicle speed information.

The compass system can operate for a limited distance or degrees of turn before needing an update from the GPS satellites. When the compass display shows CAL, drive the vehicle to a clear or open area. The system will automatically search for a GPS signal and provide a heading again when the link to the satellites is re-established.



## Clock

Set the time and date using the infotainment system. See "Date/Time" under *Settings* ⇨ 159.

## Power Outlets

The accessory power outlets can be used to plug in electrical equipment, such as a cell phone or MP3 player.

The vehicle has two accessory power outlets:

- Inside the center console storage area.
- On the rear of the center floor console.

Lift the cover to access the accessory power outlet.

Certain electrical accessories may not be compatible with the accessory power outlet and could overload a vehicle circuit breaker or adapter fuse. If overloaded, the circuit breaker will reset after all devices are disconnected or if Retained Accessory Power (RAP) is turned off and then back on. See *Retained Accessory Power (RAP)* ⇨ 197. Wait one minute to allow the circuit breaker to reset before reconnecting devices or turning RAP back on. If the problem continues, the issue could be within your device. Try another known good device to make

sure the circuit breaker is operating properly. If this does not resolve your problem, see your dealer.

It is possible to replace the factory power outlet with a cigar lighter receptacle, if desired. This requires the factory installed circuit breaker to be replaced with a standard minifuse by the dealer. A minifuse will not reset and will have to be replaced if blown.

### Caution

Failure to replace the circuit breaker with the minifuse could overheat the cigar lighter and damage the vehicle.

When adding electrical equipment, be sure to follow the proper installation instructions included with the equipment. See *Add-On Electrical Equipment* ⇨ 285.

### Caution

Hanging heavy equipment from the power outlet can cause damage not covered by the vehicle warranty. The power outlets are designed for accessory power plugs only, such as cell phone charge cords.

Always unplug electrical equipment when not in use and do not plug in equipment that exceeds the maximum 15 amps rating.

## Wireless Charging

If equipped and enabled, the vehicle has wireless charging in the bin below the climate control system. The system operates at 145 kHz and wirelessly charges one Qi compatible smartphone. The power output of the system is capable of charging at a rate up to 3 amp (15 W), as requested by the compatible smartphone.

See *Radio Frequency Statement* ⇨ 387.

### Warning

Wireless charging may affect the operation of an implanted pacemaker or other medical devices. If you have one, it is recommended to consult with your doctor before using the wireless charging system.

The vehicle must be on, in accessory mode, or Retained Accessory Power (RAP) must be active. The wireless charging feature may not correctly indicate charging when the vehicle is in RAP, during a Bluetooth phone call, or when

phone projection (e.g. Apple CarPlay / Android Auto) is active. See *Retained Accessory Power (RAP)* ⇨ 197.

The operating temperature is  $-40^{\circ}\text{C}$  ( $-40^{\circ}\text{F}$ ) to  $85^{\circ}\text{C}$  ( $185^{\circ}\text{F}$ ) for the charging system and  $0^{\circ}\text{C}$  ( $32^{\circ}\text{F}$ ) to  $35^{\circ}\text{C}$  ( $95^{\circ}\text{F}$ ) for the phone.

A charging stopped alert may be displayed on the infotainment screen, if the wireless charger or smartphone are outside of normal operating temperature. Charging will automatically resume when a normal operating temperature is reached.

### Warning

Remove all objects from the charger before charging your compatible smartphone. Objects, such as coins, keys, rings, paper clips, or cards, between the smartphone and charger may become very hot.

On the rare occasion that the charging system does not detect an object, and the object gets wedged between the smartphone and charger, remove the smartphone and allow the object to cool before removing it from the charger, to prevent burns.





To charge a compatible smartphone:

1. Confirm the smartphone is capable of wireless charging.
2. Remove all objects from the charging pad. The system may not charge if there are any objects between the smartphone and charger.
3. Place the smartphone face up against the rear of the charger.

To maximize the charge rate, ensure the smartphone is fully seated and centered in the holder with nothing under it.

A thick smartphone case may prevent the charger from working, or reduce the charging performance. See your dealer for additional information.

4. A green  will appear on the infotainment display, next to the phone icon. This indicates that the smartphone is detected.
5. If a smartphone is placed on the charger and  turns off or turns yellow, remove the smartphone and any objects from the pad. Turn the smartphone 180 degrees and wait a few seconds before placing/aligning it on the pad again.
6. If a smartphone is placed on the charger and  turns red, the charger and/or the smartphone is overheated. Remove the smartphone and any objects from the charger in order to cool the system.

The smartphone may become warm during charging. This is normal. In warmer temperatures, the speed of charging may be reduced.

For vehicles with wireless phone projection, the smartphone may overheat during wireless charging. The smartphone may slow down,

stop charging, or shut down to protect the battery. The phone may need to be removed from its case to prevent overheating. The ⚡ may flash while the phone is cooling down enough for wireless charging to automatically resume. This is normal. Individual phone performance may vary.

### Software Acknowledgements

Certain Wireless Charging Module product from LG Electronics, Inc. ("LGE") contains the open source software detailed below. Refer to the indicated open source licenses (as are included following this notice) for the terms and conditions of their use.

### OSS Notice Information

To obtain the source code that is contained in this product, please visit <https://opensource.lge.com>. In addition to the source code, all referred license terms, warranty disclaimers and copyright notices are available for download. LG Electronics will also provide open source code to you on CD-ROM for a charge covering the cost of performing such distribution (such as the cost of media, shipping, and handling) upon email request

to [opensource@lge.com](mailto:opensource@lge.com). This offer is valid for three (3) years from the date on which you purchased the product.

### Freescale-WCT library

Copyright (c) 2012-2014 Freescale Semiconductor, Inc.. All rights reserved.

Redistribution and use in source and binary forms, with or without modification, are permitted provided that the following conditions are met:

1. Redistributions of source code must retain the above copyright notice, this list of conditions and the following disclaimer.
2. Redistributions in binary form must reproduce the above copyright notice, this list of conditions and the following disclaimer in the documentation and/or other materials provided with the distribution.
3. Neither the name of the copyright holder nor the names of its contributors may be used to endorse or promote products derived from this software without specific prior written permission.

THIS SOFTWARE IS PROVIDED BY THE COPYRIGHT HOLDERS AND CONTRIBUTORS "AS IS" AND ANY EXPRESS OR IMPLIED WARRANTIES, INCLUDING, BUT NOT LIMITED TO, THE IMPLIED WARRANTIES OF MERCHANTABILITY AND FITNESS FOR A PARTICULAR PURPOSE ARE DISCLAIMED. IN NO EVENT SHALL THE COPYRIGHT HOLDER OR CONTRIBUTORS BE LIABLE FOR ANY DIRECT, INDIRECT, INCIDENTAL, SPECIAL, EXEMPLARY, OR CONSEQUENTIAL DAMAGES (INCLUDING, BUT NOT LIMITED TO, PROCUREMENT OF SUBSTITUTE GOODS OR SERVICES; LOSS OF USE, DATA, OR PROFITS; OR BUSINESS INTERRUPTION) HOWEVER CAUSED AND ON ANY THEORY OF LIABILITY, WHETHER IN CONTRACT, STRICT LIABILITY, OR TORT (INCLUDING NEGLIGENCE OR OTHERWISE) ARISING IN ANY WAY OUT OF THE USE OF THIS SOFTWARE, EVEN IF ADVISED OF THE POSSIBILITY OF SUCH DAMAGE.

## Warning Lights, Gauges, and Indicators

Warning lights and gauges can signal that something is wrong before it becomes serious enough to cause an expensive repair or replacement. Paying attention to the warning lights and gauges could prevent injury.

---

Some warning lights come on briefly when the engine is started to indicate they are working. When one of the warning lights comes on and stays on while driving, or when one of the gauges shows there may be a problem, check the section that explains what to do. Waiting to do repairs can be costly and even dangerous.

## Instrument Cluster

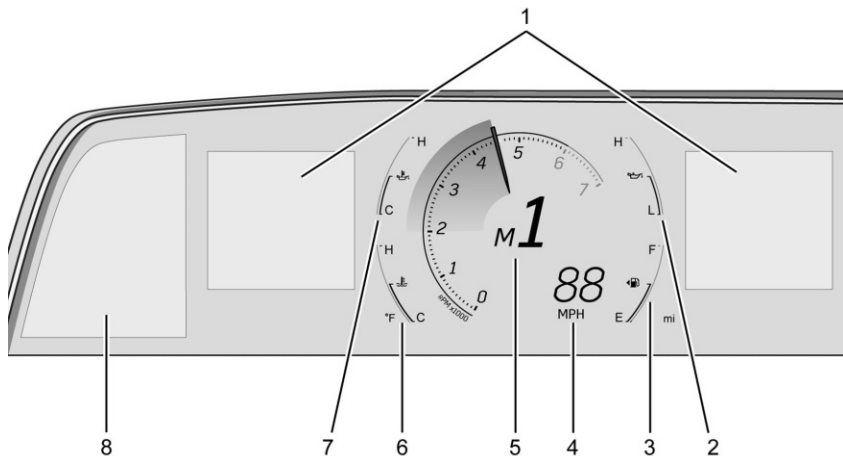

English Sport Mode Gauge View Shown, Others and Metric Similar

1. Driver Information Center (DIC) ⇨ 111
2. Engine Oil Pressure Gauge ⇨ 96
3. Fuel Gauge ⇨ 95
4. Speedometer ⇨ 94
5. Tachometer ⇨ 94
6. Engine Coolant Temperature Gauge ⇨ 97
7. Engine Oil Temperature Gauge ⇨ 97
8. Control Panel. See “Control Panel” later in this section.

## Reconfigurable Instrument Cluster

The instrument cluster display layout can be changed. There are two display configurations to choose from based on the driver mode selected: Tour, and Sport. To see how to change the Driver Mode, see “Mode Activation” under *Driver Mode Control* ⇨ 211.

- Tour configuration displays the speedometer in the center of the display. The fuel gauge is located on the right of the speedometer and the tachometer is on the left of it. There are two DIC areas on the left and right of the display.
- Sport configuration displays the tachometer in the center of the display. The gauges are located on the left and right of the tachometer. The speedometer is located near the fuel gauge and the tachometer is above it. There are two DIC areas on the left and right of the display.
- If equipped, track configuration displays the tachometer on the top of the display. The speedometer is located near the fuel gauge and there are two DIC areas on the left and right of the speedometer. The fuel

gauge is located on the right of the display. All other gauges are located on the left and right of the DIC areas.

The following are selectable views:

**Gauge:** Displays information zones to the left and right of the speedometer.

**Map:** Displays a navigation map.

**Assist:** If equipped, displays driver assistance information in the left information zone. There are two gauges located on the bottom of the display.

**Clean:** Displays no information zones.

To change the cluster configuration, touch  on the control panel to the left of the instrument cluster. Select the desired option from the list.

Selecting a different view could hide the vehicle status displayed in the information zones on the cluster. Once a view with information zones is selected, the last selected vehicle status will be displayed. See *Driver Information Center (DIC)* ⇨ 111 and *Vehicle Status* ⇨ 115.

## Control Panel

There is a touchscreen to the left of the instrument cluster. Use it for the following:

**Instrument Cluster Layout:** Touch LAYOUT to view and select the available instrument cluster views.

**Head-Up Display (HUD):** If equipped, touch HUD to select the height and brightness of the head-up display. See *Head-Up Display (HUD)* ⇨ 117.

**Trip Information:** Touch TRIP to view distance and average fuel economy for the current trip. View other trip information by swiping right or left on the touchscreen.

Touch and hold to reset the current trip.

**List Page:** Touch  to view and select the available list options. View options by swiping up or down and right or left on the touchscreen.

**Lane Keep Assist (LKA):** If equipped, touch  to select the available Lane Keep Assist (LKA) options. See *Lane Keep Assist (LKA)* ⇨ 272.

**Headlights:** If equipped, touch  to select the available headlight options. See *Exterior Lamp Controls* ⇨ 124.

## V-Series Only

**List Page:** Touch  to view and select the available list options. View options by swiping up or down and right or left on the touchscreen. See “Control Panel” under *Driver Information Center (DIC)* ⇨ 111.

**Performance:** If equipped, touch  to view the available performance information. View and select other performance information and options by swiping right or left on the touchscreen.

**Headlights:** If equipped, touch  to select the available headlight options. See *Exterior Lamp Controls* ⇨ 124.

**Lane Keep Assist (LKA):** If equipped, touch  to select the available Lane Keep Assist (LKA) options. See *Lane Keep Assist (LKA)* ⇨ 272.

**Head-Up Display (HUD):** If equipped, touch HUD to select the height and brightness of the head-up display. See *Head-Up Display (HUD)* ⇨ 117.

## Display Settings

The following options can be turned on or off using the infotainment display. Some may not be available for your particular vehicle. See *Settings* ⇨ 159.

### Speed Sign

Shows sign information from a roadway database in the onboard navigation. The sign will show “--” when there is no detected speed limit or the system is unavailable.

### Turn-by-Turn Graphics

Provides turn-by-turn navigation graphics during an active route in your driver display.

### Traffic Sign Recognition

Displays the detected speed limit in your driver display.

## Speedometer

The speedometer shows the vehicle speed in either kilometers per hour (km/h) or miles per hour (mph).

## Odometer

The odometer shows how far the vehicle has been driven, in either kilometers or miles.

### Trip Odometer

The trip odometer shows how far the vehicle has been driven since the trip odometer was last reset.

The trip odometer is accessed and reset through the control panel to the left of the instrument cluster. See *Instrument Cluster* ⇨ 92.

## Tachometer

The tachometer displays the engine speed in revolutions per minute (rpm).

The tachometer may vary by several hundred rpm, during Auto Stop mode, when the engine is shutting off and restarting.

The redline of the tachometer adjusts dynamically based on engine temperature. The redline displays a lower indication when the vehicles odometer value is less than 805 kilometers (500 miles).

If equipped, the shift indicators are displayed on instrument cluster and Head-Up Display (HUD). The shift indicators are only operational when the automatic transmission is in Manual mode, or the vehicle has a manual transmission. See *Manual Mode* ⇨ 203. When the vehicle engine is less than 70°C (158°F) and the vehicle odometer value is less than 805 kilometers (500 miles) the shift indications are not displayed.

A strong visual indicator is displayed as the vehicle approaches the red line. Tour and Sport themes feature shift rings while the Track theme features shift lights accompanied by a numerical tachometer display.

## Fuel Gauge

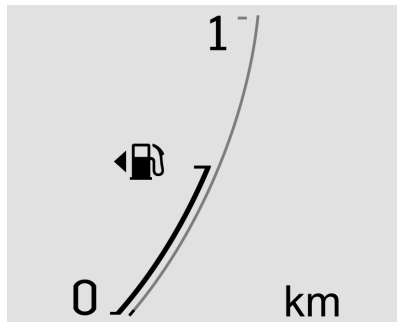

Metric Sport Mode Gauge View Shown,  
Others Similar

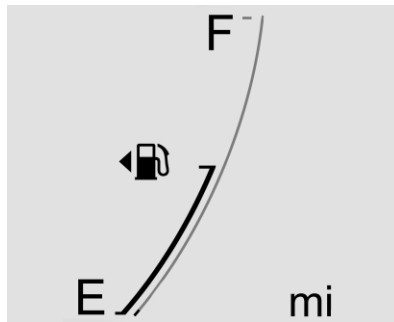

English Sport Mode Gauge View Shown,  
Others Similar

When the ignition is on, the fuel gauge indicates about how much fuel is left in the tank.

There is an arrow near the fuel gauge pointing to the side of the vehicle the fuel door is on.

When the indicator nears empty, the low fuel light comes on. There still is a little fuel left, but the vehicle should be refueled soon.

The fuel gauge may:

- Take a little more, or less fuel to fill up than it indicates. For example, the gauge may have indicated the tank is half full, but it actually will take a little more, or less than half the tank's capacity to fill the tank.
- Moves a little while turning a corner, speeding up, or braking.
- Take a few seconds to stabilize after the ignition is turned on and goes back to empty when the ignition is turned off.

These are normal conditions, none of which indicate a problem with the fuel gauge.

## Speed Limiter Indicator



This light is white when the speed limiter is on and ready, and turns green when the speed limiter is set and active.

See *Speed Limiter* ⇨ 223.



## Engine Oil Pressure Gauge

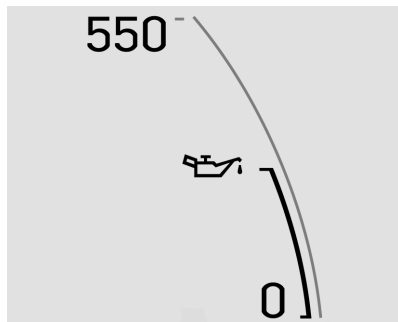

Metric Sport Mode Gauge View Shown,  
Others Similar

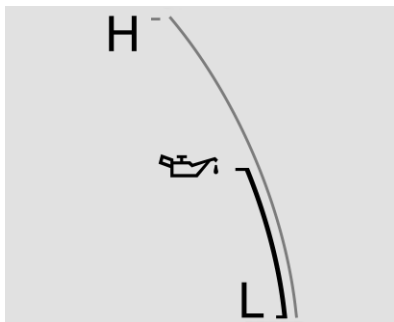

English Sport Mode Gauge View Shown,  
Others Similar

### Caution

Lack of proper engine oil maintenance can damage the engine. Driving with the engine oil low can also damage the engine. The repairs would not be covered by the vehicle warranty. Check the oil level as soon as possible. Add oil if required, but if the oil level is within the operating range and the oil pressure is still low, have the vehicle serviced. Always follow the maintenance schedule for changing engine oil.

The engine oil pressure gauge shows the engine oil pressure in kPa (kilopascals) or psi (pounds per square inch) when the engine is running.

Oil pressure can vary with engine speed, outside temperature, coolant temperature, and oil viscosity.

On some models, the oil pump will vary engine oil pressure according to engine needs. Oil pressure may change quickly as the engine speed or load varies. This is normal. If the oil pressure warning light or Driver Information Center (DIC) message indicates oil pressure outside the normal operating range, check the engine oil as soon as possible.

See *Engine Oil* ⇨ 295.

## Engine Oil Temperature Gauge

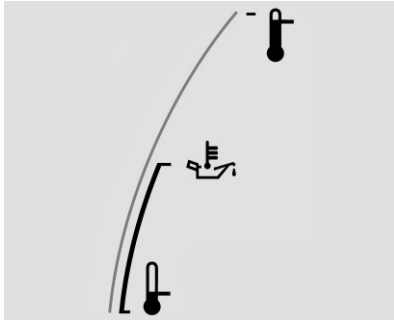

Metric Sport Mode Gauge View Shown,  
Others Similar

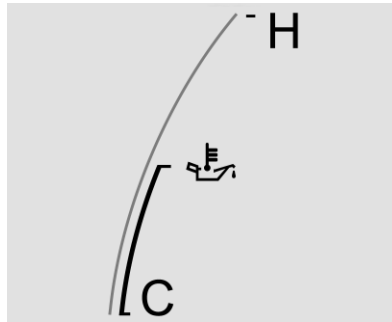

English Sport Mode Gauge View Shown,  
Others Similar

This gauge shows the engine oil temperature. If the gauge pointer moves into the high end, it means that the engine oil has overheated. If the vehicle has been operated under normal driving conditions, pull off the road, stop the vehicle, and turn off the engine as soon as possible.

See *Engine Oil* ⇨ 295.

## Engine Coolant Temperature Gauge

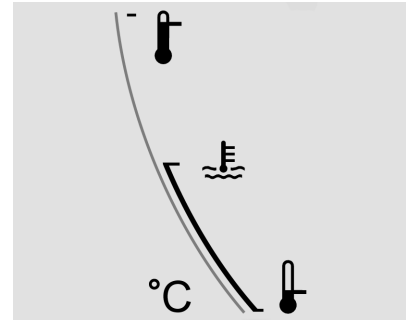

Metric Sport Mode Gauge View Shown,  
Others Similar

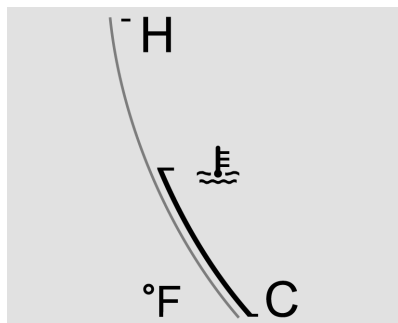

English Sport Mode Gauge View Shown,  
Others Similar

This gauge shows the engine coolant temperature.

If the pointer moves toward the warning area at the high end of the gauge, the engine is too hot.

This reading indicates the same thing as the warning light. It means that the engine coolant has overheated. If the vehicle has been operating under normal driving conditions, pull off the road, stop the vehicle, and turn off the engine as soon as possible. See *Engine Overheating* ⇨ 306.

### Transmission Temperature Gauge

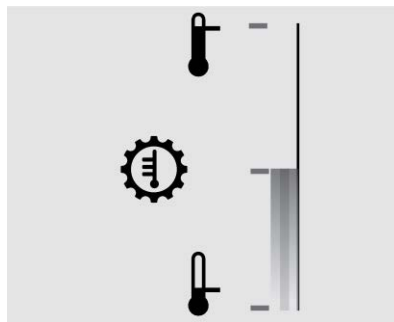

Metric Track Mode Gauge View Shown,  
Others Similar

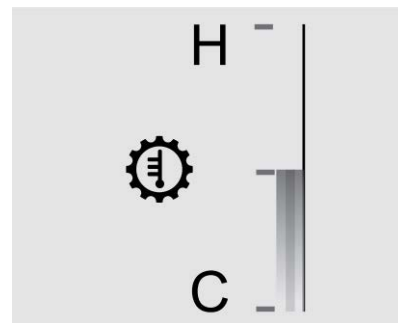

English Track Mode Gauge View Shown,  
Others Similar

#### Caution

Do not drive the vehicle while the transmission fluid is overheating, or the transmission can be damaged. This could lead to costly repairs that would not be covered by the warranty.

If equipped, the transmission temperature gauge shows the transmission fluid temperature. If the gauge is reading in the red area and/or a message appears in the Driver

Information Center (DIC), the vehicle must be stopped and the cause checked. One possible cause is a low fluid level in the transmission.

## Seat Belt Reminders

### Driver Seat Belt Reminder Light

There is a driver seat belt reminder light on the instrument cluster.



When the vehicle is started, this light flashes and a chime may come on to remind the driver to fasten their seat belt.

Then the light stays on solid until the belt is buckled. This cycle may continue several times if the driver remains or becomes unbuckled while the vehicle is moving.

If the driver seat belt is buckled, neither the light nor the chime comes on.

### Front Passenger Seat Belt Reminder Light

The vehicle may have a front passenger seat belt reminder light near the passenger airbag status indicator. See *Passenger Sensing System* ⇨ 58.



When the vehicle is started, this light flashes and a chime may come on to remind passengers to fasten their seat belt.

Then the light stays on solid until the belt is buckled. This cycle continues several times if the front passenger remains or becomes unbuckled while the vehicle is moving.

If the front passenger seat belt is buckled, neither the chime nor the light comes on.

The front passenger seat belt reminder light and chime may come on if an object is put on the seat such as a briefcase, handbag, grocery bag, laptop, or other electronic device. To turn off the reminder light and/or chime, remove the object from the seat or buckle the seat belt.

### Second Row Passenger Seat Belt Reminder Lights

The vehicle may have second row passenger seat belt reminder lights. The vehicle has one of the following displays.



- A shaded or green light indicates the seat belt is buckled.



- An X indicates the seat belt is not buckled. A check mark indicates the seat belt is buckled.

For information on the front seat belt reminder lights, see "Driver Seat Belt Reminder Light" and "Front Passenger Seat Belt Reminder Light" listed previously in this section.

When the vehicle is started, these lights come on solid to remind rear passengers to fasten their seat belts. Then each light may stay on solid or flash, and a chime may come on if the rear passenger remains unbuckled, or becomes unbuckled, when the vehicle is moving.

If all rear seat positions are buckled, neither the chime nor the lights will come on.

## Airbag Readiness Light

This light shows if there is an electrical problem with the airbag system. It is located in the instrument cluster. The system check includes the airbag sensor(s), the passenger sensing system, the pretensioners, the airbag modules, the wiring, and the crash sensing and diagnostic module. For more information on the airbag system, see *Airbag System* ⇨ 53.



The airbag readiness light comes on for several seconds when the vehicle is started. If the light does not come on then, have it fixed immediately.

### Warning

If the airbag readiness light stays on after the vehicle is started or comes on while driving, it means the airbag system might not be working properly. The airbags in the vehicle might not inflate in a crash, or they could even inflate without a crash. To help avoid injury, have the vehicle serviced right away.

If there is a problem with the airbag system, a Driver Information Center (DIC) message may also come on.

## Passenger Airbag Status Indicator

The vehicle has a passenger sensing system. See *Passenger Sensing System* ⇨ 58 for important safety information. The overhead console has a passenger airbag status indicator.

## PASS AIR BAG



When the vehicle is started, the passenger airbag status indicator will light ON and OFF, and the symbols for on and off, for several seconds as a system check. Then, after several more seconds, the status indicator will light either ON or OFF, and either the symbol for on or off, to let you know the status of the front outboard passenger frontal airbag and knee airbag.

If the word ON, and the on symbol, is lit on the passenger airbag status indicator, it means that the front outboard passenger frontal airbag and knee airbag are allowed to inflate.

If the word OFF, and the off symbol, is lit on the passenger airbag status indicator, it means that the passenger sensing system has turned off the front outboard passenger frontal airbag and knee airbag.

If, after several seconds, all of the symbols remain lit, or if no symbols are lit, or if the airbag readiness light is on, there may be

a problem with the lights or the passenger sensing system. See your dealer for service right away.

### Warning

If the airbag readiness light ever comes on and stays on, it means that something may be wrong with the airbag system. To help avoid injury to yourself or others, have the vehicle serviced right away. See *Airbag Readiness Light* ⇨ 100 for more information, including important safety information.

## Charging System Light

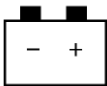

The charging system light comes on briefly when the ignition is turned on, but the engine is not running, as a check to show the light is working. It should go out when the engine is started.

If the light stays on, or comes on while driving, there may be a problem with the electrical charging system. Have it checked by your dealer. Driving while this light is on could drain the battery.

When this light comes on, or is flashing, the Driver Information Center (DIC) also displays a message.

If a short distance must be driven with the light on, be sure to turn off all accessories, such as the radio and air conditioner. Find a safe place to stop the vehicle.

## Malfunction Indicator Lamp (Check Engine Light)

This light is part of the vehicle's emission control on-board diagnostic system. If this light is on while the engine is running, a malfunction has been detected and the vehicle may require service. The light should come on to show that it is working when the ignition is on and the engine is not running. See *Ignition Positions* ⇨ 192.



Malfunctions are often indicated by the system before any problem is noticeable. Being aware of the light and seeking service promptly when it comes on may prevent damage.

### Caution

If the vehicle is driven continually with this light on, the emission control system may not work as well, the fuel economy may be lower, and the vehicle may not run smoothly. This could lead to costly repairs that might not be covered by the vehicle warranty.

### Caution

Modifications to the engine, transmission, exhaust, intake, or fuel system, or the use of replacement tires that do not

(Continued)

**Caution (Continued)**

meet the original tire specifications, can cause this light to come on. This could lead to costly repairs not covered by the vehicle warranty. This could also affect the vehicle's ability to pass an Emissions Inspection/Maintenance test. See *Accessories and Modifications* ⇨ 287.

**If the light is flashing:** A malfunction has been detected that could damage the emission control system and increase vehicle emissions. Diagnosis and service may be required.

To help prevent damage, reduce vehicle speed and avoid hard accelerations and uphill grades. If towing a trailer, reduce the amount of cargo being hauled as soon as possible.

If the light continues to flash, find a safe place to park. Turn the vehicle off and wait at least 10 seconds before restarting the engine. If the light is still flashing, follow the previous guidelines and see your dealer for service as soon as possible.

**If the light is on steady:** A malfunction has been detected. Diagnosis and service may be required.

Check the following:

- If fuel has been added to the vehicle using the capless funnel adapter, make sure that it has been removed. See “Filling the Tank with a Portable Gas Can” under *Filling the Tank* ⇨ 277. The diagnostic system can detect if the adapter has been left installed in the vehicle, allowing fuel to evaporate into the atmosphere. A few driving trips with the adapter removed may turn off the light.
- Poor fuel quality can cause inefficient engine operation and poor driveability, which may go away once the engine is warmed up. If this occurs, change the fuel brand. It may require at least one full tank of the proper fuel to turn the light off. See *Recommended Fuel (LSY 2.0L I4 Engine)* ⇨ 275 *Recommended Fuel (LGY 3.0L V6 and LT4 6.2L V8 Engines)* ⇨ 276.

If the light remains on, see your dealer.

**Emissions Inspection and Maintenance Programs**

If the vehicle requires an Emissions Inspection/Maintenance test, the test equipment will likely connect to the vehicle's Data Link Connector (DLC).

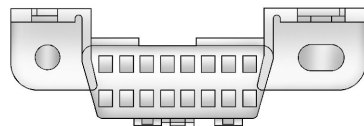

The DLC is under the instrument panel to the left of the steering wheel. Connecting devices that are not used to perform an Emissions Inspection/Maintenance test or to service the vehicle may affect vehicle operation. See *Add-On Electrical Equipment* ⇨ 285. See your dealer if assistance is needed.

The vehicle may not pass inspection if:

- The light is on when the engine is running.
- The light does not come on when the ignition is on while the engine is off.
- Critical emission control systems have not been completely diagnosed. If this happens, the vehicle would not be ready

for inspection and might require several days of routine driving before the system is ready for inspection. This can happen if the 12-volt battery has recently been replaced or run down, or if the vehicle has been recently serviced.

See your dealer if the vehicle will not pass or cannot be made ready for the test.

## Brake System Warning Light



BRAKE

Metric

English

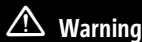

Warning

The brake system might not be working properly if the brake system warning light is on. Driving with the brake system warning light on can lead to a crash. If the light is still on after the vehicle has been pulled off the road and carefully stopped, have the vehicle towed for service.

This light comes on briefly when the vehicle is turned on to show that the light is working. If it does not come on then, have it fixed so it will be ready to warn you if there is a problem.

If the light comes on and stays on, there is a brake problem. Have the brake system inspected right away. This light may come on if the brake fluid is low. See *Brake Fluid* ⇨ 311.

If the light comes on while driving, pull off the road and stop carefully. The brake system has electric brake boost. Vehicle speed may be limited when the brake system warning light comes on. The brake pedal might be harder to push, or the brake pedal may go closer to the floor. It could take longer to stop. If the light is still on, have the vehicle towed for service. See *Transporting a Disabled Vehicle* ⇨ 352.

## Electric Parking Brake Light



PARK

Metric

English

This light comes on when the parking brake is applied. If the light continues flashing after the parking brake is released, or while driving, there is a problem with the Electric Parking Brake system. A message may also display in the Driver Information Center (DIC).

If the light does not come on, or remains flashing, see your dealer.

## Service Electric Parking Brake Light



This light should come on briefly when the vehicle is turned on. If it does not come on, have it fixed so it will be ready to warn if there is a problem.

If this light stays on or comes on while driving, there is a problem with the Electric Parking Brake (EPB). Take the vehicle to a dealer as soon as possible. In addition to the parking brake, other safety functions that utilize the



EPB may also be degraded. A message may also display in the Driver Information Center (DIC). See *Electric Parking Brake* ⇨ 208.

## Antilock Brake System (ABS) Warning Light



This light comes on briefly when the vehicle is turned on to show that the light is working. If it does not come on then, have it fixed so it will be ready to warn you if there is a problem.

If the ABS warning light stays on, or comes on again while driving, the vehicle needs service. A chime may also sound when the light stays on.

If the ABS warning light is the only light on, the vehicle has regular brakes, but ABS is not functioning.

If both the ABS warning light and the brake system warning light are on, ABS is not functioning and there is a problem with the regular brakes. See your dealer for service.

See *Brake System Warning Light* ⇨ 103.

## Performance Shifting Light



If equipped, this light may display green when Sport Mode is activated and certain driving conditions are met. Sport Mode detects when the vehicle is being driven in a competitive manner, and adjusts the shifting of the gears accordingly. See *Driver Mode Control* ⇨ 211.

## All-Wheel-Drive Light



All-Wheel-Drive  
Light



Front-Wheel-Drive  
Light

If equipped, the corresponding light comes on when an All-Wheel Drive (AWD) mode or Front-Wheel-Drive mode is selected. See *All-Wheel Drive* ⇨ 207.

If the light turns amber, there may be a malfunction. See your dealer.

## Automatic Vehicle Hold (AVH) Light



If equipped, this light comes on when AVH is turned on and turns green when AVH is actively holding the vehicle. See *Automatic Vehicle Hold (AVH)* ⇨ 209.

## Lane Keep Assist (LKA) Light



If equipped, the Lane Keep Assist Light may display the following colors:

- Blank: LKA is disabled.
- White: Appears when the vehicle starts. A steady white light indicates that LKA is not ready to assist.
- Green: Appears when LKA is turned on and ready to assist. LKA will gently turn the steering wheel if the vehicle approaches a detected lane marking.
- Amber: Appears when LKA is active. The light flashes amber as a Lane Departure Warning (LDW) alert to indicate that the lane marking has been unintentionally crossed. If the system detects you are steering intentionally (to pass or change lanes), the LDW alert may not display. If equipped, the amber light also appears when the Blind Zone Steering Assist detects

a potential crash with a moving vehicle in the lane you are entering. See *Blind Zone Steering Assist (BZSA)* ⇨ 268.

LKA will not assist or alert if the turn signal is active in the direction of lane departure, or if LKA detects that you are accelerating, braking, or actively steering. See *Lane Keep Assist (LKA)* ⇨ 272.

## Automatic Emergency Braking (AEB) Disabled Light



This indicator displays when you turn off Automatic Emergency Braking (AEB) or Front Pedestrian Braking (FPB).

This indicator will also display if AEB or FPB is unavailable due to malfunction, weather conditions, or if the windshield is not clean.

See *Automatic Emergency Braking (AEB)* ⇨ 261.

See *Front Pedestrian Braking (FPB) System* ⇨ 264.

## Vehicle Ahead Indicator



If equipped, this indicator will display green when a vehicle is detected ahead and amber when you are following a vehicle ahead much too closely.

See *Forward Collision Alert (FCA) System* ⇨ 259.

## Pedestrian Ahead Indicator



If equipped, this indicator will display amber when a nearby pedestrian is detected in front of the vehicle.

See *Front Pedestrian Braking (FPB) System* ⇨ 264.

## Traction Off Light



This light comes on briefly when the vehicle is turned on to show that the light is working. If it does not come on then, have it fixed so it will be ready to warn you if there is a problem.

The traction off light comes on when the Traction Control System (TCS) has been turned off. If StabiliTrak/Electronic Stability Control (ESC) is turned off, TCS is also turned off. To turn TCS and ESC off and on, see *Traction Control/Electronic Stability Control* ⇨ 210.

If TCS is off, wheel slip during acceleration is not limited unless necessary to help protect the driveline from damage. Adjust driving accordingly.

## Traction Control System (TCS)/ Electronic Stability Control Light



This light comes on briefly when the vehicle is turned on to show that the light is working. If it does not come on then, have it fixed so it will be ready to warn you if there is a problem.

If the light is on and not flashing, the TCS and potentially the StabiliTrak/ESC system are not fully operational and may not assist in maintaining control. Adjust driving accordingly. If the condition persists, see your dealer as soon as possible. A Driver Information Center (DIC) message may display.

The light flashes when the TCS and/or the StabiliTrak/ESC system is actively working.

See *Traction Control/Electronic Stability Control* ⇨ 210.

## Electronic Stability Control (ESC) Off Light



This light comes on briefly when the vehicle is turned on to show that the light is working. If it does not come on then, have it fixed so it will be ready to warn you if there is a problem.

This light comes on when the StabiliTrak/Electronic Stability Control (ESC) system is turned off. If StabiliTrak/ESC is off, the Traction Control System (TCS) is also off. To turn ESC off and on, see *Traction Control/Electronic Stability Control* ⇨ 210.

If ESC and TCS are off, the systems do not assist in controlling the vehicle. Adjust driving accordingly.

## Engine Coolant Temperature Warning Light



### Caution

The engine coolant temperature warning light indicates that the vehicle has overheated. Driving with this light on can damage the engine and it may not be covered by the vehicle warranty. See *Engine Overheating* ⇨ 306.

On some vehicles this light comes on briefly while starting the vehicle. If it does not, have the vehicle serviced by the dealer. If the system is working normally the indicator light goes off. For vehicles with the reconfigurable cluster, this light may not come on when starting the vehicle.

The engine coolant temperature warning light comes on when the engine has overheated.

If this happens pull over and turn off the engine as soon as possible. See *Engine Overheating* ⇨ 306.

## Driver Mode Control Light



This light comes on when Sport mode is selected.



This light comes on when Track Mode is selected.



This light comes on when Snow/Ice Mode is selected.



If equipped, this light comes on when V Mode is selected.



This light comes on when My Mode is selected. See *Driver Mode Control* ⇨ 211.

## Performance Traction Management Light

If equipped, when Performance Traction Management (PTM) is activated, one of the following lights display to show the current PTM mode. See “Competitive Driving Mode” under *Performance Driving* ⇨ 217.



This light comes on when Wet Mode is selected.



This light comes on when Dry Mode is selected.



This light comes on when Sport Mode is selected.



This light comes on when Race 1 Mode is selected.



This light comes on when Race 2 Mode is selected.

### Tire Pressure Light



If equipped with the Tire Pressure Monitor System (TPMS), this light comes on briefly when the vehicle is started. It provides information about tire pressures and the TPMS.

#### When the Light Is On Steady

This indicates that one or more of the tires are significantly underinflated.

A Driver Information Center (DIC) tire pressure message may also display. Stop as soon as possible, and inflate the tires to the pressure value shown on the Tire and Loading Information label. See *Tire Pressure* ⇨ 331.

#### When the Light Flashes First and Then Is On Steady

If the light flashes for about a minute and then stays on, there may be a problem with the TPMS. If the problem is not corrected, the light will come on every time the vehicle is started. See *Tire Pressure Monitor Operation* ⇨ 334.

## Engine Oil Pressure Light

### Caution

Driving the vehicle with low engine oil pressure can damage the engine and the repairs would not be covered by the vehicle warranty.

If the engine oil pressure light comes on while driving:

1. Stop in a safe location and turn off the engine.
2. Check the oil level. See *Engine Oil* ⇨ 295.
3. Add oil if the oil level is below the normal operating range.
4. Restart the vehicle. If the engine oil pressure light stays on for more than 10 seconds, turn the vehicle back off. Do not restart the vehicle. See your dealer for service.



This light should come on briefly when the engine starts. When the engine is off and the vehicle is on, the light should remain illuminated. If it does not come on under either condition, contact your dealer.

If the light comes on and stays on when the engine is running, it may not have adequate oil pressure. The oil level may be low or there may be some other oil system problem. Turn the engine off when it is safe to do so and contact your dealer.

## Low Fuel Warning Light



A Low Fuel Warning Light near the fuel gauge comes on briefly when the ignition is turned on as a check to show it is working.

It also comes on when the fuel gauge indicator nears empty. The light turns off when fuel is added. If it does not, have the vehicle serviced.

## Auto Stop Indicator



This light comes on when the engine is in an Auto Stop.

See *Stop/Start System* ⇨ 195.

## Security Light



The security light should come on briefly as the vehicle is started. If it does not come on, have the vehicle serviced by your dealer. If the system is working normally, the indicator light turns off.

If the light stays on and the vehicle does not start, there could be a problem with the theft-deterrent system.

## High-Beam On Light



This light comes on when the high-beam headlamps are in use. See *Headlamp High/Low-Beam Changer* ⇨ 125.

## IntelliBeam Light



If equipped, this light comes on when the IntelliBeam system is enabled. See *Exterior Lamp Controls* ⇨ 124.

## Adaptive Forward Lighting (AFL) Light



If equipped, this light comes on solid when there is a problem with the AFL system.

See *Exterior Lamp Controls* ⇨ 124.

## Lamps On Reminder



This light comes on when the exterior lamps are in use, except when only the Daytime Running Lamps (DRL) are active. See *Exterior Lamp Controls* ⇨ 124.

## Cruise Control Light



If equipped, the cruise control light is white when the cruise control is on and ready, and turns green when the cruise control is set and active.

The light turns off when the cruise control is turned off. See *Cruise Control* ⇨ 221.

## Adaptive Cruise Control Light



If equipped, this light is white when the Adaptive Cruise Control (ACC) is on and ready, and turns green when the ACC is set and active.

### Curve Speed Control Light



If equipped, this light may illuminate green when ACC is actively controlling the vehicle speed and detects a sharp curve on the road ahead.

ACC automatically slows the vehicle down while navigating the curve and may increase speed out of the curve, but will not exceed the set speed.

See *Adaptive Cruise Control (Advanced)* ⇨ 225.

### Super Cruise Light



If equipped, this light comes on to show the status of Super Cruise. See *Super Cruise* ⇨ 235.

### Driver Attention Assist Light



If equipped, this light displays amber when:

- Drowsiness assistance is not available
- Driver Attention Assist has been disabled

See *Driver Attention Assist* ⇨ 270.

### Door Ajar Light



This light comes on when a door is open or not securely latched. Before driving, check that all doors are properly closed.

## Information Displays

### Driver Information Center (DIC)

The DIC is displayed in the instrument cluster. It shows the status of many vehicle systems.

DIC information is broken down into three main zones:

**Control Panel:** A touchscreen display to left of the instrument cluster.

**Left Zone:** Displays on the instrument cluster to the left of the speedometer.

**Right Zone:** Displays on the instrument cluster to the right of the speedometer.



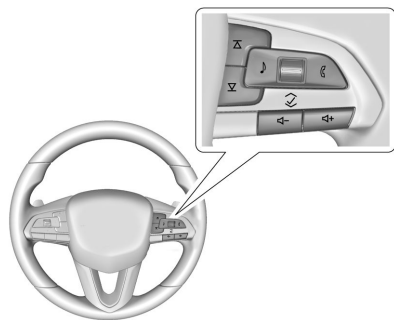

▲ or ▼ : Use the thumbwheel to scroll to the previous or next selection.

✓ : Press the thumbwheel to open a menu or select a menu item. Press and hold to reset certain displays.

### DIC Information Display Options

Select which info display to view by selecting Add to Driver Display in the Vehicle Status on the infotainment display. See *Vehicle Status* ⇨ 115.

### DIC Information Displays

The following is the list of all possible DIC information displays and their locations. Some of the information displays may not be available for your particular vehicle.

#### Control Panel

**Trip Information:** Trip 1 or 2 displays the current distance traveled, in either kilometers (km) or miles (mi), since the trip odometer was last reset. To reset the current trip, touch and hold the touchscreen display when trip odometer is displayed.

The Average Fuel Economy display shows the approximate average liters per 100 kilometers (L/100 km), kilometers per liter (km/L), or miles per gallon (mpg). This number is calculated based on the number of L/100 km (mpg) or km/L recorded since the last time this menu item was reset. This number reflects only the approximate average fuel economy that the vehicle has right now, and will change as driving conditions change. The Average Fuel Economy can be reset along with the trip odometer by touching and holding the touchscreen display when trip odometer is displayed.

**Current Trip:** Displays distance driven and fuel economy since vehicle startup. It resets when you turn your vehicle off.

**Fuel Economy:** Displays average fuel economy, the best fuel economy over the selected distance, and a bar graph showing instantaneous fuel economy. Values are displayed in liters per 100 kilometers (L/100 km) or miles per gallon (mpg). This number reflects only the approximate fuel economy and changes frequently as driving conditions change. Only the best score can be reset.

The distance for average fuel economy and the best fuel economy can be changed to: 40 km (25 mi), 80 km (50 mi), and 725 km (300 mi).

**Launch Control:** If equipped, the Launch Control display allows the driver to adjust the parameters of the Launch Control System. See *Track Events and Competitive Driving (V-Series and V-Series Blackwing)* ⇨ 176.

**Line Lock:** If equipped, the Line Lock display allows the driver to adjust the parameters of the Line Lock System. See *Track Events and Competitive Driving (V-Series and V-Series Blackwing)* ⇨ 176.

**Drive Summary:** If equipped, displays information in relation to the current drive cycle including Distance Traveled, Average Fuel Economy, Top Speed, and Lateral G-Force. They will reset after the drive cycle is completed.

### Left Zone

**Time/Date:** Displays current date and time information. If equipped, Air Quality information is shown below date and time information. Air Quality shows the measured Particulate Matter (PM2.5), along with the status of the air quality. This indicates how clean or polluted outdoor air is. Higher numbers indicate more pollutants and a greater potential for adverse health effects.

**Tire Pressure:** Displays the approximate pressures of all four tires. Tire pressure is displayed in either kilopascal (kPa) or in pounds per square inch (psi). If the pressure is low, the value for that tire is shown in amber. See *Tire Pressure Monitor System* ⇨ 333 and *Tire Pressure Monitor Operation* ⇨ 334.

**Engine Boost:** If equipped, displays engine manifold pressure relative to ambient air pressure. It will display boost pressure generated by the turbocharging system.

**Output:** Displays current engine power, torque, and boost. The current gear also displays on vehicles equipped with an automatic transmission.

**Vitals:** Displays Oil Pressure, Coolant Temperature, Transmission Fluid Temperature, and Oil Temperature.

**G-Force:** Displays inertial forces being exerted on the vehicle in the lateral (side to side) and vertical (acceleration and braking) direction as numerical values and graphical depictions.

**Handling:** If equipped, displays electronic Limited-Slip Differential (eLSD) information.

Electronic Limited-Slip Differential (eLSD) shows the amount of rear differential coupling when the electronic Limited-Slip Differential (eLSD) is active and functioning during vehicle operation. A reading of 1% is an open differential and 100% is locked. It is normal for the value to make small or large changes due to driving conditions and driver inputs. See *Limited-Slip Differential* ⇨ 221.

**Tires:** If equipped, displays the approximate pressures of all four tires. Tire pressure is displayed in either kilopascal (kPa) or in pounds per square inch (psi). If the pressure is low,

the value for that tire is shown in amber. See *Tire Pressure Monitor System* ⇨ 333 and *Tire Pressure Monitor Operation* ⇨ 334.

If equipped, Tire Temperature is located above the tire pressure graphic. Tire Temperature shows overall temperature as either Cold, Cool, Normal, Warm, or Hot. Normal is typical for normal driving while Warm is typical for spirited driving. Unknown displays when tire temperature information is unavailable.

If equipped, Brake Temperature is located below the tire pressure graphic. Brake Temperature shows overall temperature as either Normal, Warm, Hot, or Overheated. Normal is typical for normal driving while Warm is typical for spirited driving. Unknown may be displayed if tire temperature information is unavailable.

**Battery Voltage:** Displays the current battery voltage.

**Oil Life:** Displays an estimate of the remaining oil life. If REMAINING OIL LIFE 99% is displayed, that means 99% of the current oil life remains.

When the remaining oil life is low, the CHANGE ENGINE OIL SOON message will appear on the display. The oil should be changed as soon as possible. See *Engine Oil* ⇨ 295. In addition to the

engine oil life system monitoring the oil life, additional maintenance is recommended. See *Maintenance Schedule* ⇨ 365.

The Oil Life display must be reset after each oil change. It will not reset itself. Do not reset the Oil Life display at any time other than when the oil has just been changed. It cannot be reset accurately until the next oil change. To reset, see *Engine Oil Life System* ⇨ 297.

**Brake Pad Life:** Displays an estimate of the remaining life of the front and rear brake pads. Messages are displayed based on brake pad wear and the state of the system. Reset the Brake Pad Life display after replacing the brake pads. See *Brake Pad Life System (If Equipped)* ⇨ 310.

**Engine Air Filter Life:** Displays an estimate of the remaining engine air filter life and the state of the system. Engine Air Filter Life 95% means 95% of the current air filter life remains. Messages are displayed based on the engine air filter life and the state of the system. When the REPLACE AT NEXT OIL CHANGE message displays, the engine air filter should be replaced at the time of the next oil change. When the REPLACE NOW message displays, the engine air filter should be replaced as soon as possible. To reset, see *Engine Air Filter Life System* ⇨ 299.

**Fuel Economy:** Displays information about current and average fuel economy.

**Oil Pressure:** Displays the engine oil pressure in kPa (kilopascals) or psi (pounds per square inch).

**Engine Hours:** Displays the total number of hours the engine has run.

**Coolant Temperature:** Displays the temperature of the coolant in either degrees Celsius (°C) or degrees Fahrenheit (°F).

**Transmission Fluid Temperature:** Displays the temperature of the automatic transmission fluid in either degrees Celsius (°C) or degrees Fahrenheit (°F).

**Oil Temperature:** Displays the current oil temperature in either degrees Celsius (°C) or degrees Fahrenheit (°F).

**Auto Lane Change:** Displays the status of a driver-requested lane change when Super Cruise is active. See *Super Cruise* ⇨ 235.

**Driver Assistance:** If equipped, displays information for Super Cruise, Adaptive Cruise Control (ACC), Lane Keep Assist (LKA), and Forward Collision Alert (FCA).

**Launch Coach:** If equipped, displays instructional messages and dynamic gauges reflecting brake and throttle pedal positions. See *Track Events and Competitive Driving (V-Series and V-Series Blackwing)* ⇨ 176.

**Line Lock:** If equipped, displays instructional messages and dynamic gauges reflecting brake and throttle pedal positions. See *Track Events and Competitive Driving (V-Series and V-Series Blackwing)* ⇨ 176.

### Right Zone

**Audio Now Playing:** Displays the actively playing audio.

**Phone:** Displays a variety of call information.

**Navigation:** Displays a variety of navigation information.

**Performance Timer:** If equipped, displays the current and best times achieved during acceleration.

To reset the best time or set a custom timer, highlight the selection on the performance timer menu and press the thumbwheel.

## Vehicle Status

To access the menu select the Vehicle Status icon from the infotainment home screen. Vehicle status content is grouped together and shown on the infotainment display.

Selecting vehicle status content on the infotainment display shows the available options. Follow any message or alerts that may display. Some options may be unavailable while driving.

Touch Add to Driver Display to send the desired content to the Driver Information Center (DIC) on the instrument cluster. Touch Remove from Display to remove the selected content from the instrument cluster. See *Driver Information Center (DIC)* ⇨ 111.

## Options

The following is the list of all possible vehicle status content and location. Some but not all of the content and options may be available for your particular vehicle. Group names used may vary based on your vehicle.

## Overview

Displays an interactive image of your vehicle that shows performance and health information.

## Maintenance

**Tire Pressure:** Displays the approximate pressures of all four tires. Tire pressure is displayed in either kilopascal (kPa) or in pounds per square inch (psi). If the pressure is low, the value for that tire is shown in amber. See *Tire Pressure Monitor System* ⇨ 333 and *Tire Pressure Monitor Operation* ⇨ 334.

The following options may be chosen: Relearn Tire Pressure, and Add to Driver Display.

**Brake Pad Life:** Displays an estimate of the remaining life of the front and rear brake pads. Messages are displayed based on brake pad wear and the state of the system.

The following options may be chosen: Turn Off/On, Reset Front Brake Pads, Reset Rear Brake Pads, and Add to Driver Display. Reset the Brake Pad Life after replacing the brake pads. See *Brake Pad Life System (If Equipped)* ⇨ 310.

**Oil Life:** Displays an estimate of the remaining oil life. If REMAINING OIL LIFE 99% is displayed, that means 99% of the current oil life remains.

When the remaining oil life is low, the CHANGE ENGINE OIL SOON message will appear on the display. The oil should be changed as soon as possible. See *Engine Oil* ⇨ 295. In addition to the engine oil life system monitoring the oil life, additional maintenance is recommended. See *Maintenance Schedule* ⇨ 365.

The following options may be chosen: Reset, and Add to Driver Display. The Oil Life must be reset after each oil change. It will not reset itself. Do not reset the Oil Life display at any time other than when the oil has just been changed. It cannot be reset accurately until the next oil change. To reset, see *Engine Oil Life System* ⇨ 297.

**Engine Air Filter Life:** Displays an estimate of the remaining engine air filter life and the state of the system. Engine Air Filter Life 95% means 95% of the current air filter life remains. Messages are displayed based on the engine air filter life and the state of the system. When the REPLACE AT NEXT OIL CHANGE message displays, the engine air filter should be replaced at the time of the next oil change. When the REPLACE NOW message displays, the engine air filter should be replaced as soon as possible.

The Air Filter Life display must be reset after the engine air filter replacement. To reset, see *Engine Air Filter Life System* ⇨ 299.

The following options may be chosen: Turn Off/On, Reset, and Add to Driver Display.

### Gauges (Except V-Series)

**Battery Voltage:** Displays the current battery voltage.

Add to Driver Display may be chosen.

**Coolant Temperature:** Displays the temperature of the coolant in either degrees Celsius (°C) or degrees Fahrenheit (°F).

Add to Driver Display may be chosen.

**Transmission Fluid Temperature:** Displays the temperature of the automatic transmission fluid in either degrees Celsius (°C) or degrees Fahrenheit (°F).

Add to Driver Display may be chosen.

**Oil Pressure:** Displays the engine oil pressure in kPa (kilopascals) or psi (pounds per square inch).

Add to Driver Display may be chosen.

### Fuel Economy

Displays average fuel economy, the best fuel economy over the selected distance, and a bar graph showing instantaneous fuel economy. Values are displayed in liters per 100 kilometers (L/100 km) or miles per gallon (mpg). This number reflects only the approximate fuel economy and changes frequently as driving conditions change. Only the best score can be reset.

If the vehicle is equipped with an Active Fuel Management indicator, the engine operating mode will be shown in this display.

The following options may be chosen: Change Distance, Reset Best Score, and Add to Driver Display. The distance for average fuel economy and the best fuel economy can be changed to: 40 km (25 mi), 80 km (50 mi), and 725 km (300 mi).

### Air Quality

Displays the measured Particulate Matter (PM<sub>2.5</sub>), along with the status of the air quality. This indicates how clean or polluted outdoor air is. Higher numbers indicate more pollutants and a greater potential for adverse health effects. When Air Quality Index numbers are high, close your vehicle's windows and doors,

set your climate system to Auto, and turn on air recirculation. Air Quality Index displays all of the possible measurement ranges, along with the status that is attributed to those ranges.

The following options may be chosen: Air Quality Index, and Add to Driver Display.

### Engine & Battery (V-Series Only)

**Battery Voltage:** Displays the current battery voltage.

Add to Driver Display may be chosen.

**Engine Hours:** Displays the total number of hours the engine has run.

Add to Driver Display may be chosen.

**Fuel Economy:** Displays average fuel economy, the best fuel economy over the selected distance, and a bar graph showing instantaneous fuel economy. Values are displayed in liters per 100 kilometers (L/100 km) or miles per gallon (mpg). This number reflects only the approximate fuel economy and changes frequently as driving conditions change. Only the best score can be reset.

If the vehicle is equipped with an Active Fuel Management indicator, the engine operating mode will be shown in this display.

The following options may be chosen: Change Distance, Reset Best Score, and Add to Driver Display. The distance for average fuel economy and the best fuel economy can be changed to: 40 km (25 mi), 80 km (50 mi), and 725 km (300 mi).

## Head-Up Display (HUD)

If equipped with HUD, certain vehicle information is projected through a lens on top of the instrument panel onto the windshield.

### Warning

If the HUD image is too bright or too high in your field of view, it may take you more time to see things you need to see when it is dark outside. Be sure to keep the HUD image dim and placed low in your field of view.

### Caution

If you try to use the HUD image as a parking aid, you may misjudge the distance and damage your vehicle. Do not use the HUD image as a parking aid.

The HUD information can be displayed in various languages. The speedometer reading and other numerical values can be displayed in either English or metric units.

The language selection and the units of measurement are changed through the infotainment screen. See *Settings* ⇨ 159.

Depending on how the vehicle is equipped, the HUD may display the following vehicle information, messages, or alerts:

- Speed
- Audio
- Phone
- Navigation
- Performance
- Driver Assistance Features
- Vehicle Messages

Some vehicle messages or alerts displayed in the HUD may be cleared by using the steering wheel controls. See *Vehicle Messages* ⇨ 120.

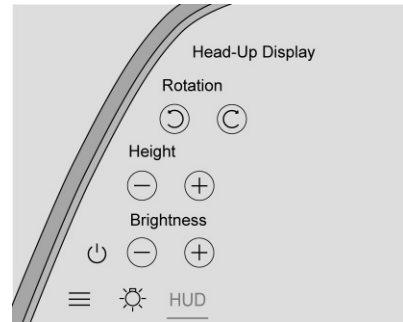

The HUD control is on a touchscreen to the left of the instrument cluster. HUD controls are also available on the infotainment screen. See *Settings* ⇨ 159.

To adjust the HUD image:

1. Adjust the driver seat.
2. Start the vehicle.
3. Select HUD on the touchscreen to the left of the instrument cluster.
4. Use the icons to adjust the HUD as desired.

The HUD image will automatically dim and brighten to compensate for outside lighting. Adjust as needed.

The HUD image can temporarily light up depending on the angle and position of sunlight on the HUD image. This is normal.

Polarized sunglasses can make the HUD image harder to see.

### HUD Options

If equipped, this feature under the HUD Options menu on the infotainment screen allows you to adjust the HUD image. This feature may only be available in P (Park). See *Settings* ↗ 159.

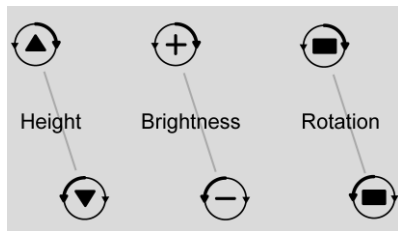

Press the icons above and below to adjust the HUD image.

### HUD Views

There are three views in the HUD. Track mode is available for V-Series and Blackwing models only. Some vehicle information and vehicle messages or alerts are available in all views.

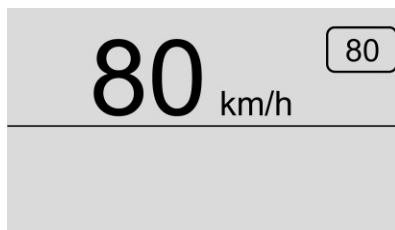

Metric

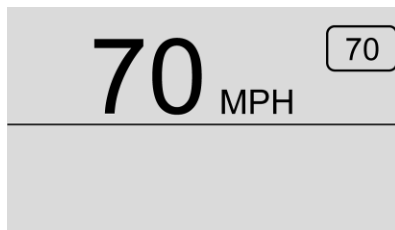

English

**Speed View:** If equipped, displays digital speed in English or metric units, speed limit, vehicle ahead indicator, Lane Departure Warning/Lane Keep Assist, and Adaptive Cruise Control and set speed.

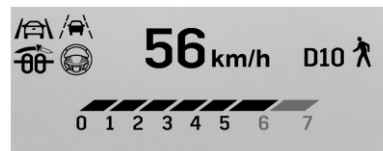

Metric

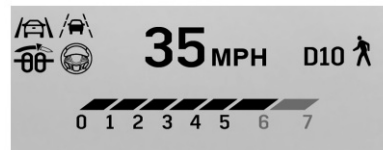

English

**Performance View:** Displays digital speed, indicators from speed view, rpm reading, vehicle ahead indicator, Lane Departure Warning/Lane Keep Assist, and Adaptive Cruise Control and set speed.



Metric



English

**Track View:** If equipped, displays digital speed, transmission positions, Shift Timing Light Position, and gear shift indicator.

The shift timing lights at the top of the display will appear with increases in engine rpm. The rows of lights get closer together as the shift point gets closer. Shift the transmission before the lights come together in the display. Shift immediately if the lights are flashing. See *Manual Mode* ↻ 203.

### Temporary Overlays

Infotainment: Audio, Phone, and Navigation are temporary overlays linked to cluster layouts.

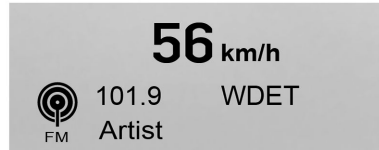

Metric

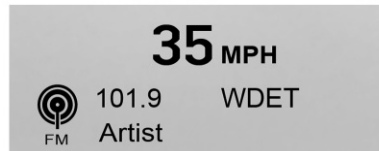

English

**Audio/Phone Overlay:** Displays digital speed for Tour/Sport, current gear for Track, indicators from speed view, audio/phone information, vehicle ahead indicator, Lane Departure Warning/Lane Keep Assist, and

Adaptive Cruise Control and set speed. The current radio station, media type, and incoming calls will be displayed.

All HUD views may briefly display audio information when the driver uses the steering wheel controls to adjust the audio settings appearing in the instrument cluster.

Incoming phone calls appearing in the instrument cluster may also display in any HUD view.

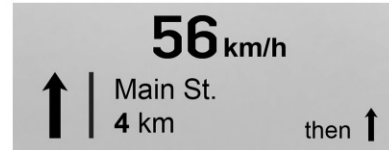

Metric

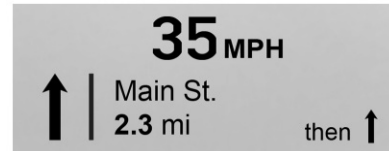

English



**Navigation Overlay:** If equipped, displays digital speed for Tour/Sport, current gear for Track, indicators from speed view, turn-by-turn navigation information, vehicle ahead indicator, Lane Departure Warning/Lane Keep Assist, and Adaptive Cruise Control and set speed. The compass heading is displayed when navigation routing is not active.

Navigation turn-by-turn alerts shown in the instrument cluster may also be displayed in any HUD view.

### Care of the HUD

Clean the inside of the windshield to remove any dirt or film that could reduce the sharpness or clarity of the HUD image.

Clean the HUD lens with a soft cloth sprayed with glass cleaner. Wipe the lens gently, then dry it.

### HUD Troubleshooting

If you cannot see the HUD image when the vehicle is on, ensure that:

- Nothing is covering the HUD lens.
- The HUD brightness setting is not too dim or too bright.

- The HUD is adjusted to the proper height and rotation.
- You are not wearing polarized sunglasses.
- The windshield and HUD lens are clean.

If you continue to experience problems with the HUD, contact your dealer.

The windshield is part of the HUD system. See *Windshield Replacement* ⇨ 314.

## Vehicle Messages

Messages displayed on the Driver Information Center (DIC) indicate the status of the vehicle or some action that may be needed to correct a condition. Multiple messages may appear one after another.

Vehicle status notifications are also sent to the infotainment display. Touching  on the infotainment home screen displays active vehicle messages. Depending on the message, you can schedule a service or find the nearest dealer. When there are active messages that can be viewed, a red dot appears on top of the notification icon on the infotainment display.

The messages that do not require immediate action can be acknowledged and cleared by pressing ✓. The messages that require immediate action cannot be cleared until that action is performed.

All messages should be taken seriously; clearing the message does not correct the problem.

If a SERVICE message appears, see your dealer.

Follow the instructions given in the messages. The system displays messages regarding the following topics:

- Service Messages
- Fluid Levels
- Vehicle Security
- Brakes
- Ride Control Systems
- Advanced Driver Assistance Systems
- Cruise Control
- Lighting and Bulb Replacement
- Wiper/Washer Systems
- Doors and Windows
- Seat Belts

- Airbag Systems
- Engine and Transmission
- Tire Pressure
- Battery
- Steering

## Engine Power Messages

### REDUCED ACCELERATION DRIVE WITH CARE

This message displays when the vehicle's propulsion power is reduced. A reduction in propulsion power can affect the vehicle's ability to accelerate. If this message is on, but there is no observed reduction in performance, proceed to your destination. Under certain conditions the performance may be reduced the next time the vehicle is driven. The vehicle may be driven while this message is on, but maximum acceleration and speed may be reduced. Anytime this message stays on, or displays repeatedly, the vehicle should be taken to your dealer for service as soon as possible.

Under certain operating conditions, propulsion will be disabled. Try restarting after the ignition has been off for two minutes.

## Vehicle Speed Messages

### SPEED LIMITED TO XXX KM/H (MPH)

This message shows that the vehicle speed has been limited to the speed displayed. The limited speed is a protection for various propulsion and vehicle systems, such as lubrication; thermal; brakes; suspension; Teen Driver, if equipped; or tires.

## Universal Remote System

See *Radio Frequency Statement* ⇨ 387.

### Universal Remote System Programming

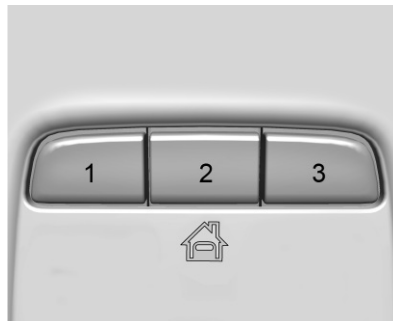

If equipped, these buttons are in the overhead console.

This system can replace up to three remote control transmitters used to activate devices such as garage door openers, security systems, and home automation devices. These instructions refer to a garage door opener, but can be used for other devices.

Do not use the Universal Remote system with any garage door opener that does not have the stop and reverse feature. This includes any garage door opener model manufactured before April 1, 1982.

Keep the original hand-held transmitter for use in other vehicles as well as for future programming. Erase the programming when vehicle ownership is terminated. See “Erasing Universal Remote System Buttons” later in this section.

To program a garage door opener, park outside directly in line with and facing the garage door opener receiver. Clear all people and objects near the garage door.

Make sure the hand-held transmitter has a new battery for quick and accurate transmission of the radio-frequency signal.

## Programming the Universal Remote System

Programming involves time-sensitive actions and may time out, requiring the procedure to be repeated. Read these instructions completely before programming the Universal Remote system. It may help to have another person assist with the programming process.

1. Hold the end of the hand-held transmitter about 3 to 8 cm (1 to 3 in) away from the Universal Remote system buttons with the indicator light in view. The hand-held transmitter was supplied by the manufacturer of the garage door opener receiver.
2. At the same time, press and hold both the hand-held transmitter button and one of the three Universal Remote system buttons to be used to operate the garage door. Do not release either button until the indicator light changes from a slow to a rapid flash or continuous light. Then release both buttons.

Some garage door openers may require substitution of Step 2 with the procedure under “Radio Signals for Some Gate Operators” later in this section.

3. Press and hold the newly programmed Universal Remote system button for five seconds while watching the indicator light and garage door activation.

- If the indicator light stays on continuously or the garage door moves when the button is pressed, then programming is complete. There is no need to complete Steps 4–6.
- If the indicator light does not come on or the garage door does not move, a second button press may be required. For a second time, press and hold the newly programmed button for five seconds. If the indicator light stays on continuously or the garage door moves when the button is pressed, then programming is complete. There is no need to complete Steps 4–6.
- If the garage door does not move, continue with programming Steps 4–6.

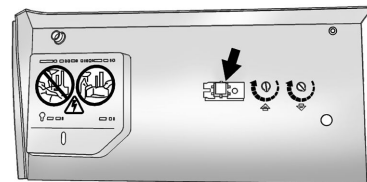

### Learn or Smart Button

4. After completing Steps 1–3, locate the Learn or Smart button inside garage on the garage door opener receiver. The name and color of the button may vary by manufacturer.
5. Press and release the Learn or Smart button. Step 6 must be completed within 30 seconds of pressing this button.
6. Return to the vehicle and firmly press and hold the trained Universal Remote system button for two seconds and release. Repeat the “press/hold/release” sequence up to three times to complete the training process.

The Universal Remote system should now activate the garage door. Repeat the process for programming the remaining two buttons.

For questions or programming help, visit [www.homelink.com/gm](http://www.homelink.com/gm) or call 1-800-355-3515. For calls placed outside the U.S., Canada, or Puerto Rico, international rates will apply and may differ based on landline or mobile phone.

### **Radio Signals for Some Gate Operators**

Some gate operators and radio-frequency laws require transmitter signals to time out or quit after several seconds of transmission. This may not be long enough for the Universal Remote system to pick up the signal during programming.

If the programming did not work, replace Step 2 under “Programming the Universal Remote System” with the following:

Press and hold the Universal Remote system button while pressing and releasing the hand-held transmitter button every two seconds until the signal has been successfully accepted by the Universal Remote system. The Universal Remote system indicator light will flash slowly at first and then change to a rapid flash or continuous solid-light. Proceed with Step 3 under “Programming the Universal Remote System” to complete.

## **Universal Remote System Operation**

### **Using the Universal Remote System**

Press and hold the appropriate Universal Remote system button for at least one-half second. The indicator light will come on while the signal is being transmitted.

### **Erasing Universal Remote System Buttons**

Erase all programmed buttons when vehicle ownership is terminated.

To erase:

1. Press and hold the two outside buttons until the indicator light begins to flash. This should take about 10 seconds.
2. Release both buttons.

### **Reprogramming a Single Universal Remote System Button**

To reprogram any of the system buttons:

1. Press and hold any one of the buttons. Do not release the button.

2. The indicator light will begin to flash after 20 seconds. Without releasing the button, proceed with Step 1 under “Programming the Universal Remote System.”

## Lighting

### Exterior Lighting

Exterior Lamp Controls .....	124
Exterior Lamps Off Reminder .....	125
Headlamp High/Low-Beam Changer .....	125
Flash-to-Pass .....	126
Daytime Running Lamps (DRL) .....	126
Automatic Headlamp System .....	126
Adaptive Forward Lighting (AFL) .....	126
Headlamp Leveling Control .....	128
Hazard Warning Flashers .....	128
Turn and Lane-Change Signals .....	128
Cornering Lamps .....	128

### Interior Lighting

Instrument Panel Illumination Control ....	129
Courtesy Lamps .....	129
Dome Lamps .....	129
Reading Lamps .....	129

### Lighting Features

Entry Lighting .....	130
Exit Lighting .....	130
Ambient Lighting .....	131
Battery Load Management .....	132
Battery Power Protection .....	132
Exterior Lighting Battery Saver .....	132



## Exterior Lighting

### Exterior Lamp Controls



The exterior lamp control is on the turn signal lever.

Turn the control to the following positions:

 : Turns the exterior lamps off and deactivates the AUTO mode. Turn to  again to reactivate the AUTO mode.

In Canada, the headlamps will automatically reactivate when the vehicle is shifted out of P (Park).

**AUTO:** Automatically turns the exterior lamps on and off, depending on outside lighting.

 : Turns on the parking lamps including all lamps, except the headlamps.

 : Turns on the headlamps together with the parking lamps and instrument panel lights.

### IntelliBeam System



If equipped, this system turns the vehicle's high-beam headlamps on and off according to surrounding traffic conditions.

The system turns the high-beam headlamps on when it is dark enough and there is no other traffic present.

This light  (A) comes on in the instrument cluster when the IntelliBeam system is enabled.

### Turning On and Enabling IntelliBeam



To enable the IntelliBeam system, press  (A) on the turn signal lever when it is dark outside and the exterior lamp control is in AUTO or .



### Driving with IntelliBeam

The system only activates the high beams when driving over 40 km/h (25 mph).

The blue high-beam on light appears on the instrument cluster when the high beams are on.

There is a sensor near the top center of the windshield that automatically controls the system. Keep this area of the windshield clear of debris to allow for best system performance.

The high-beam headlamps remain on, under the automatic control, until one of the following situations occurs:

- The system detects an approaching vehicle's headlamps.
- The system detects a preceding vehicle's taillamps.
- The outside light is bright enough that high-beam headlamps are not required.
- The vehicle's speed drops below 20 km/h (12 mph).
- The IntelliBeam system is disabled by the button on the turn signal lever. If this happens, press  on the turn signal lever when the exterior lamp control is in the AUTO or  position to reactivate the

IntelliBeam system. The instrument cluster light will come on to indicate the IntelliBeam system is reactivated.

The high beams may not turn off automatically if the system cannot detect another vehicle's lamps because of any of the following:

- The other vehicle's lamps are missing, damaged, obstructed from view, or otherwise undetected.
- The other vehicle's lamps are covered with dirt, snow, and/or road spray.
- The other vehicle's lamps cannot be detected due to dense exhaust, smoke, fog, snow, road spray, mist, or other airborne obstructions.
- The vehicle's windshield is dirty, cracked, or obstructed by something that blocks the view of the light sensor.
- The vehicle is loaded such that the front end points upward, causing the light sensor to aim high and not detect headlamps and taillamps.
- The vehicle is being driven on winding or hilly roads.

The automatic high-beam headlamps may need to be disabled if any of the above conditions exist.

### Exterior Lamps Off Reminder

A warning chime sounds if the driver door is opened while the ignition is off and the exterior lamps are on.

### Headlamp High/Low-Beam Changer

: Push the turn signal lever away from you and release, to turn the high beams on. To return to low beams, push the lever again or pull it toward you and release.



This indicator light turns on in the instrument cluster when the high-beam headlamps are on.

## Flash-to-Pass

To flash the high beams, pull the turn signal lever toward you and release.

## Daytime Running Lamps (DRL)

DRL can make it easier for others to see the front of your vehicle during the day. Fully functional DRL are required on all vehicles first sold in Canada.

If equipped, the DRL will come on when all of the following conditions are met:

- The ignition is on.
- The exterior lamp control is in AUTO.
- The light sensor determines it is daytime.

The DRL turn off when the headlamps are turned to  or the ignition is off.

For vehicles first sold in Canada, the DRL can only be turned off when the vehicle is parked.

## Automatic Headlamp System

When the exterior lamp control is set to AUTO and it is dark enough outside, the headlamps come on automatically.

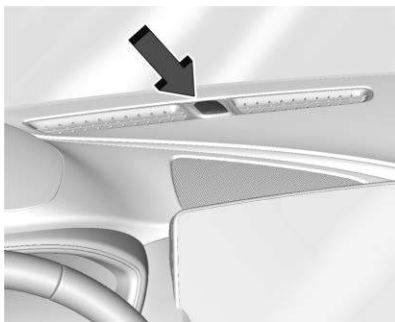

If equipped, the light sensor is on top of the instrument panel or on the windshield near the rearview mirror. Do not cover the sensor, otherwise the headlamps will come on when they are not needed.

The system may also turn on the headlamps when driving through a parking garage or tunnel.



If the vehicle is started in a dark garage, the automatic headlamp system comes on immediately. If it is light outside when the vehicle leaves the garage, there is a slight delay before the automatic headlamp system turns off the headlamps. During that delay, the instrument cluster may not be as bright as usual. Make sure the instrument panel

brightness control is in the full bright position. See *Instrument Panel Illumination Control*  129.

When it is bright enough outside, the headlamps will turn off.

The automatic headlamp system turns off when the exterior lamp control is turned to  or the ignition is off. For vehicles sold in Canada, this control only works when the transmission is in P (Park).

## Lights On with Wipers

If the windshield wipers are activated in daylight with the engine on, and the exterior lamp control is in AUTO, the headlamps, parking lamps, and other exterior lamps come on. The transition time for the lamps coming on varies based on wiper speed. When the wipers are not operating, these lamps turn off. Move the exterior lamp control to  or  to disable this feature.

## Adaptive Forward Lighting (AFL)

If equipped, the AFL system automatically modifies the low-beam lighting patterns to the situation to enable optimal light performance for the driver. Light distribution and intensity

of low-beam light are controlled based on exterior lighting conditions, vehicle location, and driving situations.

To activate AFL, set the exterior lamp control to the Auto position. See *Exterior Lamp Controls* ⇨ 124.

To adjust the AFL setting, go to the infotainment home screen and select Settings > Vehicle > Lighting. Moving the exterior lamp controls out of the Auto position will deactivate the system.

### Town Light

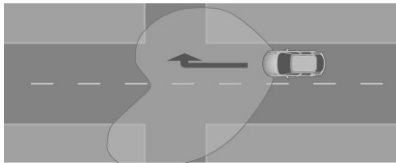

If equipped, the town light activates automatically at a speed up to 55 km/h (34 mph).

The light is wide and symmetrical. The special beam pattern is designed to prevent glare for other road users.

### Country Light

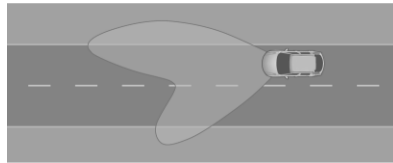

If equipped, the country light activates automatically at a speed above 55 km/h (34 mph).

The illumination of the current lane and the side of the road is improved, reducing glare to oncoming and preceding vehicles.

### Freeway/Motorway Light



If equipped, when driving faster than 90 km/h (55 mph) on freeways, the low-beam illumination is smaller and extended.

### Adverse Weather Light

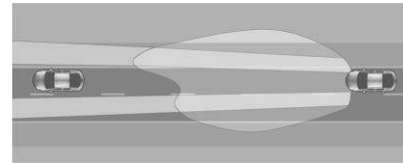

If equipped, the adverse weather light activates automatically when driving in adverse weather conditions (heavy rain, snow, sleet, freezing rain, etc.). The illumination is shifted more to the side of the road to highlight road signs, and reduces glare caused by reflecting of wet roads.

### Maneuvering Light

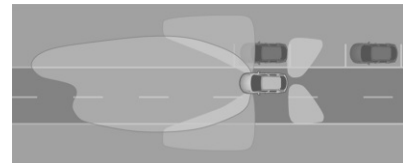

If equipped, the maneuvering light activates automatically at speeds less than 7 km/h (4 mph) when the vehicle is in R (Reverse). The maneuvering light illumination improves parking and maneuvering situations.





## Headlamp Leveling Control

### Automatic Headlamp Leveling

If equipped, the level of the headlamps is adjusted automatically based on the vehicle load and driving conditions. Headlamp aiming is important to safe driving. If the headlamps require aiming or the automatic headlamp leveling system is malfunctioning, see your dealer for service.

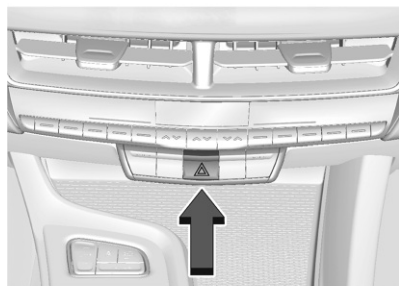
### Hazard Warning Flashers



 : Press this button to make the front and rear turn signal lamps flash on and off. Release the button for at least one second and press again to turn the flashers off.

The hazard warning flashers turn on automatically if the airbags deploy.

### Turn and Lane-Change Signals

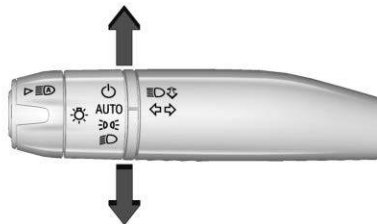

Move the lever all the way up or down to signal a turn.

An arrow on the instrument cluster flashes in the direction of the turn or lane change.

Raise or lower the lever until the arrow starts to flash to signal a lane change. Hold it there until the lane change is completed. If the lever is briefly pressed and released, the turn signal flashes three times.

The turn and lane-change signal can be turned off manually by moving the lever back to its original position.

If after signaling a turn or lane change, the arrow flashes rapidly or does not come on, a signal function may be inoperative. This vehicle may be equipped with LED lighting. For replacement of any LED lighting, contact your dealer.

### Cornering Lamps

If equipped with cornering lamps, they automatically come on when all of the following occur:

- The low-beam headlamps are on.
- The turn signals are activated or the steering wheel is at a turning angle.
- The vehicle speed is below 40 km/h (25 mph).

### Reverse Parking Function

If equipped, when putting the vehicle in R (Reverse) and the headlights are on, the cornering lamps and reverse lamps illuminate. See *Exterior Lamp Controls* ⇨ 124.

## Interior Lighting

### Instrument Panel Illumination Control

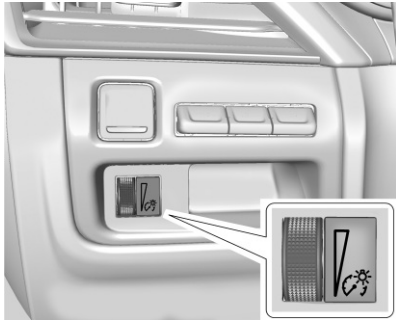

This feature adjusts the brightness of all illuminated controls.

 : Move the thumbwheel up or down to brighten or dim the lights.

The thumbwheel is functional at night, or when the headlamps or parking lamps are ON.

## Courtesy Lamps

The courtesy lamps come on when any door is opened,  on the remote key is pressed, or when the vehicle is turned off. See *Dome Lamps* ⇨ 129.



## Dome Lamps



The dome lamp controls are in the overhead console.

The dome lamps come on when any door is opened,  on the remote key is pressed, or when the vehicle is turned off.

To operate, press the following buttons:

 OFF : Press to turn off the dome lamps. An indicator light on the button will turn on when the dome lamp override is activated. Press  OFF again to deactivate this feature and the indicator light will turn off.

 ON/OFF : Press to turn the dome lamps on or off manually.

## Reading Lamps

There are front and rear reading lamps on the overhead console and over the rear passenger doors. These lamps come on when any door is opened,  on the remote key is pressed, or when the vehicle is turned off.

## Front Reading Lamps

The front reading lamps are on the overhead console.



Press the lamp lenses to manually turn on or off the front reading lamps.

### Rear Reading Lamps

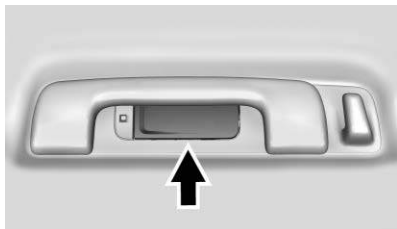

The rear reading lamps are over the rear passenger doors.



Press the lamp lenses to manually turn on or off the rear reading lamps.

## Lighting Features

### Entry Lighting

The interior lamps turn on when pressing  on the remote key or opening any doors, and the dome lamp control is not in the  OFF position.

Some exterior lamps also turn on when pressing  on the remote key or opening any doors. Low-Beam lamps will only turn on briefly at night, or in areas with limited lighting.

All lamps will gradually fade out after about 30 seconds.

Entry lighting can be disabled manually by closing all doors, pressing  on the remote key, or starting the vehicle.

This feature can be changed. On the infotainment home page, select the Setting icon > Vehicle > Vehicle Locator Lights.

### Approach Detection

If equipped, the entry lighting feature will automatically turn on when the remote key is detected within approximately 2 m (6 ft) of the vehicle.

If the vehicle has remained parked for an extended period of time with no remote key use or keyless access operation, approach detection will be disabled. To reactivate, press any button on the remote key or open and close all vehicle doors to re-enable the entry lighting feature on approach.

### Exit Lighting

Some exterior lamps and interior lamps turn on when the driver door is opened after the vehicle is turned off.

The exterior and interior lamps remain on for a set amount of time, then automatically turn off.

The interior lights turn on when the vehicle is turned off.

The exterior lamps turn off immediately by turning the exterior lamp control off.

This feature can be changed. On the infotainment home screen, select Settings > Vehicle > Lighting.

## Ambient Lighting

This feature enables you to customize the color and brightness of the ambient lighting throughout the passenger cabin. On the infotainment home screen, select Ambient Lighting.

To disable or enable the cabin ambient lighting, slide the on-screen toggle to the opposite position.

### Overview

**Styles:** Styles are a series of presets. Swipe the row of boxes to display more choices. Touch a box to change all cabin ambient lighting to the same style.

**Current Lighting:** Touch the effect name to apply it to all cabin ambient lighting.

### Customize



This screen enables selection of different colors and effects for multiple areas of the cabin.

Tap a dot to select which cabin area to change, then select the effect name. Color variants will display. Touch the desired color swatch to apply that color, then touch Confirm to keep the selection.

- Touch Sync to apply the same selection to all cabin areas at once.
- Touch Undo to revert to the previous selection.

To save your set of selections to use another time, touch Save to Styles. To find your custom style, go to the Styles tab and swipe the row of presets.

### Brightness

To customize the brightness of each effect, tap the  or  icons, or drag your finger across the slider bar.

**Sync Brightness:** Select this option to apply the same adjustment to all effects at the same time.

### Styles

Styles are a series of presets for all cabin ambient lighting. Swipe the row of tiles to display more choices. Touch a box to change all cabin ambient lighting to that saved style.

### Modes

**Link to Theme:** This mode assigns a predefined color to ambient lighting based on the theme selected in the infotainment Themes app.

When you select a different theme, the ambient lighting color changes automatically to complement the theme.

When you unlink from a theme, the ambient lighting retains the theme color until you select another color, link to theme again, or link to Drive mode.

**Link to Drive Mode:** This mode enables a predefined set of colors, one for each mode on the Driver Mode Control. When you change modes — for example, from Tour to Sport — the ambient lighting automatically changes to the assigned color.

To unlink from Drive Mode and revert to the default lighting, leave the Modes tab then go back to it. A prompt to unlink will be displayed. Click Unlink to confirm.

**Custom:** This mode enables the selections on the other screens of the Ambient Lighting app.

**Demo Mode:** If equipped, this mode automatically cycles through the available colors and effects. The vehicle must be in P (Park) to use Demo Mode. See *Shifting Into Park*  197.

## Battery Load Management

The vehicle has Electric Power Management (EPM), which estimates the battery's temperature and state of charge. It then adjusts the voltage for best performance and extended life of the battery.

When the battery's state of charge is low, the voltage is raised slightly to quickly bring the charge back up. When the state of charge is high, the voltage is lowered slightly to prevent overcharging. If the vehicle has a voltmeter gauge or a voltage display on the Driver Information Center (DIC), you may see the voltage move up or down. This is normal. If there is a problem, an alert will be displayed.

The battery can be discharged at idle if the electrical loads are very high. This is true for all vehicles. This is because the generator (alternator) may not be spinning fast enough at idle to produce all the power that is needed for very high electrical loads.

A high electrical load occurs when several of the following are on, such as: headlamps, high beams, fog lamps, rear window defogger, climate control fan at high speed, heated seats, engine cooling fans, and loads plugged into accessory power outlets.

EPM works to prevent excessive discharge of the battery. It does this by balancing the generator's output and the vehicle's electrical needs. It can increase engine idle speed to generate more power, whenever needed. It can temporarily reduce the power demands of some accessories.



Normally, these actions occur in steps or levels, without being noticeable. In rare cases at the highest levels of corrective action, this action may be noticeable to the driver. If so, a DIC message might be displayed. If a battery message is displayed, it is recommended that the driver reduce the electrical loads as much as possible. See *Driver Information Center (DIC)* ⇨ 111.

## Battery Power Protection

This feature helps prevent the battery from being drained, if the interior courtesy lamps or reading lamps are accidentally left on. If any of these lamps are left on, they automatically turn off after 10 minutes, if the ignition is off. The lamps will not come back on again until one of the following occurs:

- The ignition is turned on.
- The doors are closed and then re-opened.

## Exterior Lighting Battery Saver

The exterior lamps turn off about 10 minutes after the vehicle is turned off, if the parking lamps or headlamps have been manually left on. This protects against draining the battery. To restart the 10-minute timer, turn the exterior lamp control to the  position and then back to the  or  position.

To keep the lamps on for more than 10 minutes, the vehicle must be on or in accessory mode.

# Infotainment System

## Introduction

Introduction .....	133
Overview .....	134
Steering Wheel Controls .....	135
Using the System .....	136
Software Updates .....	138

## Radio

AM-FM Radio .....	138
Satellite Radio .....	139
Radio Reception .....	140
Multi-Band Antenna .....	140

## Audio Players

Avoiding Untrusted Media Devices .....	141
USB Port .....	141
Bluetooth Audio .....	141

## Navigation

Using the Navigation System .....	141
Maps .....	142
Navigation Symbols .....	143
Destination .....	143
Global Positioning System (GPS) .....	144
Vehicle Positioning .....	144
Problems with Route Guidance .....	145

## Voice Recognition

Voice Recognition .....	145
-------------------------	-----

## Performance Data Recorder (PDR)

Performance Data Recorder (PDR) .....	147
---------------------------------------	-----

## Phone

Bluetooth (Overview) .....	153
Bluetooth (Pairing and Using a Phone) ....	154
Apple CarPlay and Android Auto .....	158

## Settings

Settings .....	159
Teen Driver .....	161

## Trademarks and License Agreements

Trademarks and License Agreements .....	164
---	-----

# Introduction

Read the following pages to become familiar with the features.

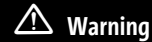

## Warning

Taking your eyes off the road for too long or too often while using any infotainment feature can cause a crash. You or others could be injured or killed. Do not give extended attention to infotainment tasks while driving. Limit your glances at the vehicle displays and focus your attention on driving. Use voice commands whenever possible.

The infotainment system has built-in features intended to help avoid distraction by disabling some features when driving. These features may become disabled on the infotainment home screen when they are unavailable. Many infotainment features are also available through the instrument cluster and steering wheel controls.

Before driving:

- Become familiar with the operation, center stack controls, steering wheel controls, and infotainment display.
- Set up the audio by presetting favorite stations, setting the tone, and adjusting the speakers.
- Set up phone numbers in advance so they can be called easily by pressing a single control or by using a single voice command.

See *Distracted Driving* ⇨ 173.

### Active Noise Cancellation

If equipped, Active Noise Cancellation (ANC) reduces engine noise in the vehicle's interior. ANC requires the factory-installed audio system, radio, speakers, amplifier (if equipped), induction system, and exhaust system to work properly. Deactivation is required by your dealer if related aftermarket equipment is installed.

## Overview

### Infotainment System

The infotainment system is controlled by using the infotainment display, controls on the center console, steering wheel controls, and voice recognition.

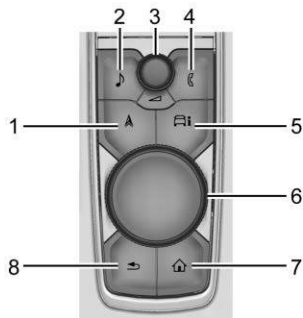

### Infotainment Controls on the Multi-Function Controller (MFC)



#### 1. (Navigation)

- Press to access the navigation screen.

- Press and hold to access the Apple CarPlay or Android Auto Map View, if connected, regardless of active route guidance.
- #### 2. (Radio/Audio)
- Press to open the active audio source page.
  - Press and hold to access the Apple CarPlay or Android Now Playing View, if connected. If the current audio source is the radio, the Apple CarPlay or Android Auto Now Playing View with the audio source plays the radio.
- #### 3. (Power/Volume) Knob
- Press to turn the power on.
  - Press and hold when the system is on to turn the power off and display the time.
  - Press to mute/unmute the system when on.
  - Turn to decrease or increase the volume.
- #### 4. (Phone)

- Press to access the phone menu.
  - Press and hold to access the Apple CarPlay or Android Auto Phone View, if connected.
5.  (Vehicle Information)
    - Press to access the vehicle information.
  6. Primary Knob
    - Turn to highlight a feature. Press to activate the highlighted feature.
    - Move right/left or up/down to change the highlighted area on the display screen.
  7.  (Home Page)
    - Press to access the Home Page. See “Home Page” later in this section.
    - Press and hold to access the Apple CarPlay or Android Auto Phone Home screen, if connected.
  8.  (Back)
    - Press to return to the previous display in a menu.

## Home Page

The Home Page is where vehicle application icons or cards are accessed. Some applications are disabled when the vehicle is moving.

Swipe left or right across the display or use the MFC to move the home page. Move the knob right/left to change the page.

## Managing Home Page Icons/Cards

1. Touch and hold any of the Home Page icons/cards to enter edit mode. Edit mode is not available when the vehicle is moving.
2. Continue holding the icon/card and drag it to the desired position.
3. Release your finger to drop the icon in the desired position.
4. To move an application to another page, drag the icon to the edge of the display toward the desired page. Cards must stay on the first page.
5. Continue dragging and dropping application icons as desired.
6. Application cards on the first page can be replaced, moved or deleted based on user preference while in edit mode.

7. Touch Done to save changes or Cancel to not save and exit edit mode.

There will always be 10 icons per page except on the last page. If an icon is moved from the first page to the second, then that icon from the second page will replace the one removed from the first.

## Steering Wheel Controls

The infotainment steering wheel controls can be used to control the infotainment features displayed in the instrument cluster.

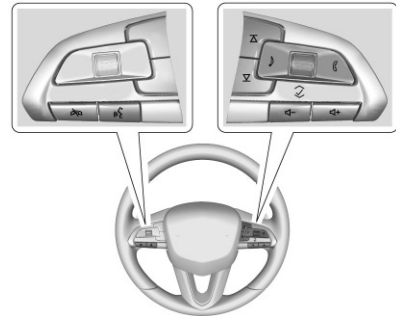

When in Valet Mode, if equipped, access to the infotainment functions is disabled. See “Valet Mode,” under *Settings* ⇨ 159.









: Press to answer an incoming call or start voice recognition. See *Bluetooth (Pairing and Using a Phone)* ⇨ *154 Bluetooth (Overview)* ⇨ 153.

: Press to decline an incoming call or end a current call. Press to mute or unmute the infotainment system when not on a call.

 or : Press to go to the next or previous favorite when listening to the radio. Press to go to the next or previous track when listening to a media source.

: Press to open the audio source list.

: Press to answer an incoming call.

 + or  -: Press to increase or decrease the volume.

## Using the System

### Audio

Touch the **Audio** icon on the infotainment display or  on the Multifunction Controller (MFC) to display the active audio source page. Examples of available sources may include AM, FM, SiriusXM (if equipped), USB, and Bluetooth.

### Phone

Touch the **Phone** icon on the infotainment display or  on the MFC to display the **Phone** menu. See *Bluetooth (Pairing and Using a Phone)* ⇨ *154 Bluetooth (Overview)* ⇨ 153.

### Maps

Touch the **Maps** icon to display the Google Maps screen. See *Using the Navigation System* ⇨ 141.

### Google Assistant

Touch the **Google Assistant** icon to open the Google Assistant app. See *Voice Recognition* ⇨ 145.

### Google Play

Touch to download some of your favorite apps in your vehicle. Downloading apps on Google Play require you to sign into a Google Account with an active service plan with data. Some third-party apps require a separate account and, in some cases, a paid subscription for in-vehicle access.

### Apple CarPlay

If equipped, touch the **Apple CarPlay** icon to activate Apple CarPlay after a supported device is connected. See *Apple CarPlay and Android Auto* ⇨ 158.

### Android Auto

If equipped, touch the **Android Auto** icon to activate Android Auto after a supported device is connected. See *Apple CarPlay and Android Auto* ⇨ 158.

### Settings

Touch the **Settings** icon to display the **Settings** menu. See *Settings* ⇨ 159.

### Controls

Touch the **Controls** icon to display the **Controls** menu.

### Application Tray

The **Application Tray** is along the bottom of the display. It shows up to six applications.

### Infotainment Gestures

Use the following finger gestures to control the infotainment system.

### Touch/Tap

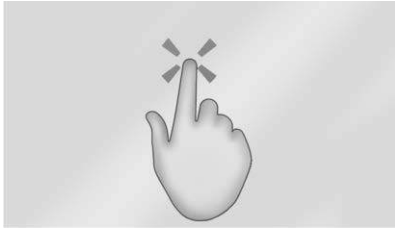

Touch/tap is used to select an icon or option, activate an application, or change the location inside a map.

### Touch and Hold



Touch and hold can be used to move or delete an application.

### Drag

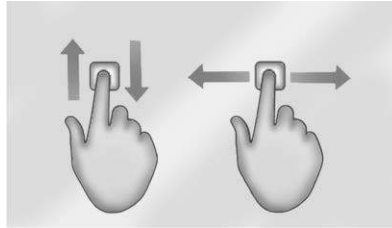

Drag is used to move applications on the infotainment home screen, or to pan the map. To drag the item, it must be held and moved along the display to the new location. This can be done up, down, right, or left. This feature is only available when vehicle is parked and not in motion.

### Nudge



Nudge is used to move items a short distance on a list or a map. To nudge, hold and move the selected item up or down to a new location.

### Fling or Swipe

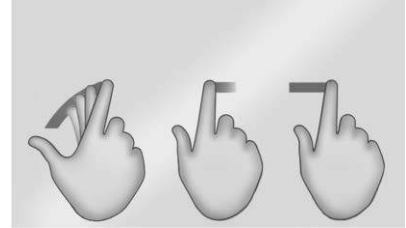

Fling or swipe is used to scroll through a list, pan the map, or change page views. Do this by placing a finger on the display then moving it rapidly up and down or right and left.

### Spread

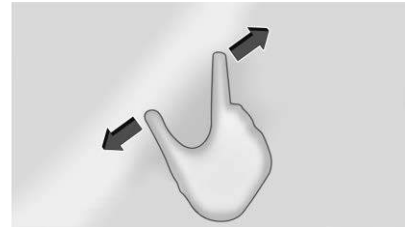

Spread is used to zoom in on a map, certain images, or a web page. Place finger and thumb together on the display, then move them apart.

### Pinch

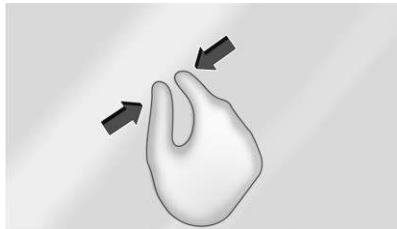

Pinch is used to zoom out on a map, certain images, or a web page. Place finger and thumb apart on the display, then move them together.

### Cleaning High Gloss Surfaces and Vehicle Information and Radio Displays

For vehicles with high gloss surfaces or vehicle displays, use a microfiber cloth to wipe surfaces. Before wiping the surface with the microfiber cloth, remove dirt that could scratch the surface. Then use the microfiber cloth by gently rubbing to clean. Never use window cleaners or solvents. Periodically hand wash

the microfiber cloth separately, using mild soap. Do not use bleach or fabric softener. Rinse thoroughly and air dry before next use.

## Software Updates

### Over-the-Air Software Updates

If equipped, see “Updates” under *Settings* ⇨ 159 for details on software updates.

## Radio

### AM-FM Radio

#### Playing the Radio

From the infotainment home screen, touch the Audio icon to display the active audio source page. Touch the source icon from the top of the page to choose from AM, FM, SiriusXM, or Bluetooth.

#### Finding a Station

##### Seeking a Station

From the AM or FM screen, touch ◀◀ or ▶▶ on the infotainment display to search for the previous or next strong station.

## Tune

Touch  on the infotainment display to display the Tune screen. Enter a station using the keypad.

The keypad will gray out entries that do not contribute to a valid frequency and will automatically place a decimal point within the frequency number.

Touch  to delete one number at a time.

Touch and hold  to delete all numbers.

A valid AM or FM station will automatically tune to the new frequency and display the now playing screen.

The list of all available stations are on the right side of the Tune display to browse. Touch to go to that station or touch  to save the station as a favorite.

#### Storing Radio Station Favorites

Favorites show in the area on the left of the display.

**AM, FM, or SiriusXM** : Favorites can be stored by touching Hold to Set on the left side of the screen.

The number of favorites is displayed automatically.

## Audio Settings

From the now playing screen, touch  and the following may display:

**Equalizer** : Touch to adjust Bass, Midrange, or Treble using the options on the infotainment display.

**Fade/Balance** : Touch to adjust by using the controls on the infotainment display.

**Sound Mode** : Touch to select Front or Rear to provide the best sound for the front or rear seating positions.

Adjust the Surround controls to change from Stereo to Surround mode.

**Adaptive Volume** : This allows the Adaptive Volume to be turned on or off.

Touch Off or On.

**Manage Radio Favorites** : Touch to display a list of Audio favorites.

Favorites can be moved or deleted.

To move, touch and hold the move icon, and then drag up or down to rearrange the position.

**Radio Text** : This allows the Radio Data System (RDS) to be turned on or off.

Touch Off or On.

**Radio Text (RDS) Categories** : When on, category information about current radio content will be shown.

## Radio Text–Radio Data System (RDS)

RDS relies on receiving specific RDS information from radio stations and only works when the information is available. It is possible that a radio station could broadcast information that causes the radio to work improperly.

In addition, RDS features are region and country of sale specific. This means specific RDS content may not be available in your listening area or in the country you operate the vehicle.

To turn RDS features on or off, see "Audio Settings" previously.

The following RDS features may be supported by radio broadcasters in your listening area:

### Core Radio Text (RDS) Features

- Display radio station call letters
- Display messages from radio stations
- Provide radio station category information (when available)

## Satellite Radio

### SiriusXM Radio Service

If equipped, vehicles with a valid SiriusXM radio subscription can receive SiriusXM programming.

SiriusXM radio has a wide variety of programming and commercial-free music, coast to coast, in digital-quality sound. In the U.S., see [www.siriusxm.com](http://www.siriusxm.com) or call 1-888-601-6296. In Canada, see [www.siriusxm.ca](http://www.siriusxm.ca) or call 1-877-438-9677.

When SiriusXM is active, the channel name, number, song title, and artist appear on the display.

### SiriusXM with 360L

SiriusXM with 360L interface has enhanced in-vehicle listening experience for subscribers. The experience now offers more categories and system learned recommendations toward discovering more personalized content.

To use the full SiriusXM 360L program, including streaming content and listening recommendations, OnStar Connected Access is required and Terms and Conditions accepted.

Connected vehicle services vary by model and require a complete working electrical system, cell reception, and GPS signal.

Reference the SiriusXM user guide for use and subscription information.

### Playing SiriusXM Content

Touch ◀, II, ▶ or ▶▶ on the now playing screen to rewind, pause, play, or fast forward content.

### Finding a Channel

From the SiriusXM now playing screen, touch ◀CH or CH▶ to open the SiriusXM tuner channel list.

To directly tune to a channel, touch the Tune icon to enter a channel number using the keypad.

### Browsing Content

Touch  to view different browsing content.

Browse will include Channels, Music, On Demand shows and episodes, Sports and News content.

### SiriusXM Settings

From the SiriusXM now playing screen, touch the user settings icon to display the SiriusXM settings.

The settings include subscription information, help and support, and listener preferences.

### Radio Reception

Unplug any electronic devices from the accessory power outlets if there is static interference.

### FM

FM signals only reach about 16 to 65 km (10 to 40 mi). Although the radio has a built-in electronic circuit that automatically works to reduce interference, some static can occur, especially around tall buildings or hills, causing the sound to fade in and out.

### AM

The range for most AM stations is greater than FM, especially at night. The longer range may also cause station frequencies to interfere with each other. Storms and power lines may also interfere with radio reception. Try reducing the treble on the radio if static interference occurs.

### SiriusXM Satellite Radio Service

If equipped, SiriusXM Satellite Radio Service provides digital radio reception. Tall buildings or hills can interfere with satellite radio signals, causing the sound to fade in and out. In addition, traveling or parking under heavy foliage, bridges, garages, or tunnels may cause loss of the SiriusXM signal for a period of time. Some cellular services may interfere with SiriusXM reception causing signal loss.

### Mobile Devices

Making or receiving calls, charging, or just having a mobile device on may cause static interference. Unplug or turn off any mobile devices if this happens.

### Multi-Band Antenna

The multi-band roof antenna may be used for radio, navigation, and other communication systems, depending on the equipped options. To ensure clear reception, keep the antenna clear of obstructions, such as snow and ice. Reception can be affected by an open sunroof or roof-mounted cargo.

## Audio Players

### Avoiding Untrusted Media Devices

Only use trusted media devices. Avoid untrusted mobile and USB media devices that may contain files that affect system operation or performance.

### USB Port

The vehicle may be equipped with multiple USB ports. Music may be played from a connected USB device. Ports may also be used for charging.

#### Caution

To avoid vehicle damage, unplug all accessories and disconnect all accessory cables from the vehicle when not in use. Accessory cables left plugged into the vehicle, unconnected to a device, could be damaged or cause an electrical short if the unconnected end comes in contact with liquids or another power source such as the accessory power outlet.

### USB Audio

To play music via USB:

1. On the audio now playing screen, touch source and select USB.
2. If there is no device connected, follow the screen prompts to connect the device.
3. Supported media content will appear on the display.

### Bluetooth Audio

Music may be played from a connected Bluetooth mobile device.

Volume and song selection may be controlled by using the infotainment controls. If Bluetooth is selected and no volume is present, check the volume setting on the infotainment system or the connected mobile device.

To play music via Bluetooth:

1. On the audio now playing page, touch source and select the desired Bluetooth mobile device.
2. If there is no mobile device connected, follow the screen prompts to pair the device.

3. Supported media content will appear on the display.

### Manage Bluetooth Devices

Managing Bluetooth devices allows you to add, delete, or select another paired mobile device.

Only one Bluetooth mobile device can be active at a time.

Some mobile devices support sending Bluetooth music information to display on the radio. For more information about supported Bluetooth features, visit your brand website. See *Online Account and Customer Support* ⇨ 381 for details.

See *Radio Frequency Statement* ⇨ 387.

## Navigation

### Using the Navigation System

The Navigation software is provided by Google Maps. The information provided in this section is a general overview and is subject to change. For the latest functional information, see [g.co/mapsincarc](http://g.co/mapsincarc).

Accept the Terms and Conditions to use.

### Internet Connectivity

Google Maps relies on a subscription data plan for full functionality, including availability of offline maps. With an applicable connected services plan, Google Maps can be used offline when driving through connectivity dead zones by auto-downloading offline maps prior to going offline.

### Profiles

Sign in to a Google Account for personalized service. Information available in the Google Account will be shown.

To log into a profile, see Accounts under *Settings* ⇨ 159.

### Voice Assistant

If equipped, Google Maps can be controlled by voice commands, see Google Assistant under *Voice Recognition* ⇨ 145.

### Language and Units

To change the language and units, see *Settings* ⇨ 159.

### Mute Settings

During active route guidance, Google Maps can give audible voice directions, traffic alerts, or can be muted. In the Google Maps app, touch Settings, then Mute settings to access the options. Alternatively, audible voice directions and traffic alerts can be muted by touching the sound icon on the navigation map screen during active navigation.

### Compass

The Google Maps orientation can be changed between the direction currently traveling, north, and route overview. Touch the compass to switch between these options.

To recenter the map to the current location, touch the location icon.

### Super Cruise

If equipped, Super Cruise highlights routes in a specific outline. See *Super Cruise* ⇨ 235.

## Maps

### Auto-Downloaded Maps

Google Maps downloads maps automatically for use when not connected to the Internet. Offline maps make map data available to vehicle features regardless of connectivity.

To turn on auto-download:

1. Open Google Maps.
2. Touch the Settings icon.
3. Touch Privacy center, then select Offline maps.
4. Select Auto-download offline maps.
5. Check the Internet connection and wait for the download to finish.

### Downloading Offline Maps

1. Open Google Maps.
2. Touch Settings, then Offline maps.
3. Touch the Select your own map square icon.
4. Adjust the map to cover the desired area to download.
5. Touch Download.

## Navigation Symbols

The following are the most common symbols that may appear in Google Maps.



This indicates the vehicle's current location and direction on the map.



The destination pin marks the location of the final destination. Touch the pin to view the destination address or to add it or remove it from the Favorites list. Hide the information by touching the pin one more time. It will automatically time out if no action is taken.

A second pin in the menu is the route overview. Touch this pin to show more details of the destination or to remove the destination.

## Destination

### Searching for a Destination

A destination can be searched using Google Assistant.

To search for a destination without Google Assistant:

1. Open Google Maps.
2. Touch the Search field.
3. Enter the destination.
4. Touch the Navigation icon.

### Alternate Routes

Alternate routes are displayed as separate lines. While in either Turn-by-Turn navigation or on the route overview, touch the suggested alternate route.

### Adding a Stop on Route by Voice

1. While in Turn-by-Turn navigation, touch the Search icon at the bottom.
2. Touch the Google Assistant mic icon and say the destination to search by voice.
3. Select the desired search result from the list.
4. Touch the Add stop icon.

### Adding a Stop on Route by Category

1. While in Turn-by-Turn navigation, touch the Search icon at the bottom.
2. Select a category.
3. Select the desired search result from the list.
4. Touch the Add stop icon.

### Adding a Home or Work Address

To edit a home or work address, an account must be logged in. See Accounts under *Settings* ⇨ 159.

1. Open Google Maps.
2. Touch Settings, then touch Edit home or work.
3. Enter the address.

### Search by Category

Destinations can be searched by category, such as restaurant or grocery store.

1. Open Google Maps.
2. Touch the search bar.
3. Touch Categories, then select a category.
4. Touch the desired location, then touch the Navigation icon.



### Avoid Tolls, Highways, or Ferries

1. Open Google Maps.
2. Touch the Settings icon.
3. Select Route options.
4. Select the desired options and then touch X to close.

### An Alternative Way for General Route Options

1. During active route guidance, touch Route Overview.
2. Select Route options.
3. Select the desired option and then touch X to close.

### Traffic Layers

1. Open Google Maps.
2. Touch the Settings icon.
3. Touch Traffic to turn on or off.

## Global Positioning System (GPS)

The current position of the vehicle is determined by using satellite signals and various vehicle signals.

At times, other interference such as the satellite condition, road configuration, condition of the vehicle, and/or other circumstances can affect the navigation system's ability to determine the accurate position of the vehicle.

This system might not be available or interference can occur if any of the following are true:

- Signals are obstructed by tall buildings, trees, large trucks, or a tunnel.
- Satellites are being repaired or improved.

For more information if the GPS is not functioning properly, see *Problems with Route Guidance* ⇨ 145.

## Vehicle Positioning

At times, the position of the vehicle on the map could be inaccurate due to one or more of the following reasons:

- The road system has changed.
- The vehicle is driving on slippery road surfaces such as sand, gravel, or snow.
- The vehicle is traveling on winding roads or long, straight roads.

- The vehicle is approaching a tall building or a large vehicle.
- The surface streets run parallel to a freeway.
- The vehicle has been transferred by a vehicle carrier or a ferry.
- The current position calibration is set incorrectly.
- The vehicle is traveling at high speed.
- The vehicle changes directions more than once, or the vehicle is turning on a turn table in a parking lot.
- The vehicle is entering and/or exiting a parking lot, garage, or a lot with a roof.
- The GPS signal is not received.
- A roof carrier is installed on the vehicle.
- Tire traction devices are installed on the vehicle.
- The tires are replaced or worn.
- The tire pressure for the tires is incorrect.
- This is the first navigation use after the map data is updated.
- The 12-volt battery has been disconnected for several days.

- The vehicle is driving in heavy traffic where driving is at low speeds, and the vehicle is stopped and started repeatedly.

## Problems with Route Guidance

Inappropriate route guidance can occur under one or more of the following conditions:

- The turn was not made on the road indicated.
- Route guidance might not be available when using automatic rerouting for the next right or left turn.
- The route might not be changed when using automatic rerouting.
- There is no route guidance when turning at an intersection.
- Automatic rerouting might display a route returning to the set waypoint if heading for a destination without passing through a set waypoint.
- The route prohibits the entry of a vehicle due to a regulation by time or season or any other regulation which may be given.
- Some routes might not be searched.

- The route to the destination might not be shown if there are new roads, if roads have recently changed, or if certain roads are not listed in Maps.

To recalibrate the vehicle's position on the map, park with the vehicle running for two to five minutes, until the vehicle position updates. Make sure the vehicle is parked in a location that is safe and has a clear view of the sky and away from large obstructions.



## Voice Recognition

If equipped, the vehicle's built-in Assistant allows for hands-free use of media and messaging, navigation and climate control functionality in the vehicle. To activate, quickly press and release  on the steering wheel, touch Google Assistant on the infotainment home screen, or use the wake up words "Hey Google" or "OK Google. Google Assistant must be set as the default assistant for steering wheel and wake word activation to work.

However, not all features within these areas are supported by voice commands and requires the user to have a valid data subscription plan or connected to Wi-Fi in order to use some of the Google Assistant features.

## Using Voice Recognition

Voice recognition becomes available once the system is initialized. This begins when the vehicle is turned on. Initialization may take a few moments.

1. Quickly press and release  on the steering wheel controls, touch Google Assistant on the infotainment home screen, or use the wake up words "Hey Google" or "OK Google" to activate voice recognition. Google Assistant must be set as the Default Assistant for the  and the wake word options to work.
2. Clearly speak one of the commands described later in this section.

## Canceling Google Assistant

- Press  on the steering wheel controls to cancel the Google Assistant request.

## Helpful Hints for Speaking Commands

Voice recognition identifies commands that are naturally stated in sentence form, or direct commands that state the application and the task.

For best results:

- Speak the command naturally, not too fast, not too slow.
- Use direct commands without a lot of extra words. For example, “Call <name> at work,” “Play” followed by the artist or song name, or “Play” followed by the radio station number.

Direct commands are more clearly understood by the system. An example of a direct command is “Dial <number>.”

If a cell phone number was saved with a name and a place, the direct command should include both. For example “Call <name> at work.”

### Voice Recognition for the Radio

When voice is started, the voice recognition commands for AM, FM, SiriusXM (if equipped), and media apps (if supported) are available.

**“Play <AM frequency> AM”**: Tune to the radio station frequency identified in the command (like “nine fifty”).

**“Play <FM frequency> FM”**: Tune to the radio station frequency identified in the command (like “one oh one point one”).

**“Play channel <SiriusXM channel number> on SiriusXM”**: Tune to the SiriusXM radio station channel number identified in the command. This command may require an online connection.

**“Play <SiriusXM channel name> on SiriusXM”**: Tune to the SiriusXM radio station channel name identified in the command. This command may require an online connection.

**“Play <Media> on <Audio Source>”**: Play media like a song or channel using a specified audio source such as Pandora or Spotify. This command may require an online connection.

### Voice Recognition for the Phone

Make sure the phone is paired using Bluetooth to use the phone related voice commands.

**“Call <contact name>”**: Initiate a call to a stored contact. The command may include location if the contact has location numbers stored. You must accept Personal Results permission during set up for access to the contacts.

**“Call < phone number>”**: Initiate a call to a phone number of seven digits or 10 digits.

**“Send a message to <contact name>”**: Send a message to a stored contact.

### Voice Recognition for Navigation

Navigation commands can be used to start, cancel route, or add waypoints/points of interest (POI).

**“Navigate to <destination address>”**: Initiate navigation to the address in the command.

**“Find a <Place of Interest>”**: Find and initiate navigation to a POI in the command.

**“Add <destination> on my way”**: Adds a waypoint to the current route.

**“Take me home”**: Starts navigation to Home location set in Google maps.

### Onboard Vehicle Commands

These commands can be used to adjust vehicle temperature, control window defrosters and obtain fuel information.

**“Turn on the A/C”**: Turns on the air conditioning.

**“How much gas do I have left”**: Find out how much fuel your vehicle has left.

**“Set temperature to <desired number> degrees”**: Set to a specific temperature inside your vehicle.

## Phone Assistant Voice Recognition

While a mobile phone is connected via Bluetooth, Android Auto, or Apple CarPlay, press and hold  on the steering wheel controls until you hear a response from the phone's voice assistant to pass through and launch the Voice Assistant on the connected mobile phone (e.g., Google assistant, Siri, etc.).

## Performance Data Recorder (PDR)

If equipped, the PDR icon displays on the infotainment home screen.

### Important Information

Use of the PDR may be prohibited or legally restricted in certain countries and situations. Ensure compliance with applicable laws and regulations, including, but not limited to: privacy laws, laws related to camera surveillance and recordings, road traffic and security laws, and laws on the protection of publicity and personality rights.

- Do not use the PDR if it causes distraction.
- Do not rely on camera footage to steer the vehicle.

- Comply with any notice and consent requirements before capturing and/or recording the voices or images of other persons or before collecting other personal data.
- Notify other drivers of your vehicle of the above rules and require them to comply.
- General Motors does not accept any responsibility or liability in connection with use that is not permitted.
- Law enforcement authorities may have the right to seize video recordings and use them as evidence of criminal/driving offenses against you or third parties.

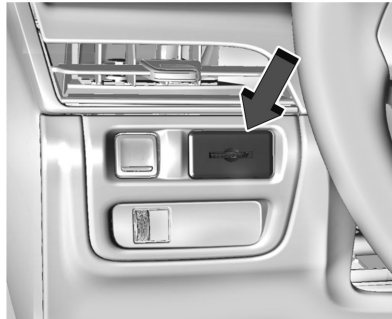

The PDR records video, audio, and Performance Data. This data is stored on a removable SD card located to the left of the steering wheel.

The recorded data is not stored anywhere else and is only accessible from the SD card.

To optimize PDR performance, it is recommended that the SD card is formatted on a regular basis. Back up all recordings on the SD card prior to formatting. Formatting the SD card will delete all saved recordings.

If a system error code is seen on the display, such as "System Error Code ####", please check the health of the SD card. It may need to be reformatted or replaced. If the issue persists, please see your dealer.

To begin, insert an exFAT formatted SD card, Class 10 required, 16 GB or larger recommended, into the SD card reader located to the left of the steering wheel.

If an SD card is not detected, a No Storage Device Detected message will display.

Touch the PDR icon to access the PDR home screen.

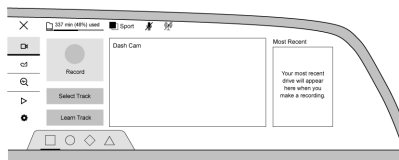

Home Screen – Dash Cam

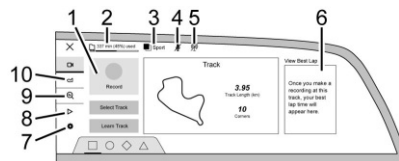

Home Screen – Track Selected

1. Record
2. SD Card Information
3. Video Overlay: Sport, Track, Timers, None
4. Audio Recording
5. GPS Signal
6. Vehicle Setup (Pre-Race)
7. Settings
8. Saved Recordings
9. Analysis

## 10. Tracks: Circuit and Autocross

The Dash Cam menu is shown on first time use and/or until a track is learned or selected. Touching Dash Cam deselects the track and returns to the dash cam menu.

### Record

If the system is unable to begin recording, the Record button is grayed out. See SD Card Information later in this section.

Touch Record to begin recording. After recording begins, this button changes to Stop Recording. Touch to stop the recording session.

The recording must be stopped and the file closed before removing the SD card, or the recording cannot be reviewed.

The elapsed time will show when recording.

### SD Card Information

This displays the SD card storage information. When the storage is low, full or undetected, the display changes to an alert.

The following errors or warnings may be displayed while recording:

- No Storage Device Detected
- Storage Device is Low

- Storage Device is Full
- System Error
- Unable to Use This Storage Device
- GPS Accuracy Warning
- SD Card Write Protected- Remove the SD card and slide the protection switch if this message displays.

### Video Overlay

Touch the Video Overlay icon to display the menu screen.

The overlay can be changed or configured after the video is created by selecting an overlay during video playback.

Touching preview provides a live preview of the overlay selected.

Select one:

- Sport
- Track
- Timers
- None

## Sport

Displays these vehicle metrics:

- **Vehicle Speed:** Up to three digits are displayed in km/h or MPH depending on vehicle settings.
- **Engine Revolutions Per Minute (rpm):** The horizontal bar shows current rpm. As the rpm increases, the backfill follows.
- **Transmission State (Current Gear):** Transmissions display 1, 2, etc.
- **Lateral G-Force Graphic:** Left and Right G-Forces are displayed. The graphic fills to the left or the right depending on the measure value. The measured G-Force displays as a number at the top of the graphic.
- **Event Odometer:** This displays the distance driven since the recording began.

## Track

Displays these vehicle metrics:

- **Vehicle Speed:** Same as Sport.
- **GPS Tracking Map:** Shows the vehicle's current position relative to a known route.
- **Engine Revolutions Per Minute (rpm):** The horizontal bar shows current rpm. As the rpm increases, the backfill follows.

- **Transmission State (Current Gear):** Same as Sport.
- **Friction Bubble Graphic:** Lateral and longitudinal G-Forces are displayed as a dot within a bubble. A red dot displays when the vehicle starts braking and turns green when the vehicle accelerates. The dot is white when the vehicle is not moving. A white dot is the default.
- **Brake and Throttle Graphic:** Displays the percentage value of brake and throttle pedal position from 0–100%.
- **Steering Angle:** The graphic fills from the center to the left or right depending on the direction of steering. The numerical steering angle displays below the graphic.
- **Active Handling Active Indicator:** The graphic only displays if the active handling systems are activated.
- **Performance Traction Management (PTM) Mode:** Displays the current PTM mode. The options are OFF, WET, DRY, SPORT, RACE 1, RACE 2 and PRO.
- **Current Lap Time:** Displays the elapsed lap time if the finish line is defined and the vehicle has crossed the defined finish line at least once.

- **Event Odometer:** This displays the distance driven since the recording began.
- **Drive Mode:** Displays the vehicle's current drive mode.

## Timers

Displays these vehicle metrics:

- **Vehicle Speed:** Same as Sport.
- **Engine Revolutions Per Minute (rpm):** Same as Sport.
- **Transmission State (Current Gear):** Same as Sport.
- **0–96 km/h (0–60 mph), 0–160 km/h (0–100 mph), 0–160–0 km/h (0–100–0 mph) and 0–402 m (0–1/4 mi):** The timer starts recording as soon as the vehicle accelerates. As the vehicle passes each speed and distance milestone, it is displayed on the overlay.
- **Select Set Speeds** to choose the speeds to start and end the timer.
- **Throttle Position:** Displays the percentage of throttle applied from 0–100%.
- **Active Handling Active Indicator:** The graphic only displays if the active handling systems are activated.

**None**

No vehicle data displays on top of the recorded video. Vehicle data is still available with the video when accessed in the toolbox software. See [www.cadillac.com](http://www.cadillac.com) to download Toolbox Software.

**Audio Recording**

Touch to turn the audio recording on/off.

**GPS Signal**

Indicates GPS signal strength.

**Vehicle Setup (Pre-Race)**

Touch this card to view pre-race information including Performance Traction Management (PTM), Drive Modes and tire pressure.

**Settings**

Touch the Settings icon to view the Settings menu.

- **Audio Recording-** Select on or off to record audio with the recorded video.
- **Automatic Recording-** When on, the PDR will automatically begin recording whenever the vehicle is in the Run Power Mode. Configurations include:

- Automatic Recording Video Quality
- While in Valet Mode only
- Whether to allow recording overwrite when the storage is full
- **Video Recording Quality-** Low (480p), Medium (720p) or High (1080p). Higher quality will result in larger recording files.
- **Storage Information-** Removable and PDR Application Storage
- **Default Video Overlay-** Select the default overlay: Sport, Track, Timers, None
- **Software Information-** Displays PDR Software Information and Version numbers.

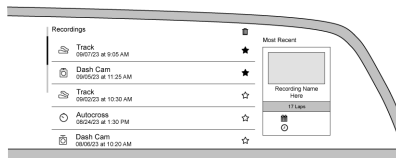
**Saved Recordings**

Touch the Recordings icon. If a Track, Autocross or Dash Cam outing was recorded, it can be selected to view. The most recent recording is

displayed in the card next to the list. The next most recent recordings are shown in the list in chronological order.

To save a recording as a favorite, touch the star next to the recording.

Select the recording to start playback.

Recordings may be deleted by selecting the trash can. Touch Delete to confirm delete or Close to cancel. Touch Select All to delete all saved recordings.

Video Playback is not allowed while the vehicle is moving.

Tap on the screen while the video is playing to display the video playback controls.

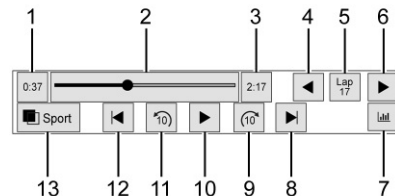
**Single Video**

1. Elapsed time
2. Slide bar

3. Time remaining
4. Previous lap
5. Current lap
6. Next lap
7. Analysis
8. Move ahead
9. Skip forward
10. Play/Pause
11. Skip back
12. Move back
13. Selected overlay

### **Elapsed Time**

Shows the elapsed time for the recording.

### **Slide Bar**

On touch or slide: Navigate to any section of the video.

### **Time Remaining**

Shows the remaining time for the recording.

### **Previous Lap**

On touch: Displays previous lap. If on Lap 1, this icon is inactive.

### **Current Lap**

Shows current lap.

### **Next Lap**

On touch: Displays next lap. If on final lap within the outing, this icon is inactive.

### **Analysis**

On touch: Displays single lap analysis screen.

### **Move Ahead**

On touch: Move ahead to next sector within the video. If on the last sector, this icon is inactive.

### **Skip Forward**

On touch: Skip ahead (10 sec.). If at the end of the playback time, this icon is inactive.

### **Play/Pause**

On touch: Play/Pause the video playback. When paused, the icon changes to 'Pause' icon.

### **Skip Back**

On touch: Skip back (10 sec.). If at the beginning of video playback, this icon is inactive.

### **Move Back**

On touch: Move back to previous sector within the video. If on the first sector, this icon is inactive.

### **Track Overlay**

On touch: Change video overlays. The track overlay can be changed or configured after the video is created by selecting an overlay during video playback.

### **Dual Video**

In Track Dual Video View, touch the edit icon to open the target lap screen and select a different lap from the current session or from a different session within the selected track.

Use the video playback controls to sync playbacks from both videos.

### **Analysis**

Touch the Analysis icon for Coaching and Analysis

Coaching: Select an outing from the track list to display speed tips. Select a Speed Tip to view tips for improvement.

Swipe the screen to see the additional tips.



**Analysis:** Touch the card to select a lap for analysis. After first lap has been selected, touch the card to add an additional lap.

**Select Show Analysis:** View analysis for Speed, Throttle, and Brake.

### Speed

**On touch:** Shows Speed information for selected laps within selected session.

### Throttle

**On touch:** Shows Acceleration information for selected laps within selected session.

### Brake

**On touch:** Shows Braking information for selected laps within selected session.

View the graph to see the Time Slip data of each selection.

### Tracks

Touch the Track icon to view the track browser.

### Track Browser

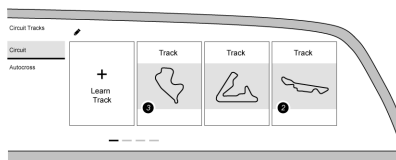

- Select Learn Track to create a new custom track.
- Only one track can be learned during each recording session. To learn a new track, end the current recording and start a new one. If a track learning is unsuccessful, a message will display to Retry.
- Once a track is learned, touch the pencil icon to customize the track name.

### Custom Track Learning – Circuit

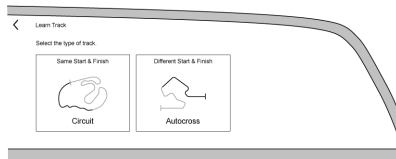

- Select Circuit as the track type. Select Set Start when you reach the starting line.

- Circuit track learning will complete automatically once one lap of the course is completed.
- After the Learning Process is complete, touch the arrow in the top left to go back to the home screen or touch Relearn Track to attempt to learn again.
- Saved tracks will be named by the PDR as custom.gpx.
- Select the saved track and rename by selecting the pencil icon in the top right corner. Do not change or delete the file extension (.gpx).
- Touch < in the upper left corner to return to the home screen or Cancel to stop track learning.

### Custom Track Learning – Autocross

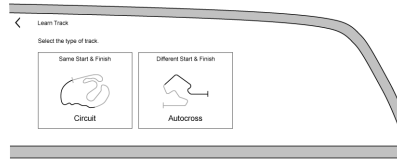

- Select Autocross as the track type. Select Set Start when you reach the starting line.

- Drive along the course and touch Set Finish when the vehicle has reached the finish line.
- After the Learning Process is complete, touch the arrow in the top left to go back to the home screen or touch Relearn Track to attempt to learn again.
- Saved tracks will be named by the PDR as custom.gpx.
- Saved tracks can be renamed by selecting the pencil icon in the top right corner. Do not change or delete the file extension (.gpx).
- Touch < in the upper left corner to return to the home screen or Cancel to stop track learning.

## Post Race Summary

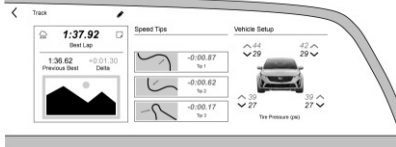

- Post Race Summary Card
- Speed Tips
- Vehicle Setup

Select a learned track or press Stop during a track recording to view the post race summary.

### Post Race Summary Card

Touch the summary card to view the best lap information and the lap video preview.

### Speed Tips

Touch to view the total lap time reduction based on the selected outing. For additional information, see Analysis earlier in this section.

### Vehicle Setup

View Tire Pressure information from the best lap.

### PDR Tools

Use analysis tools to view data and footage captured by PDR to get a more-in depth understanding of on-track performance and lap time improvements. See [www.cosworth.com/motorsport/support/pdr-data-analysis-tools/](http://www.cosworth.com/motorsport/support/pdr-data-analysis-tools/) to download analysis tools.

## Phone

### Bluetooth (Overview)

The vehicle's Bluetooth system can interact with a mobile device to:

- Place and receive calls in a hands-free mode.
- Share the device's address book or contact list with the vehicle.
- Stream audio (music, podcasts).
- Notify receipt of text messages.

To minimize driver distraction, before driving, and with the vehicle parked:

- Become familiar with the features of the mobile device. Organize the phone book and contact lists clearly and delete duplicate or unused entries.
- Review the controls and operation of the infotainment system.
- Pair mobile device(s) to the vehicle. The system may not work with all mobile devices. See "Pairing" later in this section.

Vehicles with a Bluetooth system can use a Bluetooth-capable mobile device with a Hands-Free Profile to make and receive phone calls. The infotainment system and voice

recognition are used to control the system. The system can be used while the vehicle is on. The range of the Bluetooth system can be up to 9.1 m (30 ft). Not all mobile devices support all functions and not all mobile devices work with the Bluetooth system. See *Online Account and Customer Support* ⇨ 381 for more information about compatible mobile devices.

### Controls

Use the controls on the infotainment display and the steering wheel to operate the Bluetooth system.

### Steering Wheel Controls

 : Press and release to start voice recognition on your mobile phone that is connected through Bluetooth, Apple CarPlay, or Android Auto. If there is an incoming call, then a press and release will answer the call.

 : Press to end a call, decline a call, or cancel an operation. Press to mute or unmute the infotainment system when not on a call.

### Infotainment System Controls

For information about how to navigate the menu system using the infotainment controls, see *Using the System* ⇨ 136.

### Audio System

When using the Bluetooth system, sound comes through the vehicle's front audio system speakers and overrides the audio system. The volume level while on a mobile device phone call can be adjusted by pressing the steering wheel volume controls or the volume controls for the infotainment system. The adjusted volume level remains the same for later calls. The volume cannot be lowered beyond a certain level.

### Bluetooth (Pairing and Using a Phone)

#### Pairing

A Bluetooth-enabled mobile device must be paired to the Bluetooth system and then connected to the vehicle before it can be used. See the mobile device manufacturer's user guide for Bluetooth functions before pairing the device.

#### Pairing Information

- Select the phone icon on the infotainment home screen.

- If no mobile device has been paired, a message on the infotainment display will show the Manage Phones option. Select this option and the Phones screen will display. See "Pairing a Phone" later in this section.
- A Bluetooth mobile device with music capability can be paired to the vehicle as a phone and a music player at the same time.
- Up to 10 devices can be paired to the Bluetooth system.
- The pairing process is disabled when the vehicle is moving.
- Pairing only needs to be completed once, unless the pairing information on the mobile device changes or the phone is deleted from the system.
- If a previously paired mobile device is not connecting to the Bluetooth system, try forgetting the mobile device on the vehicle's infotainment system and also forgetting the vehicle in the Bluetooth settings of the mobile device. Then repeat the pairing process.

- If multiple paired mobile devices are within range of the system, the system connects to the paired mobile device that is set to First to Connect. If there is no mobile device set to First to Connect, it will connect to the mobile device which was used last. To connect to a different paired mobile device, see “Connecting to a Different Phone” later in this section.

### Pairing a Phone

1. Make sure Bluetooth has been enabled on the phone before starting the pairing process.
2. Select the phone icon on the infotainment home screen.
3. If a phone has been previously added, select Settings > Connections > Phones to reach the device manager. From the device manager, select “Add Phone.” If a phone has been previously added, the “Add Phone” card will just be a “+” button.
4. Select Manage Phones to display the Phones screen.

5. Select Add Phone.

If a phone has been previously added or disconnected, the “Add Phone” card will just be a “+” card.

6. The code on both the phone and infotainment display need to be acknowledged for pairing to be successful.
7. Follow the instructions on the phone to confirm the six-digit code showing on the infotainment display and select Pair. The code on the phone and infotainment display need to be acknowledged for pairing to be successful.
8. If a previously paired mobile device is not connecting to the Bluetooth system, try forgetting the mobile device on the vehicle’s infotainment system and also forgetting the vehicle in the Bluetooth settings of the mobile device.
9. If the vehicle name does not appear on your phone under the “other devices” or “available devices” menu, there are a few ways to start the pairing process over:
  - Turn Bluetooth off then back on, on your phone.

- Go back to the beginning of the Phone menus on the infotainment display and restart the pairing process.
- Turn the phone off and then back on.
- Reset the phone, but this step should be done as a last effort.

10. If the phone prompts to accept connection or allow phone book download, select Always Accept and Allow. The phone book may not be available if not accepted.
11. To pair additional phones, select Settings > Connections > Phones.

### First to Connect Paired Phones

If multiple paired phones are within range of the system, the system connects to the paired phone that is set as First to Connect. To enable a paired phone as the First to Connect phone:

1. Make sure the phone is turned on.
2. Select the Settings icon on the infotainment home screen.
3. Select Connections.
4. Select Phone.
5. Select Options under the connected phone.

6. Select First to Connect from the phone's settings menu and set First to Connect to On.

Phones and mobile devices can be added, removed, connected, and disconnected. A sub-menu will display whenever a request is made to add or manage phones and mobile devices.

### Accessing the Device List Screen

There are two ways to access the device list screen:

#### Using the Settings Icon

1. Select the Settings icon on the infotainment home screen or the Settings icon on the application tray near the left of the display.
2. Select Connections.
3. Select Phones.

#### Using the Phone Icon

1. Select the Phone icon on the infotainment home screen or the Phone icon on the application tray near the left of the display.
2. Select  on the Phones screen.
3. Select Connected Phone.

### Disconnecting a Connected Phone

To disconnect a phone:

1. Open the Device List Screen. See "Accessing the Device List Screen" previously in this section.
2. Select Option on the phone card to show the phone's or mobile device's settings.
3. Select Disconnect.

### Deleting a Paired Phone

To delete a paired phone:

1. Open the Device List Screen. See "Accessing the Device List Screen" previously in this section.
2. Select Option on the phone card to show the phone's or mobile device's settings.
3. Select Forget Phone.

### Connecting to a Different Phone

To connect to a different phone, the new phone must be in the vehicle and paired to the Bluetooth system.

To connect to a different phone:

1. Open the Device List Screen. See "Accessing the Device List Screen" previously in this section.

2. Select the new phone you want to connect to from the list of available phones. See "First to Connect Paired Phones" previously in this section.

### Switching to Handset or Hands-Free Mode

To switch between handset or hands-free mode:

- While the active call is hands-free, select the Audio Output option, then select Phone to switch to the handset mode.  
The mute icon will not be available or functional while Handset mode is active.
- While the active call is on the handset, select the Audio Output option, then select Car Speakers to switch to the hands-free mode.

### Making a Call Using Contacts

Calls can be made through the Bluetooth system using personal phone contact information for all phones that support the Phone Book feature. Become familiar with the phone settings and operation and that the phone is set to allow the sharing of contacts over Bluetooth with the vehicle. Verify the

phone supports this feature and that the phone is set to allow the sharing of contacts over Bluetooth with the vehicle.

The Contacts menu accesses the phone book stored in the phone.

To make a call using the Contacts menu:

1. Select the Phone icon on the infotainment home screen or on the application tray near the left of the display.
2. Select Contacts.
3. There are two methods to search for contacts:
  - Search bar – Select the search icon on the top right of the Phones window and type the name or number of the contact on the keyboard. Search results will be displayed corresponding to the user input. Select the name to call.
  - Scroll – Select the list and scroll, or use the scrollbar on the left side of the Phones window. Select the name to call.

### Making a Call Using the Recents Menu

The Recents menu accesses the recents call list from your phone.

To make a call using the Recents menu:

1. Select the Phone icon on the infotainment home screen or on the application tray near the left of the display.
2. Select Recents.
3. Select the name or number to call.

### Making a Call Using the Keypad

To make a call by dialing the numbers:

1. Select the Phone icon on the infotainment home screen or on the application tray near the left of the display.
2. Select Keypad and enter a phone number.
3. Select the phone icon on the infotainment display to start dialing the number.

### Searching Contacts Using the Keypad

To search for contacts using the keypad:

1. Select the Phone icon on the infotainment home screen.

2. Select Keypad and enter partial phone numbers or contact names using the digits on the keypad to search.

Results appear on the right side of the display. Select one to place a call.

### Accepting or Declining a Call

When an incoming call is received, the infotainment system mutes and a ring tone is heard in the vehicle.

#### Accepting a Call

There are two ways to accept a call:

- Press  on the steering wheel controls.
- Select Answer on the infotainment display.

#### Declining a Call

There are two ways to decline a call:

- Press  on the steering wheel controls.
- Select Decline on the infotainment display.

### Call Waiting

Call waiting must be supported on the Bluetooth phone and enabled by the wireless service carrier to work.

### Accepting a Call

Press  to answer, then select Switch on the infotainment display.



### Declining a Call

Press  to decline, then select Decline on the infotainment display.

### Switching Between Calls (Call Waiting Calls Only)

To switch between calls, select Phone on the infotainment home screen to display Call View. While in Call View, select the call information of the call on hold to change calls.

### Ending a Call

- Press  on the steering wheel controls.
- Select  on the infotainment display, next to a call, to end only that call.

### Dual Tone Multi-Frequency (DTMF) Tones

The in-vehicle Bluetooth system can send numbers during a call. This is used when calling a menu-driven phone system. Use the Keypad to enter the number.

## Apple CarPlay and Android Auto

If equipped, Android Auto and/or Apple CarPlay capability may be available through a compatible smartphone. If the phone is paired and projections are available, Android Auto and/or Apple CarPlay icons will become illuminated on the infotainment home screen.

To use Android Auto and/or Apple CarPlay:

### For Wired Phone Projection

1. For Android 9 smartphones and older, download the Android Auto app to your phone from the Google Play Store. There is no app required for Apple CarPlay.
2. Connect your Android phone or Apple iPhone by using the factory-provided phone USB cable and plugging into a USB data port. For best performance, it is highly recommended to use the device's factory-provided USB cable, which should be replaced after significant wear to maintain connection quality. Aftermarket or third-party cables may not work.
3. When the phone is first connected, to activate Apple CarPlay or Android Auto, accept the terms and conditions on both the infotainment system and the phone.

4. Follow the instructions on the phone.

The Android Auto and Apple CarPlay icons on the infotainment home screen will illuminate. Android Auto and/or Apple CarPlay may automatically launch the next time the USB is connected. If not, select the Android Auto or Apple CarPlay icon on the infotainment home screen to launch.

Select  on the center stack to return to the infotainment home screen.

### For Wireless Phone Projection

Verify your phone is wireless compatible by visiting the Android Auto or Apple CarPlay support page.

1. For Android 9 smartphones and older, download the Android Auto app to your phone from the phones Google Play Store. There is no app required for Apple CarPlay.
2. For first time connection, make sure Bluetooth and WiFi are turned on in phone settings. To connect the phone over Bluetooth, see *Bluetooth (Pairing and Using a Phone)* ⇨ 154 *Bluetooth (Overview)* ⇨ 153.

3. When the phone is first connected, to activate Apple CarPlay or Android Auto, agree to the terms and conditions on both the infotainment system and the phone.

4. Follow the instructions on the phone.

The Android Auto and Apple CarPlay icons on the infotainment home screen will illuminate. Android Auto and/or Apple CarPlay may automatically launch upon wireless connection. If not, select the Android Auto or Apple CarPlay icon on the infotainment home screen to launch.

Wireless CarPlay and/or Wireless Android Auto may experience occasional service disruption due to outside Wi-Fi interference.

To disconnect the phones wireless projection for that paired device:



1. Select the Settings from the infotainment home screen.
2. Select Connections.
3. Select Phones.
4. Select the Bluetooth icon or Options on the phone card.
5. Select Connection Type from the list and choose Bluetooth Calling and Media.

Select  on the center stack to return to the infotainment home screen.

Features are subject to change. For further information on how to set up Android Auto and Apple CarPlay in the vehicle, visit your brand website. See *Online Account and Customer Support* ⇨ 381 for details.

CarPlay will not support Fast Connect on iPhones with iOS version 13 or older.

Android Auto is provided by Google and is subject to Google's terms and privacy policy. Apple CarPlay is provided by Apple and is subject to Apple's terms and privacy policy. Data plan rates apply. For Android Auto support and to see if your phone is compatible, see [www.android.com/auto/](http://www.android.com/auto/) compatability. For Apple CarPlay support and to see if your phone is compatible, see [www.apple.com/ios/carplay/](http://www.apple.com/ios/carplay/). Apple or Google may change or suspend availability at any time. Google, Android, Android Auto, Google Maps, and other marks are trademarks of Google LLC. Apple CarPlay is a trademark of Apple Inc.

Select  on the center stack to exit Android Auto or Apple CarPlay. To enter back into Android Auto or Apple CarPlay, press and hold  on the center stack.

If applicable, Android Auto and/or Apple CarPlay may be disabled from the infotainment system. To do this, select Home > Settings > Connections. Scroll down the list to find Android Auto or Apple CarPlay. Use the On/Off toggle to turn Android Auto or Apple CarPlay on or off for the entire system.

## Settings

To access the Settings menus:

1. Touch Settings on the infotainment home screen.
2. Touch the desired category to display a list of available options.
3. Touch to select the desired feature setting.
4. Touch the options on the infotainment display to change a setting.
5. Touch  to go back.

The Settings menu may contain the following:



**Connections**

The menu may contain the following:

**Phones**

Allows connecting to a different cell phone or mobile device source, disconnecting a cell phone or media device, or deleting a cell phone or media device.

**Wi-Fi Networks**

Shows connected and available Wi-Fi networks.

**Wi-Fi Hotspot**

Allows adjustment of different Wi-Fi features.

**Vehicle-to-Phone Sharing**

Allows GM apps to use vehicle data on the listed phones shown.

**Trusted Device**

Allows for setting a phone as your trusted device to establish a secure communication channel between your phone and vehicle that enables convenient features like instant profile unlocking and account sign in. When nearby, your trusted device is recognized automatically via a unique Bluetooth connection. Requires MyBrand app.

**Vehicle**

The menu may contain the following:

**Audio Settings**

Allows adjustment of different audio settings.

**Teen Driver**

See *Teen Driver* ⇨ 161.

**Rear Seat Reminder**

Allows for a chime and a message when the rear door has been opened before or during operation of the vehicle.

**Buckle to Drive**

This feature can prevent shifting out of (P) Park when the driver's, and if applicable the front passenger's, seat belt is not buckled. See *Buckle To Drive* ⇨ 46.

**Climate and Air Quality**

Allows adjustment of different climate settings.

**Collision/Detection Systems**

Allows adjustment of different driver assistance system settings.

**Comfort and Convenience**

Allows adjustment of different comfort and convenience settings.

**Lighting**

Allows adjustment of different lighting settings.

**Power Door Locks**

Allows adjustment of different door lock settings.

**Remote Lock, Unlock, and Start**

Allows adjustment of different remote lock settings.

**Seating Position**

Allows adjustment of different seating position settings.

**Date/Time**

Allows setting of the clock.

**Notifications**

Allows setting of the notification settings.

**Display**

Allows adjustment of the infotainment display.

**Sounds**

Allows adjustment of the infotainment system sounds.

**Profiles and Accounts**

Modifies the infotainment system's profiles and provides access to the accounts assigned to the currently active profile.

**Privacy**

This menu allows adjustment of the infotainment privacy settings.

**Accessibility**

This menu shows the accessibility information on the infotainment system.

**Assistant and Voice**

This menu shows the assistant and voice settings.

**Storage**

This menu shows the storage info on the infotainment system.

**Security**

This menu allows adjustment of the infotainment security settings.

**Apps**

Shows a list of installed apps used.

**System**

The menu may contain the following:

**Language**

This will set the display language used on the infotainment display.

**Keyboard and Speech**

Touch to change keyboard and speech settings.

**Units**

Touch to change units settings.

**Reset Options**

Touch to change reset settings.

**TTY Mode**

Touch to turn off or on.

**About**

Touch to view the infotainment system software information.

**Legal Information**

Touch to view legal and license information.

**Updates**

This menu allows adjustment of the vehicle update settings.

**Google**

This menu allows adjustment of the Google settings.

**Teen Driver**

If equipped, this allows multiple keys to be registered for beginner drivers to encourage safe driving habits. When the vehicle is started with a Teen Driver key, it will automatically activate certain safety systems, allow setting of some features, and limit the use of others. The Report Card will record vehicle data about driving behavior that can be viewed later. When the vehicle is started with a registered key, the Driver Information Center (DIC) displays a message that Teen Driver is active.

**To access:**

1. Touch Settings on the infotainment home screen, then touch Vehicle, and then Teen Driver.
2. Create a Personal Identification Number (PIN) by choosing a four-digit PIN. Re-enter the PIN to confirm. To change the PIN, touch Change PIN.

**The PIN is required to:**

- Set up/Add or remove keys.
- Change Teen Driver settings.
- Change or clear the Teen Driver PIN.
- Access or delete Report Card data.

**Set up/Add keys to activate Teen Driver and assign restrictions to the key:**

Any vehicle key can be registered, up to a maximum of eight keys. Label the key to tell it apart from the other keys.

**For a pushbutton start system:**

1. Start the vehicle.

2. For automatic transmissions, the vehicle must be in P (Park). For manual transmissions, the vehicle must be stopped with the parking brake set.
3. From the Settings menu, touch Vehicle and then Teen Driver.
4. Enter the PIN.
5. Place the remote key you wish to register in the transmitter pocket. The key does not need to be the one that started the vehicle.
6. From the Teen Driver menu, touch Setup Keys or Add/Remove Teen Driver Keys.
  - If the remote key has not previously been registered, the option to add the key displays. Touch Add and a confirmation message displays. Teen Driver restrictions will be applied whenever this remote key is used to operate the vehicle.
  - If the remote key has already been registered, the option to remove the key displays. If Remove is touched, the remote key is no longer registered. A confirmation message displays, and Teen Driver restrictions will not be applied if this remote key is used to operate the vehicle.

In vehicles with a pushbutton start system, if a Teen Driver and a non-Teen Driver key are both present at start up, the vehicle will recognize the non-Teen Driver key to start the vehicle. The Teen Driver settings will not be active.

**For a keyed ignition system:**

1. Start the vehicle.
2. For automatic transmissions, the vehicle must be in P (Park). For manual transmissions, the vehicle must be stopped with the parking brake set.
3. From the Settings menu, touch Vehicle and then Teen Driver.
4. Enter the PIN.
5. Touch Setup Keys or Add/Remove Teen Driver Keys. The system displays instructions for registering or unregistering a key. A confirmation message displays.

**Manage Settings or Teen Driver Settings**

Depending on the options of your vehicle, the following menu items may be displayed:

**Buckle to Drive :** When turned ON, Buckle to Drive prevents the driver from shifting out of P (Park) for a period of time after the

brake pedal is pressed if the driver, or on some vehicles the detected passenger, has not buckled their seat belt. On some vehicles, Buckle to Drive is always ON when Teen Driver is active and is not configurable.

**Audio Volume Limit** : Allows a maximum audio volume to be set. Turn the audio volume limit on or off. Use the arrows to choose the maximum allowable level for the audio volume. On some infotainment systems, touch Set Audio Volume Limit to choose the maximum allowable audio volume level.

**Set Audio Volume Limit** : Use the arrows to choose the maximum allowable level for the audio volume.

**Teen Driver Speed Limiter** : Limits the maximum speed of the vehicle. When the speed limiter is turned on and the vehicle is started with a Teen Driver key, the DIC displays a message that the top speed is limited.

On certain vehicles, when the Speed Limiter is turned ON, the vehicle's maximum acceleration will be limited. The DIC will display a message that the acceleration is limited.

**Teen Driver Speed Warning** : Displays a warning in the DIC when exceeding a selectable speed. Turn the speed warning on or off and choose the desired speed warning

level. The speed warning does not limit the speed of the vehicle. On some infotainment systems, touch Set Teen Driver Speed Warning to set the warning speed.

**Set Teen Driver Speed Warning** : Choose the desired speed warning level. The speed warning does not limit the speed of the vehicle.

#### **When Teen Driver is Active:**

- If equipped, the radio will mute when the driver seat belt, and in some vehicles the front passenger seat belt, is not buckled. The audio from any device paired to the vehicle will also be muted.
- An object placed on the front passenger seat, such as a briefcase, handbag, grocery bag, laptop, or other electronic device, could cause the passenger sensing system to falsely sense an unbuckled front passenger and mute the radio. If this happens, remove the object from the seat.
- Some safety systems, such as Automatic Emergency Braking, if equipped, cannot be turned off.
- The gap setting for Adaptive Cruise Control and alert timing for Forward Collision Alert, if equipped, cannot be changed.

- When trying to change a safety feature that is not configurable in Teen Driver, the feature may be grayed out or removed from the infotainment menu, or the DIC will display a message indicating that Teen Driver is active and the action is not available.
- Super Cruise, if equipped, is not available.
- Enhanced Low Fuel Warning (if equipped) – When the vehicle is low on fuel, the low fuel light on the instrument cluster flashes and the DIC low fuel warning cannot be dismissed.
- Do not tow a trailer if equipped with Automatic Emergency Braking.

#### **Report Card**

The vehicle owner must secure the driver's consent to record certain vehicle data when the vehicle is driven with a registered Teen Driver key. There is one Report Card per vehicle. Data is only recorded when a registered Teen Driver key is used to operate the vehicle.

The Report Card data is collected from the time Teen Driver is activated or the last time the Report Card was reset. The following items may be recorded:

- Distance Driven – the total distance driven.
- Maximum Speed – the maximum vehicle speed detected.
- Overspeed Warnings – the number of times the speed warning setting was exceeded.
- Wide Open Throttle – the number of times the accelerator pedal was pressed nearly all the way down.
- Forward Collision Alerts (if equipped) – the number of times the driver was notified when approaching a vehicle ahead too quickly and at potential risk for a crash.
- Forward Automatic Braking, also called Automatic Emergency Braking (if equipped) – the number of times the vehicle detected that a forward collision was imminent and applied the brakes.
- Reverse Automatic Braking (if equipped) – the number of times the vehicle detected that a rearward collision was imminent and applied the brakes.
- Traction Control – the number of times the Traction Control System activated to reduce wheel spin or loss of traction.

- Stability Control – the number of events which required the use of electronic stability control.
- Antilock Braking System Active – The number of Antilock Brake System activations.
- Tailgating Alerts (if equipped) – the number of times the driver was alerted for following a vehicle ahead too closely.

### Report Card Data

Cumulative Data is saved for all trips until the Report Card is reset or until the maximum count is exceeded. If the maximum count is exceeded for a Report Card line item, that item will no longer be updated in the Report Card until it is reset. Each item will report a maximum of 1,000 counts. The distance driven will report a maximum of 64 374 km (40,000 mi).

To delete Report Card data, do one of the following:

- From the Report Card display, touch Reset.
- Touch Clear PIN and All Teen Driver Keys from the Teen Driver menu. This will also unregister any Teen Driver keys and delete the PIN.

### Forgotten PIN

See your dealer to reset the PIN.

## Trademarks and License Agreements

### FCC Information

See *Radio Frequency Statement* ⇨ 387.



"Made for iPhone" means that an electronic accessory has been designed to connect specifically to iPhone, and has been certified by the developer to meet Apple performance standards. Apple is not responsible for the operation of this device or its compliance with safety and regulatory standards. Please note that the use of this accessory with iPhone may affect wireless performance. iPhone are trademarks of Apple Inc., registered in the U.S. and other countries.



Trial length and service availability may vary by model, model year, or trim. Service will automatically stop at the end of your trial subscription period unless you decide to continue service. If you do not wish to enjoy your trial, you can cancel by calling the number below. All SiriusXM services require a subscription, each sold separately by SiriusXM after the trial period. Service subject to the applicable SiriusXM Customer Agreement and Privacy Policy, visit [www.siriusxm.com](http://www.siriusxm.com) (USA) or [www.siriusxm.ca](http://www.siriusxm.ca) (Canada) to see complete terms and how to cancel which includes calling 1-866-635-2349 (USA) or 1-888-539-7474 (Canada). Some services and features are subject to device capabilities and location availability. Content varies by SiriusXM subscription package. All fees, content, and features are subject to change.

SiriusXM with 360L: Some features, including streaming content and listening recommendations, require an active OnStar Connected Access plan and may vary by vehicle model. Content varies by SiriusXM subscription plan. GM connected vehicle services vary by vehicle model and require active service plan, working electrical system, cell reception, and GPS signal. See [onstar.com](http://onstar.com) for details and limitations.

SiriusXM, Pandora, Stitcher, and all related logos are trademarks of Sirius XM Radio Inc. and its respective subsidiaries.

SiriusXM satellite service is only available in the 48 contiguous United States (and Puerto Rico with limited availability) and Canada.

In Canada: Some deterioration of service may occur in extreme northern latitudes. This is beyond the control of SiriusXM.

Explicit Language Notice: Channels with frequent explicit language are indicated with an “XL” preceding the channel name. Family-friendly packages are available by contacting SiriusXM:

- USA Customers — See [www.siriusxm.com](http://www.siriusxm.com) or call 1-888-601-6296.

- Canada Customers — See [www.siriusxm.ca](http://www.siriusxm.ca) or call 1-877-438-9677.

It is prohibited to copy, decompile, disassemble, reverse engineer, hack, manipulate, or otherwise make available any technology or software incorporated in receivers compatible with the SiriusXM Satellite Radio System or that support the SiriusXM website, the Online Service or any of its content.

General Requirements:

1. A License Agreement from SiriusXM is required for any product that incorporates SiriusXM Technology and/or for use of any of the SiriusXM marks to be manufactured, distributed, or marketed in the SiriusXM Service Area.
2. For products to be distributed, marketed, and/or sold in Canada, a separate agreement is required with Sirius XM Canada Inc.



immersion.

TouchSense Technology and TouchSense System 1000 Series Licensed from Immersion Corporation. TouchSense System 1000 protected under one or more of the U.S. Patents at the following address [www.immersion.com/patent-marking.html](http://www.immersion.com/patent-marking.html) and other patents pending.

### **Bluetooth**

The Bluetooth word mark and logos are owned by the Bluetooth SIG, Inc. and any use of such marks by General Motors is under license. Other trademarks and trade names are those of their respective owners.

### **Java**

Java is a registered trademark of Oracle and/or its affiliates.

### **MPEG4–AVC (H.264)**

THIS PRODUCT IS LICENSED UNDER THE AVC PATENT PORTFOLIO LICENSE FOR THE PERSONAL AND NON-COMMERCIAL USE OF A CONSUMER TO (i) ENCODE VIDEO IN COMPLIANCE WITH THE AVC STANDARD (“AVC VIDEO”) AND/OR (ii) DECODE AVC VIDEO THAT WAS ENCODED BY A CONSUMER ENGAGED IN A PERSONAL AND NON-COMMERCIAL ACTIVITY AND/OR WAS OBTAINED FROM A VIDEO

PROVIDER LICENSED TO PROVIDE AVC VIDEO. NO LICENSE IS GRANTED OR SHALL BE IMPLIED FOR ANY OTHER USE. ADDITIONAL INFORMATION MAY BE OBTAINED FROM MPEG LA, L.L.C. SEE [HTTPS://WWW.MPEGLA.COM](https://www.mpegla.com).

### **MPEG4–Visual**

USE OF THIS PRODUCT IN ANY MANNER THAT COMPLIES WITH THE MPEG-4 VISUAL STANDARD IS PROHIBITED, EXCEPT FOR USE BY A CONSUMER ENGAGING IN PERSONAL AND NON-COMMERCIAL ACTIVITIES.

### **MP3**

MPEG Layer-3 audio coding technology licensed from Fraunhofer IIS and Thomson.

### **WMV/WMA**

This product includes technology owned by Microsoft Corporation and under a license from Microsoft Licensing, GP. Use or distribution of such technology outside of this product is prohibited without a license from Microsoft Corporation and/or Microsoft Licensing, GP as applicable.

## Climate Controls

### Climate Control Systems

Dual Automatic Climate Control System ..167

### Air Vents

Air Vents ..... 170

### Maintenance

Passenger Compartment Air Filter .....171

Service .....171

## Climate Control Systems

### Dual Automatic Climate Control System

The climate control buttons on the center stack and on the climate control display are used to adjust the heating, cooling, and ventilation.

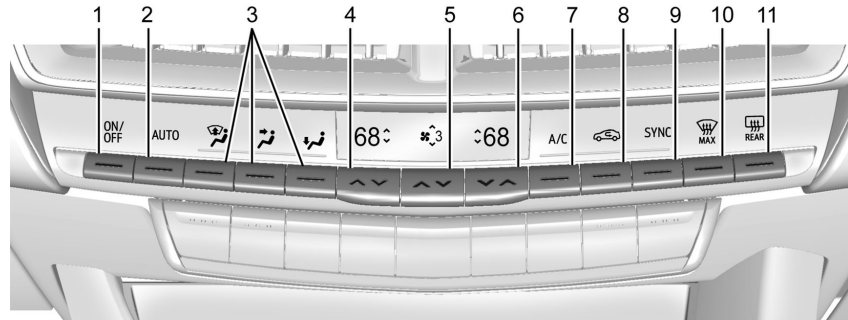

1. ON/OFF (Power)
2. AUTO (Automatic Operation)
3. Air Delivery Mode Control
4. Driver Temperature Controls
5. Fan Control
6. Passenger Temperature Controls
7. A/C (Air Conditioning)
8. Recirculation
9. SYNC (Synchronized Temperature)
10. Defrost
11. Rear Window Defogger



## Climate Control Display

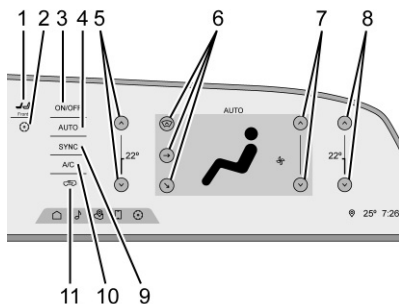

The fan, air delivery mode, air conditioning, temperature, and SYNC settings can be controlled by touching CLIMATE on the infotainment home screen.

1. Front or Rear (If equipped) Climate Control Selection
2. Personalization Settings
3. On/Off (Power)
4. AUTO (Automatic Operation)
5. Driver Temperature
6. Air Delivery Mode Controls
7. Fan Control

8. Passenger Temperature
9. SYNC (Synchronized Temperature)
10. Air Conditioning
11. Recirculation

## Automatic Operation

The system automatically controls the fan speed, air delivery, air conditioning, and recirculation to heat or cool the vehicle to the desired temperature.

When AUTO is selected, the system is in full automatic operation. AC or HEAT will be highlighted to indicate the system is automatically cooling or heating. Turning off the indicated button turns off that function resulting in fan operation only. If the air delivery mode or fan setting is manually adjusted, the auto indicator turns off and the display shows the selected settings. Auto operation can be turned off individually for climate settings.

For automatic operation:

1. Press AUTO.
2. Set the temperature. Allow the system time to stabilize. Adjust the temperature as desired.

To improve efficiency and to warm or cool the vehicle faster, recirculation is automatically selected. The recirculation light will not come on. Press  to select recirculation; press it again to select outside air.

**ON/OFF:** Press OFF to turn the fan on or off. When OFF is selected, the system stops air from flowing into the cabin. If ON is selected or any other buttons are pressed, the climate control system will turn on and operate at the current setting.

**^ / v :** The temperature can be adjusted separately for the driver and the passenger. Press to decrease or lift to increase the temperature. Press or lift and hold to rapidly increase or decrease the temperature. Press SYNC on the Climate Display to reset the Passenger Temperature to the Driver Temperature.

**SYNC:** Touch SYNC on the climate control display to link all climate zone settings to the driver settings. Adjust the driver side temperature control to change the linked temperature. When the passenger setting is adjusted, SYNC turns off.

## Manual Operation

 : Press to decrease or lift to increase the fan speed. Press or lift and hold the fan controls to adjust speed more quickly. The fan speed setting displays. Any adjustment of the fan speed cancels automatic fan control and the fan can be controlled manually. Press AUTO to return to automatic operation.

To turn off the fan and climate control system, press OFF on the center stack climate controls. The airflow will be blocked from entering in all air delivery modes, except defrost.

The maximum automatic fan speed can be set to low, medium, or high. To adjust the automatic fan speed select Settings > Vehicle > Climate > Auto Fan Speed.



**Air Delivery Mode Controls:** When the climate information is displayed, press the desired air delivery mode on the climate control display to change the direction of the airflow. The selected air delivery mode button is lit. Pressing any of the air delivery buttons cancels automatic air delivery control and the direction of the airflow can be controlled manually. Press AUTO to return to automatic operation.

To change the current mode, select one or more of the following:

 : Air is directed to the windshield, outboard A/C outlets, and side window outlets.

 : Air is directed to the instrument panel outlets.

 : Air is primarily directed to the floor outlets, with some air directed to the windshield, outboard A/C outlets, and side window outlets.

 : Clears the windshield of fog or frost more quickly. Air is directed to the windshield. Press  to turn on or off. Changing the air delivery mode also turns the defrost off.

**A/C:** Touch A/C on the climate control display to turn the automatic air conditioning on or off. If the fan is turned off or the outside temperature falls below freezing, the air conditioner will not run.

Press AUTO to return to automatic operation and the air conditioner runs as needed.

**Automatic Air Recirculation:** When the AUTO indicator light is on, the air is automatically recirculated as needed to help quickly cool the inside of the vehicle.

 : Press to alternate between recirculating air inside the vehicle or pulling in outside air. The indicator light on the button is lit when

recirculation mode is active. This helps to quickly cool the air inside the vehicle and reduce the entry of outside air and odors. Pressing this button cancels automatic recirculation. Press AUTO to return to automatic operation; recirculation runs automatically as needed.

Manual recirculation mode is not available when in Defrost or some air distribution modes with air to the windshield.

**Auto Defog:** The climate control system uses a sensor to automatically detect high humidity inside the vehicle. When high humidity is detected, the climate control system may adjust to outside air supply, turn on the air conditioner, and direct more air to the windshield. If the climate control system does not detect possible window fogging, it returns to normal operation. To turn Auto Defog off or on, select Settings > Climate and Air Quality > Auto Defog > Select ON or OFF.

## Rear Window Defogger

 : Press to turn the rear window defogger on or off. An indicator light on the button comes on to show that the rear window defogger is on.

The defogger can be turned off by turning the vehicle off or to accessory mode.

To turn Auto Rear Defog off or on, select Settings > Climate and Air Quality > Auto Rear Defog > Select ON or OFF. When auto rear defog is selected, the rear window defogger turns on automatically when the interior temperature is cold and the outside temperature is about 7 °C (44 °F) and below. The auto rear defogger turns off automatically.

If equipped, the heated outside mirrors turn on when the rear window defogger button is on and help to clear fog or frost from the surface of the mirror. See *Heated Mirrors* ⇨ 27.

### Caution

Do not try to clear frost or other material from the inside of the front windshield and rear window with a razor blade or anything else that is sharp. This may damage the rear window defogger grid and affect the radio's ability to pick up stations clearly. The repairs would not be covered by the vehicle warranty.

**Remote Start Climate Control Operation:** If equipped with remote start, the climate control system may run when the vehicle is started remotely. If equipped with heated or ventilated seats or a heated steering wheel, these features may come on during a remote start. See *Remote Start* ⇨ 12, *Heated and Ventilating Front Seats* ⇨ 42, and *Heated Steering Wheel* ⇨ 85.

### Sensor

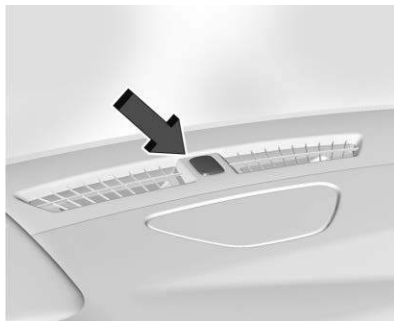

The solar sensor, on top of the instrument panel near the windshield, monitors the solar intensity.

The climate control system uses the sensor information to adjust the temperature, fan speed, recirculation, and air delivery mode for best comfort.

If the sensor is covered, the automatic climate control system may not work properly.

### Afterblow Feature

If equipped, under certain conditions, the fan may stay on or may turn on and off several times after you turn off and lock the vehicle. This is normal.

### Air Vents

Adjustable air vents are in the center and on the sides of the instrument panel, and on the rear of the center console storage.

Move the slider knobs to change the direction of or to close off the airflow.

### Operation Tips

- Clear away any ice, snow, or leaves from air inlets at the base of the windshield that could block the flow of air into the vehicle.
- Clear snow off the hood to improve visibility and help decrease moisture drawn into the vehicle.

- Keep the path under the front seats clear of objects to help circulate the air inside of the vehicle more effectively.
- Use of non-GM approved hood deflectors can adversely affect the performance of the system. Check with your dealer before adding equipment to the outside of the vehicle.
- Do not attach any devices to the air vent slats. This restricts airflow and may cause damage to the air vents.

## Maintenance

### Passenger Compartment Air Filter

The filter reduces dust, pollen, and other airborne irritants from outside air that is pulled into the vehicle. The filter should be replaced as part of routine scheduled maintenance. See your dealer regarding replacement of the filter.

### Service

All vehicles have a label underhood that identifies the refrigerant used in the vehicle. The refrigerant system should only be serviced by trained and certified technicians. The air conditioning evaporator should never be

repaired or replaced by one from a salvage vehicle. It should only be replaced by a new evaporator to ensure proper and safe operation.

During service, all refrigerants should be reclaimed with proper equipment. Venting refrigerants directly to the atmosphere is harmful to the environment and may also create unsafe conditions based on inhalation, combustion, frostbite, or other health-based concerns.

## Driving and Operating

### Driving Information

Driving for Better Fuel Economy .....	173
Distracted Driving .....	173
Defensive Driving .....	174
Impaired Driving .....	174
Control of a Vehicle .....	174
Braking .....	174
Steering .....	175
Off-Road Recovery .....	176
Loss of Control .....	176
Track Events and Competitive Driving (V-Series and V-Series Blackwing) .....	176
Driving on Wet Roads .....	184
Hill and Mountain Roads .....	185
Winter Driving .....	186
If the Vehicle Is Stuck .....	187
Vehicle Load Limits .....	187

### Starting and Operating

New Vehicle Break-In .....	191
Composite Materials .....	192
Ignition Positions .....	192
Starting the Engine .....	193
Stop/Start System .....	195
Engine Heater .....	196
Retained Accessory Power (RAP) .....	197
Shifting Into Park .....	197

Shifting out of Park .....	198
Parking (Manual Transmission) .....	198
Parking over Things That Burn .....	198
Active Fuel Management .....	198
Extended Parking .....	198

### Engine Exhaust

Engine Exhaust .....	199
Running the Vehicle While Parked .....	199

### Automatic Transmission

Automatic Transmission .....	200
Manual Mode .....	203

### Manual Transmission

Manual Transmission .....	204
Active Rev Match .....	206

### Drive Systems

All-Wheel Drive .....	207
-----------------------	-----

### Brakes

Electric Brake Boost .....	207
Antilock Brake System (ABS) .....	207
Electric Parking Brake .....	208
Brake Assist .....	209
Hill Start Assist (HSA) .....	209
Automatic Vehicle Hold (AVH) .....	209

### Ride Control Systems

Traction Control/Electronic Stability Control .....	210
Driver Mode Control .....	211

Performance Driving .....	217
Limited-Slip Differential .....	221

### Cruise Control

Cruise Control .....	221
Speed Limiter .....	223
Adaptive Cruise Control (Advanced) .....	225
Super Cruise .....	235

### Advanced Driver Assistance Systems

Advanced Driver Assistance Systems .....	250
Assistance Systems for Parking or Backing .....	251
Rear Vision Camera (RVC) .....	251
Surround Vision System .....	252
Park Assist .....	253
Automatic Parking Assist (APA) .....	255
Reverse Automatic Braking (RAB) .....	257
Rear Pedestrian Alert .....	258
Rear Cross Traffic Alert (RCTA) System .....	258
Assistance Systems for Driving .....	259
Forward Collision Alert (FCA) System .....	259
Automatic Emergency Braking (AEB) .....	261
Front Pedestrian Braking (FPB) System .....	264
Side Blind Zone Alert (SBZA) .....	266
Lane Change Alert (LCA) .....	266
Blind Zone Steering Assist (BZSA) .....	268
Traffic Sign Assistant .....	269
Driver Attention Assist .....	270

Lane Keep Assist (LKA) .....	272
Surround Vision Recorder .....	273

## Fuel

Top Tier Fuel .....	275
Recommended Fuel (LSY 2.0L I4 Engine) ..	275
Recommended Fuel (LGY 3.0L V6 and LT4 6.2L V8 Engines) .....	276
Prohibited Fuels .....	276
Fuels in Foreign Countries .....	276
Fuel Additives .....	276
Filling the Tank .....	277
Filling a Portable Fuel Container .....	278

## Trailer Towing

General Towing Information .....	278
Driving Characteristics and Towing Tips ..	279
Trailer Towing (LSY 2.0L I4 and LGY 3.0L V6 Engines Only) .....	282
Towing Equipment .....	284

## Conversions and Add-Ons

Add-On Electrical Equipment .....	285
-----------------------------------	-----

## Driving Information

### Driving for Better Fuel Economy

Driving habits can affect fuel mileage. Here are some driving tips to get the best fuel economy possible:

- Set the climate controls to the desired temperature after the engine is started, or turn them off when not required.
- Avoid fast starts and accelerate smoothly.
- Brake gradually and avoid abrupt stops.
- Avoid idling the engine for long periods of time.
- When road and weather conditions are appropriate, use cruise control.
- Always follow posted speed limits or drive more slowly when conditions require.
- Keep vehicle tires properly inflated.
- Combine several trips into a single trip.
- Replace the vehicle's tires with the same TPC Spec number molded into the tire's sidewall near the size.
- Follow recommended scheduled maintenance.

### Distracted Driving

Distraction comes in many forms and can take your focus from the task of driving. Exercise good judgment and do not let other activities divert your attention away from the road.

Many local governments have enacted laws regarding driver distraction. Become familiar with the local laws in your area.

To avoid distracted driving, keep your eyes on the road, keep your hands on the steering wheel, and focus your attention on driving.

- Do not use a phone in demanding driving situations. Use a hands-free method to place or receive necessary phone calls.
- Watch the road. Do not read, take notes, or look up information on phones or other electronic devices.
- Designate a front seat passenger to handle potential distractions.
- Become familiar with vehicle features before driving, such as programming favorite radio stations and adjusting climate control and seat settings. Program all trip information into any navigation device prior to driving.

- Wait until the vehicle is parked to retrieve items that have fallen to the floor.
- Stop or park the vehicle to tend to children.
- Keep pets in an appropriate carrier or restraint.
- Avoid stressful conversations while driving, whether with a passenger or on a cell phone.

### Warning

Taking your eyes off the road too long or too often could cause a crash resulting in injury or death. Focus your attention on driving.

Refer to the infotainment section for more information on using that system and the navigation system, if equipped, including pairing and using a cell phone.

## Defensive Driving

Defensive driving means to always expect the unexpected. The first step in driving defensively is to wear a seat belt. See *Seat Belts* ⇨ 45.

- Assume that other road users (pedestrians, bicyclists, and other drivers) are going to be careless and make mistakes. Anticipate what they may do and be ready.
- Allow enough following distance between your vehicle and the vehicle in front of you.
- Focus on the task of driving.

## Impaired Driving

Death and injury associated with impaired driving is a global tragedy.

### Warning

Drinking alcohol or taking drugs and then driving is very dangerous. Your reflexes, perceptions, attentiveness, and judgment can be affected by even a small amount of alcohol or drugs. You can have a serious — or even fatal — collision if you drive after drinking or taking drugs.

Do not drive while under the influence of alcohol or drugs, or ride with a driver who has been drinking or is impaired by drugs. Find alternate transportation home; or if you are with a group, designate a driver who will remain sober.

## Control of a Vehicle

Braking, steering, and accelerating are important factors in helping to control a vehicle while driving.

## Braking

Braking action involves perception time and reaction time. Deciding to push the brake pedal is perception time. Actually doing it is reaction time.

Average driver reaction time is about three-quarters of a second. In that time, a vehicle moving at 100 km/h (60 mph) travels 20 m (66 ft), which could be a lot of distance in an emergency.

Helpful braking tips to keep in mind include:

- Keep enough distance between you and the vehicle in front of you.
- Avoid needless heavy braking.
- Keep pace with traffic.

If the engine ever stops or a brake fault occurs, the brakes may lose power assist. More effort will be required to stop the vehicle and it can take longer to stop.

## Steering

### Caution

To avoid damage to the steering system, do not drive over curbs, parking barriers, or similar objects at speeds greater than 3 km/h (1 mph). Use care when driving over other objects such as lane dividers and speed bumps. Damage caused by misuse of the vehicle is not covered by the vehicle warranty.

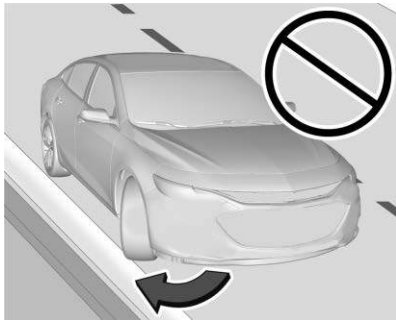

### Variable Effort Steering

The vehicle has a steering system that varies the amount of effort required to steer the vehicle in relation to the speed of the vehicle.

The amount of steering effort required is less at slower speeds to make the vehicle more maneuverable and easier to park. At faster speeds, the steering effort increases to provide a sport-like feel to the steering. This provides maximum control and stability.

### Electric Power Steering

The vehicle is equipped with an electric power steering system, which reduces the amount of effort needed to steer the vehicle. It does not have power steering fluid. Regular maintenance is not required.

If the vehicle experiences a system malfunction and loses power steering, greater steering effort may be required. Power steering assist also may be reduced if you turn the steering wheel as far as it can turn and hold it there with force for an extended period of time.

See your dealer if there is a problem.

### Curve Tips

- Take curves at a reasonable speed.

- Reduce speed before entering a curve.
- Maintain a reasonable steady speed through the curve.
- Wait until the vehicle is out of the curve before accelerating gently into the straightaway.

### Steering in Emergencies

- There are some situations when steering around a problem may be more effective than braking.
- Holding both sides of the steering wheel allows you to turn 180 degrees without removing a hand.
- Antilock Brake System (ABS) allows steering while braking.



## Off-Road Recovery

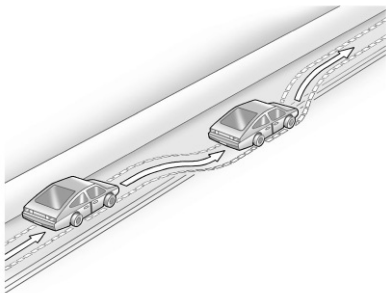

The vehicle's right wheels can drop off the edge of a road onto the shoulder while driving. Follow these tips:

1. Ease off the accelerator and then, if there is nothing in the way, steer the vehicle so that it straddles the edge of the pavement.
2. Turn the steering wheel about one-eighth of a turn, until the right front tire contacts the pavement edge.
3. Turn the steering wheel to go straight down the roadway.

## Loss of Control

### Skidding

There are three types of skids that correspond to the vehicle's three control systems:

- Braking Skid — wheels are not rolling.
- Steering or Cornering Skid — too much speed or steering in a curve causes tires to slip and lose cornering force.
- Acceleration Skid — too much throttle causes the driving wheels to spin.

Antilock brakes help to avoid only the braking skid.

Defensive drivers avoid most skids by taking reasonable care suited to existing conditions, and by not exceeding those conditions. But skids are always possible.

If the vehicle starts to skid, follow these suggestions:

- Ease your foot off the accelerator pedal and steer the way you want the vehicle to go. The vehicle may straighten out, but if it skids again from oversteer, be ready to correct another skid if it occurs.

- Slow down and adjust your driving according to weather conditions. Stopping distance may be longer and vehicle control may be affected when traction is reduced by water, snow, ice, gravel, or other material on the road. Learn to recognize warning clues — such as enough water, ice, or packed snow on the road to make a mirrored surface — and slow down when you have any doubt.
- Try to avoid sudden steering, acceleration, or braking, including reducing vehicle speed by shifting to a lower gear. Any sudden changes could cause the tires to slide.

## Track Events and Competitive Driving (V-Series and V-Series Blackwing)

### Danger

High-performance features are intended for use only on closed tracks by experienced and qualified drivers and should not be

(Continued)

**Danger (Continued)**

used on public roads. High-speed driving, aggressive cornering, hard braking, and other high-performance driving can be dangerous. Improper driver inputs for the conditions may result in loss of control of the vehicle, which could injure or kill you or others. Always drive safely.

Track events and competitive driving may affect the vehicle warranty. See the warranty manual before using the vehicle for competitive driving.

 **Warning**

Some of the adjustments and procedures specified in this section may require specialized skill, training, and equipment. Failure to perform these procedures properly could cause malfunction, potentially resulting in death, personal injury, or damage to the vehicle or property. Do not attempt to perform these adjustments or procedures unless properly qualified.

 **Warning**

Prior to each track event and again before returning to public roads, tighten the wheel nuts with a torque wrench to the proper torque specification. Wheel nuts that are improperly or incorrectly tightened can cause the wheels to become loose or come off, resulting in a crash. See *Capacities and Specifications* ⇨ 375 for wheel nut torque specifications.

**Caution**

If the vehicle is used for track events and competitive driving, the engine may use more oil than it would with normal use. Low oil levels can damage the engine. Check the oil level often and maintain the proper level. See *Engine Oil* ⇨ 295.

Before any track event, there are three features that should be turned off:

- Automatic Emergency Braking (AEB). See *Automatic Emergency Braking (AEB)* ⇨ 261.

- Lane Keep Assist. See *Lane Keep Assist (LKA)* ⇨ 272.
- Adaptive Cruise Control. See *Adaptive Cruise Control (Advanced)* ⇨ 225.

Competitive Driving Mode can be selected. See *Driver Mode Control* ⇨ 211.

**Seat Belts****Lap-Shoulder Belt**

If equipped, the driver seat belt has an Automatic Locking Retractor (ALR). This feature is useful in performance driving scenarios where the driver wants to be held in the seat more tightly to take advantage of the aggressive bolstering of the seat.

1. Move the seat 8–10 cm (3–4 in) rearward from the normal driving position.
2. Pull the driver shoulder belt out as far as it will go, until it stops, to set the lock. While holding the shoulder belt in this position, buckle the belt.

When the shoulder belt is released, the retractor will make a ratchet sound when it retracts. When the retractor lock is set, the belt can be tightened but not pulled out of the retractor.

- Adjust the belt, and then move the seat forward 8–10 cm (3–4 in) to the desired driving position. This will secure the belt. The belt fit should be tight, but not uncomfortable.

To unlatch the belt, press the button on the buckle. The belt should return to its stowed position.

### Axle Fluid

#### Caution

During a first time track or racing event, high axle temperatures can occur. Damage could be caused to the axle and would not be covered by the vehicle warranty. Do not drive as long or as fast the first time the vehicle is driven on the track or raced.

Axles must have 2 400 km (1,500 mi) of use before being used in track driving.

The front, if equipped with AWD, and rear axle fluid temperatures may be higher than when driving in severe conditions. Drain and refill with new fluid after the first racing or

competitive driving event, and then after every 24 hours of racing or competitive driving. See your dealer for the correct fluid.

- The axle lubricant should be replaced with new lubricant.
- On vehicles without a differential cooler, additional cooling capacity is required for continuous competitive driving. The V-Series Blackwing has a differential cooler, so no additional cooling capacity is necessary.

### Engine Oil

#### Caution

If the vehicle is used for track events and competitive driving, the engine may use more oil than it would with normal use. Low oil levels can damage the engine. Check the oil level often and maintain the proper level. See *Engine Oil* ⇨ 295.

Check the oil level often during track events and competitive driving, and keep the oil level at or near the upper mark. See “Checking the Engine Oil” in *Engine Oil* ⇨ 295.

### LT4 Only

Racing or track use may cause additional oil consumption, and also cause the engine oil to degrade faster than the oil life monitor prediction. Frequently inspect the oil level during track use, and change the oil after the oil life monitor expires, or nine hours of total track time, whichever comes first.

### Fuel

Use premium unleaded gasoline with a posted octane rating of 93 at a track event. Unleaded gasoline with a posted octane rating of 91 may be used, but performance will be degraded. See *Prohibited Fuels* ⇨ 276.

### Automatic or Manual Transmission Fluid

Have the transmission fluid set to the full oil level prior to track usage. Transmission fluid should be changed after every 15 hours of track usage. Any transmission level set or change should be performed at your dealer.

## Brakes

### Battery Disconnect

#### Warning

To avoid personal injury and/or vehicle damage, always disconnect the battery before performing service work on the hydraulic brake system. Bleeding the brake system with the battery connected can lead to excessive pressurization of the system during automatic diagnostic tests or diagnosis of a leak or air in the braking system. A Diagnostic Trouble Code (DTC) may set and vehicle speed may be limited.

Disconnect the battery before servicing the hydraulic brake system. It is critical to disconnect the battery before bleeding the system, replacing the pads, or any other work. The battery must be disconnected to prevent the brake master cylinder from pressurizing the hydraulic system during its automated self diagnostic tests that may occur when a door is opened or the remote key is present.

### Brake Cooling (V-Series Blackwing)

Prior to any track event, high speed driving event, or competitive driving, complete the following:

1. Ensure all the brake cooling parts are correctly secured and installed.
2. Inspect and replace any deflectors that have damage.
3. Inspect for blockage in the front brake cooling duct prior to every event.
4. Remove front tire deflector (if equipped).

If improved brake cooling is desired on vehicles with cast-iron brakes (RPO JGH), install the ball joint protector front shields, remove both upper and lower rear rotor shields, and install the rear lower control arm cooling deflectors, per the instructions included with the brake cooling kit. These parts are for track use only. After track events, reinstall the original front and rear rotor shields and remove the rear lower control arm cooling deflectors.

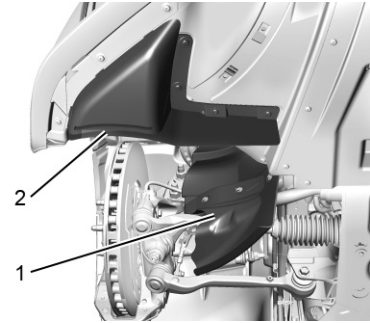

Right Side Front Shown, Left Side Front Similar

1. Front Lower Control Arm Deflector
2. Remove – Front Tire Deflector



### 3. Front Brake Cooling Duct

#### Brake Pad Wear Sensors

If equipped, the brake pad wear sensors need to be removed from the brake calipers prior to any track or racing event. The original sensors can be reinstalled if significant brake pad wear is not observed. Refer to *Brake Pad Life System (If Equipped)* ⇨ 310. If the sensors are not reinstalled after the track event, install brake pad wear sensor plugs. See your dealer.

The V-Series Blackwing is equipped with brake pad wear sensors which are track capable and should not be disabled for track and racing. A message will display in the Driver Information Center (DIC) when the brake pads show excessive wear.

#### Brake Fluid

Replace existing brake fluid with a qualified DOT 4 high performance brake fluid from a sealed container. Brake fluid with a dry boiling point >310 °C (590 °F) is qualified. If high performance brake fluid is used, replace it with GM approved brake fluid before driving on public roads. If high performance brake fluid is in the vehicle and the age of the brake fluid is over a month old or unknown,

replace the brake fluid before track events and competitive driving. Do not use silicone or DOT 5 brake fluids.

It is critical to disconnect the battery before bleeding the system, replacing the pads, or any other work. The battery must be disconnected to prevent the brake master cylinder from pressurizing the hydraulic system during its automated self diagnostic tests that can possibly occur when a door is opened or the remote key is present.

Check the fluid level before each competitive driving event.

#### Brake System Flushing & Bleeding

The J56 brake system requires specific processes for bleeding and fluid flushing. These can be found in the service manual.

Properly bleeding the brake system is required for proper operation of the hydraulic brake system.

#### Brake Leak Detection

The hydraulic braking system has advanced diagnostic capability to help detect hydraulic leaks, trapped air, and other performance issues. These diagnostics are active when the hydraulic system is powered. In order to avoid

inadvertently setting a leak Diagnostic Trouble Code (DTC), disconnect the battery before servicing the brake system.

If the vehicle sets a DTC related to a brake system leak, the Brake System Warning Light will come on and vehicle speed may be limited to 100 kph (62 mph). Any time a leak DTC is set, the vehicle should be inspected carefully for evidence of a leak and should be repaired immediately. See your dealer.

#### Brake Fade Warning Assist

The Brake Fade Warning Assist system monitors the performance of the brake system. If the system detects brake fade, or if the brake fluid is near the boiling point, the driver will be alerted.

The Brake Fade Warning Assist system is designed for use with the factory-installed brake pads or GM approved replacement pads. If the brake pads on the vehicle need to be replaced, use GM approved brake pads. If this is not done, the brake fade warning system may not function properly.

**Stage 1:** The DIC displays a “Reduce Braking to Avoid Overheating” message, a chime sounds and brake pedal effort and travel is increased. When the message displays, the driver should

back up braking points and reduce brake usage in order to reduce brake temperature. This will allow for continued lapping with no speed limitations.

**Stage 2:** The DIC displays a Brakes Overheated Service Now message, a chime sounds, and brake pedal effort and travel is further increased. This code indicates that the brake fluid temperature is excessive and is about to boil. The system limits vehicle speed to 100 km/h (62 mph). The driver should immediately start a cool down lap if on the track. If this message displays, the vehicle needs to be serviced. The brake system needs to cool down, and the brake fluid must be immediately flushed with DOT 4 for street use, or to a qualified DOT 4 race fluid for track use. Boiled brake fluid is compromised and must be replaced.

### Brake Burnishing

#### Caution

These procedures are specific to the V-Series with performance brake linings package. This procedure should not be run on other models as damage may result.

#### Caution

The new vehicle break-in period should be completed before performing the brake burnishing procedure or damage may occur to the powertrain/engine. See *New Vehicle Break-In* ⇨ 191.

#### Caution

Brake pedal fade will occur during any track burnish procedure and can cause brake pedal travel and force to increase. This could extend stopping distance until the brakes are fully burnished.

New brake pads must be burnished before racing or other competitive driving.

When performed as instructed, these procedures will not damage the brakes. During the burnishing procedure, the brake pads will smoke and produce an odor. The braking force and pedal travel may increase. After the procedure is complete, the brake pads may appear white at the rotor contact.

Perform these procedures in a safe manner and in compliance with all local and state ordinances/laws regarding motor vehicle operation. Perform the procedures only on dry pavement.

As with all high performance brake systems, some amount of brake squeal is normal.

### Street High Performance Brake Burnishing Procedure

This section is for the V-Series Blackwing with J57 carbon ceramic brake rotors only.

#### Caution

Brake fade will occur during this track burnish procedure and can cause brake pedal travel and force to increase. This could extend stopping distance until the brakes are fully burnished.

This procedure should only be run on a track or other non-public area, and only on dry pavement.

1. From a stop, accelerate as rapidly as possible without activating traction control to a speed of 100 km/h (60 mph).

- Using the G-Force Gauge in the HUD display, use enough pedal force to completely stop the vehicle in four to five seconds. (~0.7g Decel level to stop the vehicle in a straight line). If ABS activates, braking is too hard.
- Repeat the first two steps 20 consecutive times, this should take about five minutes.
- After completing the 20 stops, cool the brakes by driving for 8 km (5 mi) at 100 km/h (60 mph).

#### Alternative Closed Course Brake Burnishing Procedure

This brake burnish procedure should only be run on vehicles with a factory equipped brake system.

This procedure should only be run on a track and only on dry pavement. Brake pedal fade will occur during this track burnish procedure and can cause brake pedal travel and force to increase. This could extend stopping distance until the brakes are fully burnished.

- Start track lapping at lower speeds and lower braking efforts for three minutes of driving. Allow for increased braking distances due to reduced brake output.

- After Step 1, increase speed and braking effort for the next six minutes of lapping, gradually ending up at 90% effort. Continue to allow for increased braking distance due to reduced brake output.
- Cool the brakes by lapping with minimal light braking for six minutes.

#### Wheel Alignment

##### Caution

Using these wheel alignment settings may cause excessive tire wear. Only use these wheel alignment settings for racing or competitive driving. Excessive tire wear is not covered under the vehicle warranty.

##### Caution

Do not use power tools when removing or installing the fasteners. Damage to the threads may occur. Use hand tools only, and do not overtighten. Hand start the fasteners to ensure that the threads do not bind or cross thread.

Wheel alignment suggested specs for track use:

#### Road Course (V-Series)

- Front: -2.0 deg camber, 0.2 deg total toe
- Rear: -1.7 deg camber, 0.2 deg total toe

#### Road Course (V-Series Blackwing)

- Front: -2.5 deg camber, 0.1 deg total toe
- Rear: -1.5 deg camber, 0.1 deg total toe

#### Tire Inflation Pressure Guidelines

Tire inflation pressures affect vehicle handling and tire life, and should be adjusted for various types of tracks/courses.

Inspect the tires prior to every track/course session. Track/course driving will reduce the tire tread life.

To maximize tire life, drive 800 km (500 mi) prior to racetrack driving or complete the minimum track running that will increase the tire pressures by 35 kPa (5 psi). After this, immediately let the tires cool to cold pressures.

#### Tire Inflation Pressure High Speed

See *Tire Pressure for High-Speed Operation*

↪ 332.

## Driving and Operating

 **Warning**

Operating the vehicle at high speeds can be dangerous. Improper tire inflation pressure can put additional strain on the tires and can cause a sudden failure. Make sure the tires are in excellent condition, and use the correct cold tire inflation pressure for the vehicle load and track/course.

 **Warning**

Tracks/courses put high loads on tires operating at high speed, which can lead to tire failure if not inflated properly. Always limit vehicle cargo to the driver plus one passenger with no additional cargo.

 **Warning**

Track/course loads wear tires both on the tread and internal to the tire. When driven in track/course conditions, even if tread is not worn down to the treadwear indicator,

(Continued)

**Warning (Continued)**

tires must be replaced after the equivalent of two tanks of fuel or approximately 160 km (100 mi).

**Custom Launch Control (If Equipped)**

Custom Launch Control allows the following parameters for Launch Control to be modified:

- Launch RPM
- Slip Target (5%–15%)
- Surface Type

To adjust the Launch RPM, all of these conditions must be met:

- Performance Traction Management (PTM) Mode must be enabled. See *Performance Driving* ⇨ 217.
- The steering wheel must be straight.
- The driver door must be closed.
- The transmission must be in D (Drive) or forward gear.
- The parking brake must not be engaged.

To enable Launch Control:

1. Touch the V-Series icon on the control panel. See *Driver Information Center (DIC)* ⇨ 111.
2. Touch Auto for automatic Launch Control or Custom for manually adjusted Launch Control.

Instructional messages and dynamic gauges reflecting brake and throttle pedal positions will be displayed on the Left Zone of the DIC.

**Line Lock (If Equipped)** **Warning**

The vehicle may move unexpectedly when using Line Lock, which could cause injury to persons or property located nearby. Only use Line Lock on a closed track where there is a large clear area around all sides of the vehicle. Be ready to apply the brakes immediately if the vehicle begins to move. Do not use Line Lock in an area that is accessible to the public or where people or property are located near the vehicle.



**Caution**

Attempting to shift when the drive wheels are spinning and do not have traction may cause damage to the transmission. Damage caused by misuse of the vehicle is not covered by the vehicle warranty. Do not attempt to shift when the drive wheels do not have traction.

Line Lock allows for locking the front brakes independently of the rear brakes. This allows the rear tires to spin when the throttle is applied.

To enter Line Lock, all of these conditions must be met:

- Performance Traction Management (PTM) Mode must be enabled. See *Performance Driving* ⇨ 217.
- The steering wheel must be straight.
- The driver door must be closed.
- The vehicle must be in D (Drive) for an automatic transmission or 1 (First) gear for a manual transmission.
- The parking brake must not be engaged.

- The vehicle must be stopped on level ground. The accelerator pedal must not be applied.

To enable Line Lock:

1. Touch the V-Series icon on the control panel. See *Driver Information Center (DIC)* ⇨ 111.
2. Touch Line Lock.

If the burnout is not completed in 15 seconds, torque will be reduced to idle, the parking brake will be applied, Line Lock releases, and Custom Launch Control will be disabled.

Ensure the parking brake is disengaged to re-enter Launch Control.

**Performance Timers (If Equipped)**

The Performance Timer displays the current and best times achieved during acceleration. All stored times can be reset on the Performance Timer menu.

Touch the V-Series icon on the control panel to open the Performance Timer menu. See *Driver Information Center (DIC)* ⇨ 111. The Performance Timer menu will display on the Right Zone of the DIC.

**Driving on Wet Roads**

Rain and wet roads can reduce vehicle traction and affect your ability to stop and accelerate. Always drive slower in these types of driving conditions and avoid driving through large puddles and deep-standing or flowing water.

**Warning**

Wet brakes can cause crashes. They might not work as well in a quick stop and could cause pulling to one side. You could lose control of the vehicle.

After driving through a large puddle of water or a car/vehicle wash, lightly apply the brake pedal until the brakes work normally.

Flowing or rushing water creates strong forces. Driving through flowing water could cause the vehicle to be carried away. If this happens, you and other vehicle occupants could drown. Do not ignore police warnings and be very cautious about trying to drive through flowing water.

### Caution

Driving through deep puddles or standing water can cause water to come in through the engine air intake and damage the engine. If deep puddles or standing water cannot be avoided, proceed with caution and do not exceed 8 km/h (5 mph). Do not drive through water that may come close to or cover the vehicle's underbody.

### Hydroplaning

Hydroplaning is dangerous. Water can build up under the vehicle's tires so they actually ride on the water. This can happen if the road is wet enough and you are going fast enough. When the vehicle is hydroplaning, it has little or no contact with the road.

There is no hard and fast rule about hydroplaning. The best advice is to slow down when the road is wet.

### Other Rainy Weather Tips

Besides slowing down, other wet weather driving tips include:

- Allow extra following distance.
- Pass with caution.

- Keep windshield wiping equipment in good shape.
- Keep the windshield washer fluid reservoir filled.
- Have good tires with proper tread depth. See *Tires* ⇨ 325.
- Turn off cruise control.

### Hill and Mountain Roads

Driving on steep hills or through mountains is different than driving on flat or rolling terrain. Tips include:

- Keep the vehicle serviced and in good shape.
- Check all fluid levels and brakes, tires, cooling system, and transmission.
- Shift to a lower gear when going down steep or long hills.

### Warning

Using the brakes to slow the vehicle on a long downhill slope can cause brake overheating, can reduce brake

(Continued)

### Warning (Continued)

performance, and could result in a loss of braking. Shift the transmission to a lower gear to let the engine assist the brakes on a steep downhill slope.

### Warning

Coasting downhill in N (Neutral) or with the ignition off is dangerous. This can cause overheating of the brakes and loss of steering assist. Always have the engine running and the vehicle in gear.

- Drive at speeds that keep the vehicle in its own lane. Do not swing wide or cross the center line.
- Be alert on top of hills; something could be in your lane (e.g., stalled car, crash).
- Pay attention to special road signs (e.g., falling rocks area, winding roads, long grades, passing or no-passing zones) and take appropriate action.

## Winter Driving

### Driving on Snow or Ice

#### Caution

To avoid damage to the wheels and brake components, always clear snow and ice from inside the wheels and underneath the vehicle before driving.

Snow or ice between the tires and the road creates less traction or grip, so drive carefully. Wet ice can occur at about 0 °C (32 °F) when freezing rain begins to fall. Avoid driving on wet ice or in freezing rain until roads can be treated.

#### For Slippery Road Driving:

- Accelerate gently. Accelerating too quickly causes the wheels to spin and makes the surface under the tires slick.
- Turn on Traction Control. See *Traction Control/Electronic Stability Control* ⇨ 210.
- The Antilock Brake System (ABS) improves vehicle stability during hard stops, but the brakes should be applied sooner than when on dry pavement. See *Antilock Brake System (ABS)* ⇨ 207.

- Allow greater following distance and watch for slippery spots. Icy patches can occur on otherwise clear roads in shaded areas. The surface of a curve or an overpass can remain icy when the surrounding roads are clear. Avoid sudden steering maneuvers and braking while on ice.
- Turn off cruise control.
- Select All-Wheel Drive (AWD) Mode for vehicles equipped with AWD. Select Snow/Ice Mode for FWD only vehicles. See *Driver Mode Control* ⇨ 211 and *All-Wheel Drive* ⇨ 207.

### Cold Weather Mode

In very low temperatures, a cold weather message may display on the Driver Information Center (DIC). The engine speed, transmission shift patterns, and cabin fan speed may operate differently to enable the vehicle to warm up quicker. You can manually override the cabin fan speed in cold weather mode.

### Blizzard Conditions

Stop the vehicle in a safe place and signal for help. Stay with the vehicle unless there is help nearby. If possible, use Roadside Assistance. See *Roadside Assistance Program* ⇨ 382. To get help and keep everyone in the vehicle safe:

- Turn on the hazard warning flashers.
- Tie a red cloth to an outside mirror.

#### Warning

Snow can trap engine exhaust under the vehicle. This may cause exhaust gases to get inside. Engine exhaust contains carbon monoxide (CO), which cannot be seen or smelled. It can cause unconsciousness and even death.

If the vehicle is stuck in snow:

- Clear snow from the base of the vehicle, especially any blocking the exhaust pipe.
- Open a window about 5 cm (2 in) on the vehicle side that is away from the wind, to bring in fresh air.

(Continued)

### Warning (Continued)

- Fully open the air outlets on or under the instrument panel.
- Adjust the climate control system to circulate the air inside the vehicle and set the fan speed to the highest setting. See “Climate Control Systems.”

For more information about CO, see *Engine Exhaust* ⇨ 199.

To save fuel, run the engine for short periods to warm the vehicle and then shut the engine off and partially close the window. Moving about to keep warm also helps.

If it takes time for help to arrive, when running the engine, push the accelerator pedal slightly so the engine runs faster than the idle speed. This keeps the battery charged to restart the vehicle and to signal for help with the headlamps. Do this as little as possible, to save fuel.

### If the Vehicle Is Stuck

Slowly and cautiously spin the wheels to free the vehicle when stuck in sand, mud, ice, or snow.

The Traction Control System (TCS) can often help to free a stuck vehicle. See *Traction Control/Electronic Stability Control* ⇨ 210.

If TCS cannot free the vehicle, turn TCS off and use the rocking method. See “Rocking the Vehicle to Get it Out” following.

### Warning

If the vehicle's tires spin at high speed, they can explode, and you or others could be injured. The vehicle can overheat, causing an engine compartment fire or other damage. Spin the wheels as little as possible and avoid going above 56 km/h (35 mph).

### Rocking the Vehicle to Get it Out

Turn the steering wheel left and right to clear the area around the front wheels. Turn off any traction system. Shift back and forth between R (Reverse) and a low forward gear, spinning the wheels as little as possible. To prevent

transmission wear, wait until the wheels stop spinning before shifting gears. Release the accelerator pedal while shifting, and press lightly on the accelerator pedal when the transmission is in gear. Slowly spinning the wheels in the forward and reverse directions causes a rocking motion that could free the vehicle. If that does not get the vehicle out after a few tries, it might need to be towed out. If the vehicle does need to be towed out, see *Transporting a Disabled Vehicle* ⇨ 352.

### Vehicle Load Limits

It is very important to know how much weight the vehicle can carry. This weight is called the vehicle capacity weight and includes the weight of all occupants, cargo, and all non-factory-installed options. Two labels on the vehicle may show how much weight it may properly carry: the Tire and Loading Information label and the Certification label.

### Warning

Do not load the vehicle any heavier than the Gross Vehicle Weight Rating (GVWR), or either the maximum front or rear Gross Axle Weight Rating (GAWR). This can cause systems to break and change the way the vehicle handles. This could cause loss of control and a crash. Overloading can also reduce stopping performance, damage the tires, and shorten the life of the vehicle.

### Tire and Loading Information Label

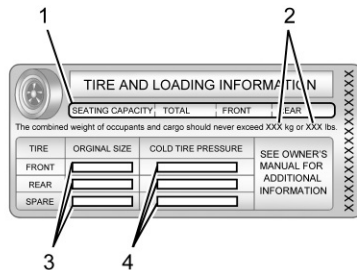

Example Label

A vehicle-specific Tire and Loading Information label is attached to the vehicle's center pillar (B-pillar). The Tire and Loading Information label shows the number of occupant seating positions (1), and the maximum vehicle capacity weight (2) in kilograms and pounds.

The Tire and Loading Information label also shows the tire size of the original equipment tires (3) and the recommended

cold tire inflation pressures (4). For more information on tires and inflation see *Tires* ⇨ 325 and *Tire Pressure* ⇨ 331.

There is also important loading information on the Certification label. It may show the Gross Vehicle Weight Rating (GVWR) and the Gross Axle Weight Rating (GAWR) for the front and rear axle. See "Certification Label" later in this section.

### Steps for Determining Correct Load Limit

1. Locate the statement "The combined weight of occupants and cargo should never exceed XXX kg or XXX lbs." on your vehicle's placard.
2. Determine the combined weight of the driver and passengers that will be riding in your vehicle.
3. Subtract the combined weight of the driver and passengers from XXX kg or XXX lbs.
4. The resulting figure equals the available amount of cargo and luggage load capacity. For example, if the "XXX" amount equals 1400 lbs. and there

will be five 150 lb passengers in your vehicle, the amount of available cargo and luggage load capacity is 650 lbs. (1400-750 (5 x 150) = 650 lbs.)

- Determine the combined weight of luggage and cargo being loaded on the vehicle. That weight may not safely exceed the available cargo and luggage load capacity calculated in Step 4.
- If your vehicle will be towing a trailer, load from your trailer will be transferred to your vehicle. Consult this manual to determine how this reduces the available cargo and luggage load capacity of your vehicle.

See *Trailer Towing (LSY 2.0L L4 and LGY 3.0L V6 Engines Only)* ⇨ 282 for important information on towing a trailer, towing safety rules, and trailering tips.

If aftermarket accessories are installed on the vehicle, for example a rooftop carrier, be sure to add the weight of all installed accessories to the combined weight of luggage and cargo.

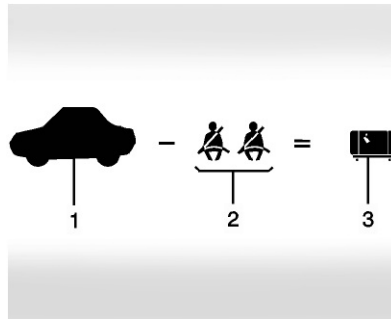

**Example 1**

- Vehicle Capacity Weight for Example 1 = 453 kg (1,000 lb)  
Then subtract Accessory Weight, for example a rooftop cargo box = 15.8 kg (35 lb)
- Subtract Occupant Weight @ 68 kg (150 lb) × 2 = 136 kg (300 lb)
- Remaining available capacity for Cargo Weight = 301.2 kg (665 lb)

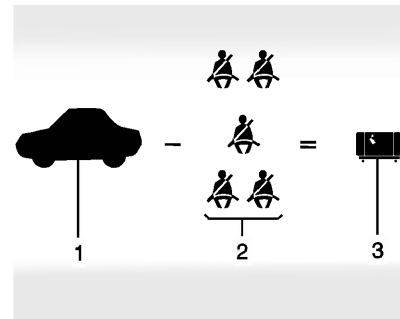

**Example 2**

- Vehicle Capacity Weight for Example 2 = 453 kg (1,000 lb)  
Then subtract Accessory Weight, for example a rooftop cargo box = 18.1 kg (40 lb)
- Subtract Occupant Weight @ 68 kg (150 lb) × 5 = 340 kg (750 lb)
- Remaining available capacity for Cargo Weight = 94.9 kg (210 lb)

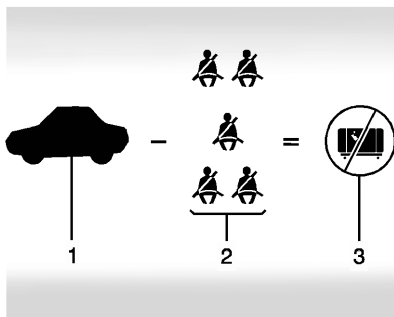
**Example 3**

1. Vehicle Capacity Weight for Example 3 = 453 kg (1,000 lbs)
2. Subtract Occupant Weight @ 91 kg (200 lbs)  $\times$  5 = 453 kg (1,000 lbs)
3. Available Cargo Weight = 0 kg (0 lbs)

Refer to the vehicle's Tire and Loading Information label for specific information about the vehicle's capacity weight and seating positions. The combined weight of the driver, passengers, accessories, and cargo should never exceed the vehicle's capacity weight.

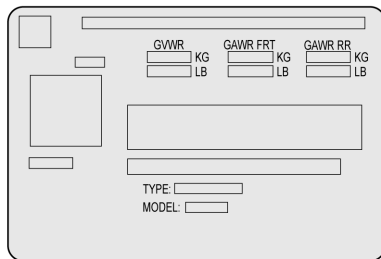
**Certification Label****Label Example**

A vehicle-specific Certification label is attached to the vehicle's center pillar (B-pillar). The label may show the gross weight capacity of the vehicle, called the Gross Vehicle Weight Rating (GVWR). The GVWR includes the weight of the vehicle, all occupants, fuel, and cargo.

**Warning**

Things inside the vehicle can strike and injure people in a sudden stop or turn, or in a crash.

- Put things in the cargo area of the vehicle. In the cargo area, put them as far forward as possible. Try to spread the weight evenly.
- Never stack heavier things, like suitcases, inside the vehicle so that some of them are above the tops of the seats.
- Do not leave an unsecured child restraint in the vehicle.
- Secure loose items in the vehicle.
- Do not leave a seat folded down unless needed.

## Starting and Operating New Vehicle Break-In

### Caution

Follow these recommended guidelines during the first 2 414 km (1,500 mi) of driving this vehicle. Parts have a break-in period and performance will be better in the long run.

- Avoid full throttle starts and abrupt stops.
- Do not exceed 4000 engine rpm.
- Avoid driving at any one constant speed, fast or slow.
- Do not drive above 129 km/h (80 mph).
- Avoid downshifting to brake or slow the vehicle when the engine speed will exceed 4000 rpm.

(Continued)

### Caution (Continued)

- Do not let the engine labor. Never lug the engine in high gear at low speeds. With a manual transmission, shift to the next lower gear. This rule applies at all times, not just during the break-in period.
- Do not participate in racing events, sport driving schools, or similar activities during this break-in period.
- Check engine oil with every refueling and add if necessary. Oil and fuel consumption may be higher than normal during the first 2 414 km (1,500 mi).
- To break in new tires, drive at moderate speeds and avoid hard cornering for the first 322 km (200 mi). New tires do not have maximum traction and may tend to slip.
- New brake linings also need a break-in period. Avoid making hard stops during the first 322 km (200 mi). This is recommended every time brake linings are replaced.

(Continued)

### Caution (Continued)

- Should the vehicle be used for racing or competitive driving (after break-in), the rear axle lubricant must be replaced beforehand.

See *Track Events and Competitive Driving (V-Series and V-Series Blackwing)* ⇨ 176.

On new vehicles, the various mechanical and electrical systems experience a “break-in” period during the first 6,400 km (4,000 miles) of routine driving. As the vehicle is driven, the mechanical systems adjust to provide optimal fuel economy and transmission shift performance.

Electrical systems will adapt and calibrate during the break-in period. A one-time occurrence of clicks and similar vehicle noises is normal during this process.

Normal driving charges the vehicle’s battery to achieve the best operation of the vehicle, including fuel economy.



## Composite Materials

This vehicle may be equipped with parts containing carbon fiber, sheet-molding compound, or other composite materials. Dealer-installed accessories may also contain composite materials.

### Warning

Exposed edges of parts containing carbon fiber and other composite materials can be sharp. Contact with these parts could result in injury. Use caution to avoid contacting these parts, including when washing the vehicle. If the parts are damaged, replace the parts promptly with replacements from your dealer.

### Warning

Rocker extensions may break under pressure, resulting in property damage or injury. Do not stand on the rocker extension or use it as a step.

### Warning

Rear end spoilers may break under pressure, resulting in property damage or injury. Do not push the vehicle by the spoiler or use the spoiler as a handle.

## Ignition Positions

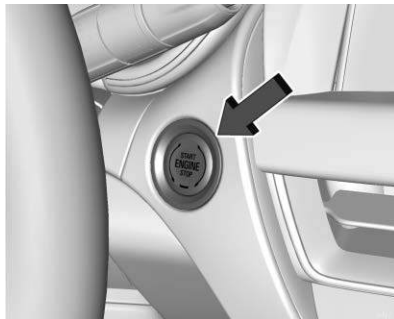

The vehicle has an electronic keyless ignition with pushbutton start.

The Remote Key must be in the vehicle for the system to operate. If the pushbutton start is not working, the vehicle may be near a strong

radio antenna signal causing interference to the Keyless Access system. See *Remote Key Operation* ⇨ 7.

To shift out of P (Park), the vehicle must be on and the brake pedal must be applied.

**Stopping the Engine/OFF (No Indicator Lights):** When the vehicle is stopped, press ENGINE START/STOP once to turn the engine off.

If the vehicle is in P (Park), the ignition will turn off, and Retained Accessory Power (RAP) will remain active. See *Retained Accessory Power (RAP)* ⇨ 197.

If the vehicle has an automatic transmission, and is not in P (Park), the ignition will return to accessory mode and display a message in the Driver Information Center (DIC). When the vehicle is shifted into P (Park), the ignition system will turn OFF.

If the vehicle has a manual transmission and is stationary, the ignition will turn off, and Retained Accessory Power (RAP) will remain active. See *Retained Accessory Power (RAP)* ⇨ 197.

The vehicle may have an electric steering column lock. The lock is activated when the vehicle is switched to OFF and the driver door

is opened. A sound may be heard as the lock actuates or releases. The steering column lock may not release with the wheels turned off center. If this happens, the vehicle may not start. Move the steering wheel from left to right while attempting to start the vehicle. If this does not work, the vehicle needs service.

Do not turn the engine off when the vehicle is moving. This will cause a loss of power assist in the brake and steering systems and disable the airbags.

If the vehicle must be shut off in an emergency:

1. Brake using a firm and steady pressure. Do not pump the brakes repeatedly. This may deplete power assist, requiring increased brake pedal force.
2. Shift the vehicle to N (Neutral). This can be done while the vehicle is moving. After shifting to N (Neutral), firmly apply the brakes and steer the vehicle to a safe location.
3. Come to a complete stop. Shift to P (Park) with an automatic transmission, or Neutral with a manual transmission. Turn the ignition off.
4. Set the parking brake. See *Electric Parking Brake* ⇨ 208.

 **Warning**

Turning off the vehicle while moving may cause loss of power assist in the brake and steering systems and disable the airbags. While driving, only shut the vehicle off in an emergency.

If the vehicle cannot be pulled over, and must be shut off while driving, press and hold ENGINE START/STOP for longer than two seconds, or press twice within five seconds.

**Accessory Mode (Amber Indicator Light):** This mode allows the use of some electrical accessories when the engine is off.

With the ignition off, pressing the button once without the brake pedal applied will place the ignition system in accessory mode.

The ignition will switch from accessory mode to OFF after five minutes to prevent battery rundown.

**ON/RUN/START (Green Indicator Light):** This mode is for driving and starting. With the ignition off, and the brake pedal applied, pressing the button once will place the ignition system in ON/RUN/START. Once engine cranking begins, release the button.

Engine cranking will continue until the engine starts. See *Starting the Engine* ⇨ 193. The ignition will then remain on.

### Service Mode

This power mode is available for service and diagnostics, and to verify the proper operation of the malfunction indicator lamp as may be required for emission inspection purposes. With the vehicle off, and the brake pedal not applied, pressing and holding ENGINE START/STOP for more than five seconds will place the vehicle in Service Mode. The instruments and audio systems will operate as they do in ON/RUN, but the vehicle will not be able to be driven. The engine will not start in Service Mode. Press the button again to turn the vehicle off.

### Starting the Engine

Place the transmission in the proper gear

**Caution**

If you add electrical parts or accessories, you could change the way the engine operates. Any resulting damage would not be covered by the vehicle warranty. See *Add-On Electrical Equipment* ⇨ 285.

**Automatic Transmission**

Move the shift lever to P (Park) or N (Neutral). To restart the vehicle when it is already moving, use N (Neutral) only.

**Caution**

Do not try to shift to P (Park) if the vehicle is moving. If you do, you could damage the transmission. Shift to P (Park) only when the vehicle is stopped.

**Manual Transmission**

The shift lever should be in Neutral and the parking brake engaged.

**Starting the Vehicle**

1. For vehicles with an automatic transmission, press the brake pedal, then press ENGINE START/STOP on the instrument panel. For a manual transmission, hold the clutch pedal down to the floor, press the brake pedal, then press ENGINE START/STOP.

If the remote key is not in the vehicle, if there is interference, or if the remote key battery is low, a Driver Information Center (DIC) message will display. See *Remote Key Operation* ⇨ 7.

**Caution**

Cranking the engine for long periods of time, by pressing ENGINE START/STOP immediately after cranking has ended, can overheat and damage the cranking motor, and drain the battery. Wait at least 15 seconds between each try, to let the cranking motor cool down.

2. If the engine does not start after five to 10 seconds, especially in very cold weather (below  $-18^{\circ}\text{C}$  or  $0^{\circ}\text{F}$ ), it could be flooded with too much gasoline. Try pushing the

accelerator pedal all the way to the floor and hold it there, then press ENGINE START/STOP for up to a maximum of 15 seconds. Wait at least 15 seconds between each try, to allow the cranking motor to cool down. When the engine starts, let go of the button and the accelerator. If the vehicle starts briefly but then stops again, do the same thing. This clears the extra gasoline from the engine. Do not race the engine immediately after starting it. Operate the engine and transmission gently until the oil warms up and lubricates all moving parts.

**Stopping the Engine**

If the vehicle has an automatic transmission, move the shift lever to P (Park) and press and hold ENGINE START/STOP on the instrument panel, until the engine shuts off. If the shift lever is not in P (Park), the engine shuts off and the ignition goes to accessory mode. The DIC displays SHIFT TO PARK. Once the shift lever is moved to P (Park), the vehicle turns off.

If the vehicle has a manual transmission, before getting out of the vehicle, shift to 1 (First) or R (Reverse) and apply the parking brake. Then

turn off the ignition off by pressing ENGINE START/STOP and release the clutch pedal when the engine has stopped.

If the remote key is not detected inside the vehicle when it is turned off the DIC displays a message.

## Stop/Start System

If equipped and enabled, the Stop/Start system shuts off the engine to help conserve fuel. The system is designed to manage the increased number of starts.

### Warning

The automatic engine Stop/Start feature causes the engine to shut off while the vehicle is still on. Do not exit the vehicle before shifting to P (Park). The vehicle may restart and move unexpectedly. Always shift to P (Park), and then turn the ignition off before exiting the vehicle.

### Auto Engine Stop/Start

When the brakes are applied and the vehicle is at a complete stop, the engine may turn off. When stopped, the tachometer displays

AUTO STOP. See *Tachometer* ⇨ 94. When the brake pedal is released or the accelerator pedal is pressed, the engine will restart.

To maintain vehicle performance, other conditions may cause the engine to automatically restart before the brake pedal is released.

Auto Stops may not occur and/or Auto Starts may occur because:

- The climate control settings require the engine to be running to cool or heat the vehicle interior.
- The vehicle battery needs to charge.
- The vehicle battery has recently been disconnected.
- Minimum vehicle speed has not been reached since the last Auto Stop.
- The accelerator pedal is pressed.
- The engine or transmission is not at the required operating temperature.
- The outside temperature is not in the required operating range.
- The vehicle is shifted out of D (Drive) to any gear other than P (Park).

- Certain driver modes have been selected. See *Driver Mode Control* ⇨ 211.
- The vehicle is on a steep hill or grade.
- The driver door has been opened or the driver seat belt has been unbuckled.
- The hood has been opened.
- The Auto Stop has reached the maximum allowed time.

### Auto Stop Disable Switch

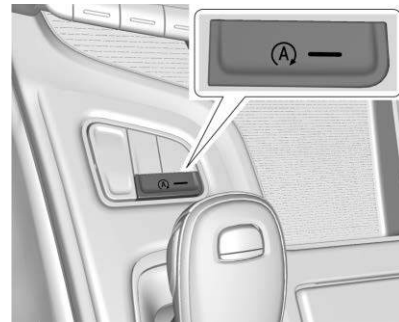

The automatic engine Stop/Start feature can be disabled and enabled by pressing . Auto Stop/Start is enabled each time you start the vehicle.

When the (A) indicator is illuminated, the system is enabled.

## Engine Heater

Vehicles with the engine heater can use this option in cold weather conditions at or below  $-18^{\circ}\text{C}$  ( $0^{\circ}\text{F}$ ) for easier starting and better fuel economy during engine warm-up. Plug in the engine heater at least four hours before starting your vehicle. An internal thermostat in the plug-end of the cord may exist which will prevent engine heater operation at temperatures above  $-18^{\circ}\text{C}$  ( $0^{\circ}\text{F}$ ).

### To Use the Engine Heater

1. Turn off the engine.

Check the heater cord for damage. If it is damaged, do not use it. See your dealer for a replacement. Inspect the cord for damage yearly.



2. Plug the heater cord into the connector in the front license plate bracket.
3. Plug it into a normal, grounded 110-volt AC outlet.



### Warning

Improper use of the heater cord or an extension cord can damage the cord and may result in overheating and fire.

(Continued)

### Warning (Continued)

- Plug the cord into a three-prong electrical utility receptacle that is protected by a ground fault detection function. An ungrounded outlet could cause an electric shock.
- Use a weatherproof, heavy-duty, 15 amp-rated extension cord if needed. Failure to use the recommended extension cord in good operating condition, or using a damaged heater or extension cord, could make it overheat and cause a fire, property damage, electric shock, and injury.
- Do not operate the vehicle with the heater cord permanently attached to the vehicle. Possible heater cord and thermostat damage could occur.
- While in use, do not let the heater cord touch vehicle parts or sharp edges. Never close the hood on the heater cord.
- Before starting the vehicle, unplug the cord, reattach the cover to the plug, and securely fasten the cord. Keep the cord away from any moving parts.

- Before starting the engine, be sure to unplug and store the cord as it was before to keep it away from moving engine parts. If you do not, it could be damaged.

Contact your dealer for information on how long to use the heater in your particular area.

## Retained Accessory Power (RAP)

When the vehicle is turned from on to off, the following features (if equipped) will continue to function for up to 10 minutes, or until the driver door is opened. These features will also work when the vehicle is on or in accessory mode:

- Infotainment System
- Power Windows (during RAP this functionality will be lost when any door is opened)
- Sunroof (during RAP this functionality will be lost when any door is opened)
- Auxiliary Power Outlet
- Audio System
- OnStar System

## Shifting Into Park

To shift into P (Park):

- Hold the brake pedal down and set the parking brake. See *Electric Parking Brake* ⇨ 208.
- Press the button on top of the shift lever to shift into P (Park). See *Automatic Transmission* ⇨ 200.
- The P indicator on the shift lever will turn red when the vehicle is in P (Park).

If the vehicle is shifted into P (Park) on a hill, the Electric Parking Brake (EPB) may apply automatically. You may not be able to release the EPB using the EPB switch. It should automatically release when the vehicle is shifted out of P (Park).

## Leaving the Vehicle with the Engine Running

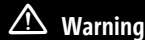

### Warning

It can be dangerous to leave the vehicle with the engine running. It could overheat and catch fire.

(Continued)

## Warning (Continued)

It is dangerous to get out of the vehicle if the vehicle is not in P (Park) with the parking brake set. The vehicle can roll.

Do not leave the vehicle when the engine is running. If you have left the engine running, the vehicle can move suddenly. You or others could be injured. To be sure the vehicle will not move, even when you are on fairly level ground, always set the parking brake and shift to P (Park). See *Shifting Into Park* ⇨ 197. If you are towing a trailer, see *Driving Characteristics and Towing Tips* ⇨ 279.

If you have to leave the vehicle with the engine running, be sure the vehicle is in P (Park) and the parking brake is set before you leave it.

If you are towing a trailer and parking on a hill, see *Driving Characteristics and Towing Tips* ⇨ 279.

## Shifting out of Park

This vehicle is equipped with an electronic transmission. The shift lock release button is designed to prevent inadvertent shifting out of P (Park).

To shift out of P (Park):

1. Ensure the engine is running.
2. Apply the brake pedal.
3. Press and hold the shift lock release button on the shift lever.
4. Move the shift lever to the desired position. For N (Neutral) hold the lever in the N (Neutral) position until the N indicator illuminates red.
5. The P indicator will turn white and the gear indicator will turn red when the vehicle is no longer in P (Park).
6. After releasing the shift lever, it will return to the center position.

If equipped, the Buckle to Drive feature may prevent shifting from P (Park). See *Buckle To Drive* ⇨ 46.

If the vehicle cannot shift from P (Park), a Driver Information Center (DIC) message may be displayed. Check that the ignition is on, the

engine is running, the brake pedal is applied, and the shift lock release button is pressed when you are attempting to shift out of P (Park). If all of these are met but the vehicle will not shift out of P (Park), see your dealer for service.

## Parking (Manual Transmission)

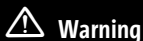

If the vehicle has a manual transmission, never get out of the vehicle without first moving the shift lever into 1st or R (Reverse), setting the parking brake and turning the ignition off. The vehicle can roll, which could cause serious injury or death.

## Parking over Things That Burn

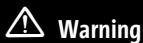

Things that can burn could touch hot exhaust parts under the vehicle and ignite. Do not park over papers, leaves, dry grass, or other things that can burn.

## Active Fuel Management

This vehicle's engine may be equipped with Active Fuel Management, which allows the engine to operate on either all of its cylinders, or in reduced cylinder operation mode, depending on the driving conditions.

When less power is required, such as cruising at a constant vehicle speed, the system will operate in reduced cylinder operation mode, allowing the vehicle to achieve better fuel economy. When greater power demands are required, such as accelerating from a stop, passing, or merging onto a freeway, the system will maintain full-cylinder operation.

If the vehicle has an Active Fuel Management indicator, see Driver Information Center (DIC) for more information on using this display.

## Extended Parking

It is best not to park with the vehicle running. If the vehicle is left running, be sure it will not move and there is adequate ventilation.

See *Shifting Into Park* ⇨ 197 and *Engine Exhaust* ⇨ 199.

If the vehicle is left parked and running with the remote key outside the vehicle, it will continue to run for up to 15 minutes.

If the vehicle is left parked and running with the remote key inside the vehicle, it will continue to run for up to 30 minutes.

The vehicle could turn off sooner if it is parked on a hill, due to lack of available fuel.

### Automatic Transmission

The timer will reset if the vehicle is taken out of P (Park) while it is running.

### Manual Transmission

The timer will reset if vehicle speed exceeds 4 km/h (2.5 mph).

## Engine Exhaust

### Warning

Engine exhaust contains carbon monoxide (CO), which cannot be seen or smelled. Exposure to CO can cause unconsciousness and even death.

Exhaust may enter the vehicle if:

(Continued)

### Warning (Continued)

- The vehicle idles in areas with poor ventilation (parking garages, tunnels, deep snow that may block underbody airflow or tail pipes).
- The exhaust smells or sounds strange or different.
- The exhaust system leaks due to corrosion or damage.
- The vehicle exhaust system has been modified, damaged, or improperly repaired.
- There are holes or openings in the vehicle body from damage or aftermarket modifications that are not completely sealed.

If unusual fumes are detected or if it is suspected that exhaust is coming into the vehicle:

- Drive it only with the windows completely down.
- Have the vehicle repaired immediately.

(Continued)

### Warning (Continued)

Never park the vehicle with the engine running in an enclosed area such as a garage or a building that has no fresh air ventilation.

## Running the Vehicle While Parked

The vehicle should not be left running while parked.

If the vehicle is left with the engine running, follow the proper steps to be sure the vehicle will not move. See *Shifting Into Park* ⇨ 197 and *Engine Exhaust* ⇨ 199.

If parking on a hill and pulling a trailer, see *Driving Characteristics and Towing Tips* ⇨ 279.



## Automatic Transmission



The shift pattern is displayed in the top of the shift lever. The selected gear position will illuminate red on the shift lever, while all others will be displayed in white. If the shift is not immediate, as in very cold conditions, the indicator on the shift lever may flash until it is fully engaged.

The shift lever always starts from a center position, represented by an up/down arrow on the shift pattern. After releasing the shift lever, it will return to the center position.

The transmission does not operate when the vehicle is off.

If the vehicle is in accessory mode, the transmission can be shifted into P (Park).

If the vehicle is turned off while at a relatively high vehicle speed, the transmission will automatically shift to N (Neutral). Once the vehicle is stopped, it can be shifted into P (Park).



**P:** This position locks the drive wheels. Use P (Park) when starting the engine to prevent the vehicle from moving easily.

### Warning

It is dangerous to get out of the vehicle if the transmission is not in P (Park) with the parking brake set. The vehicle can roll.

Do not leave the vehicle when the engine is running. If the engine has been left running, the vehicle can move suddenly. You or others could be injured. To be sure the vehicle will not move, even when on fairly level ground, always set the parking brake and place the transmission into P (Park). See *Shifting Into Park* ⇨ 197 and *Electric Parking Brake* ⇨ 208.



This vehicle is equipped with an electronically controlled transmission. The shift lock release button is designed to prevent inadvertent shifting out of P (Park) unless the ignition is on, the brake pedal is applied, and the shift lock release button is pressed.

When the vehicle is stopped, press ENGINE START/STOP to turn off the vehicle. The transmission will shift to P (Park) automatically unless the vehicle is in N (Neutral), See “Car Wash Mode” following.

The vehicle will not shift into P (Park) if it is moving too fast. Stop the vehicle and shift into P (Park).

To shift in and out of P (Park), see *Shifting Into Park* ⇨ 197 and *Shifting out of Park* ⇨ 198.

### Service Shift Lever Message

If the message SERVICE SHIFTER SEE OWNER'S MANUAL appears in the Driver Information Center (DIC), the shift lever needs service. Have the vehicle serviced as soon as possible. If the vehicle is automatically shifting into P (Park), check to see if the P (Park) button on top of the shift lever is stuck. To operate the vehicle, hold the shift lever in the desired gear, R (Reverse) or D (Drive), until vehicle speed exceeds 15 km/h (10 mph), then release the shift lever.

**R:** Use this gear to back up.

If the vehicle is shifted from either R (Reverse) to D (Drive) or M (Manual Mode), or M (Manual Mode) or D (Drive) to R (Reverse) while the speed is too high, the vehicle will shift to N (Neutral). Reduce the vehicle speed and try the shift again.

To shift into R (Reverse):

1. Bring the vehicle to a complete stop.
2. Press and hold shift lock release button on the side of the shift lever.
3. From the center position, move the shift lever forward through the first detent to the end of travel. R is illuminated in red.
4. After releasing the shift lever, it will return to the center position.

To shift out of R (Reverse):

1. Bring the vehicle to a complete stop.
2. Shift to the desired gear.
3. After releasing the shift lever, it will return to the center position.

At low vehicle speeds, R (Reverse) can be used to rock the vehicle back and forth to get out of snow, ice, or sand without damaging the transmission. See *If the Vehicle Is Stuck* ⇨ 187.

**N:** In this position, the engine does not connect with the wheels. To restart the engine when the vehicle is already moving, use N (Neutral) only.

### Warning

Shifting into a drive gear while the engine is running at high speed is dangerous. Unless your foot is firmly on the brake pedal, the vehicle could move very rapidly. You could lose control and hit people or objects. Do not shift into a drive gear while the engine is running at high speed.

### Caution

Shifting out of P (Park) or N (Neutral) with the engine running at high speed may damage the transmission. The repairs would not be covered by the vehicle warranty. Be sure the engine is not running at high speed when shifting the vehicle.

The vehicle is not designed to stay in N (Neutral) for more than five minutes. It may automatically shift into P (Park). N (Neutral) is

not intended for towing. If the vehicle needs to be towed, see *Transporting a Disabled Vehicle* ⇨ 352.

To shift into N (Neutral):

1. Move the shift lever forward to the first detent from the center position.
  - If the vehicle is in P (Park), apply the brake pedal and press the shift lock release button while moving the shift lever forward.
  - N will illuminate in red.
2. After releasing the shift lever, it will return to the center position.

To shift out of N (Neutral):

1. Bring the vehicle to a complete stop.
2. Shift to the desired gear. If shifting from N (Neutral) to R (Reverse), press the shift lock release button.
3. After releasing the shift lever, it will return to the center position.

### Car Wash Mode

This vehicle includes a Car Wash Mode that allows the vehicle to remain in N (Neutral) for use in automatic car washes.

### Car Wash Mode (Engine Off – Driver in Vehicle)

To place the vehicle in N (Neutral) with the engine off and the vehicle occupied:

1. Drive to the entrance of the car wash.
2. Apply the brake pedal.
3. Shift to N (Neutral).
4. Turn off the engine and release the brake pedal.
5. The indicator should continue to show N. If it does not, repeat Steps 2–4.
6. The vehicle is now ready for the car wash.

### Car Wash Mode (Engine Off – Driver out of Vehicle)

To place the vehicle in N (Neutral) with the engine off and the vehicle unoccupied:

1. Drive to the entrance of the car wash.
2. Apply the brake pedal.
3. Open the door.
4. Shift to N (Neutral).
5. Turn off the engine and release the brake pedal.
6. The indicator should continue to show N. If it does not, repeat Steps 2–5.

7. Exit the vehicle and close the door. The vehicle is now ready for the car wash.
8. The vehicle may automatically shift to P (Park) upon re-entry.

### Car Wash Mode (Engine On – Driver in Vehicle)

To place the vehicle in N (Neutral) with the engine on and the vehicle occupied:

1. Drive to the entrance of the car wash.
2. Apply the brake pedal.
3. Shift to N (Neutral).
4. Release the brake pedal. The vehicle is now ready for the car wash.

### Car Wash Mode (Engine On – Driver out of Vehicle)

To place the vehicle in N (Neutral) with the engine on and the vehicle unoccupied:

1. Drive to the entrance of the car wash.
2. Apply the brake pedal.
3. Open the door.
4. Shift to N (Neutral), then release the brake pedal.
5. The indicator should continue to show N. If it does not, repeat Steps 2–4.

6. Exit the vehicle and close the door. The vehicle is now ready for the car wash.
7. The vehicle may automatically shift to P (Park) upon re-entry.

### Caution

A transmission hot message may display if the automatic transmission fluid is too hot. Driving under this condition can damage the vehicle. Stop and idle the engine to cool the automatic transmission fluid. This message clears when the transmission fluid has cooled sufficiently.

**D:** This position is for normal driving. If more power is needed for passing, press the accelerator pedal down.

To shift into D (Drive):

1. Bring the vehicle to a complete stop.
2. From the center position, move the shift lever back.
  - If the vehicle is in P (Park), press the shift lock release button while pulling the shift lever back.
  - D will illuminate in red.

- After releasing the shift lever, it will return to the center position.

To shift out of D (Drive):

1. Bring the vehicle to a complete stop.
2. Shift to the desired gear.
3. After releasing the shift lever, it will return to the center position.

Downshifting the transmission in slippery road conditions could result in skidding. See “Skidding” under *Loss of Control* ⇨ 176.

### Caution

Spinning the tires or holding the vehicle in one place on a hill using only the accelerator pedal may damage the transmission. The repair will not be covered by the vehicle warranty. If the vehicle is stuck, do not spin the tires. When stopping on a hill, use the brakes to hold the vehicle in place.

If equipped with the 2.0L I4 engine, engine speeds may be increased while driving at highway speeds while the engine is still warming up.

## Manual Mode

### Tap Shift

#### Caution

Driving with the engine at a high rpm without upshifting while using Tap Shift, could damage the vehicle. Always upshift when necessary while using Tap Shift.



If equipped, vehicles with Tap Shift have controls on the back of the steering wheel to manually shift the automatic transmission.

### Permanent Tap Shift Mode

To enter Permanent Tap Shift Mode:

1. With the vehicle in D (Drive), pull back on the shift lever to activate M (Manual Mode). The M in the shift pattern will illuminate in red, and the D will switch to white. While in Permanent Tap Shift Mode, the M on the instrument cluster will be highlighted and the current gear shown.
2. After releasing the shift lever, it will return to the center position.
3. Pull the control toward you to shift. Pull the left control to downshift, and the right control to upshift. To shift to the lowest available gear, pull and hold the left control.

To exit Permanent Tap Shift Mode:

1. To exit M (Manual Mode) and return to D (Drive), pull back on the shift lever. The D in the shift pattern will illuminate in red, and the M will switch to white.
2. After releasing the shift lever, it will return to the center position.

M (Manual Mode) can be exited to return to D (Drive) at any speed by pulling the lever rearward from the center position. It is not

necessary to stop the vehicle or shift to N (Neutral) or P (Park) prior to shifting back to D (Drive).

### Temporary Tap Manual Shift Mode

To enter Temporary Tap Shift Mode:

1. With the transmission in D (Drive) and not in Permanent Tap Shift Mode, the Tap Shift controls will activate a Temporary Tap Manual Shift Mode, allowing the transmission to be manually shifted. While in Temporary Tap Shift Mode, the D on the instrument cluster will be highlighted and the current gear shown.
2. To shift to the lowest available gear, press and hold the left control.
3. To deactivate, hold the right control briefly. Automatic shifts return after no manual shifts have been done for seven to 10 seconds.

While using Tap Shift, the vehicle will have firmer, quicker shifting. This can be used for sport driving or when climbing or descending hills, to stay in gear longer, or to downshift for more power or engine braking.

The transmission will only allow shifting into gears appropriate for the vehicle speed and engine revolutions per minute (rpm). The transmission will not automatically shift to the next higher gear if the engine rpm is too high. It will only automatically shift to the next lower gear if the engine rpm is much too low.

## Manual Transmission

If equipped, this is the shift pattern for the manual transmission.



**Caution**

Shifting the vehicle initially into any gear other than 1 (First) or R (Reverse) can damage the clutch. Shift the manual transmission in the proper sequence, and time the gear shifting with the accelerator to avoid revving the engine and damaging the clutch.

**Caution**

The message MANUAL TRANSMISSION — RELEASE CLUTCH PEDAL displays and a chime sounds if the manual transmission clutch pedal is partially applied for an extended period of time while the vehicle is being driven. Driving with the clutch pedal applied can reduce the life of the clutch and/or damage it. Fully release the clutch pedal after each gear change.

**Caution**

The message REDUCED PERFORMANCE — REDUCE CLUTCH USE displays and engine torque is momentarily limited if excessive manual transmission clutch slip is detected while the clutch pedal is fully released. This could be caused by a hot clutch. Apply less pressure on the accelerator pedal when accelerating from a stop. Also, fully release the accelerator pedal during gear changes. This will allow the clutch to cool and should prevent further clutch slip while the clutch pedal is fully released. If this message displays repeatedly, see your dealer. Repeated clutch slip could cause permanent damage.

**Caution**

The message TRANSMISSION IS HOT — SLOW DOWN displays and a chime sounds if the manual transmission fluid is hot and vehicle speed is high. Driving with the manual transmission fluid temperature high can damage the vehicle. Drive at

(Continued)

**Caution (Continued)**

a slower speed to cool the manual transmission fluid. This message clears when the vehicle has slowed sufficiently or if the manual transmission fluid has cooled sufficiently.

**1 (First):** Press the clutch pedal and shift into 1 (First). Slowly let up on the clutch pedal while pressing on the accelerator pedal.

After a complete stop, if it is hard to shift into 1 (First), let up on the clutch pedal, then press it back down and shift into 1 (First).

**2 (Second):** Press the clutch pedal and let up on the accelerator pedal, then shift into 2 (Second). Then, slowly let up on the clutch pedal while accelerating.

**3 (Third), 4 (Fourth), 5 (Fifth), and 6 (Sixth):** Shift into 3 (Third), 4 (Fourth), 5 (Fifth), and 6 (Sixth) the same as 2 (Second).

To stop, let up on the accelerator pedal and press the brake pedal. Just before the vehicle stops, press the clutch pedal and the brake pedal, and shift to Neutral.

**Neutral:** Use this position when you start or idle the engine. The shift lever is in Neutral when it is centered in the shift pattern, not in any gear.

**R (Reverse):** To back up, press down the clutch pedal, completely stop the vehicle, and shift into R (Reverse). Let up on the clutch pedal slowly while pressing the accelerator pedal.

### Warning

If you skip a gear when downshifting, you could lose control of the vehicle. You could injure yourself or others. Do not shift down more than one gear at a time when downshifting.

### Caution

Shifting to R (Reverse) while the vehicle is moving forward could damage the transmission. The repairs would not be covered by the vehicle warranty. Shift to R (Reverse) only after the vehicle is stopped.

### Caution

Do not rest your hand on the shift lever while driving. The pressure could cause premature wear in the transmission. The repairs would not be covered by the vehicle warranty.

### Caution

When downshifting, if more than one gear is skipped, or the engine is racing when the clutch pedal is released, the engine, clutch, driveshaft or transmission could be damaged.

### No Lift-Shift

The vehicle can be shifted up a gear when the accelerator pedal is pressed to the floor without being released. This allows for less power interruption and will improve acceleration times. This feature is available in all vehicle modes and is only active when the engine speed is greater than 5000 rpm.

## Active Rev Match

Vehicles equipped with a manual transmission have Active Rev Match (ARM). ARM aids in smoother shifting by matching the engine speed to the next selected gear. By monitoring shift lever and clutch operation, ARM adjusts engine speed to match a calibrated value based on gear selection. On upshifts and downshifts, engine speed will be increased and decreased to match vehicle road speed and transmission gear position. ARM is maintained while the clutch pedal is pressed, but will deactivate if the shift lever is left in the Neutral position.

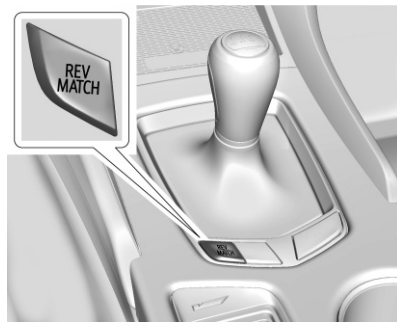

The system is activated and deactivated by pressing the ARM switch on the center console. The system must be activated with each new ignition cycle. If ARM is deactivated, the system will still perform rev matching for upshifts.

A gear indicator in the instrument cluster displays the current gear selected. ARM is also shown in the Performance View of the HUD:

- When ARM is activated, the gear number is amber.
- When ARM is deactivated, the gear number is white.
- If no gear number is displayed while the shift lever is in gear, service is required. All rev matching will be disabled, and the malfunction indicator lamp will be on. See *Malfunction Indicator Lamp (Check Engine Light)* ⇨ 101. The clutch and manual transmission will continue to operate normally.

ARM will also:

- Be active above 28 km/h (18 mph).
- Match engine speed up to 5400 rpm.
- Not operate when the accelerator pedal is applied.

- Be disabled when the coolant temperature is below 0 °C (32 °F).

## Drive Systems

### All-Wheel Drive

Vehicles with this feature always send engine power to all four wheels. It is fully automatic, and adjusts itself as needed for road conditions.

## Brakes

### Electric Brake Boost

Vehicles equipped with electric brake boost have hydraulic brake circuits that are electronically controlled when the brake pedal is applied during normal operation. The system performs routine tests and turns off within a few minutes after the vehicle is turned off. Noise may be heard during this time. If the brake pedal is pressed during the tests or when the electric brake boost system is off, a noticeable change in pedal force and travel may be felt. This is normal.

## Antilock Brake System (ABS)

The Antilock Brake System (ABS) helps prevent a braking skid and maintain steering while braking hard.



If there is a problem with ABS, this warning light stays on. See *Antilock Brake System (ABS) Warning Light* ⇨ 104.

ABS does not change the time needed to get a foot on the brake pedal and does not always decrease stopping distance. If you get too close to the vehicle ahead, there will not be enough time to apply the brakes if that vehicle suddenly slows or stops. Always leave enough room ahead to stop, even with ABS.

### Using ABS

Do not pump the brakes. Just hold the brake pedal down firmly. Hearing and feeling ABS operate is normal.



## Braking in Emergencies

ABS allows steering and braking at the same time. In many emergencies, steering can help even more than braking.

## Electric Parking Brake

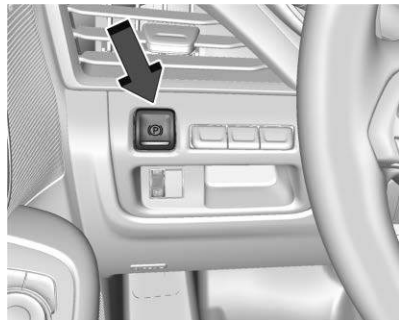

The Electric Parking Brake (EPB) can always be applied, even if the vehicle is off. In case of insufficient electrical power, the EPB cannot be applied or released. To prevent draining the battery, avoid unnecessary repeated cycles of the EPB.

The system has a red parking brake status light and an amber service parking brake warning light. See *Electric Parking Brake Light* ⇨ 103

and *Service Electric Parking Brake Light* ⇨ 103. There are also parking brake-related Driver Information Center (DIC) messages.

Before leaving the vehicle, check the red parking brake status light to ensure that the parking brake is applied.

### EPB Apply

To apply the EPB:

1. Be sure the vehicle is at a complete stop.
2. Press the EPB switch momentarily.

The red parking brake status light will flash and then stay on once the EPB is fully applied. If the red parking brake status light flashes continuously, then the EPB is only partially applied or there is a problem with the EPB. A DIC message will display. Release the EPB and try to apply it again. If the light does not come on, or keeps flashing, have the vehicle serviced. Do not drive the vehicle if the red parking brake status light is flashing. See your dealer.

If the amber service parking brake warning light is on, press the EPB switch. Continue to hold the switch until the red parking brake status light remains on. If the amber service parking brake warning light is on, see your dealer.

If the EPB is applied while the vehicle is moving, the vehicle will decelerate as long as the switch is pressed. If the switch is pressed until the vehicle comes to a stop, the EPB will remain applied.

The vehicle may automatically apply the EPB in some situations when the vehicle is not moving. This is normal, and is done to periodically check the correct operation of the EPB system, or at the request of other safety functions that utilize the EPB.

If the EPB fails to apply, block the rear wheels to prevent vehicle movement.

### EPB Release

To release the EPB:

1. Turn the ignition on or to accessory mode.
2. Apply and hold the brake pedal.
3. Press the EPB switch momentarily.

The EPB is released when the red parking brake status light is off.

If the amber service parking brake warning light is on, release the EPB by pressing and holding the EPB switch. Continue to hold the

switch until the red parking brake status light is off. If either light stays on after release is attempted, see your dealer.

### Caution

Driving with the parking brake on can overheat the brake system and cause premature wear or damage to brake system parts. Make sure that the parking brake is fully released and the brake warning light is off before driving.

If you are towing a trailer and parking on a hill, see *Driving Characteristics and Towing Tips* ⇨ 279.

### Automatic EPB Release

The EPB will automatically release if the vehicle is running, placed into gear, and an attempt is made to drive away. Avoid rapid acceleration when the EPB is applied, to preserve parking brake lining life.

### Brake Assist

Brake Assist detects rapid brake pedal applications due to emergency braking situations and provides additional braking to

activate the Antilock Brake System (ABS) if the brake pedal is not pushed hard enough to activate ABS normally. Minor noise, brake pedal pulsation, and/or pedal movement during this time may occur. Continue to apply the brake pedal as the driving situation dictates. Brake Assist disengages when the brake pedal is released.

### Hill Start Assist (HSA)

#### Warning

Do not rely on the HSA feature. HSA does not replace the need to pay attention and drive safely. You may not hear or feel alerts or warnings provided by this system. Failure to use proper care when driving may result in injury, death, or vehicle damage. See *Defensive Driving* ⇨ 174.

When the vehicle is stopped on a grade, Hill Start Assist (HSA) temporarily prevents the vehicle from rolling in an unintended direction during the transition from brake pedal release to accelerator pedal apply. The brakes release when the accelerator pedal is applied or automatically release after a few

seconds. The brakes may also release under other conditions. Do not rely on HSA to hold the vehicle.

HSA is available when the vehicle is facing uphill in a forward gear, or when facing downhill in R (Reverse). The vehicle must come to a complete stop on a grade for HSA to activate.

### Automatic Vehicle Hold (AVH)



 **Warning**

Do not rely on this feature. It does not replace the need to pay attention and drive safely. You may not hear or feel alerts or warnings provided by this system. Failure to use proper care when driving may result in injury, death, or vehicle damage.

When Automatic Vehicle Hold (AVH) is turned on and the vehicle is braked to a stop, AVH prevents the vehicle from moving during the transition from brake pedal release to accelerator pedal apply. The brakes release when the accelerator pedal is applied. The brakes may also release under other conditions. Do not rely on AVH to hold the vehicle.

If the accelerator pedal is not applied within a few minutes, the Electric Parking Brake will apply. The parking brake will also apply if the driver door is opened or the driver seat belt is unfastened while AVH is holding the vehicle.

AVH can be turned on by pressing AUTO HOLD. The indicator light on the switch will come on. The AVH light on the instrument panel

will come on while AVH is actively holding the vehicle. See *Automatic Vehicle Hold (AVH) Light* ⇨ 104.

## Ride Control Systems

### Traction Control/Electronic Stability Control

The vehicle has a Traction Control System (TCS) and StabiliTrak/Electronic Stability Control (ESC). These systems help limit wheel slip and assist the driver in maintaining control, especially on slippery road conditions.

TCS activates if it senses that any of the drive wheels are spinning or beginning to lose traction. When this happens, the system brakes the spinning wheel(s) and/or reduces engine power to limit wheel spin.

StabiliTrak/ESC activates when the computer senses a difference between the intended path and the direction the vehicle is actually traveling. StabiliTrak/ESC selectively applies braking pressure at any one of the vehicle's brakes to help steer the vehicle in the intended direction.

If cruise control is being used and TCS or StabiliTrak/ESC begins to limit wheel spin, cruise control will disengage. Cruise control may be turned back on when road conditions allow.

Both systems come on automatically when the vehicle is started and begins to move. The systems may be heard or felt while they are operating or while performing diagnostic checks. This is normal and does not mean there is a problem with the vehicle.

It is recommended to leave both systems on for normal driving conditions, but it may be necessary to turn TCS off if the vehicle gets stuck in sand, mud, ice, or snow. See *If the Vehicle Is Stuck* ⇨ 187 and "Turning the Systems Off and On" later in this section.



The indicator light for both systems is in the instrument cluster. This light will:

- Flash when TCS is limiting wheel spin.
- Flash when StabiliTrak/ESC is activated.

- Turn on and stay on when either system is not working.

If either system fails to turn on or to activate, a message may display in the Driver Information Center (DIC), and  comes on and stays on to indicate that the system is inactive and is not assisting the driver in maintaining control. The vehicle is safe to drive, but driving should be adjusted accordingly.

If  comes on and stays on:

1. Stop the vehicle.
2. Turn the engine off and wait 15 seconds.
3. Start the engine.



Drive the vehicle. If  comes on and stays on, the vehicle may need more time to diagnose the problem. If the condition persists, see your dealer.



## Turning the Systems Off and On







### Caution



Do not repeatedly brake or accelerate heavily when TCS is off. The vehicle driveline could be damaged.

To turn off only TCS, press and release . The traction off light  displays in the instrument cluster. A DIC message may display.

To turn TCS on again, press and release . The traction off light  displayed in the instrument cluster will turn off.

If TCS is limiting wheel spin when  is pressed, the system will not turn off until the wheels stop spinning.

To turn off both TCS and StabiliTrak/ESC, press and hold  until the traction off light  and StabiliTrak/ESC OFF light  come on and stay on in the instrument cluster. A DIC message may display.

To turn TCS and StabiliTrak/ESC on again, press and release . The traction off light  and StabiliTrak/ESC OFF light  in the instrument cluster turn off.

Adding accessories can affect the vehicle's performance. See *Accessories and Modifications* ⇨ 287 .

## Driver Mode Control

Driver Mode Control (DMC) allows the driver to adjust the overall driving experience to better suit driver preference by adjusting vehicle systems to fit specific driving needs. Drive mode availability and affected vehicle systems are dependent on vehicle trim level, region, and optional features.

If the vehicle is in Tour, Sport, and My Mode, it will stay in that mode through future ignition cycles. If the vehicle is in any other mode, it will return to Tour mode when the vehicle is restarted. When a mode is selected, an indicator comes on in the instrument cluster and stays on.

### Mode Activation



**Driver Mode Control Switch for Automatic Transmission**



**Driver Mode Control Switch for Manual Transmission**

To activate, press the MODE switch on the center console. Use the up and down arrows to move through the menu.

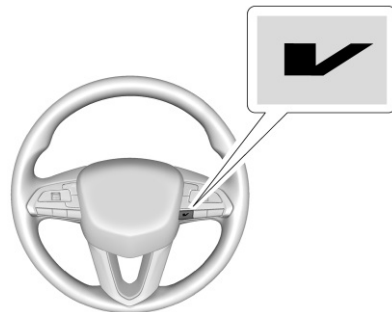

**V-Mode Switch (Variant 1)**

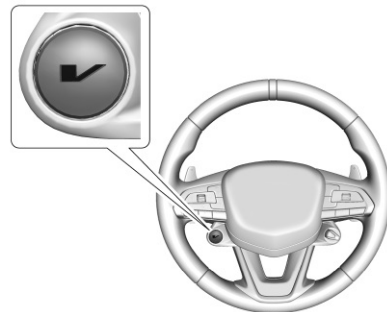

**V-Mode Switch (Variant 2)**

Depending on trim level, the V-Mode switch may be located on the right side or left side of the steering wheel. To activate V-Mode, press the V-Mode switch on the steering wheel. To deactivate, select a different mode using the DMC switch, or press the V-Mode switch again.

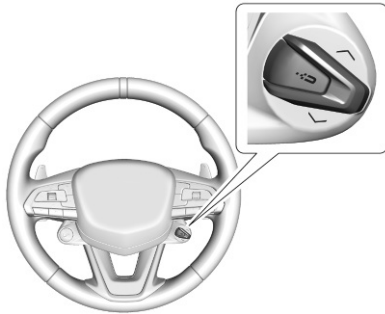

### Performance Traction Management (PTM) Switch

If equipped, activate PTM by pressing up on the PTM switch on the steering wheel. A PTM menu will appear in the Driver Information Center (DIC). Press up or down on the PTM switch to scroll through the options and make a selection. To exit PTM, select INACTIVE in the PTM menu.

## Mode Description

### Tour Mode

Use for normal city and highway driving to provide a smooth, soft ride. This mode provides a balance between comfort and handling. This is the standard mode. See “Mode Selection Attributes” later in this section. When Tour mode is selected, no indicator will display.

### Sport Mode

Use this mode where road conditions or personal preference demand a more controlled response. When this mode is selected, the vehicle immediately downshifts. The vehicle also monitors driving behaviors and automatically enables Performance Shift Features when spirited driving is detected. These features maintain lower transmission gears to increase available engine braking and improve acceleration response. The vehicle will exit this feature and return to normal operation after a short period when spirited driving is no longer detected. The steering changes to provide more precise control. If the vehicle has Magnetic Ride Control, the suspension changes to provide better cornering performance. See “Mode Selection Attributes” later in this section.

### Snow/Ice Mode

Use this mode for slippery surfaces to help control wheel speed. This mode can compromise the acceleration on dry asphalt. This feature is not intended for use when the vehicle is stuck in sand, mud, or gravel. If the vehicle is stuck, see *If the Vehicle Is Stuck* ⇨ 187. See “Mode Selection Attributes” later in this section.

### Track Mode (V-Series and V-Series Blackwing)

When in Track mode, the automatic transmission and steering function similar to Sport mode. The accelerator pedal is adjusted to give maximum control during the highest level of spirited driving. The Magnetic Ride Control is set to the optimum level for vehicle responsiveness. PTM can be accessed through this mode. See “Performance Traction Management” in *Performance Driving* ⇨ 217. See “Mode Selection Attributes” later in this section. While driving on a track, turn off applicable driver assistance features. For more information see *Assistance Systems for Driving* ⇨ 259.

**My Mode**

My Mode is used to personalize everyday driving. This mode is designed to allow the driver to configure vehicle systems to their own preference for city or normal driving.

Through the DIC, the following vehicle systems may be available for customization in this mode.

- Steering: Tour (default), Sport, Track
- Suspension: Tour (default), Sport, Track
- Brake Feel: Tour (default), Sport, Track
- Engine Sound: Stealth, Tour (Default), Sport, Track

For information on the range of settings, see “Drive Mode Customization.”

**V-Mode (V-Series and V-Series Blackwing)**

V-Mode is used to personalize dynamic driving. This mode is designed to allow the driver to configure vehicle subsystems to their own preference for maximum handling. V-Mode further enhances the driver’s experience by adding an Engine/Shift customization option. Through the DIC, the following vehicle systems may be available for customization in this mode.

- Steering: Tour, Sport (default), Track
- Suspension: Tour, Sport, (default), Track
- Engine/Shift: Snow/Ice, Tour, Sport, (default), Track
- Brake Feel: Tour, Sport, Track
- Engine Sound: Stealth, Tour, Sport (default), Track
- PTM: OFF, WET, DRY, SPORT, RACE 1, RACE 2

For information on the range of settings, see “Drive Mode Customization.”

## Mode Selection Attributes

MODES	TOUR <i>Default</i>	SPORT	TRACK	SNOW/ICE
Engine/Shift	Tour	Tour	Track	Snow/Ice
Throttle Progression	Tour	Tour	Track	Snow/Ice
Transmission Shift Mode	Tour	Sport	Track	Tour
Engine Sound	Tour	Sport	Track	Tour
Steering	Tour	Sport	Track	Tour
Suspension (if equipped with Magnetic Ride Control)	Tour	Sport	Track	Tour
Traction and Stability Control	Tour	Tour	Track	Tour
Competitive Driving Mode (if equipped)	Not Available	Available	Not Available	Not Available
Performance Traction Mode (if equipped)	Not Available	Not Available	Available	Not Available
Brake Feel	Tour	Sport	Track	Tour

### Throttle Progression

Adjusts throttle sensitivity by selecting how quick or slow the throttle reacts to input.

- Snow/Ice – The accelerator pedal reduces engine torque at small pedal inputs. This allows better wheel control on slippery surfaces.
- Track – The accelerator pedal adjusts to give maximum control during the highest level of spirited driving.



**Transmission Shift Mode**

Sport or Track – Dynamic Performance Mode (DPM) allows the transmission to hold the current gear after a quick release of a heavily applied accelerator pedal. This provides greater engine braking and enhanced vehicle control without using the paddles. DPM recognizes aggressive cornering, heavy braking, and high acceleration to select and hold lower gears when not using paddles. The shifts are also firmer to increase the quickness of shifting.

**Engine Sound**

Adjusts the volume of engine noise.

The sound level changes when the variable exhaust valves open.

**Steering (Assist Effort)**

Adjusts from a lighter steering feel in Tour Mode to reduced assist in Sport and Track Mode for more steering feel.

**Magnetic Ride Control**

If equipped, adjusts the shock dampening firmness from a comfort in Tour mode to an optimized responsiveness tune in Sport and Track.

**Stability Control**

- Competitive mode allows less computer control to permit some slide and drift and is selected with the TCS/StabiliTrak button – only available in Sport mode.
- StabiliTrak/Electronic Stability Control (ESC) can be turned off by pressing and holding the TCS/StabiliTrak button for five seconds.

**Brake Feel**

Adjusts brake pedal sensitivity by selecting how quick or slow the brakes respond to input.

**Drive Mode Customization**

The following settings can be changed using the Drive Mode Customization Menu. See Settings > Vehicle > Drive Mode Customization in the center display to customize My Mode or V-Mode.

**Steering**

Steering adjusts the effort required to turn the steering wheel. The steering wheel offers better feedback in the Tour setting, but requires more effort in the Sport and Track settings.

- Tour, Sport, Track

**Suspension**

Suspension adjusts the firmness of the suspension in the vehicle. Suspension adjusts the stiffness of the shocks and/or springs. The ride is more comfortable at lower settings and is stiffer at higher settings for better control.

- Tour, Sport, Track

**Brake Feel**

Brake Feel adjusts the brake pedal response. Settings range from a slower response for more comfortable driving to the quickest response for quicker deceleration. Brake pedal travel decreases and caliper pressure increases in the Sport and Track settings.

- Tour, Sport, Track

**Engine/Shift**

Engine/Shift adjusts the throttle response, gear shifting and engine performance. Throttle response increases in the Sport, Track, and Snow/Ice settings, and gear shifting is more aggressive.

- Tour, Sport, Track, Snow/Ice

## Engine Sound

Engine sound adjusts the volume of engine noise. The settings range from quietest to loudest volume from Stealth through Track.

- Stealth, Tour, Sport, Track

## PTM

If equipped, PTM controls vehicle performance systems for professional handling on race tracks. Traction Control and Stability Control are reduced when moving through each of the settings. Changing PTM settings may also automatically change the other subsystem settings. While driving on a track, turn off all active safety features. While driving on a track, turn off applicable driver assistance features. For more information, see *Assistance Systems for Driving* ⇨ 259. For more information on PTM, see *Performance Driving* ⇨ 217.

- Off, Wet, Dry, Sport, Race 1, Race 2

## Performance Driving



Competitive Driving mode, Performance Traction Management (PTM), and Launch Control are systems designed for a closed course race track and not intended for public

roads. The systems are not intended to compensate for lack of driver experience or familiarity with the race track.

## Competitive Driving Mode

### Caution



When traction control is turned off, or Competitive Driving Mode is active, it is possible to lose traction.

Competitive Driving mode enables spirited driving, allowing for more rear wheel spin and slip. Once engaged, the Traction Control System (TCS) does not limit wheel spin, and the electronic Limited-Slip Differential (eLSD) allows increased agility. The Traction OFF light  and StabiliTrak/ESC OFF light  appear when in Competitive Driving mode and more effort is required to turn the steering wheel. Adjust your driving accordingly. See “Limited-Slip Differential (V-Series Only)” later in this section.

To engage Competitive Driving mode:

1. Press the Driver Mode Control switch and select Sport mode. See *Driver Mode Control* ⇨ 211.

2. Press  two times. COMPETITIVE MODE ON displays in the Driver Information Center (DIC).

Press  again, or turn the vehicle to accessory mode and restart the vehicle, to turn TCS back on. The Traction OFF light  and StabiliTrak/ESC OFF light  turn off.

## Performance Traction Management

If equipped, activate PTM through V Mode customization or press the ESC switch twice while in Track mode. Depending on available options and trim levels, there may be a PTM switch on the steering wheel.

To enter PTM through V Mode customization:

1. Select Settings > Vehicle > Driver Mode Customization > V Mode and select the desired PTM mode.
2. Press the V Mode switch once to activate. “V Mode Active – Press Again for PTM On – ESC May be Disabled” appears in the DIC.
3. To confirm and enter PTM, press the V Mode switch again.

4. Modify the PTM mode using the MODE switch or changing the V Mode PTM settings in the center stack. Both the V Mode and PTM indicators display.

To exit PTM, press the ESC switch. To cancel, press the center dismiss button on the steering wheel (V Mode remains active).

To enter PTM through the PTM switch on the steering wheel, if equipped:

1. Press up on the switch to activate PTM.
2. A PTM menu appears in the DIC. Press up or down on the PTM switch to make a selection.

To exit PTM, select INACTIVE in the PTM menu, turn off PTM in the V Mode configuration page, or press the ESC switch once.

Selecting PTM modes may modify Off, Wet, Dry, Sport, Race 1, and Race 2 V Mode customization options.

Descriptions and recommendations of each DIC mode display include:

#### Wet

- Intended for all driver skill levels.

- Wet or damp conditions only — not intended for use in heavy rain or standing water.
- StabiliTrak/ESC is on and engine power is reduced based on conditions.

#### Dry

- For use by less experienced drivers or while learning a new track.
- Dry conditions only.
- StabiliTrak/ESC is on and engine power is slightly reduced.

#### Sport

- For use by drivers who are familiar with the track.
- Dry conditions only.
- Requires more driving skill than Dry.
- StabiliTrak/ESC is on and more engine power is available than in Dry.

#### Race 1

- For use by drivers who are familiar with the track.
- Dry conditions only.

- Requires more driving skill than modes Dry or Sport.
- StabiliTrak/ESC is off and available engine power is the same as Sport.

#### Race 2

- For use by experienced drivers who are familiar with the track.
- Dry conditions only.
- Requires more driving skill than mode Race 1.
- StabiliTrak/ESC is off and engine power is available for maximum cornering speed.

#### Pro

- Traction Control and StabiliTrak/ESC are off.
- Requires more driving skill than mode Race 2.
- All traction and stability systems are disabled for the most analog driving experience. Drive with caution.

In any PTM Mode, Launch Control is available. Use PTM Race 2 for the most consistent performance during drag strip use. See

“Custom Launch Control” in *Track Events and Competitive Driving (V-Series and V-Series Blackwing)* ⇨ 176.

## Launch Control

If equipped, Launch Control is available within Competitive Driving mode and PTM to allow high levels of vehicle acceleration in a straight line. Launch Control is a form of traction control that manages tire spin while launching the vehicle. This feature is intended for use during closed course race events where consistent zero to 60 and quarter mile times are desirable.

Launch Control is only available when the following criteria are met:

- Competitive Driving Mode is selected or any of the PTM modes are selected. The Traction OFF light  comes on in the instrument cluster and the appropriate DIC message displays.
- The vehicle is not moving.
- The steering wheel is pointing straight.
- The brake pedal is firmly pressed to the floor, equivalent to a panic brake event.

- The accelerator pedal is rapidly applied to wide open throttle. If the vehicle rolls due to wide open throttle, release the throttle, press the brake pedal more firmly, and reapply the accelerator to wide open throttle.

Launch Control initially limits engine speed as you rapidly apply the accelerator pedal to wide open throttle. Allow the engine rpm to stabilize. A smooth, quick release of the brake pedal, while maintaining the fully pressed accelerator pedal, manages wheel slip.

After the vehicle is launched, the system continues in Competitive Driving Mode or PTM.

## Performance App

The following are all possible performance app features, if equipped.

To access the performance app menu, select  from the infotainment home screen. Touch the icons in the top left to access the three pages: Output, Dyno, and Custom.

## Output

The Output page displays after selecting . To return to the Output page when in the Dyno or Custom page, select the top icon in the left corner. This page shows gauges for power, torque, and engine boost.

## Dyno

Select the middle icon in the left corner to access the Dyno page. This page shows a live graph of engine power and torque. You can change the timeframe of the graph to show the past 15 or 30 seconds or one or two minutes. To stop and inspect the current graph, select pause, then bring the vehicle to a stop. A slider appears overlaying the graph. Drag the slider to the left or right to view data at a specific time.

## Custom

Select the bottom icon in the left corner to access the Custom page. The performance app content displays on the infotainment display. This page consists of three options. Swipe up and down on each option to select what gauges to display.

Selecting performance app content on the infotainment display opens a dialog box for that option. To select a desired option within

a dialog box, if available, touch the option and follow any message or alerts that display. Some options may be unavailable while driving.

Touch Add to Driver Display to send the desired content to the Driver Information Center (DIC) on the instrument cluster. Touch Remove from Driver Display to remove the selected content from the instrument cluster. See *Driver Information Center (DIC)* ⇨ 111.

After selecting Add to Driver Display, a message to switch views to show the feature may appear. Select Continue.

### Options

The following is the list of all possible performance app content. Some content and options may not be available for your vehicle.

**Engine Boost:** If equipped, displays engine manifold pressure relative to ambient air pressure. It displays boost pressure generated by the supercharging or turbocharging system.

When selected, touch Add to Driver Display to send the content to the DIC.

**Vitals:** Displays Oil Pressure, Coolant Temperature, Transmission Fluid Temperature, and Oil Temperature.

Oil Pressure is shown in either kPa (kilopascals) or psi (pounds per square inch). Coolant Temperature, Transmission Fluid Temperature, and Oil Temperature are shown in either degrees Celsius (°C) or degrees Fahrenheit (°F).

When selected, touch Add to Driver Display to send the content to the DIC.

**G-Force:** Displays inertial forces being exerted on the vehicle in the lateral (side to side) and vertical (acceleration and braking) direction as numerical values and graphical depictions.

When selected, touch Add to Driver Display to send the content to the DIC.

**Handling:** If equipped, displays electronic Limited-Slip Differential (eLSD) information.

Electronic Limited-Slip Differential (eLSD) shows the amount of rear differential coupling when the eLSD is active and functioning during vehicle operation. A reading of 1% is an open differential and 100% is locked. It is normal for the value to make small or large changes due to driving conditions and driver inputs. See *Limited-Slip Differential* ⇨ 221.

**Tires:** If equipped, displays the approximate pressures of all four tires. Tire pressure displays in either kilopascal (kPa) or in pounds per

square inch (psi). If the pressure is low, the value for that tire is shown in amber. See *Tire Pressure Monitor System* ⇨ 333 and *Tire Pressure Monitor Operation* ⇨ 334.

If equipped, Tire Temperature is located above the tire pressure graphic. Tire Temperature shows overall temperature as either Cold, Cool, Normal, Warm, or Hot. Normal is typical for normal driving while Warm is typical for spirited driving. Peak tire grip is at warm. Unknown displays when tire temperature information is unavailable.

If equipped, Brake Temperature is located below the tire pressure graphic. Brake Temperature shows overall temperature as either Normal, Warm, Hot, or Overheated. Normal is typical for normal driving while Warm is typical for spirited driving. Peak brake performance is at warm. Unknown displays when tire temperature information is unavailable.

**Output:** Shows current engine power, torque, and boost. The current gear also displays on vehicles equipped with an automatic transmission.

When selected, touch Add to Driver Display to send the content to the DIC.

## Limited-Slip Differential

If equipped, the Electronic Limited-Slip Differential (eLSD) is automatically activated. eLSD actively monitors vehicle sensors and driver inputs to determine the amount of change for the conditions. With eLSD, the vehicle has:

- Enhanced high-speed control.
- Improved traction through corners, allowing more acceleration.
- More precise steering.
- Increased vehicle agility.
- Integration with StabiliTrak/Electronic Stability Control (ESC).

For vehicles with eLSD, driven under severe conditions, the rear axle fluid should be changed. See *Performance Driving* ⇨ 217 and *Maintenance Schedule* ⇨ 365.

## Cruise Control

Cruise control allows the vehicle to maintain a speed of 40 km/h (25 mph) or more without using the accelerator pedal. Cruise control does not work at speeds below 40 km/h (25 mph).

### Warning

Cruise control can be dangerous where you cannot drive safely at a steady speed. Do not use cruise control on winding roads or in heavy traffic.

Cruise control can be dangerous on slippery roads. On such roads, fast changes in tire traction can cause excessive wheel slip, and you could lose control. Do not use cruise control on slippery roads.

If equipped with a manual transmission, cruise control will remain active when the gears are shifted.

Cruise control will disengage if:

- The clutch pedal is applied for several seconds, if equipped with a manual transmission.
- The Traction Control System (TCS) or StabiliTrak/Electronic Stability Control (ESC) system begins to limit wheel spin. See *Traction Control/Electronic Stability Control* ⇨ 210.
- TCS or StabiliTrak/ESC is turned off.

- A collision alert occurs. See *Forward Collision Alert (FCA) System* ⇨ 259.
- The brakes are applied.

When road conditions allow cruise control to be safely used, cruise control can be turned back on.

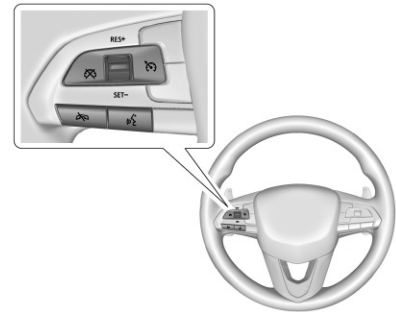

: Press to turn cruise control on and off. A white indicator light appears in the instrument cluster when cruise control is turned on.

**RES+:** If cruise control is already engaged, press the thumbwheel up to increase the set speed. If cruise control is on and there is a set speed in memory, briefly press up to resume cruise control at the previous set speed.

**SET-** : If cruise control is already on, briefly press the thumbwheel down to set the cruise speed and engage cruise control. If cruise control is already engaged, press down to decrease the set speed.

 : Press to disengage cruise control without erasing the set speed from memory.

### Setting Cruise Control

If cruise control is on but is not engaged, the thumbwheel could be pressed to SET- or RES+ and engage cruise control when not desired. Keep cruise control off when it is not being used. Press  to turn off cruise control.

To set the cruise speed:

1. Press .
2. Accelerate to the desired speed.
3. Press and release SET-. The set speed briefly appears in the instrument cluster.
4. Remove your foot from the accelerator pedal.

When cruise control has been set to the desired speed, the cruise control indicator light turns green, and a cruise control set speed message is displayed briefly in the instrument cluster. See

*Instrument Cluster*  92.

### Resuming a Set Speed

If cruise control is set at a desired speed and then the brakes are applied or  is pressed, cruise control is disengaged without erasing the set speed from memory.

Once the vehicle speed reaches about 40 km/h (25 mph) or more, briefly press the thumbwheel up to RES+ to engage cruise control at the previous set speed.

### Increasing Speed While Using Cruise Control

If cruise control is already engaged:

- Press and hold the thumbwheel up to the first or the second position for RES+ until the desired cruise speed is reached, then release it.
- To increase the vehicle speed in small increments, briefly press the thumbwheel up to the first position for RES+ and then release it. For each press, the vehicle speed increases by about 1 km/h (1 mph).
- To increase the vehicle speed in larger increments, briefly press the thumbwheel up to the second position for RES+ and then release it. For each press, the vehicle speed increases to the next 5 km/h (5 mph) mark on the speedometer.

The speedometer reading can be displayed in either English or metric units. The increment value used by cruise control depends on the units displayed by the speedometer.

### Reducing Speed While Using Cruise Control

If cruise control is already engaged:

- Press and hold the thumbwheel down to the first or the second position for SET- until the desired lower cruise speed is reached, then release it.
- To decrease the vehicle speed in small increments, briefly press the thumbwheel down to the first position for SET-, and then release it. For each press, the vehicle speed decreases by about 1 km/h (1 mph).
- To decrease the vehicle speed in larger increments, briefly press the thumbwheel down to the second position for SET- and then release it. For each press, the vehicle speed decreases to the next 5 km/h (5 mph) mark on the speedometer.

The cruise control system may automatically brake to slow the vehicle down.

### Passing Another Vehicle While Using Cruise Control

Use the accelerator pedal to increase the vehicle speed. When you take your foot off of the accelerator pedal, the vehicle will slow down to the previous set cruise speed. While pressing the accelerator pedal or shortly following the release to override cruise control, briefly pressing the thumbwheel down to SET- will result in the cruise speed being set to the current vehicle speed.

### Using Cruise Control on Hills

How well cruise control works on a hill depends on the vehicle speed, load, and the steepness of the hill. When going up a steep hill, you may need to apply the accelerator pedal to maintain the set speed.



When going down a steep hill, to maintain the desired cruise speed, you may need to:

- Apply the brake pedal
- Apply the brake pedal and/or shift to a lower gear, if equipped with a manual transmission

If you apply the brake pedal, cruise control disengages. See "Resuming a Set Speed" previously in this section.

### Ending Cruise Control

There are five ways to end cruise control:

- Lightly apply the brake pedal.
- Press .
- Shift the transmission to N (Neutral).
- Press the clutch pedal for several seconds or shift to N (Neutral) (manual transmissions).
- Press .

### Erasing Speed Memory

The cruise control set speed is erased from memory if  is pressed or when the vehicle is turned off.

### Speed Limiter

If equipped, Speed Limiter allows you to set a maximum speed limit. When Speed Limiter is active at a set speed, it prevents the vehicle from accelerating above the set speed even if you continue to accelerate.

Speed Limiter can be used at speeds of about 20 km/h (12 mph) or more.

You can temporarily override the set speed. See "Overriding Speed Limiter" later in this section.

Speed Limiter does not limit the vehicle speed when driving down a hill. If the vehicle speed exceeds the set speed when driving down a hill, beeps will sound to alert you that the vehicle has exceeded the set speed.

### Warning

Speed Limiter does not automatically apply the brakes in emergency braking situations. To avoid possible injury or death, always be prepared to brake in emergencies and pay careful attention to the road ahead while driving.

Speed Limiter will automatically be disabled if:

- Cruise control or Adaptive Cruise Control (ACC) is turned on, if equipped.
- Super Cruise is turned on, if equipped.

Speed Limiter is controlled using the +RES and -SET thumbwheel and the  button on the steering wheel:

+RES : Move the thumbwheel up to resume Speed Limiter at the last set speed in memory, to increase the set speed (Manual mode), or to increase the offset (Auto mode).



-SET : Move the thumbwheel down to choose the set speed, to decrease the set speed (Manual mode), or to decrease the offset (Auto mode).

 : Press to disengage Speed Limiter while keeping the last set speed in memory.

### Automatic Speed Limiter

Automatic Speed Limiter uses an on-board camera and navigation data to identify speed limit road signs and propose a new set speed based on that data.

In Auto mode, you can adjust the set speed with an offset above or below the identified speed limit using the steering wheel controls. See "Increasing the Set Speed" and "Decreasing the Set Speed" later in this section.

### Warning

In Auto mode, Speed Limiter may not prompt for set speed changes when encountering conditional speed limit signs, for example time frames or when construction workers are present. To avoid a crash, personal injury, or death, always pay attention to posted signs and follow applicable traffic laws.

### Manual Speed Limiter

Speed Limiter can also be used in Manual mode. In Manual mode, all changes to the set speed are controlled by the driver.

### Selecting the Speed Limiter Mode

To enable Speed Limiter, select a Speed Limiter mode. From the infotainment home screen touch Controls > Drive (Drive & Park) > Speed Limiter. The following options are available:

- Off
- Manual
- Auto

When a Speed Limiter mode is selected,  will be lit white in the instrument cluster.

### Setting Speed Limiter

Press the thumbwheel down to -SET to activate Speed Limiter and use the current vehicle speed as the set speed. When Speed Limiter is active,  will be lit green in the instrument cluster.

### Increasing the Set Speed

While Speed Limiter is active, move the thumbwheel up to +RES to increase the set speed (Manual mode), or to increase the offset from the area speed limit (Auto mode).

- Briefly move the thumbwheel up to +RES and release it. For each press, the set speed increases by 1 km/h (1 mph).
- Press and hold the thumbwheel up to +RES to increase the set speed by 5 km/h (5 mph). Release the thumbwheel when the desired set speed is displayed in the instrument cluster.

When using Speed Limiter in Auto mode, there is a predefined maximum allowed value of offset beyond which the set speed cannot be increased.

### Decreasing the Set Speed

While Speed Limiter is active, move the thumbwheel down to -SET to decrease the set speed (Manual mode), or to decrease the offset from the area speed limit (Auto mode).

- Briefly move the thumbwheel down to -SET and release it. For each press, the set speed decreases by 1 km/h (1 mph).

- Press and hold the thumbwheel down to -SET to decrease the set speed by 5 km/h (5 mph). Release the thumbwheel when the desired set speed is displayed in the instrument cluster.

When using Speed Limiter in Auto mode, there is a predefined minimum allowed value of offset beyond which the set speed cannot be decreased.

### Accept or Decline Automatic Set Speed Changes (Auto)

When Speed Limiter is in Auto mode, is active, and a new speed limit sign is detected, it will propose a new set speed based on the detected speed limit sign. The proposed new set speed will be displayed as a message in the instrument cluster.

- To accept the new set speed, briefly move the thumbwheel down to -SET and release it.
- To decline the new set speed, briefly move the thumbwheel up to +RES and release it.

If you do not accept or decline the new proposed set speed, there is no change to the set speed.

### Conditions Affecting Automatic Speed Limiter (Auto)

- There are changes in brightness, such as entering and exiting tunnels, bridges, and overpasses.
- There are low sun angles.
- Ambient lighting is poor in the evening or early morning.
- There are multiple changes in brightness or there are shadows along the roadway.
- There are conditions associated with low visibility such as fog, rain, snow, or road spray.
- The on-board camera's view of the road is blocked by leaves, snow, or other debris.

If Automatic Speed Limiter becomes temporarily unavailable, change to Manual mode.

### Resuming Speed Limiter

If Speed Limiter was active but then  was pressed, Speed Limiter can be resumed using the previous set speed. Briefly move the thumbwheel up to +RES and release it to activate Speed Limiter using the previous set speed.

If Speed Limiter was turned off because cruise control, ACC, or Super Cruise was turned on, to use Speed Limiter again:

1. Turn off cruise control, ACC, or Super Cruise.
2. On the infotainment home screen, touch Controls > Drive (Drive & Park) > Speed Limiter.
3. Select Manual or Auto.

### Overriding Speed Limiter

When Speed Limiter is active, the set speed can be temporarily overridden only when you fully apply the accelerator pedal. You can control vehicle acceleration again when the vehicle speed is below the set speed.

### Turning Off Speed Limiter

To turn off Speed Limiter, from the infotainment home screen, touch Controls > Drive (Drive & Park) > Speed Limiter > Off.

### Adaptive Cruise Control (Advanced)

If equipped, Adaptive Cruise Control (ACC) allows the cruise control set speed and following gap to be selected. Read this entire section before using this system. The following

gap is the following time between your vehicle and a vehicle detected directly ahead in your path, moving in the same direction. If no vehicle is detected in your path, ACC works like regular cruise control. ACC uses camera and radar sensors. See *Radio Frequency Statement* ⇨ 387.

If a vehicle is detected in your path, ACC can speed up the vehicle or apply limited, moderate braking to maintain the selected following gap. To disengage ACC, apply the brake. If the Traction Control System (TCS) or StabiliTrak/Electronic Stability Control (ESC) system activates while ACC is engaged, ACC may automatically disengage. See *Traction Control/Electronic Stability Control* ⇨ 210.

When road conditions allow ACC to be safely used, ACC can be turned back on. ACC will not engage if the TCS or StabiliTrak/ESC electronic stability control system is disabled.

ACC can reduce the need for you to frequently brake and accelerate, especially when used on expressways, freeways, and interstate highways. When used on other roads, you may need to take over the control of braking or acceleration more often.

### Warning

ACC has limited braking ability and may not have time to slow the vehicle down enough to avoid a collision with another vehicle you are following. This can occur when vehicles suddenly slow or stop ahead, or enter your lane. Also see “Alerting the Driver” in this section. Complete attention is always required while driving and you should be ready to take action and apply the brakes. See *Defensive Driving* ⇨ 174.

### Warning

ACC will not detect or brake for children, pedestrians, animals, or other objects.

Do not use ACC when:

- On winding and hilly roads or when the sensors are blocked by snow, ice, or dirt. The system may not detect a vehicle ahead. Keep the entire front of the vehicle clean.

(Continued)

### Warning (Continued)

- Visibility is low, such as in fog, rain, or snow conditions. ACC performance is limited under these conditions.
- On slippery roads where fast changes in tire traction can cause excessive wheel slip.
- When towing a trailer.

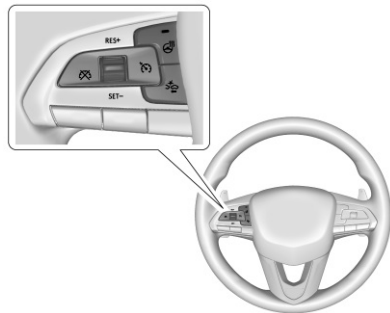



 : Press to turn the system on or off. The indicator turns white on the instrument cluster when ACC is turned on.

**RES+:** Press briefly to resume the previous set speed or to increase vehicle speed if ACC is already engaged. To increase speed by 1 km/h (1 mph), press RES+ to the first detent. To increase speed to the next 5 km/h (5 mph) mark on the speedometer, press RES+ to the second detent.



**SET-:** Press briefly to set the speed and activate ACC or to decrease vehicle speed if ACC is already engaged. To decrease speed by 1 km/h (1 mph), press SET- to the first detent. To decrease speed to the next 5 km/h (5 mph) mark on the speedometer, press SET- to the second detent.

: Press to disengage ACC without erasing the selected set speed.

: Press to select a following gap time (or distance) setting for ACC of Far, Medium, or Near.

The speedometer reading can be displayed in either English or metric units. See *Instrument Cluster*  92. The increment value used depends on the units displayed.

### Switching Between ACC and Regular Cruise Control

To switch between ACC and regular cruise control, press and hold . A Driver Information Display (DIC) message displays. See *Vehicle Messages*  120.





ACC Indicator (Base Level)



ACC Indicator (Uplevel)



Regular Cruise Control Indicator

When ACC is engaged, a green  indicator will be lit on the instrument cluster. When the regular cruise control is engaged, a green  indicator will be lit on the instrument cluster and the following gap will not display.



When the vehicle is turned on, the cruise control mode will be set to the last mode used before the vehicle was turned off.

Switch from ACC to regular cruise control only when there are no vehicles ahead of your vehicle.

### Warning

Always check the cruise control indicator on the instrument cluster to determine which mode cruise control is in before using the feature. If ACC is not active, the vehicle will not automatically brake for other vehicles, which could cause a crash if the brakes are not applied manually. You and others could be seriously injured or killed.

### Setting Adaptive Cruise Control

If  is on when not in use, SET-/RES+ could be pressed by mistake and activate ACC when not desired. Keep  off when cruise is not being used.

Select the set speed desired for ACC. This is the vehicle speed when no vehicle is detected in its path.

While the vehicle is moving, ACC will not set at a speed below a minimum speed, although it can be resumed. If equipped with Super Cruise, this minimum speed is 5 km/h (3 mph), otherwise, it is 25 km/h (15 mph). The minimum allowable set speed is 25 km/h (15 mph).

To set ACC while moving:

1. Press .
2. Accelerate to the desired speed.
3. Press and release SET-.
4. Remove your foot from the accelerator.

After ACC is set, it may immediately apply the brakes if a vehicle ahead is detected closer than the selected following gap.

ACC can also be set while the vehicle is stopped if ACC is on and the brake pedal is applied.

The ACC indicator displays on the instrument cluster and Head-Up Display (HUD), if equipped. When ACC is turned on, the indicator light displays white. When ACC is engaged, the indicator light turns green.

Be mindful of speed limits, surrounding traffic speeds, and weather conditions when selecting the set speed.

### Resuming a Set Speed

If ACC is set at a desired speed and then the brakes are applied, ACC is disengaged without erasing the set speed from memory.

To begin using ACC again, press RES+ up briefly while moving more than 5 km/h (3 mph). The vehicle returns to the previous set speed.

If the vehicle is stopped with the brake pedal applied, press RES+ and release the brake pedal. ACC will hold the vehicle until RES+ or the accelerator pedal is pressed.

A green ACC indicator and the set speed display on the instrument cluster. The vehicle ahead indicator may be flashing if a vehicle ahead was present and moved. See “Approaching and Following a Vehicle” later in this section.

Once ACC has resumed, if there is no vehicle ahead, if the vehicle ahead is beyond the selected following gap, or if the vehicle has exited a sharp curve, then the vehicle speed will increase to the set speed.

### Increasing Speed While ACC Is at a Set Speed

If ACC is already activated, do one of the following:

- Use the accelerator to get to the higher speed. Press SET- . Release the control and the accelerator pedal. The vehicle will now cruise at the higher speed.

When the accelerator pedal is pressed, ACC will not brake because it is overridden. The ACC indicator light will turn blue on the instrument panel and the HUD, if equipped

- Press and hold RES+ until the desired set speed is displayed, then release it.
- To increase speed in smaller increments, press RES+ to the first detent. For each press, the vehicle goes 1 km/h (1 mph) faster.

- To increase speed in larger increments, press RES+ to the second detent. For each press, the vehicle speed increases to the next 5 km/h (5 mph) mark on the speedometer.

The set speed can also be increased while the vehicle is stopped.

- If stopped with the brake applied, press RES+ until the desired set speed is displayed.
- If ACC is holding the vehicle at a stop and there is another vehicle directly ahead, pressing RES+ will increase the set speed.
- Pressing RES+ when there is no longer a vehicle ahead or the vehicle ahead is pulling away and the brake is not applied will cause the ACC to resume.

When it is determined there is no vehicle ahead or the vehicle ahead is beyond the selected following gap, then the vehicle speed will increase to the set speed.

The speedometer reading can be displayed in either English or metric units. See *Instrument Cluster* ↪ 92. The increment value used depends on the units displayed.

### Reducing Speed While ACC Is at a Set Speed

If ACC is already activated, do one of the following:

- Use the brake to get to the desired lower speed. Release the brake and press SET-. The vehicle will now cruise at the lower speed.
  - Press and hold SET- until the desired lower speed is displayed, then release it.
  - To decrease speed in smaller increments, press SET- to the first detent. For each press, the vehicle goes about 1 km/h (1 mph) slower.
  - To decrease speed in larger increments, press or hold SET- to the second detent. For each press, the vehicle speed decreases to the next 5 km/h (5 mph) mark on the speedometer.
- The set speed can also be decreased while the vehicle is stopped.
- To decrease speed while the vehicle is stopped, press SET- until the desired set speed is displayed.

### Selecting the Follow Distance Gap

When a slower moving vehicle is detected ahead within the selected following gap, ACC will adjust the vehicle's speed and attempt to maintain the follow distance gap selected.

Press  on the steering wheel to adjust the following gap. Each press cycles the gap button through three settings: Far, Medium, or Near.

When pressed, the current gap setting displays briefly on the instrument cluster and the HUD (if equipped). Subsequent presses cycle the gap button through three settings: Far, Medium, or Near. The gap setting will be maintained until it is changed.

Gap Adjust



Far Gap Setting

Gap Adjust



Medium Gap Setting

Gap Adjust



Near Gap Setting

Since each gap setting corresponds to a following time (Far, Medium, or Near), the following distance will vary based on vehicle speed. The faster the vehicle speed, the further back your vehicle will follow a vehicle detected ahead. Consider traffic and weather conditions

when selecting the following gap. The range of selectable gaps may not be appropriate for all drivers and driving conditions.

Changing the gap setting automatically changes the alert timing sensitivity (Far, Medium, or Near) for the Forward Collision Alert (FCA) feature. See *Forward Collision Alert (FCA) System* ⇨ 259.

### Courtesy Gap (If Equipped with Super Cruise)

Press and Hold  on the steering wheel when vehicle is moving to temporarily increase the gap with the vehicle ahead to allow for merging traffic.

Press and Hold  when stopped to cancel ACC from resuming automatically (if the stop is brief) and remain stationary. This can be used to allow traffic to merge between you and the vehicle ahead.

Press RES+ or the accelerator pedal to resume ACC. Following distance gap will return to the original selection after hold.

### Alerting the Driver

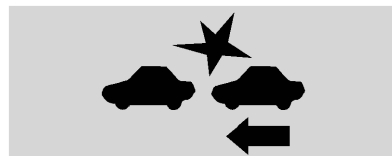

If ACC is engaged, driver action may be required when ACC cannot apply sufficient braking because of approaching a vehicle too rapidly.

When this condition occurs, the collision alert symbol will flash on the windshield. Either eight beeps will sound from the front, or both sides of the Safety Alert Seat will pulse five times. To view available settings for this feature, touch the Settings icon on the infotainment home page. Select “Vehicle” to display the list of available options and select “Collision/Detection Systems.”

See *Defensive Driving* ⇨ 174.

## Approaching and Following a Vehicle



The vehicle ahead indicator is in the instrument cluster and HUD display, if equipped.

The vehicle ahead indicator only displays when a vehicle is detected in your vehicle's path moving in the same direction.

If this symbol is not displaying, ACC will not respond to or brake to vehicles ahead.

ACC automatically slows the vehicle down and adjusts vehicle speed to follow a detected vehicle ahead at the selected follow gap. The vehicle speed increases or decreases to follow a detected vehicle in front of your vehicle when that vehicle is traveling slower than your vehicle set speed. It may apply limited braking, if necessary. When braking is active, the brake lamps will come on. The automatic braking may feel or sound different than if the brakes were applied manually. This is normal.

## Passing a Vehicle While Using ACC

If the set speed is high enough, and the left turn signal is used to pass a vehicle ahead in the selected following gap, ACC may assist by gradually accelerating the vehicle prior to the lane change.

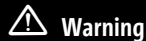

### Warning

When using ACC to pass a vehicle or perform a lane change, the following distance to the vehicle being passed may be reduced. ACC may not apply sufficient acceleration or braking when passing a vehicle or performing a lane change. Always be ready to manually accelerate or brake to complete the pass or lane change.

## Stationary or Very Slow-Moving Objects

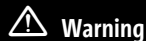

### Warning

ACC may not detect and react to stopped or slow-moving vehicles ahead of you. For example, the system may not brake for a vehicle it has never detected moving. This can occur in stop-and-go traffic or when

(Continued)

## Warning (Continued)

a vehicle suddenly appears due to a vehicle ahead changing lanes. Your vehicle may not stop and could cause a crash. Use caution when using ACC. Your complete attention is always required while driving and you should be ready to take action and apply the brakes.

## Irregular Objects Affecting ACC

ACC may have difficulty detecting the following objects:

- Vehicles with cargo extending from the back end.
- Non-standard shaped vehicles, such as vehicle transport, vehicles with a side car fitted, or horse carriages.
- Objects that are close to the front of your vehicle.

## ACC Automatically Disengages

ACC may automatically disengage and you will need to manually apply the brakes to slow the vehicle when:

- The sensors are blocked.



- The Traction Control System (TCS) or StabiliTrak/ESC system has activated or been disabled.
- There is a fault in the system.
- The radar falsely reports blockage when driving in a desert or remote area with no other vehicles or roadside objects.
- A DIC message may display to indicate that ACC is temporarily unavailable.

The ACC indicator light will turn white when ACC is no longer active.

In some cases, when ACC will not activate, regular Cruise Control may be used. See “Switching Between ACC and Regular Cruise Control” previously in this section. Always consider driving conditions before using either cruise control system.

#### Notification to Resume ACC

ACC will maintain a follow gap behind a detected vehicle and slow your vehicle to a stop behind that vehicle.

If the stopped vehicle ahead has driven away and ACC has not resumed, the vehicle ahead indicator will flash as a reminder to check traffic ahead before proceeding. In addition, the left and right sides of the Safety Alert Seat will

pulse three times, or three beeps will sound. Touch the Settings icon on the infotainment home page. Select “Vehicle” to display the list of available options and select “Alert Type” and “Adaptive Cruise Go Notifier” in “Collision/Detection Systems”.

If equipped with Driver Attention System (DAS) located on top of the steering column, when the vehicle ahead drives away, and DAS determines if the driver's attention is on the road ahead, ACC resumes automatically. See “Attention to the Road” under *Super Cruise* ⇨ 235. If necessary, press RES+ or the accelerator pedal to resume ACC. If stopped for more than two minutes or if the driver door is opened and the driver seat belt is unbuckled, the ACC automatically applies the Electric Parking Brake (EPB) to hold the vehicle. The EPB status light will turn on. See *Electric Parking Brake* ⇨ 208. To release the EPB, press the accelerator pedal.

A DIC warning message may display indicating to shift to P (Park) before exiting the vehicle.

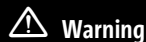

**Warning**

If ACC has stopped the vehicle, and if ACC is disengaged, turned off, or canceled, the vehicle will no longer be held at a stop. The vehicle can move. When ACC is holding the vehicle at a stop, always be prepared to manually apply the brakes.

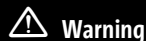

**Warning**

Leaving the vehicle without placing it in P (Park) can be dangerous. Do not leave the vehicle while it is being held at a stop by ACC. Always place the vehicle in P (Park) and turn off the ignition before leaving the vehicle.

#### ACC Override

If using the accelerator pedal while ACC is active, the ACC indicator turns blue on the instrument cluster and in the HUD (if equipped) to indicate that automatic braking will not occur. ACC will resume operation when the accelerator pedal is not being pressed.

### Warning

The ACC will not automatically apply the brakes if your foot is resting on the accelerator pedal. You could crash into a vehicle ahead of you.

#### Curves in the Road

### Warning

On curves, ACC may not detect a vehicle ahead in your lane. You could be startled if the vehicle accelerates up to the set speed, especially when following a vehicle exiting or entering exit ramps. You could lose control of the vehicle or crash. Do not use ACC while driving on an entrance or exit ramp. Always be ready to use the brakes if necessary.

### Warning

On curves, ACC may respond to a vehicle in another lane, or may not have time to react to a vehicle in your lane. You could crash

(Continued)

### Warning (Continued)

into a vehicle ahead of you, or lose control of your vehicle. Give extra attention in curves and be ready to use the brakes if necessary. Select an appropriate speed while driving in curves.

ACC may operate differently in a sharp curve. It may reduce the vehicle speed if the curve is too sharp.

If equipped, the curve speed control indicator light  may illuminate green when ACC is actively controlling the vehicle speed and detects a sharp curve on the road ahead.

ACC automatically slows the vehicle down while navigating the curve and may increase speed out of the curve, but will not exceed the set speed.

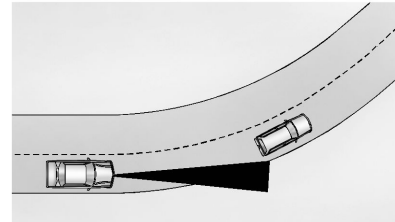

When following a vehicle and entering a curve, ACC may not detect the vehicle ahead and accelerate to the set speed. When this happens, the vehicle ahead indicator will not appear.

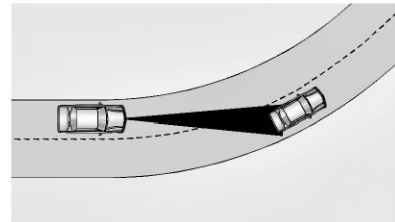

ACC may detect a vehicle that is not in your lane and apply the brakes.

ACC may occasionally provide an alert and/or braking that is considered unnecessary. It could respond to vehicles in different lanes, signs,

guardrails, and other stationary objects when entering or exiting a curve. This is normal operation. The vehicle does not need service.

### Other Vehicle Lane Changes

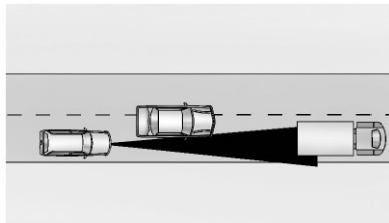

ACC will not detect a vehicle ahead until it is completely in the lane. The brakes may need to be manually applied.

### Objects Not Directly in Front of Your Vehicle

The detection of objects in front of the vehicle may not be possible if:

- The vehicle or object ahead is not within your lane.
- The vehicle ahead is shifted, not centered, or is shifted to one side of the lane.

### Driving in Narrow Lanes

Vehicles in adjacent traffic lanes or roadside objects may be incorrectly detected when located along the roadway.

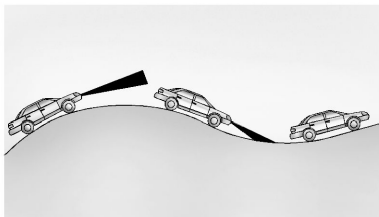

### Do Not Use ACC on Hills and When Towing a Trailer



Do not use ACC when driving on steep hills or when towing a trailer. ACC will not detect a vehicle in the lane while driving on steep hills. If the brakes are applied, ACC disengages.

### Disengaging ACC

There are three ways to disengage ACC:

- Step lightly on the brake pedal.
- Press .
- Press .

### Erasing Speed Memory

The ACC set speed is erased from memory if  is pressed or if the ignition is turned off.

### Weather Conditions Affecting ACC

System operation may be limited under snow, heavy rain, or road spray conditions.

### Accessory Installations and Vehicle Modifications

Do not install or place any object around the front camera windshield area that would obstruct the front camera view.

Do not install objects on top of the vehicle that overhang and obstruct the front camera, such as a canoe, kayak, or other items.

Do not modify the hood, headlamps, or fog lamps, as this may limit the camera's ability to detect an object.

### Cleaning the Sensing System

The camera sensor on the windshield behind the rearview mirror and the radar sensors on the front of the vehicle can become blocked by snow, ice, dirt, or mud. These areas need to be cleaned for ACC to operate properly.

If ACC will not operate, regular Cruise Control may be available. See “Switching Between ACC and Regular Cruise Control” previously in this section. Always consider driving conditions before using either cruise control system.

For cleaning instructions, see “Washing the Vehicle” under *Exterior Care* ⇨ 354.

## Super Cruise

If equipped, Super Cruise can steer to maintain lane position under certain conditions on Super Cruise-enabled roads.

Super Cruise can also steer to perform a lane change under certain conditions on Super Cruise-enabled roads.

A lane change can be initiated by the driver using the turn signal lever. If equipped with Automatic Lane Change, the Super Cruise system may initiate a lane change maneuver in the following scenarios:

- To pass slower traffic
- When the current lane is ending ahead
- To return to the initial lane
- To provide space for vehicles merging from an ending lane

See “Super Cruise Lane Change” later in this section and *Turn and Lane-Change Signals* ⇨ 128.

### Warning

Super Cruise can only assist to maintain lane position, or steer to change lanes, when driving on compatible roads. You must supervise the driving task and monitor the road conditions. You may need to respond to traffic events by steering, braking, or accelerating. See Defensive Driving.

Super Cruise is:

- Not a self-driving system
- Not a crash avoidance or warning system
- Not a substitute for proper supervision of the driving task

Super Cruise uses the following to detect the current lane position and lane markings ahead on Super Cruise-compatible roads under certain conditions:

- Cameras
- Global Positioning System (GPS) sensing

- A high-precision map
- GPS-enhancement data downloaded through Connected Services

An active Connected Service plan that includes Super Cruise Services is required to use Super Cruise.

Super Cruise works with Adaptive Cruise Control (ACC), which controls acceleration and braking while Super Cruise is enabled and operating. Carefully review the information in this “Super Cruise” section and in the “Adaptive Cruise Control” section before using Super Cruise. See *Adaptive Cruise Control (Advanced)* ⇨ 225.

### Warning

Super Cruise does not perform all aspects of driving, nor does it do everything a driver can do. Super Cruise only steers to maintain vehicle position in the current lane or, under some circumstances, to change lanes. Super Cruise can only be used with Adaptive Cruise Control.

Super Cruise does:

(Continued)

**Warning (Continued)**

- Not prevent crashes or warn of possible crashes.
- Not steer to avoid stopped or slow-moving vehicles, cross-traffic, construction barriers or cones, motorcycles, children, pedestrians, animals, or other objects on the road.
- Not steer in response to vehicles or objects next to your vehicle, including vehicles attempting to enter your lane.
- Not respond to traffic lights, stop signs, or other traffic control devices.
- Not respond to crossing traffic.
- Not make turns.
- Not steer to merge onto or to exit highways.
- Not steer to avoid, or steer through construction zones.
- Not function on surface streets.
- Not respond to oncoming traffic.
- Not function in city driving conditions.

 **Warning**

Some state and local laws may require hands to be kept on the steering wheel at all times. Only remove your hands from the steering wheel if Super Cruise is engaged, it is safe to do so, and it is permitted by state and local laws.

 **Warning**

Failure to supervise the driving task and to respond appropriately, even while Super Cruise is operating, can cause a crash. Super Cruise may not respond as you would to all driving situations and may not maintain lane position under all conditions.

It is extremely important to pay attention to the operation of the vehicle, even while using Super Cruise. Do not use a hand-held device while driving, even with Super Cruise engaged. To prevent serious injury or death:

- Always remain properly seated in the driver seat with your seat belt fastened.

(Continued)

**Warning (Continued)**

- Never remove your hands from the steering wheel when Super Cruise is not operating.
- Always make sure traffic conditions are safe before using Super Cruise.
- Always keep the entire vehicle and the sensors clean. Sensors are on the front, sides, and rear of the vehicle.
- Always observe posted speed limits. Only use Super Cruise at or below the posted speed limit.

Super Cruise should not be used in complex or uncertain driving conditions, including:

- Not in construction zones.
- Not when approaching or exiting toll plazas.
- Not when approaching an intersection that is controlled with a traffic light, stop sign, or other traffic control device.

(Continued)

### Warning (Continued)

- Not when lane markings are not present or cannot be detected. For example, there is too much glare, weather conditions are poor, or lanes are poorly marked.
- Not on slippery or icy roads.
- Not in adverse weather conditions, including rain, sleet, fog, ice, or snow.
- Not on winding or hilly roads.
- Not for city driving.
- Not during heavy or emergency braking.
- Not on a road shoulder, service drive, or under an elevated freeway.
- Not when towing a trailer.
- Not in a highway exit lane.

### When Super Cruise is Available



#### Super Cruise Indicator

Super Cruise is designed to operate only when:

- ACC is on. See *Adaptive Cruise Control (Advanced)* ⇨ 225.
- Teen Driver is not active.
- The GPS detects the vehicle is on a Super Cruise-compatible road.
- The camera and the radar sensors are functioning and not covered, obstructed, or damaged.
- The Driver Attention System (DAS) detects the driver's head and eyes are directed toward the road ahead.
- The lane markings are clearly visible and detectable by the system.

Super Cruise may be unavailable if the system detects that the outside air temperature is very cold.







Poor Conditions



Poor Conditions

## Using Super Cruise

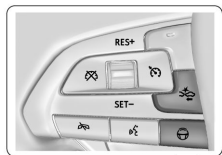

 **Warning**

To prevent serious injury or death, only remove your hands from the steering wheel if the steering wheel light bar, , and  are green. Super Cruise may not begin steering immediately, even when Super Cruise is available and  has been pressed.



To engage Super Cruise:

1. Press  to turn on ACC.

Make sure the ACC light  is lit white on the instrument cluster. See *Adaptive Cruise Control (Advanced)* ⇨ 225. When Super Cruise is available, the Super Cruise light  displays on the instrument cluster and is lit white.

2. Press  to engage Super Cruise.

ACC will set the speed to the current vehicle speed or resume to the higher previously stored ACC set speed.

If equipped, when Auto Set Speed is enabled and Road Speed Limit is detected, ACC will set the speed to the road speed limit (+/- selected offset). For more information about Auto Set Speed customization, see *Adaptive Cruise Control (Advanced)* ⇨ 225.

 **Warning**

Always monitor the vehicle speed and make sure that you are following the speed limit, regardless of the Auto Set Speed status.

When Super Cruise is engaged and is not steering the vehicle, the steering wheel light bar flashes blue and  will display blue. The driver is in control of steering and Super Cruise is not steering the vehicle.

When Super Cruise is engaged and is not steering the vehicle, the steering wheel light bar flashes blue and the Super Cruise light  is lit blue. The driver is in control of steering and Super Cruise is not steering the vehicle.

When the vehicle is positioned in the center of the lane, the steering wheel light bar is lit green and the Super Cruise light  is lit green, indicating that Super Cruise is steering the vehicle.

When Super Cruise is controlling the steering, traffic and other conditions and laws permit, and it is safe to do so, your hands can be taken off the steering wheel.

Always pay attention to the road and the operation of the vehicle. Always monitor and be attentive of surrounding traffic, including vehicles that may cross the road in front of your vehicle.

Super Cruise steering can be overridden with manual steering at any time. When Super Cruise is engaged, always be prepared to take immediate action – including steering, accelerating, and braking quickly, if necessary.

When Super Cruise is engaged, the Forward Collision System is enabled to Alert and Brake.

### Steering Manually and Changing Lanes

The vehicle can always be manually steered, even with Super Cruise engaged; for example, when manually changing lanes.

When the steering wheel is moved manually, the steering wheel light bar flashes blue and  displays blue on the instrument cluster to indicate Super Cruise is not steering the vehicle.

When ready to allow Super Cruise to resume steering again, position the vehicle in the center of the lane, hold the steering wheel until the steering wheel light bar turns green, and then release the steering wheel when it is safe to do so.



### Warning

To help prevent crashes before making a lane change:

- Always check mirrors.
- Glance over your shoulder.
- Use the turn signals.

### Super Cruise Lane Change

#### On Demand Lane Changes

Super Cruise can steer to perform a single lane change under certain conditions when requested by the driver activating the turn signal or when automatically initiated by the Super Cruise system.

To request a lane change:

1. Verify the lane next to your vehicle is clear and conditions are safe to make a lane change.
2. Use the turn signal lever to activate the turn signal in the direction of the desired lane change.
3. Return the turn signal lever to the neutral position after the lane change. See *Turn and Lane-Change Signals* ⇨ 128.

To cancel a lane change, return the turn signal lever to the neutral position, move the lever in the opposite direction of the lane change, or steer manually at any time.

### Automatic Lane Changes

If equipped with automatic lane change, and if the automatic lane change setting is enabled, Super Cruise may initiate a single lane change under the following conditions:

- To use the left lane to pass a slower moving vehicle ahead and a subsequent lane change to the right to return to the original lane.
- To use the left or right lane when the current lane is ending ahead.
- If a slower moving vehicle is detected in the adjacent ending lane, Super Cruise may merge to the left or the right lane to provide space for the merging vehicle.

To cancel a Super Cruise lane change, return the turn signal lever to the neutral position or move the turn signal lever.

Super Cruise steering can be overridden with manual steering at any time to cancel a Super Cruise lane change.



If the Super Cruise system detects that traffic is clear, it will steer the vehicle to perform the lane change. A message appears on the Driver Information Center (DIC) during the lane change to provide more information on the status of the lane change.

Super Cruise Lane Change functionality is only available on Super Cruise-capable divided roads.

Super Cruise Lane Change functionality is not available when a construction zone is detected.

Super Cruise Lane Change may be disabled when a trailer or other accessories (e.g., a bike rack, cargo tray, etc.) is detected.

Do not use Super Cruise Lane Change when towing a trailer.

The Super Cruise Lane Change feature can be customized to be Off, Turn Signal Activated, or Automatic through vehicle settings. To view the available settings, from the infotainment home screen, touch Settings > Vehicle > Super Cruise Lane Change.

### Warning

Super Cruise Lane Change may not detect a vehicle in an adjacent lane. Always supervise the driving task and monitor traffic conditions when using the Super Cruise Lane Change feature. Only request a lane change when traffic conditions are safe for a lane change, and always be ready to manually steer the vehicle. See “Steering Manually and Changing Lanes” listed previously in this section.

### Take Over Alert

### Warning

Super Cruise will not maintain the vehicle's speed while the steering wheel light bar is flashing red. If the steering wheel light bar flashes red, immediately resume manual steering to prevent serious injury or death. If you do not resume manual steering, the vehicle will begin to slow in the same lane and eventually come to a complete stop on the road.

Any time the steering wheel light bar flashes red, resume manual steering immediately.

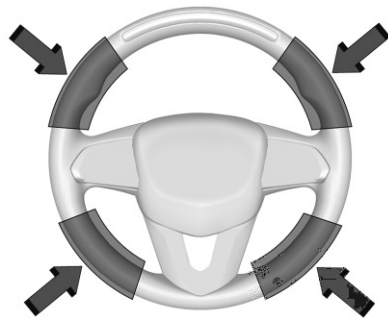

To begin steering manually, hold the steering wheel firmly with both hands using the highlighted regions. The Super Cruise light  will display red and a message will display in the DIC. In addition, beeps will sound or the Safety Alert Seat will vibrate, if equipped. To view collision and detection settings, from the infotainment home screen, touch Settings > Vehicle > Collision/Detection Systems. When you begin steering manually, Super Cruise will disengage.

The red flashing steering wheel light bar could occur under any of the following conditions:

- Lane markings are poor, or visibility is limited.
- The DAS does not detect that the driver's head and eyes are directed toward the road.
- ACC has been canceled.
- The vehicle is on a tight curve, the lanes are too wide, or the vehicle enters a curve too fast.
- The speed limit of a Super Cruise-compatible non-divided road is below 72 km/h (45 mph).
- The Super Cruise-compatible road ends.
- The vehicle is approaching an intersection controlled by a traffic light, stop sign, or other traffic control device.
- A Super Cruise system fault occurs.
- Super Cruise is unable to complete the lane change maneuver.
- Super Cruise detects a very cold outside air temperature.

### Attention to the Road

#### Warning

Super Cruise is a driver assistance system and cannot accurately detect or predict all situations. Super Cruise is not a crash avoidance system. To prevent serious injury or death, you must supervise the driving task and monitor the road conditions. You may need to respond to traffic events by steering, braking, or accelerating. See *Defensive Driving* ⇨ 174. Super Cruise also cannot determine whether you are awake, asleep, impaired, or properly focused on safe driving. The vehicle could crash into other vehicles, drive out of the lane, or drive off the road. Complete attention is always required while driving, even while using Super Cruise. Be prepared to take over steering or apply the brakes at any time.

#### Warning

To prevent serious injury or death, be alert and pay special attention when passing highway exits, entrances, and crossings with Super Cruise, and be ready to take control of the vehicle when necessary. Changes in lane markings around exits and entrances can momentarily cause Super Cruise to not detect the correct lane. If this occurs, Super Cruise may attempt steering inputs to bring the vehicle back into the correct lane and, in rare circumstances, could over-correct and cause the vehicle to momentarily cross into a lane next to your vehicle unless you manually steer to maintain your lane position.

The DAS camera on the steering column continually monitors the driver's head and eye position to estimate driver attention to the road. The camera does not record or share pictures, audio, or video.

Sunglasses, hats, or other types of clothing that change the shape of the head may interfere with camera performance. To improve camera performance, raise or lower the steering wheel, or change the seat position.

Pay close attention to the road ahead to avoid these three alerts of increasing severity:

First Alert	<ul style="list-style-type: none"> <li>• If the steering wheel light bar flashes green, the system has detected that your head and eyes may not be directed toward the road.</li> <li>• The flashing will stop when the system detects that your head and eyes appear to be directed toward the road.</li> </ul>
Second Alert	<ul style="list-style-type: none"> <li>• If the steering wheel light bar flashes green for too long, Super Cruise will alert the driver to take control of steering immediately by flashing the light bar red. In addition, beeps will sound or the Safety Alert Seat will vibrate, if equipped. To view the available alert settings on the infotainment home screen, touch Settings &gt; Vehicle &gt; Collision/Detection Systems &gt; Alert Type.</li> <li>• Take over steering, then Super Cruise may disengage or the steering wheel light bar flashes blue to indicate driver override. Do not take your hands off of the steering wheel until the steering wheel light bar illuminates green.</li> <li>• To re-engage Super Cruise after disengagement, press . See “Using Super Cruise” previously in this section.</li> </ul>
Third Alert	<ul style="list-style-type: none"> <li>• If the steering wheel light bar flashes red for too long, a voice command will instruct you to take control of the vehicle.</li> <li>• Take control of the steering immediately; ACC and Super Cruise will disengage.</li> <li>• A DIC message will indicate that Super Cruise is locked out. Super Cruise cannot be re-engaged until the next ignition cycle.</li> <li>• Continued failure to take over steering will cause the vehicle to brake to a stop and OnStar will be called. The brake lamps and hazard warning flashers will come on.</li> <li>• Take control of the vehicle to continue driving.</li> </ul>

### Stationary or Very Slow-Moving Objects; Cross-Traffic

#### Warning

Super Cruise is not a crash avoidance system and will not steer or brake to avoid a crash. Super Cruise does not steer to prevent a crash with stopped or slow-moving vehicles. You must supervise the driving task and may need to steer and brake to prevent a crash, especially in stop-and-go traffic or when a vehicle suddenly enters your lane. Always pay attention when using Super Cruise. Failure to do so could result in a crash involving serious injury or death.

### Curves in the Road

#### Warning

The vehicle could drift out of your lane of travel. To prevent crashes, always be ready to manually steer.

(Continued)

#### Warning (Continued)

Super Cruise may not detect your lane on curves in the road. Super Cruise may not detect the markings that show your lane. You may not have time to react to a vehicle in the lane next to your vehicle while on curves in the road.

Super Cruise may hand control back to the driver more often when driving through a sharp curve.

Super Cruise may operate differently in sharp curves. The vehicle may drift out of your lane of travel if the curve is too sharp.

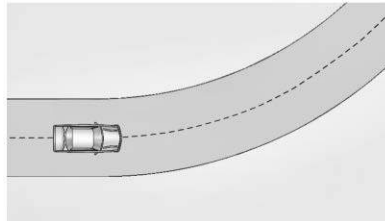

When entering a curve, Super Cruise may not detect the lane markings and may not adjust the steering enough to stay in your lane of travel. When this happens, you will need to steer the vehicle.

Super Cruise may detect other lane markings that are not in your lane and may or may not steer appropriately to maintain your lane.

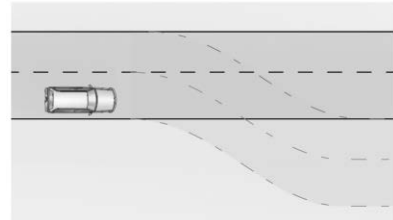

Super Cruise may occasionally provide an alert and/or steering that is considered unnecessary. It could respond to lane markings in different lanes, signs, guardrails, and other stationary objects when entering or exiting a curve. This is normal operation. The vehicle does not need service.

### Other Vehicles Entering Your Lane

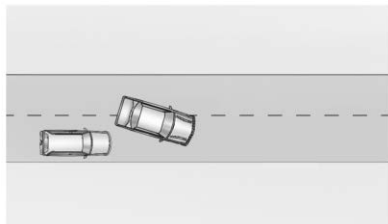

Super Cruise may not detect a vehicle that enters your lane or may not brake fast enough to avoid a crash. You must manually brake and steer the vehicle.

### Intersections; Vehicles Crossing the Road Ahead

Super Cruise will not brake the vehicle when approaching an intersection that is controlled by a traffic light or stop sign. Super Cruise will not detect vehicles crossing the road ahead, including at intersections, and will not automatically steer or brake to prevent a collision. You must manually brake and steer the vehicle.

### Towing a Trailer

Do not use Super Cruise when towing a trailer. See *General Towing Information* ⇨ 278.

### Super Cruise on Hills

Do not use Super Cruise while driving on steep hills.

### Super Cruise on Non-Divided Roads

Super Cruise may be available on non-divided roads that are mapped, outside of urbanized areas and have a road speed limit above 72 km/h (45 mph).

### Super Cruise Indicator Light Summary



The steering wheel light bar and instrument cluster light provide the following important information about Super Cruise operation:



Steering Wheel Light Bar	Instrument Cluster Light	Super Cruise Description
Off	Off	Super Cruise is off. There is no automatic steering. Operate the vehicle manually.
Off	White	Super Cruise is available and can be engaged.
Solid Green	Solid Green	Super Cruise is steering. Pay attention to the road and vehicle operation.
Flashing Blue	Solid Blue	Super Cruise is not steering. Operate the vehicle manually. See “Steering Manually and Changing Lanes” previously in this section.
Flashing Green	Solid Green	Super Cruise has detected you are not paying sufficiently close attention to the road. Pay attention to the road. See “Attention to the Road” previously in this section.
Flashing Red	Solid Red	Take over steering immediately. Super Cruise will disengage. See “Take Over Alert” previously in this section.

### Disengaging Super Cruise

There are two ways to disengage Super Cruise:

- Press  while your hands are on the steering wheel. Super Cruise steering will disengage.
- Press the brake pedal while your hands are on the steering wheel. Both Super Cruise steering and ACC will disengage.

### Super Cruise Messages

If  does not appear, press  to display a DIC message that provides a reason why Super Cruise is unavailable.

Immediately after a disengagement, pressing  within 10 seconds will display a DIC message with the reason for Super Cruise disengagement.

### Super Cruise Message Summary

Message	Possible Causes
Subscription Required Press OnStar Button	<ul style="list-style-type: none"> <li>• The required Connected Services subscription may have ended.</li> <li>• Press the Blue OnStar button in your vehicle to speak with an OnStar Advisor, who can help determine the issue and what actions to take.</li> </ul>
Unavailable Turn on Adaptive Cruise Control	<p>ACC must be on before Super Cruise can be enabled.</p> <ul style="list-style-type: none"> <li>• A set speed is not required before engaging Super Cruise.</li> <li>• ACC is not required to be engaged before you can engage Super Cruise.</li> </ul>
Unavailable Lane Ending	<p>Super Cruise is disabled because the driving lane is ending.</p>
Unavailable No Road Information	<ul style="list-style-type: none"> <li>• There is no map information available for that portion of the road. Recent road reconstruction may turn off Super Cruise for that section of road until new map information is available.</li> <li>• The vehicle is not on the correct type of road. A controlled access freeway or Super Cruise-compatible divided or non-divided road is required to use Super Cruise.</li> <li>• There are lanes entering or exiting on both the left and right side of the road.</li> </ul>

Message	Possible Causes
Unavailable Sensors Can't Find Lane Lines	<ul style="list-style-type: none"><li>• Rain or snow is inhibiting the system's ability to identify lane lines.</li><li>• Direct sunlight is shining on the front camera at dawn or dusk.</li><li>• There are missing or poor lane line markings on the road.</li><li>• There is sun glare on the road surface.</li><li>• There is heavy rain, puddles, or road spray.</li></ul>
Unavailable Sensor Can't See Face Clearly	<ul style="list-style-type: none"><li>• Cups, food, hands, or other objects are obscuring the DAS camera's view of the driver's face.</li><li>• The steering column is pointed too high or low for the DAS camera to detect the driver's face. Adjust the steering column or the seat if the message is displayed frequently.</li><li>• The sun is shining into the DAS camera.</li><li>• Dawn or dusk sun glare is shining on the driver's face.</li></ul>
Unavailable Looking Away From Road for Too Long	The DAS detects that the driver is not looking at the road.
Unavailable Driving Too Fast	The vehicle is traveling faster than 137 km/h (85 mph). The maximum Super Cruise speed in curves will vary based on how sharp the curve is. The vehicle will automatically decrease speed if needed.
Unavailable Driving in Exit Lane	The Super Cruise system has detected that the vehicle is in an exit lane.



Message	Possible Causes
Unavailable GPS Signal Lost	<ul style="list-style-type: none"><li>• There is poor reception in isolated areas.</li><li>• Reception is being blocked by buildings or other large structures.</li></ul>
Unavailable You Have Taken Vehicle Control	<ul style="list-style-type: none"><li>• The brake pedal is being pressed.</li><li>• ACC has been canceled or turned off.</li></ul>
Unavailable Sensor Blocked	Carefully clear any snow, ice, dirt, or other contaminants from the front and rear areas of the vehicle.
Unavailable Sharp Curve	Some curves are too sharp to be navigated by the Super Cruise system. Super Cruise will be available after exiting the curve.
Super Cruise Unavailable	Super Cruise is unavailable for reasons not described in other messages.
Super Cruise Locked Out See Owner's Manual	The driver did not take control of the vehicle when prompted by the Super Cruise system. The Super Cruise system will be disabled until the vehicle is turned off and back on.
Unavailable Seat Belt Not Fastened	The driver seat belt is not fastened.
Unavailable Teen Driver Mode Active	Teen Driver mode is active.
Unavailable Unsupported Intersection	Super Cruise has detected an unsupported intersection.

Message	Possible Causes
Unavailable Approaching Toll Booth	Super Cruise has detected that there is a toll booth ahead.
Unavailable Construction Zone – Drive With Care	Super Cruise has detected a construction zone.

### Map Updates

Super Cruise map information must be periodically updated at least once every seven months to determine whether Super Cruise is available on certain roads.

Turn on the vehicle's built-in Wi-Fi hotspot to receive automatic updates via OnStar, or see your dealer. For additional information on the Wi-Fi hotspot, see *Settings* ⇨ 159.

Disabling the vehicle's Wi-Fi, Share Hotspot Data, or Location Services will disable automatic map updates. Super Cruise will stop functioning after seven months or less depending on the time of the last map update.

### Data Download

If the vehicle is equipped with OnStar and has an active service plan, additional data may be collected through the OnStar system. This includes information about: the vehicle's operation; a crash involving the vehicle; the use of the vehicle and its features; and, in certain situations, the location and approximate GPS speed of the vehicle. Refer to the OnStar Terms and Conditions and Privacy Statement on the OnStar website.

### Location Services

This setting enables or disables sharing of vehicle location outside the vehicle for certain purposes. Even if the Location Services setting is disabled, vehicle location information will continue to be shared for emergency services and Super Cruise, if equipped.

### System Care

The camera on the steering column has a lens cover that may become dirty over time and affect camera performance. Clean the lens cover with a soft cloth sprayed with glass cleaner. Wipe the lens gently, then dry it. Never use abrasive cloths/cleaners or corrosive chemicals of any kind on the lens cover.

Super Cruise uses the front radar, front camera, and 360-degree cameras for its operation. Clean surfaces are required for Super Cruise operation. See *Adaptive Cruise Control (Advanced)* ⇨ 225, "Surround Vision Camera" under *Assistance Systems for Parking or Backing* ⇨ 251, and *Lane Keep Assist (LKA)* ⇨ 272 for care information.

**Caution**

The Super Cruise system is a highly sophisticated system and should only be serviced by technicians with the proper training, tools, and safety instructions, which your dealer has. Without proper training and tools the vehicle may become damaged.

## Advanced Driver Assistance Systems

This vehicle may have features that work together to help avoid crashes or reduce crash damage while driving, backing, and parking. Read this entire section before using these systems.

**Warning**

Do not rely on the Driver Assistance Systems. These systems do not replace the need for paying attention and driving safely. You may not hear or feel alerts or warnings provided by these systems.

(Continued)

**Warning (Continued)**

Failure to use proper care when driving may result in injury, death, or vehicle damage. See *Defensive Driving* ⇨ 174.

Under many conditions, these systems will not:

- Detect children, pedestrians, bicyclists, or animals.
- Detect vehicles or objects outside the area monitored by the system.
- Work at all driving speeds.
- Warn you or provide you with enough time to avoid a crash.
- Work under poor visibility or bad weather conditions.
- Work if the detection sensor is not cleaned or is covered by ice, snow, mud, or dirt.
- Work if the detection sensor is covered up, such as with a sticker, magnet, or metal plate.

(Continued)

**Warning (Continued)**

- Work if the area surrounding the detection sensor is damaged or not properly repaired.

Complete attention is always required while driving, and you should be ready to take action and apply the brakes and/or steer the vehicle to avoid crashes.

**Audible or Safety Alert Seat**

Some driver assistance features alert the driver of obstacles by beeping. To view available settings for this feature, touch the Settings icon on the infotainment home page. Select “Vehicle” to display the list of available options and select “Comfort and Convenience”.

If equipped with the Safety Alert Seat, the driver seat cushion may provide a vibrating pulse alert instead of beeping. To view available settings for this feature, touch the Settings icon on the infotainment home page. Select “Vehicle” to display the list of available options and select “Collision/ Detection Systems”.

## Cleaning

Depending on vehicle options, keep these areas of the vehicle clean to ensure the best driver assistance feature performance. Driver Information Center (DIC) messages may display when the systems are unavailable or blocked.

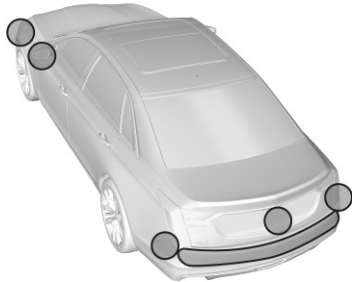

- Front and rear bumpers and the area below the bumpers
- Front grille and headlamps
- Front camera lens in the front grille or near the front emblem
- Front side and rear side panels
- Outside of the windshield in front of the rearview mirror
- Side camera lens on the bottom of the outside mirrors
- Rear side corner bumpers
- Rear Vision Camera above the license plate

## Radio Frequency

This vehicle may be equipped with driver assistance systems that operate using radio frequency. See *Radio Frequency Statement* ⇨ 387.

## Assistance Systems for Parking or Backing

If equipped, the Rear Vision Camera (RVC), Rear Park Assist (RPA), Front Park Assist (FPA), Surround Vision, Reverse Automatic Braking (RAB) and Backing Warning System, and Rear Cross Traffic Alert (RCTA) may help the driver park or avoid objects. Always check around the vehicle when parking or backing.

## Rear Vision Camera (RVC)

When the vehicle is shifted into R (Reverse), the RVC displays an image of the area behind the vehicle in the infotainment display. The previous screen displays when the vehicle is shifted out of R (Reverse) after a short delay. To return to the previous screen sooner, press Home or Back on the infotainment system, shift into P (Park), or reach a vehicle speed of approximately 12 km/h (8 mph) while in D (Drive).

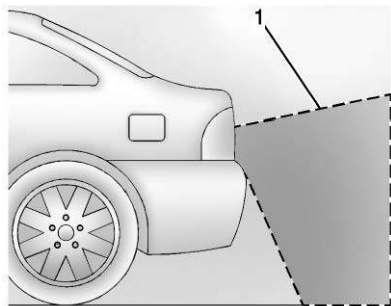

1. View Displayed by the Camera

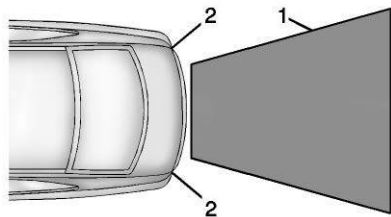

1. View Displayed by the Camera
2. Corners of the Rear Bumper

Displayed images may be farther or closer than they appear. The area displayed is limited and objects that are close to either corner of the bumper or under the bumper do not display.

A warning triangle may display to show that RPA or RCTA has detected an object. This triangle changes from amber to red and increases in size the closer the object.

### Warning

The camera(s) do not display children, pedestrians, bicyclists, crossing traffic, animals, or any other object outside of the cameras' field of view, below the bumper, or under the vehicle. Shown distances may be different from actual distances. Do not drive or park the vehicle using only these camera(s). Always check behind and around the vehicle before driving. Failure to use proper care may result in injury, death, or vehicle damage.

## Surround Vision System

If equipped, Surround Vision shows an image of the area surrounding the vehicle, along with the front or rear camera views on the infotainment display. The front camera is in

the grille or near the front emblem, the side cameras are on the bottom of the outside mirrors, and the rear camera is above the license plate.

The Surround Vision system can be accessed by selecting CAMERA in the infotainment display or when the vehicle is shifted into R (Reverse). To return to the previous screen sooner, press any button on the infotainment system, shift into P (Park), or reach a vehicle speed of approximately 12 km/h (8 mph).

### Warning

The Surround Vision cameras have blind spots and will not display all objects near the corners of the vehicle. Folding outside mirrors that are out of position may not display surround view correctly. Always check around the vehicle when parking or backing.



1. Views Displayed by the Surround Vision Cameras
2. Area Not Shown

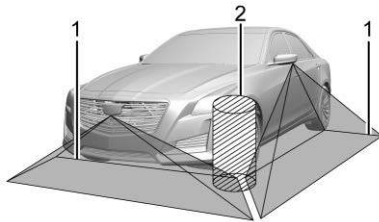

1. Views Displayed by the Surround Vision Cameras
2. Area Not Shown

## Camera Views

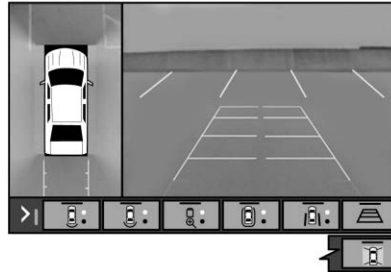

Touch the camera view buttons along the bottom of the infotainment display.

**Front/Rear Standard View:** Displays an image of the area in front or behind the vehicle. Touch Front/Rear Standard View on the infotainment display when a camera view is active. Touching the button multiple times will toggle between front and rear camera views.

If equipped, the front view camera also displays when the Park Assist system detects an object within 30 cm (12 in).

**Front/Rear Overhead View:** Displays a front or rear overhead view of the vehicle. Touching the button will toggle between the two views.

**Side Forward/Rearward View:** Displays a view that shows objects next to the front or rear sides of the vehicle. Touch Side Forward/Rearward View on the infotainment display when a camera view is active. Touching the button multiple times will toggle between forward and rearward views. Rear Pedestrian Alert, Park Assist, and RCTA are not available when Side Forward/Rearward view is active.

**Guidance Lines:** Displays available guidelines. The horizontal markings represent distance from the vehicle.

**Top Down View:** Displays an image of the area surrounding the vehicle, along with other views in the infotainment display. Top Down can be enabled or disabled by pressing the Top Down View button multiple times.

## Park Assist

The vehicle may be equipped with the Rear Park Assist (RPA) or Front and Rear Park Assist (FRPA). The Park Assist system may provide assistance to driver when backing up and parking. Park Assist uses ultrasonic sensors in the bumpers to measure the distance between the vehicle and objects. The system calculates the distance between vehicle and object via measuring the time it takes for the ultrasonic waves to bounce

back from the object. Park Assist works only at speeds up to about 11 Km/h (7 mph). An illuminated LED in the parking assist button indicates that the system is ready to operate. The sensors on the bumpers may detect objects up to 1.8 m (6 ft) behind and 1.25 m (4 ft) in front of the vehicle within a zone 25 cm (10 in) high off the ground and below bumper level. These detection distances may be shorter during warmer or humid weather. Blocked sensors will not detect objects and can also cause false detections. Keep the sensors clean of mud, dirt, snow, ice, and slush; and clean sensors after a car wash in freezing temperatures.

### Warning

The Park Assist System is no substitute for careful and attentive driving. The Park Assist system does not detect children, pedestrians, bicyclists, animals, or objects located below the bumper or that are too close or too far from the vehicle. It is not available at speeds greater than 11 km/h (7 mph). To prevent injury, death, or vehicle damage, even with Park Assist, always

(Continued)

### Warning (Continued)

check the area around the vehicle and check all mirrors before moving forward or backing.

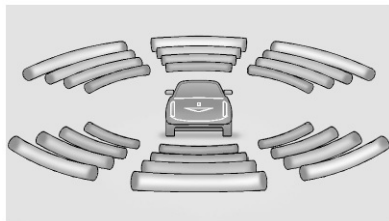

### How the System Works

The instrument cluster may have a Park Assist display with bars that show “distance to object,” driving direction, and object location information for the Park Assist system. As the object gets closer, more bars light up and the bars change color from yellow to amber to red.

Beeps sound to warn the driver of certain objects that are detected around the vehicle. The frequency of beeps increases as the vehicle gets closer to the object. When the object is very close to the vehicle, the beeps are

continuous. Beeps for the front are higher pitched than beeps for the rear. If equipped with Safety Alert seat, both sides of the seat will pulse alongside the beeps.

### When the System Does Not Seem to Work Properly

The following messages may be displayed on the DIC:

**SERVICE PARKING ASSIST:** If this message occurs, check the following conditions:

- The sensors are not clean. Keep the vehicle's rear bumper free of mud, dirt, snow, ice, and slush. For cleaning instructions, see *Exterior Care* ⇨ 354.
- The Park Assist sensors are covered by frost or ice. Frost or ice can form around and behind the sensors and may not always be seen; this can occur after washing the vehicle in cold weather. The message may not clear until the frost or ice has melted.

If the above conditions do not exist, take the vehicle to your dealer to repair the system.

**PARK ASSIST OFF:** If the PA system does not activate due to a temporary condition, the appropriate message displays on the DIC. PA OFF message is displayed when disabled

by the driver. Front/Rear PA OFF message is displayed when an attached object is detected in the front or rear respectively. PA Temporarily Unavailable message is displayed for system failures. This can occur under the following conditions:

- The driver has disabled the system.
- An object was hanging out of the trunk during the last drive cycle. Once the object is removed, RPA will return to normal operation.
- The bumper is damaged. Take the vehicle to your dealer to repair the system.
- Other conditions, such as vibrations from a jackhammer or the compression of air brakes on a very large truck, are affecting system performance.

### Turning the Feature On or Off

Touch  on the center stack to turn on or off the Front and Rear Park Assist, Reverse Automatic Braking (RAB), and the Backing Warning System at the same time. The indicator light next to the button comes on when the features are on and turns off when the features have been disabled.

Turn off Park Assist when towing a trailer.

To view available settings for this feature, touch the Settings icon on the infotainment home page. Select “Vehicle” to display the list of available options and select “Collision/Detection Systems”.

### Automatic Parking Assist (APA)

If equipped, APA searches for and steers the vehicle into parallel and perpendicular parking spots. When using APA, you must still shift gears while the system applies the brakes and accelerator. A display and audible beeps help to guide parking maneuvers.

Do not use APA when towing a trailer.

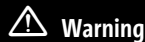

#### Warning

APA may not detect objects in the parking space, objects that are soft or narrow, objects high off the ground such as flatbed trucks, objects below ground level such as large potholes, or moving objects (e.g. pedestrians). Always verify that the parking space is appropriate for parking a vehicle. APA does not respond to changes in the parking space, such as movement

(Continued)

### Warning (Continued)

of an adjacent vehicle, or a person or object entering the parking space. APA does not detect or avoid traffic that is behind or alongside of the vehicle. Always be prepared to stop the vehicle during the parking maneuver.

Touch  on the center stack to enable the system to search for a parking space that is large enough and within 1.5 m (5 ft) of the vehicle. The vehicle speed must be below 30 km/h (18 mph). The system cannot:

- Detect whether it is a legal parking space.
- Park exactly lined up with the vehicle next to it if the spot is approached at an angle or if the parking space is angled.
- Park exactly centered in a spot that is marked too large.
- Always detect short curbs.

When enabled, APA searches for parallel parking spaces to the right of the vehicle. To search for a parking space to the left, turn on the left turn signal or, if available, change the side selection in the infotainment display. To



switch the parking mode between parallel and perpendicular, change the parking mode in the infotainment display.



After completely passing a large enough space, an audible beep occurs. A red stop symbol and a shift to reverse message are displayed.

If the vehicle is in R (Reverse), but does not steer into the expected space, this may be because the system is maneuvering the vehicle into a previously detected space. The APA system does not need service.

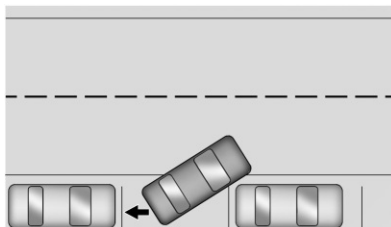

APA will instruct the vehicle to stop once a large enough space is found. Follow the displayed instructions. When instructed to drive in reverse, shift to R (Reverse) while holding the brakes. The steering wheel will vibrate briefly as a reminder to remove hands from the steering wheel. Release the brakes slowly when the vibration stops to begin automatic parking. Check surroundings and continue braking or accelerating as needed, and be prepared to stop to avoid vehicles, pedestrians, or objects. If the vehicle exceeds 10 km/h (6 mph), APA is automatically disengaged.

A progress arrow displays the status of the parking maneuver. Depending on the space size, additional maneuvers may be required, and there will be additional instructions. When changing gears, allow the automatic steering to complete before continuing the parking maneuver. APA will beep and display

a PARKING COMPLETE message. Secure the vehicle against rolling away by applying parking brake.

APA may automatically disengage if:

- The steering wheel is used by the driver.
- The maximum allowed speed is exceeded.
- The parking brake is applied or the vehicle is shifted into P (Park).
- There is a failure with the APA system.
- Electronic stability control or antilock brakes are activated.
- The driver opens the door with an unbuckled seat belt.

The brake holds the vehicle until the parking brake or brake is applied, or the vehicle is shifted into P (Park).

To cancel APA, touch  again.

### When the System Does Not Seem to Work Properly

The APA system may require a short period of driving along curves to calibrate.

## Reverse Automatic Braking (RAB)

### Backing Warning and RAB

#### Warning

The Backing Warning System only operates at speeds greater than 8 km/h (5 mph). It does not detect children, pedestrians, bicyclists, animals, or objects below the bumper or that are too close or too far from the vehicle. In some situations, such as at higher backing speeds, there may not be enough time for the short, sharp application of the vehicle brake system to occur. To prevent injury, death, or vehicle damage, even with the Backing Warning System, always check the area around the vehicle and check all mirrors before backing.

#### Warning

RAB may not avoid many types of backing crashes. Do not wait for the automatic braking to apply. This system is not

(Continued)

#### Warning (Continued)

designed to replace driver braking and only works in R (Reverse) when an object is detected directly behind the vehicle. It may not brake or stop in time to avoid a crash. It will not brake for objects when the vehicle is moving at very low speeds. It does not detect children, pedestrians, bicyclists, animals, or objects below the bumper or that are too close or too far from the vehicle. To prevent injury, death, or vehicle damage, even with RAB, always check the area around the vehicle before and while backing.

#### Warning

There may be instances where unexpected or undesired automatic braking occurs. If this happens, either press the brake pedal or firmly press the accelerator pedal to release the brakes from the RAB system. Before releasing the brakes, check the RVC and check the area around the vehicle to make sure it is safe to proceed.

If equipped and enabled, when in R (Reverse), Backing Warning alerts of rear objects at vehicle speeds greater than 8 km/h (5 mph). RAB may automatically brake hard at speeds between 1–32 km/h (0.5–20 mph).

The Backing Warning System will beep once from the rear when an object is first detected, or pulse twice on both sides of the Safety Alert Seat. When the system detects a potential crash, beeps will be heard from the rear, or five pulses will be felt on both sides of the Safety Alert Seat. There may also be a brief, sharp application of the brakes.

When the vehicle is in R (Reverse), if the system detects the vehicle is backing too fast to avoid a crash with a detected object behind your vehicle in your path, it may automatically brake hard to a stop to help avoid or reduce the harm caused by a backing crash.

To view available settings from the infotainment home screen, touch Settings > Vehicle > Collision/Detection Systems.

Pressing the brake pedal after the vehicle comes to a stop will release RAB. If the brake pedal is not pressed soon after the stop, the Electric Parking Brake (EPB) may be set. When it is safe, press the accelerator pedal firmly at any time to override RAB.

Unexpected braking events are possible with a static installed accessory, such as a bike rack or hitch-mounted cargo carrier.

## Rear Pedestrian Alert

If equipped, and under certain conditions, this feature can provide alerts for a pedestrian within the system's range directly behind the vehicle. This feature only works in R (Reverse) below 12 km/h (8 mph), and detects pedestrians up to 8 m (26 ft) away during daytime driving. During nighttime driving, feature performance is very limited.



### Rear Pedestrian Alert Indicator

When a pedestrian is detected within the system's range directly behind the vehicle, this symbol flashes amber on the infotainment display, along with five beeps from the rear, or if equipped, two pulses from both sides of the driver seat. When a pedestrian is detected close to the vehicle, the symbol flashes red on

the infotainment display, along with ten beeps from the rear, or if equipped, seven pulses from both sides of the driver seat.

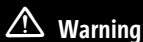

### Warning

Rear Pedestrian Alert does not automatically brake the vehicle. It also does not provide an alert unless it detects a pedestrian, and it may not detect all pedestrians if:

- The pedestrian is not directly behind the vehicle, fully visible to the Rear Vision Camera (RVC), or standing upright.
- The pedestrian is part of a group.
- The pedestrian is a child.
- Visibility is poor, including nighttime conditions, fog, rain, or snow.
- The RVC is blocked by dirt, snow, or ice.
- The RVC, taillamps, or back-up lamps are not cleaned or in proper working condition.
- The vehicle is not in R (Reverse).

(Continued)

### Warning (Continued)

To help avoid death or injury, always check for pedestrians around the vehicle before backing up. Be ready to take action and apply the brakes. See *Defensive Driving* ⇨ 174. Keep the RVC, taillamps, and back-up lamps clean and in good repair.

Rear Pedestrian Alert can be set to Off or Alert. To view available settings from the infotainment screen, touch Settings > Vehicle > Collision/Detection Systems.

If equipped, alerts can be set to beeps or seat pulses. To view available settings from the infotainment screen, touch Settings > Vehicle > Collision/Detection Systems > Alert Type.

## Rear Cross Traffic Alert (RCTA) System

If equipped, Rear Cross Traffic Alert (RCTA) displays a red warning triangle with a left or right pointing arrow on the infotainment display to warn of traffic coming from the left or right. This system detects objects coming from up to 20 m (65 ft) from the left or right side of the vehicle. When an object is detected,

either three beeps sound from the left or right or three Safety Alert Seat pulses occur on the left or right side, depending on the direction of the detected vehicle.

### Rear Cross Traffic Braking (RCTB)

If equipped, RCTB displays a red warning triangle with a left or right pointing arrow on the infotainment screen to warn of traffic coming from the left or right. The system detects objects coming from up to 20 m (65 ft) from the left or right side of the vehicle. When an object is detected, three beeps sounds from the left or right, depending on the direction of the detected vehicle. RCTB will bring the vehicle to a full stop if a collision is imminent.

### Driving With a Trailer

Use caution while backing up when towing a trailer. RCTA and RCTB are automatically disabled when a trailer is attached to the vehicle.

### Turning the Feature On or Off

To view available settings from the infotainment screen, touch Settings > Vehicle > Collision/Detection Systems.

## Assistance Systems for Driving

If equipped, when driving the vehicle in a forward gear, Forward Collision Alert (FCA), Lane Departure Warning (LDW), Lane Keep Assist (LKA), Side Blind Zone Alert (SBZA), Lane Change Alert (LCA), Automatic Emergency Braking (AEB), and/or the Front Pedestrian Braking (FPB) System can help to avoid a crash or reduce crash damage.

### Forward Collision Alert (FCA) System

The FCA system may help to avoid or reduce the harm caused by front-end crashes. When approaching a vehicle ahead too quickly, FCA provides a red flashing alert on the windshield and rapidly chimes or pulses the driver seat. FCA also lights an amber visual alert if following another vehicle much too closely.

FCA detects vehicles within a distance of approximately 60 m (197 ft) and operates at speeds above 8 km/h (5 mph). If the vehicle has Adaptive Cruise Control (ACC), it can detect vehicles to distances of approximately 110 m (360 ft) and operates at all speeds. See *Adaptive Cruise Control (Advanced)* ⇨ 225.

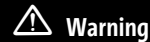

**Warning**

FCA is a warning system and does not apply the brakes. When approaching a slower-moving or stopped vehicle ahead too rapidly, or when following a vehicle too closely, FCA may not provide a warning with enough time to help avoid a crash. It also may not provide any warning at all. FCA does not warn of pedestrians, animals, signs, guardrails, bridges, construction barrels, or other objects. Be ready to take action and apply the brakes. See *Defensive Driving* ⇨ 174.

FCA can be disabled through vehicle settings. To view available settings from the infotainment home screen, touch Settings > Vehicle > Collision/Detection Systems.

### Detecting the Vehicle Ahead



FCA warnings will not occur unless the FCA system detects a vehicle ahead. When a vehicle is detected, the vehicle ahead indicator will display green. Vehicles may not be detected on curves, highway exit ramps, or hills, due to poor visibility; or if a vehicle ahead is partially blocked by pedestrians or other objects. FCA will not detect another vehicle ahead until it is completely in the driving lane.



### Warning

FCA does not provide a warning to help avoid a crash, unless it detects a vehicle. FCA may not detect a vehicle ahead if the FCA sensor is blocked by dirt, snow, or ice, or if the windshield is damaged. It may also not detect a vehicle on winding or hilly roads, or in conditions that can limit visibility such as fog, rain, or snow, or if the headlamps or windshield are not cleaned or in proper condition. Keep the windshield, headlamps, and FCA sensors clean and in good repair.

### Collision Alert

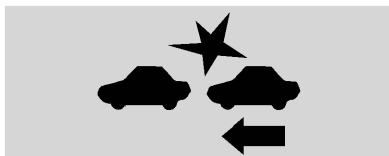

With Head-Up Display



Without Head-Up Display

When your vehicle approaches another detected vehicle too rapidly, the red FCA display will flash on the windshield. Also, eight rapid high-pitched chimes will sound from the front, or both sides of the Safety Alert Seat will pulse five times. When this Collision Alert occurs, the brake system may prepare for driver braking to occur more rapidly which can cause a brief, mild deceleration. Continue to apply the brake pedal as needed.

### Tailgating Alert



The vehicle ahead indicator will display amber when you are following a vehicle ahead much too closely.

### Selecting the Alert Timing



The Collision Alert control is on the steering wheel. Press  to set the FCA timing to Far, Medium, or Near. The first button press shows the current setting on the DIC. Additional button presses will change this setting. The chosen setting will remain until it is changed and will affect the timing of both the Collision Alert and the Tailgating Alert features. The timing of both alerts will vary based on vehicle speed. The faster the vehicle speed, the farther

away the alert will occur. Consider traffic and weather conditions when selecting the alert timing. The range of selectable alert timings may not be appropriate for all drivers and driving conditions.

If your vehicle is equipped with ACC, changing the FCA timing setting automatically changes the following gap setting (Far, Medium, or Near).

### Following Distance Indicator

If equipped, the following distance to a moving vehicle ahead in your path is indicated in following time in seconds on the Driver Information Center (DIC). See *Driver Information Center (DIC)* ⇨ 111. The minimum following time is 0.5 seconds away. If there is no vehicle detected ahead, or the vehicle ahead is out of sensor range, dashes will be displayed.

### Unnecessary Alerts

FCA may provide unnecessary alerts for turning vehicles, vehicles in other lanes, objects that are not vehicles, or shadows. These alerts are normal operation and the vehicle does not need service.

### Cleaning the System

If the FCA system does not seem to operate properly, this may correct the issue:

- Clean the outside of the windshield in front of the rearview mirror.
- Clean the entire front of the vehicle.
- Clean the headlamps.

### Automatic Emergency Braking (AEB)

The AEB system may help avoid or reduce the harm caused by front-end crashes. AEB also includes Intelligent Brake Assist (IBA). When the system detects a vehicle ahead in your path that is traveling in the same direction that you may be about to crash into, it can provide a boost to braking or automatically brake the vehicle. This can help avoid or lessen the severity of crashes when driving in a forward gear. Depending on the situation, the vehicle may automatically brake moderately or hard. Always wear a seat belt and ensure that all passengers are properly restrained. This automatic emergency braking can only occur if

a vehicle is detected. This is shown by the FCA vehicle ahead indicator being lit. See *Forward Collision Alert (FCA) System* ⇨ 259.

The system works when driving in a forward gear above 4km/h (2 mph). It can detect vehicles up to approximately 60 m (197 ft).

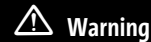

### Warning

AEB is an emergency crash preparation feature and is not designed to avoid crashes. Do not rely on AEB to brake the vehicle. AEB will not brake outside of its operating speed range and only responds to detected vehicles.

AEB may not:

- Detect a vehicle ahead on winding or hilly roads.
- Detect all vehicles, especially vehicles with a trailer, tractors, muddy vehicles, etc.
- Detect a vehicle when weather limits visibility, such as in fog, rain, or snow.
- Detect a vehicle ahead if it is partially blocked by pedestrians or other objects.

(Continued)

**Warning (Continued)**

Complete attention is always required while driving, and you should be ready to take action and apply the brakes and/or steer the vehicle to avoid crashes.

AEB may slow the vehicle to a complete stop to try to avoid a potential crash. If this happens, AEB may engage the Electric Parking Brake (EPB) to hold the vehicle at a stop. Release the EPB or firmly press the accelerator pedal.

 **Warning**

AEB may automatically brake the vehicle suddenly in situations where it is unexpected and undesired. It could respond to a turning vehicle ahead, guardrails, signs, and other non-moving objects. To override AEB, firmly press the accelerator pedal, if it is safe to do so.

**Intelligent Brake Assist (IBA)**

IBA may activate when the brake pedal is applied quickly by providing a boost to braking based on the speed of approach and distance to a vehicle ahead.

Minor brake pedal pulsations or pedal movement during this time is normal and the brake pedal should continue to be applied as needed. IBA will automatically disengage only when the brake pedal is released.

 **Warning**

IBA may increase vehicle braking in situations when it may not be necessary. You could block the flow of traffic. If this occurs, take your foot off the brake pedal and then apply the brakes as needed.

AEB and IBA can be disabled through vehicle settings. To view available settings from the infotainment home screen, touch Settings > Vehicle > Collision/Detection Systems.

A system unavailable message may display if:

- The front of the vehicle or windshield is not clean.
- Heavy rain or snow is interfering with object detection.
- There is a problem with the StabiliTrak system.

The AEB system does not need service.

**Intersection Automatic Emergency Braking (I-AEB) System**

If equipped, the I-AEB system may help avoid or reduce the harm caused by front-end crashes with crossing vehicles.

The system works when driving in a forward gear above 15 km/h (9 mph) and less than 80 km/h (50 mph). It can detect oncoming vehicles up to approximately 60 m (197 ft).

 **Warning**

I-AEB is an emergency crash preparation feature. Do not rely on I-AEB to brake or avoid crashes. I-AEB will not brake outside of its operating speed range and only responds to detected intersecting vehicles. I-AEB may not:

- detect a crossing or oncoming vehicle on winding or hilly roads.
- detect all vehicles, especially vehicles with a trailer, tractors, muddy vehicles, etc.
- detect a vehicle when weather limits visibility, such as in fog, rain, or snow.

(Continued)

### Warning (Continued)

- detect a vehicle ahead if it is partially blocked by pedestrians or other objects.

Complete attention is always required while driving, and you should be ready to take action and apply the brakes and/or steer the vehicle to avoid crashes.

### Vehicle Crossing the Path Ahead

When there is a crossing vehicle detected approaching from the right or the left side that may lead to a collision, I-AEB provides a red flashing alert on the windshield and rapidly beeps or pulses the Safety Alert Seat. See *Advanced Driver Assistance Systems* ⇨ 250. I-AEB can provide a boost to braking or automatically brake the vehicle.

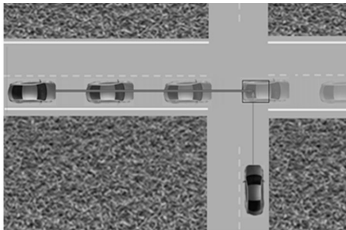

I-AEB can be set to Off, Alert, or Alert and Brake. To view available settings from the infotainment screen, touch Settings > Vehicle > Collision/Detection Systems.

### Crossing Traffic Alert

When your vehicle approaches an intersecting vehicle too rapidly and there is risk of a collision, a red warning graphic will flash on the windshield. Also, eight rapid high-pitched beeps will sound, or the driver seat will pulse five times. The side of the seat that is pulsed and the location of the beeps will depend on the direction that the intersecting vehicle is detected from. When this collision alert occurs, the brake system may prepare for driver braking to occur more rapidly which can cause a brief, mild deceleration. Continue to apply the brake pedal as needed.



With Head-Up Display

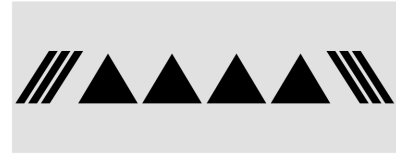

Without Head-Up Display

### Turning Across Oncoming Traffic Alert

When your vehicle approaches another detected vehicle too rapidly, a red graphic will flash on the windshield. Also, eight rapid high-pitched beeps will sound from the front, or both sides of the Safety Alert Seat will pulse five times. When this Collision Alert occurs, the brake system may prepare for driver braking to occur more rapidly which can cause a brief, mild deceleration. Continue to apply the brake pedal as needed.



With Head-Up Display



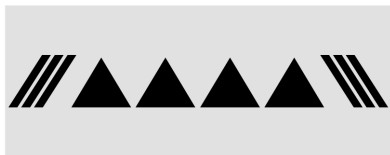

Without Head-Up Display

### Automatic Braking

If I-AEB detects it is about to crash into an intersecting vehicle, and the brakes have not been applied, I-AEB may automatically brake moderately or hard. This can help to avoid some crashes or lessen impact by reducing the speed of the vehicle. Always wear a seat belt and check that all passengers are properly restrained. I-AEB can automatically brake between 15 km/h (9 mph) and 80 km/h (50 mph). Automatic braking levels may be reduced under certain conditions, such as higher speeds.

I-AEB may slow the vehicle to a complete stop to try to avoid a potential crash. If this happens, I-AEB may engage the Electric Parking Brake (EPB) to hold the vehicle at a stop. Release the EPB or firmly press the accelerator pedal to continue driving.

I-AEB may also apply the brakes automatically when there is an intersecting vehicle at risk of collision and the system determines that the driver is not braking with sufficient force.

Minor brake pedal pulsations or pedal movement during this time is normal and the brake pedal should continue to be applied as needed.

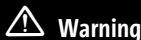

### Warning

I-AEB may automatically brake or increase vehicle braking in situations when it may not be necessary or desired. Your vehicle could block the flow of traffic. I-AEB may respond to stationary or parked vehicles, signs, and other non-moving objects. To override AEB, firmly press the accelerator pedal, if it is safe to do so.

### Cleaning the System

If I-AEB does not seem to operate properly, cleaning the outside of the windshield in front of the rearview mirror may correct the issue.

## Front Pedestrian Braking (FPB) System

If equipped, the FPB system may help avoid or reduce the harm caused by front-end crashes with nearby pedestrians when driving in a forward gear. FPB displays an amber indicator, , when a nearby pedestrian is detected ahead. When approaching a detected pedestrian too quickly, FPB provides a red flashing alert on the windshield and rapidly beeps or pulses the driver seat. FPB can provide a boost to braking or automatically brake the vehicle. This system includes Intelligent Brake Assist (IBA), and the Automatic Emergency Braking (AEB) System may also respond to pedestrians. Always wear a seat belt and ensure that all passengers are properly restrained. See *Automatic Emergency Braking (AEB)* ⇨ 261.

The FPB system can detect and alert to pedestrians in a forward gear at speeds between 8 km/h (5 mph) and 80 km/h (50 mph). During daytime driving, the system detects pedestrians up to a distance of approximately 40 m (131 ft). During nighttime driving, system performance is very limited.

 **Warning**

FPB does not provide an alert or automatically brake the vehicle, unless it detects a pedestrian. FPB may not detect pedestrians, including children:

- When the pedestrian is not directly ahead, fully visible, or standing upright, or when part of a group.
- Due to poor visibility, including nighttime conditions, fog, rain, or snow.
- If the FPB sensor is blocked by dirt, snow, or ice.
- If the headlamps or windshield are not cleaned or in proper condition.

Be ready to take action and apply the brakes. For more information, see *Defensive Driving* ⇨ 174. Keep the windshield, headlamps, and FPB sensor clean and in good repair.

FPB can be set to Off, Alert, or Alert & Brake through vehicle personalization. To view available settings for this feature, touch the Settings icon on the infotainment home

page. Select “Vehicle” to display the list of available options and select “Collision/Detection Systems”.

### Detecting the Pedestrian Ahead



FPB alerts and automatic braking will not occur unless the FPB system detects a pedestrian. When a pedestrian that may enter the vehicle’s forward path is detected, the pedestrian ahead indicator will display amber.

### Front Pedestrian Alert



### With Head-Up Display

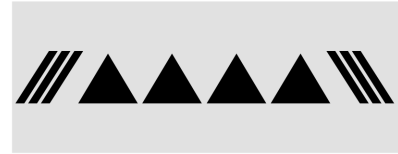

### Without Head-Up Display

When the vehicle approaches a pedestrian ahead too rapidly, the red FPB alert display will flash on the windshield. Eight rapid high-pitched beeps will sound from the front, or both sides of the Safety Alert Seat will pulse five times. When this Pedestrian Alert occurs, the brake system may prepare for driver braking to occur more rapidly which can cause a brief, mild deceleration. Continue to apply the brake pedal as needed. Cruise control may be disengaged when the Front Pedestrian Alert occurs.

### Automatic Braking

If FPB detects it is about to crash into a pedestrian directly ahead, and the brakes have not been applied, FPB may automatically brake moderately or brake hard. This can help to avoid some very low speed pedestrian crashes or reduce pedestrian injury. FPB can automatically brake to detected pedestrians

between 8 km/h (5 mph) and 80 km/h (50 mph). Automatic braking levels may be reduced under certain conditions, such as higher speeds.

FPB may slow the vehicle to a complete stop to try and avoid a potential collision with a pedestrian. If this happens, Automatic Braking may engage the Electric Parking Brake (EPB) to hold the vehicle at a stop. Release the EPB. A firm press of the accelerator pedal will also release Automatic Braking and the EPB.

### Warning

FPB may alert or automatically brake the vehicle suddenly in situations where it is unexpected and undesired. It could falsely alert or brake for objects similar in shape or size to pedestrians, including shadows. This is normal operation and the vehicle does not need service. To override Automatic Braking, firmly press the accelerator pedal, if it is safe to do so.

Automatic Braking can be disabled through vehicle personalization. To view available settings for this feature, touch the Settings

icon on the infotainment home page. Select “Vehicle” to display the list of available options and select “Collision/Detection Systems”.

### Warning

Using the Front Pedestrian Braking system while towing a trailer could cause you to lose control of the vehicle and crash. Turn the system to Alert or Off when towing a trailer.

### Cleaning the System

If FPB does not seem to operate properly, cleaning the outside of the windshield in front of the rearview mirror may correct the issue.

### Side Blind Zone Alert (SBZA)

If equipped, the SBZA system is a lane-changing aid that assists drivers with avoiding crashes that occur with moving vehicles in the side blind zone, or blind spot areas. When the vehicle is in a forward gear, the left or right side mirror display will light up if a moving vehicle is detected in that blind zone. If the turn signal is activated and a vehicle is also detected on the same side, the display will flash as an extra warning not to change lanes. Since

this system is part of the Lane Change Alert (LCA) system, read the entire LCA section before using this feature.

### Lane Change Alert (LCA)

If equipped, the LCA system is a lane-changing aid that assists drivers with avoiding lane change crashes that occur with moving vehicles in the side blind zone (or spot) areas or with vehicles rapidly approaching these areas from behind. The LCA warning display will light up in the corresponding outside mirror and will flash if the turn signal is on.

Side Blind Zone Alert (SBZA) is included as part of the LCA system.

### Warning

LCA does not alert the driver to vehicles outside of the system detection zones, pedestrians, bicyclists, or animals. It may not provide alerts when changing lanes under all driving conditions. Failure to use proper care when changing lanes may result in injury, death, or vehicle damage. Before making a lane change, always check mirrors, glance over your shoulder, and use the turn signals.

### LCA Detection Zones

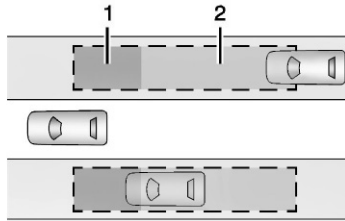

1. SBZA Detection Zone
2. LCA Detection Zone

The LCA sensor covers a zone of approximately one lane over from both sides of the vehicle, or 3.5 m (11 ft). The height of the zone is approximately between 0.5 m (1.5 ft) and 2 m (6 ft) off the ground. The Side Blind Zone Alert (SBZA) warning area starts at approximately the middle of the vehicle and goes back 5 m (16 ft). Drivers are also warned of vehicles rapidly approaching from up to 70 m (230 ft) behind the vehicle.

### How the System Works

The LCA symbol lights up in the side mirrors when the system detects a moving vehicle in the next lane over that is in the side blind zone or rapidly approaching that zone from behind.

A lit LCA symbol indicates it may be unsafe to change lanes. Before making a lane change, check the LCA display, check mirrors, glance over your shoulder, and use the turn signals.



**Left Side Mirror Display**

**Right Side Mirror Display**

When the vehicle is started, both outside mirror LCA displays will briefly come on to indicate the system is operating. When the vehicle is in a forward gear, the left or right side mirror display will light up if a moving vehicle is detected in the next lane over in that blind zone or rapidly approaching that zone. If the turn signal is activated in the same direction as a detected vehicle, this display will flash as an extra warning not to change lanes.

LCA can be disabled through vehicle personalization. To view available settings from the infotainment screen, touch Settings

> Vehicle > Collision/Detection Systems. If LCA is disabled by the driver, the LCA mirror displays will not light up.

### When the System Does Not Seem to Work Properly

The LCA system requires some driving for the system to calibrate to maximum performance. This calibration may occur more quickly if the vehicle is driven on a straight highway road with traffic and roadside objects (e.g., guardrails, barriers). During a trip, the LCA system is not operational until the vehicle first reaches a speed of 24 km/h (15 mph).

LCA displays may not come on when passing a vehicle quickly or for a stopped vehicle. LCA may alert to objects attached to the vehicle, such as a bicycle, or object extending out to either side of the vehicle. Attached objects may also interfere with the detection of vehicles. This is normal system operation; the vehicle does not need service.

LCA may not always alert the driver to vehicles in the next lane over, especially in wet conditions or when driving on sharp curves. The system does not need to be serviced. The system may light up due to guardrails, signs,

trees, shrubs, and other non-moving objects. This is normal system operation; the vehicle does not need service.

LCA may not operate when the LCA sensors in the left or right corners of the rear bumper are covered with mud, dirt, snow, ice, or slush, or in heavy rainstorms. For cleaning instructions, see "Washing the Vehicle" under *Exterior Care* ⇨ 354. If the Driver Information Center (DIC) still displays the system unavailable message after cleaning both sides of the vehicle toward the rear corners of the vehicle, see your dealer.

If the LCA displays do not light up when moving vehicles are in the side blind zone or rapidly approaching this zone and the system is clean, the system may need service. Take the vehicle to your dealer.

### Driving with a Trailer

If equipped with Lane Change Alert (LCA), the LCA detection zones that extend back from the side of the vehicle do not move further back when a trailer is towed.

Use caution while changing lanes when towing a trailer.

### Side Bicycle Detection

If equipped, the system may detect a bicyclist approaching from the side or rear of the vehicle.

If this occurs, a chime will sound in the direction of the detection, and the Safety Alert Seat will pulse if enabled through vehicle settings. To view available settings from the infotainment screen, touch Settings > Vehicle > Collision/Detection Systems.

Bicyclist Detection is available when the vehicle is in D (Drive), P (Park), and for a short time after the vehicle is turned off.

If the vehicle detects a bicyclist when it is off, a DIC message may display and alert to the direction of the detection. In some cases, an Unavailable message may display. This is normal and does not mean that the system is broken.

### Detection Zones

When the vehicle is in P (Park) or is turned off, a bicyclist can be detected 11 m (36 ft) behind the vehicle or 10 m (33 ft) to the side of the vehicle.

When the vehicle is in D (Drive), a bicyclist can be detected 3 m (10 ft) behind the vehicle or to the side of the vehicle.

### Turning the Feature On or Off



Bicyclist Detection can be turned on or off through vehicle settings. To view available settings from the infotainment screen, touch Settings > Vehicle > Collision/Detection Systems.

### Blind Zone Steering Assist (BZSA)

If equipped, the Blind Zone Steering Assist (BZSA) system can detect a potential crash with a moving vehicle in the lane you are entering. It provides a brief, urgent turn of the steering wheel to alert you to take action to avoid a collision.

BZSA works with Lane Keep Assist (LKA) and Lane Change Alert (LCA). BZSA operates when the vehicle is in a forward gear, and only when LKA and LCA are enabled and able to assist. See *Lane Keep Assist (LKA)* ⇨ 272. See *Lane Change Alert (LCA)* ⇨ 266.

BZSA will provide a steering correction when your vehicle is about to leave the current lane of travel, with the possibility of a collision with a vehicle in the adjacent lane. Unlike LKA, the steering correction with BZSA will happen even if your turn signal is on in the direction of lane departure.

In addition to the BZSA steering intervention, the  will turn amber, six beeps or six seat pulses will occur, if equipped with Safety Alert Seat, and  or  will flash on the outside rear view mirror.

### Warning

Do not rely on Blind Zone Steering Assist (BZSA) to prevent crashes. This system does not replace the need to pay attention and drive safely. Failure to use proper care when driving may result in vehicle damage, injury, or death.

- BZSA performance may be affected by weather and road conditions.
- BZSA does not provide steering assistance to avoid a vehicle that is in, or has entered, your lane of travel.
- BZSA will not prevent a towed trailer from crossing into the adjacent lane. Always monitor the trailer position while towing to ensure it is in the same lane as your vehicle. BZSA is only designed to detect when your vehicle unintentionally crosses detected lane lines.

## Traffic Sign Assistant

If equipped, Traffic Sign Assistant recognizes designated traffic signs via the front camera located behind the windshield in front of the interior rear view mirror, and displays the detected speed limit in the Driver Information Center (DIC) or instrument cluster. Traffic Sign Assistant requires an active OnStar subscription. Additionally, speed limit information from the navigation system map database may be used.

### Caution

The system is intended to assist the driver within a defined speed range to discern certain traffic signs. Always pay attention to posted speed limit signs.

Do not ignore traffic signs which are not displayed by the system.

The system does not discern any signs other than the conventional traffic signs that might give or end a speed limit. It may not detect some electronic speed signs.

(Continued)

### Caution (Continued)

Depending on the weather conditions or problems with traffic signs, a traffic sign may not be recognized or a sign different from the actual traffic sign may be displayed.

Do not let this special feature tempt you into taking risks when driving.

Always adapt vehicle speed to the road conditions.

Advanced driver assistance systems do not relieve the driver from full responsibility for vehicle operation.

Traffic signs that are detected are:

- Speed Limit
- Constraint Signs

### Display Indication

The current valid speed limit is permanently displayed in the DIC or instrument cluster, depending on the vehicle.

A (--) symbol in a frame indicates there is a sign detected which cannot be clearly identified by the system.

A (I) symbol in a frame indicates that the feature is turned off or has failed.

See *Instrument Cluster* ↪ 92.

### Alert Function

If equipped, a chime may sound when you have exceeded the indicated speed limit, or if a new speed limit is detected.

The alert function can be turned on or off. To view available settings from the infotainment screen, touch Settings > Display > Instrument Cluster.

Each time the vehicle is started, the customization options will be turned on.

### System Reset

The content of the traffic sign display can be cleared. To view available settings from the infotainment screen, touch Settings > Display > Instrument Cluster.

Upon successful reset, a (–) symbol displays until the next traffic sign is detected or provided by the navigation system map data. In some cases, traffic sign memory is cleared automatically by the system.

Alert function will automatically be turned on when the system is reset.

### Navigation System Traffic Sign Detection

The currently displayed sign can either originate from sign detection using the camera, or from the navigation system map data. If the currently displayed sign originates from map data and the map information changes, a new sign will be displayed. This may lead to detection of a new sign although no sign on the road may have been passed. If the map data is unavailable, Traffic Sign Assistant will turn off automatically.

### Limitations

Traffic sign memory may not operate correctly if:

- The area of the windshield, where the front camera is located, is not clean or is affected by foreign objects, e.g. stickers, window tinting, etc.
- Traffic signs are completely or partially covered, are too low or high or difficult to discern.
- Traffic signs are incorrectly mounted or are damaged.
- Traffic signs do not comply with the approved traffic sign standards.

- The speed limit is displayed by certain types of electronic speed signs.
- There are adverse environmental conditions, e.g. heavy rain, snow, direct sunlight or shadows.
- The headlights are dirty or not correctly aligned when driving at night.
- The navigation map data is out of date.
- The navigation map is unavailable.

### Driver Attention Assist

If equipped, Driver Attention Assist alerts the driver to pay closer attention to the road ahead. Driver Attention Assist uses a camera-based Driver Monitoring System. The Driver Monitoring System on the steering column continually monitors the driver's head movements and eye gaze location to determine if the driver is drowsy or fatigued. Depending on the level of the driver's distraction or drowsiness, Driver Attention Assist will provide visual warnings, chimes, and, if equipped, haptic movements to gently guide the driver to look back at the road.

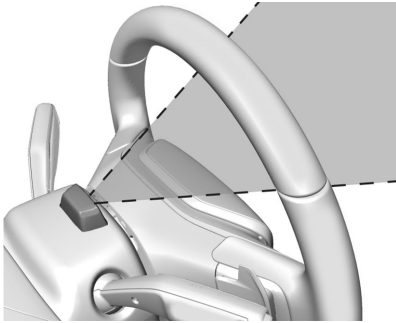

Sunglasses, hats, or other types of clothing that change the shape of the head may interfere with camera performance. To improve camera performance, raise or lower the steering wheel, or change the seat position.

Driver Attention Assist does not record video or audio. It is only active while driving with the feature enabled.

### How to Activate Driver Attention Assist

Driver Attention Assist turns on automatically every time the vehicle is started. The feature can be enabled or disabled through vehicle settings. To view available

settings from the infotainment screen, touch Settings > Vehicle > Driver Attention Assist > Drowsiness Detection.

### Drowsiness Alerts

Depending on the drowsiness level, Driver Attention Assist will display escalating alerts in the instrument cluster. These alerts progress as the drowsiness level increases. Each level is designated by a coffee cup and a Driver Information Center (DIC) message recommending that the driver consider taking a rest break. Depending on the driver's drowsiness level, the system will also send chimes or haptic alerts, if equipped with Safety Alert Seat. The higher alerts will be seen more frequently. Not all alerts may occur during a drowsy event.

When the maximum drowsiness alert occurs, the driver will be presented with the following options on the infotainment screen:

- Phone a Friend
- Place an OnStar call
- Navigate to Nearest Point of Interest (POI)

Select an option from the list and follow the instructions displayed on infotainment screen.

### Cleaning the Camera

The camera lens cover on the steering column may become dirty over time. If this occurs, clean the lens cover with a soft cloth sprayed with glass cleaner. Wipe the lens gently, then dry it. Never use abrasive cloths, cleaners, or corrosive chemicals of any kind on the lens cover.

### Limitations

Some factors can impact the performance of the Driver Attention Assist feature, causing it to not to function as intended. These include (but are not limited to):

- Damage to the Driver Monitoring System, camera, or lens.
- The camera being blocked by the steering wheel, hands, or objects.

If there is a problem with the system, a DIC message or icon in the instrument cluster may display.



## Lane Keep Assist (LKA)

 **Warning**

The LKA system does not continuously steer the vehicle. It may not keep the vehicle in the lane or give a Lane Departure Warning (LDW) alert, even if a lane marking is detected.

The LKA and LDW systems may not:

- Provide an alert or enough steering assist to avoid a lane departure or crash.
- Detect lane markings under poor weather or visibility conditions. This can occur if the windshield or headlamps are blocked by dirt, snow, or ice; if they are not in proper condition; or if the sun shines directly into the camera.
- Detect road edges.
- Detect lanes on winding or hilly roads.

If LKA only detects lane markings on one side of the road, it will only assist or provide an LDW alert when approaching the lane on the side where it has detected a lane

(Continued)

**Warning (Continued)**

marking. Even with LKA and LDW, you must steer the vehicle. Always keep your attention on the road and maintain proper vehicle position within the lane, or vehicle damage, injury, or death could occur. Always keep the windshield, headlamps, and camera sensors clean and in good repair. Do not use LKA in bad weather conditions or on roads with unclear lane markings, such as construction zones.

 **Warning**

Using LKA on slippery roads could cause loss of control of the vehicle and a crash. Turn the system off.

 **Warning**

LKA will not alert the driver if a towed trailer crosses into an adjacent lane of travel. Serious injury or property damage may occur if the trailer moves into another lane.

(Continued)

**Warning (Continued)**

Always monitor the trailer position while towing to make sure it is within the same lane as the tow vehicle.



If equipped, LKA may help avoid crashes due to unintentional lane departures. This system uses a camera to detect lane markings. The LKA system can be ready to assist above approximately 50 km/h (31 mph). LKA may assist by gently turning the steering wheel if the vehicle approaches a detected lane marking. It may also provide a Lane Departure Warning (LDW) alert if the vehicle unintentionally crosses a detected lane marking. LKA will not assist or alert if the turn signal is active in the direction of the lane departure, or if it detects that you are accelerating, braking, or actively steering. LKA can be overridden by turning the steering wheel. If the system detects you are steering intentionally across a lane marker, the LDW may not be given. Do not expect the LDW to occur when you are intentionally crossing a lane marker.

## How the System Works

LKA uses a camera sensor installed on the windshield ahead of the rearview mirror to detect lane markings. It may provide brief steering assist if it detects an unintended lane departure. It may further provide an audible alert or the driver seat may pulse indicating that a lane marking has been crossed. The system does not provide a Lane Departure Warning (LDW) when intentionally steering across a lane marker.

To turn LKA on and off, press  on the center stack. If equipped, the indicator light on the button comes on when LKA is on and turns off when LKA is disabled. In some vehicles, a long press of over three seconds is required to turn LKA off.

LKA may not be available in extremely cold temperatures of less than approximately  $-30^{\circ}\text{f}$  ( $-34^{\circ}\text{c}$ ).

When on,  is white, if equipped, indicating that the system is not ready to assist.  is green if LKA is ready to assist. LKA may assist by gently turning the steering wheel if the vehicle approaches a detected lane marking.  is amber when assisting. It may also provide a Lane Departure Warning (LDW)

alert by flashing  amber if the vehicle crosses a detected lane marking. Additionally, there may be three beeps, or the driver seat may pulse three times, on the right or left, depending on the lane departure direction.

## Take Steering

The LKA system does not continuously steer the vehicle. If LKA does not detect active driver steering, an alert and chime may be provided. Steer the vehicle to dismiss. LKA may become temporarily unavailable after repeated take steering alerts.

## When the System Does Not Seem to Work Properly

The system performance may be affected by:

- Close vehicles ahead.
- Sudden lighting changes, such as when driving through tunnels.
- Banked roads.
- Roads with poor lane markings, such as two-lane roads.

If the LKA system is not functioning properly when lane markings are clearly visible, cleaning the windshield may help.

A camera blocked message may display if the camera is blocked. Some driver assistance systems may have reduced performance or not work at all. An LKA or LDW unavailable message may display if the systems are temporarily unavailable. This message could be due to a blocked camera. The LKA system does not need service. Clean the outside of the windshield behind the rearview mirror.

LKA assistance and/or LDW alerts may occur due to tar marks, shadows, cracks in the road, temporary or construction lane markings, or other road imperfections. This is normal system operation; the vehicle does not need service. Turn LKA off if these conditions continue.

## Surround Vision Recorder

If equipped, this system records the  $360^{\circ}$  camera views to an SD card. Only images are recorded, no sound. An SD card will be needed for this system. The minimum recommended SD card specifications are at least 32GB, with a FAT32 file system, and a video class of V30 or greater.

Continuous use of the Surround Vision Recorder will degrade the performance of the SD card and will require replacement of the SD card over time.

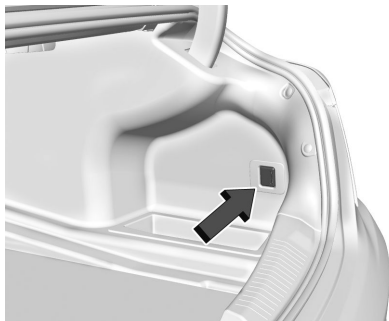

Insert an SD card into the card reader in the trunk. Disable the system from the playback screen before removing the SD card from the reader. Do not remove the card while recording is enabled. This could corrupt the video file and/or the SD card.

Other files should not be stored on the same SD card as the surround vision recorder files. Storing other files on the same card may increase recording start up and playback time or result in a loss of data.

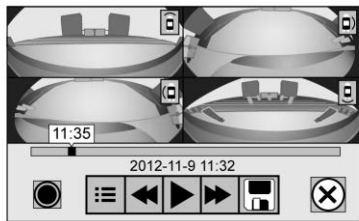

**To Activate:** Touch Video Recorder on the Home Page. Touch the red dot. The red dot will illuminate when the video recorder is on. It will remain on until it has been turned off. Recording will start after exiting the playback screen. Advise other drivers and occupants of the vehicle that video images are being recorded.

**To Deactivate:** Touch Video Recorder on the Home Page. Touch the red dot. Select from the following when the vehicle is in P (Park).

**Exit:** Touch X to exit this application and return to the previous app.

**Video List:** Touch to display a list of the most recent and saved videos. Touch the delete button next to the name to delete a saved video.

**Rewind:** Touch to rewind the video. Touch again to increase speed. Continue touching to stop rewinding.

**Play/Pause:** Touch to play or pause a recorded video.

**Fast Forward:** Touch to fast forward the video. Touch again to increase speed. Continue touching to stop fast forward.

**Save:** Touch to save a video. This protects the video from being erased. Once the SD card is full, the oldest files will be overwritten unless they have been saved.

**Camera Views:** When opening the Video Recorder, the previous file will show all camera views and can be played. Icons in the upper right corner of each view indicate which camera. Touch one of the views to zoom to only that camera view. Touch again to return to all camera views. Press X at any time to exit the video recorder app.

The latest recorded video file can be played. In addition:

- The recorded video is stored in five-minute-long files.
- All files can be viewed on the playback app or when the SD card is read by a personal computer (PC).

- Once the SD card is full, the oldest files will be overwritten. Saved files will not be overwritten.

**To Delete Data:** Remove the SD card from the vehicle and insert into a PC to manually delete the file.

Video player unavailable can occur if:

- No SD card is present.
- An empty SD card is present.
- The video files are the wrong format.
- The video files are corrupt.
- The SD card is full.
- There is a system error.

Other files should not be stored on the same SD card as the surround vision recorder files. Storing other files on the same card may increase recording start up and playback time or result in a loss of data. An error message may be displayed if no surround vision recorded video file is available for playback.

## Fuel Top Tier Fuel

GM recommends the use of TOP TIER Detergent Gasoline to keep the engine clean, reduce engine deposits, and maintain optimal vehicle performance. Look for the TOP TIER Logo or see [www.toptiergas.com](http://www.toptiergas.com) for a list of TOP TIER Detergent Gasoline marketers and applicable countries.



## Recommended Fuel (LSY 2.0L I4 Engine)



Premium unleaded gasoline meeting ASTM specification D4814 with a posted octane rating (R+M)/2 of 91 or greater is recommended. If unavailable, unleaded gasoline with a posted octane rating of 87 may be used, but will result in reduced performance and driveability. If heavy knocking is heard when using gasoline rated at 91 or greater, the engine needs service.

Do not use any fuel labeled E85 or FlexFuel. Do not use gasoline with ethanol levels greater than 15% by volume.

## Recommended Fuel (LGY 3.0L V6 and LT4 6.2L V8 Engines)



Premium unleaded gasoline meeting ASTM specification D4814 with a posted octane rating  $(R+M)/2$  of 91 or greater is required. The use of the correct fuel is an important part of the proper maintenance of the vehicle and a condition of the vehicle warranty. If heavy knocking is heard when using gasoline rated at 91 or greater, the engine needs service.

Do not use any fuel labeled E85 or FlexFuel. Do not use gasoline with ethanol levels greater than 15% by volume.

## Prohibited Fuels

### Caution

Do not use fuels with any of the following conditions; doing so may damage the vehicle and void its warranty:

- For vehicles that are not FlexFuel, fuel labeled greater than 15% ethanol by volume, such as mid-level ethanol blends (16–50% ethanol), E85, or FlexFuel.
- Fuel with any amount of methanol, methylal, ferrocene, and aniline. These fuels can corrode metal fuel system parts or damage plastic and rubber parts.
- Fuel containing metals such as methylcyclopentadienyl manganese tricarbonyl (MMT), which can damage the emissions control system and spark plugs.

(Continued)

### Caution (Continued)

- Fuel with a posted octane rating of less than the recommended fuel. Using this fuel will lower fuel economy and performance, and may decrease the life of the emissions catalyst.

## Fuels in Foreign Countries

The U.S., Canada, and Mexico post fuel octane ratings in anti-knock index (AKI). For fuel not to use in a foreign country, see *Prohibited Fuels* ⇨ 276.

## Fuel Additives

TOP TIER Detergent Gasoline is highly recommended for use with your vehicle. If your country does not have TOP TIER Detergent Gasoline, add ACDelco Fuel System Treatment Plus – Gasoline to the vehicle's gasoline fuel tank at every oil change or 15 000 km (9,000 mi), whichever occurs first. TOP TIER Detergent Gasoline and ACDelco Fuel System Treatment Plus – Gasoline will help keep your vehicle's engine fuel deposit free and performing optimally.

## Filling the Tank

An arrow on the fuel gauge indicates which side of the vehicle the fuel door is on. See *Fuel Gauge* ⇨ 95.

### Warning

Fuel vapors and fuel fires burn violently and can cause injury or death.

Follow these guidelines to help avoid injuries to you and others:

- Read and follow all the instructions on the fuel pump island.
- Turn off the engine when refueling.
- Keep sparks, flames, and smoking materials away from fuel.
- Do not leave the fuel pump unattended.
- Avoid using electronic devices while refueling.
- Do not re-enter the vehicle while pumping fuel.
- Keep children away from the fuel pump and never let children pump fuel.

(Continued)

### Warning (Continued)

- Before touching the fill nozzle, touch a metallic object to discharge static electricity from your body.
- Fuel can spray out if the fill nozzle is inserted too quickly. This spray can happen if the tank is nearly full, and is more likely in hot weather. Insert the fill nozzle slowly and wait for any hiss noise to stop before beginning to flow fuel.

If equipped, the fuel door unlocks when the vehicle doors are unlocked. See *Remote Key Operation* ⇨ 7.

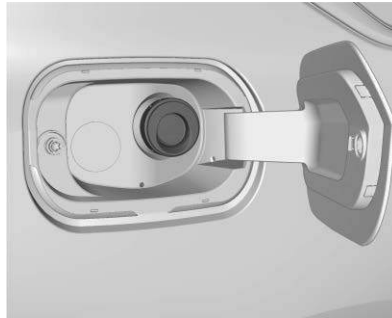

To open the fuel door, push and release the rearward center edge of the door.

The capless refueling system does not have a fuel cap. Fully insert and latch the fill nozzle, begin fueling.

### Warning

Overfilling the fuel tank by more than three clicks of a standard fill nozzle may cause:

- Vehicle performance issues, including engine stalling and damage to the fuel system.
- Fuel spills.
- Under certain conditions, fuel fires.

Be careful not to spill fuel. Wait five seconds after you have finished pumping before removing the fill nozzle. Clean fuel from painted surfaces as soon as possible. See *Exterior Care* ⇨ 354. Push the fuel door closed until it latches.

### Warning

If a fire starts while you are refueling, do not remove the fill nozzle. Shut off the flow of fuel by shutting off the pump or by notifying the station attendant. Leave the area immediately.

#### Filling the Tank with a Portable Fuel Container

If the vehicle runs out of fuel and must be filled from a portable fuel container:

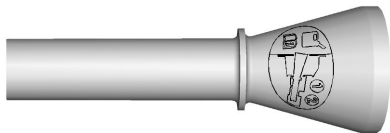

1. Locate the capless funnel adapter.
2. Insert and latch the funnel into the capless fuel system.

### Warning

Attempting to refuel from a portable fuel container without using the funnel adapter may cause fuel spillage and damage the capless fuel system. This could cause a fire. You or others could be badly burned and the vehicle could be damaged.

3. Remove and clean the funnel adapter and return it to the storage location.

#### Filling a Portable Fuel Container

### Warning

Never fill a portable fuel container while it is in the vehicle. Static electricity discharge from the container can ignite the fuel vapor. You or others could be badly burned and the vehicle could be damaged. To help avoid injury to you and others:

- Dispense fuel only into approved containers.

(Continued)

### Warning (Continued)

- Do not fill a container while it is inside a vehicle, in a vehicle's trunk, in a pickup bed, or on any surface other than the ground.
- Bring the fill nozzle in contact with the inside of the fill opening before operating the nozzle. Maintain contact until filling is complete.
- Keep sparks, flames, and smoking materials away from fuel.
- Avoid using electronic devices while pumping fuel.

## Trailer Towing

### General Towing Information

Only use towing equipment that has been designed for the vehicle. Contact your dealer or trailering dealer for assistance with preparing the vehicle to tow a trailer. Read the entire section before towing a trailer. To tow a disabled vehicle, see *Transporting a Disabled*

Vehicle ⇨ 352. To tow the vehicle behind another vehicle such as a motor home, see *Recreational Vehicle Towing* ⇨ 354.

When towing with the 2.0L L4 engine, only use unleaded gasoline with an octane rating of 89 or higher. Using gasoline with a lower octane rating while towing may damage the engine and may not be covered by the vehicle warranty. See *Recommended Fuel (LSY 2.0L L4 Engine)* ⇨ 275 *Recommended Fuel (LGY 3.0L V6 and LT4 6.2L V8 Engines)* ⇨ 276.

## Driving Characteristics and Towing Tips

### Warning

You can lose control when towing a trailer if the correct equipment is not used or the vehicle is not driven properly. For example, if the trailer is too heavy or the trailer brakes are inadequate for the load, the vehicle may not stop as expected. You and others could be seriously injured. The vehicle may also be damaged, and the repairs would

(Continued)

### Warning (Continued)

not be covered by the vehicle warranty. Pull a trailer only if all the steps in this section have been followed. Ask your dealer for advice and information about towing a trailer with the vehicle.

### Driving with a Trailer

Trailer is different than just driving the vehicle by itself. Trailering affects vehicle handling, acceleration, braking, and durability. Successful and safe trailering requires proper use of the correct equipment.

The following information has many time-tested, important trailering tips and safety rules. Many of these are important for your safety and that of your passengers. Read this section carefully before towing a trailer.

When towing a trailer:

- Follow all state and local laws that apply to trailer towing. These requirements vary from state to state.

- Install extended side view mirrors on your vehicle if your visibility is limited or restricted while towing. State laws may require the use of extended side view mirrors.
- Do not tow a trailer during the first 800 km (500 mi) of vehicle use to prevent damage to the vehicle.
- Perform the first oil change before heavy towing.
- Do not drive over 80 km/h (50 mph) and do not make starts at full throttle during the first 800 km (500 mi) of trailer towing.
- Tow in D (Drive). If the transmission downshifts too often, a lower gear may be selected using Manual Mode. See *Manual Mode* ⇨ 203.

The following advanced driver assistance features should be turned off when towing a trailer, or may turn off automatically when a trailer is detected:

- Park Assist
- Automatic Parking Assist (APA)
- Reverse Automatic Braking (RAB)
- Rear Cross Traffic Alert (RCTA)



- Rear Cross Traffic Braking (RCTB)
- Lane Change Alert (LCA)
- Super Cruise and Adaptive Cruise Control (ACC), unless equipped with trailering functionality, see *Adaptive Cruise Control (Advanced)* ⇨ 225.

Automatic Emergency Braking (AEB), and Front Pedestrian Braking (FPB) should be set to Alert unless equipped with Super Cruise.

### **Warning**

To prevent serious injury or death from carbon monoxide (CO), when towing a trailer:

- Do not drive with the liftgate, trunk/hatch, or rear-most window open.
- Fully open the air outlets on or under the instrument panel.
- Adjust the climate control system to a setting that brings in only outside air. See “Climate Control Systems” in the Index.

For more information about carbon monoxide, see *Engine Exhaust* ⇨ 199.

Towing a trailer requires experience. The combination of the vehicle and trailer is longer and not as responsive as the vehicle itself. Become familiar with handling and braking by driving on a level road surface before driving on public roads.

The trailer structure, the tires, and the brakes must all be rated to carry the intended cargo. Inadequate trailer equipment can cause the combination to operate in an unexpected or unsafe manner. Before driving, inspect all trailer hitch parts and attachments, safety chains, electrical connectors, lamps, tires, and mirrors. See *Towing Equipment* ⇨ 284. If the trailer has electric brakes, start the combination moving and then manually apply the trailer brake controller to check the trailer brakes work. During the trip, occasionally check that the cargo and trailer are secure and that the lamps and any trailer brakes are working.

### **Towing with a Stability Control System**

When towing, the stability control system might be heard. The system reacts to vehicle movement caused by the trailer, which mainly occurs during cornering. This is normal when towing heavier trailers.

### **Following Distance**

Stay at least twice as far behind the vehicle ahead as you would when driving without a trailer to help to avoid heavy braking and sudden turns.

### **Passing**

More passing distance is needed when towing a trailer. The combination of the vehicle and trailer will not accelerate as quickly and is much longer than the vehicle alone. It is necessary to go much farther beyond the passed vehicle before returning to the lane. Pass on level roadways. Avoid passing on hills if possible.

### **Backing Up**

Hold the bottom of the steering wheel with one hand. To move the trailer to the left, move that hand to the left. To move the trailer to the right, move that hand to the right. Always back up slowly and, if possible, have someone guide you.

## Making Turns

### Caution

Turn more slowly and make wider arcs when towing a trailer to prevent damage to your vehicle. Making very sharp turns could cause the trailer to contact the vehicle.

Make wide turns when towing to prevent the trailer from crossing over soft shoulders or curbs, or striking road signs, trees, or other objects. Always signal turns well in advance. Do not steer or brake suddenly.

## Driving on Grades

Reduce speed and shift to a lower gear before descending a long or steep downhill grade. If the transmission is not downshifted, the brakes may overheat, resulting in reduced braking efficiency.

Tow in D (Drive). If the transmission shifts too often under heavy loads and/or hilly conditions, consider shifting the transmission to a lower gear, or if equipped, use Tow/Haul Mode.

Coolant boils at a lower temperature at higher altitudes than at lower altitudes. If the vehicle is turned off immediately after towing at high altitude on steep uphill grades, the vehicle may show signs of overheating. To avoid this, let the vehicle run, preferably on level ground, with the transmission in P (Park) for a few minutes before turning the vehicle off.

## Viewing Systems

If equipped, the viewing systems on the vehicle can improve visibility while hitching, backing up, and driving with a trailer. See *Advanced Driver Assistance Systems* ⇨ 250.

## Parking on Hills

### Warning

To prevent serious injury or death, always park your vehicle and trailer on a level surface when possible.

When parking your vehicle and your trailer on a hill:

1. Press the brake pedal, but do not shift into P (Park) yet. Turn the wheels into the curb if facing downhill or into traffic if facing uphill.
2. Have someone place chocks under the trailer wheels.
3. When the wheel chocks are in place, gradually release the brake pedal to allow the chocks to support the load of the trailer.
4. Reapply the brake pedal. Then apply the parking brake and shift into P (Park).
5. Release the brake pedal.

## Leaving After Parking on a Hill

1. Apply and hold the brake pedal.
  - Start the engine.
  - Shift into the desired gear.
  - Release the parking brake.
2. Let up on the brake pedal.
3. Drive slowly until the trailer is clear of the chocks.

4. Stop and have someone pick up and store the chocks.

### Maintenance when Trailer Towing

A vehicle used to tow trailers requires service more often. See *Maintenance Schedule* ⇨ 365. It is especially important to check the automatic transmission fluid, engine oil, axle lubricant, belts, cooling system, and brake system before and during each trip.

Check periodically that all nuts and bolts on the trailer hitch are tight.

### Engine Cooling when Trailer Towing

The cooling system may temporarily overheat during severe operating conditions. See *Engine Overheating* ⇨ 306.

## Trailer Towing (LSY 2.0L I4 and LGY 3.0L V6 Engines Only)

### Caution

Towing a trailer improperly can damage the vehicle and result in costly repairs not covered by the vehicle warranty. To tow a trailer correctly, follow the directions in this section and see your dealer for important information about towing a trailer with the vehicle.

Never tow a trailer with a V-Series or V-Series Blackwing. These models are not designed or intended to tow a trailer.

### Trailer Weight

#### Warning

Never exceed the towing capacity for your vehicle.

Safe trailering requires monitoring the weight, speed, altitude, road grades, outside temperature, dimensions of the front of the trailer, and how frequently the vehicle is used to tow a trailer.

Before towing a trailer, always separately weigh:

- the total weight on the vehicle's tires
- the trailer
- the trailer tongue

### Trailer Weight Ratings

When towing a trailer, the combined weight of the vehicle, vehicle contents, trailer, and trailer contents must be below all of the maximum weight ratings for the vehicle, including:

- Gross Combined Weight Rating (GCWR)
- Gross Vehicle Weight Rating (GVWR)
- Maximum Trailer Weight Rating
- Gross Axle Weight Rating-Rear (GAWR-RR)
- Maximum Trailer Tongue Weight Rating

See “Weight-Distributing Hitch and Adjustment” under *Towing Equipment* ⇨ 284 to determine if equalizer bars are required to obtain the maximum trailer weight rating.

See “Trailer Brakes” under *Towing Equipment* ⇨ 284 to determine if brakes are required based on the trailer weight.

The only way to be sure the weight ratings are not exceeded is to verify with a scale.

### Warning

You and others could be seriously injured or killed if the trailer is too heavy or the trailer brakes are inadequate for the load. The vehicle may be damaged, and the repairs would not be covered by the vehicle warranty.

Only tow a trailer if all the steps in this section have been followed. Ask your dealer for advice and information about towing a trailer.

### Gross Vehicle Weight Rating (GVWR)

For information about the vehicle's maximum load capacity, see *Vehicle Load Limits* ⇨ 187. When calculating the GVWR with a trailer attached, the trailer tongue weight must be included as part of the weight the vehicle is carrying.

### Maximum Trailer Weight

The maximum trailer weight rating is calculated using the process defined by SAE J2807 and based on the vehicle model and powertrain. This process assumes the tow vehicle has a driver, a front seat passenger, and all required trailering equipment. The maximum trailer weight rating represents the heaviest trailer the vehicle can tow, but it may be necessary to reduce the trailer weight to stay within the GCWR, GVWR, maximum trailer tongue load, or GAWR-RR. This is especially true for heavier vehicles with high option content.

### Trailer Load Balance

The correct trailer load balance must be maintained to ensure trailer stability. Incorrect load balance is a leading cause of trailer sway.

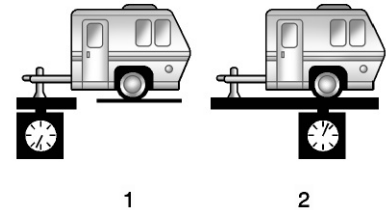

After loading the trailer, separately weigh the trailer and trailer tongue. Calculate the trailer load balance percentage to see if the weights and distribution are appropriate for your vehicle. If the trailer weight is too high, it may be possible to transfer some of the cargo into your vehicle. If the trailer tongue weight is too high or too low, it may be possible to rearrange some of the cargo inside of the trailer.

Do not exceed the maximum allowable tongue weight for your vehicle. Use the shortest hitch extension available to position the hitch ball closer to your vehicle. This will help reduce the effect of the trailer tongue weight on the trailer hitch and the rear axle.

If a cargo carrier is used in the trailer hitch receiver, choose a carrier that positions the load as close to the vehicle as possible. Make sure the total weight, including the carrier, is no more than half of the maximum allowable tongue weight for the vehicle or 227 kg (500 lb), whichever is less.

Ask your dealer for trailering information or assistance.

## Towing Equipment

### Hitches

Always use the correct hitch equipment for your vehicle. Crosswinds, getting passed by large trucks, and rough roads can affect the vehicle and trailer combination.

Never attach rental hitches or other bumper-type hitches. Only use frame-mounted hitches that do not attach to the bumper.

Always seal any holes in your vehicle if the trailer hitch removed. If not sealed, dirt, water, and carbon monoxide (CO) from the exhaust may enter your vehicle. See *Engine Exhaust* ⇨ 199.

Consider using mechanical sway controls with any trailer. Ask a trailering professional about sway controls or see the trailer manufacturer's recommendations and instructions.

### Tires

- Do not tow a trailer while using a compact spare tire on the vehicle.
- Tires must be properly inflated to support loads while towing a trailer. See *Tires* ⇨ 325 for instructions on proper tire inflation.

### Safety Chains

#### Warning

Always cross trailer safety chains and never allow them to drag on the ground. Improper installation can result in damage to the chains and could lead to loss of control of the trailer and tow vehicle. Serious injury can occur if the trailer detaches from the tow vehicle.

Always attach safety chains between the vehicle and the trailer, and then attach the chains to the holes on the trailer hitch.

Instructions about safety chains may be provided by the hitch manufacturer or by the trailer manufacturer.

Cross the safety chains under the tongue of the trailer to help prevent the tongue from contacting the road if it becomes separated from the hitch. Always leave just enough slack so the combination can turn. Never allow safety chains to drag on the ground.

### Trailer Brakes

Loaded trailers over 450 kg (1,000 lb) must be equipped with brake systems and with brakes for each axle. Use trailer braking equipment meeting or exceeding the Canadian Standards Association (CSA) requirement CAN3-D313.

State or local regulations may require trailers to have their own braking system if the loaded weight of the trailer exceeds certain minimums that can vary from state to state. Read and follow the instructions for the trailer brakes so they are installed, adjusted, and maintained properly.

 **Warning**

Never attempt to tamper with the hydraulic brake system for your trailer brakes. Do not connect a trailer's hydraulic brake system directly to your vehicle's hydraulic brake system. If you do, both the vehicle antilock brakes and the trailer brakes may not function, which could result in a crash.

**Trailer Lamps**

Always check that all trailer lamps are working at the beginning of each trip, and periodically on longer trips.

**Turn Signals When Towing a Trailer**

When properly connected, the trailer turn signals will illuminate to indicate the vehicle is turning, changing lanes, or stopping. When towing a trailer, the arrows on the instrument cluster will illuminate even if the trailer is not properly connected or the bulbs are burned out.

## Conversions and Add-Ons

### Add-On Electrical Equipment

 **Warning**

The Data Link Connector (DLC) is used for vehicle service and Emission Inspection/Maintenance testing. See *Malfunction Indicator Lamp (Check Engine Light)* ⇨ 101. A device connected to the DLC — such as an aftermarket fleet or driver-behavior tracking device — may interfere with vehicle systems. This could affect vehicle operation and cause a crash. Such devices may also access information stored in the vehicle's systems.

**Caution**

Some electrical equipment can damage the vehicle or cause components to not work and would not be covered by the vehicle warranty. Always check with your dealer before adding electrical equipment.

Add-on equipment can drain the vehicle's 12-volt battery, even if the vehicle is not operating.

The vehicle has an airbag system. Before attempting to add anything electrical to the vehicle, see *Servicing the Airbag-Equipped Vehicle* ⇨ 61 and *Adding Equipment to the Airbag-Equipped Vehicle* ⇨ 62.

## Vehicle Care

### General Information

General Information .....	287
California Perchlorate Materials Requirements .....	287
Accessories and Modifications .....	287

### Vehicle Checks

Doing Your Own Service Work .....	287
Hood .....	288
Engine Compartment Overview .....	290
Engine Oil .....	295
Engine Oil Life System .....	297
Automatic Transmission Fluid .....	298
Manual Transmission Fluid .....	298
Hydraulic Clutch .....	298
Engine Air Filter Life System .....	299
Engine Air Cleaner/Filter .....	299
Cooling System .....	302
Engine Overheating .....	306
Washer Fluid .....	307
Brakes .....	308
Brake Pad Life System (If Equipped) .....	310
Brake Fluid .....	311
Battery - North America .....	312
All-Wheel Drive .....	312
Park Brake and P (Park) Mechanism Check .....	313

Wiper Blade Replacement .....	313
Windshield Replacement .....	314
Gas Strut(s) .....	314

### Headlamp Aiming

Front Headlamp Aiming .....	315
-----------------------------	-----

### Bulb Replacement

LED Lighting .....	315
--------------------	-----

### Electrical System

Electrical System Overload .....	315
Fuses and Circuit Breakers .....	317
Engine Compartment Fuse Block .....	317
Instrument Panel Fuse Block .....	319
Rear Compartment Fuse Block .....	323

### Wheels and Tires

Tires .....	325
All-Season Tires .....	326
Winter Tires .....	326
Run-Flat Tires .....	326
Self-Sealing Tires .....	327
Noise Reducing Tires (V-Series Blackwing Only) .....	327
Low-Profile Tires .....	327
Summer Tires .....	327
Tire Sidewall Labeling .....	328
Tire Designations .....	329
Tire Terminology and Definitions .....	329
Tire Pressure .....	331
Tire Pressure for High-Speed Operation ..	332

Tire Pressure Monitor System .....	333
Tire Pressure Monitor Operation .....	334
Tire Inspection .....	337
Tire Rotation .....	337
When It Is Time for New Tires .....	338
Buying New Tires .....	339
Reverse Rim Wheels .....	340
Different Size Tires and Wheels .....	340
Uniform Tire Quality Grading .....	341
Wheel Alignment and Tire Balance .....	342
Wheel Replacement .....	342
Tire Traction Devices .....	343
If a Tire Goes Flat .....	343
Tire Sealant and Compressor Kit .....	344
Storing the Tire Sealant and Compressor Kit .....	349

### Jump Starting

Jump Starting - North America .....	349
-------------------------------------	-----

### Towing the Vehicle

Transporting a Disabled Vehicle .....	352
Recreational Vehicle Towing .....	354

### Appearance Care

Exterior Care .....	354
Interior Care .....	359
Floor Mats .....	362

## General Information

For service and parts needs, visit your dealer. You will receive genuine GM parts and GM-trained and supported service people.

Genuine GM parts have one of these marks:



***ACDelco***

## California Perchlorate Materials Requirements

Certain types of automotive applications, such as airbag initiators, seat belt pretensioners, and lithium batteries contained in electronic keys, may contain perchlorate

materials. Perchlorate Material – special handling may apply. See [www.dtsc.ca.gov/hazardouswaste/perchlorate](http://www.dtsc.ca.gov/hazardouswaste/perchlorate).

## Accessories and Modifications

Adding non-dealer accessories or making modifications to the vehicle can affect vehicle performance and safety, including such things as airbags, braking, stability, ride and handling, emissions systems, aerodynamics, durability, Driver Assistance Systems, and electronic systems like antilock brakes, traction control, and stability control. These accessories or modifications could even cause malfunction or damage not covered by the vehicle warranty.

Damage to suspension components caused by modifying vehicle height outside of factory settings will not be covered by the vehicle warranty.

Damage to vehicle components resulting from modifications or the installation or use of non-GM certified parts, including control module or software modifications, is not covered under the terms of the vehicle warranty and may affect remaining warranty coverage for affected parts.

GM Accessories are designed to complement and function with other systems on the vehicle. See your dealer to accessorize the vehicle using genuine GM Accessories installed by a dealer technician.

Also, see *Adding Equipment to the Airbag-Equipped Vehicle* ⇨ 62.

## Vehicle Checks

### Doing Your Own Service Work

#### Warning

It can be dangerous to work on your vehicle if you do not have the proper knowledge, service manual, tools, or parts. Always follow owner's manual procedures and consult the service manual for your vehicle before doing any service work.

#### Caution

Even small amounts of contamination can cause damage to vehicle systems. Do not allow contaminants to contact the fluids, reservoir caps, or dipsticks.



If doing some of your own service work, use the proper service manual. It tells you much more about how to service the vehicle than this manual can. To order the proper service manual, see *Publication Ordering Information* ⇨ 387.

This vehicle has an airbag system. Before attempting to do your own service work, see *Servicing the Airbag-Equipped Vehicle* ⇨ 61.

If equipped with remote start, open the hood before performing any service work to prevent remote starting the vehicle accidentally. See *Remote Start* ⇨ 12.

Keep a record with all parts receipts and list the mileage and the date of any service work performed. See *Maintenance Records* ⇨ 371.

## Hood

### Warning

For vehicles with auto engine stop/start, turn the vehicle off before opening the hood. If the vehicle is on, the engine will start when the hood is opened. You or others could be injured.

### Warning

Components under the hood can get hot from running the engine. To help avoid the risk of burning unprotected skin, never touch these components until they have cooled, and always use a glove or towel to avoid direct skin contact.

Clear any snow from the hood before opening.

### To open the hood:



1. Pull the hood release lever with the  symbol. It is on the lower left side of the instrument panel.

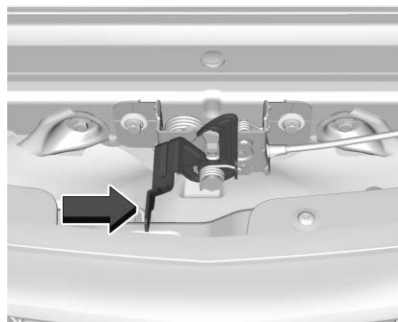

2. Go to the front of the vehicle and locate the secondary release lever under the front center of the hood. Push the secondary hood release lever to the right to release.
3. After you have partially lifted the hood, the gas strut system will automatically lift the hood and hold it in the fully open position.

### To close the hood:

1. Before closing the hood, be sure all filler caps are on properly, and all tools are removed.
2. Pull the hood down until the strut system is no longer holding up the hood.

3. Lower the hood 20 cm (8 in) above the vehicle. Allow the hood to fall. Check to make sure the hood is latched completely. Repeat this process with additional force if necessary.

 **Warning**

Do not drive the vehicle if the hood is not latched completely. The hood could open fully, block your vision, and cause a crash. You or others could be injured. Always close the hood completely before driving.

The Driver Information Center (DIC) will display a message if the hood is not fully closed.

Stop and turn off the vehicle, check the hood for obstructions, and close the hood again. Check to see if the message still appears on the DIC.

## Engine Compartment Overview

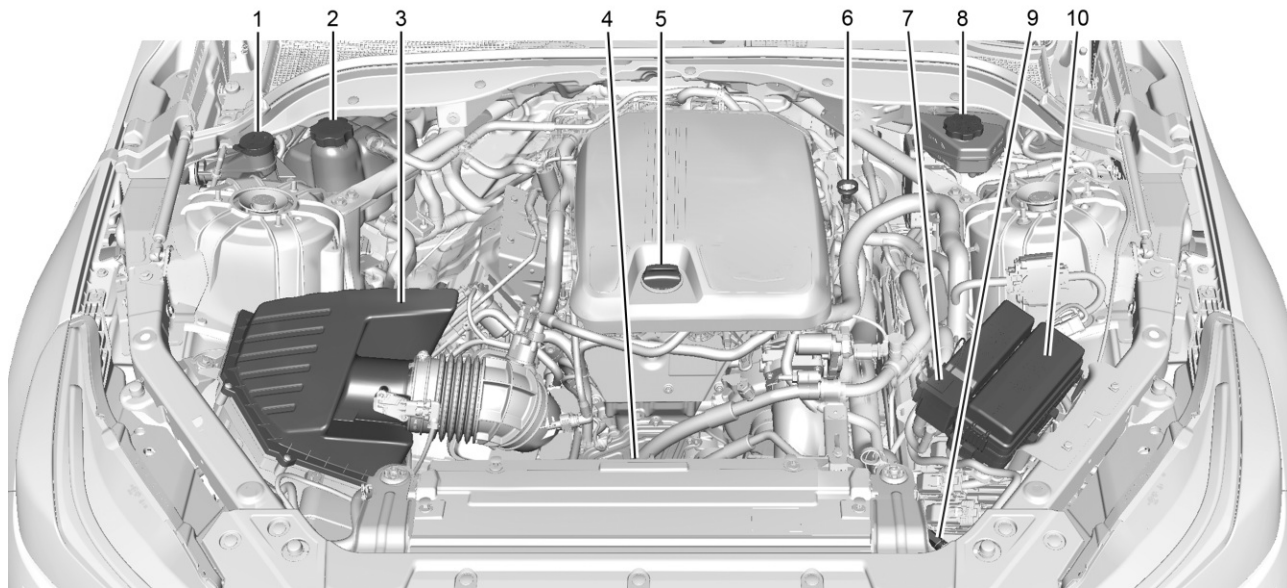

2.0L I4 Engine

- 
1. Windshield Washer Fluid Reservoir. See *Washer Fluid* ⇨ 307.
  2. Engine Coolant Surge Tank and Pressure Cap. See *Cooling System* ⇨ 302.
  3. *Engine Air Cleaner/Filter* ⇨ 299.
  4. Engine Cooling Fan (Out of View). See *Cooling System* ⇨ 302.
  5. Engine Oil Fill Cap. See *Engine Oil* ⇨ 295.
  6. Engine Oil Dipstick. See *Engine Oil* ⇨ 295.
  7. Remote Positive (+) Battery Terminal. See *Jump Starting - North America* ⇨ 349.
  8. Brake Fluid Reservoir. See *Brake Fluid* ⇨ 311.
  9. Remote Negative (-) Battery Terminal. See *Jump Starting - North America* ⇨ 349.
  10. *Engine Compartment Fuse Block* ⇨ 317.

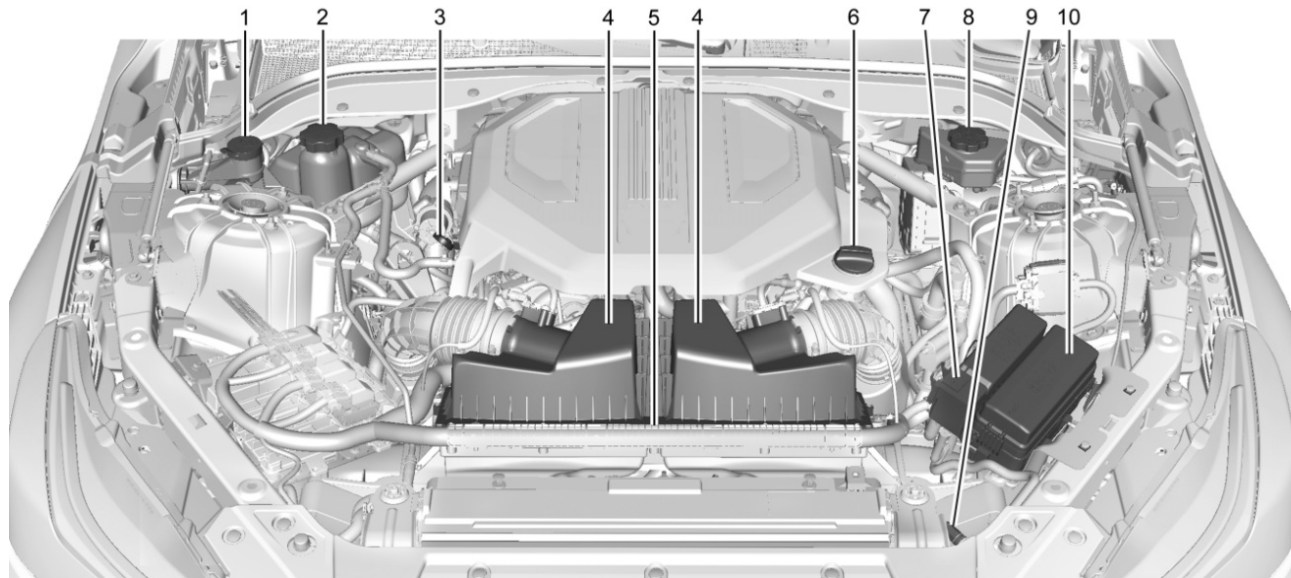

**3.0L V6 Engine**

- 
1. Windshield Washer Fluid Reservoir. See *Washer Fluid* ⇨ 307.
  2. Engine Coolant Surge Tank and Pressure Cap. See *Cooling System* ⇨ 302.
  3. Engine Oil Dipstick. See *Engine Oil* ⇨ 295.
  4. *Engine Air Cleaner/Filter* ⇨ 299.
  5. Engine Cooling Fan (Out of View). See *Cooling System* ⇨ 302.
  6. Engine Oil Fill Cap. See *Engine Oil* ⇨ 295.
  7. Remote Positive (+) Battery Terminal. See *Jump Starting - North America* ⇨ 349.
  8. Brake Fluid Reservoir. See *Brake Fluid* ⇨ 311.
  9. Remote Negative (-) Battery Terminal. See *Jump Starting - North America* ⇨ 349.
  10. *Engine Compartment Fuse Block* ⇨ 317.

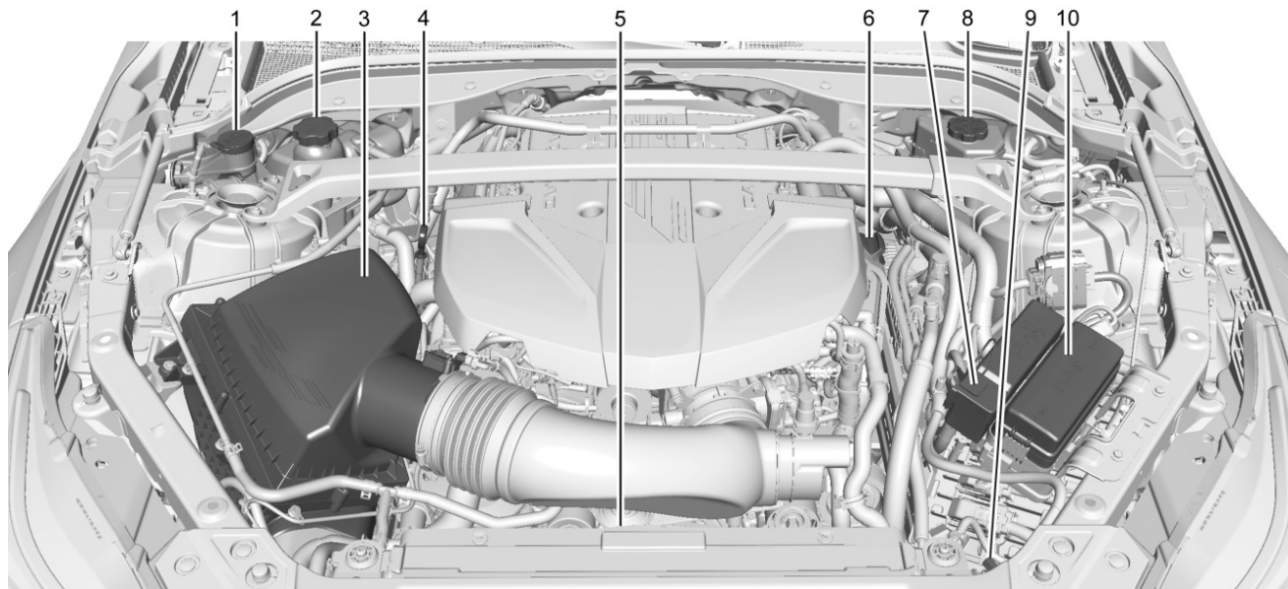

6.2L V8 Engine

1. Windshield Washer Fluid Reservoir. See *Washer Fluid* ⇨ 307.
2. Engine Coolant Surge Tank and Pressure Cap. See *Cooling System* ⇨ 302.
3. *Engine Air Cleaner/Filter* ⇨ 299.
4. Engine Oil Dipstick. See *Engine Oil* ⇨ 295.
5. Engine Cooling Fan (Out of View). See *Cooling System* ⇨ 302.
6. Engine Oil Fill Cap. See *Engine Oil* ⇨ 295.
7. Remote Positive (+) Battery Terminal. See *Jump Starting - North America* ⇨ 349.
8. Brake/Clutch Fluid Reservoir. See *Brake Fluid* ⇨ 311.
9. Remote Negative (-) Battery Terminal. See *Jump Starting - North America* ⇨ 349.
10. *Engine Compartment Fuse Block* ⇨ 317.

## Engine Oil

To ensure proper engine performance and long life, careful attention must be paid to engine oil. Following these simple, but important steps will help protect your investment:

- Use engine oil approved to the proper specification and of the proper viscosity grade. See “Selecting the Right Engine Oil” in this section.
- Check the engine oil level regularly and maintain the proper oil level. See “Checking Engine Oil” and “When to Add Engine Oil” in this section.
- Change the engine oil at the appropriate time. See *Engine Oil Life System* ⇨ 297.
- Always dispose of engine oil properly. See “What to Do with Used Oil” in this section.

### Checking Engine Oil

Check the engine oil level regularly, every 650 km (400 mi), especially prior to a long trip. The engine oil dipstick handle is a loop. See *Engine Compartment Overview* ⇨ 290 for the location.

#### Warning

The engine oil dipstick handle may be hot; it could burn you. Use a towel or glove to touch the dipstick handle.

If a low oil Driver Information Center (DIC) message displays, check the oil level.

Follow these guidelines:

- To get an accurate reading, park the vehicle on level ground. Check the engine oil level after the engine has been off for at least two hours. Checking the engine oil level on steep grades or too soon after engine shutoff can result in incorrect readings. Accuracy improves when checking a cold engine prior to starting. Remove the dipstick and check the level.
- If unable to wait two hours, the engine must be off for at least 15 minutes if the engine is warm, or at least 30 minutes if the engine is not warm. Pull out the dipstick, wipe it with a clean paper towel or cloth, then push it back in all the way. Remove it again, keeping the tip down, and check the level.

### When to Add Engine Oil



2.0L I4 Turbo (LSY) Engine





### 3.0L V6 Twin Turbo (LGY) and 6.2L V8 (LT4) Engines

If the oil is below the cross-hatched area at the tip of the dipstick and the engine has been off for at least 15 minutes, add 1 L (1 qt) of the recommended oil and then recheck the level. See “Selecting the Right Engine Oil” later in this section for an explanation of what kind of oil to use. For engine oil crankcase capacity, see *Capacities and Specifications* ⇨ 375.

#### Caution

Do not add too much oil. Oil levels above or below the acceptable operating range shown on the dipstick are harmful to the engine. If the oil level is above the operating range (i.e., the engine has so much oil that the oil level gets above the cross-hatched

(Continued)

#### Caution (Continued)

area that shows the proper operating range), the engine could be damaged. Drain the excess oil or limit driving of the vehicle, and seek a service professional to remove the excess oil.

See *Engine Compartment Overview* ⇨ 290 for the location of the engine oil fill cap.

Add enough oil to put the level somewhere in the proper operating range. Push the dipstick all the way back in when through.

### Selecting the Right Engine Oil – 2.0L L4 Turbo (LSY) and 3.0L V6 Twin Turbo (LGY) Engines

Selecting the right engine oil depends on both the proper oil specification and viscosity grade. See *Recommended Fluids and Lubricants* ⇨ 370.

#### Specification

Use full synthetic engine oils that meet the dexos1 specification. Engine oils that have been approved by GM as meeting the dexos1 specification are marked with the dexos1 approved logo.



#### Caution

Failure to use the recommended engine oil or equivalent can result in engine damage not covered by the vehicle warranty.

#### Viscosity Grade

For the 2.0L L4 Turbo (LSY) engine, use SAE 0W-20 viscosity grade engine oil.

For the 3.0L V6 Twin Turbo (LGY) engine, use SAE 5W-30 viscosity grade engine oil. Cold Temperature Operation: In an area of extreme cold, where the temperature falls below  $-29^{\circ}\text{C}$  ( $-20^{\circ}\text{F}$ ), an SAE 0W-30 oil may be used. An oil of this viscosity grade will provide easier cold starting for the engine at extremely low temperatures.

When selecting an oil of the appropriate viscosity grade, it is recommended to select an oil of the correct specification. See “Specification” earlier in this section.

## Selecting the Right Engine Oil — 6.2L V8 (LT4) Engine

Selecting the right engine oil depends on both the proper oil specification and viscosity grade. See *Recommended Fluids and Lubricants* ⇨ 370.

### Specification

Use full synthetic engine oils that meet the dexosR specification. Engine oils that have been approved by GM as meeting the dexosR specification are marked with the dexosR approved logo.



### Caution

Failure to use the recommended engine oil or equivalent can result in engine damage not covered by the vehicle warranty.

### Viscosity Grade

For the 6.2L V8 (LT4) engine, use SAE 0W-40 viscosity grade engine oil. GM recommends Mobil 1 engine oil that shows the dexosR approved logo.

When selecting an oil of the appropriate viscosity grade, it is recommended to select an oil of the correct specification. See “Specification” earlier in this section.

### Engine Oil Additives/Engine Oil Flushes

Do not add anything to the oil. The recommended oils meeting the dexosR specification are all that is needed for good performance and engine protection.

Engine oil system flushes are not recommended and could cause engine damage not covered by the vehicle warranty.

### What to Do with Used Oil

Used engine oil contains certain elements that can be unhealthy for your skin and could even cause cancer. Do not let used oil stay on your skin for very long. Clean your skin and nails with soap and water, or a good hand cleaner. Wash or properly dispose of clothing

or rags containing used engine oil. See the manufacturer's warnings about the use and disposal of oil products.

Used oil can be a threat to the environment. If you change your own oil, be sure to drain all the oil from the filter before disposal. Never dispose of oil by putting it in the trash or pouring it on the ground, into sewers, or into streams or bodies of water. Recycle it by taking it to a place that collects used oil.

## Engine Oil Life System

### When to Change Engine Oil

This vehicle has a computer system that indicates when to change the engine oil and filter. This is based on a combination of factors which include engine revolutions, engine temperature, and miles driven. Based on driving conditions, the mileage at which an oil change is indicated can vary considerably. For the oil life system to work properly, the system must be reset every time the oil is changed.

When the system has calculated that oil life has been diminished, it indicates that an oil change is necessary. A CHANGE ENGINE OIL SOON message comes on. Change the oil as

soon as possible within the next 1 000 km (600 mi). It is possible that, if driving under the best conditions, the oil life system may indicate that an oil change is not necessary for up to a year. The engine oil and filter must be changed at least once a year and at this time the system must be reset. Your dealer has trained service people who will perform this work and reset the system. It is also important to check the oil regularly over the course of an oil drain interval and keep it at the proper level.

If the system is ever reset accidentally, the oil must be changed at 5 000 km (3,000 mi) since the last oil change. Remember to reset the oil life system whenever the oil is changed.

### How to Reset the Engine Oil Life System

Reset the system whenever the engine oil is changed so that the system can calculate the next engine oil change. To reset the system:

1. Place the vehicle in P (Park).
2. From the infotainment home screen, select Vehicle Status > Fluids and Filters > Oil Life. See *Vehicle Status* ⇨ 115.

3. Follow the menu and select Reset on the display screen. Then select Reset to confirm the reset. The percentage will change to 100%.

The system is reset when the CHANGE ENGINE OIL SOON message is off.

If the CHANGE ENGINE OIL SOON message comes back on when the vehicle is started, the engine oil life system has not been reset. Repeat the procedure.

## Automatic Transmission Fluid

### How to Check Automatic Transmission Fluid

It is not necessary to check the transmission fluid level. A transmission fluid leak is the only reason for fluid loss. If a leak occurs, take the vehicle to your dealer and have it repaired as soon as possible.

The vehicle is not equipped with a transmission fluid level dipstick. There is a special procedure for checking and changing the transmission fluid. Because this procedure is difficult, this should be done at the dealer. Contact your dealer for additional information.

### Caution

Use of the incorrect automatic transmission fluid may damage the vehicle, and the damage may not be covered by the vehicle warranty. Always use the correct automatic transmission fluid. See *Recommended Fluids and Lubricants* ⇨ 370.

Change the fluid and filter at the intervals listed in *Maintenance Schedule* ⇨ 365, and be sure to use the fluid listed in *Recommended Fluids and Lubricants* ⇨ 370.

## Manual Transmission Fluid

It is not necessary to check the manual transmission fluid level. A transmission fluid leak is the only reason for fluid loss. If a leak occurs, take the vehicle to your dealer and have it repaired as soon as possible. See *Recommended Fluids and Lubricants* ⇨ 370 for the proper fluid to use.

## Hydraulic Clutch

For vehicles with a manual transmission, it is not necessary to regularly check brake/clutch fluid unless there is a leak suspected. Adding

fluid will not correct a leak. A fluid loss in this system could indicate a problem. Have the system inspected and repaired.

### When to Check and What to Use



The brake/hydraulic clutch fluid reservoir cap has this symbol on it. See *Engine Compartment Overview* ⇨ 290 for reservoir location. The common hydraulic clutch and brake master cylinder fluid reservoir is filled with brake fluid as indicated on the reservoir cap. See *Brake Fluid* ⇨ 311 for brake fluid to use.

### How to Check and Add Fluid

Visually check the brake/clutch fluid reservoir to make sure the fluid level is at the MIN (minimum) line on the side of the reservoir. The brake/hydraulic clutch fluid system should be closed and sealed.

Do not remove the cap to check the fluid level or to top-off the fluid level. Remove the cap only when necessary to add the proper fluid until the level reaches the MIN line.

### Engine Air Filter Life System

This feature provides the engine air filter's remaining life and best timing for a change. The timing to change an engine air filter depends on driving and environmental conditions.

#### When to Change the Engine Air Filter

When the Driver Information Center (DIC) displays a message to replace the engine air filter at the next oil change, follow this timing.

When the DIC displays a message to replace the engine air filter soon, replace the engine air filter at the earliest convenience.

The system must be reset after the engine air filter is changed.

If the DIC displays a message to check the engine air filter system, see your dealer.

#### How to Reset the Engine Air Filter Life System

To reset:

1. Place the vehicle in P (Park).

2. Display the Maintenance card on the DIC. See *Driver Information Center (DIC)* ⇨ 111.
3. Use the thumbwheel to scroll to Air Filter Life.
4. Press the thumbwheel to select Air Filter Life.
5. Use the thumbwheel to scroll to Reset.
6. Press the thumbwheel to select Reset.

### Engine Air Cleaner/Filter

The engine air cleaner/filter is in the engine compartment on the passenger side of the vehicle for the 2.0L I4 and 6.2L V8 engines, and in the center of the engine compartment for the 3.0L V6 engine. See *Engine Compartment Overview* ⇨ 290.

#### When to Inspect the Engine Air Cleaner/Filter

- For intervals on changing and inspecting the engine air filter, see *Maintenance Schedule* ⇨ 365.
- If equipped with Engine Air Filter Life System, see *Engine Air Filter Life System* ⇨ 299.

- If driving in very dusty areas, follow the engine air filter inspecting and changing intervals, see *Maintenance Schedule* ⇨ 365.

### How to Inspect/Replace the Engine Air Cleaner/Filter

Do not start the engine or have the engine running with the engine air cleaner/filter housing open. Before removing the engine air cleaner/filter, make sure that the engine air cleaner/filter housing and nearby components are free of dirt and debris. Do not clean the engine air cleaner/filter or components with water or compressed air.

#### Warning

Operating the engine with the air cleaner/filter off can cause you or others to be burned. Use caution when working on the engine. Do not start the engine or drive the vehicle with the air cleaner/filter off, as flames may be present if the engine backfires.

#### Caution

If the air cleaner/filter is off, dirt can easily get into the engine, which could damage it. Always have the air cleaner/filter in place when driving.

To inspect or replace the air cleaner/filter:

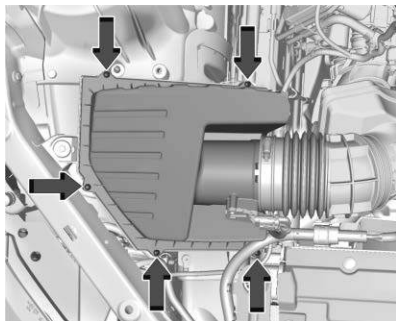

2.0L I4 Engine

1. Remove the five screws on top of the air cleaner/filter cover.
2. Lift the air/cleaner/filter cover away from the air cleaner/filter housing.
3. Pull out the air cleaner/filter.

#### Warning

If part replacement is necessary, the part must be replaced with one of the same part number or with an equivalent part. Use of a replacement part without the same fit, form, and function may result in personal injury or damage to the vehicle.

5. Inspect or replace the air cleaner/filter.
6. Reverse Steps 1–3 to reinstall the air cleaner/filter cover.
7. If equipped, reset the engine air filter life system after replacing the engine air filter. See *Engine Air Filter Life System* ⇨ 299.

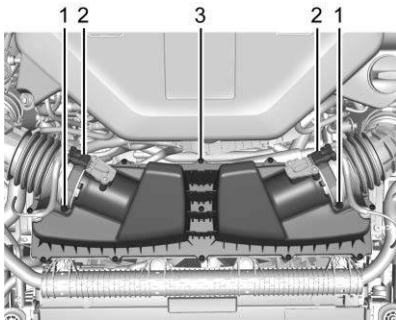

3.0L V6 Engine

1. Air Duct Clamps
2. Electrical Connectors
3. Screws
1. Disconnect the harness connectors from the air cleaner/filter cover electrical connectors (2).
2. Loosen the screws on the air duct clamps (1) holding the air outlet ducts in place. Do not remove clamps. Move the ducts aside.
3. Remove the 13 screws (3) on top of the engine air cleaner/filter cover to gain access to both air cleaner/filters.

4. Lift the engine air cleaner/filter cover.

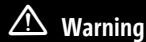
**Warning**

If part replacement is necessary, the part must be replaced with one of the same part number or with an equivalent part. Use of a replacement part without the same fit, form, and function may result in personal injury or damage to the vehicle.

6. Lift and remove one or both engine air cleaner/filters.
7. Inspect or replace one or both engine air cleaner/filters.
8. Reverse Steps 1–4 to reinstall the engine air cleaner/filter cover.
9. If equipped, reset the engine air filter life system after replacing the engine air filter. See *Engine Air Filter Life System* ⇨ 299.

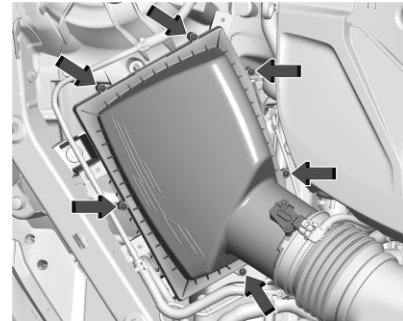

6.2L V8 Engine

1. Remove the six screws on top of the air cleaner/filter cover.
2. Lift the air/cleaner/filter cover away from the air cleaner/filter housing.

**Warning**

If part replacement is necessary, the part must be replaced with one of the same part number or with an equivalent part. Use of a replacement part without the same fit, form, and function may result in personal injury or damage to the vehicle.

4. Pull out the air cleaner/filter.
5. Inspect or replace the air cleaner/filter.
6. Reverse Steps 1–3 to reinstall the air cleaner/filter cover.
7. If equipped, reset the engine air filter life system after replacing the engine air filter. See *Engine Air Filter Life System* ⇨ 299.

## Cooling System

The cooling system allows the engine to maintain the correct working temperature.

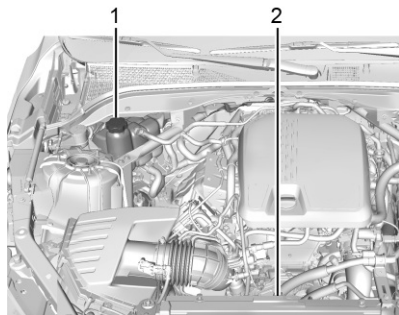

2.0L I4 Engine

1. Engine Coolant Surge Tank and Pressure Cap
2. Engine Cooling Fan (Out of View)

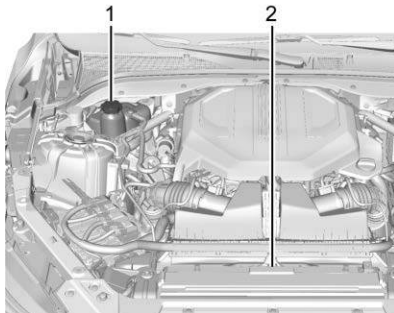

3.0L V6 Engine

1. Engine Coolant Surge Tank and Pressure Cap
2. Engine Cooling Fan (Out of View)

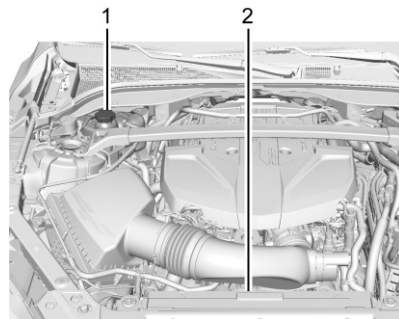

6.2L V8 Engine

1. Engine Coolant Surge Tank and Pressure Cap
2. Engine Cooling Fan (Out of View)

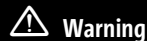

**Warning**

An underhood electric fan can start up even when the engine is not running and can cause injury. Keep hands, clothing, and tools away from any underhood electric fan.

 **Warning**

Do not touch heater or radiator hoses, or other engine parts. They can be very hot and can burn you. Do not run the engine if there is a leak; all coolant could leak out. That could cause an engine fire and can burn you. Fix any leak before driving the vehicle.

**Caution**

Do not use anything other than a mix of DEX-COOL coolant that meets GM Standard GMW3420 and clean, drinkable water. Anything else can cause damage to the engine cooling system and the vehicle, which would not be covered by the vehicle warranty.

**Engine Coolant**

The cooling system in the vehicle is filled with DEX-COOL engine coolant. See *Maintenance Schedule* ⇨ 365 and *Recommended Fluids and Lubricants* ⇨ 370 .

The following explains the cooling system and how to check and add coolant when it is low. If there is a problem with engine overheating, see *Engine Overheating* ⇨ 306.

**What to Use** **Warning**

Do not touch heater or radiator hoses, or other engine parts. They can be very hot and can burn you. Do not run the engine if there is a leak; all coolant could leak out. That could cause an engine fire and can burn you. Fix any leak before driving the vehicle.

Use a 50/50 mixture of clean drinkable water and DEX-COOL coolant. This mixture:

- Gives freezing protection down to  $-37^{\circ}\text{C}$  ( $-34^{\circ}\text{F}$ ), outside temperature.
- Gives boiling protection up to  $129^{\circ}\text{C}$  ( $265^{\circ}\text{F}$ ), engine temperature.
- Protects against rust and corrosion.
- Will not damage aluminum parts.
- Helps keep the proper engine temperature.

**Caution**

Do not use anything other than a mix of DEX-COOL coolant that meets GM Standard GMW3420 and clean, drinkable water. Anything else can cause damage to the engine cooling system and the vehicle, which would not be covered by the vehicle warranty.

Never dispose of engine coolant by putting it in the trash, pouring it on the ground, or into sewers, streams, or bodies of water. Have the coolant changed by an authorized service center, familiar with legal requirements regarding used coolant disposal. This will help protect the environment and your health.

**Checking Coolant**

The vehicle must be on a level surface when checking the coolant level.

It is normal to see coolant moving in the upper coolant hose return line when the engine is running. It is also normal to see bubbles entering the surge tank through the small hose.



Check to see if coolant is visible in the coolant surge tank. If the coolant inside the coolant surge tank is boiling, do not do anything else until it cools down.



If coolant is visible but the coolant level is not at or above the indicated mark, add a 50/50 mixture of clean drinkable water and DEX-COOL coolant.

Be sure the cooling system is cool before this is done.

If no coolant is visible in the coolant surge tank, add coolant as follows:

### How to Add Coolant to the Coolant Surge Tank

#### Warning

Spilling coolant on hot engine parts can burn you. Coolant contains ethylene glycol and it will burn if the engine parts are hot enough.

#### Warning

Plain water, or other liquids such as alcohol, can boil before the proper coolant mixture will. With plain water or the wrong mixture, the engine could get too hot but there would not be an overheat warning. The engine could catch fire and you or others could be burned.

#### Warning

Steam and scalding liquids from a hot cooling system are under pressure. Turning the pressure cap, even a little, can cause

(Continued)

#### Warning (Continued)

them to come out at high speed and you could be burned. Never turn the cap when the cooling system, including the pressure cap, is hot. Wait for the cooling system and pressure cap to cool.

#### Caution

Failure to follow the specific coolant fill procedure could cause the engine to overheat and could cause system damage. If coolant is not visible in the surge tank, contact your dealer.

If no problem is found, check to see if coolant is visible in the coolant surge tank. If coolant is visible but the coolant level is not at or above the indicated mark, add a 50/50 mixture of clean, drinkable water and DEX-COOL coolant at the coolant surge tank, but be sure the cooling system, including the coolant surge tank pressure cap, is cool before you do it.

## 2.0L I4 Engine

### Automatic Coolant Service Fill Instructions

The vehicle is equipped with a service feature that assists with filling and removing air from the cooling system after service of components or when coolant is added after being too low.

To use the service feature:



1. With a cold system, add coolant to the indicated line on the surge tank.
2. Replace the pressure cap on the surge tank.

To activate the service feature:

1. Connect the vehicle to a battery charger.

2. Turn the ignition on. See *Ignition Positions* ⇨ 192.
3. Turn off the air conditioning.
4. Set the parking brake.
5. At the same time, press the accelerator and the brake pedal for two seconds, then release.
6. At the end of the cycle, check the coolant level in the surge tank and add coolant if it is below the indicated line. Turn the ignition off, allow the Electronic Control Module (ECM) to go to sleep, about two minutes, and repeat Steps 2–6.

Listen for pump activation and movement of the control valves while watching the level of the coolant in the surge tank. If the tank empties, turn the ignition off, carefully remove the pressure cap, refill to the indicated line, replace the pressure cap, and repeat Steps 2–6.

The fill and air removal process will run for approximately 15 minutes.

### Caution

If the pressure cap is not tightly installed, coolant loss and engine damage may occur. Be sure the cap is properly and tightly secured.

## 3.0L V6 Engine and 6.2L V8 Engine



1. Remove the coolant surge tank pressure cap when the cooling system, including the coolant surge tank pressure cap and upper radiator hose, is no longer hot.

Turn the pressure cap slowly counterclockwise. If you hear a hiss, wait for that to stop. This will allow any pressure still left to be vented out the discharge hose.

2. Keep turning the pressure cap slowly and remove it.



2.0L I4 Engine and 3.0L V6 Engine Coolant Surge Tank

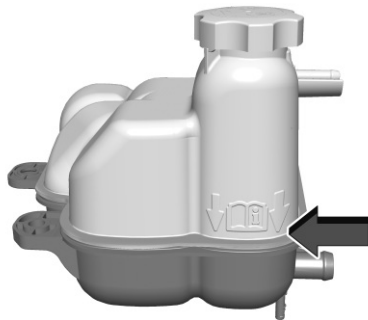

6.2L V8 Engine Coolant Surge Tank

3. Fill the surge tank with the proper mixture to the indicated level mark.
4. With the coolant surge tank pressure cap off, start the engine and let it run until you can feel the upper radiator hose getting hot. Watch out for the engine cooling fan.

By this time, the coolant level inside the coolant surge tank may be lower. If the level is lower, add more of the proper mixture to the surge tank until the level reaches the indicated level mark.

5. Replace the pressure cap tightly.
6. Check the level in the surge tank after the engine is shut off and the cooling system has cooled down. If the coolant is not at the proper level, repeat Steps 1–6. If the coolant still is not at the proper level when the system cools down again, see your dealer.

#### Caution

If the pressure cap is not tightly installed, coolant loss and engine damage may occur. Be sure the cap is properly and tightly secured.

## Engine Overheating

The vehicle has an indicator to warn of the engine overheating.

If the decision is made not to lift the hood when this warning appears, get service help right away. See *Roadside Assistance Program* ⇨ 382.

If the decision is made to lift the hood, make sure the vehicle is parked on a level surface.

Then check to see if the engine cooling fan is running. If the engine is overheating, the fan should be running. If it is not, do not continue to run the engine. Have the vehicle serviced.

#### Caution

Do not run the engine if there is a leak in the engine cooling system. This can cause a loss of all coolant and can damage the system and vehicle. Have any leaks fixed right away.

## If Steam Is Coming from the Engine Compartment

### Warning

Steam and scalding liquids from a hot cooling system are under pressure. Turning the pressure cap, even a little, can cause them to come out at high speed and you could be burned. Never turn the cap when the cooling system, including the pressure cap, is hot. Wait for the cooling system and pressure cap to cool.

## If No Steam Is Coming from the Engine Compartment

If an engine overheat warning is displayed but no steam can be seen or heard, the problem may not be too serious. Sometimes the engine can get a little too hot when the vehicle:

- Climbs a long hill on a hot day.
- Stops after high-speed driving.
- Idles for long periods in traffic.

If the overheat warning is displayed with no sign of steam:

1. Turn the air conditioning off.

2. Turn the heater on to the highest temperature and to the highest fan speed. Open the windows as necessary.
3. When it is safe to do so, pull off the road, shift to P (Park) or N (Neutral) and let the engine idle.

If the overheat warning no longer displays, the vehicle can be driven. Continue to drive the vehicle slowly for about 10 minutes. Keep a safe vehicle distance from the vehicle in front. If the warning does not come back on, continue to drive normally and have the cooling system checked for proper fill and function.

If the warning continues, pull over, stop, and park the vehicle right away.

If there is no sign of steam, idle the engine for three minutes while parked. If the warning is still displayed, turn off the engine until it cools down.

## Washer Fluid

### What to Use

When windshield washer fluid is needed, be sure to read the manufacturer's instructions before use. If operating the vehicle in an

area where the temperature may fall below freezing, use a fluid that has sufficient protection against freezing.

## Adding Washer Fluid

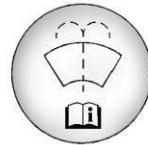

Open the cap with the washer symbol on it. Add washer fluid until the tank is full.

See *Engine Compartment Overview* ⇨ 290 for reservoir location.

### Caution

- Do not use washer fluid that contains any type of water repellent coating. This can cause the wiper blades to chatter or skip.
- Do not use engine coolant (antifreeze) in the windshield washer. It can damage the windshield washer system and paint.

(Continued)

**Caution (Continued)**

- Do not mix water with ready-to-use washer fluid. Water can cause the solution to freeze and damage the washer fluid tank and other parts of the washer system.
- When using concentrated washer fluid, follow the manufacturer instructions for adding water.
- Fill the washer fluid tank only three-quarters full when it is very cold. This allows for fluid expansion if freezing occurs, which could damage the tank if it is completely full.

**Brakes**

Disc brake linings, except J57 V-Series Blackwing with carbon ceramic brakes, have built-in wear indicators that make a high-pitched warning sound when the brake linings are worn and new linings are needed. The sound can come and go or can be heard all the time when the vehicle is moving, except when applying the brake pedal firmly. The V-Series Blackwing has electronic pad wear sensors. See *Brake Pad Life System (If Equipped)* ⇨ 310

**Warning**

The brake wear warning sound means that soon the brakes will not work well. That could lead to a crash. When the brake wear warning sound is heard, have the vehicle serviced.

**Caution**

Continuing to drive with worn-out brake linings could result in costly brake repairs.

Properly torqued wheel nuts are necessary to help prevent brake pulsation. When tires are rotated, inspect brake linings for wear and evenly tighten wheel nuts in the proper sequence to torque specifications. See *Capacities and Specifications* ⇨ 375.

Brake linings should be replaced as complete axle sets.

**Brake Squeal and Brake Dust**

Some driving conditions or climates can cause a brake squeal when the brakes are first applied, clearing up following several applies. This does not mean something is wrong with the brakes.

Vehicles equipped with high performance brake systems provide superior fade resistance, but will produce increased brake squeal and brake dust on the wheels and calipers as compared to standard brake linings. This is normal.

To help reduce squeal, high performance brake pads are treated with an anti-squeal paste that may need to be reapplied periodically as part of normal vehicle maintenance. The anti-squeal paste will dissipate over time. Also, the use of wheel cleaners or power washers directly on the brake calipers may remove the anti-squeal paste from the brake pads. It may be necessary to reapply the anti-squeal paste if it is removed during cleaning.

If brake squeal is excessive, the anti-squeal paste should be reapplied. The anti-squeal paste should always be reapplied whenever the brake pads are removed or replaced. See your dealer for service.

## Brake Pedal Travel

See your dealer if the brake pedal does not return to normal height, or if there is a rapid increase in pedal travel. This could be a sign that brake service may be required.

## Replacing Brake System Parts

Always replace brake system parts with new, approved replacement parts. If this is not done, the brakes may not work properly. The braking performance can change in many ways if the wrong brake parts are installed or if parts are improperly installed.

The Brake Fade Warning Assist system is designed for use with the factory-installed brake pads or GM approved replacement pads. If the brake pads on the vehicle need to be replaced, use GM-approved brake pads. If this is not done, the brake fade warning system may not function properly.

## High Performance Brake Lining Car Wash and Extended Parking Care

If equipped with high performance brake components, binding or clunking may be noticeable after extended parking or in cold weather when the brakes have been wet, such as when driving in the rain or after a car wash.

The clunking is normal for brakes with high performance brake linings and does not affect the operation of the brakes. When driving, normal braking will allow for the brakes to feel smooth and the clunking to go away. If the vehicle is washed before overnight parking or long term storage, drive it and apply the brakes several times to thoroughly dry the brakes.

## Brake Rotor Wear (V-Series Blackwing With J57 Carbon Ceramic Rotors)

The V-Series Blackwing with J57 has carbon ceramic brake rotors. The rotors should be visually inspected whenever the brake pads are replaced. Carbon ceramic brake rotors also need to be weighed before brake pads are replaced to confirm that the rotor mass is greater than the wear-out mass printed on the rotor. The rotor can be reused if the weight of the rotor is above the mass limit. Carbon ceramic brake rotors inspection and weighing methods can be found in the service manual.

## V-Series Blackwing Brake Burnish Procedure for Corrosion Cleanup

Corrosion spotting and grooving on the brake rotor surface may appear after the vehicle sits for an extended period of time, especially

in high humidity. This corrosion may result in brake pulsation and noise. To help restore optimal braking performance and reduce noise, complete the following procedure:

### Caution

Performing the brake burnish procedure on a base brake system can result in brake damage.

Perform this procedure only on dry pavement, in a safe manner, and in compliance with all local and state ordinances/laws regarding motor vehicle operation.

### Caution

The new vehicle break-in period should be completed before performing the brake burnishing procedure or damage may occur to the powertrain/engine. See *New Vehicle Break-In* ⇨ 191.

**Caution**

Brake fade can occur during this burnish procedure and can cause brake pedal travel and force to increase. This could extend stopping distance until the brakes are fully burnished.

Completing the following procedure as instructed will not damage the brakes. The brake pads may smoke and produce an odor. The braking force and pedal travel may increase. After the procedure, the brake pads may appear white at the rotor contact.

1. Using the G-Force Gauge in the HUD display, apply the brakes 10 times starting at 100 km/h (60 mph) to 50 km/h (30 mph) while decelerating at 0.4g. See *Head-Up Display (HUD)* ⇨ 117. This is a medium brake application. Drive for at least 0.5 km (0.3 mi) between applying the brakes.
2. If further cleanup of the brake discs is needed, repeat this procedure with 0.7g applications.

As with all high performance brake systems, some amount of brake squeal is normal.

## Brake Pad Life System (If Equipped)

### When to Change Brake Pads

If equipped, this system estimates the remaining life of the front and rear brake pads. Brake Pad Life is displayed in the Driver Information Center (DIC), along with a percentage for each axle. The system must be reset every time the brake pads are changed.

When the system has determined that the brake pads need to be replaced, a message displays, which may include mileage remaining.

Brake pads should always be replaced as complete axle sets.

### How to Reset the Brake Pad Life System

The system will automatically detect when significantly worn brake pads are replaced. When the ignition is turned on after new pads and wear sensors are installed, a message will display. Follow the prompts to reset the system.

The brake pad life system can also be manually reset:

1. Display Brake Pad Life on the DIC. See *Driver Information Center (DIC)* ⇨ 111.
2. Select the Brake Pad Life menu.
3. Select front or rear pads as appropriate.
4. Select YES on the confirmation message. Repeat for the pads on the other axle if they were also replaced.

### How to Disable the Brake Pad Life System

The brake pad life system can be turned off. This may be necessary if aftermarket brake pads without wear sensors are installed. When the system is turned off, the front and rear brake pad life percentages will not display. However, the built-in wear indicators that make a high-pitched warning sound when the brake pads are worn can still determine when the pads should be replaced. See *Brakes* ⇨ 308.

To turn off the brake pad life system:

1. Display Brake Pad Life on the DIC. See *Driver Information Center (DIC)* ⇨ 111.
2. Select the Brake Pad Life menu.
3. Select DISABLE.

To turn the brake pad life system back on, follow the above steps but select ENABLE in Step 2.

### Brake Pad Sensor System (V-Series Blackwing)

The V-Series Blackwing has electronic brake pad wear sensors, when the brake pads need to be replaced, a message displays in the Driver Information Center (DIC).

When the message displays, install new brake pads and brake pad wear sensors on the vehicle.

When the ignition is turned on after new brake pads and brake pad wear sensors are installed, the message should no longer display.

The brake pad sensor system can only be reset by replacing the brake pads and brake pad wear sensors.

### Brake Fluid

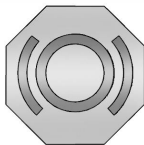

The brake/clutch master cylinder reservoir is filled with GM approved DOT 4 brake fluid as indicated on the reservoir cap. See *Engine Compartment Overview* ⇨ 290 for the location of the reservoir.

#### Checking Brake Fluid

Place the vehicle in P (Park) or Neutral with the parking brake applied if equipped with a manual transmission. On a level surface, the brake fluid level should be between the minimum and maximum marks on the brake fluid reservoir.

There are only two reasons why the brake fluid level in the reservoir may go down:

- Normal brake lining wear. When new linings are installed, the fluid level goes back up.
- A fluid leak in the brake/clutch hydraulic system. Have the brake/clutch hydraulic system fixed. With a leak, the brakes will not work well.

Always clean the brake fluid reservoir cap and the area around the cap before removing it.

Do not top off the brake/clutch fluid. Adding fluid does not correct a leak. If fluid is added when the linings are worn, there will be

too much fluid when new brake linings are installed. Add or remove fluid, as necessary, only when work is done on the brake/clutch hydraulic system.

#### Warning

If too much brake fluid is added, it can spill on the engine and burn, if the engine is hot enough. You or others could be burned, and the vehicle could be damaged. Add brake fluid only when work is done on the brake/clutch hydraulic system.

When the brake/clutch fluid falls to a low level, the brake warning light comes on. See *Brake System Warning Light* ⇨ 103.

Brake fluid absorbs water over time which degrades the effectiveness of the brake fluid. Replace brake fluid at the specified intervals to prevent increased stopping distance. See *Maintenance Schedule* ⇨ 365.

#### What to Add

Use only GM approved DOT 4 brake fluid from a clean, sealed container. See *Recommended Fluids and Lubricants* ⇨ 370.



 **Warning**

The wrong or contaminated brake fluid could result in damage to the brake system. This could result in the loss of braking leading to a possible injury. Always use the proper GM approved brake fluid.

**Caution**

If brake fluid is spilled on the vehicle's painted surfaces, the paint finish can be damaged. Immediately wash off any painted surface.

**Battery - North America**

The original equipment battery is maintenance free. Do not remove the cap and do not add fluid.

Refer to the replacement number shown on the original battery label when a new battery is needed.

The vehicle has an Absorbed Glass Mat (AGM) 12-volt battery. Installation of a standard 12-volt battery will result in reduced 12-volt battery life.

When using a 12-volt battery charger on the 12-volt AGM battery, some chargers have an AGM battery setting on the charger. If available, use the AGM setting on the charger, to limit charge voltage to 14.8 volts. Follow the charger manufacturer's instructions.

For replacement of the battery, see your dealer.

**Stop/Start System**

This vehicle has a Stop/Start system to shut off the engine to help conserve fuel. See *Stop/Start System* ⇨ 195.

 **Warning**

**WARNING:** Battery posts, terminals and related accessories can expose you to chemicals including lead and lead compounds, which are known to the State of California to cause cancer and birth defects or other reproductive harm. Wash hands after handling. For more information go to [www.P65Warnings.ca.gov](http://www.P65Warnings.ca.gov).

See *California Proposition 65 Warning* ⇨ 1.

**Vehicle Storage**
 **Warning**

Batteries have acid that can burn you and gas that can explode. You can be badly hurt if you are not careful. Always wear eye protection. See *Jump Starting - North America* ⇨ 349 for tips on working around a battery without getting hurt.

**Infrequent Usage:** Remove the black, negative (-) cable from the battery to keep the battery from running down.

**Extended Storage:** Remove the black, negative (-) cable from the battery or use a battery trickle charger.

**All-Wheel Drive**

If the vehicle is equipped with All-Wheel-Drive (AWD), this is an additional system that needs lubrication.

**Transfer Case**

Under normal driving conditions, transfer case fluid does not require maintenance unless there is a fluid leak or unusual noise. If required, have the transfer case serviced by your dealer.

## Park Brake and P (Park) Mechanism Check

### Warning

When you are doing this check, the vehicle could begin to move. You or others could be injured and property could be damaged. Make sure there is room in front of the vehicle in case it begins to roll. Be ready to apply the regular brake at once should the vehicle begin to move.

Park on a fairly steep hill, with the vehicle facing downhill. Keeping your foot on the regular brake, set the parking brake.

- To check the parking brake's holding ability: With the engine running and the transmission in N (Neutral), slowly remove foot pressure from the regular brake pedal. Do this until the vehicle is held by the parking brake only.
- Automatic transmission vehicles only: To check the P (Park) mechanism's holding ability: With the engine running, shift to P (Park). Then release the parking brake followed by the regular brake.

Contact your dealer if service is required.

## Wiper Blade Replacement

### Caution

Allowing the wiper arm to touch the windshield when no wiper blade is installed could damage the windshield. Any damage that occurs would not be covered by the vehicle warranty. Do not allow the wiper arm to touch the windshield.

Windshield wiper blades should be inspected for wear or cracking.

It is a good idea to clean or replace the wiper blade assembly on a regular basis or when worn. For proper windshield wiper blade length and type, see your dealer.

To replace the wiper blade assembly:

1. Pull the windshield wiper assembly away from the windshield. The passenger side wiper arm has limited travel.

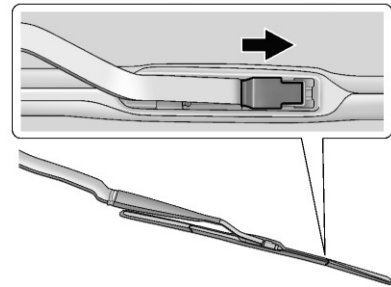

2. Lift up on the latch in the middle of the wiper blade where the wiper arm attaches.
3. With the latch open, pull the wiper blade down toward the windshield far enough to release it from the J-hooked end of the wiper arm.
4. Remove the wiper blade.
5. Reverse Steps 1–3 for wiper blade replacement.

## Windshield Replacement

### HUD System

The windshield is part of the HUD system. If the windshield needs to be replaced, a GM replacement windshield is recommended. The replacement windshield must be installed according to GM specifications for proper alignment. If it is not, the HUD image may look out of focus.

### Driver Assistance Systems

If the windshield needs to be replaced and the vehicle is equipped with a front camera sensor for the Driver Assistance Systems, a GM replacement windshield is recommended. The replacement windshield must be installed according to GM specifications for proper alignment. If it is not, these systems may not work properly, they may display messages, or they may not work at all. See your dealer for proper windshield replacement.

### Acoustic Windshield

The vehicle is equipped with an acoustic windshield. If the windshield needs to be replaced be sure to get an acoustic windshield so you will continue to have the benefits an acoustic windshield can provide.

### Gas Strut(s)

Your vehicle may be equipped with gas strut(s) to provide assistance in lifting and holding open the hood/trunk/liftgate system in full open position.

#### Warning

If the gas struts that hold open the hood, trunk, and/or liftgate fail, you or others could be seriously injured. Take the vehicle to your dealer for service immediately. Visually inspect the gas struts for signs of wear, cracks, or other damage periodically. Check to make sure the hood/trunk/liftgate is held open with enough force. If struts are failing to hold the hood/trunk/liftgate, do not operate. Have the vehicle serviced.

#### Caution

Do not apply tape or hang any objects from gas struts. Also do not push down or pull on gas struts. This may cause damage to the vehicle.



Hood

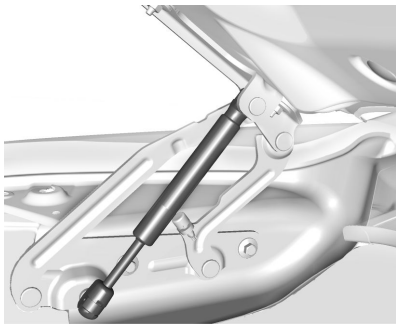

Trunk

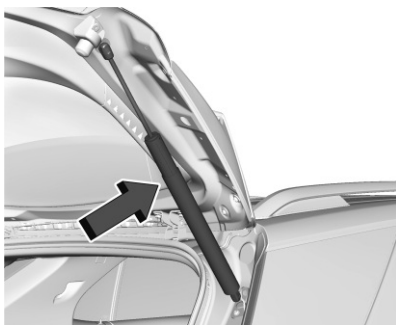

Liftgate

## Headlamp Aiming

### Front Headlamp Aiming

Headlamp aim has been preset and should need no further adjustment.

If the vehicle is damaged in a crash, the headlamp aim may be affected. If adjustment to the headlamps is necessary, see your dealer.

## Bulb Replacement

### LED Lighting

This vehicle is equipped with LED light sources for all exterior lamps.

The lamp assemblies do not contain any serviceable light sources (e.g., incandescent bulbs).

For replacement of any LED lighting assembly, contact your dealer.

## Electrical System

### Electrical System Overload

The vehicle has fuses and circuit breakers to protect against an electrical system overload.

When the current electrical load is too heavy, the circuit breaker opens and closes, protecting the circuit until the current load returns to normal or the problem is fixed. This greatly reduces the chance of circuit overload and fire caused by electrical problems.

Fuses and circuit breakers protect power devices in the vehicle.

If there is a problem on the road and a fuse needs to be replaced, the same amperage fuse can be borrowed. Choose some feature of the vehicle that is not needed to use and replace it as soon as possible.

To check a fuse, look at the band inside the fuse. If the band is broken or melted, replace the fuse. Be sure to replace a bad fuse with a fuse of the identical size and rating.

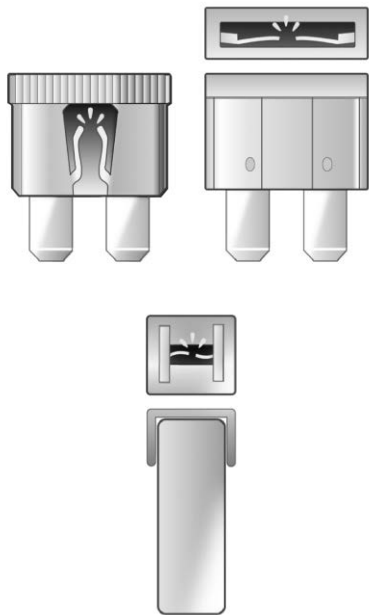

### Replacing a Blown Fuse

1. Turn off the ignition.

2. Locate the fuse puller in the engine compartment fuse block.

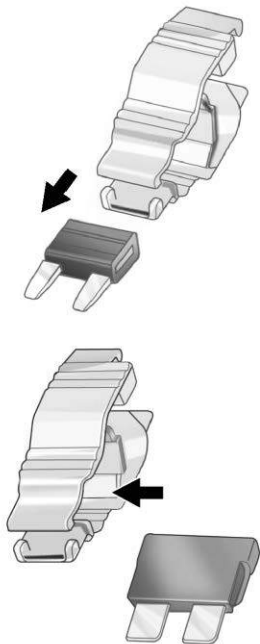

3. Use the fuse puller to remove the fuse from the top or side, as shown above.
4. If the fuse must be replaced immediately, borrow a replacement fuse with the same amperage from the fuse block. Choose a vehicle feature that is not needed to safely operate the vehicle. Repeat Steps 2-3.
5. Insert the replacement fuse into the empty slot of the blown fuse.

At the next opportunity, see your dealer to replace the blown fuse.

### Headlamp Wiring

An electrical overload may cause the lamps to go on and off, or in some cases to remain off. Have the headlamp wiring checked right away if the lamps go on and off or remain off.

### Windshield Wipers

If the wiper motor overheats due to heavy snow or ice, the windshield wipers will stop. Wiper function is available immediately after the wiper switch is set to off, and back to on.

To protect the wiper motor from overheating, the wipers may slow down when the windshield is dry for a long period of time. If a period of dry operation, or little moisture,

exceeds 10 minutes, the wipers may switch to intermittent operation, and remain there. When moisture is again detected on the windshield, wiper operation will return to the operator selected speed.

Although the circuit is protected from electrical overload, overload due to heavy snow or ice may cause wiper linkage damage. Always clear ice and heavy snow from the windshield before using the windshield wipers.

If the overload is caused by an electrical problem and not snow or ice, be sure to get it fixed.

## Fuses and Circuit Breakers

The wiring circuits in the vehicle are protected from short circuits by a combination of fuses and circuit breakers. This greatly reduces the chance of damage caused by electrical problems.

### Danger

Fuses and circuit breakers are marked with their ampere rating. Do not exceed the specified amperage rating when replacing

(Continued)

### Danger (Continued)

fuses and circuit breakers. Use of an oversized fuse or circuit breaker can result in a vehicle fire. You and others could be seriously injured or killed.



### Warning

Installation or use of fuses that do not meet GM's original fuse specifications is dangerous. The fuses could fail, and result in a fire. You or others could be injured or killed, and the vehicle could be damaged.

See *Accessories and Modifications* ⇨ 287 and *General Information* ⇨ 287.

To check or replace a blown fuse, see *Electrical System Overload* ⇨ 315.

## Engine Compartment Fuse Block

The engine compartment fuse block is on the driver side of the engine compartment.

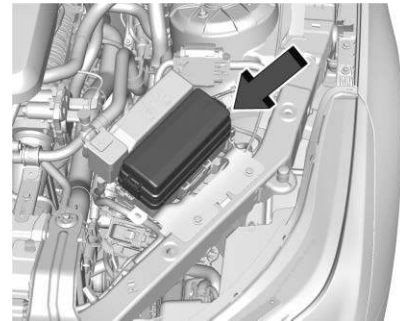

Lift the fuse block cover to access the fuses.

The vehicle may not be equipped with all of the fuses and relays shown.

### Caution

Spilling liquid on any electrical component on the vehicle may damage it. Always keep the covers on any electrical component.

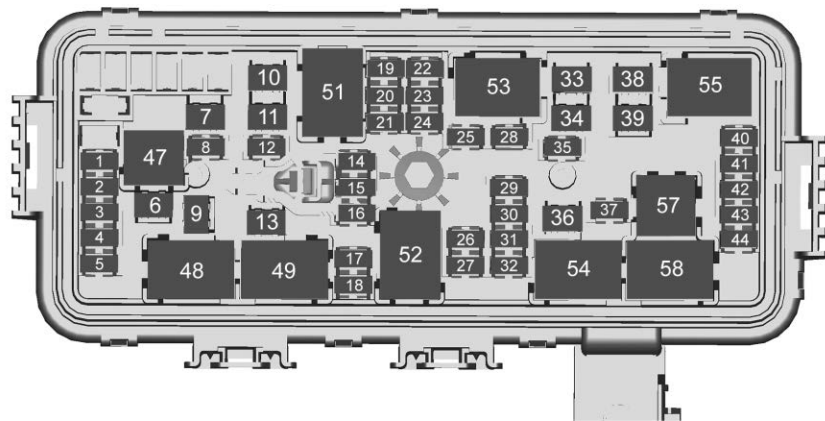

Fuses	Usage
1	Long Range Radar Front Sensor
2	Park/Daytime Running Lamps
3	Exterior Lighting Module 4
4	Exterior Lighting Module 7

Fuses	Usage
5	–
6	–
7	Electronic Brake Control Module

Fuses	Usage
8	Washer Pump
9	–
10	–
11	–
12	Horn
13	Front Wiper
14	–
15	Exterior Lighting Module 6
16	–
17	Exterior Lighting Module 1
18	Exterior Lighting Module 5
19	Exterior Lighting Module 3
20	Aero Shutter
21	–
22	–
23	–
24	–
25	–
26	–
27	–
28	–
29	–
30	–
31	–
32	–
33	–
34	–
35	–
36	–
37	–
38	–
39	–
40	–
41	–
42	–
43	–
44	–
45	–
46	–
47	–
48	–
49	–
50	–
51	–
52	–
53	–
54	–
55	–
56	–
57	–
58	–

Fuses	Usage
21	Virtual Key System/Power Sounder Module
22	Engine Control Module Battery
23	Transmission Control Module
24	Active Engine Mount
25	–
26	Engine Control Module
27	Injectors/Ignition 2
28	Charged Air Cooler/Not Used
29	Transmission Aux Oil Pump/Transmission Reverse Lock Out
30	Injectors/Ignition 1
31	Emissions 1
32	Emissions 2
33	Starter Solenoid

Fuses	Usage
34	–
35	–
36	Starter Pinion/Not Used
37	AC Clutch
38	–
39	–
40	–
41	–
42	Water Pump/Not Used
43	–
44	–
Relays	Usage
47	–
48	Front Wiper Speed/Not Used
49	Front Wiper Control

Relays	Usage
51	–
52	Engine Control Module
53	Starter Solenoid
54	Starter Pinion/Not Used
55	–
57	AC Clutch
58	–

### Instrument Panel Fuse Block

The instrument panel fuse block is in the end of the driver side of the instrument panel.



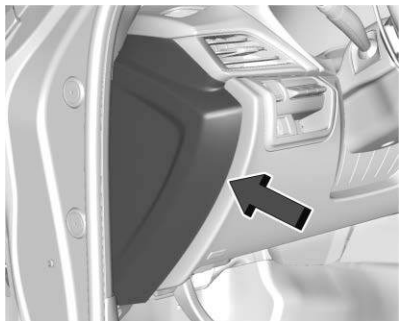

To access the fuses, remove the end panel by gently prying with a plastic tool near each clip, beginning at the point shown.

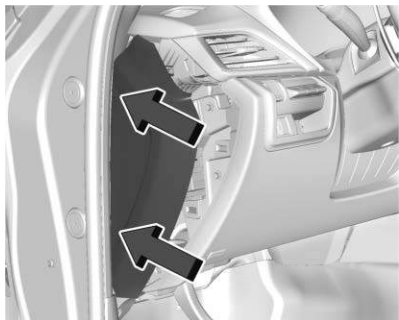

To install the end cover, insert the tabs on the back of the cover into the slots in the instrument panel at the points shown. Align the clips with the slots in the instrument panel, and press the cover into place.

The vehicle may not be equipped with all of the fuses and relays shown.

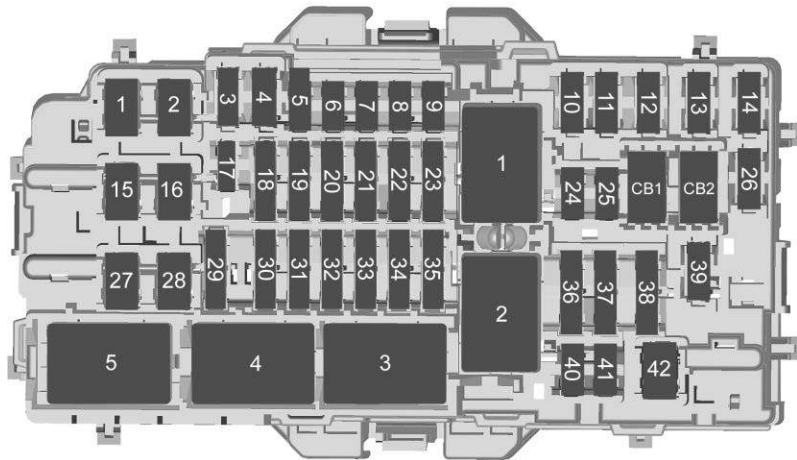

Fuses	Usage
1	-
2	Heating, Ventilation, and Air Conditioning Blower
3	-
4	-

Fuses	Usage
5	Theft Deterrent/Universal Garage Door Opener/Overhead Console/Rain Sensor
6	-
7	Air Quality Ionizer

Fuses	Usage
8	Heated Steering Wheel
9	-
10	Electronic Steering Column Lock 1
11	-
12	-
13	-
14	-
15	-
16	-
17	-
18	Display/Infotainment/USB/Multi-function Control Module

Fuses	Usage
19	Sensing and Diagnostic Module/Automatic Occupant Sensing/Data Link Connection/Wireless Charging Module/Virtual Key Module
20	Power Steering Column Module/Electronic Steering Column Lock 2
21	Driver Monitor System/Performance Data Recorder
22	–
23	–
24	–
25	USB
26	–
27	Headlamp LH
28	Headlamp RH
29	–

Fuses	Usage
30	–
31	Headlamp Level/Spare
32	–
33	Body Ignition/IP Ignition
34	Exhaust Valve
35	Transmission Control Module Ignition/Engine Control Module Ignition/Shift Ignition/Brake Ignition
36	Shift Module
37	Body Control Module 1/Electronic Park Brake Switch
38	Center Stack Module
39	Steering Wheel Controls
40	Body Control Module 2

Fuses	Usage
41	Body Control Module 3
42	Body Control Module 4

Circuit Breakers	Usage
CB1	Auxiliary Power Outlet 1
CB2	Auxiliary Power Outlet 2

Relays	Usage
1	Run After Park/Accessory
2	Run Crank
3	–
4	–
5	–

## Rear Compartment Fuse Block

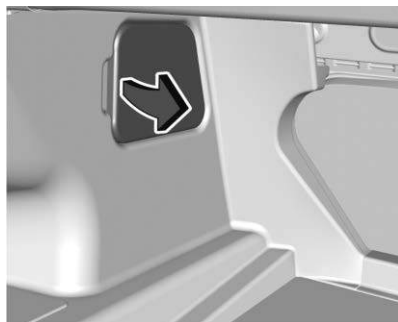

The rear compartment fuse block is behind a cover on the driver side of the rear compartment.

The vehicle may not be equipped with all of the fuses, relays, and features shown.



Fuses	Usage
1	Remote Function Actuator
2	–
3	Driver Heated Seat
4	Fuel Tank Zone Module
5	–
6	–
7	–
8	–
9	–
10	Motor Seat Belt Passenger
11	Canister Vent Solenoid
12	Sunroof
13	–
14	–
15	Passenger Heated Seat

Fuses	Usage	Fuses	Usage	Fuses	Usage
16	– Exterior Lighting Module 1	25	–	37	Passenger Memory Seat Module
17	Electronic Suspension Control	26	Amplifier (V- Series Blackwing)	38	– Amplifier
18	–	27	Rear Drive Control Module	39	Right Front/Right Rear Window
19	Motor Seat Belt Driver	28	–	40	–
20	Rear Defog	29	–	41	–
21	DC to DC Transformer 2	30	–	42	Amplifier
22	Driver Power Window/ Door Handle Switch	31	DC to DC Transformer 1	43	Park Assist Module
23	External Object Calculating Module/ Front Camera Module/ High Definition Localization Module/ Short Range Radar	32	Transfer Case Electronic Control	44	Driver Memory Seat Module
24	Passenger Power Window/Door Handle Switch	33	Central Gateway Module/ Side Blind Zone Alert	45	OnStar
		34	Video Processing Module	46	–
		35	Hands Free Closure Release	47	– Exterior Lighting Module 6
		36	Exterior Lighting Module 2	48	–

Fuses	Usage
49	–
50	Driver Seat
51	Left Front/Left Rear Window
52	Passenger Seat
Relays	Usage
53	–
54	–
55	Run

## Wheels and Tires

### Tires

Every new GM vehicle has high-quality tires made by a leading tire manufacturer. See the warranty manual for information regarding the tire warranty and where to get service. For additional information refer to the tire manufacturer.

### Warning

- Poorly maintained and improperly used tires are dangerous.
- Overloading the tires can cause overheating as a result of too much flexing. There could be a blowout and a serious crash. See *Vehicle Load Limits* ⇨ 187.
- Underinflated tires pose the same danger as overloaded tires. The resulting crash could cause serious injury. Check all tires frequently to maintain the recommended pressure. Tire pressure should be checked when the tires are cold.
- Overinflated tires are more likely to be cut, punctured, or broken by a sudden impact — such as when hitting a pothole. Keep tires at the recommended pressure.

(Continued)

### Warning (Continued)

- Worn or old tires can cause a crash. If the tread is badly worn, replace them.
- Replace any tires that have been damaged by impacts with potholes, curbs, etc.
- Improperly repaired tires can cause a crash. Only your dealer or an authorized tire service center should repair, replace, dismount, and mount the tires.
- Do not spin the tires in excess of 56 km/h (35 mph) on slippery surfaces such as snow, mud, ice, etc. Excessive spinning may cause the tires to explode.

See *Tire Pressure for High-Speed Operation* ⇨ 332 for inflation pressure adjustment for high-speed driving.

## All-Season Tires

This vehicle may come with all-season tires. These tires are designed to provide good overall performance on most road surfaces and weather conditions. Original equipment tires designed to GM's specific tire performance criteria have a TPC specification code molded onto the sidewall.

Consider installing winter tires on the vehicle if frequent driving on snow or ice-covered roads is expected. All-season tires provide adequate performance for most winter driving conditions, but they may not offer the same level of traction or performance as winter tires on snow or ice-covered roads. See *Winter Tires* ⇨ 326.

## Winter Tires

This vehicle was not originally equipped with winter tires. Winter tires are designed for increased traction on snow and ice-covered roads. Consider installing winter tires on the vehicle if frequent driving on ice or snow covered roads is expected. See your dealer for details regarding winter tire availability and proper tire selection. Also, see *Buying New Tires* ⇨ 339.

With winter tires, there may be decreased dry road traction, increased road noise, and shorter tread life. After changing to winter tires, be alert for changes in vehicle handling and braking.

If using winter tires:

- Use tires of the same brand and tread type on all four wheel positions.
- Use only radial ply tires of the same size, load range, and speed rating as the original equipment tires.

Winter tires with the same speed rating as the original equipment tires may not be available for H, V, W, Y, and ZR speed rated tires. If winter tires with a lower speed rating are chosen, never exceed the tire's maximum speed capability.

## Run-Flat Tires

This vehicle, when new, may have had run-flat tires. There is no spare tire, no tire changing equipment, and no place to store a tire in the vehicle.

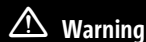

### Warning

While driving with run-flat tires at a reduced inflation pressure, avoid making sudden stops or severe maneuvers as the handling capabilities of the tires will be reduced. Driving too fast could cause loss of control and you or others could be injured. Do not drive over 80 km/h (50 mph) with the tire operating at low pressure. Drive cautiously and check the tire pressure as soon as possible.

Run-flat tires can be driven up to 80 km (50 mi) at speeds less than 80 km/h (50 mph) after a loss of inflation pressure has occurred. There is no need to stop on the side of the road to change the tire. The possible driving range after a pressure loss will vary based on the vehicle load and driving conditions. As soon as possible, contact the nearest authorized GM or run-flat servicing facility for inspection and repair or replacement.

When driving on a deflated run-flat tire, avoid potholes and other road hazards that could damage the tire and/or wheel beyond repair. When a tire has been damaged, or if driven any distance while deflated, check with

an authorized run-flat tire service center to determine whether the tire can be repaired or should be replaced. To maintain the run-flat feature, all replacement tires must be run-flat tires.

To locate the nearest GM or run-flat servicing facility, call Customer Assistance.

## Self-Sealing Tires

This vehicle may have self-sealing tires. These tires have a material inside that can seal punctures from common road hazards, such as nails and screws, in the tread area. The tire may lose air pressure if the sidewall is damaged or the tread puncture is too large. If the Tire Pressure Monitor System indicates the tire pressure is low, inspect the tire for damage and inflate it to the recommended pressure. If the tire is unable to maintain the recommended pressure, contact the nearest authorized GM servicing facility immediately for inspection and repair or replacement. To locate the nearest GM servicing facility, call GM Customer Assistance.

### Caution

Do not drive on a deflated self-sealing tire as this could damage the tire. Make sure the tire is inflated to the recommended pressure or have it immediately repaired or replaced.

When tire replacement is needed, replace with a self-sealing tire, because the vehicle does not come with a spare tire or tire changing equipment.

## Noise Reducing Tires (V-Series Blackwing Only)

This vehicle may be equipped with tires that have noise-absorbing foam technology to reduce road and interior noise levels.

To maintain overall vehicle performance, replace damaged or worn tires with Tire Performance Criteria Specification (TPC Spec) original equipment tires equipped with noise-absorbing foam. See *Buying New Tires* ↪ 339.

## Low-Profile Tires

If the vehicle has 245/45R18 96V, 245/40R19 94V, 245/40ZR19 94Y, 255/35ZR20 97W, 275/35ZR19 (100Y), or 305/30ZR19 (102Y) size tires, they are classified as low-profile tires.

### Caution

Low-profile tires are more susceptible to damage from road hazards or curb impact than standard profile tires. Tire and/or wheel assembly damage can occur when coming into contact with road hazards like potholes, or sharp edged objects, or when sliding into a curb. The warranty does not cover this type of damage. Keep tires set to the correct inflation pressure and when possible, avoid contact with curbs, potholes, and other road hazards.

## Summer Tires

### High Performance Summer Tires

This vehicle may come with 245/40ZR19 94Y, 275/35ZR19 (100Y), or 305/30ZR19 (102Y) high performance summer tires. These tires



have a special tread and compound that are optimized for maximum dry and wet road performance. This special tread and compound will have decreased performance in cold climates, and on ice and snow. It is recommended that winter tires be installed on the vehicle if frequent driving at temperatures below approximately 5 °C (40 °F) or on ice or snow covered roads is expected. See *Winter Tires* ⇨ 326.

### Caution

High performance summer tires have rubber compounds that lose flexibility and may develop surface cracks in the tread area at temperatures below -7 °C (20 °F). Always store high performance summer tires indoors and at temperatures above -7 °C (20 °F) when not in use. If the tires have been subjected to -7 °C (20 °F) or less, let them warm up in a heated space to at least 5 °C (40 °F) for 24 hours or more before being installed or driving a vehicle on which they are installed. Do not apply heat or blow heated air directly on the tires. Always inspect tires before use. See *Tire Inspection* ⇨ 337.

## Tire Sidewall Labeling

Useful information about a tire is molded into its sidewall. The example shows a typical passenger tire sidewall.

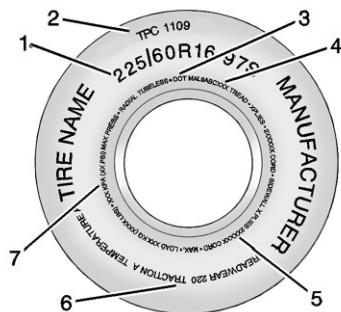

Passenger Tire Example

**(1) Tire Size :** The tire size is a combination of letters and numbers used to define a particular tire's width, height, aspect ratio, construction type, and service description. See the "Tire Size" illustration later in this section.

**(2) TPC Spec (Tire Performance Criteria Specification) :** Original equipment tires designed to GM's specific tire performance criteria have a TPC specification code molded onto the sidewall. GM's TPC specifications meet or exceed all federal safety guidelines.

**(3) DOT (Department of Transportation) :** The Department of Transportation (DOT) code indicates that the tire is in compliance with the U.S. Department of Transportation Motor Vehicle Safety Standards.

**DOT Tire Date of Manufacture :** The last four digits of the TIN indicate the tire manufactured date. The first two digits represent the week and the last two digits, the year. For example, the third week of the year 2020 would have a 4-digit DOT date of 0320. Week 01 is the first full week (Sunday through Saturday) of each year.

**(4) Tire Identification Number (TIN) :** The letters and numbers following the DOT code are the Tire Identification Number (TIN). The TIN shows the manufacturer and plant code, tire size, and date the tire

was manufactured. The TIN is molded onto both sides of the tire, although only one side may have the date of manufacture.

**(5) Tire Ply Material :** The type of cord and number of plies in the sidewall and under the tread.

**(6) Uniform Tire Quality Grading (UTQG) :** Tire manufacturers are required to grade tires based on three performance factors: treadwear, traction, and temperature resistance. For more information, see *Uniform Tire Quality Grading* ⇨ 341.

**(7) Maximum Cold Inflation Load Limit :** Maximum load that can be carried and the maximum pressure needed to support that load.

## Tire Designations

### Tire Size

The example shows a typical passenger vehicle tire size.

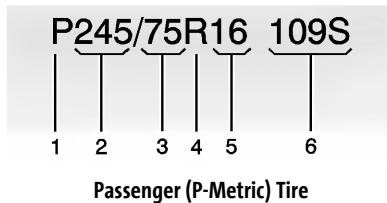

**(1) Passenger (P-Metric) Tire :** The United States version of a metric tire sizing system. The letter "P" as the first character in the tire size means a passenger vehicle tire engineered to standards set by the U.S. Tire and Rim Association.

**(2) Tire Width :** The 3-digit number indicates the tire section width in millimeters from sidewall to sidewall.

**(3) Aspect Ratio :** A 2-digit number that indicates the tire height-to-width measurements. For example, if the tire size aspect ratio is 75, as shown in item (3) of the illustration, it would mean that the tire's sidewall is 75 percent as high as it is wide.

**(4) Construction Code :** A letter code is used to indicate the type of ply construction in the tire. The letter "R" means radial ply construction; the letter "D" means diagonal or bias ply construction.

**(5) Rim Diameter :** Diameter of the wheel in inches.

**(6) Service Description :** These characters represent the load index and speed rating of the tire. The load index represents the load carrying capacity a tire is certified to carry. The speed rating is the maximum speed a tire is certified to carry a load.

## Tire Terminology and Definitions

**Air Pressure :** The amount of air inside the tire pressing outward on each square inch of the tire. Air pressure is expressed in kPa (kilopascal) or psi (pounds per square inch).

**Aspect Ratio :** The relationship of a tire's height to its width.

**Belt** : A rubber coated layer of cords that is located between the plies and the tread. Cords may be made from steel or other reinforcing materials.

**Bead** : The tire bead contains steel wires wrapped by steel cords that hold the tire onto the rim.

**Bias Ply Tire** : A pneumatic tire in which the plies are laid at alternate angles less than 90 degrees to the centerline of the tread.

**Cold Tire Pressure** : The amount of air pressure in a tire, measured in kPa (kilopascal) or psi (pounds per square inch) before a tire has built up heat from driving. See *Tire Pressure* ⇨ 331.

**DOT Markings** : A code molded into the sidewall of a tire signifying that the tire is in compliance with the U.S. Department of Transportation (DOT) Motor Vehicle Safety Standards. The DOT code includes the Tire Identification Number (TIN), an alphanumeric designator which can also identify the tire manufacturer, production plant, brand, and date of production.

**GVWR** : Gross Vehicle Weight Rating. See *Vehicle Load Limits* ⇨ 187.

**GAWR FRT** : Gross Axle Weight Rating for the front axle. See *Vehicle Load Limits* ⇨ 187.

**GAWR RR** : Gross Axle Weight Rating for the rear axle. See *Vehicle Load Limits* ⇨ 187.

**Intended Outboard Sidewall** : The side of an asymmetrical tire, that must always face outward when mounted on a vehicle.

**Kilopascal (kPa)** : The metric unit for air pressure.

**Light Truck (LT-Metric) Tire** : A tire used on light duty trucks and some multipurpose passenger vehicles.

**Load Index** : An assigned number ranging from 1 to 279 that corresponds to the load carrying capacity of a tire.

**Maximum Inflation Pressure** : The maximum air pressure to which a cold tire can be inflated. The maximum air pressure is molded onto the sidewall.

**Maximum Load Rating** : The load rating for a tire at the maximum permissible inflation pressure for that tire.

**Occupant Distribution** : Designated seating positions.

**Outward Facing Sidewall** : The side of an asymmetrical tire that has a particular side that faces outward when mounted on a vehicle. The side of the tire that contains a whitewall, bears white lettering, or bears manufacturer, brand, and/or model name molding that is higher or deeper than the same moldings on the other sidewall of the tire.

**Passenger (P-Metric) Tire** : A tire used on passenger cars and some light duty trucks and multipurpose vehicles.

**Recommended Inflation Pressure** : Vehicle manufacturer's recommended tire inflation pressure as shown on the tire placard. See *Tire Pressure* ⇨ 331 and *Vehicle Load Limits* ⇨ 187.

**Radial Ply Tire** : A pneumatic tire in which the ply cords that extend to the beads are laid at 90 degrees to the centerline of the tread.

**Rim** : A metal support for a tire and upon which the tire beads are seated.

**Sidewall** : The portion of a tire between the tread and the bead.

**Speed Rating** : An alphanumeric code assigned to a tire indicating the maximum speed at which a tire can operate.

**Traction** : The friction between the tire and the road surface. The amount of grip provided.

**Tread** : The portion of a tire that comes into contact with the road.

**Treadwear Indicators** : Narrow bands, sometimes called wear bars, that show across the tread of a tire when only 1.6 mm (1/16 in) of tread remains. See *When It Is Time for New Tires* ⇨ 338.

**UTQGS (Uniform Tire Quality Grading Standards)** : A tire information system that provides consumers with ratings for a tire's traction, temperature, and

treadwear. Ratings are determined by tire manufacturers using government testing procedures. The ratings are molded into the sidewall of the tire. See *Uniform Tire Quality Grading* ⇨ 341.

**Vehicle Capacity Weight** : The number of designated seating positions multiplied by 68 kg (150 lbs) plus the rated cargo load. See *Vehicle Load Limits* ⇨ 187.

**Vehicle Maximum Load on the Tire** : Load on an individual tire due to curb weight, accessory weight, occupant weight, and cargo weight.

**Vehicle Placard** : A label permanently attached to a vehicle showing the vehicle's capacity weight and the original equipment tire size and recommended inflation pressure. See "Tire and Loading Information Label" under *Vehicle Load Limits* ⇨ 187.

## Tire Pressure

Tires need the correct amount of air pressure to operate effectively.

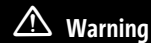

## Warning

Neither tire underinflation nor overinflation is good. Underinflated tires, or tires that do not have enough air, can result in:

- Tire overloading and overheating, which could lead to a blowout
- Premature or irregular wear
- Poor handling
- Reduced fuel economy for internal combustion engine vehicles
- Reduced range for electric vehicles

Overinflated tires, or tires that have too much air, can result in:

- Unusual wear
- Poor handling
- Rough ride
- Needless damage from road hazards

The Tire and Loading Information label on the vehicle indicates the original equipment tires and the correct cold tire inflation pressures. The recommended pressure is the minimum air pressure needed to support the vehicle's maximum load carrying capacity. See *Vehicle Load Limits* ⇨ 187.

How the vehicle is loaded affects vehicle handling and ride comfort. Never load the vehicle with more weight than it was designed to carry.

### When to Check

Check the pressure of the tires once a month or more.

### How to Check

Use a good quality pocket-type gauge to check tire pressure. Proper tire inflation cannot be determined by looking at the tire. Check the tire inflation pressure when the tires are cold, meaning the vehicle has not been driven for at least three hours or no more than 1.6 km (1 mi).

Remove the valve cap from the tire valve stem. Press the tire gauge firmly onto the valve to get a pressure measurement. If the cold tire inflation pressure matches the recommended pressure on the Tire and Loading Information label, no further adjustment is necessary. If the inflation pressure is low, add air until the recommended pressure is reached. If the inflation pressure is high, press on the metal stem in the center of the tire valve to release air.

Recheck the tire pressure with the tire gauge.

Put the valve caps back on the valve stems to keep out dirt and moisture. Use only valve caps designed for the vehicle by GM. TPMS sensors could be damaged and would not be covered by the vehicle warranty.

## Tire Pressure for High-Speed Operation

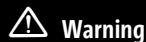

Driving at high speeds, 160 km/h (100 mph) or higher, puts additional strain on tires. Sustained high-speed driving causes excessive heat buildup and can cause sudden tire failure. This could cause a crash, and you or others could be killed. Some high-speed rated tires require inflation pressure adjustment for high-speed operation. When speed limits and road conditions allow the vehicle to be driven at high speeds, make sure the tires are rated for high-speed operation, are in excellent condition, and are set to the correct cold tire inflation pressure for the vehicle load.

Vehicles with tire sizes listed in the High Speed Operation Inflation Pressures table require inflation pressure adjustment when driving the vehicle at speeds of 160 km/h (100 mph) or higher. Set the cold tire inflation pressure to the corresponding value in the table for the tire size on the vehicle.

High Speed Operation Inflation Pressures	
Tire Size	Cold Inflation Pressure kPa (psi)
275/35ZR19 (100Y)	280 kPa (41 psi) Front
305/30ZR19 (102Y)	290 kPa (42 psi) Rear
245/40ZR19 94Y	300 kPa (44 psi)
245/40R19 94V	280 kPa (41 psi)
245/45R18 96V	280 kPa (41 psi)
255/35ZR20 97W	330 kPa (48 psi)

Return the tires to the recommended cold tire inflation pressure when high-speed driving has ended. See *Vehicle Load Limits* ⇨ 187 and *Tire Pressure* ⇨ 331.

## Tire Pressure Monitor System

The Tire Pressure Monitor System (TPMS) uses radio and sensor technology to check tire pressure levels. The TPMS sensors monitor the air pressure in your tires and transmit tire pressure readings to a receiver located in the vehicle.

Each tire, including the spare (if provided), should be checked monthly when cold and inflated to the inflation pressure recommended by the vehicle manufacturer on the vehicle placard or tire inflation pressure label. (If your vehicle has tires of a different size than the size indicated on the vehicle placard

or tire inflation pressure label, you should determine the proper tire inflation pressure for those tires.)

As an added safety feature, your vehicle has been equipped with a tire pressure monitoring system (TPMS) that illuminates a low tire pressure telltale when one or more of your tires is significantly under-inflated.

Accordingly, when the low tire pressure telltale illuminates, you should stop and check your tires as soon as possible, and inflate them to the proper pressure. Driving on a significantly under-inflated tire causes the tire to overheat and can lead to tire failure. Under-inflation also reduces energy efficiency and tire tread life, and may affect the vehicle's handling and stopping ability.

Please note that the TPMS is not a substitute for proper tire maintenance, and it is the driver's responsibility to maintain correct tire pressure, even if under-inflation has not reached the level to trigger illumination of the TPMS low tire pressure telltale.

Your vehicle has also been equipped with a TPMS malfunction indicator to indicate when the system is not operating properly. The TPMS malfunction indicator is combined with the low tire pressure telltale. When the system detects a malfunction, the telltale will flash for approximately one minute and then remain continuously illuminated. This sequence will continue upon subsequent vehicle start-ups as long as the malfunction exists.

When the malfunction indicator is illuminated, the system may not be able to detect or signal low tire pressure as intended.

TPMS malfunctions may occur for a variety of reasons, including the installation of replacement or alternate tires or wheels on the vehicle that prevent the TPMS from functioning properly. Always check the TPMS malfunction telltale after replacing one or more tires or wheels on your vehicle to ensure that the replacement or alternate tires and wheels allow the TPMS to continue to function properly.

See *Tire Pressure Monitor Operation* ⇨ 334.

See *Radio Frequency Statement* ⇨ 387.

## Tire Pressure Monitor Operation

This vehicle may have a Tire Pressure Monitor System (TPMS). The TPMS is designed to warn the driver when a low tire pressure condition exists. TPMS sensors are mounted onto each tire and wheel assembly, excluding the spare tire and wheel assembly. The TPMS sensors monitor the air pressure in the tires and transmit the tire pressure readings to a receiver located in the vehicle.



When a low tire pressure condition is detected, the TPMS illuminates the low tire pressure warning light located on the instrument cluster. If the warning light comes on, stop as soon as possible and inflate the tires to the recommended pressure shown on the Tire and Loading Information label. See *Vehicle Load Limits* ⇨ 187.

A message to check the pressure in a specific tire displays in the Driver Information Center (DIC). The low tire pressure warning light and the DIC warning message come on each time the vehicle is started until the tires are inflated to the correct inflation pressure. If the vehicle has DIC buttons, tire pressure levels can be viewed. For additional information and details about the DIC operation and displays, see *Driver Information Center (DIC)* ⇨ 111.

The low tire pressure warning light may come on in cool weather when the vehicle is first started, and then turn off as the vehicle is

driven. This could be an early indicator that the air pressure is getting low and needs to be inflated to the proper pressure.

A Tire and Loading Information label shows the size of the original equipment tires and the correct inflation pressure for the tires when they are cold. See *Vehicle Load Limits* ⇨ 187, for an example of the Tire and Loading Information label and its location. Also see *Tire Pressure* ⇨ 337.

The TPMS can warn about a low tire pressure condition but it does not replace normal tire maintenance. See *Tire Inspection* ⇨ 337, *Tire Rotation* ⇨ 337, and *Tires* ⇨ 325.

### Caution

Tire sealant materials are not all the same. A non-approved tire sealant could damage the TPMS sensors. TPMS sensor damage caused by using an incorrect tire sealant is not covered by the vehicle warranty. Always use only the GM approved tire sealant available through your dealer or included in the vehicle.

### TPMS Malfunction Light and Message

The TPMS will not function properly if one or more of the TPMS sensors are missing or inoperable. When the system detects a malfunction, the low tire pressure warning light flashes for about one minute and then stays on for the remainder of the time the vehicle is on. A DIC warning message also displays. The malfunction light and DIC warning message will come on each time the vehicle is turned on until the problem is corrected. Some of the conditions that can cause these to come on are:

- One of the road tires has been replaced with the spare tire. The spare tire does not have a TPMS sensor. The malfunction light and the DIC message should go off after the road tire is replaced and the sensor matching process is performed successfully. See "TPMS Sensor Matching Process — Auto Learn Function" later in this section.
- The TPMS sensor matching process was not done or not completed successfully after rotating the tires. The malfunction light and the DIC message should go off after successfully completing the sensor

matching process. See "TPMS Sensor Matching Process — Auto Learn Function" later in this section.

- One or more TPMS sensors are missing or damaged. The malfunction light and the DIC message should go off when the TPMS sensors are installed and the sensor matching process is performed successfully. See your dealer for service.
- Replacement tires or wheels do not match the original equipment tires or wheels. Tires and wheels other than those recommended could prevent the TPMS from functioning properly. See *Buying New Tires* ⇨ 339.
- Operating electronic devices or being near facilities using radio wave frequencies similar to the TPMS could cause the TPMS sensors to malfunction.

If the TPMS is not functioning properly, it cannot detect or signal a low tire pressure condition. See your dealer for service if the TPMS malfunction light and DIC message come on and stay on.



### Tire Fill Alert (If Equipped)

This feature provides visual and audible alerts outside the vehicle to help when inflating an underinflated tire to the recommended cold tire pressure.

When the low tire pressure warning light comes on:

1. Park the vehicle in a safe, level place.
2. Set the parking brake firmly.
3. Place the vehicle in P (Park).
4. Add air to the tire that is underinflated. The turn signal lamp will flash.

When the recommended pressure is reached, the horn sounds once and the turn signal lamp will stop flashing and briefly turn solid.

Repeat these steps for all underinflated tires that have illuminated the low tire pressure warning light.

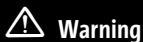

#### Warning

Overinflating a tire could cause the tire to rupture and you or others could be injured. Do not exceed the maximum pressure listed on the tire sidewall. See *Tire Sidewall Labeling* ⇨ 328 and *Vehicle Load Limits* ⇨ 187.

If the tire is overinflated by more than 35 kPa (5 psi), the horn will sound multiple times and the turn signal lamp will continue to flash for several seconds after filling stops. To release and correct the pressure, while the turn signal lamp is still flashing, briefly press the center of the valve stem. When the recommended pressure is reached, the horn sounds once.

If the turn signal lamp does not flash within 15 seconds after starting to inflate the tire, the tire fill alert has not been activated or is not working.

If the hazard warning flashers are on, the tire fill alert visual feedback will not work properly.

The TPMS will not activate the tire fill alert properly under the following conditions:

- There is interference from an external device or transmitter.

- The air pressure from the inflation device is not sufficient to inflate the tire.
- There is a malfunction in the TPMS.
- There is a malfunction in the horn or turn signal lamps.
- The TPMS sensor identification code is not registered to the system.
- The TPMS sensor battery is low.

If the tire fill alert does not operate due to TPMS interference, move the vehicle about 1 m (3 ft) back or forward and try again. If the tire fill alert feature is not working, use a tire pressure gauge.

### TPMS Sensor Matching Process — Auto Learn Function

Each TPMS sensor has a unique identification code. The identification code needs to be matched to a new tire/wheel position after rotating the tires or replacing one or more of the TPMS sensors. When a tire is installed, the vehicle must be stationary for about 20 minutes before the system recalculates. The following relearn process takes up to 10 minutes, driving at a minimum speed of 20 km/h (12 mph). A dash (-) or pressure value will display in the DIC. See *Driver Information*

Center (DIC) ⇨ 111. A warning message displays in the DIC if a problem occurs during the relearn process.

## Tire Inspection

We recommend that the tires, including the spare tire, if the vehicle has one, be inspected for signs of wear or damage at least once a month.

Replace the tire if:

- The indicators at three or more places around the tire can be seen.
- There is cord or fabric showing through the tire's rubber.
- The tread or sidewall is cracked, cut, or snagged deep enough to show cord or fabric.
- The tire has a bump, bulge, or split.
- The tire has a puncture, cut, or other damage that cannot be repaired well because of the size or location of the damage.

## Tire Rotation

Tires should be rotated according to the interval specified in the Maintenance Schedule. See *Maintenance Schedule* ⇨ 365.

Tires are rotated to achieve a uniform wear for all tires. The first rotation is the most important.

Anytime unusual wear is noticed, rotate the tires as soon as possible, check for proper tire inflation pressure, and check for damaged tires or wheels. If the unusual wear continues after the rotation, check the wheel alignment. See *When It Is Time for New Tires* ⇨ 338 and *Wheel Replacement* ⇨ 342.

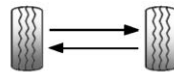
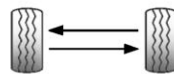

Use this rotation pattern if the vehicle has different size tires on the front and rear. Different tire sizes should not be rotated front to rear.

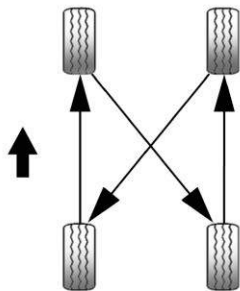

Use this rotation pattern when rotating tires of the same size installed on all four wheel positions.

Adjust the front and rear tires to the recommended inflation pressure on the Tire and Loading Information label after the tires have been rotated. See *Tire Pressure* ⇨ 331 and *Vehicle Load Limits* ⇨ 187.

Reset the Tire Pressure Monitor System. See *Tire Pressure Monitor Operation* ⇨ 334.

Check that all wheel nuts are properly tightened. See “Wheel Nut Torque” under *Capacities and Specifications* ⇨ 375.

### Warning

Rust or dirt on a wheel, or on the parts to which it is fastened, can cause wheel nuts to become loose over time. The wheel could come off and cause a crash. When changing a wheel, remove any rust or dirt from places where the wheel attaches to the vehicle. In an emergency, a cloth or paper towel can be used; however, use a scraper or wire brush later to remove all rust or dirt.

Lightly coat the center of the wheel hub with wheel bearing grease after a wheel change or tire rotation to prevent corrosion or rust build-up.

### Warning

Do not apply grease to the wheel mounting surface, wheel conical seats, or the wheel nuts or bolts. Grease applied to these areas could cause a wheel to become loose or come off, resulting in a crash.

## When It Is Time for New Tires

Factors, such as maintenance, temperatures, driving speeds, vehicle loading, and road conditions affect the wear rate of the tires.

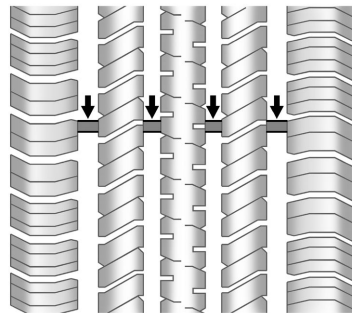

Treadwear indicators are one way to tell when it is time for new tires. Treadwear indicators appear when the tires have only 1.6 mm (1/16 in) or less of tread remaining. See *Tire Inspection* ⇨ 337 and *Tire Rotation* ⇨ 337.

The rubber in tires ages over time. This also applies to the spare tire, if the vehicle has one, even if it is never used. Multiple factors including temperatures, loading conditions, and inflation pressure maintenance affect how fast aging takes place. GM recommends

that tires, including the spare if equipped, be replaced after six years, regardless of tread wear. To identify the age of a tire, use the tire manufacture date, which is the last four digits of the DOT Tire Identification Number (TIN) molded into one side of the tire sidewall. The last four digits of the TIN indicate the tire manufactured date. The first two digits represent the week and the last two digits, the year. For example, the third week of the year 2020 would have a 4-digit DOT date of 0320. Week 01 is the first full week (Sunday through Saturday) of each year.

### Vehicle Storage

Tires age when stored normally mounted on a parked vehicle. Park a vehicle that will be stored for at least a month in a cool, dry, clean area away from direct sunlight to slow aging. This area should be free of grease, gasoline, or other substances that can deteriorate rubber.

Parking for an extended period can cause flat spots on the tires that may result in vibrations while driving. When storing a vehicle for at least a month, remove the tires or raise the vehicle to reduce the weight from the tires.

### Buying New Tires

GM has developed and matched specific tires for the vehicle. The original equipment tires installed were designed to meet General Motors Tire Performance Criteria Specification (TPC Spec) system rating. When replacement tires are needed, GM strongly recommends buying tires with the same TPC Spec rating.

GM's exclusive TPC Spec system considers over a dozen critical specifications that impact the overall performance of the vehicle, including brake system performance, ride and handling, traction control, and tire pressure monitoring performance. GM's TPC Spec number is molded onto the tire's sidewall near the tire size.

GM recommends replacing worn tires in complete sets of four. Uniform tread depth on all tires will help to maintain the performance of the vehicle. Braking and handling performance may be adversely affected if all the tires are not replaced at the same time. If proper rotation and

maintenance have been done, all four tires should wear out at about the same time. However, if it is necessary to replace only one axle set of worn tires, place the new tires on the rear axle. See *Tire Rotation* ⇨ 337.

#### Warning

Tires could explode during improper service. Attempting to mount or dismount a tire could cause injury or death. Only your dealer or authorized tire service center should mount or dismount the tires.

#### Warning

Mixing tires of different sizes (other than those originally installed on the vehicle), brands, tread patterns, or types may cause loss of vehicle control, resulting in a crash or other vehicle damage. Use the correct size, brand, and type of tire on all wheels.

 **Warning**

Using bias-ply tires on the vehicle may cause the wheel rim flanges to develop cracks after many miles of driving. A tire and/or wheel could fail suddenly and cause a crash. Use only radial-ply tires with the wheels on the vehicle.

Winter tires with the same speed rating as the original equipment tires may not be available for H, V, W, Y and ZR speed rated tires. Never exceed the winter tires' maximum speed capability when using winter tires with a lower speed rating.

If the vehicle tires must be replaced with a tire that does not have a TPC Spec number, make sure they are the same size, load range, speed rating, and construction (radial) as the original tires.

The Tire and Loading Information label indicates the original equipment tires on the vehicle. See *Vehicle Load Limits* ⇨ 187.

## Reverse Rim Wheels



This vehicle may be equipped with Reverse Rim Wheels. Reverse Rim Wheels can be identified by the logo on the rim near the service valve, as shown.

 **Warning**

Reverse Rim Wheels must be mounted to tires using specialized service equipment by your GM Dealer or qualified tire service center. Servicing Reverse Rim Wheels incorrectly can damage the tire, wheel, and vehicle, which could result in a crash causing severe injury or death. Do not attempt to service Reverse Rim Wheels yourself, see your dealer for service.

 **Warning**

Tires could explode during improper service. Attempting to mount or dismount a tire could cause injury or death. Only your dealer or authorized tire service center should mount or dismount the tires.

## Different Size Tires and Wheels

 **Warning**

If different sized wheels are used, there may not be an acceptable level of performance and safety if tires not recommended for those wheels are selected. This increases the chance of a crash and serious injury. Only use GM specific wheel and tire systems developed for the vehicle, and have them properly installed by a GM certified technician.

If wheels or tires are installed that are a different size than the original equipment wheels and tires, vehicle performance, including its braking, ride and handling

characteristics, stability, and resistance to rollover may be affected. If the vehicle has electronic systems such as antilock brakes, rollover airbags, traction control, electronic stability control, or All-Wheel Drive (AWD), the performance of these systems can also be affected.

See *Buying New Tires* ⇨ 339 and *Accessories and Modifications* ⇨ 287.

## Uniform Tire Quality Grading

The following information relates to the system developed by the United States National Highway Traffic Safety Administration (NHTSA), which grades tires by treadwear, traction, and temperature performance. This applies only to vehicles sold in the United States. The grades are molded on the sidewalls of most passenger car tires. The Uniform Tire Quality Grading (UTQG) system does not apply to deep tread, winter tires, compact spare tires, tires with nominal rim diameters of 10 to 12 inches (25 to 30 cm), or to some limited-production tires.

While the tires available on General Motors passenger cars and light trucks may vary with respect to these grades, they must also conform to federal safety requirements and additional General Motors Tire Performance Criteria (TPC) standards.

Quality grades can be found where applicable on the tire sidewall between tread shoulder and maximum section width. For example:

**Treadwear 200 Traction AA Temperature A**  
All Passenger Car Tires Must Conform to Federal Safety Requirements In Addition To These Grades.

### Treadwear

The treadwear grade is a comparative rating based on the wear rate of the tire when tested under controlled conditions on a specified government test course. For example, a tire graded 150 would wear one and one-half (1½) times as well on the government course as a tire graded 100. The relative performance of tires depends

upon the actual conditions of their use, however, and may depart significantly from the norm due to variations in driving habits, service practices and differences in road characteristics and climate.

### Traction

The traction grades, from highest to lowest, are AA, A, B, and C. Those grades represent the tire's ability to stop on wet pavement as measured under controlled conditions on specified government test surfaces of asphalt and concrete. A tire marked C may have poor traction performance. Warning: The traction grade assigned to this tire is based on straight-ahead braking traction tests, and does not include acceleration, cornering, hydroplaning, or peak traction characteristics.

### Temperature

The temperature grades are A (the highest), B, and C, representing the tire's resistance to the generation of heat and its ability to dissipate heat when tested

under controlled conditions on a specified indoor laboratory test wheel. Sustained high temperature can cause the material of the tire to degenerate and reduce tire life, and excessive temperature can lead to sudden tire failure. The grade C corresponds to a level of performance which all passenger car tires must meet under the Federal Motor Safety Standard No. 109. Grades B and A represent higher levels of performance on the laboratory test wheel than the minimum required by law. **Warning:** The temperature grade for this tire is established for a tire that is properly inflated and not overloaded. Excessive speed, underinflation, or excessive loading, either separately or in combination, can cause heat buildup and possible tire failure.

## Wheel Alignment and Tire Balance

The tires and wheels were aligned and balanced at the factory to provide the longest tire life and best overall performance. Adjustments to wheel alignment and tire balancing are not

necessary on a regular basis. The vehicle's precise steering and handling make it very responsive to road surface feedback. A slight pull may be felt in the steering depending on the crown of the road and/or other road surface variations such as troughs or ruts. This is normal and the vehicle does not require service. Consider an alignment check if there is unusual tire wear or the vehicle is significantly pulling to one side or the other.

## Wheel Replacement

Replace any wheel that is bent, cracked, or badly rusted or corroded. If wheel nuts keep coming loose, the wheel, wheel bolts, and wheel nuts should be replaced. If the wheel leaks air, replace it. Some aluminum wheels can be repaired. See your dealer if any of these conditions exist.

Your dealer will know the kind of wheel that is needed.

Each new wheel should have the same load-carrying capacity, diameter, width, offset, and be mounted the same way as the one it replaces.

Replace wheels, wheel bolts, wheel nuts, or Tire Pressure Monitor System (TPMS) sensors with new GM original equipment parts.

### Warning

Using the wrong replacement wheels, wheel bolts, or wheel nuts can be dangerous. It could affect the braking and handling of the vehicle. Tires can lose air and cause loss of control, resulting in a crash. Always use the correct wheel, wheel bolts, and wheel nuts for replacement.

### Warning

Replacing a wheel with a used one is dangerous. How it has been used or how far it has been driven may be unknown. It could fail suddenly and cause a crash. When replacing wheels, use a new GM original equipment wheel.

**Caution**

The wrong wheel can also cause problems with bearing life, brake cooling, speedometer or odometer calibration, headlamp aim, bumper height, vehicle ground clearance, and tire or tire chain clearance to the body and chassis.

**Tire Traction Devices** **Warning**

Do not use tire chains. There is not enough clearance. Tire chains used on a vehicle without the proper amount of clearance can cause damage to the brakes, suspension, or other vehicle parts. The area damaged by the tire chains could cause loss of control and a crash.

Use another type of traction device only if its manufacturer recommends it for the vehicle's tire size combination and road conditions. Follow that manufacturer's instructions. To avoid vehicle damage, drive slowly and readjust or remove the traction

(Continued)

**Warning (Continued)**

device if it contacts the vehicle. Do not spin the wheels. If traction devices are used, install them on the tires of the drive axle only.

**If a Tire Goes Flat**

It is unusual for a tire to blow out while driving, especially if the tires are maintained properly. It is much more likely for a tire to experience a slow leak. See *Tires* ⇨ 325.

In the event of a blowout, follow these tips:

- A front tire blowout causes the vehicle to pull toward the side of the flat. Take your foot off the accelerator pedal and grip the steering wheel firmly. Steer to maintain lane position, and then gently brake to a stop.
- A rear blowout, particularly on a curve, acts much like a skid and may require the same correction as used in a skid. Stop pressing the accelerator pedal and steer to straighten the vehicle. It may be very bumpy and noisy. Gently brake to a stop.

The vehicle has no spare tire, no tire changing equipment, and no place to store a tire.

If the vehicle has run-flat tires, there is no need to stop on the side of the road to change a flat tire. See *Run-Flat Tires* ⇨ 326.

If the vehicle has self-sealing tires, see *Self-Sealing Tires* ⇨ 327. Tread punctures typically will not cause tires to lose air. However, if the vehicle does get a flat tire, there is no spare tire, tire changing equipment, or place to store a tire. Contact Roadside Assistance for help.

 **Warning**

Driving on a flat tire will cause permanent damage to the tire. Re-inflating a tire after it has been driven on while severely underinflated or flat may cause a blowout and a serious crash. Never attempt to re-inflate a tire that has been driven on while severely underinflated or flat. Have your dealer or an authorized tire service center repair or replace the flat tire as soon as possible.



 **Warning**

Special tools and procedures are required to service a run-flat tire. If these special tools and procedures are not used, injury or vehicle damage may occur. Always be sure the proper tools and procedures, as described in the service manual, are used.

If a tire goes flat, avoid further tire and wheel damage by driving slowly to a level place, well off the road, if possible. Turn on the hazard warning flashers. See *Hazard Warning Flashers* ⇨ 128.

This vehicle may come with a tire sealant and compressor kit. To use the tire sealant and compressor kit, see *Tire Sealant and Compressor Kit* ⇨ 344.

## Tire Sealant and Compressor Kit

 **Warning**

Idling a vehicle in an enclosed area with poor ventilation is dangerous. Engine exhaust may enter the vehicle. Engine

(Continued)

### Warning (Continued)

exhaust contains carbon monoxide (CO) which cannot be seen or smelled. It can cause unconsciousness and even death. Never run the engine in an enclosed area that has no fresh air ventilation. For more information, see *Engine Exhaust* ⇨ 199.

 **Warning**

Overinflating a tire could cause the tire to rupture and you or others could be injured. Be sure to read and follow the tire sealant and compressor kit instructions and inflate the tire to its recommended pressure. Do not exceed the recommended pressure.

 **Warning**

Storing the tire sealant and compressor kit or other equipment in the passenger compartment of the vehicle could cause injury. In a sudden stop or collision, loose

(Continued)

### Warning (Continued)

equipment could strike someone. Store the tire sealant and compressor kit in its original location.

If this vehicle has a tire sealant and compressor kit, there may not be a spare tire or tire changing equipment, and on some vehicles there may not be a place to store a tire.

The tire sealant and compressor can be used to temporarily seal punctures up to 6 mm (0.25 in) in the tread area of the tire. It can also be used to inflate an underinflated tire.

If the vehicle is equipped with tires containing acoustic foam, tire sealant performance may be decreased in cold climates.

If the tire has been separated from the wheel, has damaged sidewalls, or has a large puncture, the tire is too severely damaged for the tire sealant and compressor kit to be effective. See *Roadside Assistance Program* ⇨ 382.

Read and follow all of the tire sealant and compressor kit instructions.

The kit includes:

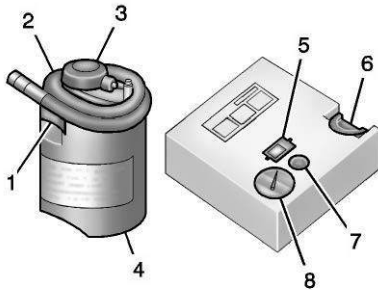

1. Sealant Canister Inlet Valve
2. Sealant/Air Hose
3. Base of Sealant Canister
4. Tire Sealant Canister
5. On/Off Button
6. Slot on Top of Compressor
7. Pressure Deflation Button
8. Pressure Gauge

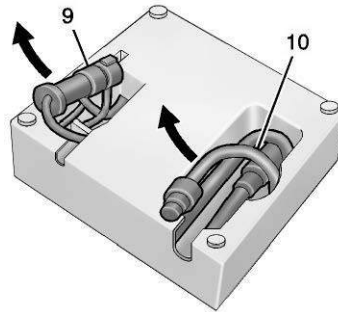

9. Power Plug
10. Air Only Hose

### Tire Sealant

Read and follow the safe handling instructions on the label adhered to the tire sealant canister (4).

Check the tire sealant expiration date on the tire sealant canister. The tire sealant canister (4) should be replaced before its expiration date. Replacement tire sealant canisters are available at your local dealer.

There is only enough sealant to seal one tire. After usage, the tire sealant canister must be replaced.

### Using the Tire Sealant and Compressor Kit to Temporarily Seal and Inflate a Punctured Tire

When using the tire sealant and compressor kit during cold temperatures, warm the kit in a heated environment for five minutes. This will help to inflate the tire faster.

If a tire goes flat, avoid further tire and wheel damage by driving slowly to a level place. Turn on the hazard warning flashers. See *Hazard Warning Flashers* ⇨ 128.

See *If a Tire Goes Flat* ⇨ 343 for other important safety warnings.

Do not remove any objects that have penetrated the tire.

1. Remove the tire sealant canister (4) and compressor from its storage location. See *Storing the Tire Sealant and Compressor Kit* ⇨ 349.
2. Remove the air only hose (10) and the power plug (9) from the bottom of the compressor.
3. Place the compressor on the ground near the flat tire.

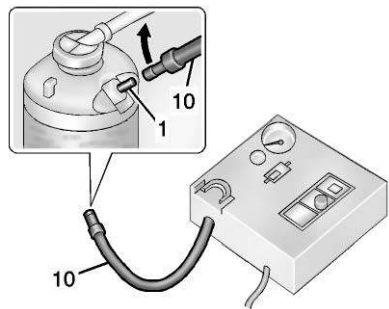

4. Attach the air only hose (10) to the sealant canister inlet valve (1) by turning it clockwise until tight.

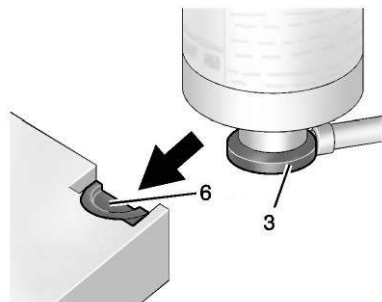

5. Slide the base of the tire sealant canister (3) into the slot on the top of the compressor (6) to hold it upright.

Make sure the tire valve stem is positioned close to the ground so the hose will reach it.

6. Remove the valve stem cap from the flat tire by turning it counterclockwise.

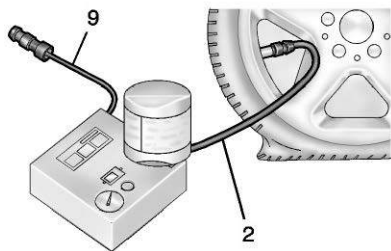

7. Attach the sealant/air hose (2) to the tire valve stem by turning it clockwise until tight.
8. Plug the power plug (9) into the accessory power outlet in the vehicle. Unplug all items from other accessory power outlets. See *Power Outlets* ⇨ 88.

If the vehicle has an accessory power outlet, do not use the cigarette lighter.

If the vehicle only has a cigarette lighter, use the cigarette lighter.

Do not pinch the power plug cord in the door or window.

9. Start the vehicle. The vehicle must be running while using the air compressor.
10. Press the on/off button (5) to turn the tire sealant and compressor kit on.

The compressor will inject sealant and air into the tire.

The pressure gauge (8) will initially show a high pressure while the compressor pushes the sealant into the tire. Once the sealant is completely dispersed into the tire, the pressure will quickly drop and start to rise again as the tire inflates with air only.

11. Inflate the tire to the recommended inflation pressure using the pressure gauge (8). The recommended inflation pressure can be found on the Tire and Loading Information label. See *Tire Pressure* ⇨ 331.
- The pressure gauge (8) may read higher than the actual tire pressure while the compressor is on. Turn the compressor off

to get an accurate pressure reading. The compressor may be turned on/off until the correct pressure is reached.

### Caution

If the recommended pressure cannot be reached after approximately 25 minutes, the vehicle should not be driven farther. The tire is too severely damaged and the tire sealant and compressor kit cannot inflate the tire. Remove the power plug from the accessory power outlet and unscrew the inflating hose from the tire valve. See *Roadside Assistance Program* ⇨ 382.

12. Press the on/off button (5) to turn the tire sealant and compressor kit off.

The tire is not sealed and will continue to leak air until the vehicle is driven and the sealant is distributed in the tire. Therefore, Steps 13–21 must be done immediately after Step 12.

Be careful while handling the tire sealant and compressor kit as it could be warm after usage.

13. Unplug the power plug (9) from the accessory power outlet in the vehicle.

14. Turn the sealant/air hose (2) counterclockwise to remove it from the tire valve stem.
15. Replace the tire valve stem cap.
16. Remove the tire sealant canister (4) from the slot on top of the compressor (6).
17. Turn the air only hose (10) counterclockwise to remove it from the tire sealant canister inlet valve (1).
18. Turn the sealant/air hose (2) clockwise onto the sealant canister inlet valve (1) to prevent sealant leakage.
19. Return the air only hose (10) and power plug (9) back to their original storage location.



20. If the flat tire was able to inflate to the recommended inflation pressure, remove the maximum speed label from the sealant canister and place it in a highly visible location.

Do not exceed the speed on this label until the damaged tire is repaired or replaced.

21. Return the equipment to its original storage location in the vehicle.
22. Immediately drive the vehicle 8 km (5 mi) to distribute the sealant in the tire.
23. Stop at a safe location and check the tire pressure. Refer to Steps 1–10 under “Using the Tire Sealant and Compressor Kit without Sealant to Inflate a Tire (Not Punctured).”

If the tire pressure has fallen more than 68 kPa (10 psi) below the recommended inflation pressure, stop driving the vehicle. The tire is too severely damaged and the tire sealant cannot seal the tire. See *Roadside Assistance Program* ⇨ 382.

If the tire pressure has not dropped more than 68 kPa (10 psi) from the recommended inflation pressure, inflate the tire to the recommended inflation pressure.

24. Wipe off any sealant from the wheel, tire, or vehicle.
25. Dispose of the used tire sealant canister (4) at a local dealer or in accordance with local state codes and practices.

26. Replace it with a new canister available from your dealer.
27. After temporarily sealing a tire using the tire sealant and compressor kit, take the vehicle to an authorized dealer within 161 km (100 mi) of driving to have the tire repaired or replaced.

### Using the Tire Sealant and Compressor Kit without Sealant to Inflate a Tire (Not Punctured)

The kit includes:

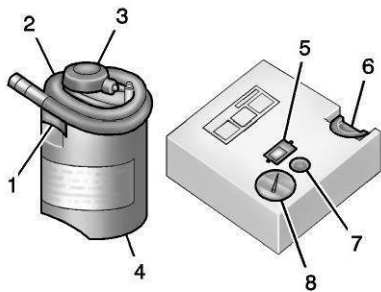

1. Sealant Canister Inlet Valve
2. Sealant/Air Hose
3. Base of Sealant Canister

4. Tire Sealant Canister
5. On/Off Button
6. Slot on Top of Compressor
7. Pressure Deflation Button
8. Pressure Gauge

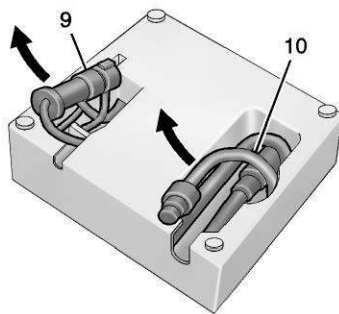

9. Power Plug
10. Air Only Hose

If a tire goes flat, avoid further tire and wheel damage by driving slowly to a level place. Turn on the hazard warning flashers. See *Hazard Warning Flashers* ⇨ 128.

See *If a Tire Goes Flat* ⇨ 343 for other important safety warnings.

1. Remove the compressor from its storage location. See *Storing the Tire Sealant and Compressor Kit* ⇨ 349.
2. Remove the air only hose (10) and the power plug (9) from the bottom of the compressor.
3. Place the compressor on the ground near the flat tire.  
Make sure the tire valve stem is positioned close to the ground so the hose will reach it.
4. Remove the valve stem cap from the flat tire by turning it counterclockwise.
5. Attach the air only hose (10) to the tire valve stem by turning it clockwise until tight.
6. Plug the power plug (9) into the accessory power outlet in the vehicle. Unplug all items from other accessory power outlets. See *Power Outlets* ⇨ 88.  
If the vehicle has an accessory power outlet, do not use the cigarette lighter.  
If the vehicle only has a cigarette lighter, use the cigarette lighter.  
Do not pinch the power plug cord in the door or window.
7. Start the vehicle. The vehicle must be running while using the air compressor.

8. Press the on/off button (5) to turn the tire sealant and compressor kit on.  
The compressor will inflate the tire with air only.
9. Inflate the tire to the recommended inflation pressure using the pressure gauge (8). The recommended inflation pressure can be found on the Tire and Loading Information label. See *Tire Pressure* ⇨ 331.  
The pressure gauge (8) may read higher than the actual tire pressure while the compressor is on. Turn the compressor off to get an accurate pressure reading. The compressor may be turned on/off until the correct pressure is reached.

### Caution

If the recommended pressure cannot be reached after approximately 25 minutes, the vehicle should not be driven farther. The tire is too severely damaged and the tire sealant and compressor kit cannot inflate the tire. Remove the power plug from the accessory power outlet and unscrew the inflating hose from the tire valve. See *Roadside Assistance Program* ⇨ 382.

10. Press the on/off button (5) to turn the tire sealant and compressor kit off.  
Be careful while handling the compressor as it could be warm after usage.
11. Unplug the power plug (9) from the accessory power outlet in the vehicle.
12. Turn the air only hose (10) counterclockwise to remove it from the tire valve stem.
13. Replace the tire valve stem cap.
14. Return the air only hose (10) and power plug (9) back to their original storage location.
15. Return the equipment to its original storage location in the vehicle.

The tire sealant and compressor kit has accessory adapters located in a compartment on the bottom of its housing that can be used to inflate air mattresses, balls, etc.

## Storing the Tire Sealant and Compressor Kit

The tire sealant and compressor kit is in a bag in the trunk.

1. Open the trunk. See *Trunk* ⇨ 17.

2. Lift the load floor.

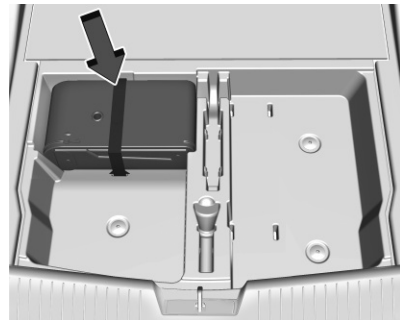

3. Remove the tire sealant and compressor kit bag.
4. Remove the tire sealant and compressor kit from the bag.

To store the tire sealant and compressor kit, reverse the steps.

## Jump Starting

### Jump Starting - North America

For more information about the vehicle battery, see *Battery - North America* ⇨ 312.

If the battery has run down, try to use another vehicle and some jumper cables to start your vehicle. Be sure to use the following steps to do it safely.

### Warning

**WARNING:** Battery posts, terminals and related accessories can expose you to chemicals including lead and lead compounds, which are known to the State of California to cause cancer and birth defects or other reproductive harm. Wash hands after handling. For more information go to [www.P65Warnings.ca.gov](http://www.P65Warnings.ca.gov).

See *California Proposition 65 Warning* ⇨ 1.

### Warning

Batteries can hurt you. They can be dangerous because:

- They contain acid that can burn you.
- They contain gas that can explode or ignite.

(Continued)

### Warning (Continued)

- They contain enough electricity to burn you.

If you do not follow these steps exactly, some or all of these things can hurt you.

### Caution

Ignoring these steps could result in costly damage to the vehicle that would not be covered by the vehicle warranty. Trying to start the vehicle by pushing or pulling it will not work, and it could damage the vehicle.

### Caution

If the jumper cables are connected or removed in the wrong order, electrical shorting may occur and damage the vehicle. The repairs would not be covered by the vehicle warranty. Always connect and remove the jumper cables in the correct order, making sure that the cables do not touch each other or other metal.

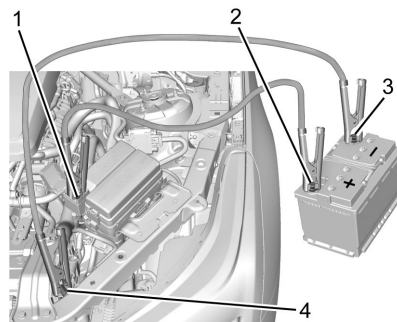

2.0L I4 Engine Shown, 3.0L V6 Engine and 6.2L DI Engine Similar

### Connection Points and Sequence

1. Discharged Battery Positive (+) Terminal
2. Good Battery Positive (+) Terminal
3. Good Battery Negative (-) Terminal
4. Discharged Battery Negative Grounding (-) Terminal

The jump start positive terminal (+) and negative post (-) are on the battery of the vehicle providing the jump start.

The jump start remote positive terminal (+) and the remote negative grounding terminal (-) for the discharged battery are on the driver side of the vehicle.

The positive jump start connection for the discharged battery is under a cover. Lift the cover to expose the terminal.

### Caution

If the other vehicle does not have a 12-volt system with a negative ground, both vehicles can be damaged. Only use a vehicle that has a 12-volt system with a negative ground for jump starting.

1. Check the other vehicle. It must have a 12-volt battery with a negative ground system.
2. Position the two vehicles so that they are not touching.
3. Set the parking brake firmly and put the vehicle in P (Park) with an automatic transmission, or Neutral with a manual transmission.

### Caution

If any accessories are left on or plugged in during the jump starting procedure, they could be damaged. The repairs would not be covered by the vehicle warranty. Whenever possible, turn off or unplug all accessories on either vehicle when jump starting.

4. Turn the ignition off. Turn off all lights and accessories in both vehicles, except the hazard warning flashers if needed.

### Warning

An electric fan can start up even when the engine is not running and can injure you. Keep hands, clothing, and tools away from any underhood electric fan.

### Warning

Using a match near a battery can cause battery gas to explode. People have been hurt doing this, and some have been blinded. Use a flashlight if you need more light.

Battery fluid contains acid that can burn you. Do not get it on you. If you accidentally get it in your eyes or on your skin, flush the place with water and get medical help immediately.

### Warning

Fans or other moving engine parts can injure you badly. Keep your hands away from moving parts once the engine is running.

5. Connect one end of the red positive (+) cable to the remote positive (+) terminal on the discharged battery.
6. Connect the other end of the red positive (+) cable to the positive (+) terminal of the good battery.



7. Connect one end of the black negative (-) cable to the negative (-) terminal of the good battery.  
Do not let the other end touch anything until the next step. The other end of the negative (-) cable does not go to the dead battery. It goes to a heavy, unpainted metal engine part.
8. Connect the other end of the black negative (-) cable to the negative (-) grounding point for the discharged battery.
9. Start the engine in the vehicle with the good battery and run the engine at idle speed for at least four minutes.
10. Try to start the vehicle that had the dead battery. If it will not start after a few tries, it probably needs service.

### Jumper Cable Removal

Reverse the sequence exactly when removing the jumper cables.

After starting the disabled vehicle and removing the jumper cables, allow it to idle for several minutes.

## Towing the Vehicle

### Transporting a Disabled Vehicle

#### Caution

Incorrectly transporting a disabled vehicle may cause damage to the vehicle. Use proper tire straps to secure the vehicle to the flatbed tow truck. Do not strap or hook to any frame, underbody, or suspension component not specified below. Do not move vehicles with drive axle tires on the ground. Damage is not covered by the vehicle warranty.

#### Caution

The vehicle may be equipped with an Electric Parking Brake (EPB) and/or an electronic shifter. In the event of a loss of 12-volt battery power, the EPB cannot be released, and the vehicle cannot be shifted to N (Neutral). Tire skates or dollies must be used under the non-rolling tires to prevent damage while loading/

(Continued)

#### Caution (Continued)

unloading the vehicle. Dragging the vehicle will cause damage not covered by the vehicle warranty.

#### Caution

The vehicle may be equipped with a tow eye. Improper use of the tow eye may cause damage to the vehicle and is not covered by the vehicle warranty. If equipped, use the tow eye to load the vehicle onto a flatbed tow truck from a flat road surface, or to move the vehicle a very short distance at a walking pace. The tow eye is not designed for off-road recovery. The vehicle must be in N (Neutral) with the Electric Parking Brake (EPB) released when using the tow eye.

Contact a professional towing service if the disabled vehicle must be transported. GM recommends a flatbed tow truck to transport a disabled vehicle. Use ramps to help reduce approach angles, if necessary.

If equipped, a tow eye may be located near the spare tire or emergency jack. Do not use the tow eye to pull the vehicle from the snow, mud, sand, or ditch. Tow eye threads may have right- or left-hand threads. Use caution when installing or removing the tow eye.

The vehicle must be in N (Neutral) and the electric parking brake must be released when loading the vehicle onto a flatbed tow truck.

- If the vehicle is equipped with car wash mode and has 12-volt battery power, see “Car Wash Mode” under *Automatic Transmission* ⇨ 200 to place the vehicle in N (Neutral).
- If the 12-volt battery is dead and/or the engine will not start, the vehicle will not move. Try to jump start the vehicle. See *Jump Starting - North America* ⇨ 349 and if the jump start is successful, retry the “Car Wash Mode” procedure.
- If jump starting is unsuccessful, the vehicle will not move. Tire skates or dollies must be used under the non-rolling tires to prevent vehicle damage.

### V-Series Blackwing Only

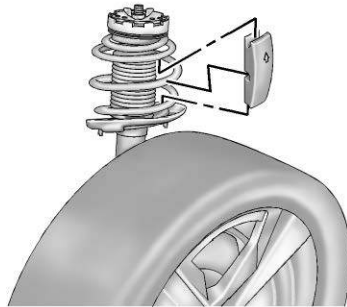

Due to low ramp angles on the V-Series Blackwing, use care when loading the vehicle onto a flatbed carrier. Front spring spacers were provided for lifting the front suspension if more clearance is necessary when towing.

### Front Tow Eye



The vehicle is equipped with a tow eye. Only use the tow eye to pull the vehicle onto a flatbed car carrier from a flat road surface. Do not use the tow eye to pull the vehicle from snow, mud, or sand. The tow eye is located under the carpet in the trunk.

Carefully open the cover on the fascia by using the small notch that conceals the tow eye socket.

Install the tow eye into the socket and turn it until it is fully tightened. When the tow eye is removed, reinstall the cover with the notch in the original position.

### Rear Tow Eye



If equipped, carefully open the cover by using the small notch that conceals the rear tow eye socket. Install the tow eye into the socket and turn it until it is fully tightened. When the tow eye is removed, reinstall the cover with the notch in the original position.

### Recreational Vehicle Towing

#### Caution

Dolly towing or dinghy towing the vehicle may cause damage because of reduced ground clearance. Always put the vehicle on a flatbed truck or trailer.

The vehicle was neither designed nor intended to be towed with any of its wheels on the ground. If the vehicle must be towed, see *Transporting a Disabled Vehicle* ⇨ 352.

### Appearance Care

#### Exterior Care

##### Locks

Locks are lubricated at the factory. Use a de-icing agent only when necessary, and have the locks greased after using. See *Recommended Fluids and Lubricants* ⇨ 370.

##### Washing the Vehicle

To preserve the vehicle finish, wash it often and out of direct sunlight.

#### Caution

Do not use petroleum-based, acidic, or abrasive cleaning agents as they can damage the vehicle's paint, metal, or plastic parts. If damage occurs, it would not be covered by the vehicle warranty. Approved cleaning products can be obtained from your dealer. Follow all manufacturer directions regarding correct product usage, necessary safety precautions, and appropriate disposal of any vehicle care product.

#### Caution

Avoid using high-pressure washers closer than 30 cm (12 in) to the surface of the vehicle. Use of power washers exceeding 8,274 kPa (1,200 psi) can result in damage or removal of paint and decals.

**Automatic Car Wash****Caution**

Automatic car washes can cause damage to the vehicle, wheels, ground effects, and convertible top (if equipped). Do not use automatic car washes due to lack of clearance for the undercarriage, wide rear tires, and wheels.

**Caution**

To avoid damage to a matte paint finish, do not use an automatic car wash equipped with brushes or scrubbers. Only use touchless automatic car washes.

If using an automatic car wash, follow the car wash instructions. The windshield wiper and rear window wiper, if equipped, must be off. Remove any accessories that may be damaged or interfere with the car wash equipment.

**Hand Wash**

Rinse the vehicle well, before and after washing, to remove all cleaning agents completely. If they are allowed to dry on the surface, they could stain.

Dry the finish with a soft, clean chamois or an all-cotton towel to avoid surface scratches and water spotting.

**Cleaning Underhood Components****Caution**

Do not power wash any component under the hood that has this  symbol.

This could cause damage to the vehicle that would not be covered by the vehicle warranty.

Avoid using solvents or abrasive cleaners that may harm underhood components. GM recommends using only water to clean underhood components.

If using a pressure washer, ensure the following criteria is met:

- Water pressure must be kept below 14 000 KPa (2,000 PSI).

- Water temperature must be below 80 °C (180 °F).
- A spray nozzle with a 40 degree wide angle spray pattern or wider must be used, and must be kept at least 30 cm (1ft) away from all surfaces.

**Finish Care**

Application of aftermarket clearcoat sealant/wax materials is not recommended. If painted surfaces are damaged, see your dealer to have the damage assessed and repaired.

Materials such as calcium chloride and other salts, ice melting agents, road oil and tar, tree sap, bird droppings, chemicals from industrial chimneys, etc., can damage the vehicle finish if they remain on painted surfaces. Wash the vehicle as soon as possible. If necessary, use non-abrasive cleaners that are marked safe for painted surfaces to remove foreign matter.

Occasional hand waxing or mild polishing should be done to remove residue from the paint finish. See your dealer for approved cleaning products.

**Caution**

Do not apply waxes or polishes to uncoated plastic, vinyl, rubber, decals, simulated wood, or matte paint as damage can occur.

**Caution**

Machine compounding or aggressive polishing on a basecoat/clearcoat paint finish may damage it. Use only non-abrasive waxes and polishes that are made for a basecoat/clearcoat paint finish on the vehicle.

To keep the paint finish looking new, keep the vehicle garaged or covered whenever possible.

**Protecting Exterior Bright Metal Moldings****Caution**

Failure to clean and protect the bright metal moldings can result in a hazy white finish or pitting. This damage would not be covered by the vehicle warranty.

The bright metal moldings on the vehicle are aluminum, chrome, or stainless steel. To prevent damage, always follow these cleaning instructions:

- Be sure the molding is cool to the touch before applying any cleaning solution.
- Use only approved cleaning solutions for aluminum, chrome, or stainless steel. Some cleaners are highly acidic or contain alkaline substances and can damage the moldings.
- Always dilute a concentrated cleaner according to the manufacturer's instructions.
- Do not use cleaners that are not intended for automotive use.
- Use a nonabrasive wax on the vehicle after washing to protect and extend the molding finish.

**Carbon Fiber Care**

Carbon fiber composite parts can be washed and waxed like any other parts. Use a clear or black pigmented wax. See *Composite Materials* ⇨ 192.

**Cleaning Exterior Lamps/Lenses, Emblems, Decals, and Stripes**

Use only lukewarm or cold water, a soft cloth, and a car washing soap to clean exterior lamps, lenses, emblems, decals, and stripes. Follow instructions under "Washing the Vehicle" previously in this section.

Lamp covers are made of plastic, and some have a UV protective coating. Do not clean or wipe lamp covers when dry. This can cause scratches to the surface of the lamp cover.

Do not use any of the following items on lamp covers:

- Abrasive or caustic agents.
- Washer fluids and other cleaning agents in higher concentrations than suggested by the manufacturer.
- Solvents, alcohols, fuels, or other harsh cleaners.
- Ice scrapers or other hard items.
- Aftermarket appearance caps or covers while the lamps are illuminated, due to excessive heat generated.

**Caution**

Failure to clean lamps properly can cause damage to the lamp cover that would not be covered by the vehicle warranty.

**Caution**

Using wax on low gloss black finish stripes can increase the gloss level and create a non-uniform finish. Clean low gloss stripes with soap and water only.

**Air Intakes**

Clear debris from the air intakes between the hood and windshield when washing the vehicle.

**Shutter System**

The vehicle may have a shutter system designed to help improve fuel economy. Always keep the shutter system clear of debris, snow and ice. If the check engine light is activated, please check to see if the shutter system is clear of debris, snow or ice.

**Windshield and Wiper Blades**

Clean the outside of the windshield with glass cleaner.

Clean rubber wiper blades using a lint-free cloth or paper towel soaked with windshield washer fluid or a mild detergent. Wash the windshield thoroughly when cleaning the

blades. Bugs, road grime, sap, and a buildup of vehicle wash/wax treatments may cause wiper streaking.

Replace the wiper blades if they are worn or damaged. Damage can be caused by extreme dusty conditions, sand, salt, heat, sun, snow, and ice.

**Weatherstrips**

Apply weatherstrip lubricant on weatherstrips to make them last longer, seal better, and not stick or squeak. Lubricate weatherstrips at least once a year. Hot, dry climates may require more frequent application. Black marks from rubber material on painted surfaces can be removed by rubbing with a clean cloth.

**Tires**

Use a stiff brush with tire cleaner to clean the tires.

**Caution**

Using petroleum-based tire dressing products on the vehicle may damage the paint finish and/or tires. When applying

(Continued)

**Caution (Continued)**

a tire dressing, always wipe off any overspray from all painted surfaces on the vehicle.

**Wheels and Wheel Trim**

Use a soft, clean cloth with mild soap and water to clean the wheels. After rinsing thoroughly with clean water, dry with a soft, clean towel. A wax may then be applied.

**Caution**

Chrome wheels and chrome wheel trim may be damaged if the vehicle is not washed after driving on roads that have been sprayed with magnesium chloride or calcium chloride. These are used on roads for conditions such as dust control. Always wash the chrome with soap and water after exposure.

**Caution**

To avoid surface damage on wheels and wheel trim, do not use strong soaps, chemicals, abrasive polishes, cleaners, or brushes. Use only GM approved cleaners. Do not drive the vehicle through an automatic car wash that uses silicon carbide tire/wheel cleaning brushes. Damage could occur and the repairs would not be covered by the vehicle warranty.

**Brake System**

Visually inspect brake lines and hoses for proper hook-up, binding, leaks, cracks, chafing, etc. Inspect disc brake pads for wear and rotors for surface condition. Inspect brake linings/shoes for wear or cracks. Inspect all other brake parts.

**Steering, Suspension, and Chassis Components**

Visually inspect steering, suspension, and chassis components for damaged, loose, or missing parts or signs of wear at least once a year.

Inspect power steering for proper attachment, connections, binding, leaks, cracks, chafing, etc.

Visually check constant velocity joint boots and axle seals for leaks.

**Body Component Lubrication**

Lubricate all key lock cylinders, hood hinges, liftgate hinges, and the steel fuel door hinges, unless the components are plastic. Applying silicone grease on weatherstrips with a clean cloth will make them last longer, seal better, and not stick or squeak.

**Underbody Maintenance**

Every six months, use plain water to flush any corrosive materials from the underbody. Take care to thoroughly clean any areas where mud and other debris can collect.

Do not directly power wash the transfer case and/or front/rear axle output seals. High pressure water can overcome the seals and contaminate the fluid. Contaminated fluid will decrease the life of the transfer case and/or axles and should be replaced.

### Sheet Metal Damage

If the vehicle is damaged and requires sheet metal repair or replacement, make sure the body repair shop applies anti-corrosion material to parts repaired or replaced to restore corrosion protection.

Original manufacturer replacement parts will provide the corrosion protection while maintaining the vehicle warranty.

### Finish Damage

Quickly repair minor chips and scratches with touch-up materials available from your dealer to avoid corrosion. Larger areas of finish damage can be corrected in your dealer's body and paint shop.

### Chemical Paint Spotting

Airborne pollutants can fall upon and attack painted vehicle surfaces causing blotchy, ring-shaped discolorations, and small, irregular dark spots etched into the paint surface. See "Finish Care" previously in this section.

### Interior Care

To prevent dirt particle abrasions, regularly clean the vehicle's interior. Before using cleaners, read and follow all safety instructions on the label. While cleaning the interior, open the doors and windows for proper ventilation. Newspapers or dark garments can transfer color to the vehicle's interior.

#### Caution

Immediately remove cleaners, hand lotions, sunscreen, and insect repellent from all interior surfaces or permanent damage may result.

#### Caution

Use cleaners specifically designed for the surfaces being cleaned to prevent permanent damage to the vehicle. Apply all cleaners directly to a cleaning cloth. Do not spray cleaners on any switches or controls.

When using liquid soap cleaners, follow the directions on the specific cleaner or soap solution for dilution instructions.

#### Caution

To prevent damage:

- Never use a razor or any other sharp object to remove soil from any interior surface.
- Never use a brush with stiff bristles.
- Never rub any surface aggressively or with too much pressure.
- Do not get any exposed electrical components wet.
- Do not use laundry detergents or dishwashing soaps with degreasers. Do not use solutions that contain strong or caustic soap.
- Do not heavily saturate the upholstery when cleaning.
- Do not use solvents or cleaners containing solvents.
- Do not use disinfecting wipes that are scented or contain bleach. Do not use wipes or cleaners that show

(Continued)



**Caution (Continued)**

a color transfer to the wipe or change the appearance of the interior surface when used.

- Do not use scented or gel-type hand sanitizers. If hand sanitizer comes in contact with interior surfaces of the vehicle, blot immediately and clean with a soft cloth dampened with a mild soap and water solution.

**Interior Glass**

To clean, use a microfiber cloth fabric dampened with water. Wipe droplets left behind with a clean dry cloth. If necessary, use a commercial glass cleaner after cleaning with plain water.

**Caution**

To prevent scratching, never use abrasive cleaners on automotive glass. Abrasive cleaners or aggressive cleaning may damage the rear window defogger.

Cleaning the windshield with water during the first three to six months of ownership will reduce tendency to fog.

**Speaker Covers**

Vacuum around a speaker cover gently, so that the speaker will not be damaged. Clean spots with water and mild soap.

**Coated Moldings**

Clean coated moldings.

- When lightly soiled, wipe with a sponge or soft, lint-free cloth dampened with water.
- When heavily soiled, use warm soapy water.

**Vinyl/Rubber**

If equipped with vinyl floor and rubber floor mats, use a soft cloth and/or brush dampened with water to remove dust and loose dirt. For more thorough cleaning, use a mild soap and water solution.

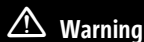
**Warning**

Do not use cleaners that contain silicone, wax-based products, or cleaners that increase gloss on vinyl/rubber floor and mats. These cleaners can permanently change the appearance and feel of the vinyl/rubber and can make the floor slippery. Your foot could slip while operating the vehicle, and you could lose control, resulting in a crash. You or others could be injured.

**Fabric/Carpet/Suede**

Start by vacuuming the surface using a soft brush attachment. If a rotating vacuum brush attachment is used, only use it on the floor carpet. Before cleaning, gently remove as much of the soil as possible:

- Gently blot liquids with a paper towel. Continue blotting until no more soil can be removed.
- For solid soils, remove as much as possible prior to vacuuming.

To clean:

1. Saturate a clean, lint-free colorfast cloth with water. Microfiber cloth is recommended to prevent lint transfer to the fabric or carpet.
2. Remove excess moisture by gently wringing until water does not drip from the cleaning cloth.
3. Start on the outside edge of the soil and gently rub toward the center. Fold the cleaning cloth to a clean area frequently to prevent forcing the soil into the fabric.
4. Continue gently rubbing the soiled area until there is no longer any color transfer from the soil to the cleaning cloth.
5. If the soil is not completely removed, use a mild soap solution followed only by plain water.

If the soil is not completely removed, it may be necessary to use a commercial upholstery cleaner or spot lifter. Test a small hidden area for colorfastness before using a commercial upholstery cleaner or spot lifter. If ring formation occurs, clean the entire fabric or carpet.

After cleaning, use a paper towel to blot excess moisture.

### Cleaning High Gloss Surfaces and Vehicle Status and Radio Displays

Use a microfiber cloth on high gloss surfaces or vehicle displays. First, use a soft bristle brush to remove dirt that can scratch the surface. Then gently clean by rubbing with a microfiber cloth. Never use window cleaners or solvents. Periodically hand wash the microfiber cloth separately, using mild soap. Do not use bleach or fabric softener. Rinse thoroughly and air dry before next use.

#### Caution

Do not attach a device with a suction cup to the display. This may cause damage and would not be covered by the vehicle warranty.

### Instrument Panel, Leather, Vinyl, Other Plastic Surfaces, Low Gloss Paint Surfaces, and Natural Open Pore Wood Surfaces

#### Caution

Soaking or saturating leather, especially perforated leather, as well as other interior surfaces, may cause permanent damage. Wipe excess moisture from these surfaces after cleaning and allow them to dry naturally. Never use heat, steam, or spot removers. Do not use liquids that contain alcohol or solvents on leather seats. Do not use cleaners that contain silicone or wax-based products. Cleaners containing these solvents can permanently change the appearance and feel of leather or soft trim and are not recommended.

#### Caution

Use of air fresheners may cause permanent damage to plastics and painted surfaces. If an air freshener comes in contact with any plastic or painted surface in the vehicle,

(Continued)

**Caution (Continued)**

blot immediately and clean with a soft cloth dampened with a mild soap solution. Damage caused by air fresheners would not be covered by the vehicle warranty.

Use compressed air or a vacuum to remove liquid or dust under the Multi-Functional Controller (MFC) cap, if equipped.

Use a soft bristle brush to remove dust from knobs and crevices on the instrument cluster. Use a soft microfiber cloth dampened with water to remove dust and loose dirt. For a more thorough cleaning, use a soft microfiber cloth dampened with a mild soap and water solution.

Do not use cleaners that increase gloss, especially on the instrument panel. Reflected glare can decrease visibility through the windshield under certain conditions.

**Cargo Cover and Convenience Net**

If equipped, wash with warm water and mild detergent. Do not use chlorine bleach. Rinse with cold water, and then dry completely.

**Care of Seat Belts**

Keep belts clean and dry.

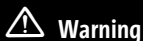
**Warning**

Do not bleach or dye seat belt webbing. It may severely weaken the webbing. In a crash, they might not be able to provide adequate protection. Clean and rinse seat belt webbing only with mild soap and lukewarm water. Allow the webbing to dry.

**Floor Mats****Warning**

If a floor mat is the wrong size or is not properly installed, it can interfere with the pedals. Interference with the pedals can cause unintended acceleration and/or increased stopping distance which can cause a crash and injury. Make sure the floor mat does not interfere with the pedals.

Use the following guidelines for proper floor mat use.

- The original equipment floor mats are designed for your vehicle. If the floor mats need to be replaced, it is recommended that GM-certified floor mats are purchased. Non-GM floor mats may not fit properly and may interfere with the pedals. Always check that the floor mats do not interfere with the pedals.
- Do not use a floor mat if the vehicle is not equipped with a floor mat retainer on the driver side floor.
- Use the floor mat with the correct side up. Do not turn it over.
- Do not place anything on top of the driver side floor mat.
- Use only a single floor mat on the driver side.
- Do not place one floor mat on top of another.

The driver side floor mat is held in place by two button-type retainers.

## Removing and Replacing the Floor Mats

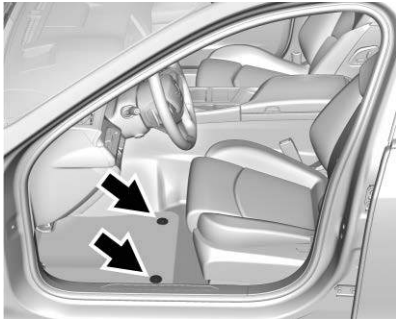

1. Pull up on the rear of the floor mat to unlock the retainers and remove.
2. Reinstall by lining up the floor mat retainer openings over the carpet retainers and snap into position.
3. Make sure the floor mat is properly secured in place. Verify the floor mat does not interfere with the pedals.

### Cleaning Rubber Floor Mats (All-Weather Mats and Floor Liners)

See “Vinyl/Rubber” under *Interior Care* ⇨ 359 for important cleaning information.

## Service and Maintenance

### General Information

General Information .....364

### Maintenance Schedule

Maintenance Schedule .....365

### Multi-Point Vehicle Inspection (MPVI)

Multi-Point Vehicle Inspection (MPVI) .... 368

### Special Application Services

Special Application Services ..... 369

### Recommended Fluids, Lubricants, and Parts

Recommended Fluids and Lubricants ..... 370

### Maintenance Records

Maintenance Records .....371

## General Information

Your vehicle is an important investment. This section describes the required maintenance for the vehicle. Follow this schedule to help protect against major repair expenses resulting from neglect or inadequate maintenance. It may also help to maintain the value of the vehicle if it is sold. It is the responsibility of the owner to have all required maintenance performed.

Your dealer has trained technicians who can perform required maintenance using genuine replacement parts. They have up-to-date tools and equipment for fast and accurate diagnostics. Many dealers have extended evening and Saturday hours, courtesy transportation, and online scheduling to assist with service needs.

Your dealer recognizes the importance of providing competitively priced maintenance and repair services. With trained technicians, the dealer is the place for routine maintenance such as oil changes and tire rotations and additional maintenance items like tires, brakes, batteries, and wiper blades.

### Caution

Damage caused by improper maintenance can lead to costly repairs and may not be covered by the vehicle warranty. Maintenance intervals, checks, inspections, recommended fluids, and lubricants are important to keep the vehicle in good working condition.

Do not have chemical flushes that are not approved by GM performed on the vehicle. The use of flushes, solvents, cleaners, or lubricants that are not approved by GM could damage the vehicle, requiring expensive repairs that are not covered by the vehicle warranty.

The Tire Rotation and Required Services are the responsibility of the vehicle owner. It is recommended to have your dealer perform these services every 12 000 km/7,500 mi. Proper vehicle maintenance helps to keep the vehicle in good working condition, improves fuel economy, and reduces vehicle emissions.

Because of the way people use vehicles, maintenance needs vary. There may need to be more frequent checks and services. The Additional Required Services - Normal are for vehicles that:

- Carry passengers and cargo within recommended limits on the Tire and Loading Information label. See *Vehicle Load Limits* ⇨ 187.
- Are driven on reasonable road surfaces within legal driving limits.
- Use the recommended fuel. See *Recommended Fuel (LSY 2.0L I4 Engine)* ⇨ 275 *Recommended Fuel (LGY 3.0L V6 and LT4 6.2L V8 Engines)* ⇨ 276.

Refer to the information in the Maintenance Schedule Additional Required Services - Normal Service.

The Additional Required Services - Severe are for vehicles that are:

- Mainly driven in heavy city traffic in hot weather.
- Mainly driven in hilly or mountainous terrain.
- Frequently towing a trailer.

- Used for high speed or competitive driving.
- Used for taxi, police, or delivery service.

Refer to the information in the Maintenance Schedule Additional Required Services - Severe Service.

### Warning

Performing maintenance work can be dangerous and can cause serious injury. Perform maintenance work only if the required information, proper tools, and equipment are available. If they are not, see your dealer to have a trained technician do the work. See *Doing Your Own Service Work* ⇨ 287.

## Maintenance Schedule

### Tire Rotation and Required Services Every 12 000 km (7,500 mi)

Tires are rotated to achieve a more uniform wear for all tires. The first rotation is the most important.

Anytime unusual wear is noticed, rotate the tires as soon as possible, check for proper tire inflation pressure, and check for damaged tires

or wheels. If the unusual wear continues after the rotation, check the wheel alignment. See *When It Is Time for New Tires* ⇨ 338 and *Wheel Replacement* ⇨ 342.

- Perform Multi-Point Vehicle Inspection. See *Multi-Point Vehicle Inspection (MPVI)* ⇨ 368.
- Lubricate body components. See *Exterior Care* ⇨ 354.

### Additional Required Services — Normal Service

#### Every 12 000 km (7,500 mi)

- Check engine oil level and oil life percentage. If needed, change engine oil and filter, and reset oil life system. Or when the CHANGE ENGINE OIL SOON message displays, have the engine oil and filter changed within the next 1 000 km/600 mi. If driven under the best conditions, the engine oil life system may not indicate the need for vehicle service for up to a year. The engine oil and filter must be changed at least once a year and the oil life system must be reset. Your trained dealer technician can perform this work. If the engine oil life system is reset accidentally, service the vehicle within 5 000 km/3,000 mi since the last service. Reset the oil life system when the oil is changed. See *Engine Oil Life System* ⇨ 297.
- When the REPLACE AT NEXT OIL CHANGE message displays, the engine air filter should be replaced at the next engine oil change. When the REPLACE ENGINE AIR FILTER SOON message displays, the engine air filter should be replaced at the earliest

convenience. Reset the engine air filter life system after the engine air filter is replaced. See *Engine Air Filter Life System* ⇨ 299.

#### Every 36 000 km (22,500 mi)

- Passenger compartment air filter replacement (or every 24 months, whichever occurs first). More frequent replacement may be needed if the vehicle is driven in areas with heavy traffic, poor air quality, areas with high dust levels or are sensitive to environmental allergens. Filter replacement may also be needed if you notice reduced airflow, windows fogging up, or odors. Your local GM Service location can help you determine when it is the right time to replace your filter.

#### Every 72 000 km (45,000 mi)

- Change rear axle fluid, if equipped with limited slip differential. Do not directly power wash the transfer case and/or front/rear axle output seals. High pressure water can overcome the seals and contaminate the transfer case fluid. Contaminated fluid will decrease the life of the transfer case and/or axles and should be replaced.

#### Every 96 000 km (60,000 mi)

- Replace spark plugs. Inspect spark plug wires and/or boots.

#### Every 156 000 km (97,500 mi)

- Change transfer case fluid, if equipped with AWD. Do not directly power wash the transfer case and/or front/rear axle output seals. High pressure water can overcome the seals and contaminate the transfer case fluid. Contaminated fluid will decrease the life of the transfer case and/or axles and should be replaced.

#### Every 161 000 km (100,000 mi)

- Replace hood and/or body lift support gas struts. Or every 10 years, whichever comes first. See *Gas Strut(s)* ⇨ 314.

#### Every 240 000 km (150,000 mi)

- Change rear axle fluid, without limited slip differential. Do not directly power wash the transfer case and/or front/rear axle output seals. High pressure water can overcome the seals and contaminate the transfer case fluid. Contaminated fluid will decrease the life of the transfer case and/or axles and should be replaced.

- Change front axle fluid, if equipped with AWD. Do not directly power wash the transfer case and/or front/rear axle output seals. High pressure water can overcome the seals and contaminate the transfer case fluid. Contaminated fluid will decrease the life of the transfer case and/or axles and should be replaced.
- Drain and fill engine cooling system. Or every six years, whichever comes first. See *Cooling System* ⇨ 302.

### Severe Conditions Requiring More Frequent Maintenance\*

- Public service, military, or commercial use vehicles to include the following:
  - Ambulances, police cars, and emergency rescue vehicles.
  - Civilian vehicles such as light duty pick-up trucks, SUVs, and passenger cars that are used in military applications.
  - Recovery vehicles such as tow trucks and flatbed single vehicle carriers or any vehicle that is consistently used in towing trailers or other loads.

- High use commercial vehicles such as courier delivery vehicles, private security patrol vehicles, or any vehicles that operate on a 24-hour basis.
- Any vehicle consistently operated in a high sand or dust environment such as those used on oil pipelines and similar applications.
- Vehicles that are regularly used for short trips of 6 km (4 mi) or less.

The oil life indicator will show you when to change the oil and filter. Under severe conditions the indicator may come on before 12 000 km (7,500 mi).

\* Footnote: Under extreme driving conditions listed above, it may be necessary to replace your spark plugs at more frequent intervals. For further assistance in determining the most suitable service maintenance intervals for your vehicle, please contact your authorized GM Dealer.

Extreme service is for vehicles mainly driven off-road in four-wheel drive or used in farming, mining, forestry, or snow plowing.

### Additional Required Services — Severe Service

#### Every 72 000 km (45,000 mi)

- Change automatic transmission fluid and filter.
- Change manual transmission fluid. (If equipped)
- Change transfer case fluid, if equipped with AWD. Do not directly power wash the transfer case and/or front/rear axle output seals. High pressure water can overcome the seals and contaminate the transfer case fluid. Contaminated fluid will decrease the life of the transfer case and/or axles and should be replaced.
- Change rear axle fluid, with limited slip differential. Do not directly power wash the transfer case and/or front/rear axle output seals. High pressure water can overcome the seals and contaminate the transfer case fluid. Contaminated fluid will decrease the life of the transfer case and/or axles and should be replaced.
- Change front axle fluid, if equipped with AWD. Do not directly power wash the transfer case and/or front/rear axle output seals. High pressure water can overcome



the seals and contaminate the transfer case fluid. Contaminated fluid will decrease the life of the transfer case and/or axles and should be replaced.

#### Every 120 000 km (75,000 mi)

- Change rear axle fluid, without limited slip differential. Do not directly power wash the transfer case and/or front/rear axle output seals. High pressure water can overcome the seals and contaminate the transfer case fluid. Contaminated fluid will decrease the life of the transfer case and/or axles and should be replaced.

#### Owner Checks and Services

##### Every Five Years

- Replace brake fluid every five years for vehicles with automatic transmissions and every three years for vehicles with manual transmissions. See *Brake Fluid* ⇨ 311.

##### Every Seven Years

- Replace Air Conditioning Desiccant every seven years. The air conditioning system requires maintenance every seven years. This service requires replacement of the desiccant to help the longevity and efficient operation of the air conditioning system. This service can be complex. See your dealer.

### Multi-Point Vehicle Inspection (MPVI)

A Multi Point Vehicle Inspection (MPVI) completed by a trained technician is a maintenance assessment of your vehicle. The benefit of the MPVI is to identify service items that require immediate attention and those that may require attention in the future.

The technician will perform the following checks on your vehicle. You can obtain a copy of the appropriate MPVI checklist on your country's GM Certified Service website. For a complete list of checks, inspections, and services, see your dealer.

Some items may not apply to your vehicle and/or region.

##### Diagnostics

- OnStar active, if equipped
- Service history/recall check

##### Engine Oil and Filter

- Engine oil
- Oil life monitor
  - Reset oil life monitor

##### Exterior Lights

- Visual inspection

##### Windshield and Wipers

- Visual inspection

##### 12 Volt Battery

- Battery visual inspection
- Battery test results
- Battery cables and connections

##### Systems, Fluids, and Visible Leak Inspection

- Engine oil
- Transmission
- Drive axle

- Transfer case
- Engine cooling system
- Power steering, if equipped
- Fuel system
- Windshield washer fluid

### Tire Inspection

- Tire pressure, tread depth, and wear
- Rotation, if applicable
- Alignment check, optional
- Reset tire pressure monitor
- Check tire sealant expiration date, if equipped
- Check spare tire, if equipped

### Brakes

- Check brake system

### Visible and Functional Inspections

- Seat belt components
- Exhaust system
- Accelerator pedal
- Passenger compartment air filter, if equipped

- Engine air filter
- Hoses
- Belts
- Shocks and struts
- Steering components
- Axle boots or driveshaft and u-joints
- Compartment lift struts, if equipped
- Floor mats secured, no interference with pedals
- Horn
- Ignition lock, if equipped
- Starter switch
- Evaporative control system

### Lubricate

- Chassis components

### Special Application Services

- Severe Commercial Use Vehicles Only: Lubricate chassis components every oil change.

- Have underbody flushing service performed. See "Underbody Maintenance" in *Exterior Care* ⇨ 354.

## Recommended Fluids, Lubricants, and Parts

### Recommended Fluids and Lubricants

Fluids and lubricants identified below by name or specification, including fluids or lubricants not listed here, can be obtained from your dealer.

Usage	Fluid/Lubricant
Automatic Transmission	DEXRON ULV Automatic Transmission Fluid.
Engine Coolant	50/50 mixture of clean, drinkable water and use only DEX-COOL Coolant. See <i>Cooling System</i> ⇨ 302.
Engine Oil – 2.0L I4 Turbo (LSY) and 3.0L V6 Twin Turbo (LGY) Engines	Engine oil meeting the dexos1 specification of the proper SAE viscosity grade. ACDelco dexos1 full synthetic is recommended. See <i>Engine Oil</i> ⇨ 295.
Engine Oil – 6.2L V8 (LT4) Engine	Engine oil meeting the dexosR specification of the proper SAE viscosity grade. Mobil 1 dexosR full synthetic is recommended. See <i>Engine Oil</i> ⇨ 295.
Hood Latch Assembly, Secondary Latch, Pivots, Spring Anchor, and Release Pawl	Lubricant meeting requirements of NLGI #2, Category LB or GC-LB.
Hydraulic Brake System	DOT 4 Hydraulic Brake Fluid.
Key Lock Cylinders, Hood and Door Hinges	Multi-Purpose Lubricant, Superlube. See your dealer.
Manual Transmission	DEXRON III Automatic Transmission Fluid.
Rear Axle/Front Axle (All-Wheel Drive)	See your dealer.

---

Usage	Fluid/Lubricant
Transfer Case (All-Wheel Drive)	See your dealer.
Windshield Washer	Automotive windshield washer fluid that meets regional freeze protection requirements.

## Maintenance Records

After the scheduled services are performed, record the date, odometer reading, who performed the service, and the type of services performed in the boxes provided. Retain all maintenance receipts.

Date	Odometer Reading	Serviced By	Maintenance Stamp	Services Performed

Date	Odometer Reading	Serviced By	Maintenance Stamp	Services Performed

## Technical Data

### Vehicle Identification

Vehicle Identification Number (VIN) ..... 373  
 Vehicle Identification Number (VIN) (V-Series Blackwing Only) ..... 373  
 Service Parts Identification ..... 374

### Vehicle Data

Capacities and Specifications ..... 375  
 Engine Drive Belt Routing ..... 378

## Vehicle Identification

### Vehicle Identification Number (VIN)



This legal identifier is in the front corner of the instrument panel, on the driver side of the vehicle. It can be seen through the windshield from outside. The Vehicle Identification Number (VIN) also appears on the Vehicle Certification label and certificates of title and registration.

### Engine Identification

The eighth character in the VIN is the engine code. This code identifies the vehicle's engine, specifications, and replacement parts. See "Engine Specifications" under *Capacities and Specifications* ⇨ 375 for the vehicle's engine code.

## Vehicle Identification Number (VIN) (V-Series Blackwing Only)

A serialized plate can be found at the lower portion of the steering wheel.

The plate will correspond to the last six digits in the VIN.

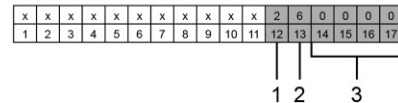

1. Vehicle Build:
  - 2 – Advanced Regular Production
  - 3 – Advanced Special Production
  - 4 – Regular Production
  - 5 – Special Production
2. Transmission
  - 6 – 6-speed Manual
  - 1 – 10-speed Automatic
3. Sequence Number

## Service Parts Identification

There may be a large barcode on the certification label on the center pillar that you can scan for the following information:

- Vehicle Identification Number (VIN)
- Model designation
- Paint information
- Production options

If there is not a large barcode on this label, then you will find this same information on a label inside of the trunk.

## Vehicle Data

### Capacities and Specifications

The following approximate capacities are given in metric and English conversions. See *Recommended Fluids and Lubricants* ⇨ 370 for more information.

Application	Capacities	
	Metric	English
Air Conditioning Refrigerant	For the air conditioning system refrigerant type and charge amount, see the refrigerant label under the hood. See your dealer for more information.	
Brake Fluid	0.4 L	0.4 qt
Engine Cooling System*		
2.0L I4 Engine	10.4 L	11.0 qt
3.0L V6 Engine with Rear Wheel Drive	12.1 L	12.8 qt
3.0L V6 Engine with All-Wheel Drive	12.3 L	13.0 qt
3.0L V6 Engine Intercoolers (RWD)	3.1 L	3.3 qt
3.0L V6 Engine Intercoolers (AWD)	3.0 L	3.2 qt
6.2L V8 Engine	13.1 L	13.8 qt
Engine Oil with Filter		



Application	Capacities	
	Metric	English
2.0L I4 Engine	5.0 L	5.3 qt
3.0L V6 Engine (RWD)	5.7 L	6.0 qt
3.0L V6 Engine (AWD)	6.2 L	6.5 qt
6.2L V8 Engine	8.5 L	9.0 qt
Front Axle	0.40 L	0.42 qt
Rear Axle		
Open Differential - Small	0.75 L	0.79 qt
Open Differential - Large	1.0 L	1.0 qt
Mechanical Limited Slip	1.0 L	1.0 qt
Electronic Limited Slip	1.5 L	1.5 qt
Fuel Tank	66.0 L	17.5 gal
Transfer Case (AWD)	0.80 L	0.85 qt
Wheel Nut Torque	190 N•m	140 lb ft

Application	Capacities	
	Metric	English
All capacities are approximate. When adding, be sure to fill to the approximate level, as recommended in this manual. Recheck fluid level after filling.		
*Engine cooling system capacity values are based on the entire cooling system and its components.		

### Engine Specifications

Engine	VIN Code	Transmission	Spark Plug Gap
2.0L I4 Engine (LSY)	K	Automatic	0.65–0.75 mm (0.026–0.030 in)
3.0L V6 Engine (LGY)	W	Automatic	0.65–0.75 mm (0.026–0.030 in)
6.2L V8 Engine (LT4)	6	Automatic Manual	0.725–0.875 mm (0.028–0.034 in)
Spark plug gaps are preset by the manufacturer. Re-gapping the spark plug is not recommended and can damage the spark plug.			

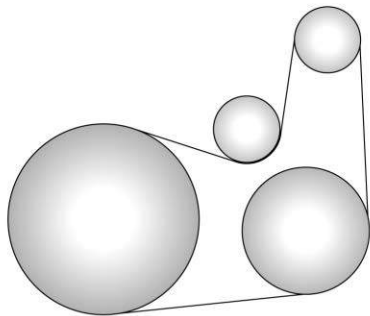
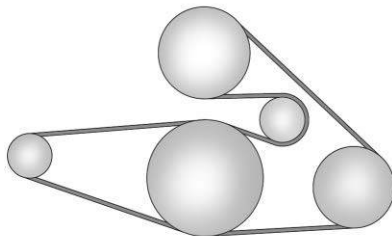
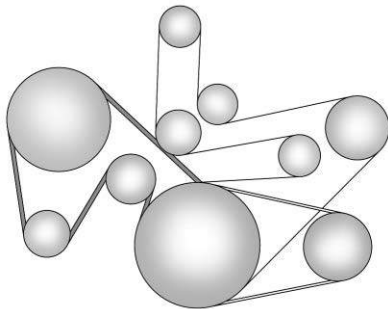
**Engine Drive Belt Routing****2.0L I4 Engine (LSY)****3.0L V6 Engine (LGY)****6.2L V8 Engine (LT4)**

## Customer Information

### Customer Information

Customer Satisfaction Procedure .....	379
Customer Assistance Offices .....	381
Customer Assistance for Text Telephone (TTY) Users .....	381
Online Account and Customer Support ...	381
GM Mobility Reimbursement Program (U.S. Only) .....	382
Roadside Assistance Program .....	382
Scheduling Service Appointments .....	384
Courtesy Transportation Program .....	384
Collision Damage Repair .....	385
Publication Ordering Information .....	387
Radio Frequency Statement .....	387

### Reporting Safety Defects

Reporting Safety Defects to the United States Government .....	388
Reporting Safety Defects to the Canadian Government .....	388
Reporting Safety Defects to General Motors .....	388

### Vehicle Data Recording and Privacy

Vehicle Data Recording and Privacy .....	388
Cybersecurity .....	389
Event Data Recorders .....	389

OnStar .....	390
Infotainment System .....	390

## Customer Information

### Customer Satisfaction Procedure

Your satisfaction and goodwill are important to your dealer and to Cadillac. Normally, any concerns with the sales transaction or the operation of the vehicle will be resolved by your dealer's sales or service departments. Sometimes, however, despite the best intentions of all concerned, misunderstandings can occur. If your concern has not been resolved to your satisfaction, the following steps should be taken:

**STEP ONE:** Discuss your concern with a member of dealership management. Normally, concerns can be quickly resolved at that level. If the matter has already been reviewed with the sales, service or parts manager, contact the owner of your dealership or the general manager

**STEP TWO:** If after contacting a member of dealership management, it appears your concern cannot be resolved by your dealership without further help, in the U.S., call the Cadillac Customer Assistance Center at 1-800-333-4223. In Canada, call the Canadian Cadillac Customer Care Centre at 1-888-446-2000.

We encourage you to call the toll-free number in order to give your inquiry prompt attention. Have the following information available to give the Customer Assistance representative:

- Vehicle Identification Number (VIN). This is available from the vehicle registration or title, or the plate at the top left of the instrument panel and visible through the windshield.
- Dealership name and location.
- Vehicle delivery date and present mileage.

When contacting Cadillac, remember that your concern will likely be resolved at a dealer's facility. That is why we suggest following Step One first.

**STEP THREE — U.S. Owners:** Both GM and your GM dealer are committed to making sure you are completely satisfied with your new vehicle. However, if you continue to remain unsatisfied after following the procedure outlined in Steps One and Two, you can file with the Better Business Bureau (BBB) AUTO LINE Program to enforce any additional rights you may have.

The BBB AUTO LINE Program is an out-of-court program administered by BBB National Programs, Inc. to settle automotive disputes regarding vehicle repairs or the interpretation

of the New Vehicle Limited Warranty. Although you may be required to resort to this informal dispute resolution program prior to filing a court action, use of the program is free of charge and your case will generally be heard within 40 days. If you do not agree with the decision given in your case, you may reject it and proceed with any other venue for relief available to you. When contacting the BBB AUTO LINE, you will need to provide the following information: Owner's name and address, Vehicle identification number (VIN), the Year, Make, Model, mileage of the vehicle and provide a description of the concern.

Contact the BBB AUTO LINE Program using the toll-free telephone number or write them at the following address:

BBB AUTO LINE Program  
BBB National Programs, Inc.  
1676 International Drive  
Suite 550  
McLean, VA 22102  
Telephone: 1-800-955-5100  
[www.bbbautoline.org](http://www.bbbautoline.org)

This program is available in all 50 states and the District of Columbia. Eligibility is limited by vehicle age, mileage, and other factors. General

Motors reserves the right to change eligibility limitations and/or discontinue its participation in this program.

**STEP THREE — Canadian Owners:** In the event that you do not feel your concerns have been addressed after following the procedure outlined in Steps One and Two, General Motors of Canada Company wants you to be aware of its participation in a no-charge mediation/arbitration program. General Motors of Canada Company has committed to binding arbitration of owner disputes involving factory-related vehicle service claims. The program provides for the review of the facts involved by an impartial third party arbiter, and may include an informal hearing before the arbiter. The program is designed so that the entire dispute settlement process, from the time you file your complaint to the final decision, should be completed in about 70 days. We believe our impartial program offers advantages over courts in most jurisdictions because it is informal, quick, and free of charge.

For further information concerning eligibility in the Canadian Motor Vehicle Arbitration Plan (CAMVAP), call toll-free 1-800-207-0685, or call the Cadillac Customer Care Centre, 1-888-446-2000, or write to:

General Motors Cadillac Customer Care Centre  
General Motors of Canada Company  
500 Wentworth Street W  
Oshawa, ON L1J 0C5

Your inquiry should be accompanied by the Vehicle Identification Number (VIN).

## Customer Assistance Offices

Cadillac is committed to assisting customers. Visit us online at [www.cadillac.com/support](http://www.cadillac.com/support) (U.S.) or [www.my.cadillac.ca](http://www.my.cadillac.ca) (Canada) to chat with us or find answers to commonly asked questions, tips, vehicle how-to instructions, and available support services.

Need more help? Use the phone numbers or mailing addresses below for additional assistance.

### United States and Puerto Rico

Cadillac Customer Assistance Center  
Cadillac Motor Car Division  
P.O. Box 33169  
Detroit, MI 48232-5169  
1-800-333-4223

TTY: Dial 711 relay service and contact 1-800-833-2438

Roadside Assistance: 1-800-224-1400

### Canada

Cadillac Customer Care Centre  
General Motors of Canada Company  
500 Wentworth Street W  
Oshawa, ON L1J 0C5  
1-888-446-2000 (English/French)  
Cadillac Roadside Assistance: 1-800-882-1112

### Overseas

Contact the local General Motors Business Unit.

## Customer Assistance for Text Telephone (TTY) Users





To assist customers who are deaf, hard of hearing, or speech-impaired and/or who use Text Telephones (TTYs), Cadillac is able to assist. Please dial the national 711 relay service and contact 1-800-833-2438. TTY users in Canada can dial 1-800-263-3830.

## Online Account and Customer Support

### Create a Cadillac Account (U.S.) at [cadillac.com](http://cadillac.com)

Learn more about your vehicle features, shop for and manage your connected services and OnStar plans, and access diagnostic information specific to your vehicle.

### Membership Benefits

-  : Download owner's manuals and view vehicle-specific how-to videos.
-  : View maintenance schedules, alerts, and Vehicle Diagnostic Information. Schedule service appointments.
-  : View service records from your dealership and add your own.
-  : Select a dealer and view locations, maps, phone numbers, and hours.
-  : Track your vehicle's warranty information.

 : View active recalls or search by Vehicle Identification Number (VIN). See *Vehicle Identification Number (VIN)* ⇨ 373 *Vehicle Identification Number (VIN) (V-Series Blackwing Only)* ⇨ 373.

 : Manage your profile and payment information. View your GM Rewards Card earnings and My Cadillac Rewards points.

 : Chat with online help representatives. Visit [cadillac.com](http://cadillac.com) and create an account today.

### Cadillac Account (Canada)

Visit your Cadillac Account at [cadillaccanada.ca/en](http://cadillaccanada.ca/en) (English) or [cadillaccanada.ca/fr](http://cadillaccanada.ca/fr) (French) to access similar benefits.

### GM Mobility Reimbursement Program (U.S. Only)

GENERAL MOTORS MOBILITY



This program is available to qualified applicants for cost reimbursement, up to certain limits, of eligible aftermarket adaptive equipment required for the vehicle, such as hand controls or a wheelchair/scooter lift for the vehicle.

To learn about the GM Mobility program, call the GM Mobility Assistance Center at 1-800-323-9935. Text Telephone (TTY) users, please dial the national 711 relay service and contact 1-800-323-9935.

### Roadside Assistance Program

U.S.: 1-800-224-1400.

Canada: 1-800-882-1112.

Text Telephone (TTY) Users (U.S. Only): 1-888-889-2438.

Service is available 24 hours a day, 365 days a year.

### Calling for Assistance

When calling Roadside Assistance, have the following information ready:

- Your name, home address, and home telephone number
- Telephone number of your location

- Location of the vehicle
- Model, year, color, and license plate number of the vehicle
- Odometer reading and Vehicle Identification Number (VIN)
- Description of the problem

### Coverage

Services are provided for the duration of the vehicle's powertrain warranty.

In the U.S., anyone driving the vehicle is covered. In Canada, a person driving the vehicle without permission from the owner is not covered.

Roadside Assistance is not a part of the New Vehicle Limited Warranty. General Motors North America and Cadillac reserve the right to make any changes or discontinue the Roadside Assistance program at any time without notification.

General Motors North America and Cadillac reserve the right to limit services or payment to an owner or driver if they decide the claims are made too often, or the same type of claim is made many times.

### Cadillac Owner Privileges™

- **Emergency Fuel Delivery:** Delivery of enough fuel for the vehicle to get to the nearest service station.
- **Lock-Out Service:** Service to unlock the vehicle if you are locked out. A remote unlock may be available if you have OnStar. For security reasons, the driver must present identification before this service is given.
- **Emergency Tow from a Public Road or Highway:** Tow to the nearest Cadillac dealer for warranty service, or if the vehicle was in a crash and cannot be driven. Assistance is not given when the vehicle is stuck in the sand, mud, or snow.
- **Flat Tire Change:** Service to change a flat tire with a spare tire. The spare tire, if equipped, must be in good condition and properly inflated. It is your responsibility for the repair or replacement of the tire if it is not covered by the warranty.
- **Battery Jump Start:** Service to jump start a dead battery.
- **Trip Interruption Benefits and Service:** If your trip is interrupted due to a warranty failure, incidental expenses may be

reimbursed. Items considered are hotel, meals, and rental car or a vehicle being delivered back to the customer, up to 500 miles. Contact Cadillac Roadside Assistance for Trip Interruption eligibility at the time of vehicle disablement.

### Cadillac Technician Roadside Assistance (U.S. Only)

Cadillac's exceptional Roadside Assistance is more than an auto club or towing service. It provides every Cadillac owner in the United States with the advantage of contacting a Cadillac advisor and, where available, a Cadillac trained dealer technician who can provide on-site service.

A dealer technician will travel to your location within a 30-mile radius of a participating Cadillac dealership. If beyond this radius, we will arrange to have your car towed to the nearest Cadillac dealership. Each technician travels with a specially equipped service vehicle complete with the necessary Cadillac parts and tools required to handle most roadside repairs.

### Services Not Included in Roadside Assistance

- Impound towing caused by violation of any laws
- Reimbursement of legal fines
- Reimbursement of police mandated tows
- Mounting, dismounting, or changing of snow tires, chains, or other traction devices
- Towing of anything attached to the vehicle like boats, campers, trailers, cargo boxes, etc.
- Vehicles stranded due to off-road driving

Service is not provided if a vehicle is in an area that is not accessible to the service vehicle or is not a regularly traveled or maintained public road, which includes ice and winter roads. Service is not provided on restricted roadways which can include and is not limited to, some highways, tunnels, toll roads, toll bridges, turnpikes, and service roads.



## Services Specific to Canadian-Purchased Vehicles

- **Fuel delivery:** Reimbursement is up to 7 liters. Diesel fuel delivery may be restricted. Propane and other fuels are not provided through this service.
- **Lock-Out Service:** Vehicle registration is required.
- **Trip Interruption Benefits and Assistance:** Must be over 150 km (93 mi) from where the trip was started to quality. Pre-authorization, original detailed receipts, and a copy of the repair orders are required. Once authorization has been received, the Roadside Assistance advisor will help to make arrangements and explain how to receive payment. Items considered are hotel, meals, and rental car or a vehicle being delivered back to the customer, up to 800 km.
- **Alternative Service:** If assistance cannot be provided right away, the Roadside Assistance advisor may give you permission to get local emergency road service. You will receive payment, up to \$100, after sending the original receipt to Roadside Assistance. Mechanical failures

may be covered, however any cost for parts and labor for repairs not covered by the warranty are the owner responsibility.

## Scheduling Service Appointments

When the vehicle requires warranty service, contact your dealer and request an appointment. By scheduling a service appointment and advising the service consultant of your transportation needs, your dealer can help minimize your inconvenience.

If the vehicle cannot be scheduled into the service department immediately, keep driving it until it can be scheduled for service, unless, of course, the problem is safety related. If it is, please call your dealership, let them know this, and ask for instructions.

If your dealer requests you to bring the vehicle for service, you are urged to do so as early in the work day as possible to allow for same-day repair.

## Courtesy Transportation Program

To enhance your ownership experience, we and our participating dealers are proud to offer Courtesy Transportation, a customer support program for vehicles with the

Bumper-to-Bumper (Base Warranty Coverage period in Canada), Federal Emission, Extended Powertrain or Electric specific warranties in both the U.S. and Canada.

Several Courtesy Transportation options are available to assist in reducing inconvenience when warranty repairs are required.

Courtesy Transportation is not a part of the New Vehicle Limited Warranty. A separate manual entitled "Limited Warranty and Owner Assistance Information" produced for new vehicles provides detailed warranty coverage information.

## Transportation Options

Warranty service can generally be completed while you wait. However, if you are unable to do so, your dealer may offer the following transportation options:

### Shuttle Service

This includes one-way or round-trip shuttle service within reasonable time and distance parameters of your dealer's area.

### **Public Transportation, Ridesharing App, or Fuel Reimbursement**

If overnight warranty repairs are needed, and public transportation or a ridesharing app is used, the expense must be supported by original receipts and within the maximum amount allowed by GM. If U.S. customers arrange their own transportation, limited reimbursement for reasonable fuel expenses may be available. Claim amounts should reflect actual costs and be supported by original receipts. See your dealer for information.

### **Courtesy Rental Vehicle**

For an overnight warranty repair, the dealer may provide an available courtesy rental vehicle or provide for reimbursement of a rental vehicle. Reimbursement is limited and must be supported by original receipts as well as a signed and completed rental agreement and meet state/provincial, local, and rental vehicle provider requirements. Requirements vary and may include minimum age requirements, insurance coverage, credit card, etc. Additional fees such as fuel, rental vehicle insurance, taxes, levies, usage fees, excessive mileage, or rental usage beyond the completion of the repair are also your responsibility.

It may not be possible to provide a like vehicle as a courtesy rental.

### **Additional Program Information**

All program options, such as shuttle service, may not be available at every dealer. Contact your dealer for specific availability.

General Motors reserves the right to unilaterally modify, change, or discontinue Courtesy Transportation at any time and to resolve all questions of claim eligibility pursuant to the terms and conditions described herein at its sole discretion.

### **Collision Damage Repair**

If the vehicle is involved in a collision and it is damaged, have the damage repaired by a qualified technician using the proper equipment and quality replacement parts. Poorly performed collision repairs diminish the vehicle resale value, and safety performance can be compromised in subsequent collisions.

### **Collision Parts**

Genuine GM Collision parts are new parts made with the same materials and construction methods as the parts with which the vehicle was originally built. Genuine GM Collision

parts are the best choice to ensure that the vehicle's designed appearance, durability, and safety are preserved. The use of Genuine GM parts can help maintain the GM New Vehicle Limited Warranty.

Recycled original equipment parts may also be used for repair. These parts are typically removed from vehicles that were total losses in prior crashes. In most cases, the parts being recycled are from undamaged sections of the vehicle. A recycled original equipment GM part may be an acceptable choice to maintain the vehicle's originally designed appearance and safety performance; however, the history of these parts is not known. Such parts are not covered by the GM New Vehicle Limited Warranty, and any related failures are not covered by that warranty.

Aftermarket collision parts are also available. These are made by companies other than GM and may not have been tested for the vehicle. As a result, these parts may fit poorly, exhibit premature durability/corrosion problems, and may not perform properly in subsequent collisions. Aftermarket parts are not covered by the GM New Vehicle Limited Warranty, and any vehicle failure related to such parts is not covered by that warranty.

## Repair Facility

GM also recommends that you choose a collision repair facility that meets your needs before you ever need collision repairs. Your dealer may have a collision repair center with GM-trained technicians and state-of-the-art equipment, or be able to recommend a collision repair center that has GM-trained technicians and comparable equipment.

## Insuring the Vehicle

Protect your investment in the GM vehicle with comprehensive and collision insurance coverage. There are significant differences in the quality of coverage afforded by various insurance policy terms. Many insurance policies provide reduced protection to the GM vehicle by limiting compensation for damage repairs by using aftermarket collision parts. Some insurance companies will not specify aftermarket collision parts. When purchasing insurance, we recommend that you ensure that the vehicle will be repaired with GM original equipment collision parts. If such insurance coverage is not available from your current insurance carrier, consider switching to another insurance carrier.

If the vehicle is leased, the leasing company may require you to have insurance that ensures repairs with Genuine GM Original Equipment Manufacturer (OEM) parts or Genuine Manufacturer replacement parts. Read the lease carefully, as you may be charged at the end of the lease for poor quality repairs.

## If a Crash Occurs

If there has been an injury, call emergency services for help. Do not leave the scene of a crash until all matters have been taken care of. Move the vehicle only if its position puts you in danger, or you are instructed to move it by a police officer.

Give only the necessary information to police and other parties involved in the crash.

For emergency towing, see *Roadside Assistance Program* ⇨ 382.

Gather the following information:

- Driver name, address, and telephone number
- Driver license number
- Owner name, address, and telephone number
- Vehicle license plate number

- Vehicle make, model, and model year
- Vehicle Identification Number (VIN)
- Insurance company and policy number
- General description of the damage to the other vehicle

Choose a reputable repair facility that uses quality replacement parts. See “Collision Parts” earlier in this section.

If the airbag has inflated, see *What Will You See after an Airbag Inflates?* ⇨ 57.

## Managing the Vehicle Damage Repair Process

In the event that the vehicle requires damage repairs, GM recommends that you take an active role in its repair. If you have a pre-determined repair facility of choice, take the vehicle there, or have it towed there. Specify to the facility that any required replacement collision parts be original equipment parts, either new Genuine GM parts or recycled original GM parts. Remember, recycled parts will not be covered by the GM vehicle warranty.

Insurance pays the bill for the repair, but you must live with the repair. Depending on your policy limits, your insurance company may

initially value the repair using aftermarket parts. Discuss this with the repair professional, and insist on Genuine GM parts. Remember, if the vehicle is leased, you may be obligated to have the vehicle repaired with Genuine GM parts, even if your insurance coverage does not pay the full cost.

If another party's insurance company is paying for the repairs, you are not obligated to accept a repair valuation based on that insurance company's collision policy repair limits, as you have no contractual limits with that company. In such cases, you can have control of the repair and parts choices as long as the cost stays within reasonable limits.

## Publication Ordering Information

### Service Manuals

Service manuals have the diagnosis and repair information on the engine/propulsion, transmission, axle, suspension, brakes, electrical system, steering system, body, etc.

## Customer Literature

Owner's manuals are written specifically for owners and are intended to provide basic operational information about the vehicle. The owner's manual includes the Maintenance Schedule for all models.

Customer literature publications available for purchase include owner's manuals, warranty manuals, and portfolios. Portfolios include an owner's manual, warranty manual, if applicable, and zip lock bag or pouch.

## Current and Past Models

Service manuals and customer literature are available for many GM vehicles.

To check availability and to order, call 1-800-551-4123 Monday–Friday, 8:00 a.m.–6:00 p.m. Eastern Time

For credit card orders only (VISA, MasterCard, or Discover), see Helm, Inc. at: [www.helminc.com](http://www.helminc.com).

To order by mail, write to:

Helm, Incorporated  
Attention: Customer Service  
47911 Halyard Drive  
Plymouth, MI 48170

Make checks payable in U.S. funds.

## Radio Frequency Statement

This vehicle uses license-exempt transmitters / receivers / systems that operate on a radio frequency that complies with Part 15/Part 18 of the Federal Communications Commission (FCC) rules and with Innovation, Science and Economic Development (ISED) Canada's license-exempt RSS(s) / RSP-100 / ICES-GEN.

Operation is subject to the following two conditions:

1. The device may not cause harmful interference.
2. The device must accept any interference received, including interference that may cause undesired operation of the device.

Changes or modifications to any of these systems by other than an authorized service facility could void authorization to use this equipment.

## Reporting Safety Defects

### Reporting Safety Defects to the United States Government

If you believe that your vehicle has a defect which could cause a crash or could cause injury or death, you should immediately inform the National Highway Traffic Safety Administration (NHTSA) in addition to notifying General Motors.

If NHTSA receives similar complaints, it may open an investigation, and if it finds that a safety defect exists in a group of vehicles, it may order a recall and remedy campaign. However, NHTSA cannot become involved in individual problems between you, your dealer, or General Motors.

To contact NHTSA, you may call the Vehicle Safety Hotline toll-free at 1-888-327-4236 (TTY: 1-877-561-7439); go to <https://www.safercar.gov>; or write to:

Administrator, NHTSA  
1200 New Jersey Avenue, S.E.,  
Washington, D.C., 20590

You can also obtain other information about motor vehicle safety from <https://www.safercar.gov>.

### Reporting Safety Defects to the Canadian Government

If you live in Canada, and you believe that the vehicle has a safety defect, notify Transport Canada immediately, and notify General Motors of Canada Company. Call Transport Canada at 1-800-333-0510; go to:

[www.tc.gc.ca/recalls](http://www.tc.gc.ca/recalls) (English)

[www.tc.gc.ca/rappels](http://www.tc.gc.ca/rappels) (French)

or write to:

Transport Canada  
Motor Vehicle Safety Directorate  
Defect Investigations and Recalls Division  
80 Noel Street  
Gatineau, QC J8Z 0A1

### Reporting Safety Defects to General Motors

In addition to notifying NHTSA (or Transport Canada) in a situation like this, notify General Motors.

In the U.S., call 1-800-458-8006, or write:

Cadillac Customer Assistance Center  
Cadillac Motor Car Division  
P.O. Box 33169  
Detroit, MI 48232-5169

In Canada, call 1-888-446-2000, or write:

Canadian Cadillac Customer Care Centre  
General Motors of Canada Company  
500 Wentworth Street W  
Oshawa, ON L1J 0C5

In Mexico, call 800-466-0805 or 800-212-2345.

In other Central America and Caribbean Countries, call 52-555-901-2369.

## Vehicle Data Recording and Privacy

The vehicle has a number of computers that record information about the vehicle's performance and how it is driven or used. For example, the vehicle uses computer modules to

monitor and control engine and transmission performance, to monitor the conditions for airbag deployment and deploy them in a crash, and, if equipped, to provide antilock braking to help the driver control the vehicle. These modules may store data to help the dealer technician service the vehicle or to help GM improve safety or features. Some modules may also store data about how the vehicle is operated, such as rate of fuel consumption or average speed. These modules may retain personal preferences, such as radio presets, seat positions, and temperature settings.

## Cybersecurity

GM collects information about the use of your vehicle including operational and safety related information. We collect this information to provide, evaluate, improve, and troubleshoot our products and services and to develop new products and services. The protection of vehicle electronics systems and customer data from unauthorized outside electronic access or control is important to GM. GM maintains appropriate security standards, practices, guidelines and controls aimed at defending the vehicle and the vehicle service ecosystem against unauthorized electronic

access, detecting possible malicious activity in related networks, and responding to suspected cybersecurity incidents in a timely, coordinated and effective manner. Security incidents could impact your safety or compromise your private data. To minimize security risks, please do not connect your vehicle electronic systems to unauthorized devices or connect your vehicle to any unknown or untrusted networks (such as Bluetooth, Wi-Fi or similar technology). In the event you suspect any security incident impacting your data or the safe operation of your vehicle, please stop operating your vehicle and contact your dealer.

## Event Data Recorders

This vehicle is equipped with an Event Data Recorder (EDR). The main purpose of an EDR is to record, in certain crash or near crash-like situations, such as an air bag deployment or hitting a road obstacle, data that will assist in understanding how a vehicle's systems performed. The EDR is designed to record data related to vehicle dynamics and safety systems for a short period of time, typically 30 seconds or less. The EDR in this vehicle is designed to record such data as:

- How various systems in your vehicle were operating;
- Whether or not the driver and passenger safety belts were buckled/fastened;
- How far (if at all) the driver was depressing the accelerator and/or brake pedal; and,
- How fast the vehicle was traveling.

These data can help provide a better understanding of the circumstances in which crashes and injuries occur.

### Note

EDR data are recorded by your vehicle only if a non-trivial crash situation occurs; no data are recorded by the EDR under normal driving conditions and no personal data (e.g., name, gender, age, and crash location) are recorded. However, other parties, such as law enforcement, could combine the EDR data with the type of personally identifying data routinely acquired during a crash investigation.

To read data recorded by an EDR, special equipment is required, and access to the vehicle or the EDR is needed. In addition to the vehicle manufacturer, other parties, such

as law enforcement, that have the special equipment, can read the information if they have access to the vehicle or the EDR.

GM will not access these data or share it with others except: with the consent of the vehicle owner or, if the vehicle is leased, with the consent of the lessee; in response to an official request by police or similar government office; as part of GM's defense of litigation through the discovery process; or, as permitted by law. Data that GM collects or receives may also be used for GM research needs or may be made available to others for research purposes, where a need is shown and the data is not tied to a specific vehicle or vehicle owner.

## OnStar

If the vehicle is equipped with OnStar and has an active service plan, additional data may be collected and transmitted through the OnStar system. This includes information about the vehicle's operation; collisions involving the vehicle; the use of the vehicle and its features, including infotainment; and the location and approximate GPS speed of the vehicle. Refer to the OnStar Terms and Conditions and Privacy Statement on the OnStar website.

See *OnStar Additional Information* ⇨ 392.

## Infotainment System

If the vehicle is equipped with a navigation system as part of the infotainment system, use of the system may result in the storage of destinations, addresses, telephone numbers, and other trip information. See the infotainment section for information on stored data and for deletion instructions.

## OnStar

### OnStar Overview

OnStar Overview .....391

### OnStar Services

Emergency .....392

Security ..... 392

### OnStar Additional Information

OnStar Additional Information ..... 392

## OnStar Overview



 White OnStar Button

 Blue OnStar Button

 Red Emergency Button

This vehicle may be equipped with a comprehensive, in-vehicle system that can connect to an OnStar Advisor for Emergency, Security, Navigation, Connections, and Diagnostics Services. OnStar services may require a paid service plan and data plan. OnStar requires the vehicle battery and electrical system, cellular service, and GPS satellite signals to be available and operating. OnStar acts as a link to existing emergency service providers. OnStar may collect information about you and your vehicle, including location information. See OnStar User Terms, Privacy Statement, and

Software Terms for more details including system limitations at [www.onstar.com](http://www.onstar.com) (U.S.) or [www.onstar.ca](http://www.onstar.ca) (Canada).

The OnStar system status light is next to the OnStar buttons. If the status light is:

- Solid Green: System is ready.
- Flashing Green: On a call.
- Red: Indicates a problem.
- Off: System is off. Press  twice to speak with an OnStar Advisor.

Press  or call 1-888-4ONSTAR (1-888-466-7827) to speak to an Advisor.

Press  to answer and end incoming calls with a live OnStar Advisor.

Press  to connect to an Advisor to:

- Verify account information or update contact information.
- Get driving directions.
- Receive a Diagnostic check of the vehicle's key operating systems.
- Receive Roadside Assistance.
- Manage Wi-Fi Settings, if equipped.



Press **SOS** to get a priority connection to an OnStar Advisor available 24/7 to:

- Get help for an emergency.
- Be a Good Samaritan or respond to an AMBER Alert.
- Get assistance in severe weather or other crisis situations and find evacuation routes.

## OnStar Services

### Emergency

Emergency Services require an active safety and security plan. With Automatic Crash Response, built-in sensors can automatically alert a specially trained OnStar Advisor who is immediately connected in to the vehicle to help.

Press **SOS** for a priority connection to an OnStar Advisor who can contact emergency service providers, direct them to your exact location, and relay important information.

With OnStar Crisis Assist, specially trained Advisors are available 24 hours a day, 7 days a week, to provide a central point of contact, assistance, and information during a crisis.

With Roadside Assistance, Advisors can locate a nearby service provider to help with a flat tire, a battery jump, or an empty gas tank.

### Security

If equipped, OnStar provides these services:

- With Stolen Vehicle Assistance, OnStar Advisors can use GPS to pinpoint the vehicle and help authorities quickly recover it.
- With Remote Ignition Block, if equipped, OnStar can block the vehicle from being restarted.
- With Stolen Vehicle Slowdown, if equipped, OnStar can work with law enforcement to gradually slow the vehicle down.

### Theft Alarm Notification

If equipped, if the doors are locked and the vehicle alarm sounds, a notification by text, email, or phone call will be sent. If the vehicle is stolen, an OnStar Advisor can work with authorities to recover the vehicle.

## OnStar Additional Information

### In-Vehicle Audio Messages

Audio messages may play important information at the following times:

- Prior to vehicle purchase. Press **On** to set up an account.
- After change in ownership and at 90 days.

### Transferring Service

Press **On** to request account transfer eligibility information. The Advisor can cancel or change account information.

### Selling/Transferring the Vehicle

Call 1-888-4ONSTAR (1-888-466-7827) immediately to terminate your OnStar or connected services if the vehicle is disposed of, sold, transferred, or if the lease ends.

### Reactivation for Subsequent Owners

Press **On** and follow the prompts to speak to an Advisor as soon as possible. The Advisor will update vehicle records and explain OnStar or connected service options.

## How OnStar Service Works

Automatic Crash Response, Emergency Services, Crisis Assist, Stolen Vehicle Assistance, Remote Services, and Roadside Assistance are available on most vehicles. Not all OnStar services are available everywhere or on all vehicles. For more information, a full description of OnStar services, system limitations, and OnStar User Terms, Privacy Statement, and Software Terms:

- Call 1-888-4ONSTAR (1-888-466-7827).
- See [www.onstar.com](http://www.onstar.com) (U.S.).
- See [www.onstar.ca](http://www.onstar.ca) (Canada).
- Call TTY 1-877-248-2080.
- Press  to speak with an Advisor.

OnStar or connected services cannot work unless the vehicle is in a place where OnStar has an agreement with a wireless service provider for service in that area. The wireless service provider must also have coverage, network capacity, reception, and technology compatible with OnStar or connected services. Service involving location information about the vehicle cannot work unless GPS signals are available, unobstructed, and compatible with the OnStar hardware. OnStar or connected

services may not work if the OnStar equipment is not properly installed or it has not been properly maintained. If equipment or software is added, connected, or modified, OnStar or connected services may not work. Other problems beyond the control of OnStar — such as hills, tall buildings, tunnels, weather, electrical system design and architecture of the vehicle, damage to the vehicle in a crash, or wireless phone network congestion or jamming — may prevent service.

See *Radio Frequency Statement* ⇨ 387.

## Services for People with Disabilities

Advisors provide services to help with physical disabilities and medical conditions.

Press  to help:

- Find a hotel, restaurant, etc., that meets accessibility needs.
- Provide directions to the closest hospital or pharmacy in urgent situations.

## TTY Users

OnStar has the ability to communicate to deaf, hard-of-hearing, or speech-impaired customers while in the vehicle. The available TTY system provides in-vehicle access to all OnStar services, except OnStar Turn-by-Turn Navigation.

If equipped, from the infotainment home screen, access TTY by touching Settings > Apps > Phone > TTY > Enable OnStar TTY Mode. When TTY mode is on, phone calls can be made or received with OnStar using the infotainment display.

## OnStar Personal Identification Number (PIN)

A PIN is needed to access some OnStar services. The PIN will need to be changed the first time when speaking with an Advisor. To change the OnStar PIN, contact an OnStar Advisor by pressing  or calling 1-888-4ONSTAR.

## Warranty

OnStar equipment may be warranted as part of the vehicle warranty.

## Languages

The vehicle can be programmed to respond in multiple languages. Press  and ask for an Advisor. Advisors are available in English, Spanish, and French. Available languages may vary by country.

## Potential Issues

OnStar cannot perform Remote Door Unlock or Stolen Vehicle Assistance after the vehicle has been off continuously for an extended period of time without being started. To find out the duration of time that applies for the vehicle, contact an OnStar Advisor by pressing  or calling 1-888-4ONSTAR. If the vehicle has not been started for an extended period of time, OnStar can contact Roadside Assistance or a locksmith to help gain access to the vehicle.

## Global Positioning System (GPS)

- Obstruction of the GPS can occur in a large city with tall buildings; in parking garages; around airports; in tunnels and underpasses; or in an area with very dense trees. If GPS signals are not available, the OnStar system should still operate to call OnStar. However, OnStar could have difficulty identifying the exact location.

- In emergency situations, OnStar can use the last stored GPS location to send to emergency responders.

A temporary loss of GPS can cause loss of the ability to send a Turn-by-Turn Navigation route. The Advisor may give a verbal route or may ask for a call back after the vehicle is driven into an open area.

## Cellular and GPS Antennas

Cellular reception is required for OnStar to send remote signals to the vehicle. Do not place items over or near the antenna to prevent blocking cellular and GPS signal reception.

## Unable to Connect to OnStar Message

If there is limited cellular coverage or the cellular network has reached maximum capacity, this message may come on. Press  to try the call again or try again after driving a few miles into another cellular area.

## Vehicle and Power Issues

OnStar services require a vehicle electrical system, wireless service, and GPS satellite technologies to be available and operating for

features to function properly. These systems may not operate if the battery is discharged or disconnected.

## Add-on Electrical Equipment

The OnStar system is integrated into the electrical architecture of the vehicle. Do not add any electrical equipment. See *Add-On Electrical Equipment* ⇨ 285. Added electrical equipment may interfere with the operation of the OnStar system and cause it to not operate.

## Vehicle Software Updates

OnStar or GM may remotely deliver software updates or changes to the vehicle without further notice or consent. These updates or changes may enhance or maintain safety, security, or the operation of the vehicle or the vehicle systems. Software updates or changes may affect or erase data or settings that are stored in the vehicle, such as saved navigation destinations or pre-set radio stations. Neither OnStar nor GM is responsible for any affected or erased data or settings. These updates or changes may also collect personal information. Such collection is described in the OnStar privacy statement or separately disclosed at the time of installation. These updates

or changes may also cause a system to automatically communicate with GM servers to collect information about vehicle system status, identify whether updates or changes are available, or deliver updates or changes. An active OnStar agreement constitutes consent to these software updates or changes and agreement that either OnStar or GM may remotely deliver them to the vehicle.

### Privacy

The complete OnStar Privacy Statement may be found at [www.onstar.com](http://www.onstar.com) (U.S.), or [www.onstar.ca](http://www.onstar.ca) (Canada). We recommend that you review it. If you have any questions, call 1-888-4ONSTAR (1-888-466-7827) or press  to speak with an Advisor. Users of wireless communications are cautioned that the privacy of any information sent via wireless cellular communications cannot be assured. Third parties may unlawfully intercept or access transmissions and private communications without consent.

### OnStar – Software Acknowledgements

To obtain the source code under GPL, LGPL, MPL, and other open source licenses, that is contained in this product, please visit

[www.opensourceautomotive.com/an/GM](http://www.opensourceautomotive.com/an/GM). In addition to the source code, all referred license terms, warranty disclaimers, and copyright notices are available for download. This offer is valid for a period of three years after our last shipment of this product. This offer is valid to anyone in receipt of this information.

\*Provided through Continental Automotive Systems, Inc., who is solely responsible for provisions of related OSS compliance.

## Connected Services

### Connected Services

Navigation .....	396
Connections .....	396
Diagnostics .....	398

## Connected Services

### Navigation

Navigation requires a specific OnStar or connected service plan.

Press  to receive Turn-by-Turn directions or have them sent to the vehicle navigation screen, if equipped. A destination transfer from OnStar will show the detail view of the destination when it is transferred from OnStar to the Navigation application. See [www.onstar.com](http://www.onstar.com) for a coverage map. Services vary by model. Map coverage is available in the United States and Canada.

### Turn-by-Turn Navigation

1. Press  to connect to an Advisor.
2. Request directions to be downloaded to the vehicle.

### Send Directions to Vehicle

If equipped, directions can be sent to the navigation screen.

Press , then ask the Advisor to download directions to the navigation system, if equipped. After the call ends, the navigation screen will provide prompts to begin driving

directions. Routes that are sent to the navigation screen can only be canceled through the navigation system.

See [www.onstar.com](http://www.onstar.com) (U.S.) or [www.onstar.ca](http://www.onstar.ca) (Canada).

## Connections

The following services help with staying connected.

For coverage maps, see [www.onstar.com](http://www.onstar.com) (U.S.) or [www.onstar.ca](http://www.onstar.ca) (Canada).

### Ensuring Security

- Change the default passwords for the Wi-Fi hotspot and myCadillac app. Make these passwords different from each other and use a combination of letters and numbers to increase the security.
- Change the default name of the Service Set Identifier (SSID). This is the network name that is visible to other wireless devices. Choose a unique name and avoid family names or vehicle descriptions.

## Wi-Fi Hotspot

If equipped, the vehicle has a built-in Wi-Fi hotspot that provides access to the Internet and web content at 5G speed. Up to seven mobile devices can be connected. A data plan is required. Use the in-vehicle controls only when it is safe to do so.

1. To retrieve Wi-Fi hotspot information, touch the Wi-Fi Hotspot icon on the infotainment home screen.
2. The Wi-Fi settings will display the Wi-Fi hotspot name (SSID), password, and on some vehicles, the connection type (no Internet connection, 3G, 4G, 4G LTE, 5G), and signal quality (poor, good, excellent). The connection type icon (3G, 4G, 4G LTE, 5G) shows connection to Wi-Fi. It is possible that the icon may not illuminate even though the vehicle has an active connection.
3. To change the SSID or password, press  or call 1-888-4ONSTAR to connect with an Advisor. On some vehicles, the SSID and password can be changed in the Wi-Fi Hotspot menu.

After initial set-up, your vehicle's Wi-Fi hotspot will connect automatically to your mobile devices. Manage data usage by turning Wi-Fi

on or off on your mobile device, using the myCadillac app, or by contacting an OnStar Advisor. On some vehicles, Wi-Fi can also be managed from the Wi-Fi Hotspot menu.

## myCadillac App

Access the myCadillac app from your vehicle's infotainment home screen, if equipped, or download the myCadillac mobile app to compatible Apple and Android smartphones, if available. Cadillac users can access the following services:

- Remotely start/stop the vehicle, if factory-equipped.
- Lock/unlock doors, if equipped with automatic locks.
- Activate the horn and lamps.
- Check the vehicle fuel level, oil life, or tire pressure, if factory-equipped with the Tire Pressure Monitor System.
- Send destinations to the vehicle.
- Locate the vehicle on a map (U.S. market only).
- Turn the vehicle's Wi-Fi hotspot on/off, manage settings, and monitor data consumption, if equipped.

- Locate a dealer and schedule service.
- Request Roadside Assistance.
- Set a parking reminder with pin drop, take a photo, make a note, and set a timer.
- Connect with Cadillac on social media.

Features are subject to change. For myCadillac app information and compatibility, see [my.cadillac.com](http://my.cadillac.com).

An active OnStar or connected service plan may be required. A compatible device, factory-installed remote start, and power locks are required. Data rates apply. See [www.onstar.com](http://www.onstar.com) for details and system limitations.

## Remote Services

Contact an OnStar Advisor to unlock the doors or sound the horn and flash the lamps.

## Marketplace

OnStar Advisors can provide offers from restaurants and retailers on your route, help locate hotels, or book a room. These services vary by market.

## Diagnostics

By monitoring and reporting on the vehicle's main systems, OnStar Advanced Diagnostics, if equipped, provides a way to keep up on maintenance. Capabilities vary by model.

See [www.onstar.com](http://www.onstar.com) for details and system limitations. Features are subject to change.

For updates on feature capabilities, see [my.cadillac.com](http://my.cadillac.com). Message and data rates may apply.

# Index

## A

Accessories and Modifications..... 287

Accessory Power..... 197

Active

    Fuel Management..... 198

    Rev Match..... 206

Adaptive

    Cruise Control..... 110, 225

    Forward Lighting (AFL)..... 126

    Forward Lighting (AFL) Light..... 110

Additional

    OnStar Information..... 392

Add-On Electrical Equipment..... 285

Adjustments

    Lumbar, Front Seats..... 38

    Thigh Support..... 37

Advanced

    Driver Assistance Systems..... 250

Agreements

    Trademarks and License..... 164

Air

    Cleaner/Filter, Engine..... 299

    Conditioning..... 167

    Filter Life System..... 299

    Filter, Passenger Compartment..... 171

    Vents..... 170

Airbags

    Adding Equipment to the Vehicle..... 62

    Passenger Status Indicator..... 100

    Readiness Light..... 100

    Replacing System Parts after a Crash..... 63

    Servicing Airbag-Equipped Vehicles..... 61

Airbag System..... 53

    Check..... 62

    How Does an Airbag Restrain?..... 57

    Passenger Sensing System..... 58

    What Makes an Airbag Inflate?..... 57

    What Will You See after an Airbag  
    Inflates?..... 57

    When Should an Airbag Inflate?..... 56

    Where Are the Airbags?..... 54

Alarm

    Vehicle Security..... 22

Alert

    Blind Zone Steering Assist (BZSA)..... 268

    Lane Change (LCA)..... 266

    Rear Cross Traffic..... 258

    Rear Pedestrian..... 258

    Side Blind Zone (SBZA)..... 266

All-Season Tires..... 326

All-Wheel Drive..... 207, 312

    Light..... 104

Ambient Lighting..... 131

AM-FM Radio..... 138

Antenna

    Multi-band..... 140



Antilock Brake System (ABS).....	207
Warning Light.....	104
Appearance Care	
Exterior.....	354
Interior.....	359
Apple CarPlay and Android Auto.....	158
Assistance Program, Roadside.....	382
Assistance Systems	
Advanced.....	250
Automatic Emergency Braking (AEB).....	261
Automatic Parking Assist (APA).....	255
Blind Zone Alert (SBZA).....	266
Blind Zone Steering (BZSA).....	268
Driver Attention.....	270
Driving.....	259
Forward Collision Alert (FCA) System....	259
Front Pedestrian Braking (FPB).....	264
Lane Change Alert (LCA).....	266
Lane Keep Assist (LKA).....	272
Parking.....	253
Parking and Backing.....	251
Rear Cross Traffic Alert (RCTA).....	258
Rear Pedestrian Alert.....	258
Rear Vision Camera (RVC).....	251
Reverse Automatic Braking (RAB).....	257
Surround Vision Recorder.....	273
Surround Vision System.....	252
Traffic Sign.....	269

Audio	
Bluetooth.....	141
Automatic	
Dimming Mirrors.....	27
Door Locks.....	16
Emergency Braking (AEB) Disabled	
Light.....	105
Headlamp System.....	126
Parking Assist (APA).....	255
Transmission.....	200
Transmission Fluid.....	298
Vehicle Hold Light.....	104
Automatic Transmission	
Manual Mode.....	203
Automatic Vehicle Hold (AVH).....	209
Auto Stop	
Indicator.....	109
Avoiding Untrusted Media Devices.....	141

## B

Battery	
Exterior Lighting Battery Saver.....	132
Load Management.....	132
Power Protection.....	132
Battery - North America.....	312, 349
Blade Replacement, Wiper.....	313
Bluetooth	
Audio.....	141
Overview.....	153, 154

Brake	
Fluid.....	311
Pad Life System.....	310
System Warning Light.....	103
Brake Pad Life System.....	310
Brakes.....	308
Antilock.....	207
Brake Assist.....	209
Electric Brake Boost.....	207
Electric Parking Brake.....	208
Braking.....	174
Automatic Emergency (AEB).....	261
Front Pedestrian (FPB) System.....	264
Reverse Automatic.....	257
Break-In, New Vehicle.....	191
Buckle To Drive.....	46
Bulb Replacement	
Headlamp Aiming.....	315
Buying New Tires.....	339

## C

Calibration	
Compass.....	87
California	
Perchlorate Materials Requirements....	287
California Proposition 65 Warning.....	1
Camera	
Rear Vision (RVC).....	251
Canadian Vehicle Owners.....	2

Capacities and Specifications..... 375

Carbon Monoxide

    Engine Exhaust..... 199

    Trunk..... 17

    Winter Driving..... 186

Cargo

    Tie-Downs..... 83

Caution, Danger, and Warning..... 2

Center Console

    Storage..... 82

Charging

    System Light..... 101

    Wireless..... 88

Check Engine Light (Malfunction Indicator)..... 101

Child Restraints

    Infants and Young Children..... 65

    Lower Anchors and Tethers for Children..... 70

    Older Children..... 63

    Securing..... 76, 78

    Systems..... 67

Child Safety Locks..... 17

Circuit Breakers..... 317

Cleaning

    Exterior Care..... 354

    Interior Care..... 359

Climate Control Systems

    Dual Automatic..... 167

Clock..... 88

Cluster, Instrument..... 92

Clutch, Hydraulic..... 298

Collision Alert

    Forward (FCA) System..... 259

Collision Damage Repair..... 385

Compartments

    Storage..... 81

Compass..... 87

Composite Materials..... 192

Compressor Kit, Tire Sealant..... 344

Connected Services

    Connections..... 396

    Diagnostics..... 398

    Navigation..... 396

Connections

    Connected Services..... 396

Control

    Traction and Electronic Stability..... 210

Control of a Vehicle..... 174

Controls

    Steering Wheel..... 135

Convex Mirrors..... 25

Coolant

    Engine Temperature Gauge..... 97

    Engine Temperature Warning Light..... 107

Cooling..... 167

Cooling System..... 302

Cornering Lamps..... 128

Courtesy Lamps..... 129

Courtesy Transportation Program..... 384

Cruise Control..... 221

    Adaptive..... 225

    Light..... 110

    Super..... 235

Cupholders..... 81

Customer Assistance

    Offices..... 381

    Text Telephone (TTY) Users..... 381

Customer Information

    Publications Ordering Information..... 387

Customer Satisfaction Procedure..... 379

Customer Support

    and Online Account..... 381

Cybersecurity..... 389

**D**

Damage Repair, Collision..... 385

Danger, Warning, and Caution..... 2

Dashboard..... 4

Data Collection

    Infotainment System..... 390

    OnStar..... 390

Data Recorder

    Performance..... 147

Data Recorders, Event..... 389

Daytime Running Lamps (DRL)..... 126

Defensive Driving..... 174

Delayed Locking.....	16
Destination.....	143
Diagnostics	
Connected Services.....	398
Differential, Limited-Slip.....	221
Disabled Vehicle	
Transporting.....	352
Distracted	
Driving.....	173
Distracted Driving.....	173
Dome Lamps.....	129
Door	
Ajar Light.....	111
Delayed Locking.....	16
Locks.....	13
Power Locks.....	16
Drive Belt Routing, Engine.....	378
Driver	
Assistance Systems, Advanced.....	250
Attention Assist.....	270
Attention Assist Light.....	111
Information Center (DIC).....	111
Mode Control.....	211
Mode Control Light.....	107
Teen.....	161
Drive Systems	
All-Wheel Drive.....	207, 312
Driving	
Assistance Systems.....	259

Better Fuel Economy.....	173
Characteristics and Towing Tips.....	279
Defensive.....	174
Hill and Mountain Roads.....	185
If the Vehicle is Stuck.....	187
Impaired.....	174
Loss of Control.....	176
Off-Road Recovery.....	176
Performance.....	217
Track Events and Competitive.....	176
Vehicle Load Limits.....	187
Wet Roads.....	184
Winter.....	186
Dual	
Automatic Climate Control System.....	167

## E

Electric	
Brake Boost.....	207
Parking Brake.....	208
Parking Brake Light.....	103
Electrical	
Equipment, Add-On.....	285
System Overload.....	315
Electrical System	
Engine Compartment Fuse Block.....	317
Fuses and Circuit Breakers.....	317
Instrument Panel Fuse Block.....	319
Rear Compartment Fuse Block.....	323

Electronic Stability Control (ESC) Off	
Light.....	106
Emergency	
OnStar.....	392
Engine	
Air Cleaner/Filter.....	299
Air Filter Life System.....	299
Check Light (Malfunction Indicator).....	101
Compartment Overview.....	290
Coolant Temperature Gauge.....	97
Coolant Temperature Warning Light....	107
Cooling System.....	302
Drive Belt Routing.....	378
Exhaust.....	199
Heater.....	196
Oil Life System.....	297
Oil Pressure Gauge.....	96
Oil Pressure Light.....	109
Oil Temperature Gauge.....	97
Overheating.....	306
Power Messages.....	121
Running While Parked.....	199
Starting.....	193
Entry Lighting.....	130
Equipment, Towing.....	284
Event Data Recorders.....	389
Exit Lighting.....	130
Extended Parking.....	198
Extender, Seat Belt.....	51

Exterior  
 Lamp Controls..... 124  
 Lamps Off Reminder..... 125  
 Lighting Battery Saver..... 132

**F**

Filter  
 Engine Air Cleaner..... 299  
 Flashers, Hazard Warning..... 128  
 Flash-to-Pass..... 126  
 Flat Tire..... 343  
 Floor Mats..... 362  
 Fluid  
 Automatic Transmission..... 298  
 Brakes..... 311  
 Washer..... 307  
 Folding Mirrors..... 26  
 Frequency Statement  
 Radio..... 387  
 Front  
 Heated and Ventilated Seats..... 42  
 Fuel  
 Recommended..... 275, 276  
 Additives..... 276  
 Economy, Driving for Better..... 173  
 Filling a Portable Fuel Container..... 278  
 Filling the Tank..... 277  
 Foreign Countries..... 276  
 Gauge..... 95

Low Fuel Warning Light..... 109  
 Management, Active..... 198  
 Prohibited Fuels..... 276  
 Top Tier..... 275

Fuses

Engine Compartment Fuse Block..... 317  
 Fuses and Circuit Breakers..... 317  
 Instrument Panel Fuse Block..... 319  
 Rear Compartment Fuse Block..... 323

**G**

Garage Door Opener..... 121  
 Programming..... 121  
 Gas Strut(s)..... 314  
 Gauges  
 Engine Coolant Temperature..... 97  
 Engine Oil Pressure..... 96  
 Engine Oil Temperature..... 97  
 Fuel..... 95  
 Odometer..... 94  
 Speedometer..... 94  
 Tachometer..... 94  
 Transmission Temperature..... 98  
 Trip Odometer..... 94  
 Warning Lights and Indicators..... 90  
 General Information  
 Service and Maintenance..... 364  
 Towing..... 278  
 Vehicle Care..... 287

Global Positioning System (GPS)..... 144  
 Glove Box..... 81  
 GM Mobility Reimbursement Program..... 382  
 Guidance  
 Problems with the Route..... 145

**H**

Hazard Warning Flashers..... 128  
 Headlamps  
 Adaptive Forward Lighting (AFL)..... 126  
 Aiming..... 315  
 Automatic..... 126  
 Daytime Running Lamps (DRL)..... 126  
 Flash-to-Pass..... 126  
 High/Low Beam Changer..... 125  
 High-Beam On Light..... 110  
 Lamps On Reminder..... 110  
 Leveling Control..... 128  
 Head Restraints..... 34  
 Head-Up Display (HUD)..... 117  
 Heated  
 Mirrors..... 27  
 Steering Wheel..... 85  
 Ventilated Front Seats..... 42  
 Heater  
 Engine..... 196  
 Heating..... 167  
 High-Beam On Light..... 110  
 High-Speed Operation..... 332

Hill and Mountain Roads.....	185
Hill Start Assist (HSA).....	209
Hood.....	288
Horn.....	86
How to Wear Seat Belts Properly.....	46
HVAC.....	167
Hydraulic Clutch.....	298
<b>I</b>	
Ignition Positions.....	192
Immobilizer.....	24
Indicator	
Auto Stop.....	109
Pedestrian Ahead.....	105
Speed Limiter.....	95
Vehicle Ahead.....	105
Indicators	
Warning Lights and Gauges.....	90
Infants and Young Children, Restraints.....	65
Information	
Publication Ordering.....	387
Infotainment	
Using the System.....	136
Infotainment System.....	390
Inspection	
Multi-Point Vehicle.....	368
Instrument Cluster.....	92
Instrument Panel Overview.....	4

Interior	
Rearview Mirrors.....	28
Introduction.....	2, 133

**J**

Jump	
Starting - North America.....	349

**K**

Keys.....	6
Remote.....	7
Remote Operation.....	7

**L**

Labeling, Tire Sidewall.....	328
Lamps	
Cornering.....	128
Courtesy.....	129
Daytime Running (DRL).....	126
Dome.....	129
Exterior Controls.....	124
Exterior Lamps Off Reminder.....	125
Exterior Lighting Battery Saver.....	132
Flash-to-Pass.....	126
High/Low Beam Changer.....	125
Malfunction Indicator (Check Engine)....	101
On Reminder.....	110
Reading.....	129

Lane	
Keep Assist Light.....	105
Lap-Shoulder Belt.....	48
LATCH, Lower Anchors and Tethers for	
Children.....	70
LATCH System	
Replacing Parts after a Crash.....	76
LED Lighting.....	315
Leveling Control	
Headlamp.....	128
Lighting	
Adaptive Forward.....	126
Ambient.....	131
Entry.....	130
Exit.....	130
Illumination Control.....	129
LED.....	315
Lights	
Adaptive Cruise Control.....	110
Adaptive Forward Lighting (AFL)	
Light.....	110
Airbag Readiness.....	100
All-Wheel-Drive.....	104
Antilock Brake System (ABS)	
Warning.....	104
Automatic Emergency Braking (AEB)	
Disabled.....	105
Automatic Vehicle Hold.....	104
Brake System Warning.....	103

Charging System..... 101  
 Check Engine (Malfunction Indicator)... 101  
 Cruise Control Light..... 110  
 Door Ajar..... 111  
 Driver Attention Assist..... 111  
 Driver Mode Control..... 107  
 Electric Parking Brake..... 103  
 Electronic Stability Control (ESC), Off... 106  
 Engine Coolant Temperature  
 Warning..... 107  
 Engine Oil Pressure..... 109  
 Gauges and Indicators..... 90  
 High-Beam On..... 110  
 Lane Keep Assist..... 105  
 Low Fuel Warning..... 109  
 Performance Shifting..... 104  
 Seat Belt Reminders..... 99  
 Security..... 109  
 Service Electric Parking Brake..... 103  
 Super Cruise..... 111  
 Tire Pressure..... 108  
 Traction Control System (TCS)/  
 Electronic Stability Control Light..... 106  
 Traction Off..... 106  
 Limited-Slip Differential..... 221  
 Lock  
 Steering Column..... 24  
 Locks  
 Automatic Door..... 16

Delayed Locking..... 16  
 Door..... 13  
 Lockout Protection..... 16  
 Power Door..... 16  
 Safety..... 17  
 Loss of Control..... 176  
 Lower Anchors and Tethers for Children  
 (LATCH System)..... 70  
 Low Fuel Warning Light..... 109  
 Low-Profile Tires..... 327  
 Lumbar Adjustment..... 38  
 Front Seats..... 38

**M**

Maintenance  
 Records..... 371  
 Maintenance Schedule..... 365  
 Recommended Fluids and Lubricants... 370  
 Malfunction Indicator Lamp..... 101  
 Manual  
 Mode..... 203  
 Transmission..... 204  
 Transmission Fluid..... 298  
 Maps..... 142  
 Massage  
 Seats..... 39  
 Matching  
 Active Rev..... 206

Media  
 Avoiding Untrusted Devices..... 141  
 Memory Seats..... 39  
 Messages  
 Engine Power..... 121  
 Vehicle..... 120  
 Vehicle Speed..... 121  
 Mirrors  
 Automatic Dimming..... 27  
 Automatic Dimming Rearview..... 28  
 Convex..... 25  
 Folding..... 26  
 Heated..... 27  
 Interior Rearview..... 28  
 Manual Rearview..... 28  
 Power..... 26  
 Rear Camera..... 28  
 Tilt in Reverse..... 27  
 Mode  
 Driver Control..... 211  
 Monitor System, Tire Pressure..... 333  
 Multi-band Antenna..... 140  
 Multi-Point Vehicle Inspection (MPVI)..... 368

**N**

Navigation  
 Connected Services..... 396  
 Destination..... 143

Symbols.....	143
Using the System.....	141
New Vehicle Break-In.....	191
Noise	
Reducing Tires.....	327

**O**

Odometer.....	94
Trip.....	94
Off-Road	
Recovery.....	176
Oil	
Engine.....	295
Engine Oil Life System.....	297
Engine Oil Pressure Gauge.....	96
Pressure Light.....	109
Older Children, Restraints.....	63
Online Account and Customer Support.....	381
OnStar.....	390
Additional Information.....	392
Overview.....	391
OnStar Emergency.....	392
OnStar Security.....	392
Outlets	
Power.....	88
Overheating, Engine.....	306
Overview.....	134
Instrument Panel.....	4

**P**

Park	
Assist.....	251, 253
Shifting Into.....	197
Shifting Out of.....	198
Parking.....	198
Brake and P (Park) Mechanism Check.....	313
Extended.....	198
Over Things That Burn.....	198
Parking Assist	
Automatic.....	255
Parking or Backing	
Assistance Systems.....	251
Passenger	
Airbag Status Indicator.....	100
Compartment Air Filter.....	171
Sensing System.....	58
Pedestrian Ahead Indicator.....	105
Perchlorate Materials Requirements, California.....	287
Performance	
Data Recorder (PDR).....	147
Driving.....	217
Shifting Light.....	104
Phone	
Apple CarPlay and Android Auto.....	158
Bluetooth.....	153, 154

Port	
USB.....	141
Positioning	
Vehicle.....	144
Power	
Door Locks.....	16
Mirrors.....	26
Outlets.....	88
Protection, Battery.....	132
Retained Accessory (RAP).....	197
Seat Adjustment.....	36
Windows.....	30
Pregnancy, Using Seat Belts.....	51
Privacy	
Vehicle Data Recording.....	388
Problems with Route Guidance.....	145
Program	
Courtesy Transportation.....	384
Prohibited Fuels.....	276
Proposition 65 Warning	
California.....	1
Publication Ordering Information.....	387

**R**

Radiator.....	302
Radio	
AM-FM Radio.....	138
Frequency Statement.....	387

Reception..... 140  
 Satellite..... 139  
 Reading Lamps..... 129  
 Rear  
     Camera Mirror..... 28  
     Seats..... 43  
 Rearview Mirrors..... 28  
     Automatic Dimming..... 28  
 Reclining Seatbacks..... 37  
 Recognition  
     Voice..... 145  
 Recommended  
     Fuel..... 275, 276  
 Recommended Fluids and Lubricants..... 370  
 Recorder  
     Surround Vision..... 273  
 Records  
     Maintenance..... 371  
 Recreational Vehicle Towing..... 354  
 Reimbursement Program, GM Mobility..... 382  
 Remote  
     Key..... 7  
     Key Operation..... 7  
     Start..... 12  
 Replacement Parts  
     Airbags..... 63  
 Replacing  
     Airbag System..... 63

LATCH System Parts After a Crash..... 76  
 Seat Belt System Parts after a Crash..... 52  
 Reporting Safety Defects  
     Canadian Government..... 388  
     General Motors..... 388  
     U.S. Government..... 388  
 Restraints  
     Where to Put..... 69  
 Retained Accessory Power (RAP)..... 197  
 Reverse Rim Wheels..... 340  
 Reverse Tilt Mirrors..... 27  
 Ride Control Systems  
     Enhanced Traction System (ETS)..... 221  
 Roads  
     Driving, Wet..... 184  
 Roadside Assistance Program..... 382  
 Roof  
     Sunroof..... 32  
 Rotation, Tires..... 337  
 Routing, Engine Drive Belt..... 378  
 Run-Flat Tires..... 326  
 Running the Vehicle While Parked..... 199

**S**

Safety  
     Locks..... 17  
 Safety Defects Reporting  
     Canadian Government..... 388

General Motors..... 388  
 U.S. Government..... 388  
 Safety System Check..... 52  
 Satellite Radio..... 139  
 Scheduling Appointments..... 384  
 Sealant Kit, Tire..... 344  
 Seat Belts..... 45  
     Buckle To Drive..... 46  
     Care..... 52  
     Extender..... 51  
     How to Wear Seat Belts Properly..... 46  
     Lap-Shoulder Belt..... 48  
     Reminders..... 99  
     Replacing after a Crash..... 52  
     Use During Pregnancy..... 51  
 Seats  
     Head Restraints..... 34  
     Heated and Ventilated, Front..... 42  
     Lumbar Adjustment, Front..... 38  
     Massage..... 39  
     Memory..... 39  
     Power Adjustment, Front..... 36  
     Rear..... 43  
     Reclining Seatbacks..... 37  
 Securing Child Restraints..... 76, 78  
 Security  
     Light..... 109  
     OnStar..... 392



Vehicle.....	22
Vehicle Alarm.....	22
Self-Sealing Tires.....	327
Service.....	171
Maintenance Records.....	371
Accessories and Modifications.....	287
Doing Your Own Work.....	287
Electric Parking Brake Light.....	103
Maintenance, General Information.....	364
Parts Identification.....	374
Scheduling Appointments.....	384
Services	
Special Application.....	369
Servicing the Airbag.....	61
Settings.....	159
Shifting	
Into Park.....	197
Out of Park.....	198
Signals, Turn and Lane-Change.....	128
Software Updates.....	138
Special Application Services.....	369
Specifications and Capacities.....	375
Speed	
Limiter.....	223
Limiter Indicator.....	95
Speedometer.....	94
Start	
Remote.....	12
Start Assist, Hill.....	209

Starting the Engine.....	193
Status	
Vehicle.....	115
Steering.....	175
Column Lock.....	24
Heated Wheel.....	85
Wheel Adjustment.....	85
Wheel Controls.....	135
Stop/Start System.....	195
Storage	
Center Console.....	82
Compartments.....	81
Cupholders.....	81
Glove Box.....	81
Umbrella.....	82
Storing the Tire Sealant and Compressor Kit.....	349
Struts	
Gas.....	314
Stuck Vehicle.....	187
Summer Tires.....	327
Sunroof.....	32
Sun Visors.....	32
Super Cruise.....	235
Light.....	111
Surround	
Vision System.....	252
Symbols.....	3
Navigation.....	143

System	
Airbag.....	53
Brake Pad Life.....	310
Engine Air Filter Life.....	299
Global Positioning.....	144
Infotainment.....	390

## T

Tachometer.....	94
Teen Driver.....	161
Text Telephone (TTY) Users.....	381
Theft-Deterrent Systems.....	24
Immobilizer.....	24
Thigh Support Adjustment.....	37
Time.....	88
Tires	325
All-Season.....	326
Buying New Tires.....	339
Designations.....	329
Different Size.....	340
If a Tire Goes Flat.....	343
Inspection.....	337
Low-Profile.....	327
Noise Reducing.....	327
Pressure.....	331, 332
Pressure Light.....	108
Pressure Monitor Operation.....	334
Pressure Monitor System.....	333
Rotation.....	337

Run-Flat..... 326  
 Sealant and Compressor Kit..... 344  
 Sealant and Compressor Kit, Storing.... 349  
 Self-Sealing..... 327  
 Sidewall Labeling..... 328  
 Terminology and Definitions..... 329  
 Traction Devices..... 343  
 Uniform Tire Quality Grading..... 341  
 Wheel Alignment and Tire Balance..... 342  
 Wheel Replacement..... 342  
 When It Is Time for New Tires..... 338  
 Winter..... 326  
 Top Tier Fuel..... 275  
 Towing  
   Driving Characteristics..... 279  
   Equipment..... 284  
   General Information..... 278  
   Recreational Vehicle..... 354  
   Trailer..... 282  
 Track Events and Competitive Driving..... 176  
 Traction  
   Control System (TCS)/Electronic  
   Stability Control Light..... 106  
   Control/Electronic Stability Control..... 210  
   Limited-Slip Differential..... 221  
   Off Light..... 106  
 Traction Devices,  
   Tires..... 343  
 Trademarks and License Agreements..... 164

Traffic  
   Sign Assistant..... 269  
 Trailer  
   Towing..... 282  
 Transmission  
   Automatic..... 200  
   Fluid, Automatic..... 298  
   Fluid, Manual..... 298  
   Manual..... 204  
   Temperature Gauge..... 98  
 Transportation Program, Courtesy..... 384  
 Transporting  
   a Disabled Vehicle..... 352  
 Trip Odometer..... 94  
 Trunk..... 17  
 TTY Users  
   Customer Assistance..... 381  
 Turn and Lane-Change Signals..... 128

**U**

Umbrella Storage..... 82  
 Uniform Tire Quality Grading..... 341  
 Universal Remote System..... 121  
   Operation..... 123  
   Programming..... 121  
 Updates  
   Software..... 138  
 USB Port..... 141

Using  
   Infotainment System..... 136  
   Navigation System..... 141

**V**

Vehicle  
   Ahead Indicator..... 105  
   Alarm System..... 22  
   Automatic Hold..... 209  
   Automatic Hold Light..... 104  
   Canadian Owners..... 2  
   Control..... 174  
   Data Recording and Privacy..... 388  
   Identification Number (VIN)..... 373  
   Load Limits..... 187  
   Messages..... 120  
   Positioning..... 144  
   Security..... 22  
   Speed Messages..... 121  
   Status..... 115  
   Symbols..... 3  
 Vehicle Care  
   Storing the Tire Sealant and  
   Compressor Kit..... 349  
   Tire Pressure..... 331  
 Vehicle Security  
   Steering Column Lock..... 24  
 Ventilation, Air..... 170

Visors.....	32
Voice Recognition.....	145

## W

Warning	
Brake System Light.....	103
Caution and Danger.....	2
Hazard Flashers.....	128
Lights, Gauges, and Indicators.....	90
Washer Fluid.....	307
Wheels	
Alignment and Tire Balance.....	342
Different Size.....	340
Replacement.....	342
Reverse Rim.....	340
When It Is Time for New Tires.....	338
Where to Put the Restraint.....	69
Windows.....	30
Power.....	30
Windshield	
Replacement.....	314
Wiper/Washer.....	86
Winter	
Driving.....	186
Tires.....	326
Wiper	
Blade Replacement.....	313
Wireless Charging.....	88

## Scan to Access

### United States



- Owner's Manuals
- Warranty Information
- Connected Services
- My Cadillac Rewards
- myCadillac Mobile App
- How-To Videos
- Vehicle Diagnostics
- Scheduled Maintenance
- Vehicle Features
- Many Additional Resources

### Canada



---

### United States

Customer Assistance  
1-800-333-4223

Roadside Assistance  
1-800-224-1400

### United States and Canada

Connected Services  
1-888-4-ONSTAR

### Canada

Customer Assistance  
1-888-446-2000

Roadside Assistance  
1-800-882-1112



25CT5\_ENUS\_17986895A\_2024APR15

