



2022

GX 460

OWNER'S MANUAL



WARNING: Operating, servicing and maintaining a passenger vehicle or off-highway motor vehicle can expose you to chemicals including engine exhaust, carbon monoxide, phthalates, and lead, which are known to the State of California to cause cancer and birth defects or other reproductive harm. To minimize exposure, avoid breathing exhaust, do not idle the engine except as necessary, service your vehicle in a well-ventilated area and wear gloves or wash your hands frequently when servicing your vehicle. For more information go to www.P65Warnings.ca.gov/passenger-vehicle.

Your Lexus dealer

Your Lexus dealer will provide quality maintenance and any other assistance you may require.

If there is not a Lexus dealer near you, please call the following number:

■ U.S. OWNERS

- In the U.S. mainland or Canada:
Lexus Roadside Assistance
1-800-25-LEXUS or **1-800-255-3987** (Toll-Free)
- In Hawaii:
Servco Automotive Roadside Assistance/Customer Services
1-800-25-LEXUS or **1-800-255-3987** (Toll-Free)

■ CANADIAN OWNERS

- In Canada or the U.S. mainland:
Lexus Roadside Assistance/Customer Service
1-800-26-LEXUS or **1-800-265-3987** (Toll-Free)

Please access our **websites** for further information.

- The U.S. mainland: www.lexus.com
- Hawaii: www.servcolexus.com
- Canada : www.lexus.ca

©2021 TOYOTA MOTOR CORPORATION

All rights reserved. This material may not be reproduced or copied, in whole or in part, without the written permission of Toyota Motor Corporation.

	Pictorial index	Search by illustration
1	For safety and security	Make sure to read through them
2	Instrument cluster	How to read the gauges and meters, the variety of warning lights and indicators, etc.
3	Operation of each component	Opening and closing the doors and windows, adjustment before driving, etc.
4	Driving	Operations and advice which are necessary for driving
5	Interior features	Usage of the interior features, etc.
6	Maintenance and care	Caring for your vehicle and maintenance procedures
7	When trouble arises	What to do in case of malfunction or emergency
8	Vehicle specifications	Vehicle specifications, customizable features, etc.
9	For owners	Reporting safety defects for U.S. owners, and seat belt, SRS airbag and headlight aim instructions for Canadian owners
	Index	Search by symptom
		Search alphabetically

For your information.....	8
Reading this manual.....	12
How to search.....	13
Pictorial index.....	14

1 For safety and security

1-1. For safe use	
Before driving	26
For safe driving.....	28
Seat belts.....	30
SRS airbags.....	36
Front passenger occupant classification system	47
Safety information for children	53
Child restraint systems.....	54
Installing child restraints.....	58
Exhaust gas precautions.....	70
1-2. LEXUS Enform	
LEXUS Enform Safety Connect.....	71
1-3. Theft deterrent system	
Engine immobilizer system.....	76
Alarm.....	77

2 Instrument cluster

2. Instrument cluster	
Warning and indicators lights	82
Gauges and meters.....	88
Multi-information display	91
Fuel consumption information	98

3 Operation of each component

3-1. Key information	
Keys.....	104
3-2. Opening, closing and locking the doors	
Side doors.....	108
Back door	116
Glass hatch	121
Smart access system with push-button start.....	126
3-3. Adjusting the seats	
Front seats	132
Rear seats	134
Driving position memory.....	145
Head restraints	150
3-4. Adjusting the steering wheel and mirrors	
Steering wheel.....	153
Inside rear view mirror	155
Outside rear view mirrors	157
3-5. Opening, closing the windows and moon roof	
Power windows	160
Moon roof.....	163

4 Driving

4-1. Before driving

Driving the vehicle	168
Cargo and luggage	176
Vehicle load limits	180
Trailer towing (with towing hitch).....	181
Dinghy towing.....	199

4-2. Driving procedures

Engine (ignition) switch.....	200
Automatic transmission	206
Turn signal lever	211
Parking brake.....	212

4-3. Operating the lights and wipers

Headlight switch	213
Automatic High Beam.....	216
Fog light switch.....	220
Windshield wipers and washer	221
Rear window wiper and washer	225
Headlight cleaner switch.....	227

4-4. Refueling

Opening the fuel tank cap	228
---------------------------------	-----

4-5. Using the driving support systems

Lexus Safety System +	232
PCS (Pre-Collision System)	237
LDA (Lane Departure Alert).....	247
Dynamic radar cruise control	255
Intuitive parking assist.....	267
Lexus parking assist monitor.....	277
Multi-terrain Select.....	292
Multi-terrain Monitor.....	296
Rear height control air suspension	352
AVS (Adaptive Variable Suspension System)	356
Four-wheel drive system	357
Crawl Control.....	361
Downhill assist control system.....	365
Driving assist systems	368
BSM (Blind Spot Monitor).....	374
• The Blind Spot Monitor function	377
• The Rear Cross Traffic Alert function.....	380

4-6. Driving tips

Winter driving tips.....	387
Off-road precautions.....	390

5 Interior features

5-1. Remote Touch/Display

Remote Touch	396
Center display	399

5-2. Using the air conditioning system and defogger

Front automatic air conditioning system	402
Rear air conditioning system	414
Heated steering wheel/seat heaters/seat ventilators	417

5-3. Using the interior lights

Interior lights list	420
• Personal/interior lights main switch	421
• Personal/interior lights	421

5-4. Using the storage features

List of storage features	423
• Glove box	424
• Console box	424
• Coin holder	425
• Cup holders/bottle holders/door pockets	426
• Auxiliary boxes	429
Luggage compartment features	431

5-5. Using the other interior features

Other interior features	438
• Cool box	438
• Sun visors	440
• Vanity mirror	440
• Conversation mirror	441
• Clock	441
• Power outlets	442
• USB charging ports	446
• Armrest	448
• Coat hooks	449
• Assist grips	449
Garage door opener	450

6 Maintenance and care

6-1. Maintenance and care

- Cleaning and protecting the vehicle exterior458
- Cleaning and protecting the vehicle interior.....461

6-2. Maintenance

- Maintenance requirements 464
- General maintenance..... 467
- Emission inspection and maintenance (I/M) programs..... 470

6-3. Do-it-yourself maintenance

- Do-it-yourself service precautions.....471
- Hood..... 474
- Engine compartment 475
- Tires.....488
- Tire inflation pressure 499
- Wheels.....503
- Air conditioning filter505
- Electronic key battery..... 507
- Checking and replacing fuses.....509
- Headlight aim.....512
- Light bulbs514

7 When trouble arises

7-1. Essential information

- Emergency flashers524
- If your vehicle has to be stopped in an emergency525
- If the vehicle is submerged or water on the road is rising..... 526

7-2. Steps to take in an emergency

- If your vehicle needs to be towed528
- If you think something is wrong.....533
- Fuel pump shut off system..... 534
- If a warning light turns on or a warning buzzer sounds535
- If a warning message is displayed544
- If you have a flat tire548
- If the engine will not start.....562
- If the electronic key does not operate properly564
- If the vehicle battery is discharged..... 567
- If your vehicle overheats.....570
- If the vehicle becomes stuck573

1

2

3

4

5

6

7

8

9

8 Vehicle specifications

8-1. Specifications

Maintenance data (fuel, oil level, etc.)	576
Fuel information	586
Tire information	589

8-2. Customization

Customizable features	600
-----------------------------	-----

8-3. Items to initialize

Items to initialize	609
---------------------------	-----

9 For owners

Reporting safety defects for U.S. owners	612
Reporting safety defects for Canadian owners	613
Seat belt instructions for Canadian owners (in French).....	614
SRS airbag instructions for Canadian owners (in French).....	616
Headlight aim instructions for Canadian owners (in French).....	624

Index

What to do if... (Troubleshooting).....	628
Alphabetical index	632

For vehicles with navigation system, refer to the "NAVIGATION SYSTEM OWNER'S MANUAL" for information regarding the equipment listed below.

- Navigation system
- Audio/video system
- Hands-free system (for cellular phone)
- Lexus Enform



For your information

Main Owner's Manual

Please note that this manual applies to all models and explains all equipment, including options. Therefore, you may find explanations for equipment not installed on your vehicle and the illustrations used may differ from your vehicle.

All specifications provided in this manual are current at the time of printing.

Over time, your vehicle may receive updates that modify the vehicle and make material in this manual incomplete and/or inaccurate. Because of Lexus' interest in continual product improvement, Lexus reserves the right to make changes to this manual at any time without notice.

If Lexus chooses to update the manual, updated versions can be viewed by selecting your vehicle by model and year at the following URL or on your mobile device if you have access to the Lexus app.

<https://drivers.lexus.com>

Noise from under vehicle after turning off the engine

Approximately five hours after the engine is turned off, you may hear sound coming from under the vehicle for several minutes. This is the sound of a fuel evaporation leakage check and, it does not indicate a malfunction.

Accessories, spare parts and modification of your Lexus

A wide variety of non-genuine spare parts and accessories for Lexus vehicles are currently available in the market. You should know that Toyota does not warrant these products and is not responsible for their performance, repair, or replacement, or for any damage they may cause to, or adverse effect they may have on, your Lexus vehicle.

This vehicle should not be modified with non-genuine Lexus products. Modification with non-genuine Lexus products could affect its performance, safety or durability, and may even violate governmental regulations. In addition, damage or performance problems resulting from the modification may not be covered under warranty.

Also, remodeling like this will have an effect on advanced safety equipment such as Lexus Safety System + and there is a danger that it will not work properly or the danger that it may work in situations where it should not be working.

Installation of a mobile two-way radio system

The installation of a mobile two-way radio system in your vehicle could affect electronic systems such as:

- Multiport fuel injection system/sequential multiport fuel injection system
- Lexus Safety System +
- Anti-lock brake system
- SRS airbag system
- Seat belt pretensioner system

Be sure to check with your Lexus dealer for precautionary measures or special instructions regarding installation of a mobile two-way radio system.

Vehicle data recording

The vehicle is equipped with sophisticated computers that will record certain data, such as:

- Engine speed/Electric motor speed (traction motor speed)
- Accelerator status
- Brake status
- Vehicle speed
- Operation status of the driving assist systems
- Images from the cameras

Your vehicle is equipped with cameras. Contact your Lexus dealer for the location of recording cameras.

The recorded data varies according to the vehicle grade level and options with which it is equipped.

These computers do not record conversations or sounds, and only record images outside of the vehicle in certain situations.

● Data Transmission

Your vehicle may transmit the data recorded in these computers to Lexus without notification to you.

● Data usage

Lexus may use the data recorded in this computer to diagnose malfunctions, conduct research and development, and improve quality.

Lexus will not disclose the recorded data to a third party except:

- With the consent of the vehicle owner or with the consent of the lessee if the vehicle is leased
- In response to an official request by the police, a court of law or a government agency
- For use by Lexus in a lawsuit
- For research purposes where the data is not tied to a specific vehicle or vehicle owner

● Recorded image information can be erased by your Lexus dealer.

The image recording function can be disabled. However, if the function is disabled, data from when the system operates will not be available.

● To learn more about the vehicle data collected, used and shared by Lexus, please visit www.lexus.com/privacyvts/.

Usage of data collected through Lexus Enform (U.S. mainland only)

If your Lexus has Lexus Enform and if you have subscribed to those services, please refer to the Lexus Enform Telematics Subscription Service Agreement for information on data collected and its usage.

● To learn more about the vehicle data collected, used and shared by Lexus, please visit www.lexus.com/privacyvts/.

Event data recorder

This vehicle is equipped with an event data recorder (EDR). The main purpose of an EDR is to record, in certain crash or near crash-like situations, such as an air bag deployment or hitting a road obstacle, data that will assist in understanding how a vehicle's systems performed. The EDR is designed to record data related to vehicle dynamics and safety systems for a short period of time, typically 30 seconds or less.

The EDR in this vehicle is designed to record such data as:

- How various systems in your vehicle were operating;
- Whether or not the driver and passenger safety belts were buckled/fastened;
- How far (if at all) the driver was depressing the accelerator and/or brake pedal; and,
- How fast the vehicle was traveling.

These data can help provide a better understanding of the circumstances in which crashes and injuries occur.

NOTE: EDR data are recorded by your vehicle only if a non-trivial crash situation occurs; no data are recorded by the EDR under normal driving conditions and no personal data (e.g., name, gender, age, and crash location) are recorded. However, other parties, such as law enforcement, could combine the EDR data with the type of personally identifying data routinely acquired during a crash investigation.

To read data recorded by an EDR, special equipment is required, and access to the vehicle or the EDR is needed. In addition to the vehicle manufacturer, other parties, such as law enforcement, that have the special equipment, can read the information if they have access to the vehicle or the EDR.

● Disclosure of the EDR data

Lexus will not disclose the data recorded in an EDR to a third party except when:

- An agreement from the vehicle's owner (or the lessee for a leased vehicle) is obtained
- In response to an official request by the police, a court of law or a government agency
- For use by Lexus in a lawsuit

However, if necessary, Lexus may:

- Use the data for research on vehicle safety performance
- Disclose the data to a third party for research purposes without disclosing information about the specific vehicle or vehicle owner

Scrapping of your Lexus

The SRS airbag and seat belt pretensioner devices in your Lexus contain explosive chemicals. If the vehicle is scrapped with the airbags and seat belt pretensioners left as they are, this may cause an accident such as fire. Be sure to have the systems of the SRS airbag and seat belt pretensioner removed and disposed of by a qualified service shop or by your Lexus dealer before you scrap your vehicle.

Perchlorate Material

Special handling may apply,
See www.dtsc.ca.gov/hazardouswaste/perchlorate.

Your vehicle has components that may contain perchlorate. These components may include the airbag, seat belt pretensioners, wireless remote control batteries, and the batteries in the tire pressure warning valve and transmitters.

WARNING

■ General precautions while driving

Driving under the influence: Never drive your vehicle when under the influence of alcohol or drugs that have impaired your ability to operate your vehicle. Alcohol and certain drugs delay reaction time, impair judgment and reduce coordination, which could lead to an accident that could result in death or serious injury.

Defensive driving: Always drive defensively. Anticipate mistakes that other drivers or pedestrians might make and be ready to avoid accidents.

Driver distraction: Always give your full attention to driving. Anything that distracts the driver, such as adjusting controls, talking on a cellular phone or reading can result in a collision with resulting death or serious injury to you, your occupants or others.

■ General precaution regarding children's safety

Never leave children unattended in the vehicle, and never allow children to have or use the key.

Children may be able to start the vehicle or shift the vehicle into neutral. There is also a danger that children may injure themselves by playing with the windows, the moon roof, or other features of the vehicle. In addition, heat build-up or extremely cold temperatures inside the vehicle can be fatal to children.

Reading this manual



WARNING:

Explains something that, if not obeyed, could cause death or serious injury to people.



NOTICE:

Explains something that, if not obeyed, could cause damage to or a malfunction in the vehicle or its equipment.



... Indicates operating or working procedures. Follow the steps in numerical order.



Indicates the action (pushing, turning, etc.) used to operate switches and other devices.



Indicates the outcome of an operation (e.g. a lid opens).

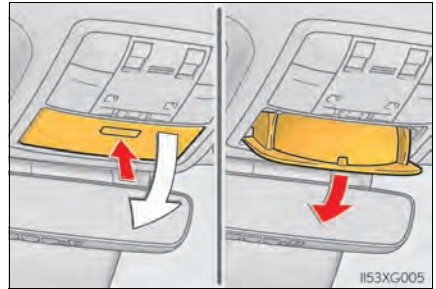

Indicates the component or position being explained.



Means "Do not", "Do not do this", or "Do not let this happen".

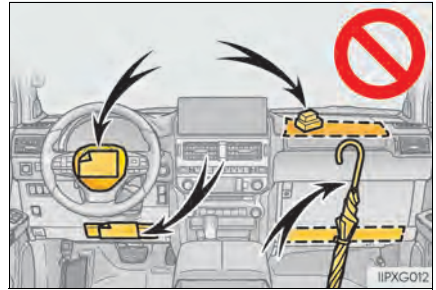

How to search

■ Searching by name

- Alphabetical index.....P. 632

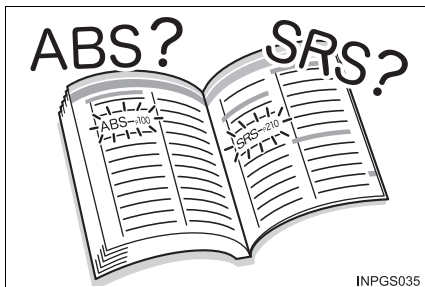

■ Searching by installation position

- Pictorial index..... P. 14



■ Searching by symptom or sound

- What to do if...
(Troubleshooting)..... P. 628



■ Searching by title

- Table of contents.....P. 2

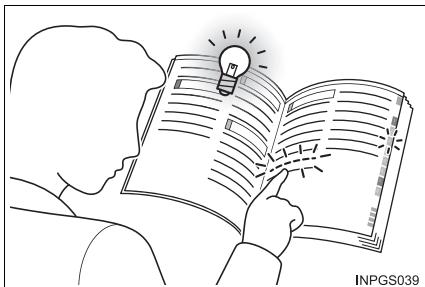

Pictorial index

Exterior

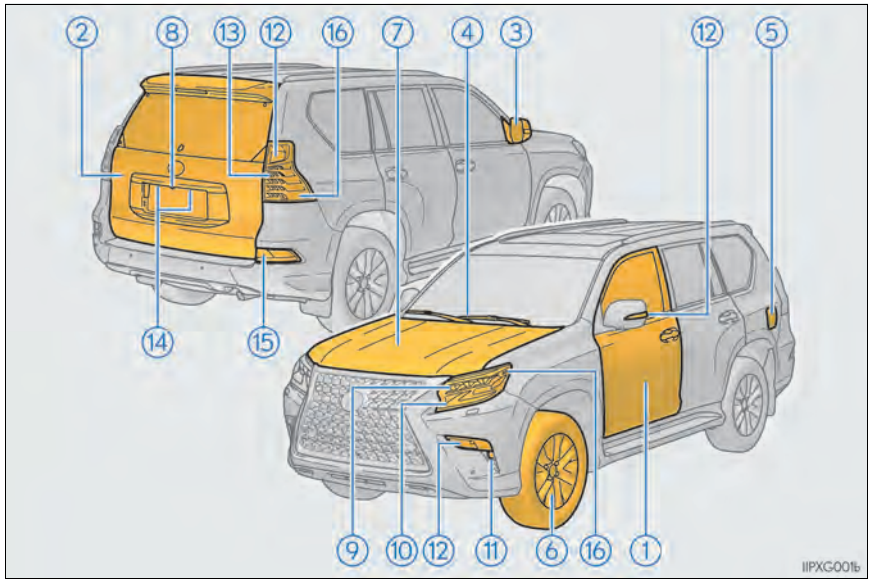

IIPXG001b

- ① **Side doors** P. 108
 - Locking/unlocking P. 108
 - Opening/closing the door glasses P. 160
 - Locking/unlocking by using the mechanical key P. 564
 - Warning lights/warning messages P. 114, 537
- ② **Back door** P. 116
 - Opening from outside P. 117
 - Opening/closing the glass hatch P. 121
 - Warning lights/warning messages P. 114, 537
- ③ **Outside rear view mirrors** P. 157
 - Adjusting the mirror angle P. 157
 - Folding the mirrors P. 157
 - Driving position memory P. 145
 - Defogging the mirrors P. 409

- ④ **Windshield wipers** P. 221
 - Precautions against winter season P. 387
 - To prevent freezing (windshield wiper de-icer^{*}) P. 409
 - Precautions against car wash P. 459
- ⑤ **Fuel filler door** P. 228
 - Refueling method P. 228
 - Fuel type/fuel tank capacity P. 578
- ⑥ **Tires** P. 488
 - Tire size/inflation pressure P. 584
 - Winter tires/tire chain P. 387
 - Checking/rotation/tire pressure warning system P. 488
 - Coping with flat tires P. 548
- ⑦ **Hood** P. 474
 - Opening P. 474
 - Engine oil P. 578
 - Coping with overheat P. 570
 - Warning lights/warning messages P. 114, 537
- ⑧ **Camera^{*}** P. 277, 296

Light bulbs of the exterior lights for driving

(Replacing method: P. 514, Watts: P. 585)

- ⑨ **Headlights** P. 213
- ⑩ **Parking lights/daytime running lights** P. 213
- ⑪ **Fog lights^{*}** P. 220
- ⑫ **Turn signal lights** P. 211
- ⑬ **Stop/tail lights**
 - Hill-start assist control P. 369
 - Downhill assist control system^{*} P. 365
- ⑭ **License plate lights** P. 213
- ⑮ **Back-up lights**
 - Shifting the shift lever to R P. 206
- ⑯ **Side marker lights** P. 213

*: If equipped

Instrument panel

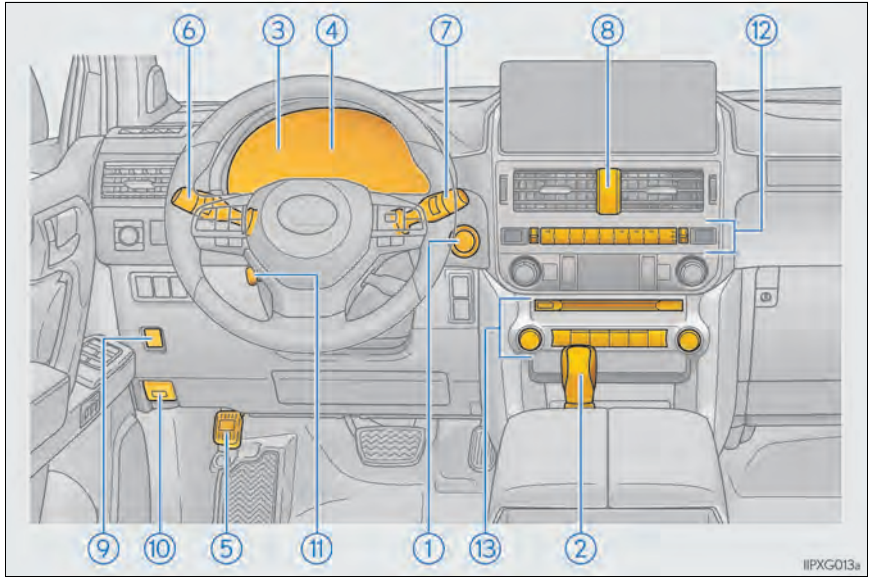

- | | | |
|---|---|---------------|
| ① | Engine switch | P. 200 |
| | Starting the engine/changing the modes | P. 200 |
| | Emergency stop of the engine | P. 525 |
| | When the engine will not start | P. 562 |
| | Warning messages | P. 544 |
| ② | Shift lever | P. 206 |
| | Changing the shift position | P. 206 |
| | Precautions against towing | P. 528 |
| | When the shift lever does not move | P. 209 |
| ③ | Meters | P. 88 |
| | Reading the meters/adjusting the instrument panel light | P. 88 |
| | Warning lights/indicators | P. 82 |
| | When the warning lights come on | P. 535 |

- ④ **Multi-information display** P. 91
 - Display P. 91
 - When the warning messages are displayed P. 544
- ⑤ **Parking brake** P. 212
 - Applying/releasing P. 212
 - Precautions against winter season P. 388
 - Warning buzzer/message P. 212, 536
- ⑥ **Turn signal lever** P. 211
 - Headlight switch** P. 213
 - Headlights/parking lights/tail lights/daytime running lights P. 213
 - Fog lights^{*1} P. 220
- ⑦ **Windshield wiper and washer switch** P. 221
 - Rear window wiper and washer switch** P. 225
 - Usage P. 221, 225
 - Adding washer fluid P. 487
 - Warning messages P. 487
- ⑧ **Emergency flasher switch** P. 524
- ⑨ **Fuel filler door opener** P. 230
- ⑩ **Hood lock release lever** P. 474
- ⑪ **Tilt and telescopic steering control switch** P. 153
 - Adjustment P. 153
 - Driving position memory P. 145
- ⑫ **Air conditioning system** P. 402
 - Usage P. 402
 - Rear window defogger P. 409
- ⑬ **Audio system**^{*2}
 - Hands-free system**^{*2}

^{*1}: If equipped

^{*2}: Refer to "NAVIGATION SYSTEM OWNER'S MANUAL".

Switches

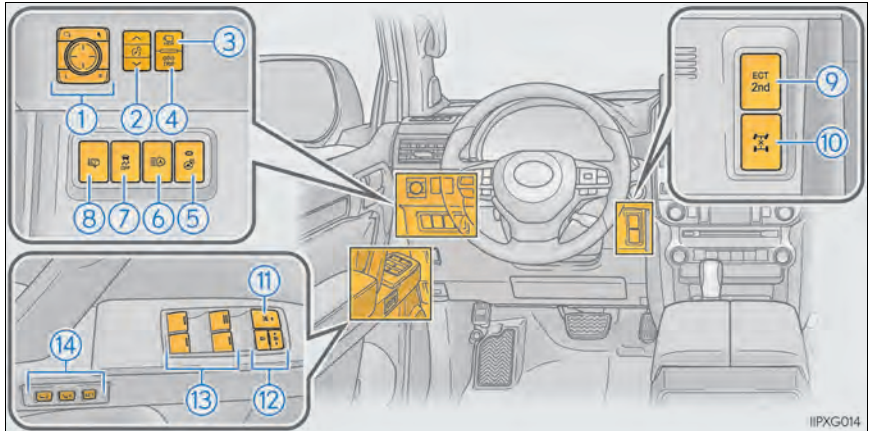

IIPXG014

- ① Outside rear view mirror switches P. 157
- ② Instrument cluster light control switch P. 89
- ③ VIEW switch* P. 301
- ④ Odometer/trip meter and trip meter reset button P. 89
- ⑤ Heated steering wheel switch* P. 417
- ⑥ Automatic High Beam switch P. 216
- ⑦ VSC OFF switch P. 370
- ⑧ Headlight cleaner switch* P. 227
- ⑨ Second start mode switch P. 207
- ⑩ Center differential lock/unlock switch P. 358
- ⑪ Window lock switch P. 160
- ⑫ Door lock switches P. 110
- ⑬ Power window switches P. 160
- ⑭ Driving position memory buttons P. 145

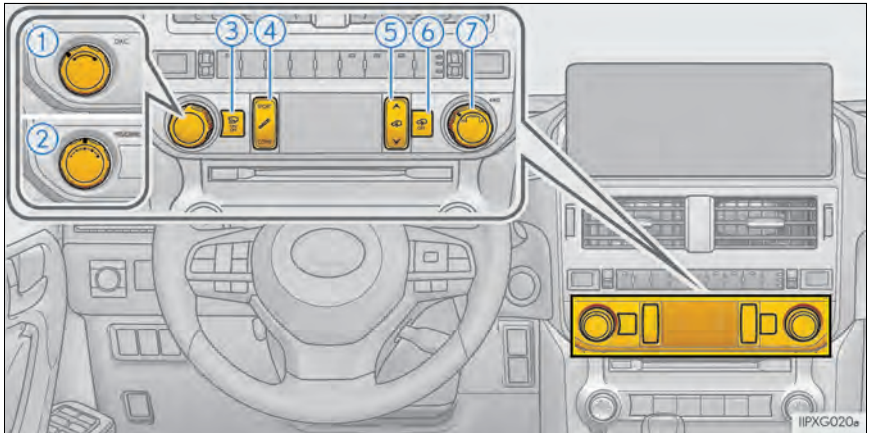

- ① “DAC” switch*P. 365
- ② Multi-terrain Select mode selector dial* P. 292
Crawl Control speed selector dial* P. 361
- ③ Crawl Control ON/OFF switch* P. 361
- ④ AVS switch*P. 356
- ⑤ Height control switch* P. 352
- ⑥ Height control OFF switch* P. 352
- ⑦ Four-wheel drive control switchP. 357

*: If equipped

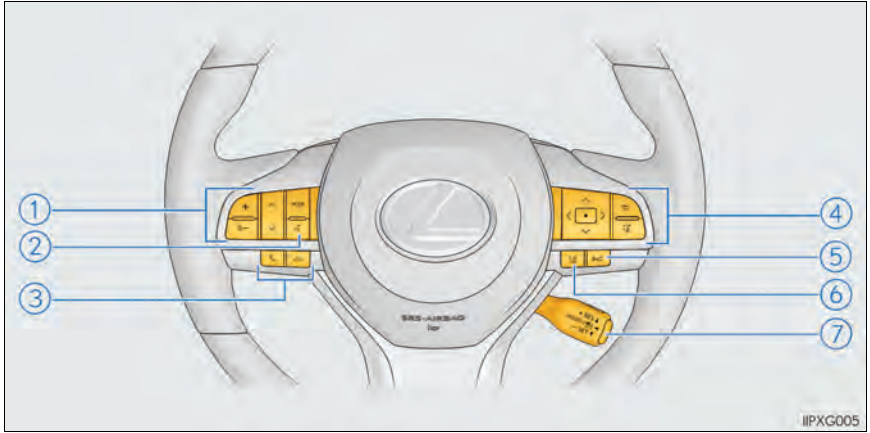

IIPXG005

- ① Audio remote control switches*¹
- ② Talk switch*¹
- ③ Telephone switches*¹
- ④ Meter control switches..... P. 92
- ⑤ Vehicle-to-vehicle distance switch P. 261
- ⑥ LDA (Lane Departure Alert) switchP. 249
- ⑦ Cruise control switch
 Dynamic radar cruise control..... P. 255

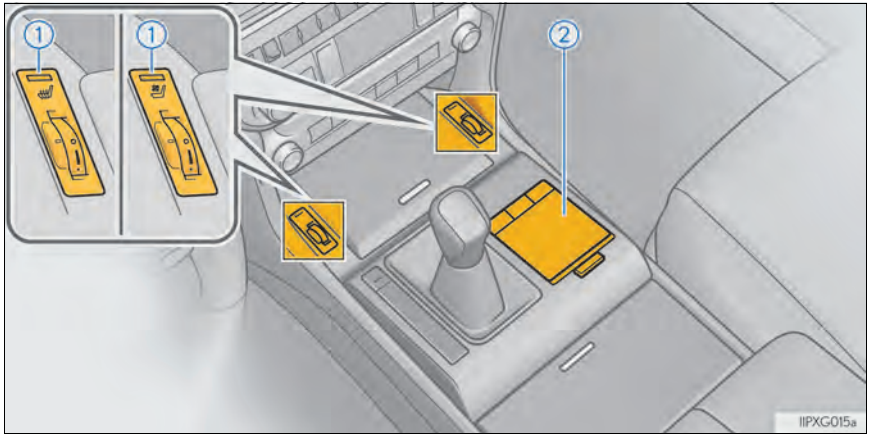

- ① Front seat heater/ventilator switches*2 P. 417
- ② Remote Touch P. 396

*1: Refer to "NAVIGATION SYSTEM OWNER'S MANUAL".

*2: If equipped

Interior

► 7-passenger models

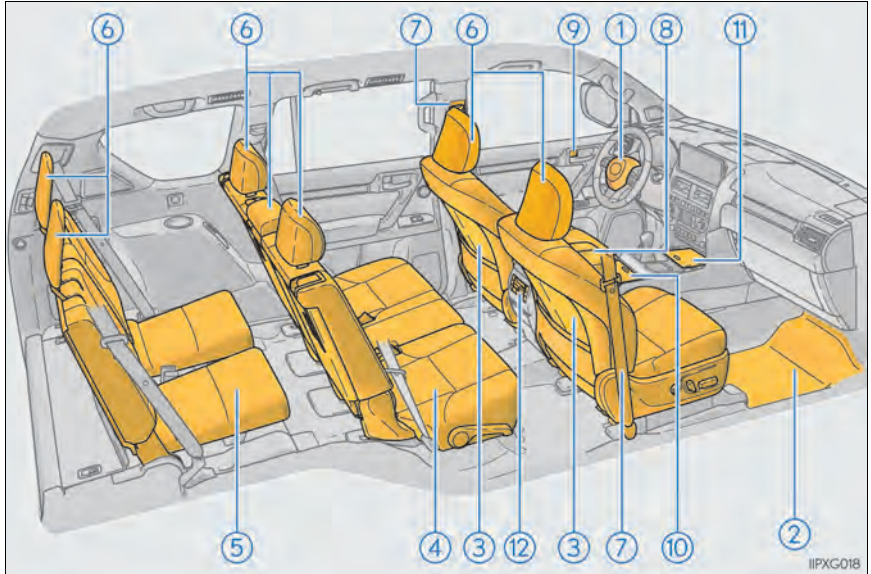

- | | |
|--|--------|
| ① SRS airbags | P. 36 |
| ② Floor mats | P. 26 |
| ③ Front seats | P. 132 |
| ④ Second seats | P. 134 |
| ⑤ Third seats | P. 134 |
| ⑥ Head restraints | P. 150 |
| ⑦ Seat belts | P. 30 |
| ⑧ Console box * | P. 424 |
| Cool box * | P. 438 |
| ⑨ Inside lock buttons | P. 110 |
| ⑩ Cup holders | P. 426 |
| ⑪ Auxiliary boxes | P. 429 |
| ⑫ Rear air conditioning system * | P. 414 |

► 6-passenger models

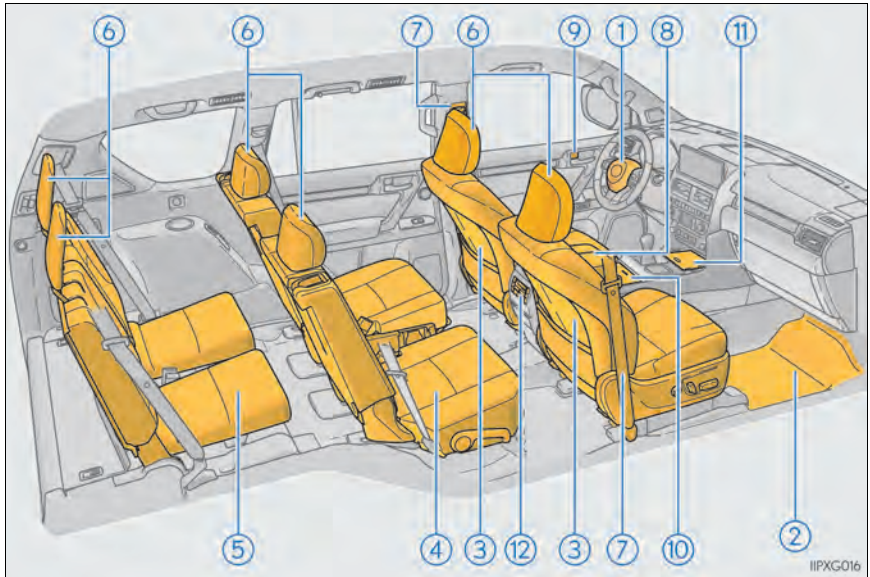

① SRS airbags.....	P. 36
② Floor mats.....	P. 26
③ Front seats.....	P. 132
④ Second seats.....	P. 134
⑤ Third seats.....	P. 134
⑥ Head restraints.....	P. 150
⑦ Seat belts.....	P. 30
⑧ Console box*.....	P. 424
Cool box*.....	P. 438
⑨ Inside lock buttons.....	P. 110
⑩ Cup holders.....	P. 426
⑪ Auxiliary boxes.....	P. 429
⑫ Rear air conditioning system*.....	P. 414

*: If equipped

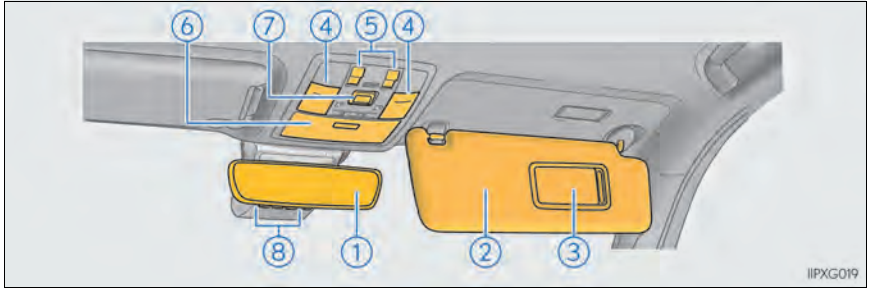

- ① Inside rear view mirror P. 155
- ② Sun visors P. 440
- ③ Vanity mirrors P. 440
- ④ Personal/interior lights ^{*1} P. 421
- ⑤ Moon roof switches P. 163
- ⑥ Conversation mirror P. 441
Auxiliary boxes P. 429
- ⑦ "SOS" button ^{*2} P. 71
- ⑧ Garage door opener buttons P. 450

^{*1}: The illustration shows the front, but they are also equipped in the rear.

^{*2}: If equipped

1-1. For safe use	
Before driving.....	26
For safe driving	28
Seat belts	30
SRS airbags.....	36
Front passenger occupant classification system.....	47
Safety information for children	53
Child restraint systems	54
Installing child restraints.....	58
Exhaust gas precautions.....	70
1-2. LEXUS Enform	
LEXUS Enform Safety Connect.....	71
1-3. Theft deterrent system	
Engine immobilizer system.....	76
Alarm	77

Before driving

Floor mat

Use only floor mats designed specifically for vehicles of the same model and model year as your vehicle. Fix them securely in place onto the carpet.

- 1 Insert the retaining hooks (clips) into the floor mat eyelets.

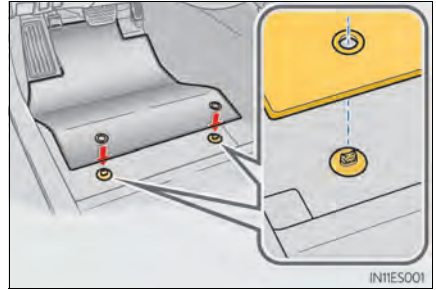

- 2 Turn the upper knob of each retaining hook (clip) to secure the floor mats in place.

*: Always align the \triangle marks.

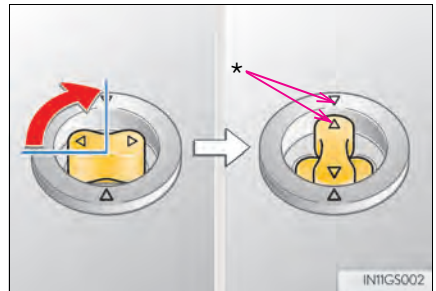

The shape of the retaining hooks (clips) may differ from that shown in the illustration.

⚠ WARNING

Observe the following precautions.

Failure to do so may cause the driver's floor mat to slip, possibly interfering with the pedals while driving. An unexpectedly high speed may result or it may become difficult to stop the vehicle. This could lead to an accident, resulting in death or serious injury.

■ When installing the driver's floor mat

- Do not use floor mats designed for other models or different model year vehicles, even if they are Lexus Genuine floor mats.
- Only use floor mats designed for the driver's seat.
- Always install the floor mat securely using the retaining hooks (clips) provided.
- Do not use two or more floor mats on top of each other.
- Do not place the floor mat bottom-side up or upside-down.

■ Before driving

- Check that the floor mat is securely fixed in the correct place with all the provided retaining hooks (clips). Be especially careful to perform this check after cleaning the floor.
- With the engine stopped and the shift lever in P, fully depress each pedal to the floor to make sure it does not interfere with the floor mat.

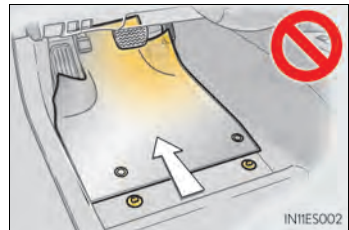

For safe driving

For safe driving, adjust the seat and mirror to an appropriate position before driving.

Correct driving posture

- ① Adjust the angle of the seatback so that you are sitting straight up and so that you do not have to lean forward to steer. (→P. 132)
- ② Adjust the seat so that you can depress the pedals fully and so that your arms bend slightly at the elbow when gripping the steering wheel. (→P. 132)
- ③ Lock the head restraint in place with the center of the head restraint closest to the top of your ears. (→P. 150)
- ④ Wear the seat belt correctly. (→P. 30)

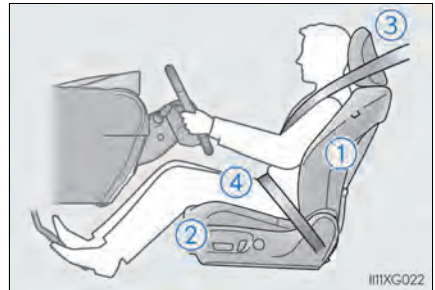

Correct use of the seat belts

Make sure that all occupants are wearing their seat belts before driving the vehicle. (→P. 30)

Use a child restraint system appropriate for the child until the child becomes large enough to properly wear the vehicle's seat belt. (→P. 54)

Adjusting the mirrors

Make sure that you can see backward clearly by adjusting the inside and outside rear view mirrors properly. (→P. 155, 157)

WARNING

Observe the following precautions.

Failure to do so may result in death or serious injury.

- Do not adjust the position of the driver's seat while driving.
Doing so could cause the driver to lose control of the vehicle.
- Do not place a cushion between the driver or passenger and the seatback.
A cushion may prevent correct posture from being achieved, and reduce the effectiveness of the seat belt and head restraint.
- Do not place anything under the front seats.
Objects placed under the front seats may become jammed in the seat tracks and stop the seat from locking in place. This may lead to an accident and the adjustment mechanism may also be damaged.
- Always observe the legal speed limit when driving on public roads.
- When driving over long distances, take regular breaks before you start to feel tired.
Also, if you feel tired or sleepy while driving, do not force yourself to continue driving and take a break immediately.

Seat belts

Make sure that all occupants are wearing their seat belts before driving the vehicle.

Correct use of the seat belts

- Extend the shoulder belt so that it comes fully over the shoulder, but does not come into contact with the neck or slide off the shoulder.
- Position the lap belt as low as possible over the hips.
- Adjust the position of the seatback. Sit up straight and well back in the seat.
- Do not twist the seat belt.

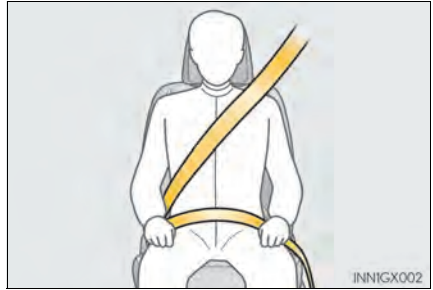

Fastening and releasing the seat belt

- ① To fasten the seat belt, push the plate into the buckle until a click sound is heard.
- ② To release the seat belt, press the release button.

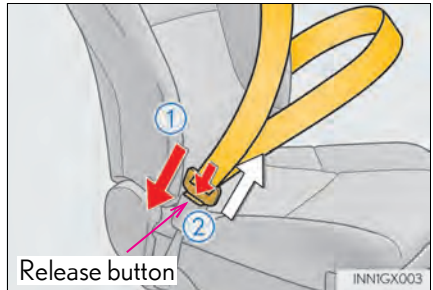

Adjusting the seat belt shoulder anchor height (front and outer second seats for 7-passenger models, front and second seats for 6-passenger models)

- ① Push the seat belt shoulder anchor down while pressing the release button.
 - ② Push the seat belt shoulder anchor up.
- Move the height adjuster up and down as needed until you hear a click.

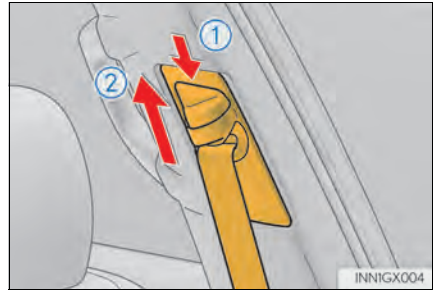

Seat belt pretensioners (front and outer second seats for 7-passenger models, front and second seats for 6-passenger models)

The pretensioners help the seat belts to quickly restrain the occupants by retracting the seat belts when the vehicle is subjected to certain types of severe frontal or side collision or a vehicle rollover.

The pretensioners do not activate in the event of a minor frontal impact, a minor side impact or a rear impact.

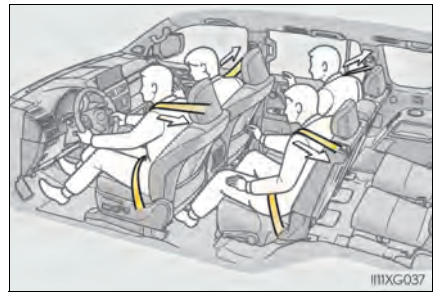

■ Emergency locking retractor (ELR)

The retractor will lock the belt during a sudden stop or on impact. It may also lock if you lean forward too quickly. A slow, easy motion will allow the belt to extend so that you can move around fully.

■ Automatic locking retractor (ALR)

When a passenger's shoulder belt is completely extended and then retracted even slightly, the belt is locked in that position and cannot be extended. This feature is used to hold the child restraint system (CRS) firmly. To free the belt again, fully retract the belt and then pull the belt out once more. (→P. 58)

■ Child seat belt usage

The seat belts of your vehicle were principally designed for persons of adult size.

- Use a child restraint system appropriate for the child, until the child becomes large enough to properly wear the vehicle's seat belt. (→P. 54)
- When the child becomes large enough to properly wear the vehicle's seat belt, follow the instructions on P. 30 regarding seat belt usage.

■ Replacing the belt after the pretensioner has been activated

If the vehicle is involved in multiple collisions, the pretensioner will activate for the first collision, but will not activate for the second or subsequent collisions.

■ Seat belt extender

If your seat belts cannot be fastened securely because they are not long enough, a personalized seat belt extender is available from your Lexus dealer free of charge.

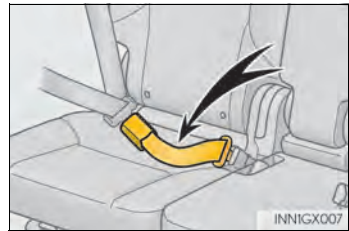

WARNING

Observe the following precautions to reduce the risk of injury in the event of sudden braking, sudden swerving or an accident. Failure to do so may cause death or serious injury.

■ Wearing a seat belt

- Ensure that all passengers wear a seat belt.
- Always wear a seat belt properly.
- Each seat belt should be used by one person only. Do not use a seat belt for more than one person at once, including children.
- Lexus recommends that children be seated in the rear seat and always use a seat belt and/or an appropriate child restraint system.
- To achieve a proper seating position, do not recline the seat more than necessary. The seat belt is most effective when the occupants are sitting up straight and well back in the seats.
- Do not wear the shoulder belt under your arm.
- Always wear your seat belt low and snug across your hips.

■ Pregnant women

Obtain medical advice and wear the seat belt in the proper way. (→P. 30)

Women who are pregnant should position the lap belt as low as possible over the hips in the same manner as other occupants, extending the shoulder belt completely over the shoulder and avoiding belt contact with the rounding of the abdominal area.

If the seat belt is not worn properly, not only the pregnant woman, but also the fetus could suffer death or serious injury as a result of sudden braking, sudden swerving or a collision.

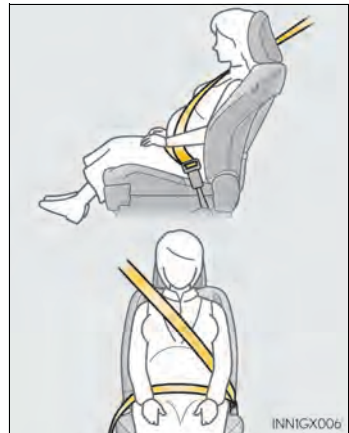

■ People suffering illness

Obtain medical advice and wear the seat belt in the proper way. (→P. 30)

 **WARNING****■ When the children are in the vehicle**

Do not allow children to play with the seat belt. If the seat belt becomes twisted around a child's neck, it may lead to choking or other serious injuries that could result in death. If this occurs and the buckle cannot be unfastened, scissors should be used to cut the belt.

■ Seat belt pretensioners

- Do not place anything, such as a cushion, on the front passenger's seat. Doing so will disperse the passenger's weight, which prevents the sensor from detecting the passenger's weight properly. As a result, the seat belt pretensioner for the front passenger's seat may not activate in the event of a collision.
- If the pretensioner has activated, the SRS warning light will come on. In that case, the seat belt cannot be used again and must be replaced at your Lexus dealer.

■ Adjustable shoulder anchor

Always make sure the shoulder belt is positioned across the center of your shoulder. The belt should be kept away from your neck, but not falling off your shoulder. Failure to do so could reduce the amount of protection in an accident and cause death or serious injuries in the event of a sudden stop, sudden swerve or accident. (→P. 31)

■ Seat belt damage and wear

- Do not damage the seat belts by allowing the belt, plate, or buckle to be jammed in the door.
- Inspect the seat belt system periodically. Check for cuts, fraying, and loose parts. Do not use a damaged seat belt until it is replaced. Damaged seat belt cannot protect an occupant from death or serious injury.
- Ensure that the belt and plate are locked and the belt is not twisted. If the seat belt does not function correctly, immediately contact your Lexus dealer.
- Replace the seat assembly, including the belts, if your vehicle has been involved in a serious accident, even if there is no obvious damage.
- Do not attempt to install, remove, modify, disassemble or dispose of the seat belts. Have any necessary repairs carried out by your Lexus dealer. Inappropriate handling may lead to incorrect operation.

**WARNING****■ Using a seat belt extender**

- Do not wear the seat belt extender if you can fasten the seat belt without the extender.
- Do not use the seat belt extender when installing a child restraint system because the belt will not securely hold the child restraint system, increasing the risk of death or serious injury in the event of an accident.
- The personalized extender may not be safe on another vehicle, when used by another person, or at a different seating position other than the one originally intended.

**NOTICE****■ Using a seat belt extender**

When releasing the seat belt, press on the buckle release button on the extender, not on the seat belt.
This helps prevent damage to the vehicle interior and the extender itself.

SRS airbags

The SRS airbags inflate when the vehicle is subjected to certain types of severe impacts that may cause significant injury to the occupants. They work together with the seat belts to help reduce the risk of death or serious injury.

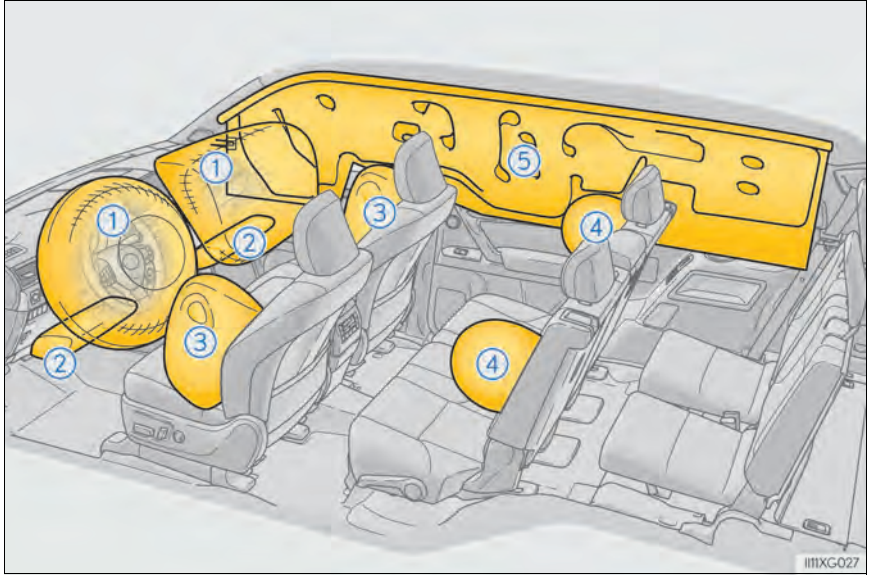

◆ SRS front airbags

- ① SRS driver airbag/front passenger airbag
Can help protect the head and chest of the driver and front passenger from impact with interior components
- ② SRS knee airbags
Can help provide driver and front passenger protection

◆ SRS side and curtain shield airbags

- ③ SRS front side airbags
 - Can help protect the torso of the front seat occupants
- ④ SRS rear side airbags
 - Can help protect the torso of occupants in the outer second seats (7-passenger models) or second seats (6-passenger models)
- ⑤ SRS curtain shield airbags
 - Can help protect primarily the head of occupants in the outer seats
 - Can help prevent the occupants from being thrown from the vehicle in the event of vehicle rollover

SRS airbag system components

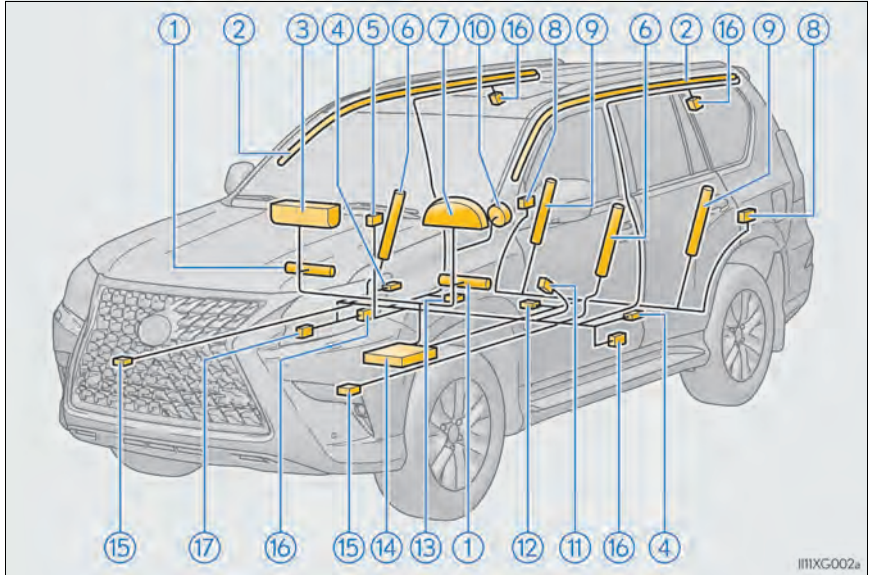

1111XG002a

- | | |
|--|--|
| ① Knee airbags | ⑩ Driver airbag |
| ② Curtain shield airbags | ⑪ Driver's seat belt buckle switch |
| ③ Front passenger airbag | ⑫ Safing sensor (rear) |
| ④ Side impact sensors (front door) | ⑬ Front passenger's seat belt buckle switch |
| ⑤ "PASSENGER AIR BAG" indicator lights | ⑭ Airbag sensor assembly |
| ⑥ Front side airbags | ⑮ Front impact sensors |
| ⑦ SRS warning light | ⑯ Seat belt pretensioners and force limiters |
| ⑧ Side impact sensors (rear) | ⑰ Front passenger occupant classification system (ECU and sensors) |
| ⑨ Rear side airbags (outer second seats [7-passenger models] or second seats [6-passenger models]) | |

Your vehicle is equipped with ADVANCED AIRBAGS designed based on the US motor vehicle safety standards (FMVSS208). The airbag sensor assembly (ECU) controls airbag deployment based on information obtained from the sensors etc. shown in the system components diagram above. This information includes crash severity and occupant information. As the airbags deploy, a chemical reaction in the inflators quickly fills the airbags with non-toxic gas to help restrain the motion of the occupants.

WARNING

■ SRS airbag precautions

Observe the following precautions regarding the SRS airbags. Failure to do so may cause death or serious injury.

- The driver and all passengers in the vehicle must wear their seat belts properly. The SRS airbags are supplemental devices to be used with the seat belts.
- The SRS driver airbag deploys with considerable force, and can cause death or serious injury especially if the driver is very close to the airbag. The National Highway Traffic Safety Administration (NHTSA) advises:

Since the risk zone for the driver's airbag is the first 2 - 3 in. (50 - 75 mm) of inflation, placing yourself 10 in. (250 mm) from your driver airbag provides you with a clear margin of safety. This distance is measured from the center of the steering wheel to your breastbone. If you sit less than 10 in. (250 mm) away now, you can change your driving position in several ways:

- Move your seat to the rear as far as you can while still reaching the pedals comfortably.
- Slightly recline the back of the seat. Although vehicle designs vary, many drivers can achieve the 10 in. (250 mm) distance, even with the driver seat all the way forward, simply by reclining the back of the seat somewhat. If reclining the back of your seat makes it hard to see the road, raise yourself by using a firm, non-slippery cushion, or raise the seat if your vehicle has that feature.
- If your steering wheel is adjustable, tilt it downward. This points the airbag toward your chest instead of your head and neck.

The seat should be adjusted as recommended by NHTSA above, while still maintaining control of the foot pedals, steering wheel, and your view of the instrument panel controls.

WARNING

■ SRS airbag precautions

- If the seat belt extender has been connected to the front seat belt buckles but the seat belt extender has not also been fastened to the latch plate of the seat belt, the SRS front airbags will judge that the driver and front passenger are wearing the seat belt even though the seat belt has not been connected. In this case, the SRS front airbags may not activate correctly in a collision, resulting in death or serious injury in the event of a collision. Be sure to wear the seat belt with the seat belt extender.



- The SRS front passenger airbag also deploys with considerable force, and can cause death or serious injury especially if the front passenger is very close to the airbag. The front passenger seat should be as far from the airbag as possible with the seatback adjusted, so the front passenger sits upright.
- Improperly seated and/or restrained infants and children can be killed or seriously injured by a deploying airbag. An infant or child who is too small to use a seat belt should be properly secured using a child restraint system. Lexus strongly recommends that all infants and children be placed in the rear seats of the vehicle and properly restrained. The rear seats are safer for infants and children than the front passenger seat. (→P. 54)
- Do not sit on the edge of the seat or lean against the dashboard.

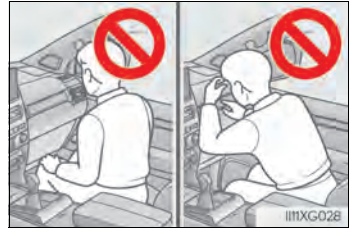

- Do not allow a child to stand in front of the SRS front passenger airbag unit or sit on the knees of a front passenger.
- Do not allow the front seat occupants to hold items on their knees.



⚠ WARNING

■ SRS airbag precautions

- Do not lean against the door, the roof side rail or the front, side and rear pillars.



- Do not allow anyone to kneel on the passenger seats toward the door or put their head or hands outside the vehicle.



- Do not attach anything to or lean anything against areas such as the dashboard, steering wheel pad and lower portion of the instrument panel. These items can become projectiles when the SRS driver, front passenger and knee airbags deploy.

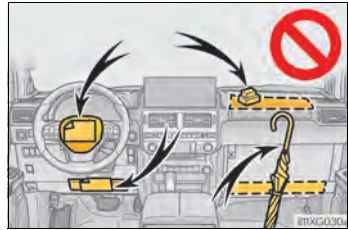

⚠ WARNING

■ SRS airbag precautions

- Do not attach anything to areas such as a door, windshield, side door glass, front or rear pillar, roof side rail and assist grip.

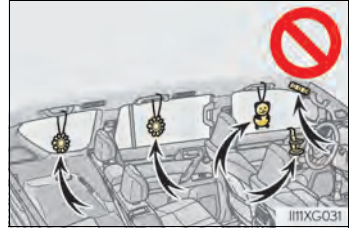

- Do not hang coat hangers or other hard objects on the coat hooks. All of these items could become projectiles and may cause death or serious injury, should the SRS curtain shield airbags deploy.
- If a vinyl cover is put on the area where the SRS knee airbag will deploy, be sure to remove it.
- Do not use seat accessories which cover the parts where the SRS side airbags inflate as they may interfere with inflation of the SRS airbags. Such accessories may prevent the side airbags from activating correctly, disable the system or cause the side airbags to inflate accidentally, resulting in death or serious injury.
- Do not strike or apply significant levels of force to the area of the SRS airbag components. Doing so can cause the SRS airbags to malfunction.
- Do not touch any of the component parts immediately after the SRS airbags have deployed (inflated) as they may be hot.
- If breathing becomes difficult after the SRS airbags have deployed, open a door or window to allow fresh air in, or leave the vehicle if it is safe to do so. Wash off any residue as soon as possible to prevent skin irritation.
- If the areas where the SRS airbags are stored, such as the steering wheel pad and front and rear pillar garnishes, are damaged or cracked, have them replaced by your Lexus dealer.
- Do not place anything such as a cushion on the front passenger's seat. Doing so will disperse the passenger's weight, which prevents the sensor from detecting the passenger's weight properly. As a result, the SRS front airbags for the front passenger may not deploy in the event of a collision.

 **WARNING****■ Modification and disposal of SRS airbag system components**

Do not dispose of your vehicle or perform any of the following modifications without consulting your Lexus dealer. The SRS airbags may malfunction or deploy (inflate) accidentally, causing death or serious injury.

- Installation, removal, disassembly and repair of the SRS airbags
- Repairs, modifications, removal or replacement of the steering wheel, instrument panel, dashboard, seats or seat upholstery, front, side and rear pillars or roof side rails
- Repairs or modifications of the front fender, front bumper, or side of the occupant compartment
- Installation of a grille guard (bull bars, kangaroo bar, etc.), snow plows, winches or roof luggage carrier
- Modifications to the vehicle's suspension system
- Installation of electronic devices such as mobile two-way radios and CD players
- Modifications to your vehicle for a person with a physical disability

■ If the SRS airbags deploy (inflate)

- Slight abrasions, burns, bruising etc., may be sustained from SRS airbags, due to the extremely high speed deployment (inflation) by hot gases.
- A loud noise and white powder will be emitted.
- Parts of the airbag module (steering wheel hub, airbag cover and inflator) as well as the front seats, parts of the front and rear pillars and roof side rails, may be hot for several minutes. The airbag itself may also be hot.
- The windshield may crack.
- All of the doors will be unlocked. (→P. 114)
- Fuel supply to the engine will be stopped. (→P. 534)
- For Lexus Enform Safety Connect subscribers, if any of the following situations occur, the system is designed to send an emergency call to the response center, notifying them of the vehicle's location (without needing to push the "SOS" button) and an agent will attempt to speak with the occupants to ascertain the level of emergency and assistance required. If the occupants are unable to communicate, the agent automatically treats the call as an emergency and helps to dispatch the necessary emergency services. (→P. 71)
 - An SRS airbag is deployed.
 - A seat belt pretensioner is activated.
 - The vehicle is involved in a severe rear-end collision.

■ SRS airbag deployment conditions (SRS front airbags)

- The SRS front airbags will deploy in the event of an impact that exceeds the set threshold level (the level of force corresponding to an approximately 12 - 18 mph [20 - 30 km/h] frontal collision with a fixed wall that does not move or deform).

However, this threshold velocity will be considerably higher in the following situations:

- If the vehicle strikes an object, such as a parked vehicle or sign pole, which can move or deform on impact
- If the vehicle is involved in an underride collision, such as a collision in which the front of the vehicle "underrides", or goes under, the bed of a truck
- Depending on the type of collision, it is possible that only the seat belt pretensioners will activate.
- The SRS front airbags for the front passenger will not activate if there is no passenger sitting in the front passenger seat. However, the SRS front airbags for the front passenger may deploy if luggage is put in the seat, even if the seat is unoccupied.

■ SRS airbag deployment conditions (SRS side and curtain shield airbags)

- The SRS side and curtain shield airbags will deploy in the event of an impact that exceeds the set threshold level (the level of force corresponding to the impact force produced by an approximately 3300 lb. [1500 kg] vehicle colliding with the vehicle cabin from a direction perpendicular to the vehicle orientation at an approximate speed of 12 - 18 mph [20 - 30 km/h]).
- Both SRS curtain shield airbags will deploy in the event of vehicle rollover.
- All SRS side and curtain shield airbags will deploy in the event of a severe frontal collision.

■ Conditions under which the SRS airbags may deploy (inflate), other than a collision

The SRS front airbags, SRS side and curtain shield airbags may also deploy if a serious impact occurs to the underside of your vehicle. Some examples are shown in the illustration.

- Hitting a curb, edge of pavement or hard surface
- Falling into or jumping over a deep hole
- Landing hard or falling

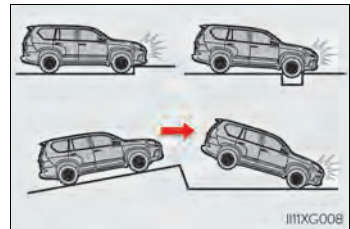

The SRS curtain shield airbags may also deploy under the situations shown in the illustration.

- The angle of vehicle tip-up is marginal
- The vehicle skids and hits a curb stone

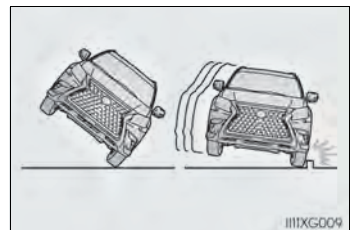

■ Types of collisions that may not deploy the SRS airbags (SRS front airbags)

The SRS front airbags do not generally inflate if the vehicle is involved in a side or rear collision, if it rolls over, or if it is involved in a low-speed frontal collision. But, whenever a collision of any type causes sufficient forward deceleration of the vehicle, deployment of the SRS front airbags may occur.

- Collision from the side
- Collision from the rear
- Vehicle rollover

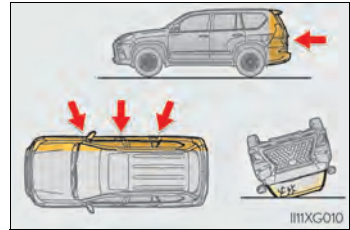

■ Types of collisions that may not deploy the SRS airbags (SRS side and curtain shield airbags)

The SRS side and curtain shield airbags may not activate if the vehicle is subjected to a collision from the side at certain angles, or a collision to the side of the vehicle body other than the passenger compartment.

- Collision from the side to the vehicle body other than the passenger compartment
- Collision from the side at an angle

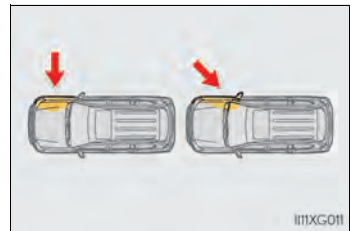

The SRS side airbags do not generally inflate if the vehicle is involved in a rear collision, if it rolls over, or if it is involved in a low-speed side or low-speed frontal collision.

- Collision from the rear
- Vehicle rollover

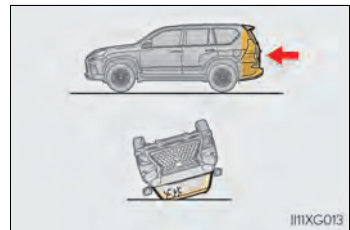

The SRS curtain shield airbags do not generally inflate if the vehicle is involved in a rear collision, if it pitches end over end, or if it is involved in a low-speed side or low-speed frontal collision.

- Collision from the rear
- Pitching end over end

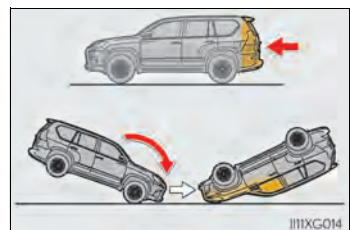

■ When to contact your Lexus dealer

In the following cases, the vehicle will require inspection and/or repair. Contact your Lexus dealer as soon as possible.

- Any of the SRS airbags have been inflated.
- The front of the vehicle is damaged or deformed, or was involved in an accident that was not severe enough to cause the SRS front airbags to inflate.

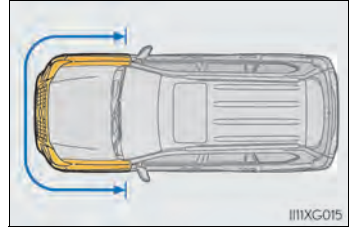

- A portion of a door or its surrounding area is damaged or deformed, or the vehicle was involved in an accident that was not severe enough to cause the SRS side and curtain shield airbags to inflate.

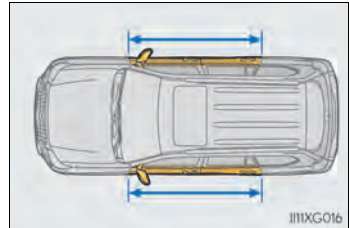

- The pad section of the steering wheel, dashboard near the front passenger airbag or lower portion of the instrument panel is scratched, cracked, or otherwise damaged.

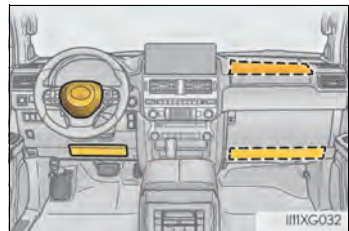

- The surface of the seats with the SRS side airbag is scratched, cracked or otherwise damaged.

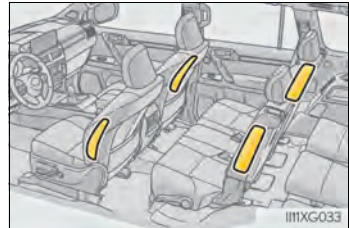

- The portion of the front pillars, rear pillars or roof side rail garnishes (padding) containing the SRS curtain shield airbags inside is scratched, cracked, or otherwise damaged.

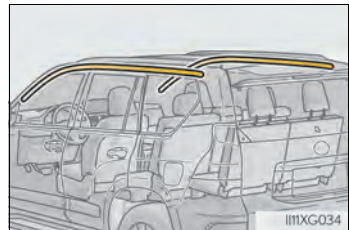

Front passenger occupant classification system

Your vehicle is equipped with a front passenger occupant classification system. This system detects the conditions of the front passenger seat and activates or deactivates the front passenger airbag, front passenger knee airbag, and front passenger's seat belt pretensioner.



- ① SRS warning light
- ② Front passenger's seat belt reminder light
- ③ "PASSENGER AIR BAG" indicator lights

Condition and operation in the front passenger occupant classification system

■ Adult*¹

Indicator/ warning light	"PASSENGER AIR BAG" indicator lights	"PASSENGER AIR BAG ON"
	SRS warning light	Off
	Front passenger's seat belt reminder light	Off* ² or flashing* ³
Devices	Front passenger airbag	Activated
	Front passenger knee airbag	
	Front passenger's seat belt pretensioner	

■ Child*⁴ or child restraint system*⁵

Indicator/ warning light	"PASSENGER AIR BAG" indicator lights	"PASSENGER AIR BAG OFF"* ⁶
	SRS warning light	Off
	Front passenger's seat belt reminder light	Off* ² or flashing* ³
Devices	Front passenger airbag	Deactivated
	Front passenger knee airbag	
	Front passenger's seat belt pretensioner	Activated

■ Unoccupied

Indicator/ warning light	"PASSENGER AIR BAG" indicator lights	Not illuminated
	SRS warning light	Off
	Front passenger's seat belt reminder light	
Devices	Front passenger airbag	Deactivated
	Front passenger knee airbag	
	Front passenger's seat belt pretensioner	Activated* ⁷ or deactivated* ⁸

■ There is a malfunction in the system

Indicator/ warning light	"PASSENGER AIR BAG" indicator lights	"PASSENGER AIR BAG OFF"
	SRS warning light	On
	Front passenger's seat belt reminder light	
Devices	Front passenger airbag	Deactivated
	Front passenger knee airbag	
	Front passenger's seat belt pretensioner	Activated

- *1: The system judges a person of adult size as an adult. When a smaller adult sits in the front passenger seat, the system may recognize him/her as a child depending on his/her physique and posture.
- *2: In the event the front passenger is wearing a seat belt.
- *3: In the event the front passenger does not wear a seat belt
- *4: When a larger child who has outgrown a child restraint system sits in the front passenger seat, the system may recognize him/her as an adult depending on his/her physique or posture.
- *5: Never install a rear-facing child restraint system on the front passenger seat. A forward-facing child restraint system should only be installed on the front passenger seat when it is unavoidable. (→P. 54)
- *6: In case the indicator light is not illuminated, consult this manual on how to install the child restraint system properly. (→P. 58)
- *7: In the event of a side collision.
- *8: In the event of a frontal collision or rollover.

**WARNING****■ Front passenger occupant classification system precautions**

Observe the following precautions regarding the front passenger occupant classification system.

Failure to do so may cause death or serious injury.

- Wear the seat belt properly.
- Make sure the front passenger's seat belt plate has not been left inserted into the buckle before someone sits in the front passenger seat.
- Make sure the "PASSENGER AIR BAG OFF" indicator light is not illuminated when using the seat belt extender for the front passenger seat. If the "PASSENGER AIR BAG OFF" indicator light is illuminated, disconnect the extender tongue from the seat belt buckle, and reconnect the seat belt. Reconnect the seat belt extender after making sure the "PASSENGER AIR BAG ON" indicator light is illuminated. If you use the seat belt extender while the "PASSENGER AIR BAG OFF" indicator light is illuminated, the SRS airbags for the front passenger will not activate, which could cause death or serious injury in the event of a collision.
- Do not apply a heavy load to the front passenger seat or equipment (e.g. seatback pocket).
- Do not put weight on the front passenger seat by putting your hands or feet on the front passenger seat seatback from the rear passenger seat.
- Do not let a rear passenger lift the front passenger seat with their feet or press on the seatback with their legs.
- Do not put objects under the front passenger seat.

**WARNING****■ Front passenger occupant classification system precautions**

- Do not recline the front passenger seatback so far that it touches a rear seat. This may cause the “PASSENGER AIR BAG OFF” indicator light to be illuminated, which indicates that the SRS airbags for the front passenger will not activate in the event of a severe accident. If the seatback touches the rear seat, return the seatback to a position where it does not touch the rear seat. Keep the front passenger seatback as upright as possible when the vehicle is moving. Reclining the seatback excessively may lessen the effectiveness of the seat belt system.
- If an adult sits in the front passenger seat, the “PASSENGER AIR BAG ON” indicator light is illuminated. If the “PASSENGER AIR BAG OFF” indicator is illuminated, ask the passenger to sit up straight, well back in the seat, feet on the floor, and with the seat belt worn correctly. If the “PASSENGER AIR BAG OFF” indicator still remains illuminated, either ask the passenger to move to the rear seat, or if that is not possible, move the front passenger seat fully rearward.
- When it is unavoidable to install a forward-facing child restraint system on the front passenger seat, install the child restraint system on the front passenger seat in the proper order. (→P. 58)
- Do not modify or remove the front seats.
- Do not kick the front passenger seat or subject it to severe impact. Otherwise, the SRS warning light may come on to indicate a malfunction of the front passenger occupant classification system. In this case, contact your Lexus dealer immediately.
- Child restraint systems installed on the rear seat should not contact the front seatbacks.
- Do not use a seat accessory, such as a cushion and seat cover, that covers the seat cushion surface.
- Do not modify or replace the upholstery of the front seat.

Safety information for children

Observe the following precautions when children are in the vehicle.
Use a child restraint system appropriate for the child, until the child becomes large enough to properly wear the vehicle's seat belt.

- It is recommended that children sit in the rear seats to avoid accidental contact with the shift lever, wiper switch etc.
- Use the rear door child-protector lock or the window lock switch to avoid children opening the door while driving or operating the power window accidentally. (→P. 111, 160)
- Do not let small children operate equipment which may catch or pinch body parts, such as the power window, hood, back door, seats etc.



WARNING

Never leave children unattended in the vehicle, and never allow children to have or use the key.

Children may be able to start the vehicle or shift the vehicle into neutral. There is also a danger that children may injure themselves by playing with the windows, the moon roof or other features of the vehicle. In addition, heat build-up or extremely cold temperatures inside the vehicle can be fatal to children.

Child restraint systems

A child restraint system for a small child or baby must itself be properly restrained on the seat with the LATCH anchors or the lap portion of the lap/shoulder belt.

The laws of all 50 states of the U.S.A. and Canada now require the use of child restraint systems.

Points to remember

Studies have shown that installing a child restraint on a rear seat is much safer than installing one on the front passenger seat.

- Choose a child restraint system that suits your vehicle and is appropriate to the age and size of the child.
- For installation details, follow the instructions provided with the child restraint system.

General installation instructions are provided in this manual. (→P. 58)

Types of child restraints

Child restraint systems are classified into the following 3 types according to the age and size of the child:

- ▶ Rear facing — Infant seat/convertible seat
- ▶ Forward facing — Convertible seat

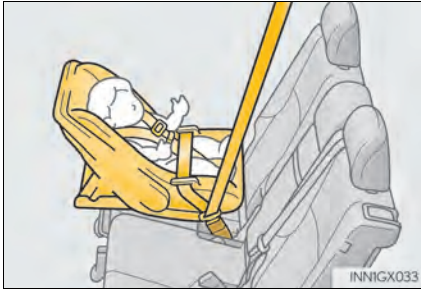

- ▶ Booster seat



■ Selecting an appropriate child restraint system

- Use a child restraint system appropriate for the child until the child becomes large enough to properly wear the vehicle's seat belt.
- If the child is too large for a child restraint system, sit the child on a rear seat and use the vehicle's seat belt. (→P. 30)

**WARNING****■ Child restraint precautions**

- For effective protection in automobile accidents and sudden stops, a child must be properly restrained, using a seat belt or child restraint system depending on the age and size of the child. Holding a child in your arms is not a substitute for a child restraint system. In an accident, the child can be crushed against the windshield, or between you and the vehicle's interior.
- Lexus strongly urges the use of a proper child restraint system that conforms to the size of the child, installed on the rear seat. According to accident statistics, the child is safer when properly restrained in the rear seat than in the front seat.
- Never install a rear-facing child restraint system on the front passenger seat even if the "PASSENGER AIR BAG OFF" indicator light is illuminated.
In the event of an accident, the force of the rapid inflation of the front passenger airbag can cause death or serious injury to the child if the rear-facing child restraint system is installed on the front passenger seat.
- A forward-facing child restraint system may be installed on the front passenger seat only when it is unavoidable. A child restraint system that requires a top tether strap should not be used in the front passenger seat since there is no top tether strap anchor for the front passenger seat. Adjust the seatback as upright as possible and always move the seat as far back as possible even if the "PASSENGER AIR BAG OFF" indicator light is illuminated, because the front passenger airbag could inflate with considerable speed and force. Otherwise, the child may be killed or seriously injured.
- Do not use the seat belt extender when installing a child restraint system on the front or rear passenger seat. If installing a child restraint system with the seat belt extender connected to the seat belt, the seat belt will not securely hold the child restraint system, which could cause death or serious injury to the child or other passengers in the event of a sudden stop, sudden swerve or accident.
- Do not allow the child to lean his/her head or any part of his/her body against the door or the area of the seat, front, center and rear pillars or roof side rails from which the SRS side airbags or SRS curtain shield airbags deploy even if the child is seated in the child restraint system. It is dangerous if the SRS side airbags and curtain shield airbags inflate, and the impact could cause death or serious injury to the child.
- Make sure you have complied with all installation instructions provided by the child restraint manufacturer and that the system is properly secured. If it is not secured properly, it may cause death or serious injury to the child in the event of a sudden stop, sudden swerve or accident.

**WARNING****■ When children are in the vehicle**

Do not allow children to play with the seat belt. If the seat belt becomes twisted around a child's neck, it may lead to choking or other serious injuries that could result in death. If this occurs and the buckle cannot be unfastened, scissors should be used to cut the belt.

■ When the child restraint system is not in use

- Keep the child restraint system properly secured on the seat even if it is not in use. Do not store the child restraint system unsecured in the passenger compartment.
- If it is necessary to detach the child restraint system, remove it from the vehicle or store it securely in the luggage compartment. This will prevent it from injuring passengers in the event of a sudden stop, sudden swerve or accident.

Installing child restraints

Follow the child restraint system manufacturer's instructions. Firmly secure child restraints to the seats using the LATCH anchors or a seat belt. Attach the top tether strap when installing a child restraint.

The lap/shoulder belt can be used if your child restraint system is not compatible with the LATCH (Lower Anchors and Tethers for Children) system.

Child restraint LATCH anchors

► 7-passenger models

LATCH anchors are provided for the right side second seat and between the center and left side second seats. (Buttons displaying the location of the anchors are attached to the seats.)



► 6-passenger models

LATCH anchors are provided for both second seats. (Buttons displaying the location of the anchors are attached to the seats.)



Seat belts equipped with a child restraint locking mechanism (ALR/ELR belts except driver's seat belt) (→P. 32)



Anchor brackets (for top tether strap)

► 7-passenger models

An anchor bracket is provided for each second seat.



► 6-passenger models

Anchor brackets are provided for both second seats and right side third seat.



Installation with LATCH system

- 1 Fold the seatback forward. Then return the seatback and secure it at the first lock position (most upright position). (→P. 134)

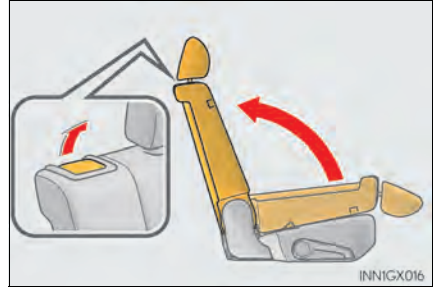

► Type A

- 2 Flip the cover, and latch the hooks of the lower straps onto the LATCH anchors. If the child restraint has a top tether strap, the top tether strap should be latched onto the top tether strap anchor. (→P. 66)

For owners in Canada:

The symbol on a child restraint system indicates the presence of a lower connector system.

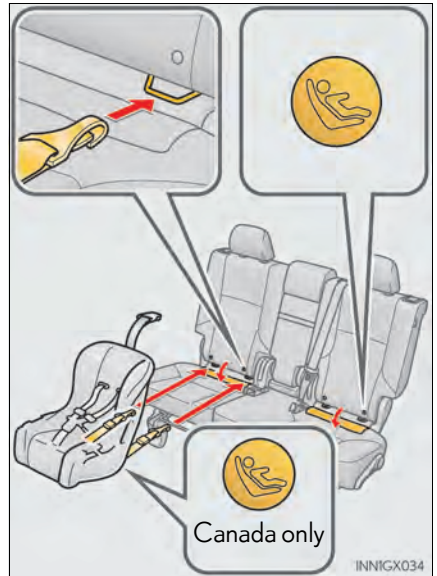

► Type B

- 2 Flip the cover, and latch the buckles onto the LATCH anchors. If the child restraint has a top tether strap, the top tether strap should be latched onto the top tether strap anchor. (→P. 66)

For owners in Canada:

The symbol on a child restraint system indicates the presence of a lower connector system.

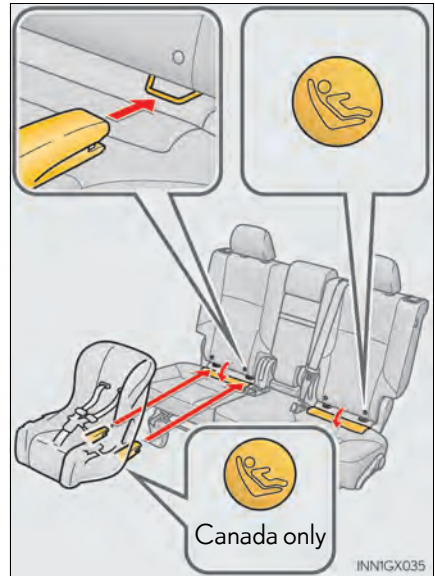

Installing child restraints using a seat belt (child restraint lock function belt)

■ Rear-facing — Infant seat/convertible seat

- 1 Fold the seatback forward. Then return the seatback and secure it at the first lock position (most upright position). (→P. 134)

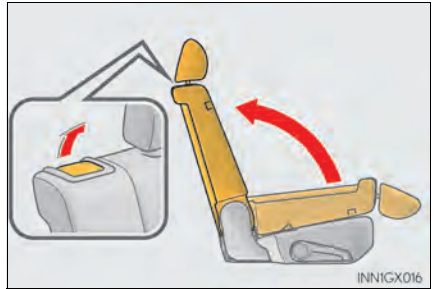

- 2 Place the child restraint system on the seat facing the rear of the vehicle.



- 3 Run the seat belt through the child restraint system and insert the plate into the buckle. Make sure that the belt is not twisted.

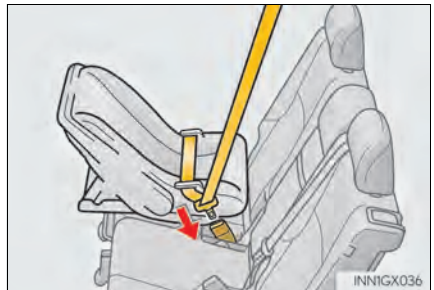

- 4 Fully extend the shoulder belt and allow it to retract to put it in lock mode. In lock mode, the belt cannot be extended.

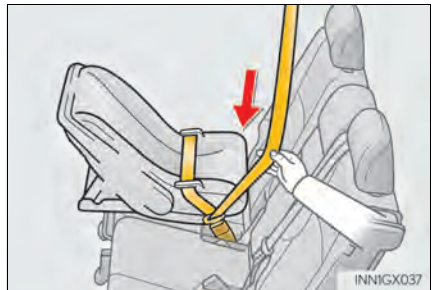

- 5** While pushing the child restraint system down into the seat, allow the shoulder belt to retract until the child restraint system is securely in place.

After the shoulder belt has retracted to a point where there is no slack in the belt, pull the belt to check that it cannot be extended.

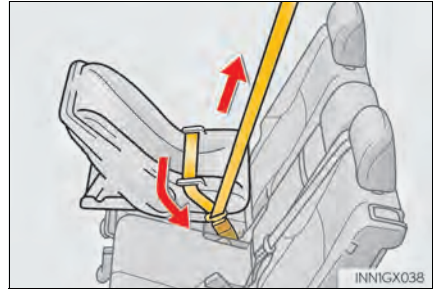

■ Forward-facing — Convertible seat

- 1** Fold the seatback forward. Then return the seatback and secure it at the first lock position (most upright position). (→P. 134)

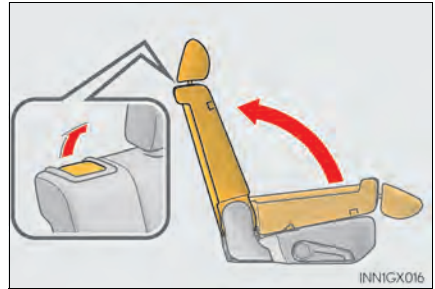

- 2** Place the child restraint system on the seat facing the front of the vehicle.



- 3 Run the seat belt through the child restraint system and insert the plate into the buckle. Make sure that the belt is not twisted.



- 4 Fully extend the shoulder belt and allow it to retract to put it in lock mode. In lock mode, the belt cannot be extended.



- 5 While pushing the child restraint system into the seat, allow the shoulder belt to retract until the child restraint system is securely in place.

After the shoulder belt has retracted to a point where there is no slack in the belt, pull the belt to check that it cannot be extended.



- 6 If the child restraint has a top tether strap, the top tether strap should be latched onto the top tether strap anchor. (→P. 66)

■ Booster seat

- 1 Fold the seatback forward. Then return the seatback and secure it at the first lock position (most upright position). (→P. 134)

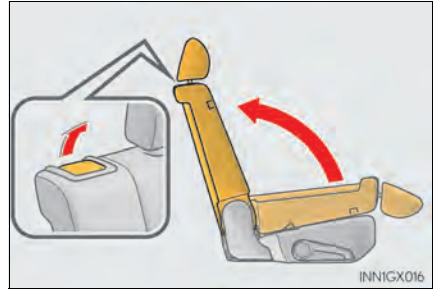

- 2 Place the child restraint system on the seat facing the front of the vehicle.



- 3 Sit the child in the child restraint system. Fit the seat belt to the child restraint system according to the manufacturer's instructions and insert the plate into the buckle. Make sure that the belt is not twisted.

Check that the shoulder belt is correctly positioned over the child's shoulder and that the lap belt is as low as possible. (→P. 30)



Removing a child restraint installed with a seat belt

Push the buckle release button and fully retract the seat belt.

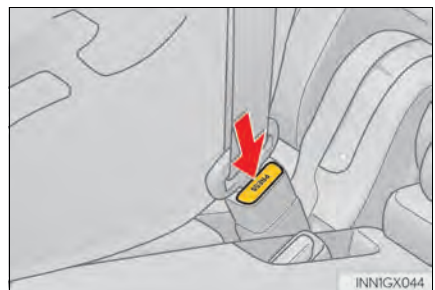

Child restraint systems with a top tether strap (second seats)

- 1 Secure the child restraint system using the seat belt or LATCH anchors and move the head restraint in place at the upmost position.



► 7-passenger models

- 2 Open the anchor bracket cover, latch the hook onto the anchor bracket and tighten the top tether strap.

Make sure the top tether strap is securely latched.

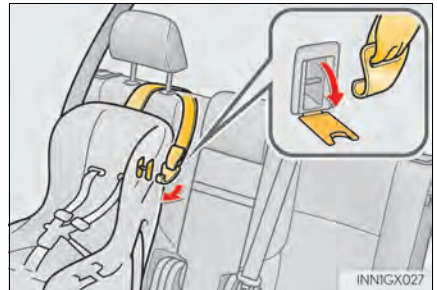

► 6-passenger models

- 2 Latch the hook onto the anchor bracket and tighten the top tether strap.

Make sure the top tether strap is securely latched.

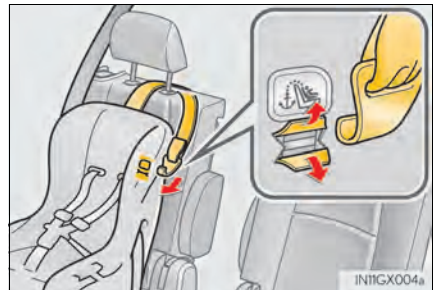

Child restraint systems with a top tether strap (right side third seat for 6-passenger models)

- 1 Lift up the head restraint system until it locks and secure the child restraint system using the seat belt.

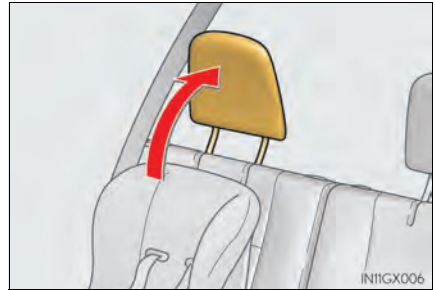

- 2 Latch the hook onto the anchor bracket and tighten the top tether strap.

Make sure the top tether strap is securely latched.



■ Laws and regulations pertaining to anchorages

The LATCH system conforms to FMVSS225 or CMVSS210.2.

Child restraint systems conforming to FMVSS213 or CMVSS213 specifications can be used.

This vehicle is designed to conform to the SAE J1819.

WARNING

■ When installing a booster seat

To prevent the belt from going into ALR lock mode, do not fully extend the shoulder belt. ALR mode causes the belt to tighten only. This could cause injury or discomfort to the child. (→P. 32)

■ When installing a child restraint system

Follow the directions given in the child restraint system installation manual and fix the child restraint system securely in place.

If the child restraint system is not correctly fixed in place, the child or other passengers may be seriously injured or even killed in the event of sudden braking, sudden swerving or an accident.

- If the driver's seat interferes with the child restraint system and prevents it from being attached correctly, attach the child restraint system to the right-hand rear seat.
- Adjust the front passenger seat so that it does not interfere with the child restraint system.
- Child restraint system installed on the third seat should not contact the second seatbacks.

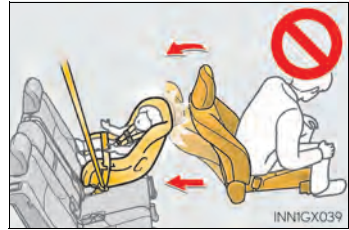

- Only put a forward-facing child restraint system on the front seat when unavoidable. When installing a forward-facing child restraint system on the front passenger seat, move the seat as far back as possible even if the "PASSENGER AIR BAG OFF" indicator light is illuminated. Failure to do so may result in death or serious injury if the airbags deploy (inflate).



- When installing a child restraint system in the center second seat, adjust both seatbacks at the same angle.
- When using the LATCH anchors for a child restraint system, move the seat as far back as possible (second seat only), with the seatback close to the child restraint system.

 **WARNING****■ When installing a child restraint system**

- When a booster seat is installed, always ensure that the shoulder belt is positioned across the center of the child's shoulder. The belt should be kept away from the child's neck, but not so that it could fall off the child's shoulder. Failing to do so may result in death or serious injury in the event of sudden braking, sudden swerving or an accident.
- Ensure that the belt and plate are securely locked and the seat belt is not twisted.
- Shake the child restraint system left and right, and forward and backward to ensure that it has been securely installed.
- After securing a child restraint system, never adjust the seat.
- Follow all installation instructions provided by the child restraint system manufacturer.
- When securing some types of child restraint systems in second or third row seats, it may not be possible to properly use the seat belts in positions next to the child restraint without interfering with it or affecting seat belt effectiveness. Be sure your seat belt fits snugly across your shoulder and low on your hips. If it does not, or if it interferes with the child restraint, move to a different position. Failure to do so may result in death or serious injury.

■ Do not use a seat belt extender

If a seat belt extender is used when installing a child restraint system, the seat belt will not securely hold the child restraint system, which could cause death or serious injury to the child or other passengers in the event of sudden braking, sudden swerving or an accident.

■ To correctly attach a child restraint system to the anchors

When using the LATCH anchors, be sure that there are no foreign objects around the anchors and that the seat belt is not caught behind the child restraint system. Make sure the child restraint system is securely attached, or it may cause death or serious injury to the child or other passengers in the event of a sudden stop, sudden swerve or accident.

Exhaust gas precautions

Harmful substance to the human body is included in exhaust gases if inhaled.

WARNING

Exhaust gases include harmful carbon monoxide (CO), which is colorless and odorless. Observe the following precautions.

Failure to do so may cause exhaust gases enter the vehicle and may lead to an accident caused by light-headedness, or may lead to death or a serious health hazard.

■ Important points while driving

- Keep the back door closed.
- If you smell exhaust gases in the vehicle even when the back door is closed, open the windows and have the vehicle inspected at your Lexus dealer as soon as possible.

■ When parking

- If the vehicle is in a poorly ventilated area or a closed area, such as a garage, stop the engine.
- Do not leave the vehicle with the engine running for a long time.
If such a situation cannot be avoided, park the vehicle in an open space and ensure that exhaust fumes do not enter the vehicle interior.
- Do not leave the engine running in an area with snow build-up, or where it is snowing.
If snowbanks build up around the vehicle while the engine is running, exhaust gases may collect and enter the vehicle.

■ Exhaust pipe

The exhaust system needs to be checked periodically. If there is a hole or crack caused by corrosion, damage to a joint or abnormal exhaust noise, be sure to have the vehicle inspected and repaired by your Lexus dealer.

LEXUS Enform Safety Connect*

Safety Connect is a subscription-based telematics service that uses Global Positioning System (GPS) data and embedded cellular technology to provide safety and security features to subscribers. Safety Connect is supported by Lexus' designated response center, which operates 24 hours per day, 7 days per week.

Safety Connect service is available by subscription on select, telematics hardware-equipped vehicles.

By using the Safety Connect service, you are agreeing to be bound by the Telematics Subscription Service Agreement and its Terms and Conditions, as in effect and amended from time to time, a current copy of which is available at Lexus.com. All use of the Safety Connect service is subject to such then-applicable Terms and Conditions.

System components

- ① Microphone
- ② LED light indicators
- ③ "SOS" button

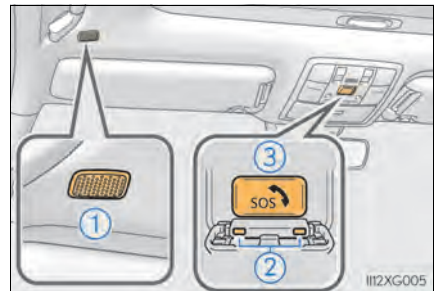

*: If equipped

Services

Subscribers have the following Safety Connect services available:

- Automatic Collision Notification*
Helps drivers receive necessary response from emergency service providers.
(→P. 74)
*: U.S. Patent No. 7,508,298 B2
- Stolen Vehicle Location
Helps drivers in the event of vehicle theft. (→P. 74)
- Emergency Assistance Button (“SOS”)
Connects drivers to response-center support. (→P. 74)
- Enhanced Roadside Assistance
Provides drivers various on-road assistance. (→P. 74)

Subscription

After you have signed the Telematics Subscription Service Agreement and are enrolled, you can begin receiving services.

A variety of subscription terms is available for purchase. Contact your Lexus dealer, call the following or push the “SOS” button in your vehicle for further subscription details.

- The United States
1-800-25-LEXUS (1-800-255-3987)
- Canada
1-800-26-LEXUS (1-800-265-3987)
- Puerto Rico
1-877-539-8777

■ Safety Connect Services Information

- Phone calls using the vehicle's Bluetooth® technology will not be possible during Safety Connect.
- Safety Connect is available beginning Fall 2009 on select Lexus models (in the contiguous United States only). Contact with the Safety Connect response center is dependent upon the telematics device being in operative condition, cellular connection availability, and GPS satellite signal reception, which can limit the ability to reach the response center or receive emergency service support. Enrollment and Telematics Subscription Service Agreement required. A variety of subscription terms is available; charges vary by subscription term selected and location.
- Automatic Collision Notification, Emergency Assistance and Stolen Vehicle Location will function in the United States, including Hawaii and Alaska, Puerto Rico and in Canada, and Enhanced Roadside Assistance will function in the United States, Puerto Rico and in Canada.
- Automatic Collision Notification, Emergency Assistance, Stolen Vehicle and Enhanced Road Assistance will not function in the United States Virgin Islands. For vehicles first sold in the USVI, no Safety Connect services will function in and outside the United States Virgin Islands.
- Safety Connect services are not subject to section 255 of the Telecommunications Act and the device is not TTY compatible.

■ Languages

The Safety Connect response center will offer support in multiple languages. The Safety Connect system will offer voice prompts in English, Spanish, and French. Please indicate your language of choice when enrolling.

■ When contacting the response center

You may be unable to contact the response center if the network is busy.

Safety Connect LED light Indicators

When the engine switch is turned to IGNITION ON mode, the red indicator light comes on for 2 seconds then turns off. Afterward, the green indicator light comes on, indicating that the service is active.

The following indicator light patterns indicate specific system usage conditions:

- Green indicator light on = Active service
- Green indicator light flashing = Safety Connect call in process
- Red indicator light (except at vehicle start-up) = System malfunction (contact your Lexus dealer)
- No indicator light (off) = Safety Connect service not active

Safety Connect services

■ Automatic Collision Notification

In case of either airbag deployment or severe rear-end collision, the system is designed to automatically call the response center. The responding agent receives the vehicle's location and attempts to speak with the vehicle occupants to assess the level of emergency. If the occupants are unable to communicate, the agent automatically treats the call as an emergency, contacts the nearest emergency services provider to describe the situation, and requests that assistance be sent to the location.

■ Stolen Vehicle Location

If your vehicle is stolen, Safety Connect can work with local authorities to assist them in locating and recovering the vehicle. After filing a police report, call the Safety Connect response center at 1-800-25-LEXUS (1-800-255-3987) in the United States, 1-877-539-8777 in Puerto Rico or 1-800-265-3987 in Canada, and follow the prompts for Safety Connect to initiate this service.

In addition to assisting law enforcement with recovery of a stolen vehicle, Safety-Connect-equipped vehicle location data may, under certain circumstances, be shared with third parties to locate your vehicle. Further information is available at Lexus.com.

■ Emergency Assistance Button ("SOS")

In the event of an emergency on the road, push the "SOS" button to reach the Safety Connect response center. The answering agent will determine your vehicle's location, assess the emergency, and dispatch the necessary assistance required.

If you accidentally press the "SOS" button, tell the response-center agent that you are not experiencing an emergency.

■ Enhanced Roadside Assistance

Enhanced Roadside Assistance adds GPS data to the already included warranty-based Lexus roadside service.

Subscribers can press the "SOS" button to reach a Safety Connect response-center agent, who can help with a wide range of needs, such as: towing, flat tire, fuel delivery, etc. For a description of the Roadside Assistance services and their limitations, please see the Safety Connect Terms and Conditions, which are available at Lexus.com.

Safety information for Safety Connect

Important! Read this information before using Safety Connect.

■ Exposure to radio frequency signals

The Safety Connect system installed in your vehicle is a low-power radio transmitter and receiver. It receives and also sends out radio frequency (RF) signals.

In August 1996, the Federal Communications Commission (FCC) adopted RF exposure guidelines with safety levels for mobile wireless phones. Those guidelines are consistent with the safety standards previously set by the following U.S. and international standards bodies.

- ANSI (American National Standards Institute) C95.1 [1992]
- NCRP (National Council on Radiation Protection and Measurement) Report 86 [1986]
- ICNIRP (International Commission on Non-Ionizing Radiation Protection) [1996]

Those standards were based on comprehensive and periodic evaluations of the relevant scientific literature. Over 120 scientists, engineers, and physicians from universities, and government health agencies and industries reviewed the available body of research to develop the ANSI Standard (C95.1).

The design of Safety Connect complies with the FCC guidelines in addition to those standards.

Engine immobilizer system

The vehicle's keys have built-in transponder chips that prevent the engine from starting if a key has not been previously registered in the vehicle's on-board computer.

Never leave the keys inside the vehicle when you leave the vehicle.

This system is designed to help prevent vehicle theft but does not guarantee absolute security against all vehicle thefts.

The indicator light flashes after the engine switch has been turned off to indicate that the system is operating.

The indicator light stops flashing after the engine switch has been turned to ACCESSORY or IGNITION ON mode to indicate that the system has been canceled.

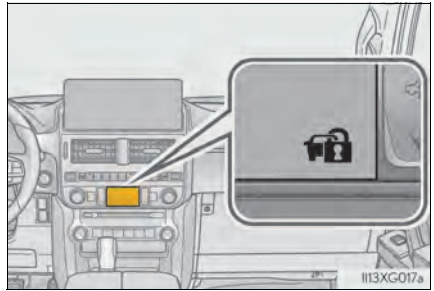

■ System maintenance

The vehicle has a maintenance-free type engine immobilizer system.

■ Conditions that may cause the system to malfunction

- If the grip portion of the key is in contact with a metallic object
- If the key is in close proximity to or touching a key to the security system (key with a built-in transponder chip) of another vehicle

⚠ NOTICE

■ To ensure the system operates correctly

Do not modify or remove the system. If modified or removed, the proper operation of the system cannot be guaranteed.

Alarm

The alarm

The alarm uses light and sound to give an alert when an intrusion is detected.

The alarm is triggered in the following situations when the alarm is set:

- For the U.S.A.: A locked door or glass hatch is unlocked or opened in any way other than using the entry function, wireless remote control or mechanical key. (The doors will lock again automatically.)
- For Canada: A locked door or glass hatch is unlocked or opened in any way other than using the entry function or the wireless remote control. (The doors will lock again automatically.)
- The hood is opened.

Setting the alarm system

Close the doors, glass hatch and hood, and lock all the doors. The system will be set automatically after 30 seconds.

The indicator light changes from being on to flashing when the system is set.

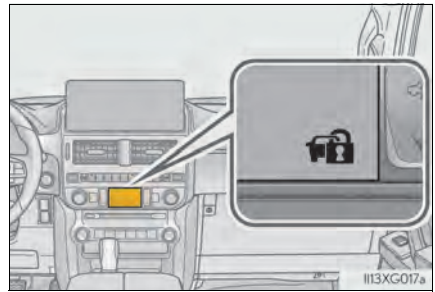

Deactivating or stopping the alarm

Do one of the following to deactivate or stop the alarms:

- Unlock the doors.
- Turn the engine switch to ACCESSORY or IGNITION ON mode, or start the engine. (The alarm will be deactivated or stopped after a few seconds.)

■ System maintenance

The vehicle has a maintenance-free type alarm system.

■ Items to check before locking the vehicle

To prevent unexpected triggering of the alarm and vehicle theft, make sure of the following.

- Nobody is in the vehicle.
- The windows and moon roof are closed before the alarm is set.
- No valuables or other personal items are left in the vehicle.

■ Triggering of the alarm

The alarm may be triggered in the following situations:
(Stopping the alarm deactivates the alarm system.)

- For vehicles sold in Canada: The doors are unlocked using the mechanical key.

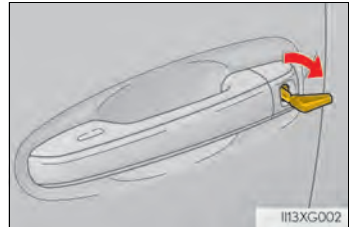

- A person inside the vehicle opens a door or hood, or unlocks the vehicle using an inside lock button.



- The battery is recharged or replaced when the vehicle is locked. (→P. 568)

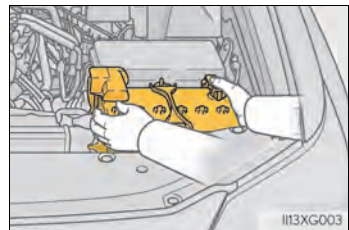

■ Alarm-operated door lock

In the following cases, depending on the situation, the door may automatically lock to prevent improper entry into the vehicle:

- When a person remaining in the vehicle unlocks the door and the alarm is activated.
- While the alarm is activated, a person remaining in the vehicle unlocks the door.
- When recharging or replacing the battery.

■ Alarm memory function

After the alarm is activated, when you unlock any door using a entry function, wireless remote control or mechanical key, the tail lights turn on for about 2 seconds to inform you that the system was activated.



NOTICE

■ To ensure the system operates correctly

Do not modify or remove the system. If modified or removed, the proper operation of the system cannot be guaranteed.

2. Instrument cluster

Warning and indicators

lights82

Gauges and meters88

Multi-information display91

Fuel consumption

information98

Warning and indicators lights

The warning and indicators lights on the instrument cluster and center panel inform the driver of the status of the vehicle's various systems.

For the purpose of explanation, the following illustrations display all warning lights and indicators illuminated.



The units used on the speedometer may differ depending on the target region.

Warning lights

Warning lights inform the driver of malfunctions in any of the vehicle's systems.



Brake system warning light
(→P. 535)



Brake system warning light
(→P. 535)



Charging system warning light
(→P. 535)



High coolant temperature warning light
(→P. 535)



Low engine oil pressure warning light
(→P. 535)

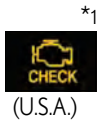

Malfunction indicator lamp
(→P. 535)



Malfunction indicator lamp
(→P. 535)



SRS warning light
(→P. 535)



ABS warning light
(→P. 536)



ABS warning light
(→P. 536)



PCS warning light
(→P. 536)



Slip indicator light
(→P. 536)



Kinetic dynamic suspension system warning light
(→P. 536)



Low speed four-wheel drive indicator light
(→P. 537)



Center differential lock indicator light
(→P. 537)



Open door warning light
(→P. 537)



Low fuel level warning light
(→P. 537)



Driver's and front passenger's seat belt reminder light
(→P. 537)



Tire pressure warning light
(→P. 537)



LDA indicator (→P. 538)



(flashes)
(U.S.A.)

Parking brake indicator
(→P. 536)



*2

Brake Override System
warning light / Drive-Start
Control warning light
(→P. 538)



(flashes)
(Canada)

Parking brake indicator
(→P. 536)

*1: These lights turn on when the engine switch is turned to IGNITION ON mode to indicate that a system check is being performed. They will turn off after the engine is started, or after a few seconds. There may be a malfunction in a system if the lights do not turn on, or turn off. Have the vehicle inspected by your Lexus dealer.

*2: This light is displayed on the multi-information display.

Indicators

The indicators inform the driver of the operating state of the vehicle's various systems.



Turn signal indicator
(→P. 211)



(U.S.A.)

Headlight indicator
(→P. 213)



(Canada)

Tail light indicator
(→P. 213)



Headlight high beam indicator
(→P. 214)



Automatic High Beam indicator
(→P. 216)



(if equipped)

Fog light indicator
(→P. 220)



*2

Eco Driving Indicator Light
(→P. 96)



*1

Cruise control indicator
(→P. 255)



*1

Cruise control "SET" indicator
(→P. 255)



*1

Dynamic radar cruise control indicator
(→P. 255)



*1

LDA indicator (→P. 249)



*1

(flashes)

LDA indicator (→P. 249)



*2,3

Slip indicator (→P. 369)



*2

VSC OFF indicator
(→P. 370)



*1

(if equipped)

Multi-terrain Select indicator
(→P. 292)



*1

(if equipped)

Crawl Control indicator
(→P. 361)



*2

(if equipped)

Downhill assist control system indicator
(→P. 365)



"2nd STRT" indicator
(→P. 207)



Low speed four-wheel drive indicator light (→P. 357)



Center differential lock indicator (→P. 358)



Intuitive parking assist indicator (→P. 267)



*2,4

PCS warning light (→P. 240)



Security indicator *8 (→P. 76, 77)



*1

Smart access system with push-button start indicator (→P. 200)



BSM indicator (→P. 374)



*5,6

BSM (Blind Spot Monitor) outside rear view mirror indicators (→P. 374)



*1,7

Low outside temperature indicator (→P. 88)



*2,8

“PASSENGER AIR BAG” indicator lights (→P. 47)



*2

TRAC OFF indicator (→P. 370)



*1

(if equipped)

MUD & SAND mode indicator (→P. 293)



*1

(if equipped)

MOGUL mode indicator (→P. 293)



*1

(if equipped)

ROCK mode indicator (→P. 293)



*1

(if equipped)

LOOSE & ROCK mode indicator (→P. 293)



*1

(if equipped)

ROCK & DIRT mode indicator (→P. 293)



*1

(if equipped)

MTS AUTO indicator (→P. 293)



*1

(if equipped)

Sport mode indicator (→P. 356)



*1

(if equipped)

Comfort mode indicator (→P. 356)

- *1: This light is displayed on the multi-information display.
- *2: These lights turn on when the engine switch is turned to IGNITION ON mode to indicate that a system check is being performed. They will turn off after the engine is started, or after a few seconds. There may be a malfunction in a system if the lights do not turn on, or turn off. Have the vehicle inspected by your Lexus dealer.
- *3: The light flashes to indicate that the system is operating.
- *4: The light comes on when the system is turned off.
- *5: In order to confirm operation, the BSM outside rear view mirror indicators illuminate in the following situations:
 - When the engine switch is turned to IGNITION ON mode while the system is set to on.
 - When the system is set to on while the engine switch is in IGNITION ON mode.If the system is functioning correctly, the BSM outside rear view mirror indicators will turn off after a few seconds.
If the BSM outside rear view mirror indicators do not illuminate or do not turn off, there may be a malfunction with the system.
If this occurs, have the vehicle inspected by your Lexus dealer.
- *6: This light illuminates on the outside rear view mirrors.
- *7: When the outside temperature is approximately 37°F (3°C) or lower, the indicator will flash for approximately 10 seconds, then stay on.
- *8: This light illuminates on the center panel.

**WARNING****■ If a safety system warning light does not come on**

Should a safety system light such as the ABS/Multi Terrain ABS and the SRS warning light not come on when you start the engine, this could mean that these systems are not available to help protect you in an accident, which could result in death or serious injury. Have the vehicle inspected by your Lexus dealer immediately if this occurs.

Gauges and meters

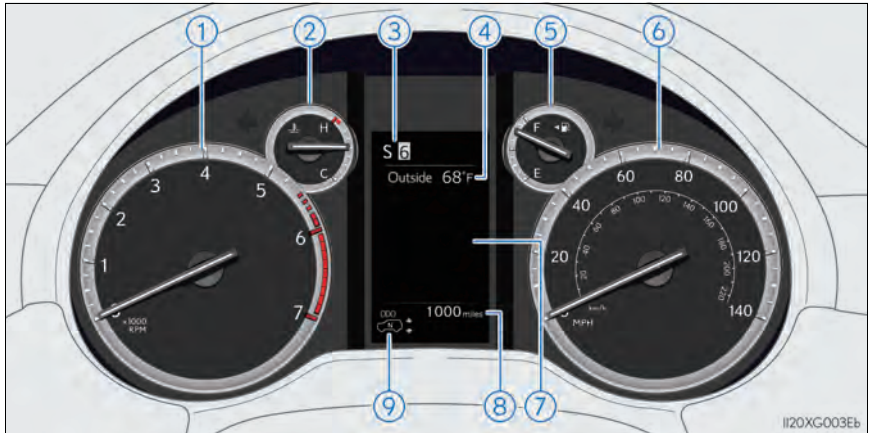

The units used on the speedometer may differ depending on the target region.

- ① Tachometer
Displays the engine speed in revolutions per minute
- ② Engine coolant temperature gauge
Displays the engine coolant temperature
- ③ Shift position and shift range
Displays the selected shift position or selected shift range (→P. 206)
- ④ Outside temperature
Displays the outside temperature within the range of -40°F (-40°C) to 122°F (50°C). Low outside temperature indicator comes on when the ambient temperature is 37°F (3°C) or lower.
- ⑤ Fuel gauge
Displays the quantity of fuel remaining in the tank
- ⑥ Speedometer
Displays the vehicle speed
- ⑦ Multi-information display
Presents the driver with a variety of driving-related data (→P. 91)

⑧ Odometer, trip meter and maintenance required information display

Odometer:

Displays the total distance the vehicle has been driven

Trip meter:

Displays the distance the vehicle has been driven since the meter was last reset. Trip meters A and B can be used to record and display different distances independently.

Maintenance required information:

- Displays the maintenance required information when the engine switch is in IGNITION ON mode.
- It can be reset from  of the multi-information display. (→P. 91)

⑨ Rear height control air suspension display (if equipped)

Displays the rear height mode selected (→P. 352)

Changing the display

Switches between odometer, trip meter and maintenance required information displays. When the trip meter is displayed, pressing and holding the button will reset the trip meter.

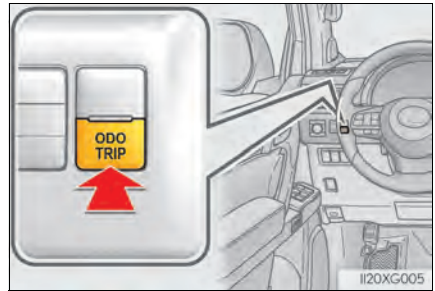

Instrument cluster light control switch

The brightness of the instrument cluster lights can be adjusted.

- ① Brighter
- ② Darker

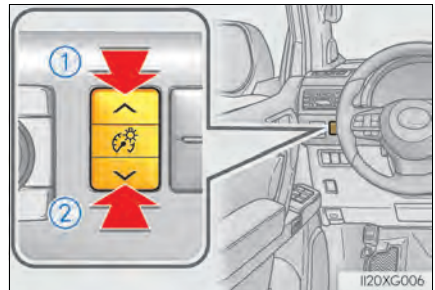

■ The meters and display illuminate when

The engine switch is in IGNITION ON mode.

■ Instrument cluster brightness adjustment

The instrument cluster brightness levels when the tail lights are on and off can be adjusted.

■ The brightness of the instrument cluster lights

When the tail lights are on, the brightness will change. However, when the surroundings are bright (daytime, etc.) turning on the tail lights will not change the instrument cluster brightness.

In addition, the brightness of the instrument cluster lights is automatically adjusted based on the light sensor detecting how bright the surroundings are.

■ Customization

The meter display can be customized on the multi-information display. (→P. 600)

**WARNING****■ The information display at low temperatures**

Allow the interior of the vehicle to warm up before using the liquid crystal information display. At extremely low temperatures, the information display monitor may respond slowly, and display changes may be delayed.

For example, there is a lag between the driver's shifting and the new gear number appearing on the display. This lag could cause the driver to downshift again, causing rapid and excessive engine braking and possibly an accident resulting in death or injury.

**NOTICE****■ To prevent damage to the engine and its components**

- Do not let the indicator needle of the tachometer enter the red zone, which indicates the maximum engine speed.
- The engine may be overheating if the engine coolant temperature gauge is in the red zone (H). In this case, immediately stop the vehicle in a safe place, and check the engine after it has cooled completely. (→P. 570)

Multi-information display

Display contents

The following information will be displayed when a menu icon is selected. (→P. 92)

Some of the information may be displayed automatically depending on the situation.

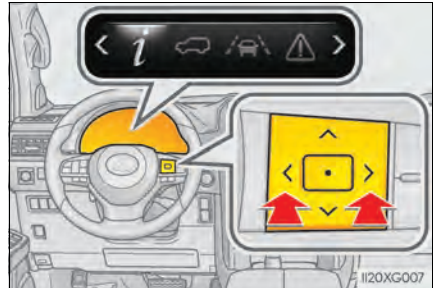

Drive information

Select to display various drive data. (→P. 93)



Vehicle information display

Select to display the vehicle information. (→P. 94)



Driving assist system information

Select to display the operational status of the following systems:

- Dynamic radar cruise control (→P. 255)
- LDA (Lane Departure Alert) (→P. 247)



Warning message display

Select to display warning messages and measures to be taken if a malfunction is detected. (→P. 544)







Settings display

Select to change the meter display settings and the operation settings of some vehicle functions. (→P. 95)

Operating the meter control switches

The multi-information display is operated using the meter control switches.

- ①   : Switch menu
  : Change displayed content, scroll up/down the screen and move the cursor up/down

- ② Press: Enter/Set
 Press and hold: Reset

- ③ Return to the previous screen

- ④ Press: Displays the screen registered to 

When no screen has been registered, the drive information screen will be displayed.

Press and hold: Registers the currently displayed screen to 

When the confirmation screen is displayed, select yes to register the screen. If the selected screen cannot be registered, a registration failure message will be shown.

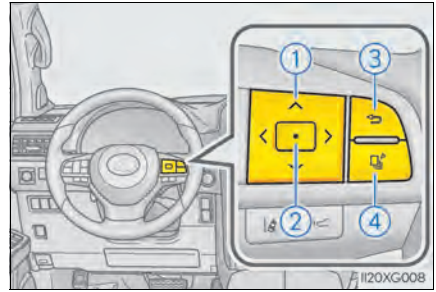

Drive information

■ After Start

- Average fuel economy*
Displays the average fuel consumption since the engine was started.
- Average vehicle speed
Displays the average vehicle speed since the engine was started.
- Elapsed time
Displays the elapsed time since the engine was started.

*: Use the displayed average fuel economy as a reference.

■ After Reset

- Current fuel economy
Displays the current rate of fuel consumption.
- Average fuel economy*^{1,2}
Displays the average fuel consumption since the function was reset.
- Average vehicle speed*²
Displays the average vehicle speed since the function was reset.
- Elapsed time*²
Displays the elapsed time since the function was reset.

*¹: Use the displayed average fuel economy as a reference.

*²: Pressing and holding  will reset.

■ After Refuel

- Range*^{1,2}
Displays the driving range with remaining fuel.
- Average fuel economy*^{2,3}
Displays the average fuel consumption since the vehicle was refueled.

*¹: This distance is computed based on your average fuel consumption. As a result, the actual distance that can be driven may differ from that displayed.

*²: When only a small amount of fuel is added to the tank, the display may not be updated. When refueling, turn the engine switch off. If the vehicle is refueled without turning the engine switch off, the display may not be updated.

*³: Use the displayed average fuel economy as a reference.

■ Eco Indicator (Eco Driving Indicator Zone Display)

→P. 96

■ Speed

Displays the vehicle speed.

■ Sway warning

Detects the sway of the vehicle within a lane, which is often associated with a decrease in the driver's attention level, and displays the decrease in attention using a bar display.

The shorter the bar length, the more the driver may need to rest.

This display is a part of the LDA (Lane Departure Alert) system. The display is enabled when the operating conditions of the vehicle sway warning function are met. (→P. 247)

■ Blank screen (display off)

Drive information is not displayed.

Vehicle information**■ Front tire angle**

Displays the direction of the front tires.

The tire direction is displayed in 3 stages for both left and right, in accordance with the angle of the tire.

If a battery terminal is disconnected and reconnected, the display may be disabled temporarily. After driving the vehicle for a while, the display will be enabled.

■ Tire inflation pressure





Displays inflation pressure of each tire.

The inflation pressure of the spare tire will also be displayed.

Settings display



The settings of the following items can be changed. (→P. 600)

For functions that can be enabled or disabled, the function switches between on and off each time  is pressed.

-  LDA (Lane Departure Alert) (→P. 247)
-  BSM (Blind Spot Monitor) (→P. 374)
-  PCS (Pre-Collision System) (→P. 237)
-  Intuitive parking assist (→P. 267)
- Rear Seat Reminder (→P. 114)
- Vehicle settings
 - Tire pressure warning system (→P. 489)
 - Scheduled maintenance* (→P. 465)
 - Oil maintenance (→P. 478)

■ Meter settings

Select to set the following items.

- Language
Select to change the language on the display.
- Units
Select to change the unit for measure.
-  Eco Driving Indicator Light
Select to activate/deactivate the Eco Driving Indicator Light.
-  Switch settings
You can register 1 screen as the top screen. To register, press and hold  while the desired screen is displayed.
- Initialization
Registered or changed meter settings will be deleted or returned to their default setting.

*: If equipped

■ Eco Driving Indicator

① Eco Driving Indicator Light

During Eco-friendly acceleration operation (Eco driving), the Eco Driving Indicator Light will turn on. When the acceleration exceeds Zone of Eco driving, or when the vehicle is stopped, the light turns off.

② Eco Driving Indicator Zone Display

Suggests the Zone of Eco driving with current Eco driving ratio based on acceleration.

③ Eco driving ratio based on acceleration

If the acceleration exceeds Zone of Eco driving, the right side of Eco Driving Indicator Zone Display will illuminate.

④ Zone of Eco driving

Eco Driving Indicator will not operate under the following conditions:

- The shift lever is in any position other than D.
- Vehicles with adaptive variable suspension system: The driving mode is set to sport mode.
- The vehicle speed is approximately 81 mph (130 km/h) or higher.

■ When disconnecting and reconnecting battery terminals

The drive information other than the current fuel consumption will be reset.

■ Tire inflation pressure

- It may take a few minutes to display the tire inflation pressure after the engine switch is turned to IGNITION ON mode. It may also take a few minutes to display the tire inflation pressure after inflation pressure has been adjusted.
- “---” may be displayed if the tire information cannot be determined due to unfavorable radio wave conditions.
- Tire inflation pressure changes with temperature. The displayed values may also be different from the values measured using a tire pressure gauge.

■ When setting up the display

Stop the vehicle in a safe place, apply the parking brake, and shift the shift lever to P.

■ Suspension of the settings display

In the following situations, the settings display using the meter control switches will be suspended.

- When a warning message appears on the multi-information display
- When the vehicle begins to move

■ Liquid crystal display

Small spots or light spots may appear on the display. This phenomenon is characteristic of liquid crystal displays, and there is no problem continuing to use the display.

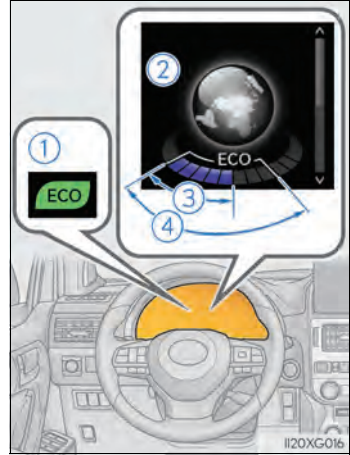

**WARNING****■ Caution for use while driving**

For safety, avoid operating the meter control switch while driving as much as possible, and do not look continuously at the multi-information display while driving. Stop the vehicle and operate the meter control switch. Failure to do so may cause a steering wheel operation error, resulting in an unexpected accident.

■ Cautions while setting up the display

As the engine needs to be running during setting up the display, ensure that the vehicle is parked in a place with adequate ventilation. In a closed area such as a garage, exhaust gases including harmful carbon monoxide (CO) may collect and enter the vehicle. This may lead to death or a serious health hazard.

**NOTICE****■ While setting up the display**

To prevent battery discharge, ensure that the engine is running while setting up the display features.

Fuel consumption screen

Fuel consumption information can be displayed on the Center Display.
The consumption screen can be displayed on the side display.

System components

- ① Center Display
- ② "MENU" button
- ③ Touchpad

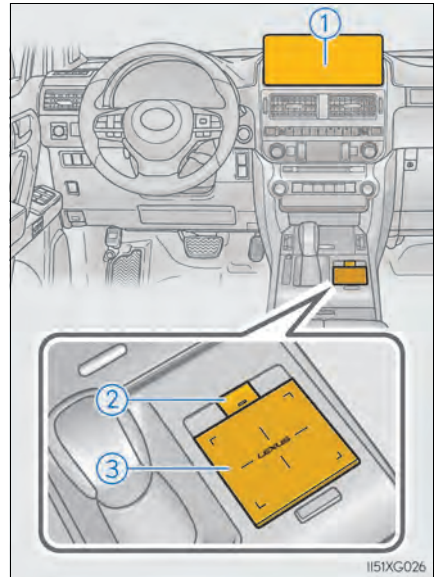

Consumption

Press the “MENU” button on the Remote Touch, then select  on the screen, and then select “Trip Information” or “History”.

This system can also be operated by the touch screen.

■ Trip information

If a screen other than “Trip Information” is displayed, select “Trip Information”.

- ① Resetting the consumption data
- ② Fuel consumption in the past 15 minutes
- ③ Current fuel consumption
- ④ Average vehicle speed since the engine was started.
- ⑤ Elapsed time since the engine was started.
- ⑥ Cruising range

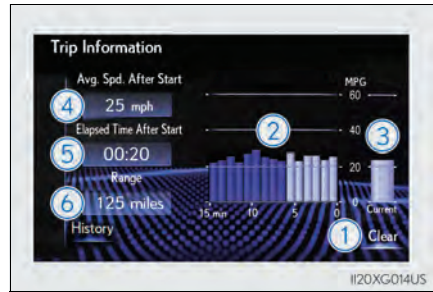

Average fuel consumption for the past 15 minutes is divided by color into past averages and averages attained since the engine switch was last turned to IGNITION ON mode. Use the displayed average fuel consumption as a reference.

The image is an example only, and may vary slightly from actual conditions.

■ History

If a screen other than “History” is displayed, select “History”.

- ① Best recorded fuel consumption
- ② Latest fuel consumption
- ③ Previous fuel consumption record
- ④ Resetting the history data
- ⑤ Updating the latest fuel consumption data



The average fuel consumption history is divided by color into past averages and the average fuel consumption since the last updated. Use the displayed average fuel consumption as a reference.

The image is an example only, and may vary slightly from actual conditions.

■ Updating the history data

Update the latest fuel consumption by selecting "Update" to measure the current fuel consumption again.

■ Resetting the data

The fuel consumption data can be deleted by selecting "Clear".

■ Cruising range

Displays the estimated maximum distance that can be driven with the quantity of fuel remaining.

This distance is computed based on your average fuel consumption.

As a result, the actual distance that can be driven may differ from that displayed.

Using the side display

Display the vehicle information on the side display (→P. 404), and then select **<** or **>** to display the desired screen.

■ Trip information (type A)

Displays the average fuel consumption for the past 10 minutes in 1 minute intervals, as well as the cruising range.

The image is an example only, and may vary slightly from actual conditions.

Use the displayed average fuel consumption as a reference.



■ Trip information (type B)

Displays the cruising range, latest fuel consumption and the amount of time elapsed since the engine was started.

The image is an example only, and may vary slightly from actual conditions.

Use the displayed average fuel consumption as a reference.

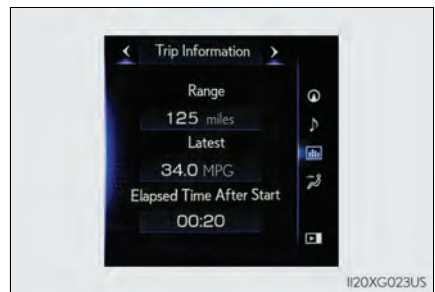

■ History

Displays the average fuel consumption and highest fuel consumption.

The image is an example only, and may vary slightly from actual conditions.

Use the displayed average fuel consumption as a reference.



3-1. Key information	
Keys	104
3-2. Opening, closing and locking the doors	
Side doors	108
Back door	116
Glass hatch	121
Smart access system with push-button start	126
3-3. Adjusting the seats	
Front seats	132
Rear seats	134
Driving position memory	145
Head restraints	150
3-4. Adjusting the steering wheel and mirrors	
Steering wheel	153
Inside rear view mirror	155
Outside rear view mirrors	157
3-5. Opening, closing the windows and moon roof	
Power windows	160
Moon roof	163

Keys

The keys

The following keys are provided with the vehicle.

- ① Electronic keys
 - Operating the smart access system with push-button start (→P. 126)
 - Operating the wireless remote control function
- ② Mechanical keys
- ③ Key number plate



Wireless remote control

- ① Locks the doors (→P. 108)
- ② Unlocks the doors (→P. 108)
- ③ Opens the windows and moon roof* (→P. 108)
- ④ Opens the glass hatch (→P. 121)
- ⑤ Sounds the alarm (→P. 105)

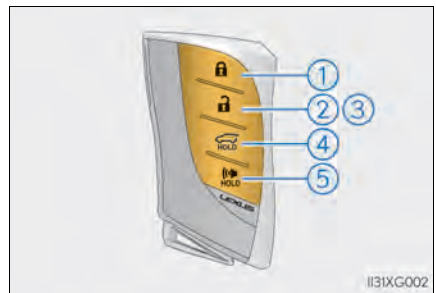

*: These settings must be customized at your Lexus dealer.

Using the mechanical key

To take out the mechanical key, push the release button and take the key out.

The mechanical key can only be inserted in one direction, as the key only has grooves on one side. If the key cannot be inserted in a lock cylinder, turn it over and re-attempt to insert it.

After using the mechanical key, store it in the electronic key. Carry the mechanical key together with the electronic key. If the electronic key battery is depleted or the entry function does not operate properly, you will need the mechanical key. (→P. 564)



■ Panic mode

When  is pressed for longer than about one second, an alarm will sound intermittently and the vehicle lights will flash to deter any person from trying to break into or damage your vehicle.

To stop the alarm, press any button on the electronic key.

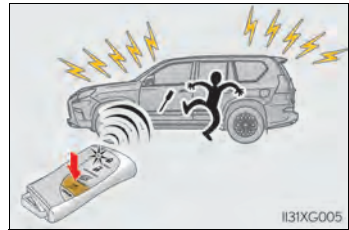

■ When required to leave the vehicle's key with a parking attendant

Lock the glove box as circumstances demand. (→P. 424)

Remove the mechanical key for your own use and provide the attendant with the electronic key only.

■ If you lose your mechanical keys

New genuine mechanical keys can be made by your Lexus dealer using another mechanical key and the key number stamped on your key number plate. Keep the plate in a safe place such as your wallet, not in the vehicle.

■ When riding in an aircraft

When bringing an electronic key onto an aircraft, make sure you do not press any buttons on the electronic key while inside the aircraft cabin. If you are carrying an electronic key in your bag etc., ensure that the buttons are not likely to be pressed accidentally. Pressing a button may cause the electronic key to emit radio waves that could interfere with the operation of the aircraft.

■ Electronic key battery depletion

- The standard battery life is 1 to 2 years.
- If the battery becomes low, an alarm will sound in the cabin when the engine is stopped.
- As the electronic key always receives radio waves, the battery will become depleted even if the electronic key is not used. The following symptoms indicate that the electronic key battery may be depleted. Replace the battery when necessary. (→P. 507)
 - The smart access key system with push-button start or the wireless remote control does not operate.
 - The detection area becomes smaller.
 - The LED indicator on the key surface does not turn on.
- To avoid serious deterioration, do not leave the electronic key within 3 ft. (1 m) of the following electrical appliances that produce a magnetic field:
 - TVs
 - Personal computers
 - Cellular phones, cordless phones and battery chargers
 - Recharging cellular phones or cordless phones
 - Table lamps
 - Induction cookers
- Battery-saving mode can reduce the power consumption of electronic keys that are not used for long periods of time. (→P. 128)

■ Replacing the battery

→P. 507

 NOTICE**■ To prevent key damage**

- Do not drop the keys, subject them to strong shocks or bend them.
- Do not expose the keys to high temperatures for long periods of time.
- Do not get the keys wet or wash them in an ultrasonic washer etc.
- Do not attach metallic or magnetic materials to the keys or place the keys close to such materials.
- Do not disassemble the keys.
- Do not attach a sticker or anything else to the surface of the electronic key.
- Do not place the keys near objects that produce magnetic fields, such as TVs, audio systems and induction cookers.
- Do not place the keys near medical electrical equipment such as low-frequency therapy equipment or microwave therapy equipment, and do not receive medical attention with the keys on your person.

■ Carrying the electronic key on your person

Carry the electronic key 3.9 in. (10 cm) or more away from electric appliances that are turned on. Radio waves emitted from electric appliances within 3.9 in. (10 cm) of the electronic key may interfere with the key, causing the key to not function properly.

■ In case of a smart access system with push-button start malfunction or other key-related problems

Take your vehicle with all the electronic keys provided with your vehicle to your Lexus dealer.

■ When an electronic key is lost

If the electronic key remains lost, the risk of vehicle theft increases significantly. Visit your Lexus dealer immediately with all remaining electronic keys that were provided with your vehicle.

Side doors

The vehicle can be locked and unlocked using the entry function, wireless remote control, key or door lock switch.

Locking and unlocking the doors from the outside

◆ Smart access system with push-button start

Carry the electronic key to enable this function.

- ① Grip the driver's door handle to unlock the door. Grip the passenger's door handle to unlock all the doors.*

Make sure to touch the sensor on the back of the handle.

The doors cannot be unlocked for 3 seconds after the doors are locked.

*: The door unlock settings can be changed. (→P. 113)

- ② Touch the lock sensor (the indentation on the upper part or lower part of the front door handle) to lock the doors.

Check that the door is securely locked.

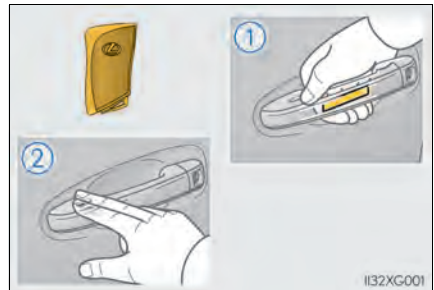

1132XG001

◆ Wireless remote control

- ① Locks all the doors

Check that the door is securely locked.

- ② Unlocks all the doors

Pressing the button unlocks the driver's door. Pressing the button again within 3 seconds unlocks the other doors.

Press and hold to open the windows and moon roof.*

*: These settings must be customized at your Lexus dealer.



1132XG002

■ Operation signals

Doors: A buzzer sounds and the emergency flashers flash to indicate that the doors have been locked/unlocked. (Locked: once; Unlocked: twice)

Windows and moon roof: A buzzer sounds to indicate that the windows and moon roof are operating.

■ Security feature

If a door or the glass hatch is not opened within approximately 60 seconds after the vehicle is unlocked, the security feature automatically locks the vehicle again.

■ When the door cannot be locked by the lock sensor on the upper part of the door handle

If the door will not lock even when the topside sensor area is touched, try touching both the topside and underside sensor areas at the same time.

When gloves are being worn, remove the gloves.

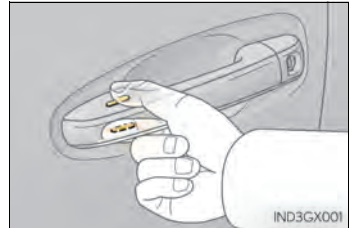

■ Door lock buzzer

If an attempt to lock the doors is made when a door and/or the glass hatch is not fully closed, a buzzer sounds continuously. Fully close the door and/or the glass hatch to stop the buzzer, and lock the vehicle once more.

■ Setting the alarm

Locking the doors will set the alarm system. (→P. 77)

■ If the smart access system with push-button start or the wireless remote control does not operate properly

- Use the mechanical key to lock and unlock the doors. (→P. 564)
- Replace the battery with a new one if it is depleted. (→P. 507)

Locking and unlocking the doors from the inside

◆ Door lock switches

- ① Locks all the doors
- ② Unlocks all the doors

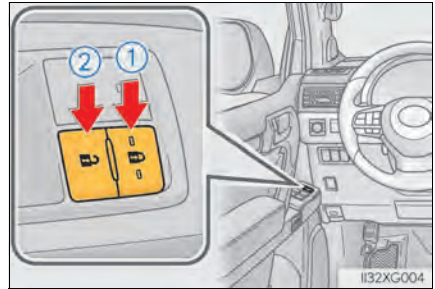

◆ Inside lock buttons

- ① Locks the door
- ② Unlocks the door

The front doors can be opened by pulling the inside handle even if the lock button is in the lock position.

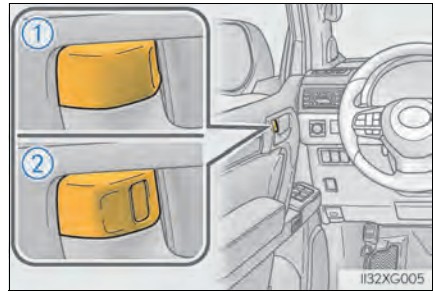

Locking the front doors from the outside without a key

- 1 Move the inside lock button to the lock position.
- 2 Close the door.

The door cannot be locked if the engine switch is in ACCESSORY or IGNITION ON mode, or the electronic key is left inside the vehicle. However, the key may not be detected correctly and the door may be locked.

Rear door child-protector lock

The door cannot be opened from inside the vehicle when the lock is set.

- 1 Unlock
- 2 Lock

These locks can be set to prevent children from opening the rear doors. Push down on each rear door switch to lock both rear doors.

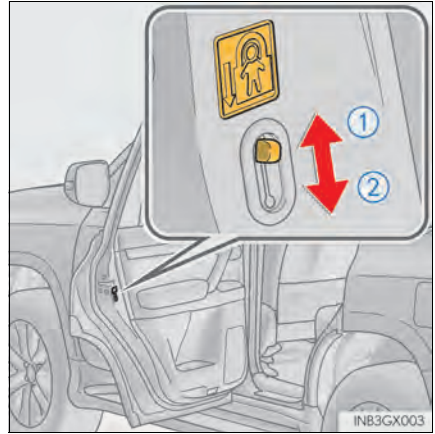

Automatic door locking and unlocking systems



The following functions can be set or canceled:

For instructions on customizing, refer to P. 600.



Function	Operation
Shift position linked door locking function	Shifting the shift lever out of P locks all the doors.
Shift position linked door unlocking function	Shifting the shift lever to P unlocks all the doors.
Speed linked door locking function	All the doors are locked when the vehicle speed is approximately 12 mph (20 km/h) or higher.
Driver's door linked door unlocking function	All the doors are unlocked when the driver's door is opened within 43 seconds after turning the engine switch off.

■ Changing the door unlock function setting

It is possible to set which doors the entry function unlocks using the wireless remote control.

- 1 Turn the engine switch off.
- 2 When the indicator light on the key surface is not on, press and hold  or  for approximately 5 seconds while pressing and holding .

The setting changes each time an operation is performed, as shown below. (When changing the setting continuously, release the buttons, wait for at least 5 seconds, and repeat step 2.)

Multi-information display	Unlocking function	Beep
	Holding the driver's door handle unlocks only the driver's door.	Exterior: Beeps 3 times Interior: Pings once
	Holding the front passenger's door handle unlocks all the doors.	
	Holding either front door handle unlocks all the doors.	Exterior: Beeps twice Interior: Pings once

To prevent unintended triggering of the alarm, unlock the doors using the wireless remote control and open and close a door once after the settings have been changed. (If a door or the glass hatch is not opened within 60 seconds after  is pressed, the doors will be locked again and the alarm will automatically be set.)
 In a case that the alarm is triggered, immediately stop the alarm. (→P. 77)

■ Impact detection door lock release system

In the event that the vehicle is subject to a strong impact, all the doors are unlocked. Depending on the force of the impact or the type of accident, however, the system may not operate.

■ Using the mechanical key

The doors can also be locked and unlocked with the mechanical key. (→P. 564)

■ If a symbol indicating one or more doors are open is shown on the multi-information display

The hood or one or more of the doors or glass hatch are not fully closed. The system also indicates which doors are not fully closed. If the vehicle reaches a speed of 3 mph (5 km/h), a buzzer sounds to indicate that the door(s) are not yet fully closed.

Make sure that the hood, all the doors and glass hatch are closed.

■ Conditions affecting the operation of the smart access system with push-button start or wireless remote control

→P. 128

■ Rear seat reminder function

● In order to remind you not to forget luggage, etc. in the rear seat, when the engine switch is turned off after any of the following conditions are met, a message will be displayed on the multi-information display for approximately 6 seconds.

- The engine is started within 10 minutes after opening and closing a rear door.
- A rear door has been opened and closed after the engine was started.

However, if a rear door is opened and then closed within approximately 2 seconds, the rear seat reminder function may not operate.

● The rear seat reminder function determines that luggage, etc. has been placed in a rear seat based on opening and closing of a rear door. Therefore, depending on the situation, the rear seat reminder function may not operate and you may still forget luggage, etc. in the rear seat, or it may operate unnecessarily.

● The rear seat reminder function can be enabled/disabled. (→P. 607)

■ Customization

Settings (e.g. unlocking function using a key) can be changed.

(Customizable features: →P. 600)

 **WARNING****■ To prevent an accident**

Observe the following precautions while driving the vehicle.

Failure to do so may result in a door opening and an occupant being thrown out of the vehicle, resulting in death or serious injury.

- Ensure that all doors are properly closed and locked.
- Do not pull the inside handle of the doors while driving.
Be especially careful for the front doors, as the doors may be opened even if the inside lock buttons are in locked position.
- Set the rear door child-protector locks when children are seated in the rear seats.

■ When using the wireless remote control and operating the power windows or moon roof

Operate the power window or moon roof after checking to make sure that there is no possibility of any passenger having any of their body parts caught in the window or moon roof. Also, do not allow children to operate the wireless remote control. It is possible for children and other passengers to get caught in the power window or moon roof.

Back door

The back door can be locked/unlocked and opened by the following procedures.

Locking and unlocking the back door from the outside

◆ Smart access system with push-button start

Carry the electronic key to enable this function.

- ① Locks all the doors
Check that the door is securely locked.
- ② Unlocks all the doors
The doors cannot be unlocked for 3 seconds after the doors are locked.

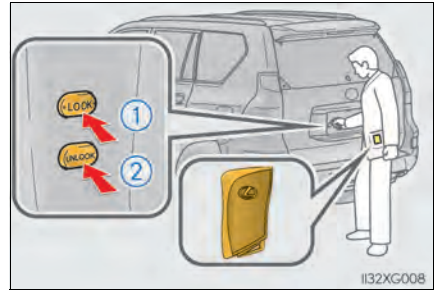

◆ Wireless remote control

→P. 108

Locking and unlocking the back door from the inside

◆ Door lock switch

→P. 110

Opening the back door from the outside

- ① Pull the handle
- ② Open the back door

The back door can be kept open at a desired position.

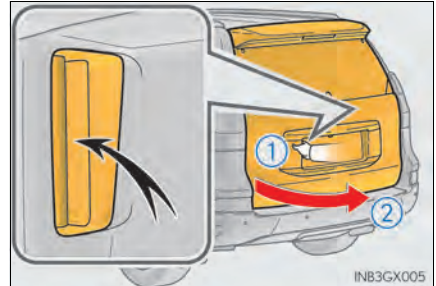

Keeping the back door open

- ① Unlocks the back door stopper
- ② Locks the back door stopper

The back door stopper can only be operated when the back door is fully open.

When closing the back door, check that the back door stopper is unlocked.

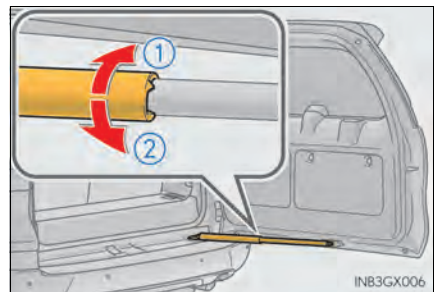

When closing the back door

Close the back door using the back door handle, and make sure to push the back door from the outside to close it.

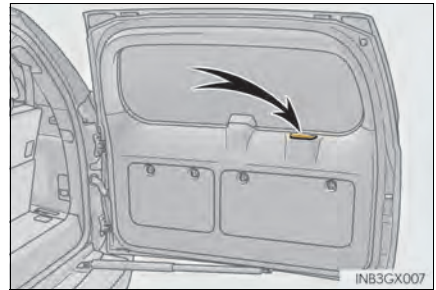

Rear step bumper

The rear step bumper is for rear end protection and easier step-up loading.

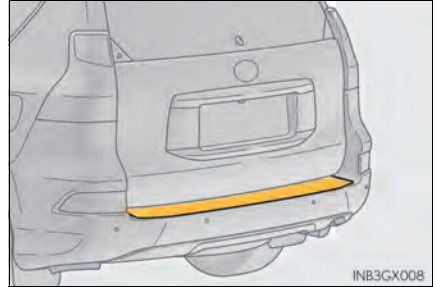

WARNING

■ While driving

- Keep the back door closed while driving. If the back door is left open, it may hit near-by objects while driving or luggage may be unexpectedly thrown out, causing an accident. In addition, exhaust gases may enter the vehicle, causing death or a serious health hazard. Make sure to close the back door before driving.
- Before driving the vehicle, make sure that the back door is fully closed. If the back door is not fully closed, it may open unexpectedly while driving, causing an accident.
- Never let anyone sit in the luggage compartment. In the event of sudden braking, sudden swerving or a collision, they are susceptible to death or serious injury.

■ When children are in the vehicle

Observe the following precautions.
Failure to do so may result in death or serious injury.

- Do not allow children to play in the luggage compartment. If a child is accidentally locked in the luggage compartment, they could have heat exhaustion or other injuries.
- Do not allow a child to open or close the back door. Doing so may cause the back door to move unexpectedly, or cause the child's hands, head, or neck to be caught by the closing back door.

⚠ WARNING

■ Operating the back door

Observe the following precautions.

Failure to do so may cause parts of the body to be caught, resulting in death or serious injury.

- When opening or closing the back door, thoroughly check to make sure the surrounding area is safe.
- If anyone is in the vicinity, make sure they are safe and let them know that the back door is about to open or close.
- Use caution when opening or closing the back door in windy weather as it may move abruptly in strong wind.
- The back door may suddenly shut if the back door stopper is not locked. It is more difficult to open or close the back door on an incline than on a level surface, so beware of the back door unexpectedly opening or closing by itself. Make sure that the back door stopper is locked and secure before using the luggage compartment.
- Even with the back door stopper locked, the back door stopper may unlock and the back door may close when excessive force such as a strong wind is applied to the back door. Take extra care to prevent any part of your body from being caught.
- When closing the back door, take extra care to prevent your fingers etc. from being caught. Also pay attention to your personal belongings such as bags and ties.
- When closing the back door, make sure to press it lightly on its outer surface. If the back door handle is used to fully close the back door, it may result in hands or arms being caught.



⚠ WARNING

- Do not pull on the back door damper stay to close the back door, and do not hang on the back door damper stay.
Doing so may cause hands to be caught or the back door damper stay to break, causing an accident.
- If a bicycle carrier or similar heavy object is attached to the back door, it may suddenly shut again after being opened, causing someone's hands, head or neck to be caught and injured. When installing an accessory part to the back door, using a genuine Lexus part is recommended.

⚠ NOTICE**■ Back door damper stay**

The back door is equipped with damper stay that hold the back door in place.

Observe the following precautions.

Failure to do so may cause damage to the back door damper stay, resulting in malfunction.

- Do not attach any accessories other than genuine Lexus parts to the back door.
- Do not lean against, climb on or place luggage on the damper stay, or apply lateral forces to it.

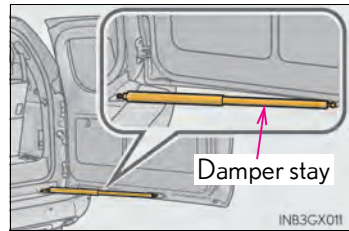

Glass hatch

The glass hatch can be opened using the glass hatch opener or wireless remote control.

Opening the glass hatch

◆ Glass hatch opener

- ① Press the button to pop up the glass hatch.
- ② Raise
The glass hatch cannot be opened when the back door is locked. Unlock the back door to open the glass hatch. (→P. 116)

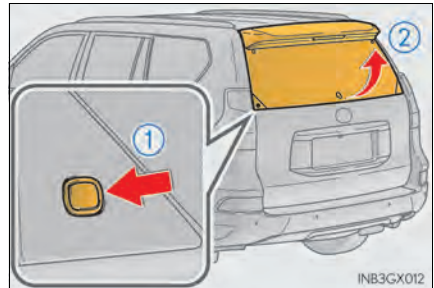

◆ Smart access system with push-button start

- ① While carrying the electronic key, press the button to pop up the glass hatch.
- ② Raise
The glass hatch can be opened even when the back door is locked.

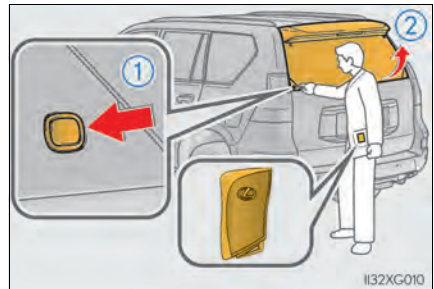

◆ Wireless remote control

Press and hold the button to open the glass hatch. The glass hatch will pop up.



■ When opening the glass hatch

- Open the glass hatch slowly and carefully.
- Use the glass hatch opener or wireless remote control when the back door is closed.

■ Operation signals (when opening with the wireless remote control)

A buzzer sounds once to indicate that the glass hatch have been opened.

■ Opening the glass hatch while the rear window wiper is in operation

Rear window wiper operation will stop moving. Operation will recommence after the glass hatch has been closed.

■ Function to prevent the glass hatch being locked with the electronic key inside

- When all doors are being locked, closing the glass hatch with the electronic key left inside the luggage compartment will sound an alarm.
In this case, the glass hatch can be opened using the entry function.
- Even when the spare electronic key is put in the luggage compartment with all the doors locked, the key confinement prevention function can be activated so the glass hatch can be opened. In order to prevent theft, take all electronic keys with you when leaving the vehicle.
- Even when the electronic key is put in the luggage compartment with all the doors are locked, the key may not be detected depending on the places and the surrounding radio wave conditions. In this case, the key confinement prevention function cannot be activated, causing the doors to lock when the glass hatch is closed. Make sure to check where the key is before closing the glass hatch.
- If you want to lock the spare electronic key in the vehicle, do not open or close the glass hatch after locking all doors. Otherwise, the glass hatch can be opened due to the key confinement prevention function and the risk of vehicle theft increases significantly.

■ After closing the glass hatch

Check that the glass hatch is firmly locked. If it is not firmly locked, the rear window wiper and washer will not operate correctly.

■ Customization

The glass hatch opening operation can be changed. (Customizable features: →P. 600)

**WARNING****■ While driving**

- Keep the glass hatch closed while driving.

If the glass hatch is left open, it may hit near-by objects while driving or luggage may be unexpectedly thrown out, causing an accident.

In addition, exhaust gases may enter the vehicle, causing death or a serious health hazard. Make sure to close the glass hatch before driving.

- Before driving the vehicle, make sure that the glass hatch is fully closed. If the glass hatch is not fully closed, it may open unexpectedly while driving, causing an accident.

■ When children are in the vehicle

Do not allow a child to open or close the glass hatch.

Doing so may cause the glass hatch to move unexpectedly, or cause the child's hands, head, or neck to be caught by the closing glass hatch.

⚠ WARNING

■ Operating the glass hatch

Observe the following precautions.

Failure to do so may cause parts of the body to be caught, resulting in death or serious injury.

- Remove any heavy loads, such as snow and ice, from the glass hatch before opening it. Failure to do so may cause the glass hatch suddenly shut again after it is opened.
- When opening or closing the glass hatch, thoroughly check to make sure the surrounding area is safe.
- If anyone is in the vicinity, make sure they are safe and let them know that the glass hatch is about to open or close.
- Use caution when opening or closing the glass hatch in windy weather as it may move abruptly in strong wind.

- The glass hatch may close if it is not opened fully. It is more difficult to open or close the glass hatch on an incline than on a level surface, so beware of the glass hatch unexpectedly opening or closing by itself. Make sure that the glass hatch is fully open and secure before using the luggage compartment. Also pay attention to your personal belongings such as bags and ties.



- When closing the glass hatch, take extra care to prevent your fingers etc. from being caught. Also pay attention to your personal belongings such as bags and ties.
- When closing the glass hatch, make sure to press it lightly on its outer surface.



- Do not pull on the glass hatch damper stay to close the glass hatch, and do not hang on the glass hatch damper stay. Doing so may cause hands to be caught or the glass hatch damper stay to break, causing an accident.
- Do not attach any accessories other than genuine Lexus parts to the glass hatch. Such additional weight on the glass hatch may cause the glass hatch to suddenly shut again after it is opened.

 NOTICE**■ Glass hatch damper stays**

The glass hatch is equipped with damper stays that hold the glass hatch in place. Observe the following precautions.

Failure to do so may cause damage to the glass hatch damper stay, resulting in malfunction.

- Do not attach any foreign objects, such as stickers, plastic sheets, or adhesives to the damper stay rod.
- Do not touch the damper stay rod with gloves or other fabric items.
- Do not attach any accessories other than genuine Lexus parts to the glass hatch.
- Do not place your hand or foot on the damper stay or apply lateral forces to it.

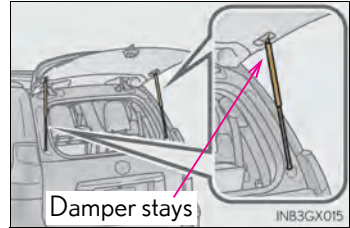

Smart access system with push-button start

The following operations can be performed simply by carrying the electronic key on your person, for example in your pocket. The driver should always carry the electronic key.

- Locks and unlocks the side doors (→P. 108)
- Locks and unlocks the back door (→P. 116)
- Opens the glass hatch (→P. 121)
- Starts the engine (→P. 200)

■ Antenna location

- ① Antennas outside the cabin
- ② Antennas inside the cabin
- ③ Antenna outside the luggage compartment

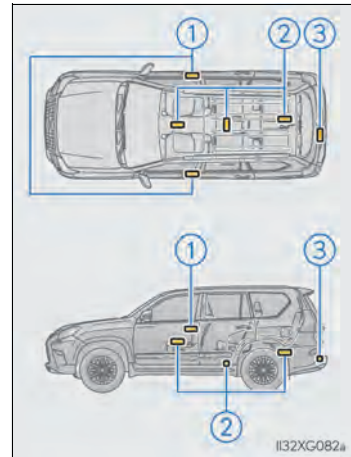

■ Effective range (areas within which the electronic key is detected)

● When locking or unlocking the doors

The system can be operated when the electronic key is within about 2.3 ft. (0.7 m) of either of the outside front door handle. (Only the doors detecting the key can be operated.)

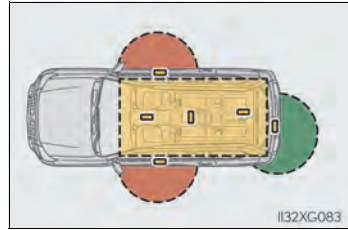

● When opening the glass hatch and locking or unlocking the back door

The system can be operated when the electronic key is within about 2.3 ft. (0.7 m) of the back door handle.

● When starting the engine or changing engine switch modes

The system can be operated when the electronic key is inside the vehicle.

■ Alarms and warning indicators

A combination of exterior and interior alarms as well as warning messages shown on the multi-information display are used to prevent theft of the vehicle and accidents resulting from erroneous operation. Take appropriate measures in response to any warning message on the multi-information display.

Alarm	Situation	Correction procedure
Exterior alarm sounds once for 5 seconds	An attempt was made to lock the vehicle while a door and/or the glass hatch was open.	Close all of the doors and/or the glass hatch, and lock the doors again.
	An attempt was made to close the glass hatch while the electronic key was still inside the vehicle.	Open the glass hatch again and retrieve the electronic key from the vehicle.
Interior alarm pings continuously	The engine switch was turned to ACCESSORY mode while the driver's door was open (or the driver's door was opened while the engine switch was in ACCESSORY mode).	Turn the engine switch off and close the driver's door.



■ Battery-saving function

The battery-saving function will be activated in order to prevent the electronic key battery and the vehicle battery from being discharged while the vehicle is not in operation for a long time.

- In the following situations, the smart access system with push-button start may take some time to unlock the doors.
 - The electronic key has been left in an area of approximately 6 ft. (2 m) of the outside of the vehicle for 10 minutes or longer.
 - The smart access system with push-button start has not been used for 5 days or longer.
- If the smart access system with push-button start has not been used for 14 days or longer, the doors cannot be unlocked at any doors except the driver's door. In this case, take hold of the driver's door handle, or use the wireless remote control or the mechanical key, to unlock the doors.

■ Electronic Key Battery-Saving Function

- When battery-saving mode is set, battery depletion is minimized by stopping the electronic key from receiving radio waves.

Press  twice while pressing and holding . Confirm that the electronic key indicator flashes 4 times.

While the battery-saving mode is set, the smart access system with push-button start cannot be used. To cancel the function, press any of the electronic key buttons.



- Electronic keys that will not be used for long periods of time can be set to the battery-saving mode in advance.

■ Conditions affecting operation

The smart access system with push-button start uses weak radio waves. In the following situations, the communication between the electronic key and the vehicle may be affected, preventing the smart access system with push-button start, wireless remote control and engine immobilizer system from operating properly.
(Ways of coping: →P. 564)

- When the electronic key battery is depleted
- Near a TV tower, electric power plant, gas station, radio station, large display, airport or other facility that generates strong radio waves or electrical noise
- When the electronic key is in contact with, or is covered by the following metallic objects
 - Cards to which aluminum foil is attached
 - Cigarette boxes that have aluminum foil inside
 - Metallic wallets or bags
 - Coins
 - Hand warmers made of metal
 - Media such as CDs and DVDs
- When other wireless keys (that emit radio waves) are being used nearby

- When carrying the electronic key together with the following devices that emit radio waves
 - Portable radio, cellular phone, cordless phone or other wireless communication devices
 - Another vehicle's electronic key or a wireless key that emits radio waves
 - Personal computers or personal digital assistants (PDAs)
 - Digital audio players
 - Portable game systems
- If window tint with a metallic content or metallic objects are attached to the rear window
- When the electronic key is placed near a battery charger or electronic devices
- When the vehicle is parked in a pay parking spot where radio waves are emitted
- **Note for the entry function**
 - Even when the electronic key is within the effective range (detection areas), the system may not operate properly in the following cases:
 - The electronic key is too close to the window or outside door handle, near the ground, or in a high place when the doors are locked or unlocked.
 - The electronic key is on the instrument panel, luggage cover or floor, or in the door pockets or glove box when the engine is started or engine switch modes are changed.
 - Do not leave the electronic key on top of the instrument panel or near the door pockets when exiting the vehicle. Depending on the radio wave reception conditions, it may be detected by the antenna outside the cabin and the doors will become lockable from the outside, possibly trapping the electronic key inside the vehicle.
 - As long as the electronic key is within the effective range, the doors may be locked or unlocked by anyone. However, only the doors detecting the electronic key can be used to unlock the vehicle.
 - Even if the electronic key is not inside the vehicle, it may be possible to start the engine if the electronic key is near the window.
 - The doors may lock or unlock if a large amount of water splashes on the door handle, such as in the rain or in a car wash, when the electronic key is within the effective range. (The doors will automatically be locked after approximately 60 seconds if the doors or the glass hatch are not opened and closed.)
 - If the wireless remote control is used to lock the doors when the electronic key is near the vehicle, there is a possibility that the door may not be unlocked by the entry function. (Use the wireless remote control to unlock the doors.)
 - Touching the door lock sensor while wearing gloves may prevent lock operation.
 - When the lock operation is performed using the lock sensor, recognition signals will be shown up to two consecutive times. After this, no recognition signals will be given.
 - If the door handle becomes wet while the electronic key is within the effective range, the door may lock and unlock repeatedly. In this case, follow the following correction procedures to wash the vehicle.
 - Place the electronic key in a location 6 ft. (2 m) or more away from the vehicle. (Take care to ensure that the key is not stolen.)
 - Set electronic key to battery-saving mode to disable the smart access system with push-button start. (→P. 128)

- If the electronic key is inside the vehicle and a door handle becomes wet during a car wash, a buzzer may sound outside the vehicle and “KEY DETECTED IN VEHICLE”/ “Key detected in vehicle” may be shown on the multi-information display. To turn off the alarm, lock all the doors.
- The lock sensor may not work properly if it comes into contact with ice, snow, mud, etc. Clean the lock sensor and attempt to operate it again, or use the lock sensor on the lower part of the door handle.
- A sudden approach to the effective range of door handle may prevent the doors from being unlocked. In this case, return the door handle to the original position and check that the doors unlock before pulling the door handle again.
- Unlocking the vehicle may take more time if another electronic key is within the effective range.

*: This setting can be customized at your Lexus dealer.

■ When the vehicle is not driven for extended periods

- To prevent theft of the vehicle, do not leave the electronic key within 6 ft. (2 m) of the vehicle.
- The smart access system with push-button start can be deactivated in advance. (→P. 600)
- Setting the electronic key to battery-saving mode helps to reduce key battery depletion. (→P. 128)

■ To operate the system properly

Make sure to carry the electronic key when operating the system. Do not get the electronic key too close to the vehicle when operating the system from the outside of the vehicle.

Depending on the position and holding condition of the electronic key, the key may not be detected correctly and the system may not operate properly. (The alarm may go off accidentally, or the door lock prevention function may not operate.)

■ If the smart access system with push-button start does not operate properly

- If the doors cannot be locked or unlocked, perform the following.
 - Bring the electronic key close to the door handle and perform a lock or unlock operation.
 - Use the wireless remote control.
 If the doors cannot be locked or unlocked by perform the above, use the mechanical key. (→P. 564)
- If the engine cannot be started, refer to P. 565

■ Customization

Settings (e. g. smart access system with push-button start) can be changed. (Customizable features: →P. 600)

■ If the smart access system with push-button start has been deactivated in a customized setting

- Locking and unlocking the doors:
Use the wireless remote control or mechanical key. (→P. 108, 564)
- Starting the engine and changing engine switch modes: →P. 565
- Stopping the engine: →P. 201

 **WARNING****■ Caution regarding interference with electronic devices**

- People with implantable cardiac pacemakers, cardiac resynchronization therapy-pacemakers or implantable cardioverter defibrillators should keep away from the smart access system antennas. (→P. 126)

The radio waves may affect the operation of such devices. If necessary, the entry function can be disabled. Ask your Lexus dealer for details, such as the frequency of radio waves and timing of the emitted radio waves. Then, consult your doctor to see if you should disable the entry function.

- Users of any electrical medical device other than implantable cardiac pacemakers, cardiac resynchronization therapy-pacemakers or implantable cardioverter defibrillators should consult the manufacturer of the device for information about its operation under the influence of radio waves.

Radio waves could have unexpected effects on the operation of such medical devices.

Ask your Lexus dealer for details on disabling the entry function.

Front seats

Adjustment procedure

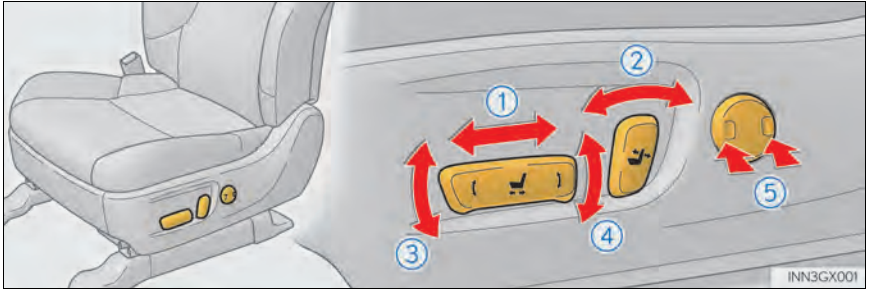

- ① Seat position adjustment switch
- ② Seatback angle adjustment switch
- ③ Seat cushion (front) angle adjustment switch
- ④ Vertical height adjustment switch
- ⑤ Lumber support adjustment switch

Active head restraints

When the occupant's lower back presses against the seatback during a rear-end collision, the head restraint moves slightly forward and upward to help reduce the risk of whiplash on the seat occupant.

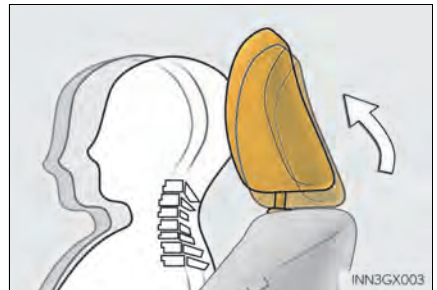

■ Power easy access system

The driver's seat and steering wheel move in accordance with engine switch mode and the driver's seat belt condition. (→P. 145)

■ Active head restraints

Even small forces applied to the seatback may cause the head restraint to move. Pushing up a locked head restraint forcibly may appear the head restraint inner structure. These do not indicate problems.

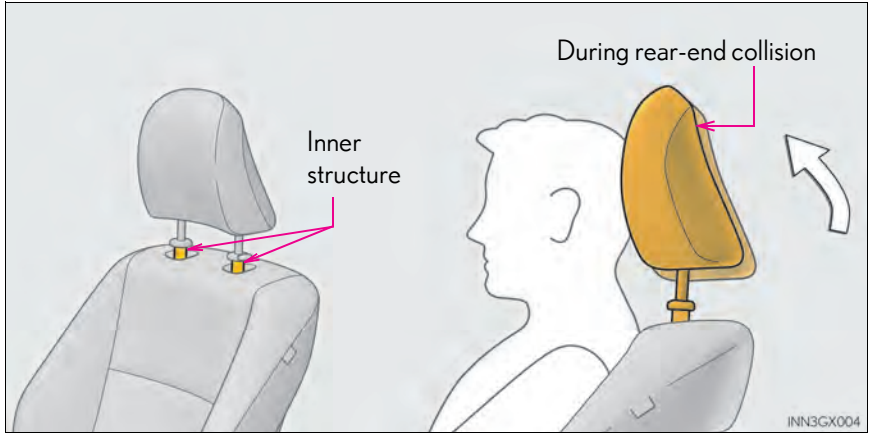

⚠ WARNING

■ When adjusting the seat position

- Take care when adjusting the seat position to ensure that other passengers are not injured by the moving seat.
- Do not put your hands under the seat or near the moving parts to avoid injury. Fingers or hands may become jammed in the seat mechanism.

■ Seat adjustment

To reduce the risk of sliding under the lap belt during a collision, do not recline the seat more than necessary.

If the seat is too reclined, the lap belt may slide past the hips and apply restraint forces directly to the abdomen, or your neck may contact the shoulder belt, increasing the risk of death or serious injury in the event of an accident.

Adjustments should not be made while driving as the seat may unexpectedly move and cause the driver to lose control of the vehicle.

Rear seats

Adjustment procedure

■ Second seats

- ① Seatback angle adjustment lever
- ② Seat position adjustment lever



■ Third seats (power seat)

Seatback angle adjustment switch

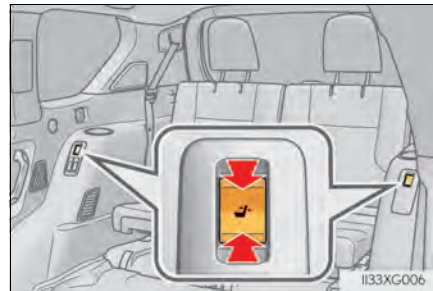

Moving a second seat for third seat access (right side only for 7-passenger models, both side for 6-passenger models)

■ Getting in the vehicle

Pull the seatback angle adjustment lever and fold down the seatback. The seat will slide forward.

Move the seat to the front-most position



■ Getting out of the vehicle

Pull the release lever and fold down the seatback. The seat will slide forward.

Move the seat to the front-most position

Make sure that no passenger is seated on the second seat before pulling the release lever.



■ After passengers have entered/exited the vehicle

Lift up the seatback and slide the seat backward until it locks.

Folding down the second seatbacks

■ Before folding down the second seatbacks

Lower the head restraints to the lowest position.

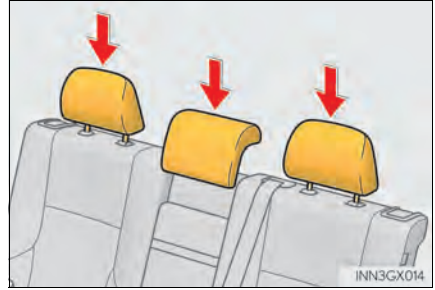

■ Folding down second seatbacks

Pull the seatback lock release lever and fold them down.

To return the second seatbacks to their original positions, lift them up until they lock.

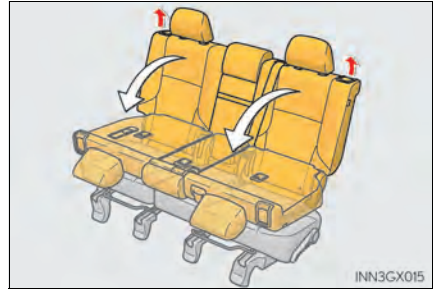

■ Folding down second center seatback only (for 7-passenger models)

Pull the center seatback lock release lever behind the seatback and fold it down.

To return the center seatback to its original position, lift it up until it locks.

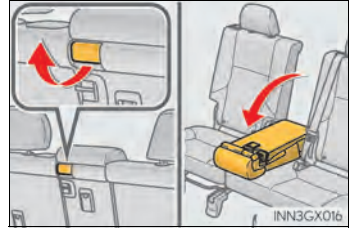
**■ If you cannot raise the second seatback**

Release the seat belt lock by:

- ① Pushing on the lower front edge of the seatback to slacken the seat belt.
- ② Let the seat belt retract a little.

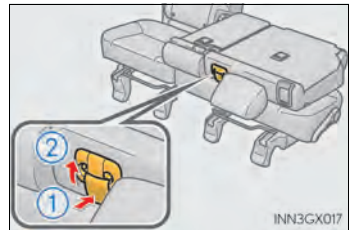

Folding down the third seats (manual seat)

■ Before folding down the third seats

Use the seat belt hanger to prevent the belt from being tangled.

Make sure that the seat belts are removed from the hangers before using them.

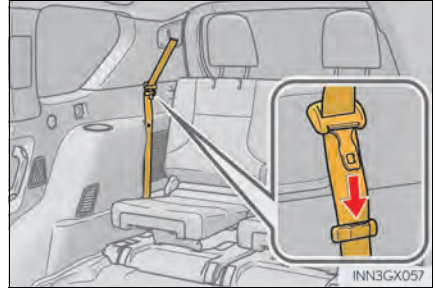

■ Folding down the third seats

► From rear door side

- 1 Pull the strap to fold the head restraint.

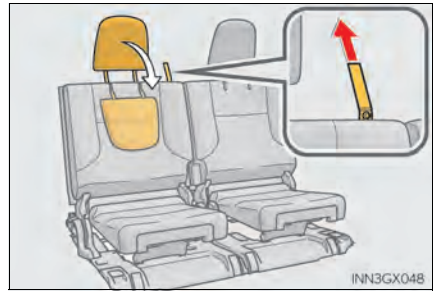

- 2 Pull the seat cushion lock release lever.

The seat cushion is stowed automatically.

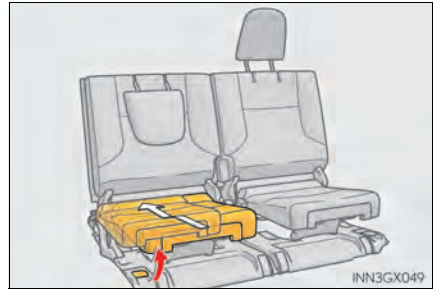

- 3 Pull the seatback lock release lever and fold the seatback down.

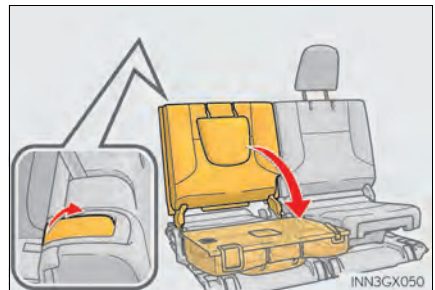

► From back door side

- 1 Pull the strap to fold the head restraint.

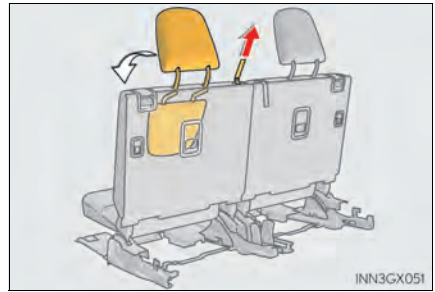

- 2 Pull the seat cushion/seatback lock release lever. The seat cushion is stowed automatically.

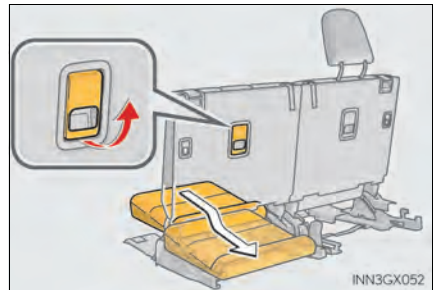

- 3 Fold the seatback down.

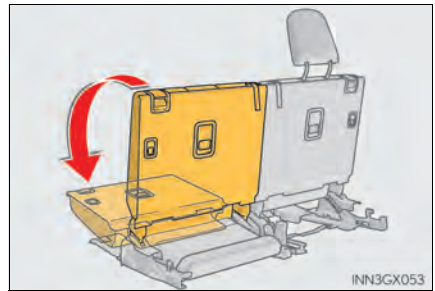

■ Returning the third seats

- 1 From rear door side, unlock the seatbacks by pulling the lock release lever, and lift them up until they lock.

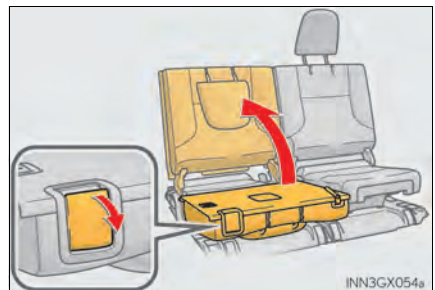

- 2 Pull the grip and carry the seat cushion out.

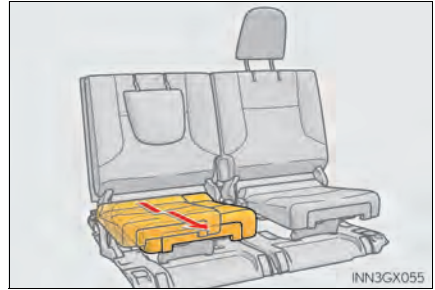

- 3 Lift the head restraint up until it locks.

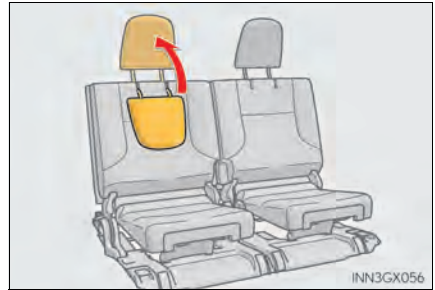

Folding down the third seats (power seat)

- 1 Right seat return switch
- 2 Right seat fold switch
- 3 Left seat return switch
- 4 Left seat fold switch

The switches can be operated from both the rear door side and the back door side.

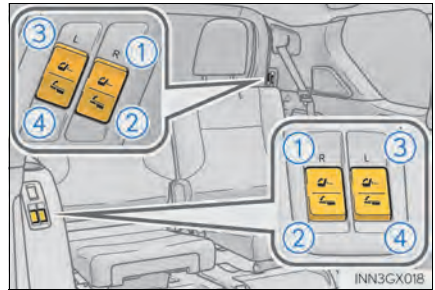

■ Before folding down the third seats

Use the seat belt hangers to prevent the belts from being tangled.

Make sure that the seat belts are removed from the hangers before using them.

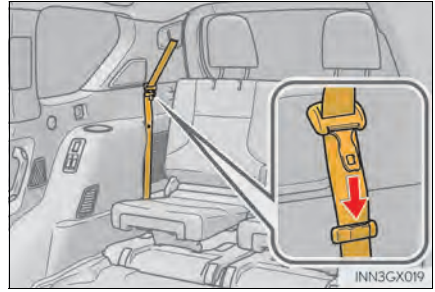

■ Folding down the third seats

- 1** Press and hold . Two beeps sound and the seatback will rise.

When operating is completed, two beeps sound again.



- 2** Press and hold  again. Two beeps sound, the head restraints will fold forward, and the seat will be stowed.

When operating is completed, two beeps sound again.

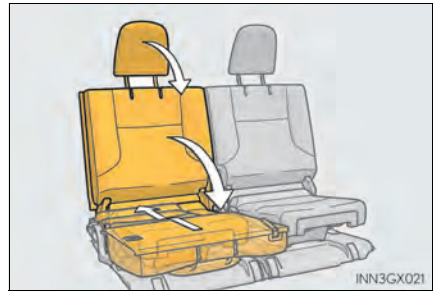

■ Returning the third seats

- 1 Press and hold .

Two beeps sound and seatback and seat cushion begin to move. When operating is completed, two beeps sound again.

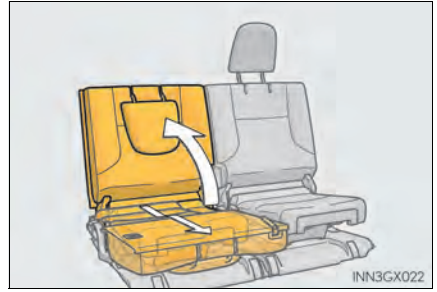

- 2 Lift the head restraints up until they lock.

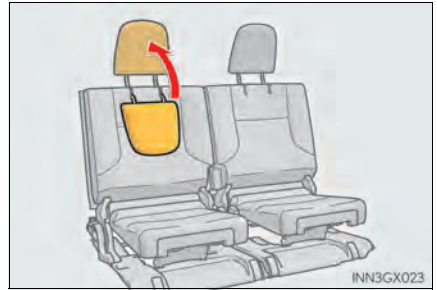

■ The third power seats can be operated when

- The engine switch is off.
- The shift lever is in P position with the engine switch in IGNITION ON mode.

■ During third power seat stowing operation

Do not remove your hand from the switch until the operation stops automatically. If you remove your hand from the switch, the operation will stop and the buzzer will sound continuously. The seat cannot be used in this state. The buzzer will stop when the switch is pressed again.

■ Enlarging the luggage compartment

The third seat can be used for sitting when it is in the position shown in step **2** of the folding down the third seats. (→P. 138, 140)

This can be convenient for enlarging the luggage compartment, for instance when the luggage is against the back of the seatback.

■ If the warning buzzer sounds continuously

If there is an abnormality in the system, the warning buzzer will sound continuously while the engine switch is in IGNITION ON mode. In this case, take the following operations:

1 Press and hold  to return the seat.

2 Press and hold  to stow the seat.

For each step, wait until the seat movement stops automatically and the two beeps sound twice before removing your hand from the switch.

If the warning buzzer does not stop even after performing the above procedure correctly, perform the following operations:

3 Press and hold  on the rear door side.

4 While holding , press forward on  5 times within 10 seconds and keep

holding  until 3 beeps sound. The beep will then sound continuously again.

5 Repeat step **1** and **2**.

 **WARNING****■ When folding the seatbacks down**

Observe the following precautions. Failure to do so may result in death or serious injury.

- Do not fold the seatbacks down while driving.
- Stop the vehicle on level ground, set the parking brake and shift the shift lever to P.
- Do not allow anyone to sit on a folded seatback or in the luggage compartment while driving.
- Do not allow children to enter the luggage compartment.

■ Seat adjustment

Observe the following precautions. Failure to do so may result in death or serious injury.

- To reduce the risk of sliding under the lap belt during a collision, do not recline the seat more than necessary.
If the seat is too reclined, the lap belt may slide past the hips and apply restraint forces directly to the abdomen, or your neck may contact the shoulder belt, increasing the risk of death or serious injury in the event of an accident.
Adjustments should not be made while driving as the seat may unexpectedly move and cause the driver to lose control of the vehicle.
- Be careful not to get hands or feet pinched between the rear console box and the second seat when folding down the rear seatback.

■ When stowing the third seats

Observe the following precautions. Failure to do so may result in death or serious injury.

- Check that there is no luggage and that there are no other people around the seat before stowing operation.
- Do not insert hands or feet into the moving parts of the seat.
- Do not allow children to operate the seat.

■ After returning the seatbacks to the upright position

Observe the following precautions. Failure to do so may result in death or serious injury.

- Make sure the seatback is securely locked by pushing it forward and rearward on the top.
- Check that the seat belts are not twisted or caught in the seatback.

 **NOTICE****■ When returning the third seat (vehicles with luggage cover)**

If the luggage cover is installed in the luggage compartment, make sure you remove it before returning the third seat. (→P. 433) The luggage cover may be damaged by the seat.

Driving position memory

This feature automatically adjusts the driver's seats, steering wheel and outside rear view mirrors to make entering and exiting the vehicle easier or to suit your preferences.

Power easy access system

The seat and steering wheel are automatically adjusted to allow the driver to enter and exit the vehicle easily.

When all of the following have been performed, the driver's seat and steering wheel are automatically adjusted to a position that allows driver to enter and exit the vehicle easily.

- The shift lever has been shifted to P.
- The engine switch has been turned off.
- The driver's seat belt has been unfastened.

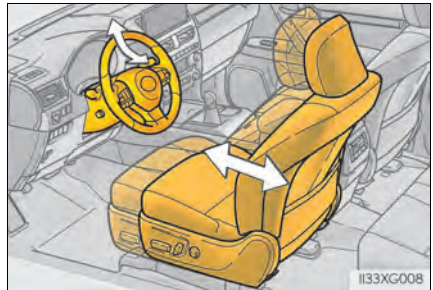

When any of the following has been performed, the driver's seat and steering wheel automatically return to their original positions.

- The engine switch has been turned to ACCESSORY mode or IGNITION ON mode.
- The driver's seat belt has been fastened.

■ Operation of the power easy access system

When exiting the vehicle, the power easy access system may not operate if the seat is already close to the rearmost position, etc.

■ Customization

The seat movement amount settings of the power easy access system can be customized. (Customizable features: →P. 600)

Driving position memory

Your preferred driving position (the position of the driver's seat, steering wheel and outside rear view mirrors) can be recorded and recalled by pressing a button.

Two different driving positions can be recorded into memory.

■ Recording procedure

- 1 Check that the shift lever is in P.
- 2 Turn the engine switch to IGNITION ON mode.
- 3 Adjust the driver's seat, steering wheel, and outside rear view mirrors to the desired positions.
- 4 While pressing the "SET" button, or within 3 seconds after the "SET" button is pressed, press button "1" or "2" until the buzzer sounds.

If the selected button has already been preset, the previously recorded position will be overwritten.

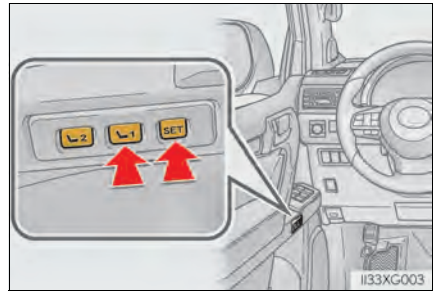

■ Recall procedure

- 1 Check that the shift lever is in P.
- 2 Turn the engine switch to IGNITION ON mode.
- 3 Press one of the buttons for the driving position you want to recall until the buzzer sounds.

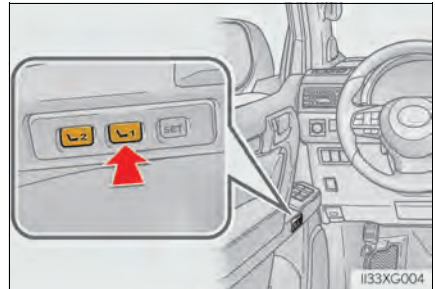

■ To stop the position recall operation part-way through

Perform any of the following:

- Press the "SET" button.
- Press button "1" or "2".
- Operate any of the seat adjustment switches (only cancels seat position recall).
- Operate the tilt and telescopic steering control switch (only cancels steering wheel position recall).

■ Seat positions that can be memorized (→ P. 132)

The adjusted positions other than the position adjusted by lumbar support switch can be recorded.

■ Operating the driving position memory after turning the engine switch off

Recorded seat positions can be activated up to 180 seconds after the driver's door is opened and another 60 seconds after it is closed again.

■ In order to correctly use the driving position memory function

If a seat position is already in the furthest possible position and the seat is operated in the same direction, the recorded position may be slightly different when it is recalled.

Memory recall function

Each electronic key can be registered to recall your preferred driving position.

■ Registering procedure

Record your driving position to button "1" or "2" before performing the following:

Carry only the key you want to register, and then close the driver's door.

If 2 or more keys are in the vehicle, the driving position cannot be recorded properly.

- 1 Check that the shift lever is in P.
- 2 Turn the engine switch to IGNITION ON mode.
- 3 Recall the driving position that you want to record.
- 4 While pressing the recalled button, press and hold the door lock switch (either lock or unlock) until the buzzer sounds.

If the button could not be registered, the buzzer sounds continuously for approximately 3 seconds.

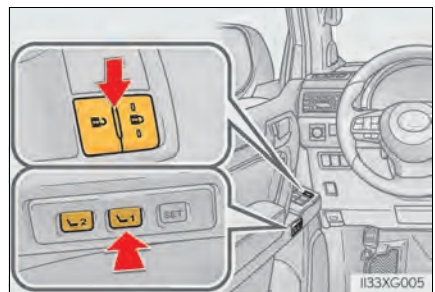

■ Recall procedure

- 1 Make sure that the doors are locked before recalling the driving position. Carry the electronic key that has been registered to the driving position, and then unlock and open the driver's door using the smart access system with push-button start or wireless remote control.

The driving position will move to the recorded position (not including the steering wheel). However, the seat will move to a position slightly behind the recorded position in order to make entering the vehicle easier.

If the driving position is in a position that has already been recorded, the seat and outside rear view mirrors will not move.

- 2 Turn the engine switch to ACCESSORY mode or IGNITION ON mode, or fasten a seat belt.

The seat and steering wheel will move to the recorded position.

■ Cancellation procedure

Carry only the key you want to cancel and then close the driver's door.

If 2 or more keys are in the vehicle, the driving position cannot be canceled properly.

- 1 Turn the engine switch to IGNITION ON mode.
- 2 While pressing the "SET" button, press and hold the door lock switch (either lock or unlock) until the buzzer sounds twice.

If the button could not be canceled, the buzzer sounds continuously for approximately 3 seconds.

■ Recalling the driving position using the memory recall function

- Different driving positions can be registered for each electronic key. Therefore, the driving position that is recalled may be different depending on the key being carried.
- If a door other than the driver's door is unlocked with the smart access system with push-button start, the driving position cannot be recalled. In this case, press the driving position button which has been set.

■ Customization

The unlock door settings of the memory recall function can be customized.
(Customizable features: →P. 600)

**WARNING****■ Seat adjustment caution**

Take care during seat adjustment so that the seat does not strike the rear passenger or squeeze your body against the steering wheel.

Head restraints

Head restraints are provided for all seats.

Front and second seats

Vertical adjustment

- ① Up
Pull the head restraints up.
- ② Down
Push the head restraint down while pressing the lock release button.

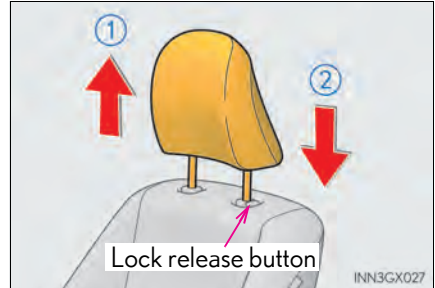

Front seats only: Angle adjustment (if equipped)

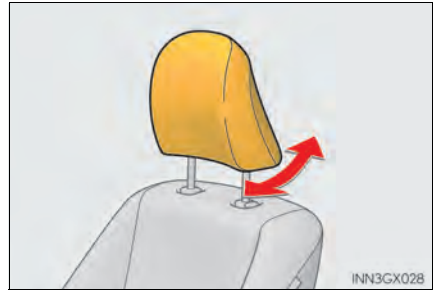

Third seats (manual seat)

To fold the head restraints, pull the lock release strap.

To return the head restraints, lift them up until they lock.

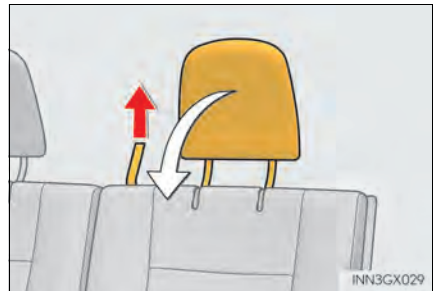

■ Removing the head restraints

▶ Front and second seats

Pull the head restraint up while pressing the lock release button.

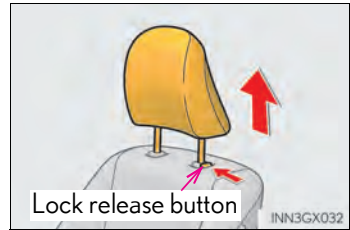

▶ Third seats

The head restraint cannot be removed.

■ Installing the head restraints (front and second seats)

Align the head restraint with the installation holes and push it down to the lock position.

Press and hold lock release button when lowering the head restraint.

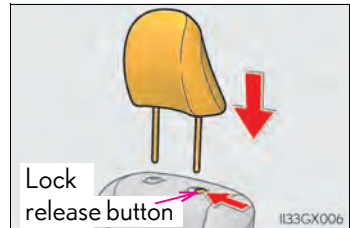

■ Adjusting the height of the head restraints (front and second seats)

Make sure that the head restraints are adjusted so that the center of the head restraint is closest to the top of your ears.

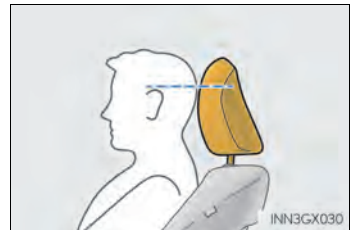

■ Using the second center seat head restraint (for 7-passenger models)

Always raise the head restraint one level from the stowed position when using.



■ Using the third seats

Always lift the head restraints up until they lock when using.

**WARNING****■ Head restraint precautions**

Observe the following precautions regarding the head restraints. Failure to do so may result in death or serious injury.

- Use the head restraints designed for each respective seat.
- Adjust the head restraints to the correct position at all times.
- After adjusting the head restraints, push down on them and make sure they are locked in position.
- Do not drive with the head restraints removed.

Steering wheel

Adjustment procedure

- ① Up
- ② Down
- ③ Toward the driver
- ④ Away from the driver

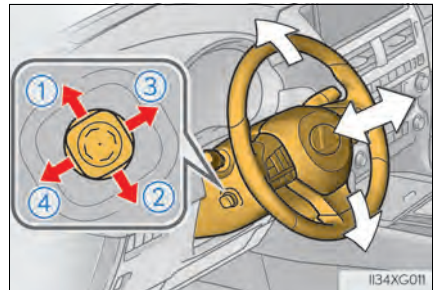

Horn

To sound the horn, press on or close to the  mark.

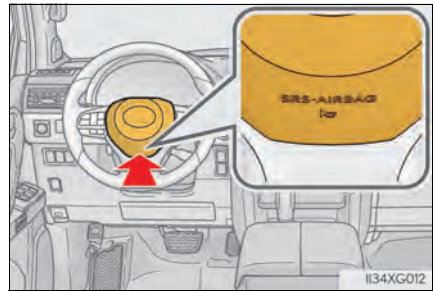

■ The steering wheel can be adjusted when

The engine switch is in ACCESSORY or IGNITION ON mode*.

*: If the driver's seat belt is fastened, the steering wheel can be adjusted regardless of engine switch mode.

■ Automatic adjustment of the steering position

A desired steering position can be entered to memory and recalled automatically by the driving position memory system. (→P. 146)

■ Power easy access system

The steering wheel and driver's seat move in accordance with engine switch mode and the driver's seat belt condition. (→P. 145)

**WARNING**

Do not adjust the steering wheel while driving.

Doing so may cause the driver to mishandle the vehicle and cause an accident, resulting in death or serious injury.

Inside rear view mirror

The rear view mirror's position can be adjusted to enable sufficient confirmation of the rear view.

Adjusting the height of rear view mirror

The height of the rear view mirror can be adjusted to suit your driving posture.

Adjust the height of the rear view mirror by moving it up and down.

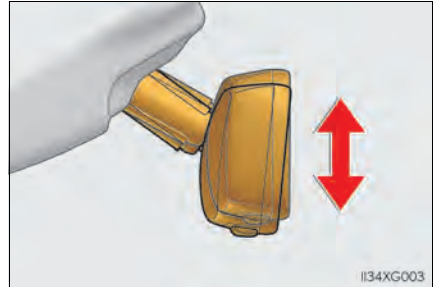

Anti-glare function

Responding to the level of brightness of the headlights of vehicles behind, the reflected light is automatically reduced.

Changing automatic anti-glare function mode
ON/OFF

When the automatic anti-glare function is in ON mode, the indicator illuminates. The function will set to ON mode each time the engine switch is turned to IGNITION ON mode.

Pressing the button turns the function to OFF mode. (The indicator also turns off.)

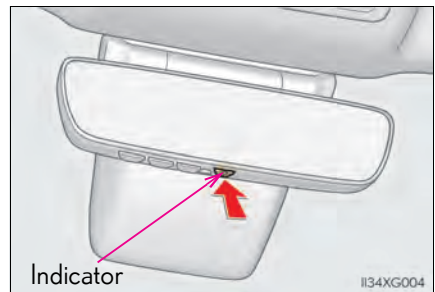

■ To prevent sensor error

To ensure that the sensors operate properly, do not touch or cover them.

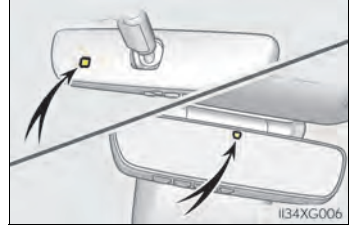
**⚠ WARNING**

Do not adjust the position of the mirror while driving.
Doing so may lead to mishandling of the vehicle and an accident, resulting in death or serious injury.

Outside rear view mirrors

Adjustment procedure

- 1** To select a mirror to adjust, press the switch.
- ① Left
 - ② Right

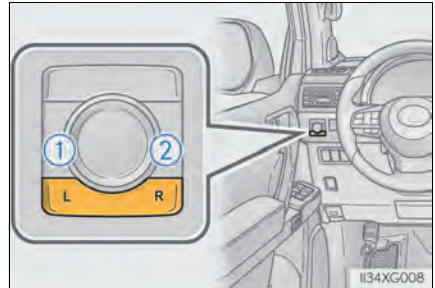

- 2** To adjust the mirror, press the switch.
- ① Up
 - ② Right
 - ③ Down
 - ④ Left

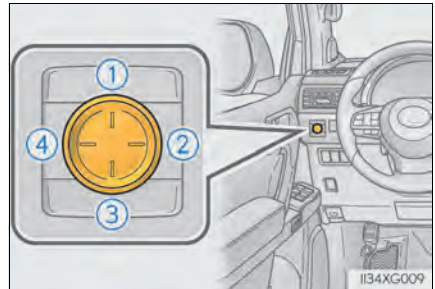

Folding and extending the mirrors

► Manual type

Push the mirror back in the direction of the vehicle's rear.



- ▶ Power type
- ① Extends the mirrors
- ② Folds the mirrors

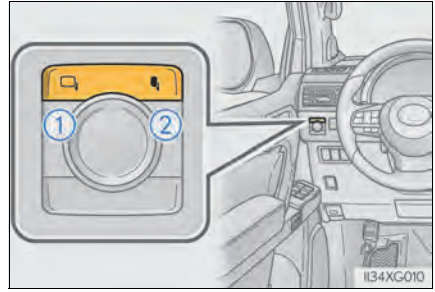

Linked mirror function when reversing

When the mirror select switch is in the L or R position, the outside rear view mirrors will automatically angle downwards when the vehicle is reversing in order to give a better view of the ground.

To disable this function, move the mirror select switch to the neutral position (between L and R).

■ Mirror angle can be adjusted when

The engine switch is in ACCESSORY or IGNITION ON mode.

■ When the mirrors are fogged up

The outside rear view mirrors can be cleared using the mirror defoggers. Turn on the rear window defogger to turn on the outside rear view mirror defoggers. (→P. 409)

■ Automatic adjustment of the mirror angle

A desired mirror face angle can be entered to memory and recalled automatically by the driving position memory. (→P. 145)

■ Auto anti-glare function (driver's side only)

When the anti-glare inside rear view mirror is set to automatic mode, the outside rear view mirrors will activate in conjunction with the anti-glare inside rear view mirror to reduce reflected light. (→P. 155)

**WARNING****■ Important points while driving**

Observe the following precautions while driving.

Failing to do so may result in loss of control of the vehicle and cause an accident, resulting in death or serious injury.

- Do not adjust the mirrors while driving.
- Do not drive with the mirrors folded.
- Both the driver and passenger side mirrors must be extended and properly adjusted before driving.

■ When a mirror is moving

To avoid personal injury and mirror malfunction, be careful not to get your hand caught by the moving mirror.

■ When the mirror defoggers are operating

Do not touch the rear view mirror surfaces, as they can become very hot and burn you.

**NOTICE****■ If ice should jam the mirror**

Do not operate the control or scrape the mirror face. Use a spray de-icer to free the mirror.

Power windows

Opening and closing procedures

The power windows can be opened and closed using the switches.

Operating the switch moves the windows as follows:

- ① Closing
- ② One-touch closing*
- ③ Opening
- ④ One-touch opening*

*: To stop the window partway, operate the switch in the opposite direction.

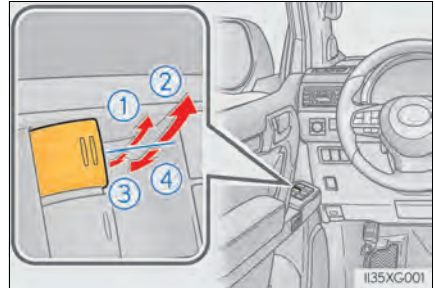

Window lock switch

Press the switch down to lock the passenger window switches.

The indicator will come on.

Use this switch to prevent children from accidentally opening or closing a passenger window.

The passenger windows can still be opened and closed using the power window switches on the driver's side even if the lock switch is on.

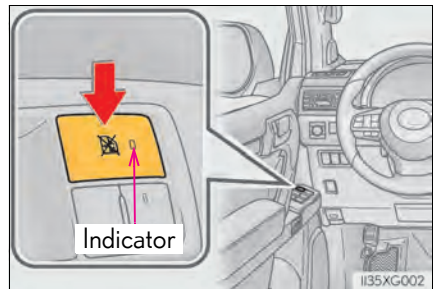

■ The power windows can be operated when

The engine switch is in IGNITION ON mode.

■ Operating the power windows after turning the engine off

The power windows can be operated for approximately 45 seconds even after the engine switch is turned to ACCESSORY mode or turned off. They cannot, however, be operated once either front door is opened.

■ Jam protection function

If an object becomes jammed between the window and the window frame while the window is closing, window movement is stopped and the window is opened slightly.

■ Catch protection function

If an object becomes caught between the door and window while the window is opening, window movement is stopped.

■ When the window cannot be opened or closed

When the jam protection function or catch protection function operates unusually and the door window cannot be opened and closed, perform the following operations with the power window switch of that door.

- Stop the vehicle. With the engine switch in IGNITION ON mode, within 4 seconds of the jam protection function or catch protection function activating, continuously operate the power window switch in the one-touch closing direction or one-touch opening direction so that the door window can be opened and closed.
- If the door window can not be opened and closed even when performing the above operations, perform the following procedure for function initialization.

- 1 Turn the engine switch to IGNITION ON mode.
- 2 Pull and hold the power window switch in the one-touch closing direction and completely close the door window.
- 3 Release the power window switch for a moment, resume pulling the switch in the one-touch closing direction, and hold it there for approximately 6 seconds or more.
- 4 Press and hold the power window switch in the one-touch opening direction. After the door window is completely opened, continue holding the switch for an additional 1 second or more.
- 5 Release the power window switch for a moment, resume pushing the switch in the one-touch opening direction, and hold it there for approximately 4 seconds or more.
- 6 Pull and hold the power window switch in the one-touch closing direction. After the door window is completely closed, continue holding the switch for a further 1 second or more.

If you release the switch while the window is moving, start again from the beginning.

If the window reverses and cannot be fully closed or opened, have the vehicle inspected by your Lexus dealer.

■ Door lock linked window operation

- The power windows can be opened and closed using the mechanical key^{*}. (→P. 564)
- The power windows can be opened using the wireless remote control^{*}. (→P. 108)

^{*}: These settings must be customized at your Lexus dealer.

■ Power window open reminder function

The buzzer sounds and a message is shown on the multi-information display in the instrument cluster when the engine switch is turned off and the driver's door is opened with the power windows open.

■ Customization

Settings (e.g. linked door lock operation) can be changed.
(Customizable features: →P. 600)

**WARNING**

Observe the following precautions.
Failure to do so may result in death or serious injury.

■ Closing the windows

- The driver is responsible for all the power window operations, including the operation for the passengers. In order to prevent accidental operation, especially by a child, do not let a child operate the power windows. It is possible for children and other passengers to have body parts caught in the power window. Also, when riding with a child, it is recommended to use the window lock switch. (→P. 160)
- Check to make sure that all passengers do not have any part of their body in a position where it could be caught when a window is being operated.
- When using the wireless remote control or mechanical key and operating the power windows, operate the power window after checking to make sure that there is no possibility of any passenger having any of their body parts caught in the window. Also, do not let a child operate window by the wireless remote control or mechanical key. It is possible for children and other passengers to get caught in the power window.
- When exiting the vehicle, turn the engine switch off, carry the key and exit the vehicle along with the child. There may be accidental operation, due to mischief, etc., that may possibly lead to an accident.

■ Jam protection function

- Never use any part of your body to intentionally activate the jam protection function.
- The jam protection function may not work if something gets jammed just before the window is fully closed. Be careful not to get any part of your body jammed in the window.

■ Catch protection function

- Never use any part of your body or clothing to intentionally activate the catch protection function.
- The catch protection function may not work if something gets caught just before the window is fully opened. Be careful not to get any part of your body or clothing caught in the window.

Moon roof

Use the overhead switches to open and close the moon roof and tilt it up and down.

Opening and closing

- ① Opens the moon roof*

The moon roof stops slightly before the fully open position to reduce wind noise. Press the switch again to fully open the moon roof.

- ② Closes the moon roof*

*: Lightly press either end of the moon roof switch to stop the moon roof partway.

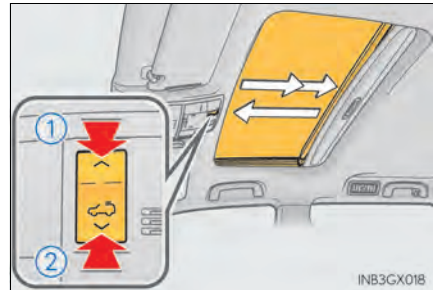

Tilting up and down

- ① Tilts the moon roof up*

- ② Tilts the moon roof down*

*: Lightly press either end of the moon roof switch to stop the moon roof partway.

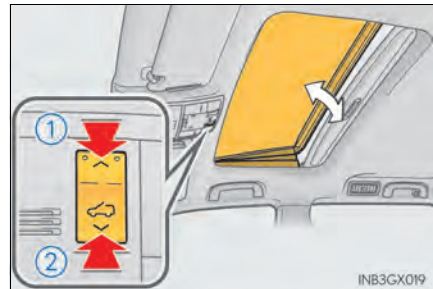

■ The moon roof can be operated when

The engine switch is in IGNITION ON mode.

■ Operating the moon roof after turning the engine off

The moon roof can be operated for approximately 45 seconds after the engine switch is turned to ACCESSORY mode or turned off. It cannot, however, be operated once either front door is opened.

■ Jam protection function

If an object is detected between the moon roof and the frame while the moon roof is closing or tilting down, travel is stopped and the moon roof opens slightly.

■ Sunshade

The sunshade can be opened and closed manually. However, the sunshade will open automatically when the moon roof is opened.

■ Door lock linked moon roof operation

- The moon roof can be opened and closed using the mechanical key^{*}. (→P. 564)

- The moon roof can be opened using the wireless remote control^{*}. (→P. 108)

^{*}: These settings must be customized at your Lexus dealer.

■ Moon roof open reminder function

A buzzer sounds and a message is shown on the multi-information display in the instrument cluster when the engine switch is turned off and the driver's door is opened with the moon roof open.

■ When the moon roof does not close normally

Perform the following procedure:

- If the moon roof closes but then re-opens slightly

1 Stop the vehicle.

2 Press and hold "v" on the . ^{*1}



The moon roof will close, re-open and pause for approximately 10 seconds. ^{*2} Then it will close again, tilt up and pause for approximately 1 second. Finally, it will tilt down, open and close.

3 Check to make sure that the moon roof is completely closed and then release the switch.

- If the moon roof tilts down but then tilts back up

1 Stop the vehicle.

2 Press and hold “^” on the  *1 until the moon roof moves into the tilt up position and stops.

3 Release “^” on the  once and then press and hold “^” on the  again. *1

The moon roof will pause for approximately 10 seconds in the tilt up position. *2 Then it will adjust slightly and pause for approximately 1 second. Finally, it will tilt down, open and close.

4 Check to make sure that the moon roof is completely closed and then release the switch.

*1: If the switch is released at the incorrect time, the procedure will have to be performed again from the beginning.

*2: If the switch is released after the above mentioned 10 second pause, automatic

operation will be disabled. In that case, press and hold “v” on the  or “^” on the



and the moon roof will tilt up and pause for approximately 1 second. Then it will tilt down, open and close. Check to make sure that the moon roof is completely closed and then release the switch.

If the moon roof does not fully close even after performing the above procedure correctly, have the vehicle inspected by your Lexus dealer.

■ Customization

Settings (e.g. linked door lock operation) can be changed.
(Customizable features: →P. 600)

**WARNING**

Observe the following precautions.
Failure to do so may result in death or serious injury.

■ Opening the moon roof

- Do not allow any passengers to put their hands or heads outside the vehicle while it is moving.
- Do not sit on top of the moon roof.

■ Closing the moon roof

- The driver is responsible for moon roof opening and closing operations. In order to prevent accidental operation, especially by a child, do not let a child operate the moon roof. It is possible for children and other passengers to have body parts caught in the moon roof.
- Check to make sure that all passengers do not have any part of their bodies in a position where it could be caught when the moon roof is being operated.
- When using the wireless remote control or mechanical key and operating the moon roof, operate the moon roof after checking to make sure that there is no possibility of any passenger having any of their body parts caught in the moon roof. Also, do not let a child operate moon roof by the wireless remote control or mechanical key. It is possible for children and other passengers to get caught in the moon roof.
- When exiting the vehicle, turn the engine switch off, carry the key and exit the vehicle along with the child. There may be accidental operation, due to mischief, etc., that may possibly lead to an accident.

■ Jam protection function

- Never use any part of your body to intentionally activate the jam protection function.
- The jam protection function may not work if something gets caught just before the moon roof fully closes.

4-1. Before driving

Driving the vehicle	168
Cargo and luggage	176
Vehicle load limits	180
Trailer towing (with towing hitch)	181
Dinghy towing	199

4-2. Driving procedures

Engine (ignition) switch	200
Automatic transmission	206
Turn signal lever	211
Parking brake	212

4-3. Operating the lights and wipers

Headlight switch	213
Automatic High Beam	216
Fog light switch	220
Windshield wipers and washer	221
Rear window wiper and washer	225
Headlight cleaner switch	227

4-4. Refueling

Opening the fuel tank cap	228
---------------------------------	-----

4-5. Using the driving support systems

Lexus Safety System +	232
PCS (Pre-Collision System)	237
LDA (Lane Departure Alert)	247
Dynamic radar cruise control	255
Intuitive parking assist	267
Lexus parking assist monitor	277
Multi-terrain Select	292
Multi-terrain Monitor	296
Rear height control air suspension	352
AVS (Adaptive Variable Suspension System)	356
Four-wheel drive system	357
Crawl Control	361
Downhill assist control system	365
Driving assist systems	368
BSM (Blind Spot Monitor)	374
• The Blind Spot Monitor function	377
• The Rear Cross Traffic Alert function	380

4-6. Driving tips

Winter driving tips	387
Off-road precautions	390

Driving the vehicle

The following procedures should be observed to ensure safe driving:

Starting the engine

→P. 200

Driving

- 1 With the brake pedal depressed, shift the shift lever to D. (→P. 206)
- 2 Release the parking brake. (→P. 212)
- 3 Gradually release the brake pedal and gently depress the accelerator pedal to accelerate the vehicle.

Stopping

- 1 With the shift lever in D, depress the brake pedal.
- 2 If necessary, set the parking brake.
If the vehicle is to be stopped for an extended period of time, shift the shift lever to P or N. (→P. 206)

Parking the vehicle

- 1 With the shift lever in D, depress the brake pedal.
- 2 Set the parking brake (→P. 212), and shift the shift lever to P (→P. 206).
- 3 Press the engine switch to stop the engine.
- 4 Lock the door, making sure that you have the key on your person.
If parking on a hill, block the wheels as needed.

Starting off on a steep uphill

- 1 Make sure that the parking brake is set and shift the shift lever to D.
- 2 Gently depress the accelerator pedal.
- 3 Release the parking brake.

■ When starting off on a uphill

The hill-start assist control is available. (→P. 369)

■ Driving in the rain

- Drive carefully when it is raining, because visibility will be reduced, the windows may become fogged-up, and the road will be slippery.
- Drive carefully when it starts to rain, because the road surface will be especially slippery.
- Refrain from high speeds when driving on an expressway in the rain, because there may be a layer of water between the tires and the road surface, preventing the steering and brakes from operating properly.

■ Engine speed while driving

In the following conditions, the engine speed may become high while driving. This is due to automatic up-shifting control or down-shifting implementation to meet driving conditions. It does not indicate sudden acceleration.

- The vehicle is judged to be driving uphill or downhill
- When the accelerator pedal is released

■ Restraining the engine output (Brake Override System)

- When the accelerator and brake pedals are depressed at the same time, the engine output may be restrained.
- A warning message is displayed on the multi-information display while the system is operating. (→P. 545)

■ Restraining sudden start (Drive-Start Control)

- When the following unusual operation is performed, the engine output may be restrained.
 - When the shift lever is shifted from R to D, D to R, N to R, P to D, or P to R (D includes S) with the accelerator pedal depressed, a warning message appears on the multi-information display. If a warning message is shown on the multi-information display, read the message and follow the instructions.
 - When the accelerator pedal is depressed too much while the vehicle is in reverse.
- While Drive-Start Control is being activated, your vehicle may have trouble escaping from the mud or fresh snow. In such case, perform the following actions to cancel Drive Start Control so that the vehicle may become able to escape from the mud or fresh snow.
 - Deactivate Active TRAC (→P. 370)
 - Put the four-wheel drive control switch in L4. (→P. 357)
 - Push the center differential lock/unlock switch to lock the center differential. (→P. 358)

■ Breaking in your new Lexus

To extend the life of the vehicle, observing the following precautions is recommended:

- For the first 200 miles (300 km):
Avoid sudden stops.
- For the first 500 miles (800 km):
Do not tow a trailer.
- For the first 600 miles (1000 km):
 - Do not drive at extremely high speeds.
 - Avoid sudden acceleration.
 - Do not drive continuously in the low gears.
 - Do not drive at a constant speed for extended periods.

■ Drum-in-disc type parking brake system

Your vehicle has a drum-in-disc type parking brake system.

This type of brake system needs bedding-down of the brake shoes periodically or whenever the parking brake shoes and/or drum are replaced.

Have your Lexus dealer, perform the bedding-down operation.

■ Operating your vehicle in a foreign country

Comply with the relevant vehicle registration laws and confirm the availability of the correct fuel. (→P. 578)

■ When turning off the engine

Emission system operating sounds may continue for a short time after the engine is turned off. This is not a malfunction, and helps to ensure optimal performance of the emission system.

 **WARNING**

Observe the following precautions.
Failure to do so may result in death or serious injury.

■ When starting the vehicle

Always keep your foot on the brake pedal while stopped with the engine running. This prevents the vehicle from creeping.

■ When driving the vehicle

- Do not drive if you are unfamiliar with the location of the brake and accelerator pedals to avoid depressing the wrong pedal.
 - Accidentally depressing the accelerator pedal instead of the brake pedal will result in sudden acceleration that may lead to an accident.
 - When backing up, you may twist your body around, leading to a difficulty in operating the pedals. Make sure to operate the pedals properly.
 - Make sure to keep a correct driving posture even when moving the vehicle only slightly. This allows you to depress the brake and accelerator pedals properly.
 - Depress the brake pedal using your right foot. Depressing the brake pedal using your left foot may delay response in an emergency, resulting in an accident.
- Do not drive the vehicle over or stop the vehicle near flammable materials. The exhaust system and exhaust gases can be extremely hot. These hot parts may cause a fire if there is any flammable material nearby.
- During normal driving, do not turn off the engine. Turning the engine off while driving will not cause loss of steering or braking control, but the power assist to these systems will be lost. This will make it more difficult to steer and brake, so you should pull over and stop the vehicle as soon as it is safe to do so. However, in the event of an emergency, such as if it becomes impossible to stop the vehicle in the normal way: →P. 525
- Use engine braking (downshift) to maintain a safe speed when driving down a steep hill. Using the brakes continuously may cause the brakes to overheat and lose effectiveness. (→P. 206)
- Do not adjust the positions of the steering wheel, the seat, or the inside or outside rear view mirrors while driving. Doing so may result in a loss of vehicle control.
- Always check that all passengers' arms, heads or other parts of their body are not outside the vehicle.
- Do not drive in excess of the speed limit. Even if the legal speed limit permits it, do not drive over 85 mph (140 km/h) unless your vehicle has high-speed capability tires. Driving over 85 mph (140 km/h) may result in tire failure, loss of control and possible injury. Be sure to consult a tire dealer to determine whether the tires on your vehicle are high-speed capability tires or not before driving at such speeds.

**WARNING**

Observe the following precautions.
Failure to do so may result in death or serious injury.

■ When driving on slippery road surfaces

- Sudden braking, acceleration and steering may cause tire slippage and reduce your ability to control the vehicle.
- Sudden acceleration, engine braking due to shifting, or changes in engine speed could cause the vehicle to skid.
- After driving through a puddle, lightly depress the brake pedal to make sure that the brakes are functioning properly. Wet brake pads may prevent the brakes from functioning properly. If the brakes on only one side are wet and not functioning properly, steering control may be affected.

■ When shifting the shift lever

- Do not let the vehicle roll backwards while the shift lever is in a driving position, or roll forward while the shift lever is in R.
Doing so may cause the engine to stall or lead to poor brake and steering performance, resulting in an accident or damage to the vehicle.
- Do not shift the shift lever to P while the vehicle is moving.
Doing so can damage the transmission and may result in a loss of vehicle control.
- Do not shift the shift lever to R while the vehicle is moving forward.
Doing so can damage the transmission and may result in a loss of vehicle control.
- Do not shift the shift lever to a driving position while the vehicle is moving backward.
Doing so can damage the transmission and may result in a loss of vehicle control.
- Moving the shift lever to N while the vehicle is moving will disengage the engine from the transmission. Engine braking is not available when N is selected.
- Be careful not to shift the shift lever with the accelerator pedal depressed. Shifting the shift lever to a gear other than P or N may lead to unexpected rapid acceleration of the vehicle that may cause an accident.

■ If you hear a squealing or scraping noise (brake pad wear limit indicators)

Have the brake pads checked and replaced by your Lexus dealer as soon as possible. Rotor damage may result if the pads are not replaced when needed.

It is dangerous to drive the vehicle when the wear limits of the brake pads and/or those of the brake discs are exceeded.

 **WARNING**

Observe the following precautions.
Failure to do so may result in death or serious injury.

■ When the vehicle is stopped

- Do not race the engine.
If the vehicle is in any gear other than P or N, the vehicle may accelerate suddenly and unexpectedly, causing an accident.
- In order to prevent accidents due to the vehicle rolling away, always keep depressing the brake pedal while the engine is running, and apply the parking brake as necessary.
- If the vehicle is stopped on an incline, in order to prevent accidents caused by the vehicle rolling forward or backward, always depress the brake pedal and securely apply the parking brake as needed.
- Avoid revving or racing the engine. Running the engine at high speed while the vehicle is stopped may cause the exhaust system to overheat, which could result in a fire if combustible material is nearby.

■ When the vehicle is parked

- Do not leave glasses, cigarette lighters, spray cans, or soft drink cans in the vehicle when it is in the sun.

Doing so may result in the following:

- Gas may leak from a cigarette lighter or spray can, and may lead to a fire.
- The temperature inside the vehicle may cause the plastic lenses and plastic material of glasses to deform or crack.
- Soft drink cans may fracture, causing the contents to spray over the interior of the vehicle, and may also cause a short circuit in the vehicle's electrical components.
- Do not leave cigarette lighters in the vehicle. If a cigarette lighter is in a place such as the glove box or on the floor, it may be lit accidentally when luggage is loaded or the seat is adjusted, causing a fire.
- Do not attach adhesive discs to the windshield or windows. Do not place containers such as air fresheners on the instrument panel or dashboard. Adhesive discs or containers may act as lenses, causing a fire in the vehicle.
- Do not leave a door or window open if the curved glass is coated with a metallized film such as a silver-colored one. Reflected sunlight may cause the glass to act as a lens, causing a fire.
- Always apply the parking brake, shift the shift lever to P, stop the engine and lock the vehicle.
Do not leave the vehicle unattended while the engine is running.
If the vehicle is parked with the shift lever in P but the parking brake is not set, the vehicle may start to move, possibly leading to an accident.
- Do not touch the exhaust pipes while the engine is running or immediately after turning the engine off.
Doing so may cause burns.

**WARNING**

Observe the following precautions.
Failure to do so may result in death or serious injury.

■ When taking a nap in the vehicle

Always turn the engine off. Otherwise, if you accidentally move the shift lever or depress the accelerator pedal, this could cause an accident or fire due to engine overheating. Additionally, if the vehicle is parked in a poorly ventilated area, exhaust gases may collect and enter the vehicle, leading to death or a serious health hazard.

■ When braking

- When the brakes are wet, drive more cautiously.

Braking distance increases when the brakes are wet, and this may cause one side of the vehicle to brake differently than the other side. Also, the parking brake may not securely hold the vehicle.

- If the brake booster device does not operate, do not follow other vehicles closely and avoid hills or sharp turns that require braking. In this case, braking is still possible, but the brake pedal should be depressed more firmly than usual. Also, the braking distance will increase. Have your brakes fixed immediately.

- Do not pump the brake pedal if the engine stalls.

Each push on the brake pedal uses up the reserve for the power-assisted brakes.

- The brake system consists of 2 individual hydraulic systems: If one of the systems fails, the other will still operate. In this case, the brake pedal should be depressed more firmly than usual and the braking distance will increase.

Have your brakes fixed immediately.

■ If the vehicle becomes stuck

Do not spin the wheels excessively when any of the tires is up in the air, or the vehicle is stuck in sand, mud, etc. This may damage the driveline components or propel the vehicle forward or backward, causing an accident.

 NOTICE**■ When driving the vehicle**

- Do not depress the accelerator and brake pedals at the same time during driving, as this may restrain the engine output.
- Do not use the accelerator pedal or depress the accelerator and brake pedals at the same time to hold the vehicle on a hill.

■ When parking the vehicle

Always set the parking brake, and shift the shift lever to P. Failure to do so may cause the vehicle to move or the vehicle may accelerate suddenly if the accelerator pedal is accidentally depressed.

■ Avoiding damage to vehicle parts

- Do not turn the steering wheel fully in either direction and hold it there for an extended period of time.
Doing so may damage the power steering pump.
- When driving over bumps in the road, drive as slowly as possible to avoid damaging the wheels, underside of the vehicle, etc.

■ If you get a flat tire while driving

A flat or damaged tire may cause the following situations. Hold the steering wheel firmly and gradually depress the brake pedal to slow down the vehicle.

- It may be difficult to control your vehicle.
- The vehicle will make abnormal sounds or vibrations.
- The vehicle will lean abnormally.

Information on what to do in case of a flat tire. (→P. 548)

■ When encountering flooded roads

Do not drive on a road that has flooded after heavy rain etc. Doing so may cause the following serious damage to the vehicle:

- Engine stalling
- Short in electrical components
- Engine damage caused by water immersion

In the event that you drive on a flooded road and the vehicle is flooded, be sure to have your Lexus dealer check the following:

- Brake function
- Changes in quantity and quality of oil and fluid used for the engine, transmission, transfer, differentials, etc.
- Lubricant condition for the propeller shaft, bearings and suspension joints (where possible), and the function of all joints, bearings, etc.

Cargo and luggage

Take notice of the following information about storage precautions, cargo capacity and load:

Capacity and distribution

Cargo capacity depends on the total weight of the occupants.

$(\text{Cargo capacity}) = (\text{Total load capacity}) - (\text{Total weight of occupants})$

Steps for Determining Correct Load Limit—

- (1) Locate the statement “The combined weight of occupants and cargo should never exceed XXX kg or XXX lbs.” on your vehicle’s placard.
- (2) Determine the combined weight of the driver and passengers that will be riding in your vehicle.
- (3) Subtract the combined weight of the driver and passengers from XXX kg or XXX lbs.
- (4) The resulting figure equals the available amount of cargo and luggage load capacity.
For example, if the “XXX” amount equals 1400 lbs. and there will be five 150 lb passengers in your vehicle, the amount of available cargo and luggage load capacity is 650 lbs. $(1400 - 750 (5 \times 150) = 650 \text{ lbs.})$
- (5) Determine the combined weight of luggage and cargo being loaded on the vehicle. That weight may not safely exceed the available cargo and luggage load capacity calculated in Step 4.
- (6) If your vehicle will be towing a trailer, load from your trailer will be transferred to your vehicle. Consult this manual to determine how this reduces the available cargo and luggage load capacity of your vehicle. (→P. 180)

Calculation formula for your vehicle

- ① Cargo capacity
- ② Total load capacity (vehicle capacity weight) (→P. 576)

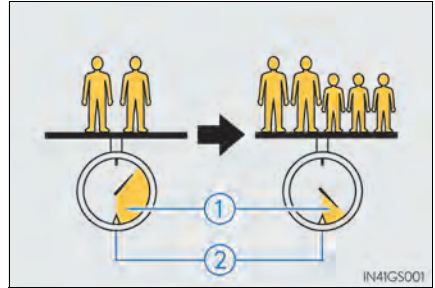

When 2 people with the combined weight of A lb. (kg) are riding in your vehicle, which has a total load capacity (vehicle capacity weight) of B lb. (kg), the available amount of cargo and luggage load capacity will be C lb. (kg) as follows:

$$B^{*2} \text{ lb. (kg)} - A^{*1} \text{ lb. (kg)} = C^{*3} \text{ lb. (kg)}$$

*1: A = Weight of people

*2: B = Total load capacity

*3: C = Available cargo and luggage load

In this condition, if 3 more passengers with the combined weight of D lb. (kg) get on, the available cargo and luggage load will be reduced E lb. (kg) as follows:

$$C \text{ lb. (kg)} - D^{*4} \text{ lb. (kg)} = E^{*5} \text{ lb. (kg)}$$

*4: D = Additional weight of people

*5: E = Available cargo and luggage load

As shown in the example above, if the number of occupants increases, the cargo and luggage load will be reduced by an amount that equals the increased weight due to the additional occupants. In other words, if an increase in the number of occupants causes an excess of the total load capacity (combined weight of occupants plus cargo and luggage load), you must reduce the cargo and luggage on your vehicle.

Roof luggage carrier (if equipped)*

■ Roof luggage carrier components

- ① Roof rail
- ② Cross rail

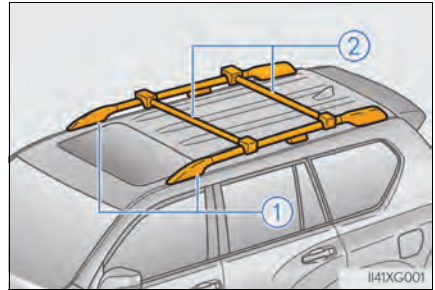

*: The roof luggage carrier differs depending on the models.

⚠ WARNING

■ Things that must not be carried in the luggage compartment

The following things may cause a fire if loaded in the luggage compartment:

- Receptacles containing gasoline
- Aerosol cans

■ Storage precautions

Observe the following precautions.

Failure to do so may prevent the pedals from being depressed properly, may block the driver's vision, or may result in items hitting the driver or passengers, possibly causing an accident.

- Stow cargo and luggage in the luggage compartment whenever possible.
- Do not stack anything in the luggage compartment higher than the seatbacks.
- Do not place cargo or luggage in or on the following locations.
 - At the feet of the driver
 - On the front passenger or rear seats (when stacking items)
 - On the luggage cover (if equipped)
 - On the instrument panel
 - On the dashboard
- Secure all items in the occupant compartment.
- When you fold down the rear seats, long items should not be placed directly behind the front seats.
- Never allow anyone to ride in the luggage compartment. It is not designed for passengers. They should ride in their seats with their seat belts properly fastened. Otherwise, they are much more likely to suffer death or serious bodily injury, in the event of sudden braking, sudden swerving or an accident.

 **WARNING****■ Capacity and distribution**

- Do not exceed the maximum axle weight rating or the total vehicle weight rating.
- Even if the total load of occupant's weight and the cargo load is less than the total load capacity, do not apply the load unevenly. Improper loading may cause deterioration of steering or braking control which may cause death or serious injury.

■ Roof luggage carrier precautions (if equipped)

To use the roof rails as a roof luggage carrier, you must fit the roof rails with two or more genuine Lexus cross rails or their equivalent.

Follow the manufacturer's instructions and precautions when installing the cross rails or their equivalent.

When you load cargo on the roof luggage carrier, observe the following:

- Place the cargo so that its weight is distributed evenly between the front and rear axles.
- If loading long or wide cargo, never exceed the vehicle overall length or width. (→P. 576)
- Before driving, make sure the cargo is securely fastened on the roof luggage carrier.
- Loading cargo on the roof luggage carrier will make the center of gravity of the vehicle higher. Avoid high speeds, sudden starts, sharp turns, sudden braking or abrupt maneuvers, otherwise it may result in loss of control or vehicle rollover due to failure to operate this vehicle correctly and result in death or serious injury.
- If driving for a long distance, on rough roads, or at high speeds, stop the vehicle now and then during the trip to make sure the cargo remains in its place.
- Do not exceed 176 lb. (80 kg) cargo weight on the roof luggage carrier.

 **NOTICE****■ When loading cargo on the roof luggage carrier (if equipped)**

Be careful not to scratch the surface of the moon roof.

Vehicle load limits

Vehicle load limits include total load capacity, seating capacity, TWR (Trailer Weight Rating) and cargo capacity.

◆ Total load capacity (vehicle capacity weight): →P. 576

Total load capacity means the combined weight of occupants, cargo and luggage.

◆ Seating capacity: →P. 576

Seating capacity means the maximum number of occupants whose estimated average weight is 150 lb. (68 kg) per person.

◆ TWR (Trailer Weight Rating): →P. 185, 576

TWR means the maximum gross trailer weight (trailer weight plus its cargo weight) that your vehicle is able to tow.

◆ Cargo capacity

Cargo capacity may increase or decrease depending on the weight and the number of occupants.

■ Total load capacity and seating capacity

These details are also described on the tire and loading information label. (→P. 499)



WARNING

■ Overloading the vehicle

Do not overload the vehicle.

It may not only cause damage to the tires, but also degrade steering and braking ability, resulting in an accident.

Trailer towing (with towing hitch)

Your vehicle is designed primarily as a passenger-and-load-carrying vehicle. Towing a trailer can have an adverse impact on handling, performance, braking, durability, and fuel consumption. For your safety and the safety of others, you must not overload your vehicle or trailer. You must also ensure that you are using appropriate towing equipment, that the towing equipment has been installed correctly and used properly, and that you employ the requisite driving habits.

Vehicle-trailer stability and braking performance are affected by trailer stability, brake performance and setting, trailer brakes, the hitch and hitch systems (if equipped).

To tow a trailer safely, use extreme care and drive the vehicle in accordance with your trailer's characteristics and operating conditions.

Lexus warranties do not apply to damage or malfunction caused by towing a trailer for commercial purposes.

Contact your Lexus dealer for further information about additional requirements such as towing kits, etc.

Towing related terms

■ GCWR (Gross Combination Weight Rating)

The maximum allowable gross combination weight. The gross combination weight is the sum of the total vehicle weight (including the occupants, cargo and any optional equipment installed on the vehicle) and the weight of the trailer being towed (including the cargo in the trailer).

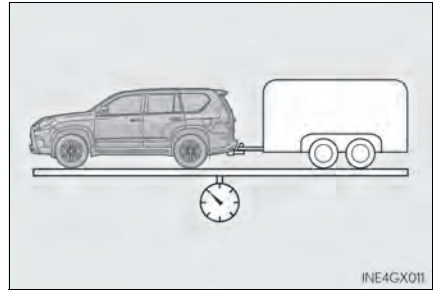

■ GVWR (Gross Vehicle Weight Rating)

The maximum allowable gross vehicle weight. The gross vehicle weight is the total weight of the vehicle. When towing a trailer, it is the sum of the vehicle weight (including the occupants, cargo and any optional equipment installed on the vehicle) and the tongue weight.

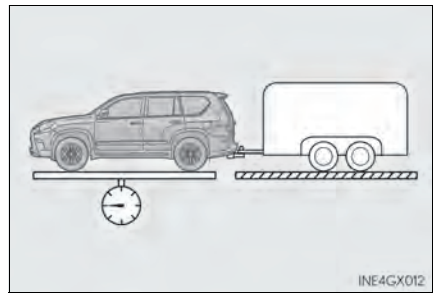

■ GAWR (Gross Axle Weight Rating)

The maximum allowable gross axle weight. The gross axle weight is the load placed on each axle (front and rear).

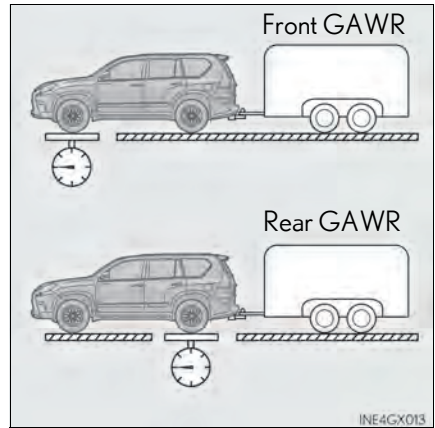

■ TWR (Trailer Weight Rating)

The maximum allowable gross trailer weight. The gross trailer weight is the sum of the trailer weight and the weight of the cargo in the trailer.

TWR is calculated assuming base vehicle with one driver, one front passenger, towing package (if available), hitch and hitch systems (if required).

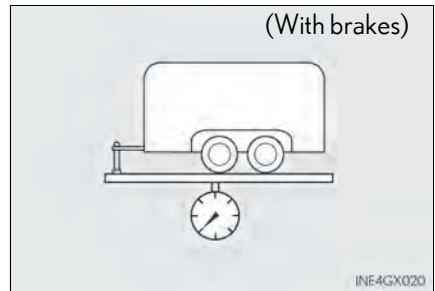

Additional optional equipment, passengers and cargo in the vehicle will reduce the trailer weight rating so as not to exceed GCWR, GVWR and GAWR.

If the gross trailer weight exceeds 3000 lb. (1360 kg), it is recommended to use a trailer with 2 or more axles.

■ Unbraked TWR (Unbraked Trailer Weight Rating)

The trailer weight rating for towing a trailer without a trailer service brake system.

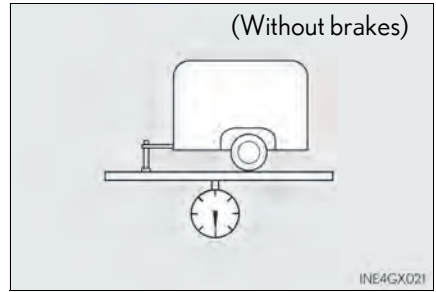

■ Tongue Weight

The load placed on the trailer hitch ball. (→P. 186)

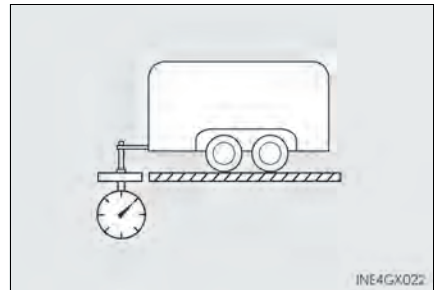

Weight limits

- The gross trailer weight must never exceed 6500 lb. (2950 kg).
- The gross combination weight must never exceed 13100 lb. (5940 kg).
- The gross vehicle weight must never exceed the GVWR indicated on the Certification Label.
- The gross axle weight on each axle must never exceed the GAWR indicated on the Certification Label.



- If the gross trailer weight is over the unbraked TWR, trailer service brakes are required.
- If the gross trailer weight is over 2000 lb. (907 kg), a sway control device with sufficient capacity is required.
- If the gross trailer weight is over 5000 lb. (2268 kg), a weight distributing hitch with sufficient capacity is required.

GCWR, TWR and Unbraked TWR

Confirm that the gross trailer weight, gross combination weight, gross vehicle weight, gross axle weight and tongue weight are all within the limits.

- **GCWR***
13100 lb. (5940 kg)
- **TWR***
6500 lb. (2950 kg)
- **Unbraked TWR***
1000 lb. (453 kg)

*: This model meets the tow-vehicle trailering requirement of SAE International per SAE J2807.

Trailer Tongue Weight

- A recommended tongue weight varies in accordance with the types of trailers or towing as described below.
- To ensure the recommended values shown below, the trailer must be loaded by referring to the following instructions.

- Tongue Weight

The gross trailer weight should be distributed so that the tongue weight is 9 % to 11 %. (Tongue weight/Gross trailer weight \times 100 = 9 % to 11 %)

- ① Gross trailer weight
- ② Tongue weight

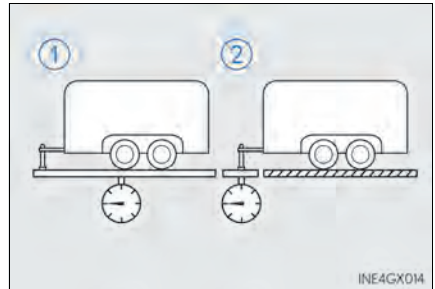

If using a weight distributing hitch when towing, return the front axle to the same weight as before the trailer connection.

If front axle weight cannot be measured directly, measure the front fender height above the front axle before connection. Adjust weight distributing hitch torque until front fender is returned to the same height as before connection.

The gross trailer weight, gross axle weight and tongue weight can be measured with platform scales found at a highway weighing station, building supply company, trucking company, junk yard, etc.

Hitch

Trailer hitch assemblies have different weight capacities. Lexus recommends the use of Lexus hitch/bracket for your vehicle. For details, contact your Lexus dealer.

- If you wish to install a trailer hitch, contact your Lexus dealer.
- Use only a hitch that conforms to the gross trailer weight requirement of your vehicle.
- Follow the directions supplied by the hitch manufacturer.
- Lubricate the hitch ball with a light coating of grease.
- Remove the hitch ball whenever you are not towing a trailer. Remove the trailer hitch if you do not need it. After removing the hitch, seal any mounting hole in the vehicle body to prevent entry of any substances into the vehicle.

Selecting trailer ball

Use the correct trailer ball for your application.

① Trailer ball load rating

Matches or exceeds the gross trailer weight rating of the trailer.

② Ball diameter

Matches the size of the trailer coupler. Most couplers are stamped with the required trailer ball size.

Trailer class	Typical trailer ball size
IV	2 5/16 in.
II and III	2 in.
I	1 7/8 in.

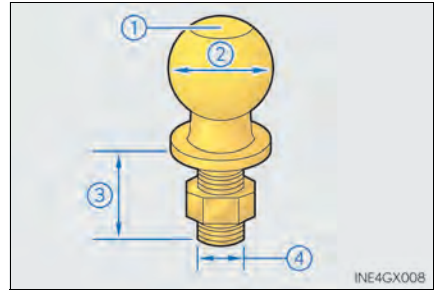

③ Shank length

Protrudes beyond the bottom of the lock washer and nut by at least 2 threads.

④ Shank diameter

Matches the ball mount hole diameter size.

Positions for towing hitch receiver and hitch ball

- ▶ Vehicles without rear height control air suspension
 - ① Weight carrying ball position: 50.4 in. (1280.6 mm)*
 - ② Hitch receiver pin hole position: 41.1 in. (1044.2 mm)*
 - ▶ Vehicles with rear height control air suspension
 - ① Weight carrying ball position: 50.5 in. (1282.7 mm)*
 - ② Hitch receiver pin hole position: 41.2 in. (1046.6 mm)*
- *: Unladen vehicles

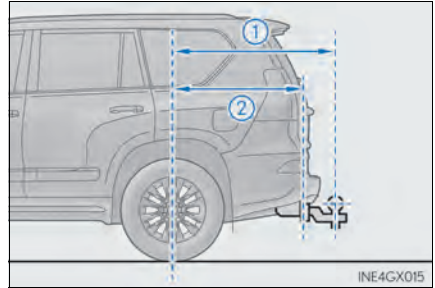

Connecting trailer lights

Use the wire harness stored in the rear end under the vehicle body.

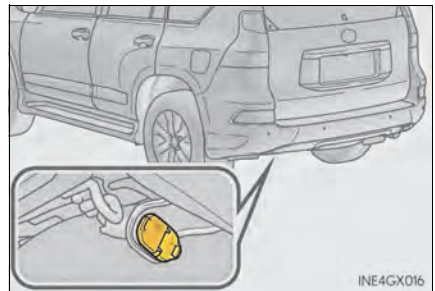

Please consult your dealer when installing trailer lights, as incorrect installation may cause damage to the vehicle's lights. Please take care to comply with your state's laws when installing trailer lights.

Connecting and disconnecting a trailer

Stop your vehicle and a trailer in line and perform the following:

● Connecting a trailer

- 1 Set the rear height control air suspension (if equipped) to N mode.
- 2 Turn off the engine switch or the rear height control air suspension (if equipped).
- 3 Connect the trailer.
- 4 Turn on the switch that was turned off on step 2.

● Disconnecting a trailer

- 1 Set the rear height control air suspension (if equipped) to N mode.
- 2 Turn off the rear height control air suspension (if equipped).
- 3 Turn off the engine switch.
- 4 Set the supporting leg of the trailer on the ground and raise the hitch by 4 in. (100 mm)
- 5 Turn on the engine switch.
- 6 Turn on the rear height control air suspension (if equipped).
- 7 Wait until vehicle height is stabilized.

Make sure the hitch is disconnected. If the hitch does not disconnect, raise the hitch higher and repeat steps 2 through 7.

Trailer towing tips

Your vehicle will handle differently when towing a trailer. Help to avoid an accident, death or serious injury, keep the following in mind when towing:

- Speed limits for towing a trailer vary by state or province. Do not exceed the posted towing speed limit.
- Lexus recommends that the vehicle-trailer speed limit is 65 mph (104 km/h) on a flat, straight, dry road. Do not exceed this limit, the posted towing speed limit or the speed limit for your trailer as set forth in your trailer owner's manual, whichever is lowest. Instability of the towing vehicle-trailer combination (trailer sway) increases as speed increases. Exceeding speed limits may cause loss of control.
- Before starting out, check the trailer lights, tires and the vehicle-trailer connections. Recheck after driving a short distance.
- Practice turning, stopping and reversing with the trailer attached in an area away from traffic until you become accustomed to the feel of the vehicle-trailer combination.
- Reversing with a trailer attached is difficult and requires practice. Grip the bottom of the steering wheel and move your hand to the left to move the trailer to the left. Move your hand to the right to move the trailer to the right. (This is generally opposite to reversing without a trailer attached.) Avoid sharp or prolonged turning. Have someone guide you when reversing to reduce the risk of an accident.
- As stopping distance is increased when towing a trailer, vehicle-to-vehicle distance should be increased. For each 10 mph (16 km/h) of speed, allow at least one vehicle and trailer length.
- Avoid sudden braking as you may skid, resulting in the trailer jackknifing and loss of vehicle control. This is especially true on wet or slippery surfaces.

- Avoid jerky starts or sudden acceleration.
- Avoid jerky steering and sharp turns, and slow down before making a turn.
- Note that when making a turn, the trailer wheels will be closer than the vehicle wheels to the inside of the turn. Compensate by making a wider than normal turning radius.
- Slow down before making a turn, in crosswinds, on wet or slippery surfaces, etc.
Increasing vehicle speed can destabilize the trailer.
- Take care when passing other vehicles. Passing requires considerable distance. After passing a vehicle, do not forget the length of your trailer, and be sure you have plenty of room before changing lanes.
- To maintain engine braking efficiency and charging system performance when using engine braking, do not put the transmission in D.
If in the S mode, the transmission shift range position must be in 5 or lower.
- Instability happens more frequently when descending steep or long downhill grades. Before descending, slow down and downshift. Do not make sudden downshifts while descending steep or long downhill grades.
- Avoid holding the brake pedal down too long or applying the brakes too frequently. This could cause the brakes to overheat and result in reduced braking efficiency.
- Due to the added load of the trailer, your vehicle's engine may overheat on hot days (at temperatures over 85°F [30°C]) when driving up a long or steep grade. If the engine coolant temperature gauge indicates overheating, immediately turn off the air conditioning (if in use), pull your vehicle off the road and stop in a safe spot. (→P. 570)

- Always place wheel blocks under both the vehicle's and the trailer's wheels when parking. Apply the parking brake firmly, and put the transmission in P. Avoid parking on a slope, but if unavoidable, do so only after performing the following:
 - 1 Apply the brakes and keep them applied.
 - 2 Have someone place wheel blocks under both the vehicle's and trailer's wheels.
 - 3 When the wheel blocks are in place, release the brakes slowly until the blocks absorb the load.
 - 4 Apply the parking brake firmly.
 - 5 Shift into P and turn off the engine.
- When restarting after parking on a slope:
 - 1 With the transmission in P, start the engine. Be sure to keep the brake pedal pressed.
 - 2 Shift into 3, 2, L, or R (if reversing).
 - 3 Release the parking brake and brake pedal, and slowly pull or back away from the wheel blocks. Stop and apply the brakes.
 - 4 Have someone retrieve the blocks.

■ Matching trailer ball height to trailer coupler height

No matter which class of tow hitch applies, for a more safe trailer hookup, the trailer ball setup must be the proper height for the coupler on the trailer.

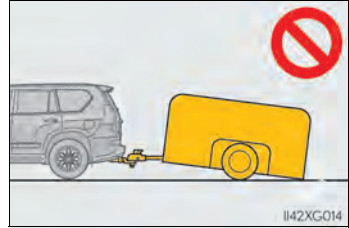

- ① Trailer ball
- ② Coupler

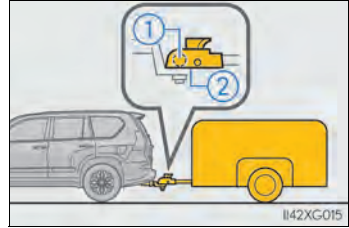

■ Before towing

Check that the following conditions are met:

- Ensure that your vehicle's tires are properly inflated. (→P. 584)
- Trailer tires are inflated according to the trailer manufacturer's recommendation.
- All trailer lights work as required by law.
- All lights work each time you connect them.
- The trailer ball is set at the proper height for the coupler on the trailer.
- The trailer is level when it is hitched.
Do not drive if the trailer is not level, and check for improper tongue weight, overloading, worn suspension, or other possible causes.
- The trailer cargo is securely loaded.
- The rear view mirrors conform to all applicable federal, state/provincial or local regulations. If they do not, install rear view mirrors appropriate for towing purposes.

■ AVS (adaptive variable suspension system) (if equipped)

The suspension can be switched for improvement in driveability. (→P. 356)

■ Break-in schedule

If your vehicle is new or equipped with any new power train components (such as an engine, transmission, differential or wheel bearing), Lexus recommends that you do not tow a trailer until the vehicle has been driven for over 500 miles (800 km).

After the vehicle has been driven for over 500 miles (800 km), you can start towing. However, for the next 500 miles (800 km), drive the vehicle at a speed of less than 50 mph (80 km/h) when towing a trailer, and avoid full throttle acceleration.

■ Maintenance

- If you tow a trailer, your vehicle will require more frequent maintenance due to the additional load. (See “Owner’s Guide”, “Warranty and Services Guide”, “Owner’s Manual Supplement” or “Warranty Booklet”.)
- Retighten the fixing bolts of the towing ball and bracket after approximately 600 miles (1000 km) of trailer towing.

■ If trailer sway occurs

One or more factors (crosswinds, passing vehicles, rough roads, etc.) can adversely affect handling of your vehicle and trailer, causing instability.

- If trailer swaying occurs:
 - Firmly grip the steering wheel. Steer straight ahead.
Do not try to control trailer swaying by turning the steering wheel.
 - Begin releasing the accelerator pedal immediately but very gradually to reduce speed.
Do not increase speed. Do not apply vehicle brakes.

If you make no extreme correction with the steering or brakes, your vehicle and trailer should stabilize.

- After the trailer swaying has stopped:
 - Stop in a safe place. Get all occupants out of the vehicle.
 - Check the tires of the vehicle and the trailer.
 - Check the load in the trailer.
 - Make sure the load has not shifted.
 - Make sure the tongue weight is appropriate, if possible.
 - Check the load in the vehicle.
 - Make sure the vehicle is not overloaded after occupants get in.

If you cannot find any problems, the speed at which trailer swaying occurred is beyond the limit of your particular vehicle-trailer combination.

Drive at a lower speed to prevent instability. Remember that swaying of the towing vehicle-trailer increases as speed increases.



WARNING

■ Trailer towing precautions

- To tow a trailer safely, use extreme care and drive the vehicle in accordance with the trailer's characteristics and operating conditions. Failure to do so could cause an accident resulting in death or serious injury. Vehicle stability and braking performance are affected by trailer stability, brake setting and performance, and the hitch. Your vehicle will handle differently when towing a trailer.
- Set the vehicle height to the LO mode and turn off the rear height control air suspension when you connect a trailer, otherwise the vehicle height may change due to the automatic leveling function, and you may catch part of your body in the vehicle, resulting in an accident.

 **WARNING****■ To avoid accident or injury**

- Do not exceed the TWR, unbraked TWR, GCWR, GVWR or GAWR.
- If the gross trailer weight is over 2000 lb. (907 kg), a sway control device with sufficient capacity is required.
- If the gross trailer weight is over 5000 lb. (2268 kg), a weight distributing hitch with sufficient capacity is required.
- Adjust the tongue weight within the appropriate range. Place heavier loads as close to the trailer axle as possible.
- Do not exceed 65 mph (104 km/h), the posted towing speed limit or the speed limit for your trailer as set forth in your trailer owner's manual, whichever is lowest. Slow down sufficiently before making a turn, in crosswinds, on wet or slippery surface, etc. to help avoid an accident. If you experience a vehicle-trailer instability from reducing a certain speed, slow down and make sure you keep your vehicle speed under the speed of which you experience the instability.
- Do not make jerky, abrupt or sharp turns.
- Do not apply the brakes suddenly as you may skid, resulting in jackknifing and loss of vehicle control. This is especially true on wet or slippery surfaces.
- Do not exceed the trailer hitch assembly weight, gross vehicle weight, gross axle weight and trailer tongue weight capacities.
- Do not use cruise control when towing.
- Slow down and downshift before descending steep or long downhill grades. Do not make sudden downshifts while descending steep or long downhill grades.
- Vehicle-trailer instability is more likely on steep long down hills. Before descending steep or long downhill grades, slow down and downshift. Do not make sudden downshifts when descending steep or long downhill grades. Avoid holding the brake pedal down too long or applying the brakes too frequently. This could cause the brakes to overheat and result in reduced braking efficiency.

 **WARNING****■ Hitch**

Trailer hitch assemblies have different weight capacities established by the hitch manufacturer. Even though the vehicle may be physically capable of towing a higher weight, the operator must determine the maximum weight rating of the particular hitch assembly and never exceed the maximum weight rating specified for the trailer-hitch. Exceeding the maximum weight rating set by the trailer-hitch manufacturer can cause an accident resulting in death or serious personal injuries.

■ When towing a trailer

Lexus recommends trailers with brakes that conform to any applicable federal and state/provincial regulations.

- If the gross trailer weight exceeds unbraked TWR, trailer brakes are required. Lexus recommends trailers with brakes that conform to all applicable federal and state/provincial regulations.
- Never tap into your vehicle's hydraulic system, as this will lower the vehicle's braking effectiveness.
- Never tow a trailer without using a safety chain securely attached to both the trailer and the vehicle. If damage occurs to the coupling unit or hitch ball, there is danger of the trailer wandering into another lane.

 **NOTICE****■ When installing a trailer hitch**

Use only the position recommended by your Lexus dealer. Do not install the trailer hitch on the bumper; this may cause body damage.

■ Do not directly splice trailer lights

Do not directly splice trailer lights. Directly splicing trailer lights may damage your vehicle's electrical system and cause a malfunction.

Dinghy towing

Your vehicle is not designed to be dinghy towed (with 4 wheels on the ground) behind a motor home.



NOTICE

- **To avoid serious damage to your vehicle**
Do not tow your vehicle with four wheels on the ground.

Engine (ignition) switch

Performing the following operations when carrying the electronic key on your person starts the engine or changes engine switch modes.

Starting the engine

- 1 Check that the parking brake is set.
- 2 Check that the shift lever is set in P.
- 3 Firmly depress the brake pedal.



and a message will be displayed on the multi-information display.

If it is not displayed, the engine cannot be started.

- 4 Press the engine switch shortly and firmly.

When operating the engine switch, one short, firm press is enough.

It is not necessary to press and hold the switch.

The engine will crank until it starts or for up to 30 seconds, whichever is less.

Continue depressing the brake pedal until the engine is completely started.

The engine can be started from any engine switch mode.

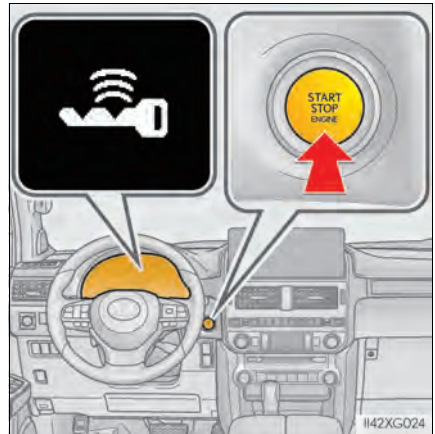

Stopping the engine

- 1 Stop the vehicle.
- 2 Set the parking brake (→P. 212), and shift the shift lever to P.
- 3 Press the engine switch.
- 4 Release the brake pedal and check that “ACCESSORY” or “IGNITION ON” is not shown on the meter.

Changing engine switch modes

Modes can be changed by pressing the engine switch with brake pedal released. (The mode changes each time the switch is pressed.)

- 1 Off*
The emergency flashers can be used.
 - 2 ACCESSORY mode
Some electrical components such as the audio system can be used. “ACCESSORY” will be displayed on the multi-information display.
 - 3 IGNITION ON mode
All electrical components can be used. “IGNITION ON” will be displayed on the multi-information display.
- *: If the shift lever is in a position other than P when turning off the engine, the engine switch will be turned to ACCESSORY mode, not to off.

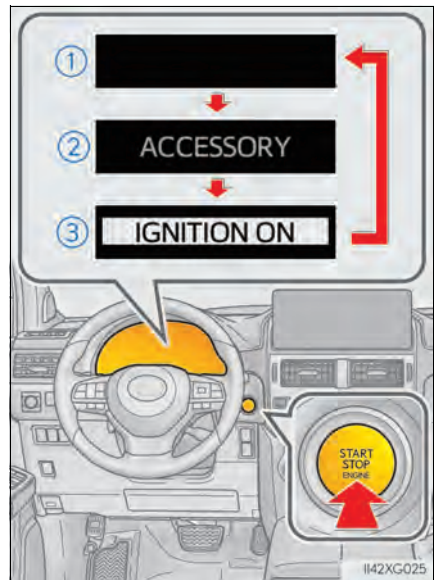

When stopping the engine with the shift lever in a position other than P

If the engine is stopped with the shift lever in a position other than P, the engine switch will not be turned off but instead be turned to ACCESSORY mode. Perform the following procedure to turn the switch off:

- 1 Check that the parking brake is set.
- 2 Shift the shift lever to P.
- 3 Check that "TURN POWER OFF"/"Turn power off" is displayed on the multi-information display and then press the engine switch once.
- 4 Check that "TURN POWER OFF"/"Turn power off" on the multi-information display is off.

■ Auto power off function

When the shift lever is in P, if the vehicle is left in ACCESSORY or IGNITION ON mode with the engine not running for more than 20 minutes (ACCESSORY mode) or one hour (IGNITION ON mode), the engine switch will automatically turn off. However, this function cannot entirely prevent battery discharge. Do not leave the vehicle with the engine switch in ACCESSORY or IGNITION ON mode for long periods of time when the engine is not running.

■ Electronic key battery depletion

→P. 106

■ Conditions affecting operation

→P. 128

■ Note for the entry function

→P. 129

■ If the engine does not start

The engine immobilizer system may not have been deactivated. (→P. 76)

Contact your Lexus dealer.

■ Steering lock

After turning the engine switch off and opening and closing the doors, the steering wheel will be locked due to the steering lock function. Operating the engine switch again automatically cancels the steering lock.

■ When the steering lock cannot be released

“PUSH THE ENGINE SWITCH WHILE TURNING THE STEERING WHEEL IN EITHER DIRECTION”/“Push the engine switch while turning the steering wheel in either direction” will be displayed on the multi-information display.

Check that the shift lever is set in P. Press the engine switch shortly and firmly while turning the steering wheel left and right.

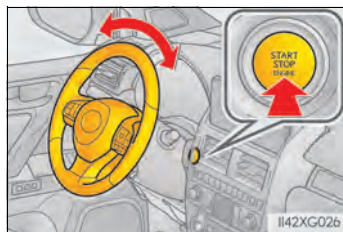

■ Steering lock motor overheating prevention

To prevent the steering lock motor from overheating, the motor may be suspended if the engine is turned on and off repeatedly in a short period of time. In this case, refrain from running the engine. After about 10 seconds, the steering lock motor will resume functioning.

■ When the engine switch indicator flashes in amber

The system may be malfunctioning. Have the vehicle inspected by your Lexus dealer, immediately.

■ If the electronic key battery is depleted

→P. 507

■ Operation of the engine switch

- If the switch is not pressed shortly and firmly, the engine switch mode may not change or the engine may not start.
- If attempting to restart the engine immediately after turning the engine switch off, the engine may not start in some cases. After turning the engine switch off, please wait a few seconds before restarting the engine.

■ Automatic engine shut off feature

- The vehicle is equipped with a feature that automatically shuts off the engine when the shift lever is in P with the engine running for an extended period.
- The engine will automatically shut off after approximately 1 hour if it has been left running while the shift lever is in P.
- The timer for the automatic engine shut off feature will reset if the brake pedal is depressed or if the shift lever is in a position other than P.
- After the vehicle is parked, if the door is locked with the door lock switch (→P. 110) from the inside or the mechanical key (→P. 564) from the outside, the automatic engine shut off feature will be disabled. The timer for the automatic engine shut off feature will be re-enabled if the driver's door is opened.

■ If the smart access system with push-button start has been deactivated in a customized setting

→P. 564

 **WARNING****■ When starting the engine**

Always start the engine while sitting in the driver's seat. Do not depress the accelerator pedal while starting the engine under any circumstances. Doing so may cause an accident resulting in death or serious injury.

■ Caution while driving

If engine failure occurs while the vehicle is moving, do not lock or open the doors until the vehicle reaches a safe and complete stop. Activation of the steering lock in this circumstance may lead to an accident, resulting in death or serious injury.

■ Stopping the engine in an emergency

● If you want to stop the engine in an emergency while driving the vehicle, press and hold the engine switch for more than 2 seconds, or press it briefly 3 times or more in succession. (→P. 525)

However, do not touch the engine switch while driving except in an emergency. Turning the engine off while driving will not cause loss of steering or braking control, but the power assist to these systems will be lost. This will make it more difficult to steer and brake, so you should pull over and stop the vehicle as soon as it is safe to do so.

● If the engine switch is operated while the vehicle is running, a warning message will be shown on the multi-information display and a buzzer sounds.

● When restarting the engine after it was turned off while driving, shift the shift lever to N and press the engine switch.

■ When parking

Exhaust gases include harmful carbon monoxide (CO), which is colorless and odorless. Observe the following precautions.

Failure to do so may cause exhaust gases to enter the vehicle and may lead to an accident caused by light-headedness, or may lead to death or a serious health hazard.

● If the vehicle is in a poorly ventilated area or a closed area, such as a garage, stop the engine.

● Do not leave the vehicle with the engine running for a long time. If such a situation cannot be avoided, park the vehicle in an open space and ensure that exhaust fumes do not enter the vehicle interior.

● Do not leave the engine running in an area with snow build-up, or where it is snowing. If snowbanks build up around the vehicle while the engine is running, exhaust gases may collect and enter the vehicle.

 NOTICE**■ To prevent battery discharge**

- Do not leave the engine switch in ACCESSORY or IGNITION ON mode for long periods of time without the engine running.
- If the indicator on the engine switch is illuminated, the engine switch is not off. When exiting the vehicle, always check that the engine switch is off.
- Do not stop the engine when the shift lever is in a position other than P. If the engine is stopped in another shift lever position, the engine switch will not be turned off but instead be turned to ACCESSORY mode. If the vehicle is left in ACCESSORY mode, battery discharge may occur.

■ When starting the engine

- Do not race a cold engine.
- If the engine becomes difficult to start or stalls frequently, have your vehicle checked by your Lexus dealer immediately.

■ Symptoms indicating a malfunction with the engine switch

If the engine switch seems to be operating somewhat differently than usual, such as the switch sticking slightly, there may be a malfunction. Contact your Lexus dealer immediately.

Automatic transmission

Shifting the shift lever

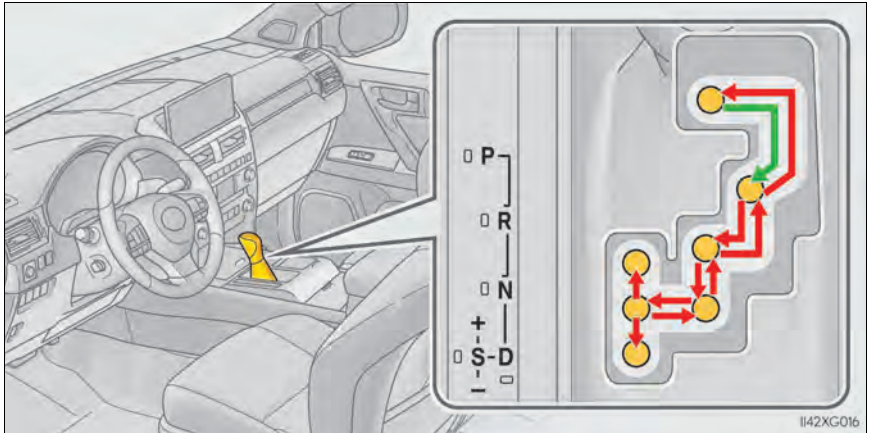

← While the engine switch is in IGNITION ON mode, move the shift lever with the brake pedal depressed.

When shifting the shift lever between P and D, make sure that the vehicle is completely stopped.

Shift position purpose

Shift position	Purpose and condition
P	Parking the vehicle/starting the engine
R	Reversing
N	Neutral (Condition in which the power is not transmitted)
D	Normal driving ^{*1}
S	S mode driving ^{*2} (→P. 207)

^{*1}: Shifting to the D position allows the system to select a gear suitable for the driving conditions. Setting the shift lever to the D position is recommended for normal driving.

^{*2}: Selecting shift ranges using S mode restricts the upper limit of the possible gear ranges, controls engine braking forces, and prevents unnecessary upshifting.

Selecting the second start mode

Use second start mode for accelerating and driving on slippery road surfaces such as snow.

Press the button to use second start mode.

The "2nd STRT" indicator will come on.
Press the button again to cancel second start mode.

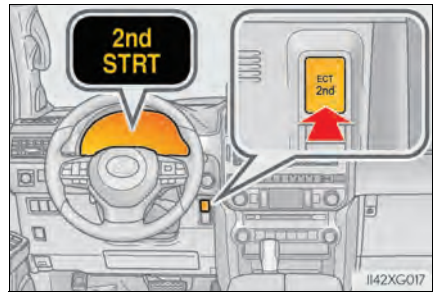

Changing shift ranges in S mode

When the shift lever is in the S position, the shift lever can be operated as follows:

- ① Upshifting
- ② Downshifting

The selected shift range, from 1 to 6, will be displayed in the meter.

The initial shift range in S mode is set automatically to 5 or 4 according to vehicle speed. However, the initial shift range may be set to 3 or 2 if AI-SHIFT has operated while the shift lever was in the D position. (→P. 208)

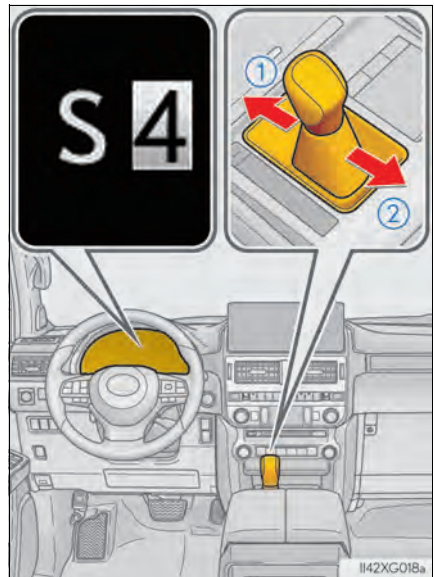

■ Shift ranges and their functions

- You can choose from 6 levels of engine braking force.
- A lower shift range will provide greater engine braking force than a higher shift range, and the engine speed will also increase.

■ Driving on a downhill

On declines, there may be case where the vehicle shifts down automatically to obtain engine braking. As a result of the downshifting, the engine speed may increase.

■ Second start mode automatic deactivation

Second start mode is automatically deactivated if the engine is turned off after driving in second start mode.

■ S mode

When the shift range is 5 or lower, holding the shift lever toward “+” sets the shift range to 6.

■ AI-SHIFT

AI-SHIFT automatically shifts the gear to the suitable position according to driver performance and driving conditions.

AI-SHIFT automatically operates when the shift lever is in the D position. (Shifting the shift lever to the S position cancels the function.)

■ When driving with dynamic radar cruise control activated

Even when performing the following actions with the intent of enabling engine braking, engine braking will not activate because dynamic radar cruise control will not be canceled.

- While driving in S mode, downshifting to 5 or 4. (→P. 255)
- Vehicles with adaptive variable suspension system: When switching the driving mode to sport mode while driving in D position. (→P. 356)

■ Restraining sudden start (Drive-Start Control)

→P. 170

■ Shift lock system

The shift lock system is a system to prevent accidental operation of the shift lever in starting.

The shift lever can be shifted from P only when the engine switch is in the IGNITION ON mode and the brake pedal is being depressed.

■ If the shift lever cannot be shifted from P

First, check whether the brake pedal is being depressed.

If the shift lever cannot be shifted with your foot on the brake pedal, there may be a problem with the shift lock system. Have the vehicle inspected by your Lexus dealer, immediately.

The following steps may be used as an emergency measure to ensure that the shift lever can be shifted.

Releasing the shift lock:

- 1 Set the parking brake.
- 2 Turn the engine switch off.
- 3 Depress the brake pedal.
- 4 Pry the cover up with a flathead screwdriver or tool.

To prevent damage to the cover, cover the tip of the screwdriver with a rag.

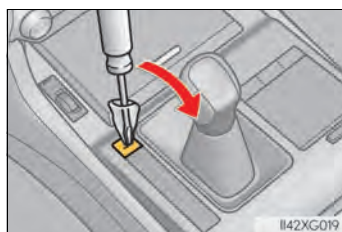

- 5 Press the shift lock override button.
- The shift lever can be shifted while the button is pressed.

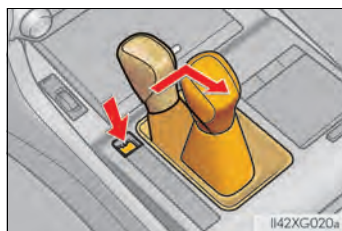

■ If the "S" indicator does not come on even after shifting the shift lever to S

This may indicate a malfunction in the automatic transmission system. Have the vehicle inspected by your Lexus dealer immediately.

(In this situation, the transmission will operate in the same manner as when the shift lever is in D.)

■ Downshift restriction warning buzzer (S mode)

To help ensure safety and driving performance, downshifting operation may sometimes be restricted. In some circumstances, downshifting may not be possible even when the shift lever is operated. (A buzzer will sound twice.)

**WARNING****■ When driving on slippery road surfaces**

Do not accelerate or shift gears suddenly.

Sudden changes in engine braking may cause the vehicle to spin or skid, resulting in an accident.

■ To prevent an accident when releasing the shift lock

Before pressing the shift lock override button, make sure to set the parking brake and depress the brake pedal.

If the accelerator pedal is accidentally depressed instead of the brake pedal when the shift lock override button is pressed and the shift lever is shifted out of P, the vehicle may suddenly start, possibly leading to an accident resulting in death or serious injury.

Turn signal lever

Operating instructions

The turn signal lever can be used to show the following intentions of the driver:

- ① Right turn
- ② Lane change to the right (move the lever partway and then release it)
- ③ Lane change to the left (move the lever partway and then release it)
- ④ Left turn

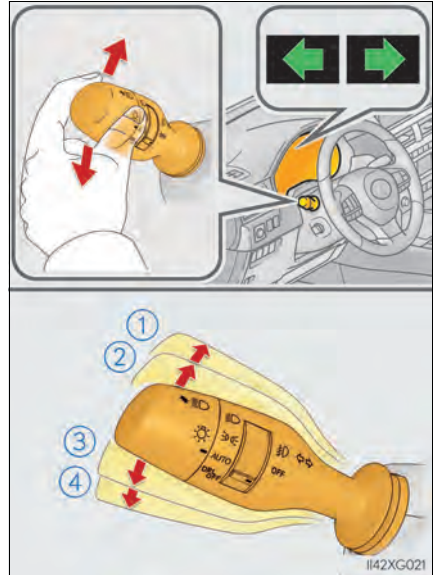

■ Turn signals can be operated when

The engine switch is in IGNITION ON mode.

■ If the indicator flashes faster than usual

Check that a light bulb in the front or rear turn signal lights has not burned out.

■ If the turn signals stop flashing before a lane change has been performed

Operate the lever again.

Parking brake

To set the parking brake, fully depress the parking brake pedal with your left foot while depressing the brake pedal with your right foot. (Depressing the pedal again releases the parking brake.)

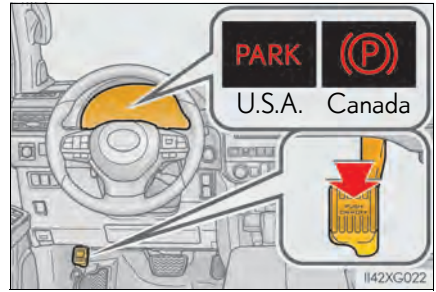

■ Parking the vehicle

→P. 168

■ Parking brake engaged warning buzzer

A buzzer will sound if the vehicle is driven with the parking brake engaged. "Release Parking Brake" is displayed on the multi-information display (with the vehicle reached a speed of 3 mph [5 km/h]).

■ Usage in winter time

→P. 387



NOTICE

■ Before driving

Fully release the parking brake.



Driving the vehicle with the parking brake set will lead to brake components overheating, which may affect braking performance and increase brake wear.

Headlight switch

The headlights can be operated manually or automatically.

Operating instructions

Operating the  switch turns on the lights as follows:

- ①  The side marker, parking, tail, license plate, instrument panel lights, and daytime running lights (→P. 214) turn on.
- ②  The headlights and all the lights listed above (except daytime running lights) turn on.
- ③ AUTO The headlights, daytime running lights (→P. 214) and all the lights listed above turn on and off automatically.
- ④  Off.
(U.S.A. only)

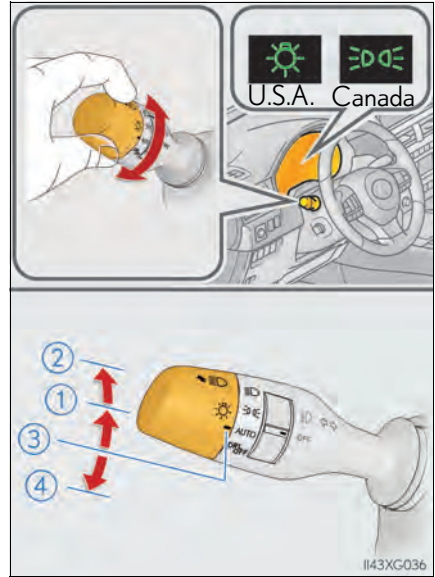

Turning on the high beam headlights

- 1 With the headlights on, push the lever away from you to turn on the high beams.

Pull the lever toward you to the center position to turn the high beams off.

- 2 Pull the lever toward you and release it to flash the high beams once.

You can flash the high beams with the headlights on or off.



Daytime running light system

- The daytime running lights illuminate using the same lights as the parking lights and illuminate brighter than the parking lights.
 - To make your vehicle more visible to other drivers during daytime driving, the daytime running lights turn on automatically when all of the following conditions are met. (The daytime running lights are not designed for use at night.)
 - The engine is running
 - The parking brake is released
 - The headlight switch is in the D or "AUTO"* position
- *: When the surroundings are bright

The daytime running lights remain on after they illuminate, even if the parking brake is set again.

- For the U.S.A.: Daytime running lights can be turned off by operating the switch.
- Compared to turning on the headlights, the daytime running light system offers greater durability and consumes less electricity, so it can help improve fuel economy.

Headlight control sensor



The sensor may not function properly if an object is placed on the sensor, or anything that blocks the sensor is affixed to the windshield.



Doing so interferes with the sensor detecting the level of ambient light and may cause the automatic headlight system to malfunction.



■ Automatic light off system

- When only the tail lights are on: The tail lights turn off automatically if the engine switch is turned off and the driver's door is opened.
- When the headlights are on: The headlights and tail lights turn off 30 seconds after the engine switch is turned off and a door is opened and all of the doors and glass hatch are closed. (The lights turn off immediately if  on the key is pressed after all the doors are closed.)

For the U.S.A.: To turn the lights on again, turn the engine switch to IGNITION ON mode, or turn the light switch off once and then back to  or .

For Canada: To turn the lights on again, turn the engine switch to IGNITION ON mode, or turn the light switch to AUTO position once and then back to  or .

If any of the doors or glass hatch is kept open, the lights automatically turn off after 20 minutes.

■ Automatic headlight leveling system

The level of the headlights is automatically adjusted according to the number of passengers and the loading condition of the vehicle to ensure that the headlights do not interfere with other road users.

■ Welcome lighting

If the headlight switch is turned to AUTO and the surrounding area is dark, unlocking the doors using the smart access system with push-button start or wireless remote control will turn the parking lights and tail lights on automatically.

■ Customization

Settings (e.g. light sensor sensitivity) can be changed.
(Customizable features: →P. 600)

NOTICE

■ To prevent battery discharge

Do not leave the lights on longer than necessary when the engine is not running.

Automatic High Beam

The Automatic High Beam uses an in-vehicle camera sensor to assess the brightness of streetlights, the lights of vehicles ahead etc., and automatically turns the high beam on or off as necessary.

⚠ WARNING

■ Limitations of the Automatic High Beam

Do not rely on the Automatic High Beam. Always drive safely, taking care to observe your surroundings and turning the high beam on or off manually if necessary.

■ To prevent incorrect operation of the Automatic High Beam system

Do not overload the vehicle.

Activating the Automatic High Beam system

- 1 Press the Automatic High Beam switch.

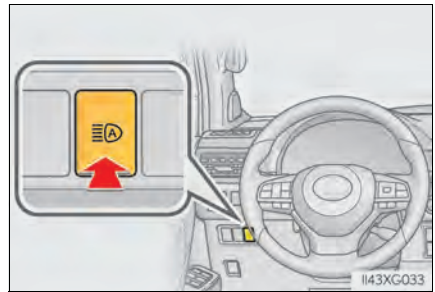

- 2 Turn the headlight switch to the  or AUTO position.

The Automatic High Beam indicator will come on when the system is operating.



Turning the high beam on/off manually

■ Switching to the high beam

Push the lever away from you.

The Automatic High Beam indicator will turn off and the high beam indicator will turn on.

Pull the lever to its original position to activate the Automatic High Beam system again.



■ Switching to the low beam

Press the Automatic High Beam switch.

The Automatic High Beam indicator will turn off.

Press the switch to activate the Automatic High Beam system again.

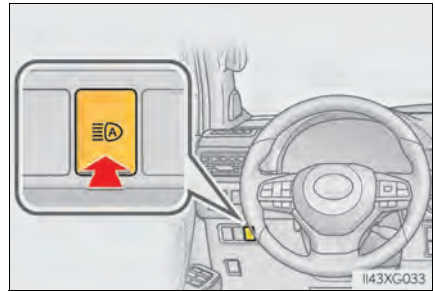

■ Temporarily switching to the low beams

Pull the lever toward you and then return it to its original position.

The high beams are on while the lever is pulled toward you, however, after the lever is returned to its original position, the low beams remain on for a certain amount of time. Afterwards, the Automatic High Beam will be activated again.

■ High beam automatic turning on or off conditions

- When all of the following conditions are fulfilled, the high beam will be automatically turned on (after approximately 1 second):
 - Vehicle speed is above approximately 21 mph (34 km/h).
 - The area ahead of the vehicle is dark.
 - There are no vehicles ahead with headlights or tail lights turned on.
 - There are few streetlights on the road ahead.
- If any of the following conditions are fulfilled, the high beam will be automatically turned off:
 - Vehicle speed drops below approximately 17 mph (27 km/h).
 - The area ahead of the vehicle is not dark.
 - Vehicles ahead have headlights or tail lights turned on.
 - There are many streetlights on the road ahead.

■ Camera sensor detection information

- The high beam may not be automatically turned off in the following situations:
 - When oncoming vehicles suddenly appear from a curve
 - When the vehicle is cut in front of by another vehicle
 - When vehicles ahead are hidden from sight due to repeated curves, road dividers or roadside trees
 - When vehicles ahead appear from the faraway lane on wide road
 - When vehicles ahead have no lights
- The high beam may be turned off if a vehicle ahead that is using fog lights without using the headlights is detected.
- House lights, street lights, traffic signals, and illuminated billboards or signs may cause the high beam to switch to the low beams, or the low beams to remain on.
- The following factors may affect the amount of time taken to turn the high beam on or off:
 - The brightness of headlights, fog lights, and tail lights of vehicles ahead
 - The movement and direction of vehicles ahead
 - When a vehicle ahead only has operational lights on one side
 - When a vehicle ahead is a two-wheeled vehicle
 - The condition of the road (gradient, curve, condition of the road surface etc.)
 - The number of passengers and amount of luggage
- The high beam may be turned on or off when the driver does not expect it.
- Bicycles or similar objects may not be detected.

- In the situations shown below, the system may not be able to accurately detect surrounding brightness levels. This may cause the low beams to remain on or the high beams to cause problems for pedestrians, vehicles ahead or other parties. In these cases, manually switch between the high and low beams.
 - In bad weather (rain, snow, fog, sandstorms etc.)
 - The windshield is obscured by fog, mist, ice, dirt etc.
 - The windshield is cracked or damaged.
 - The camera sensor is deformed or dirty.
 - The camera sensor temperature is extremely high.
 - Surrounding brightness levels are equal to those of headlights, tail lights or fog lights.
 - Vehicles ahead have headlights that are either switched off, dirty, are changing color, or are not aimed properly.
 - When driving through an area of intermittently changing brightness and darkness.
 - When frequently and repeatedly driving ascending/descending roads, or roads with rough, bumpy or uneven surfaces (such as stone-paved roads, gravel tracks etc.).
 - When frequently and repeatedly taking curves or driving on a winding road.
 - There is a highly reflective object ahead of the vehicle, such as a sign or a mirror.
 - The back of a vehicle ahead is highly reflective, such as a container on a truck.
 - The vehicle's headlights are damaged or dirty.
 - The vehicle is listing or tilting, due to a flat tire, a trailer being towed etc.
 - The high beam and low beam are repeatedly being switched between in an abnormal manner.
 - The driver believes that the high beam may be causing problems or distress to other drivers or pedestrians nearby.

■ Temporarily lowering sensor sensitivity

The sensitivity of the sensor can be temporarily lowered.

- 1 Turn the engine switch off while the following conditions are met.
 - The headlight switch is in AUTO or .
 - The headlight switch lever is in the original position.
 - Automatic High Beam switch is on.
- 2 Turn the engine switch to IGNITION ON mode.
- 3 Within 60 seconds after step 2, repeat pushing the headlight switch lever to the high beam position then pulling it to the original position quickly 10 times, then leave the lever in the original position.
- 4 If the sensitivity is changed, the Automatic High Beam indicator turns on and off 3 times.

■ Temporarily switching to the low beams

It is recommended to switch to the low beams when the high beam may cause problems or distress to other drivers or pedestrians nearby.

Fog light switch *

The fog lights secure excellent visibility in difficult driving conditions, such as in rain and fog.

- ① OFF *1 or ○ *2
Turns the fog lights off
- ②  Turns the fog lights on

*1: For the U.S.A.

*2: For Canada

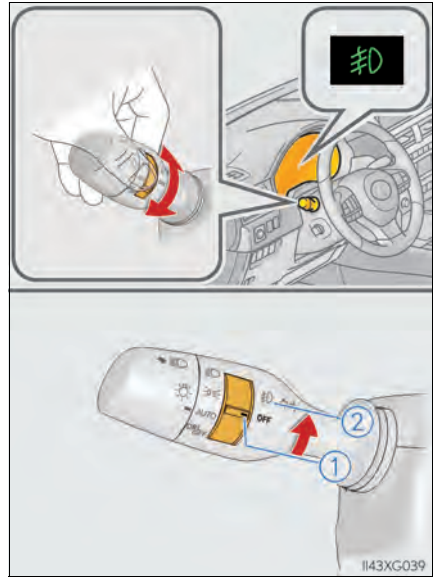

■ Fog lights can be used when

The headlights are on in low beam.

NOTICE

■ To prevent battery discharge

Do not leave the lights on longer than necessary when the engine is not running.

Windshield wipers and washer

Operating the wiper lever

Operating the  lever operates the wipers or washer as follows.

► Intermittent windshield wipers with interval adjuster

- ① **OFF** Off
- ② **INT** Intermittent operation
- ③ **LO** Low speed operation
- ④ **HI** High speed operation
- ⑤ **MIST** Temporary operation

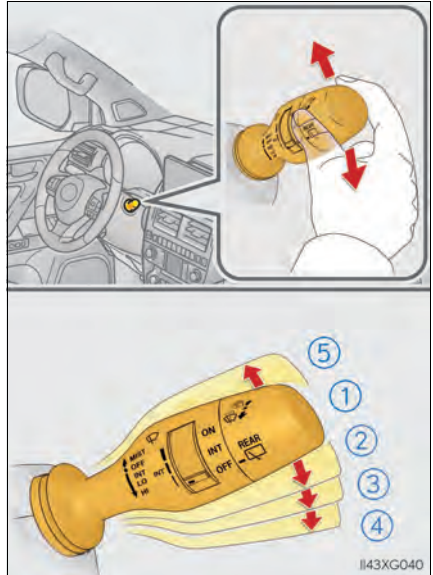

Wiper intervals can be adjusted when intermittent operation is selected.

- ⑥ Increases the intermittent windshield wiper frequency
- ⑦ Decreases the intermittent windshield wiper frequency

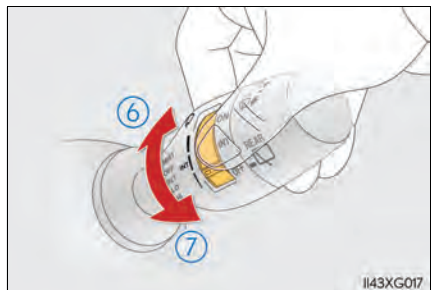





- ⑧  Washer/wiper dual operation

Pulling the lever operates the wipers and washer.

The wipers will automatically operate a couple of times after the washer squirts.

Vehicles with headlight cleaners: If the headlights are on, the headlight cleaners will operate once.

- Rain-sensing windshield wipers

- ① **OFF** *1 or  *2 Off
- ② **AUTO** Rain-sensing operation
- ③ **LO** *1 or  *2
Low speed operation
- ④ **HI** *1 or  *2
High speed operation
- ⑤ **MIST** *1 or  *2
High speed operation

*1: For the U.S.A.

*2: For Canada

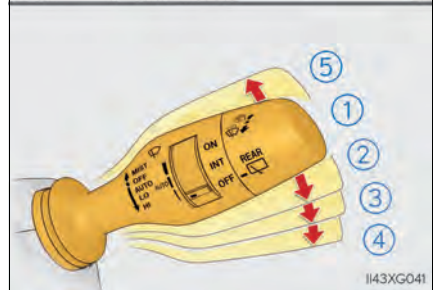
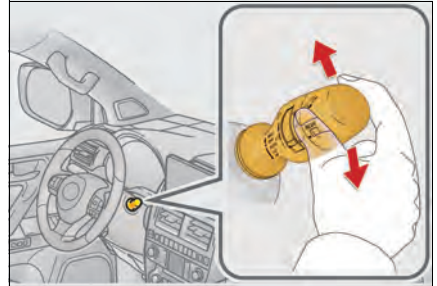
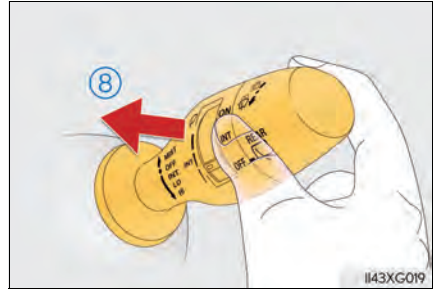

When "AUTO" is selected, the wipers will operate automatically when the sensor detects falling rain. The system automatically adjusts wiper timing in accordance with rain volume and vehicle speed.

The sensor sensitivity can be adjusted when “AUTO” is selected.

- ⑥ Increases the sensitivity
- ⑦ Decreases the sensitivity

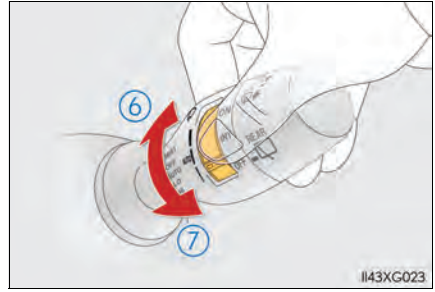

- ⑧  Washer/wiper dual operation

Pulling the lever operates the wipers and washer.

The wipers operate automatically. (After operating several times, the wipers operate one more time after a short delay to prevent dripping.)

Vehicles with headlight cleaners: If the headlights are on, the headlight cleaners will operate once.

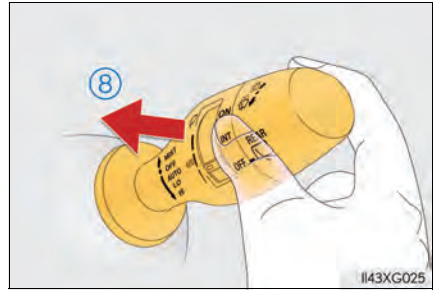

■ The windshield wiper and washer can be operated when

The engine switch is in IGNITION ON mode.

■ Raindrop sensor (vehicles with rain-sensing windshield wipers)

- The raindrop sensor judges the amount of raindrops.

An optical sensor is adopted. It may not operate properly when sunlight from the rising or setting of the sun intermittently strikes the windshield, or if bugs etc. are present on the windshield.

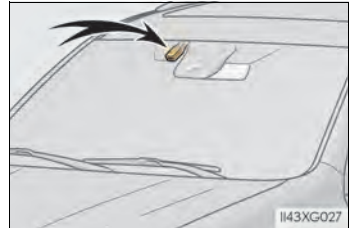

- If the wiper switch is turned to the “AUTO” position while the engine switch is in IGNITION ON mode, the wipers will operate once to show that “AUTO” mode is activated.
- When the sensor sensitivity ring is turned toward high while in “AUTO” mode, the wipers will operate once to indicate that the sensor sensitivity is enhanced.
- If the temperature of the rain drop sensor is 194°F (90°C) or higher, or 5°F (-15°C) or lower, the automatic operation may not occur. In this case, operate the wipers in any mode other than “AUTO”.

■ **Effects of vehicle speed on wiper operation (vehicles with rain-sensing windshield wipers)**

With the settings other than "AUTO" also, the time until drip prevention wiper sweep occurs is changed depending on vehicle speed.

With the low speed wiper operation selected, wiper operation will be switched from low speed to intermittent wiper operation only when the vehicle is stationary. (However, when the sensor sensitivity is adjusted to the highest level, the mode cannot be switched.)

■ **If no windshield washer fluid sprays**

Check that the washer nozzles are not blocked if there is washer fluid in the windshield washer fluid reservoir.



WARNING

■ **Caution regarding the use of windshield wipers in "AUTO" mode (vehicles with rain-sensing windshield wipers)**

The windshield wipers may operate unexpectedly if the sensor is touched or the windshield is subject to vibration in "AUTO" mode. Take care that your fingers etc. anything else does not become caught in the windshield wipers.

■ **Caution regarding the use of washer fluid**

When it is cold, do not use the washer fluid until the windshield becomes warm. The fluid may freeze on the windshield and cause low visibility. This may lead to an accident, resulting in death or serious injury.



NOTICE

■ **When the windshield is dry**

Do not use the wipers, as they may damage the windshield.

■ **When the washer fluid tank is empty**

Do not operate the switch continually as the washer fluid pump may overheat.

■ **When there is no washer fluid spray from the nozzle**

Damage to the washer fluid pump may be caused if the lever is pulled toward you and held continually.

■ **When a nozzle becomes blocked**

In this case, contact your Lexus dealer.

Do not try to clear it with a pin or other object. The nozzle will be damaged.

Rear window wiper and washer

Operating the  switch operates the rear wiper as follows.

① **OFF** *1 or  *2 Off

② **INT** *1 or  *2
Intermittent operation

③ **ON** *1 or  *2
Normal operation

*1: For the U.S.A.

*2: For Canada

④  Washer/wiper dual operation

Pushing the lever operates the wiper and washer.

The wipers will automatically operate a couple of times after the washer squirts.

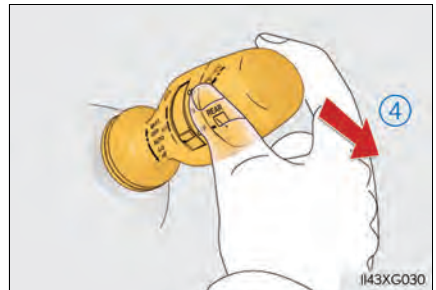
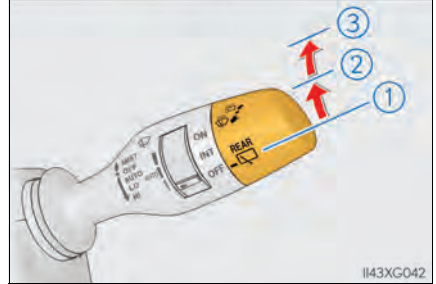

■ The rear window wiper and washer can be operated when

- The engine switch is in IGNITION ON mode.
- The glass hatch is closed.

■ If no windshield washer fluid sprays

Check that the washer nozzles are not blocked if there is washer fluid in the windshield washer fluid reservoir.



NOTICE

■ When the rear window is dry

Do not use the wiper, as it may damage the rear window.

■ When the washer fluid tank is empty

Do not operate the switch continually as the washer fluid pump may overheat.

Headlight cleaner switch *

Washer fluid can be sprayed on the headlights.

Press the switch to clean the headlights.

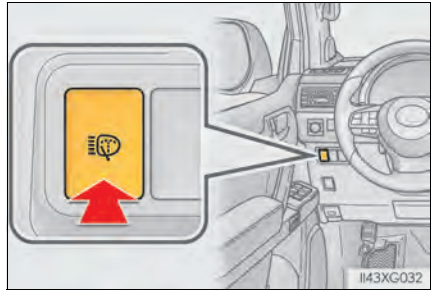

■ The headlight cleaners can be operated when

The engine switch is in IGNITION ON mode and the headlight switch is turned on.

■ Windshield washer linked operation

When the windshield washer is operated with the engine switch in IGNITION ON mode and the headlights on, the headlight cleaners will operate once. (→P. 221)

⚠ NOTICE

■ When the washer fluid tank is empty

Do not press the switch continually as the washer fluid pump may overheat.

Opening the fuel tank cap

Perform the following steps to open the fuel tank cap.

Before refueling the vehicle

- Turn the engine switch off and ensure that all the doors and windows are closed.
- Confirm the type of fuel.

■ Fuel types

→P. 586

■ Fuel tank opening for unleaded gasoline

To help prevent incorrect fueling, your Lexus has a fuel tank opening that only accommodates the special nozzle on unleaded fuel pumps.

■ If the malfunction indicator lamp illuminates

The malfunction indicator lamp may illuminate erroneously if refueling is performed repeatedly when the fuel tank is nearly full.

 **WARNING****■ When refueling the vehicle**

Observe the following precautions while refueling the vehicle. Failure to do so may result in death or serious injury.

- After exiting the vehicle and before opening the fuel door, touch an unpainted metal surface to discharge any static electricity. It is important to discharge static electricity before refueling because sparks resulting from static electricity can cause fuel vapors to ignite while refueling.
- Always hold the grips on the fuel tank cap and turn it slowly to remove it. A whooshing sound may be heard when the fuel tank cap is loosened. Wait until the sound cannot be heard before fully removing the cap. In hot weather, pressurized fuel may spray out of the filler neck and cause injury.
- Do not allow anyone that has not discharged static electricity from their body to come close to an open fuel tank.
- Do not inhale vaporized fuel. Fuel contains substances that are harmful if inhaled.
- Do not smoke while refueling the vehicle. Doing so may cause the fuel to ignite and cause a fire.
- Do not return to the vehicle or touch any person or object that is statically charged. This may cause static electricity to build up, resulting in a possible ignition hazard.

■ When refueling

Observe the following precautions to prevent fuel overflowing from the fuel tank:

- Securely insert the fuel nozzle into the fuel filler neck.
- Stop filling the tank after the fuel nozzle automatically clicks off.
- Do not top off the fuel tank.

 **NOTICE****■ Refueling**

Do not spill fuel during refueling.

Doing so may damage the vehicle, such as causing the emission control systems to operate abnormally or damaging fuel system components or the vehicle's painted surface.

Opening the fuel tank cap

- 1 Press the opener to open the fuel filler door.

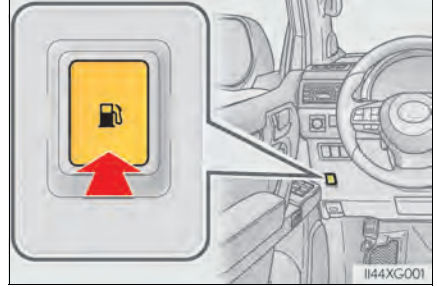

- 2 Turn the fuel tank cap slowly to open, and hang the fuel tank cap on the back of the fuel filler door.

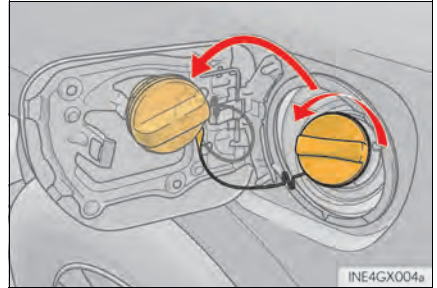

■ **When the fuel filler door cannot be opened by pressing the inside switch**

Remove the cover inside the luggage compartment and pull the lever.

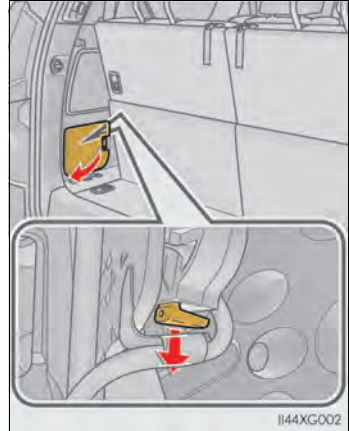

Closing the fuel tank cap

After refueling, turn the fuel tank cap until you hear a click. Once the cap is released, it will turn slightly in the opposite direction.

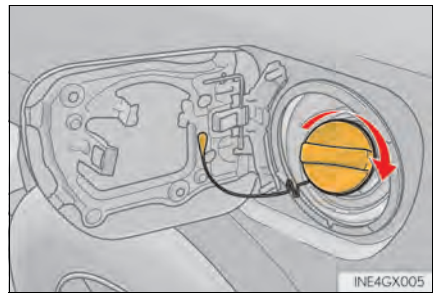

WARNING

■ **When replacing the fuel tank cap**

Do not use anything but a genuine Lexus fuel tank cap designed for your vehicle. Doing so may cause a fire or other incident which may result in death or serious injury.

Lexus Safety System +

The Lexus Safety System + consists of the following drive assist systems and contributes to a safe and comfortable driving experience:

Driving assist system

◆ PCS (Pre-Collision System)

→P. 237

◆ LDA (Lane Departure Alert)

→P. 247

◆ AHB (Automatic High Beam)

→P. 216

◆ Dynamic radar cruise control

→P. 255



WARNING

■ Lexus Safety System +

The Lexus Safety System + is designed to operate under the assumption that the driver will drive safely, and is designed to help reduce the impact to the occupants and the vehicle in the case of a collision or assist the driver in normal driving conditions.

As there is a limit to the degree of recognition accuracy and control performance that this system can provide, do not overly rely on this system. The driver is always responsible for paying attention to the vehicle's surroundings and driving safely.

Sensors

Two types of sensors, located behind the front grille and windshield, detect information necessary to operate the drive assist systems.

- ① Radar sensor
- ② Front camera

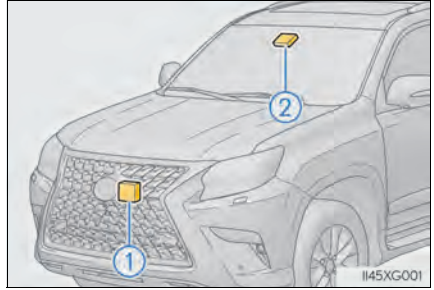

WARNING

■ To avoid malfunction of the radar sensor

Observe the following precautions.

Otherwise, the radar sensor may not operate properly, possibly leading to an accident resulting in death or serious injury.

- Keep the radar sensor and the radar sensor cover clean at all times.

- ① Radar sensor
- ② Radar sensor cover

If the front of the radar sensor or the front or back of the radar sensor cover is dirty or covered with water droplets, snow, etc., clean it.

Clean the radar sensor and radar sensor cover with a soft cloth to avoid damaging them.

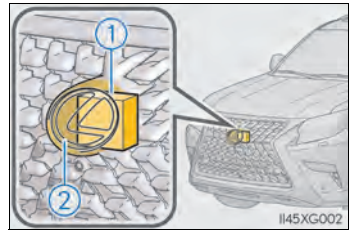

- Do not attach accessories, stickers (including transparent stickers) or other items to the radar sensor, radar sensor cover or surrounding area.
- Do not subject the radar sensor or its surrounding area to a strong impact. If the radar sensor, front grille, or front bumper has been subjected to a strong impact, have the vehicle inspected by your Lexus dealer.
- Do not disassemble the radar sensor.
- Do not modify or paint the radar sensor or radar sensor cover.
- In the following cases, the radar sensor must be recalibrated. Contact your Lexus dealer for details.
 - When the radar sensor or front grille are removed and installed, or replaced
 - When the front bumper is replaced

⚠ WARNING

■ To avoid malfunction of the front camera

Observe the following precautions.

Otherwise, the front camera may not operate properly, possibly leading to an accident resulting in death or serious injury.

● Keep the windshield clean at all times.

- If the windshield is dirty or covered with an oily film, water droplets, snow, etc., clean the windshield.
- If a glass coating agent is applied to the windshield, it will still be necessary to use the windshield wipers to remove water droplets, etc. from the area of the windshield in front of the front camera.
- If the inner side of the windshield where the front camera is installed is dirty, contact your Lexus dealer.

● Do not attach objects, such as stickers, transparent stickers, etc., to the outer side of the windshield in front of the front camera (shaded area in the illustration).

A: From the top of the windshield to approximately 0.4 in. (1 cm) below the bottom of the front camera

B: Approximately 7.9 in. (20 cm) (Approximately 4.0 in. [10 cm] to the right and left from the center of the front camera)

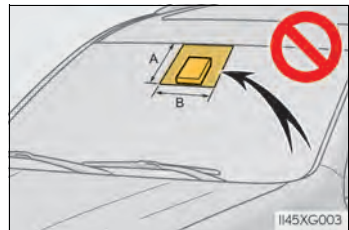

- If the part of the windshield in front of the front camera is fogged up or covered with condensation or ice, use the windshield defogger to remove the fog, condensation or ice. (→P. 408)
- If water droplets cannot be properly removed from the area of the windshield in front of the front camera by the windshield wipers, replace the wiper insert or wiper blade.
- Do not attach window tint to the windshield.
- Replace the windshield if it is damaged or cracked.
After replacing the windshield, the front camera must be recalibrated. Contact your Lexus dealer for details.
- Do not allow liquids to contact the front camera.
- Do not allow bright lights to shine into the front camera.
- Do not dirty or damage the front camera.
When cleaning the inside of the windshield, do not allow glass cleaner to contact the lens of the front camera. Also, do not touch the lens.
If the lens is dirty or damaged, contact your Lexus dealer.
- Do not subject the front camera to a strong impact.
- Do not change the installation position or direction of the front camera or remove it.
- Do not disassemble the front camera.

 **WARNING**

- Do not modify any components of the vehicle around the front camera (inside rear view mirror, etc.) or ceiling.
- Do not attach any accessories to the hood, front grille or front bumper that may obstruct the front camera. Contact your Lexus dealer for details.
- If a surfboard or other long object is to be mounted on the roof, make sure that it will not obstruct the front camera.
- Do not modify the headlights or other lights.

■ If a warning message is displayed on the multi-information display

A system may be temporarily unavailable or there may be a malfunction in the system

- In the following situations, perform the actions specified in the table. When the normal operating conditions are detected, the message will disappear and the system will become operational.

If the message does not disappear, contact your Lexus dealer.

Situation	Actions
When the area around a camera is covered with dirt, moisture (fogged up, covered with condensation, ice, etc.), or other foreign matter	Using the wiper and A/C function, remove the dirt and other attached matter. (→P. 408)
When the temperature around the front camera is outside of the operational range, such as when the vehicle is in the sun or in an extremely cold environment	If the front camera is hot, such as after the vehicle had been parked in the sun, use the air conditioning system to decrease the temperature around the front camera. If a sunshade was used when the vehicle was parked, depending on its type, the sunlight reflected from the surface of the sunshade may cause the temperature of the front camera to become excessively high.
	If the front camera is cold, such after the vehicle is parked in an extremely cold environment, use the air conditioning system to increase the temperature around the front camera.
The area in front of the front camera is obstructed, such as when the hood is open or a sticker is attached to the part of the windshield in front of the front camera.	Close the hood, remove the sticker, etc. to clear the obstruction.
When "Pre-Collision System Unavailable" is displayed.	Check whether there is attached materials on the radar sensor and radar sensor cover, and if there is, remove it.

- In the following situations, if the situation has changed (or the vehicle has been driven for some time) and the normal operating conditions are detected, the message will disappear and the system will become operational.

If the message does not disappear, contact your Lexus dealer.

- When the temperature around the radar sensor is outside of the operational range, such as when the vehicle is in the sun or in an extremely cold environment
- When the front camera cannot detect objects in front of the vehicle, such as when driving in the dark, snow, or fog, or when bright lights are shining into the front camera
- Depending on the conditions in the vicinity of the vehicle, the radar may judge the surrounding environment can not be properly recognized. In that case, "Pre-Collision System Unavailable" is displayed.

PCS (Pre-Collision System)

The pre-collision system uses a radar sensor and front camera to detect vehicles and pedestrians in front of your vehicle. When the system determines that the possibility of a frontal collision with a vehicle or pedestrian is high, a warning operates to urge the driver to take evasive action and the potential brake pressure is increased to help the driver avoid the collision. If the system determines that the possibility of a frontal collision with a vehicle or pedestrian is extremely high, the brakes are automatically applied to help avoid the collision or help reduce the impact of the collision.

The pre-collision system can be disabled/enabled and the warning timing can be changed. (→P. 240)

◆ Pre-collision warning

When the system determines that the possibility of a frontal collision is high, a buzzer will sound and a warning message will be displayed on the multi-information display to urge the driver to take evasive action.

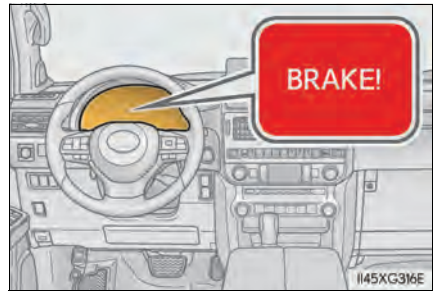

◆ Pre-collision brake assist

When the system determines that the possibility of a frontal collision is high, the system applies greater braking force in relation to how strongly the brake pedal is depressed.

◆ Pre-collision braking

When the system determines that the possibility of a frontal collision is high, the system warns the driver. If the system determines that the possibility of a frontal collision is extremely high, the brakes are automatically applied to help avoid the collision or reduce the collision speed.

◆ Suspension control (if equipped)

When the system determines that the possibility of a frontal collision is high, the Adaptive Variable Suspension System (→P. 356) will control the damping force of the shock absorbers to help maintain an appropriate vehicle posture.

WARNING

■ Limitations of the pre-collision system

- The driver is solely responsible for safe driving. Always drive safely, taking care to observe your surroundings.
Do not use the pre-collision system instead of normal braking operations under any circumstances. This system will not prevent collisions or lessen collision damage or injury in every situation. Do not overly rely on this system. Failure to do so may lead to an accident, resulting in death or serious injury.
- Although this system is designed to help avoid a collision or help reduce the impact of the collision, its effectiveness may change according to various conditions, therefore the system may not always be able to achieve the same level of performance.
Read the following conditions carefully. Do not overly rely on this system and always drive carefully.
 - Conditions under which the system may operate even if there is no possibility of a collision: →P. 242
 - Conditions under which the system may not operate properly: →P. 244
- Do not attempt to test the operation of the pre-collision system yourself.
Depending on the objects used for testing (dummies, cardboard objects imitating detectable objects, etc.), the system may not operate properly, possibly leading to an accident.

 **WARNING****■ Pre-collision braking**

- When the pre-collision braking function is operating, a large amount of braking force will be applied.
- If the vehicle is stopped by the operation of the pre-collision braking function, the pre-collision braking function operation will be canceled after approximately 2 seconds. Depress the brake pedal as necessary.
- The pre-collision braking function may not operate if certain operations are performed by the driver. If the accelerator pedal is being depressed strongly or the steering wheel is being turned, the system may determine that the driver is taking evasive action and possibly prevent the pre-collision braking function from operating.
- In some situations, while the pre-collision braking function is operating, operation of the function may be canceled if the accelerator pedal is depressed strongly or the steering wheel is turned and the system determines that the driver is taking evasive action.
- If the brake pedal is being depressed, the system may determine that the driver is taking evasive action and possibly delay the operation timing of the pre-collision braking function.

■ When to disable the pre-collision system

In the following situations, disable the system, as it may not operate properly, possibly leading to an accident resulting in death or serious injury:

- When the vehicle is being towed
- When your vehicle is towing another vehicle
- When transporting the vehicle via truck, boat, train or similar means of transportation
- When the vehicle is raised on a lift with the engine running and the tires are allowed to rotate freely
- When inspecting the vehicle using a drum tester such as a chassis dynamometer or speedometer tester, or when using an on vehicle wheel balancer
- When a strong impact is applied to the front bumper or front grille, due to an accident or other reasons
- If the vehicle cannot be driven in a stable manner, such as when the vehicle has been in an accident or is malfunctioning
- When the vehicle is driven in a sporty manner or off-road
- When the tires are not properly inflated
- When the tires are very worn
- When tires of a size other than specified are installed
- When tire chains are installed
- When a compact spare tire or an emergency tire puncture repair kit is used
- If equipment (snow plow, etc.) that may obstruct the radar sensor or front camera is temporarily installed to the vehicle

Changing settings of the pre-collision system

■ Enabling/disabling the pre-collision system

The pre-collision system can be enabled/disabled on  (→P. 91) of the multi-information display.

The system is automatically enabled each time the engine switch is turned to IGNITION ON mode.

If the system is disabled, the PCS warning light will turn on and a message will be displayed on the multi-information display.

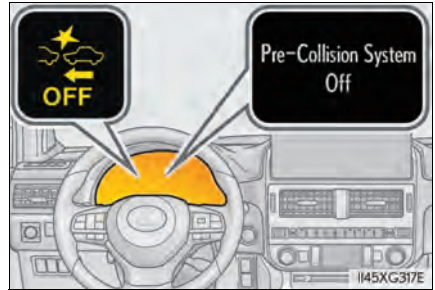

■ Changing the pre-collision warning timing

The pre-collision warning timing can be changed on  (→P. 91) of the multi-information display.

The operation timing setting is retained when the engine switch is turned off.

① Far

The warning will begin to operate earlier than with the default timing.

② Middle

This is the default setting.

③ Near

The warning will begin to operate later than with the default timing.

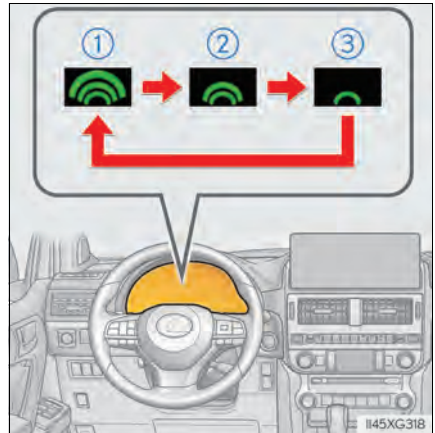

■ Operational conditions

The pre-collision system is enabled and the system determines that the possibility of a frontal collision with a vehicle or pedestrian is high.

Each function is operational at the following speeds:

- Pre-collision warning:
 - Vehicle speed is between approximately 7 and 110 mph (10 and 180 km/h). (For detecting a pedestrian, vehicle speed is between approximately 7 and 50 mph [10 and 80 km/h].)
 - The relative speed between your vehicle and the vehicle or pedestrian ahead is approximately 7 mph (10 km/h) or more.
- Pre-collision brake assist:
 - Vehicle speed is between approximately 20 and 110 mph (30 and 180 km/h). (For detecting a pedestrian, vehicle speed is between approximately 20 and 50 mph [30 and 80 km/h].)
 - The relative speed between your vehicle and the vehicle or pedestrian ahead is approximately 20 mph (30 km/h) or more.
- Pre-collision braking:
 - Vehicle speed is between approximately 7 and 110 mph (10 and 180 km/h). (For detecting a pedestrian, vehicle speed is between approximately 7 and 50 mph [10 and 80 km/h].)
 - The relative speed between your vehicle and the vehicle or pedestrian ahead is approximately 7 mph (10 km/h) or more.

The system may not operate in the following situations:

- If a battery terminal has been disconnected and reconnected and then the vehicle has not been driven for a certain amount of time
- If the shift lever is in R
- If VSC is disabled (only the pre-collision warning function will be operational)
- If the low speed four-wheel drive indicator is illuminated (only the pre-collision warning function will be operational)

■ Pedestrian detection function

The pre-collision system detects pedestrians based on the size, profile, and motion of a detected object. However, a pedestrian may not be detected depending on the surrounding brightness and the motion, posture, and angle of the detected object, preventing the system from operating properly. (→P. 246)



■ Cancellation of the pre-collision braking

If either of the following occur while the pre-collision braking function is operating, it will be canceled:

- The accelerator pedal is depressed strongly.
- The steering wheel is turned sharply or abruptly.

■ Conditions under which the system may operate even if there is no possibility of a collision

- In some situations such as the following, the system may determine that there is a possibility of a frontal collision and operate.
 - When passing a vehicle or pedestrian
 - When changing lanes while overtaking a preceding vehicle
 - When overtaking a preceding vehicle that is changing lanes
 - When overtaking a preceding vehicle that is making a left/right turn

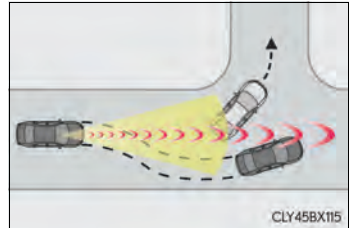

- When passing a vehicle in an oncoming lane that is stopped to make a right/left turn

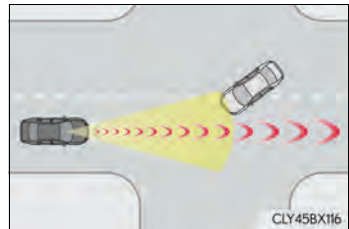

- When driving on a road where relative location to vehicle ahead in an adjacent lane may change, such as on a winding road

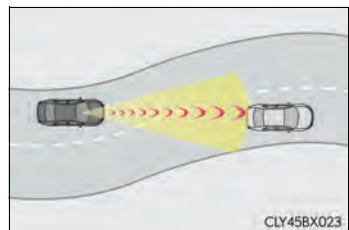

- When rapidly closing on a vehicle ahead

- If the front of the vehicle is raised or lowered, such as when the road surface is uneven or undulating
- When approaching objects on the roadside, such as guardrails, utility poles, trees, or walls
- When there is a vehicle, pedestrian, or object by the roadside at the entrance of a curve

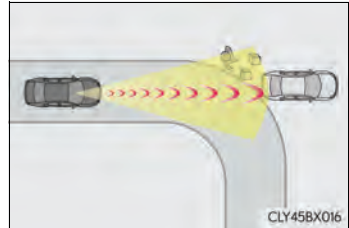

- When driving on a narrow path surrounded by a structure, such as in a tunnel or on an iron bridge
- When there is a metal object (manhole cover, steel plate, etc.), steps, or a protrusion on the road surface or roadside
- When a crossing pedestrian approaches very close to the vehicle

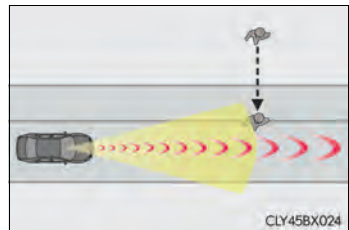

- When passing through a place with a low structure above the road (low ceiling, traffic sign, etc.)



- When passing under an object (billboard, etc.) at the top of an uphill road

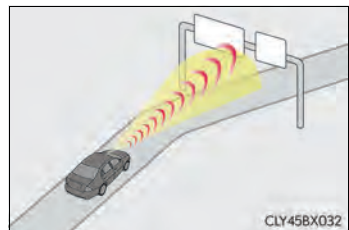

- When rapidly closing on an electric toll gate barrier, parking area barrier, or other barrier that opens and closes
- When using an automatic car wash

- When driving through or under objects that may contact the vehicle, such as thick grass, tree branches, or a banner

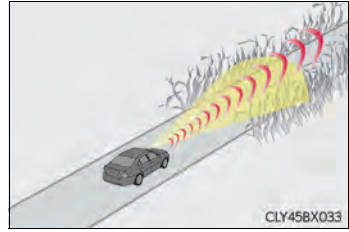

- When the vehicle is hit by water, snow, dust, etc. from a vehicle ahead
- When driving through steam or smoke
- When there are patterns or paint on the road or a wall that may be mistaken for a vehicle or pedestrian
- When driving near an object that reflects radio waves, such as a large truck or guardrail
- When driving near a TV tower, broadcasting station, electric power plant, or other location where strong radio waves or electrical noise may be present

■ Situations in which the system may not operate properly

- In some situations such as the following, a vehicle may not be detected by the radar sensor and front camera, preventing the system from operating properly:
 - If an oncoming vehicle is approaching your vehicle
 - If a vehicle ahead is a motorcycle or bicycle
 - When approaching the side or front of a vehicle
 - If a preceding vehicle has a small rear end, such as an unloaded truck
 - If a preceding vehicle has a low rear end, such as a low bed trailer

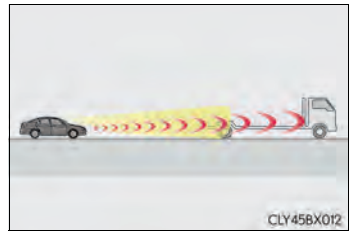

- If a vehicle ahead is carrying a load which protrudes past its rear bumper
- If a vehicle ahead has extremely high ground clearance

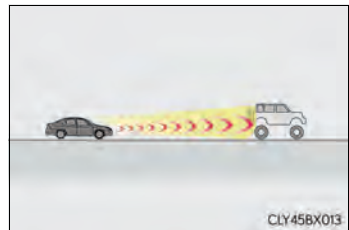

- If a vehicle ahead is irregularly shaped, such as a tractor or side car
- If the sun or other light is shining directly on a vehicle ahead
- If a vehicle cuts in front of your vehicle or emerges from beside a vehicle
- If a vehicle ahead makes an abrupt maneuver (such as sudden swerving, acceleration or deceleration)
- When suddenly cutting behind a preceding vehicle

- When a vehicle ahead is not directly in front of your vehicle

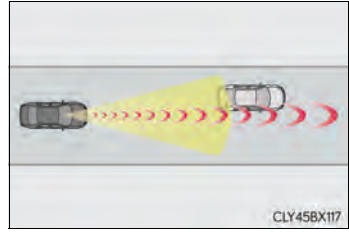

- When driving in inclement weather such as heavy rain, fog, snow or a sandstorm
- When the vehicle is hit by water, snow, dust, etc. from a vehicle ahead
- When driving through steam or smoke
- When driving in a place where the surrounding brightness changes suddenly, such as at the entrance or exit of a tunnel
- When a very bright light, such as the sun or the headlights of oncoming traffic, shines directly into the front camera
- When the surrounding area is dim, such as at dawn or dusk, or while at night or in a tunnel
- After the engine has started the vehicle has not been driven for a certain amount of time
- While making a left/right turn and for a few seconds after making a left/right turn
- While driving on a curve and for a few seconds after driving on a curve
- If your vehicle is skidding
- If the front of the vehicle is raised or lowered

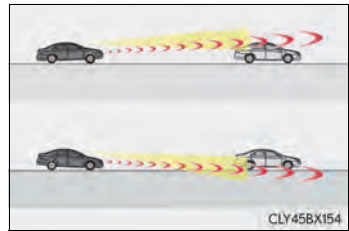

- If the wheels are misaligned
- If a wiper blade is blocking the front camera
- The vehicle is wobbling.
- The vehicle is being driven at extremely high speeds.
- When driving on a hill
- If the radar sensor or front camera is misaligned
- In some situations such as the following, sufficient braking force may not be obtained, preventing the system from performing properly:
 - If the braking functions cannot operate to their full extent, such as when the brake parts are extremely cold, extremely hot, or wet
 - If the vehicle is not properly maintained (brakes or tires are excessively worn, improper tire inflation pressure, etc.)
 - When the vehicle is being driven on a gravel road or other slippery surface

- Some pedestrians such as the following may not be detected by the radar sensor and front camera, preventing the system from operating properly:
 - Pedestrians shorter than approximately 3.2 ft. (1 m) or taller than approximately 6.5 ft. (2 m)
 - Pedestrians wearing oversized clothing (a rain coat, long skirt, etc.), making their silhouette obscure
 - Pedestrians who are carrying large baggage, holding an umbrella, etc., hiding part of their body
 - Pedestrians who are bending forward or squatting
 - Pedestrians who are pushing a stroller, wheelchair, bicycle or other vehicle
 - Groups of pedestrians which are close together
 - Pedestrians who are wearing white and look extremely bright
 - Pedestrians in the dark, such as at night or while in a tunnel
 - Pedestrians whose clothing appears to be nearly the same color or brightness as their surroundings
 - Pedestrians near walls, fences, guardrails, or large objects
 - Pedestrians who are on a metal object (manhole cover, steel plate, etc.) on the road
 - Pedestrians who are walking fast
 - Pedestrians who are changing speed abruptly
 - Pedestrians running out from behind a vehicle or a large object
 - Pedestrians who are extremely close to the side of the vehicle (outside rear view mirror, etc.)
- **If VSC is disabled**
 - If VSC is disabled (→P. 370), the pre-collision brake assist and pre-collision braking functions are also disabled.
 - The PCS warning light will turn on and “VSC Turned Off Pre-Collision Brake System Unavailable” will be displayed on the multi-information display.

LDA (Lane Departure Alert)

Summary of functions

When driving on roads with white (yellow) lines, this function alerts the driver when the vehicle might depart from its lane.

The LDA system recognizes visible white (yellow) lines with the camera sensor on the upper portion of the front windshield.

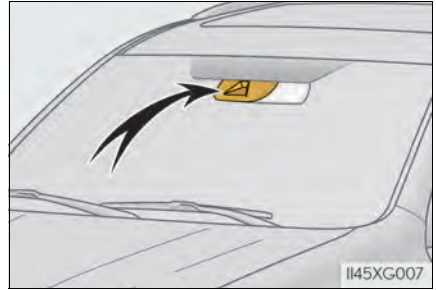

Functions included in LDA system

◆ Lane departure alert function

When the system determines that the vehicle might depart from its lane, a warning is displayed on the multi-information display, and either the warning buzzer sounds or the steering wheel vibrates to alert the driver.

When the warning buzzer sounds or the steering wheel vibrates, check the surrounding road situation and carefully operate the steering wheel to move the vehicle back to the center of the lane.

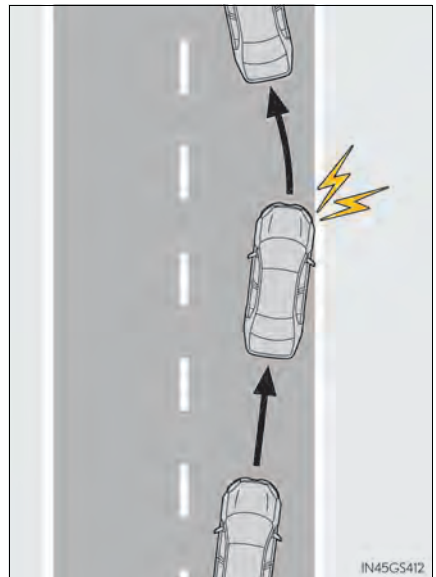

◆ Vehicle sway warning function

When the vehicle is swaying or appears as if it may depart from its lane multiple times, the warning buzzer sounds and a message is displayed on the multi-information display to alert the driver.

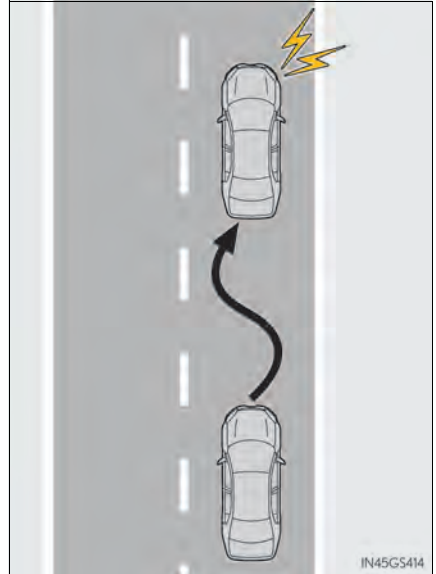

WARNING

■ Before using LDA system

Do not rely solely upon the LDA system. The LDA system does not automatically drive the vehicle or reduce the amount of attention that must be paid to the area in front of the vehicle. The driver must always assume full responsibility for driving safely by paying careful attention to the surrounding conditions and operating the steering wheel to correct the path of the vehicle. Also, the driver must take adequate breaks when fatigued, such as from driving for a long period of time.

Failure to perform appropriate driving operations and pay careful attention may lead to an accident, resulting in death or serious injury.

■ To avoid operating LDA system by mistake

When not using the LDA system, use the LDA switch to turn the system off.

⚠ WARNING

■ Situations unsuitable for LDA system

Do not use the LDA system in the following situations.

The system may not operate properly and lead to an accident, resulting in death or serious injury.

- A spare tire, tire chains, etc. are equipped.
- Objects or patterns that could be mistaken for white (yellow) lines are present on the side of the road (guardrails, curbs, reflective poles, etc.).
- Vehicle is driven on a snow-covered road.
- White (yellow) lines are difficult to see due to rain, snow, fog, dust, etc.
- Asphalt repair marks, white (yellow) line marks, etc. are present due to road repair.
- Vehicle is driven in a temporary lane or restricted lane due to construction work.
- Vehicle is driven in a construction zone.

■ Preventing LDA system malfunctions and operations performed by mistake

- Do not modify the headlights or place stickers, etc. on the surface of the lights.
- Do not modify the suspension etc. If the suspension etc. needs to be replaced, contact your Lexus dealer.
- Do not install or place anything on the hood or grille. Also, do not install a grille guard (bull bars, kangaroo bar, etc.).
- If your windshield needs repairs, contact your Lexus dealer.

Turning LDA system on

Press the LDA switch to turn the LDA system on.

The LDA indicator illuminates.

Press the LDA switch again to turn the LDA system off.

When the LDA system is turned on or off, operation of the LDA system continues in the same condition the next time the engine is started.

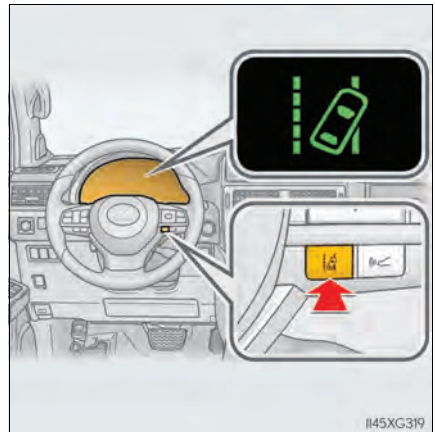

1145XG319

Indications on multi-information display

① LDA indicator

The illumination condition of the indicator informs the driver of the system operation status.

Illuminated in green:
LDA system is operating.

Flashing in orange:
Lane departure alert function is operating.

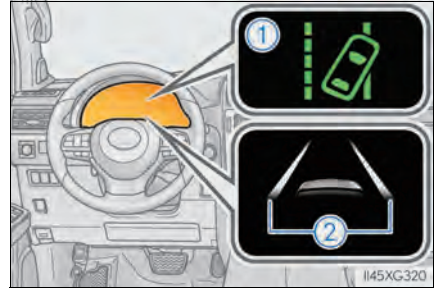

② Lane departure alert function display

Displayed when the multi-information display is switched to the driving assist system information screen.

▶ Inside of displayed white lines is white

▶ Inside of displayed white lines is black



Indicates that the system is recognizing white (yellow) lines. When the vehicle departs from its lane, the white line displayed on the side the vehicle departs from flashes orange.

Indicates that the system is not able to recognize white (yellow) lines or is temporarily canceled.

■ Operation conditions of each function

● Lane departure alert function

This function operates when all of the following conditions are met.

- LDA is turned on.
- Vehicle speed is approximately 32 mph (50 km/h) or more.
- System recognizes white (yellow) lines.
- Width of traffic lane is approximately 9.8 ft. (3 m) or more.
- Turn signal lever is not operated.
- Vehicle is driven on a straight road or around a gentle curve with a radius of more than approximately 492 ft. (150 m).
- No system malfunctions are detected. (→P. 253)

● Vehicle sway warning function

This function operates when all of the following conditions are met.

- Setting for “Sway Warning” in  of the multi-information display is set to “On”. (→P. 91)
- Vehicle speed is approximately 32 mph (50 km/h) or more.
- Width of traffic lane is approximately 9.8 ft. (3 m) or more.
- No system malfunctions are detected. (→P. 253)

■ Temporary cancellation of functions

When the operation conditions are no longer met, a function may be temporarily canceled. However, when the operation conditions are met again, operation of the function is automatically restored. (→P. 251)

■ Lane departure alert function

The warning buzzer may be difficult to hear due to external noise, audio playback, etc. Also, it may be difficult to feel steering wheel vibrations due to the road conditions etc.

■ Vehicle sway warning function

When the system determines that the vehicle is swaying while the vehicle sway warning function is operating, a buzzer sounds and a warning message urging the driver to rest and the symbol shown in the illustration are simultaneously displayed on the multi-information display.

Depending on the vehicle and road conditions, the warning may not operate.

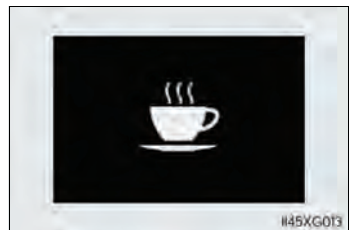

■ White (yellow) lines are only on one side of road

The LDA system will not operate for the side on which white (yellow) lines could not be recognized.

■ Conditions in which functions may not operate properly

In the following situations, the camera sensor may not detect white (yellow) lines and various functions may not operate normally.

- There are shadows on the road that run parallel with, or cover, the white (yellow) lines.
- The vehicle is driven in an area without white (yellow) lines, such as in front of a tollgate or checkpoint, or at an intersection, etc.
- The white (yellow) lines are cracked, “Botts’ dots”, “Raised pavement marker” or stones are present.
- The white (yellow) lines cannot be seen or are difficult to see due to sand, etc.
- The vehicle is driven on a road surface that is wet due to rain, puddles, etc.
- The traffic lines are yellow (which may be more difficult to recognize than lines that are white).
- The white (yellow) lines cross over a curb, etc.
- The vehicle is driven on a bright surface, such as concrete.
- The vehicle is driven on a surface that is bright due to reflected light, etc.
- The vehicle is driven in an area where the brightness changes suddenly, such as at the entrances and exits of tunnels, etc.
- Light from the headlights of an oncoming vehicle, the sun, etc. enters the camera.
- The vehicle is driven where the road diverges, merges, etc.
- The vehicle is driven on a slope.
- The vehicle is driven on a road which tilts left or right, or a winding road.
- The vehicle is driven on an unpaved or rough road.
- The vehicle is driven around a sharp curve.
- The traffic lane is excessively narrow or wide.
- The vehicle is extremely tilted due to carrying heavy luggage or having improper tire pressure.
- The distance to the preceding vehicle is extremely short.
- The vehicle is moving up and down a large amount due to road conditions during driving (poor roads or road seams).
- The headlight lenses are dirty and emit a faint amount of light at night, or the beam axis has deviated.
- The vehicle has just changed lanes or crossed an intersection.

■ Warning message

If the following warning message is displayed on the multi-information display and the LDA indicator illuminates in orange, follow the appropriate troubleshooting procedure.

Warning message	Details/Actions
"Lane Departure Alert Malfunction Visit Your Dealer"	The system may not be operating properly. → Have the vehicle inspected at your Lexus dealer.
"Front Camera Unavailable See Owner's Manual"	Dirt, rain, condensation, ice, snow, etc. are present on the windshield in front of the camera sensor. → Turn the LDA system off, remove any dirt, rain, condensation, ice, snow, etc. from the windshield, and then turn the LDA system back on.
"Front Camera Unavailable"	The operation conditions of the camera sensor (temperature, etc.) are not met. → When the operation conditions of the camera sensor (temperature, etc.) are met, the LDA system will become available. Turn the LDA system off, wait for a little while, and then turn the LDA system back on.
"Lane Departure Alert Unavailable"	The LDA system is temporarily canceled due to a malfunction in a sensor other than the camera sensor. → Turn the LDA system off and follow the appropriate troubleshooting procedures for the warning message. Afterward, drive the vehicle for a short time, and then turn the LDA system back on.
"Lane Departure Alert Unavailable Below Approx 32MPH"	The LDA system cannot be used as the vehicle speed is less than approximately 32 mph (50 km/h). → Drive the vehicle at approximately 32 mph (50 km/h) or more.

If a different warning message is displayed, follow the instructions displayed on the screen.

■ Customization

The following settings can be changed.

Function	Setting details
Lane departure alert function	Adjust alert sensitivity
	Adjust alert type
Vehicle sway warning function	Turn function on and off
	Adjust alert sensitivity

For how to change settings, refer to P. 600.

Dynamic radar cruise control

Summary of functions

In vehicle-to-vehicle distance control mode, the vehicle automatically accelerates and decelerates to match the speed changes of the preceding vehicle even if the accelerator pedal is not depressed. In constant speed control mode, the vehicle runs at a fixed speed.

Use the dynamic radar cruise control on freeways and highways.

- Vehicle-to-vehicle distance control mode (→P. 258)
- Constant speed control mode (→P. 263)

- ① Indicators
- ② Set speed
- ③ Vehicle-to-vehicle distance switch
- ④ Display
- ⑤ Cruise control switch

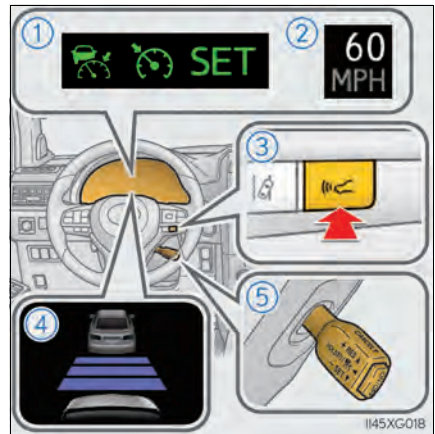

 **WARNING****■ Before using dynamic radar cruise control**

- Driving safely is the sole responsibility of the driver. Do not rely solely on the system, and drive safely by always paying careful attention to your surroundings.
- The dynamic radar cruise control provides driving assistance to reduce the driver's burden. However, there are limitations to the assistance provided. Read the following conditions carefully. Do not overly rely on this system and always drive carefully.
 - When the sensor may not be correctly detecting the vehicle ahead: →P. 265
 - Conditions under which the vehicle-to-vehicle distance control mode may not function correctly: →P. 266
- Set the speed appropriately depending on the speed limit, traffic flow, road conditions, weather conditions, etc. The driver is responsible for checking the set speed.
- Even when the system is functioning normally, the condition of the preceding vehicle as detected by the system may differ from the condition observed by the driver. Therefore, the driver must always remain alert, assess the danger of each situation and drive safely. Relying on this system or assuming the system ensures safety while driving can lead to an accident, resulting in death or serious injury.
- Switch the dynamic radar cruise control off using the "ON/OFF" button when not in use.

■ Cautions regarding the driving assist systems

Observe the following precautions, as there are limitations to the assistance provided by the system.

Failure to do so may cause an accident resulting in death or serious injury.

- **Assisting the driver to measure following distance**
The dynamic radar cruise control is only intended to help the driver in determining the following distance between the driver's own vehicle and a designated vehicle traveling ahead. It is not a mechanism that allows careless or inattentive driving, and it is not a system that can assist the driver in low-visibility conditions. It is still necessary for driver to pay close attention to the vehicle's surroundings.
- **Assisting the driver to judge proper following distance**
The dynamic radar cruise control determines whether the following distance between the driver's own vehicle and a designated vehicle traveling ahead is within a set range. It is not capable of making any other type of judgement. Therefore, it is absolutely necessary for the driver to remain vigilant and to determine whether or not there is a possibility of danger in any given situation.
- **Assisting the driver to operate the vehicle**
The dynamic radar cruise control has limited capability to prevent or avoid a collision with a vehicle traveling ahead. Therefore, if there is ever any danger, the driver must take immediate and direct control of the vehicle and act appropriately in order to ensure the safety of all involved.

 **WARNING****■ Situations unsuitable for dynamic radar cruise control**

Do not use dynamic radar cruise control in any of the following situations. Doing so may result in inappropriate speed control and could cause an accident resulting in death or serious injury.

- Roads where there are pedestrians, cyclists, etc.
- In heavy traffic
- On roads with sharp bends
- On winding roads
- On slippery roads, such as those covered with rain, ice or snow
- On steep downhills, or where there are sudden changes between sharp up and down gradients
Vehicle speed may exceed the set speed when driving down a steep hill.
- At entrances to freeways and highways
- When weather conditions are bad enough that they may prevent the sensors from detecting correctly (fog, snow, sandstorm, heavy rain, etc.)
- When there is rain, snow, etc. on the front surface of the radar sensor or camera sensor
- In traffic conditions that require frequent repeated acceleration and deceleration
- When your vehicle is towing a trailer (with towing hitch) or during emergency towing
- When an approach warning buzzer is heard often

Driving in vehicle-to-vehicle distance control mode

This mode employs a radar sensor to detect the presence of vehicles up to approximately 328 ft. (100 m) ahead, determines the current vehicle-to-vehicle following distance, and operates to maintain a suitable following distance from the vehicle ahead.

Note that vehicle-to-vehicle distance will close in when traveling on long downhill slopes.

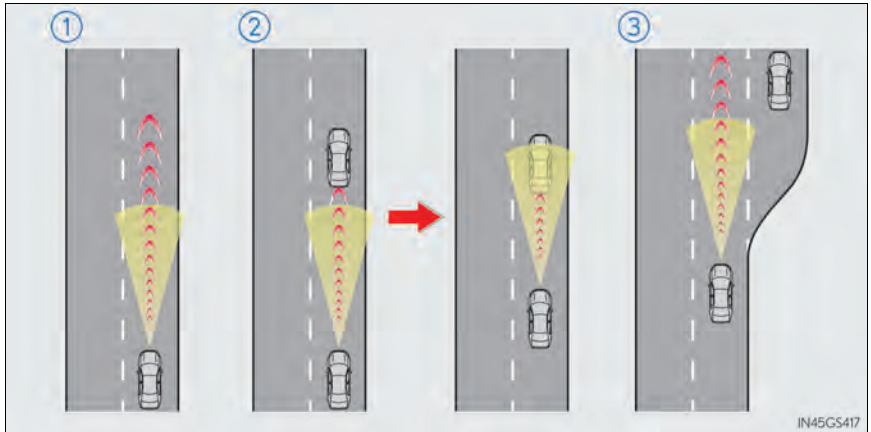

① Example of constant speed cruising

When there are no vehicles ahead

The vehicle travels at the speed set by the driver. The desired vehicle-to-vehicle distance can also be set by operating the vehicle-to-vehicle distance switch.

② Example of deceleration cruising and follow-up cruising

When a preceding vehicle driving slower than the set speed appears

When a vehicle is detected running ahead of you, the system automatically decelerates your vehicle. When a greater reduction in vehicle speed is necessary, the system applies the brakes (the stop lights will come on at this time). The system will respond to changes in the speed of the vehicle ahead in order to maintain the vehicle-to-vehicle distance set by the driver. Approach warning warns you when the system cannot decelerate sufficiently to prevent your vehicle from closing in on the vehicle ahead.

③ Example of acceleration

When there are no longer any preceding vehicles driving slower than the set speed

The system accelerates until the set speed is reached. The system then returns to constant speed cruising.

Setting the vehicle speed (vehicle-to-vehicle distance control mode)

- 1 Press the "ON/OFF" button to activate the cruise control.

Radar cruise control indicator will come on and a message will be displayed on the multi-information display.

Press the button again to deactivate the cruise control.

If the "ON/OFF" button is pressed and held for 1.5 seconds or more, the system turns on in constant speed control mode. (→P. 263)

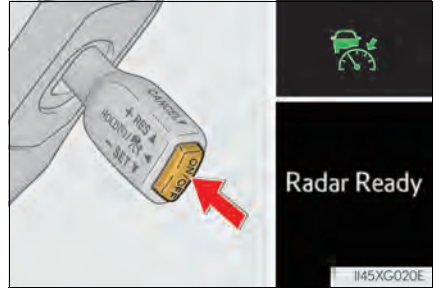

- 2 Accelerate or decelerate, with accelerator pedal operation, to the desired vehicle speed (at or above approximately 30 mph [50 km/h]) and push the lever down to set the speed.

Cruise control "SET" indicator will come on.

The vehicle speed at the moment the lever is released becomes the set speed.

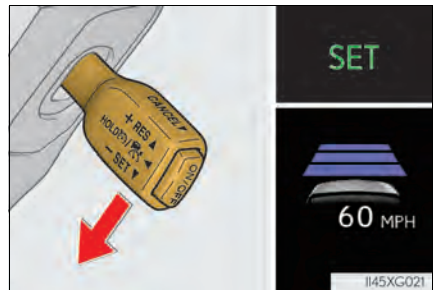

Adjusting the set speed

To change the set speed, operate the lever until the desired set speed is displayed.

- ① Increases the speed
- ② Decreases the speed

Fine adjustment: Momentarily move the lever in the desired direction.

Large adjustment: Hold the lever up or down to change the speed, and release when the desired speed is reached.

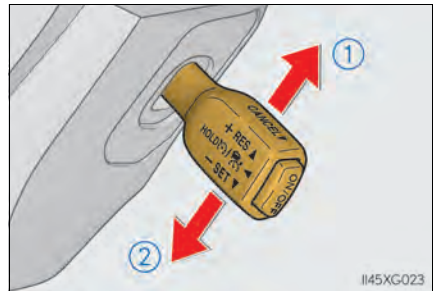

In the vehicle-to-vehicle distance control mode, the set speed will be increased or decreased as follows:

- ▶ For the U.S.A., Hawaii and Puerto Rico

Fine adjustment: By 1 mph (1.6 km/h)^{*1} or 1 km/h (0.6 mph)^{*2} each time the lever is operated

Large adjustment: Increases or decreases in 1 mph (1.6 km/h)^{*1} or 1 km/h (0.6 mph)^{*2} increments for as long as the lever is held

- ▶ Except for the U.S.A., Hawaii and Puerto Rico

Fine adjustment: By 1 mph (1.6 km/h)^{*1} or 1 km/h (0.6 mph)^{*2} each time the lever is operated

Large adjustment: Increases or decreases in 5 mph (8 km/h)^{*1} or 5 km/h (3.1 mph)^{*2} increments for as long as the lever is held

In the constant speed control mode (→P. 263), the set speed will be increased or decreased as follows:

Fine adjustment: By 1 mph (1.6 km/h)^{*1} or 1 km/h (0.6 mph)^{*2} each time the lever is operated

Large adjustment: The speed will continue to change while the lever is held.

*1: When the set speed is shown in "MPH"

*2: When the set speed is shown in "km/h"

Changing the vehicle-to-vehicle distance (vehicle-to-vehicle distance control mode)

Pressing the switch changes the vehicle-to-vehicle distance as follows:

- ① Long
- ② Medium
- ③ Short

The vehicle-to-vehicle distance is set automatically to long mode when the engine switch is turned to IGNITION ON mode.

If a vehicle is running ahead of you, the preceding vehicle mark will also be displayed.

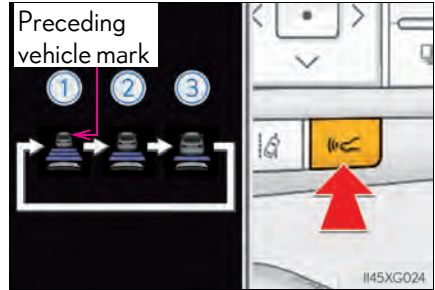

Vehicle-to-vehicle distance settings (vehicle-to-vehicle distance control mode)

Select a distance from the table below. Note that the distances shown correspond to a vehicle speed of 50 mph (80 km/h). Vehicle-to-vehicle distance increases/decreases in accordance with vehicle speed.

Distance options	Vehicle-to-vehicle distance
Long	Approximately 160 ft. (50 m)
Medium	Approximately 130 ft. (40 m)
Short	Approximately 100 ft. (30 m)

Canceling and resuming the speed control

- ① Pulling the lever toward you cancels the speed control.

The speed control is also canceled when the brake pedal is depressed.

- ② Pushing the lever up resumes the cruise control and returns vehicle speed to the set speed.

However, cruise control does not resume when the vehicle speed is approximately 25 mph (40 km/h) or less.

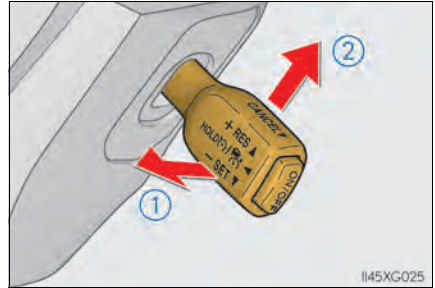

Approach warning (vehicle-to-vehicle distance control mode)

When your vehicle is too close to a vehicle ahead, and sufficient automatic deceleration via the cruise control is not possible, the display will flash and the buzzer will sound to alert the driver. An example of this would be if another driver cuts in front of you while you are following a vehicle. Depress the brake pedal to ensure an appropriate vehicle-to-vehicle distance.

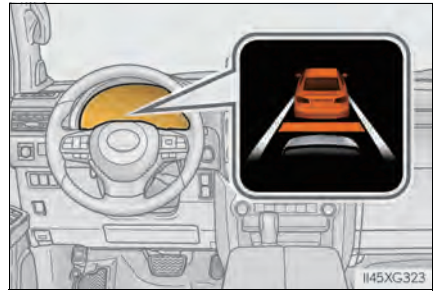

■ Warnings may not occur when

In the following instances, warnings may not occur even when the vehicle-to-vehicle distance is small.

- When the speed of the preceding vehicle matches or exceeds your vehicle speed
- When the preceding vehicle is traveling at an extremely slow speed
- Immediately after the cruise control speed was set
- When depressing the accelerator pedal

Selecting constant speed control mode

When constant speed control mode is selected, your vehicle will maintain a set speed without controlling the vehicle-to-vehicle distance. Select this mode only when vehicle-to-vehicle distance control mode does not function correctly due to a dirty radar sensor, etc.

- 1 With the cruise control off, press and hold the "ON/OFF" button for 1.5 seconds or more.

Immediately after the "ON/OFF" button is pressed, the radar cruise control indicator will come on. Afterwards, it switches to the cruise control indicator.

Switching to constant speed control mode is only possible when operating the lever with the cruise control off.

- 2 Accelerate or decelerate, with accelerator pedal operation, to the desired vehicle speed (at or above approximately 25 mph [40 km/h]) and push the lever down to set the speed.

Cruise control "SET" indicator will come on.

The vehicle speed at the moment the lever is released becomes the set speed.

Adjusting the speed setting: →P. 260

Canceling and resuming the speed setting: →P. 262

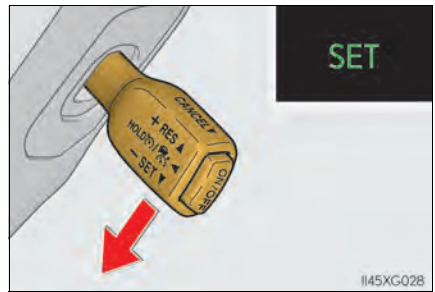
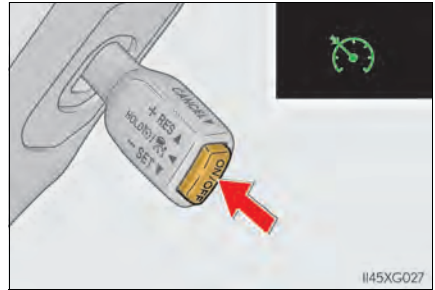

■ Dynamic radar cruise control can be set when

- The shift lever is in D.
- Vehicle speed is at or above approximately 30 mph (50 km/h).

■ Accelerating after setting the vehicle speed

The vehicle can accelerate by operating the accelerator pedal. After accelerating, the set speed resumes. However, during vehicle-to-vehicle distance control mode, the vehicle speed may decrease below the set speed in order to maintain the distance to the preceding vehicle.

■ Automatic cancelation of vehicle-to-vehicle distance control mode

Vehicle-to-vehicle distance control mode is automatically canceled in the following situations:

- Actual vehicle speed falls at or below approximately 25 mph (40 km/h).
- VSC is activated.
- Active TRAC is activated for a period of time.
- When the VSC or Active TRAC system is turned off.
- When second start mode is set.
- The sensor cannot detect correctly because it is covered in some way.
- Pre-collision braking is activated.
- The switching operation continues for 5 seconds or more after the center differential lock switch has been operated.

If vehicle-to-vehicle distance control mode is automatically canceled for any other reason, there may be a malfunction in the system. Contact your Lexus dealer.

■ Automatic cancelation of constant speed control mode

Constant speed control mode is automatically canceled in the following situations:

- Actual vehicle speed is more than approximately 10 mph (16 km/h) below the set vehicle speed.
- Actual vehicle speed falls below approximately 25 mph (40 km/h).
- VSC is activated.
- Active TRAC is activated for a period of time.
- When the VSC or Active TRAC system is turned off.
- Pre-collision braking is activated.
- The switching operation continues for 5 seconds or more after the center differential lock switch has been operated.

If constant speed control mode is automatically canceled for any other reason, there may be a malfunction in the system. Contact your Lexus dealer.

■ Brake system operation sound

If the brakes are applied automatically while the vehicle is in vehicle-to-vehicle distance control mode, a brake system operation sound may be heard. This does not indicate a malfunction.

■ Warning messages and buzzers for dynamic radar cruise control

Warning messages and buzzers are used to indicate a system malfunction or to inform the driver of the need for caution while driving. If a warning message is shown on the multi-information display, read the message and follow the instructions.

■ When the sensor may not be correctly detecting the vehicle ahead

In the case of the following and depending on the conditions, operate the brake pedal when deceleration of the system is insufficient or operate the accelerator pedal when acceleration is required.

As the sensor may not be able to correctly detect these types of vehicles, the approach warning (→P. 262) may not be activated.

- Vehicles that cut in suddenly
- Vehicles traveling at low speeds
- Vehicles that are not moving in the same lane
- Vehicles with small rear ends (trailers with no load on board, etc.)

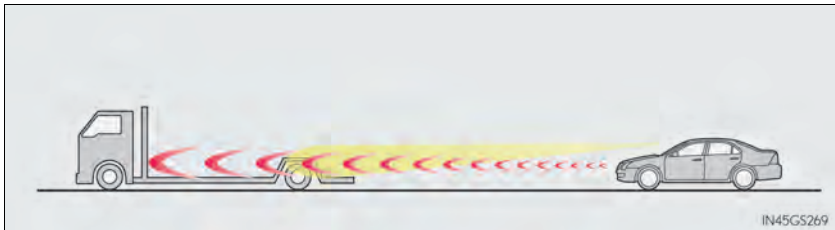

- Motorcycles traveling in the same lane
- When water or snow thrown up by the surrounding vehicles hinders the detecting of the sensor
- When your vehicle is pointing upwards (caused by a heavy load in the luggage compartment, etc.)

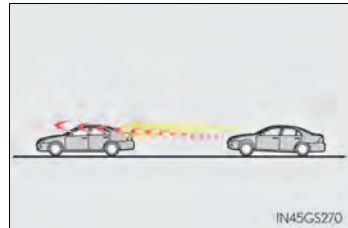

- Preceding vehicle has an extremely high ground clearance

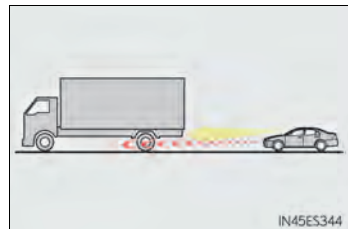

■ **Conditions under which the vehicle-to-vehicle distance control mode may not function correctly**

In the case of the following conditions, operate the brake pedal (or accelerator pedal, depending on the situation) as necessary.

As the sensor may not be able to correctly detect vehicles ahead, the system may not operate properly.

- When the road curves or when the lanes are narrow

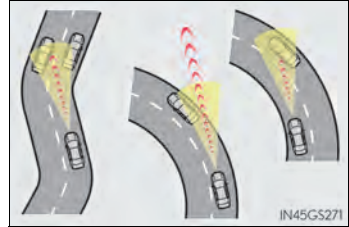

- When steering wheel operation or your position in the lane is unstable

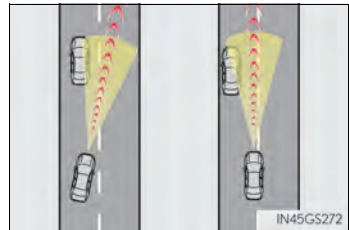

- When the vehicle ahead of you decelerates suddenly
- When driving on a road surrounded by a structure, such as in a tunnel or on a bridge
- While the vehicle speed is decreasing to the set speed after the vehicle accelerates by depressing the accelerator pedal

Intuitive parking assist

The distance from your vehicle to nearby obstacles when parallel parking or maneuvering into a garage is measured by the sensors and communicated via the multi-information display, the navigation system screen, and a buzzer. Always check the surrounding area when using this system.

Types of sensors

- ① Front center sensors
- ② Front corner sensors
- ③ Rear corner sensors
- ④ Rear center sensors

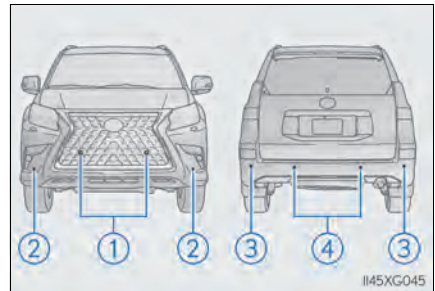

Turning the intuitive parking assist on/off

- 1 Press or of the meter control switches and select on the multi-information display.
- 2 Press or of the meter control switches and select , and then press .
- 3 Press or of the meter control switches and select , and then press .

Each pressing of the switch turns the intuitive parking assist on and off. When ON is selected, Intuitive parking assist indicator will come on.

Display

When the sensors detect an obstacle, a graphic is shown on the multi-information display and navigation system screen depending on the position and distance to the obstacle.

► Multi-information display

- ① Front corner sensor operation
- ② Front center sensor operation
- ③ Rear corner sensor operation
- ④ Rear center sensor operation

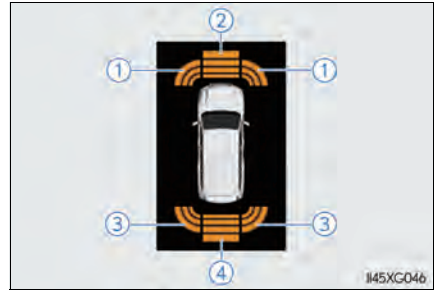

► Multimedia screen or navigation system screen

Insert display

When the Lexus parking assist monitor* or Multi-terrain Monitor* is displayed.

A simplified image is displayed on the upper corner of the screen when an obstacle is detected.



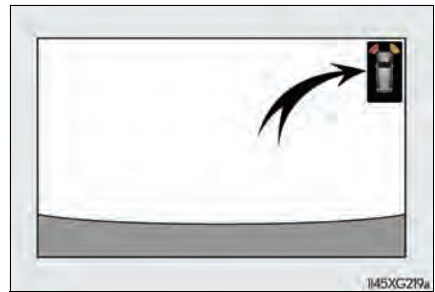





*: If equipped



Sensor detection display, obstacle distance

■ Distance display

Sensors that detect an obstacle will illuminate continuously or blink.

Multi-information display	Insert display	Approximate distance to obstacle	
		Front corner sensor/front center sensor	Rear corner sensor/rear center sensor
 <p>(continuous)</p>	 <p>(blinking slowly)</p>	<p>Front center sensor: 3.3 ft. (100 cm) to 2.0 ft. (60 cm)</p>	<p>Rear center sensor: 4.9 ft. (150 cm) to 2.1 ft. (65 cm)</p>
 <p>(continuous)</p>	 <p>(blinking)</p>	<p>Front corner sensor: 1.6 ft. (50 cm) to 1.3 ft. (40 cm)</p> <p>Front center sensor: 2.0 ft. (60 cm) to 1.5 ft. (45 cm)</p>	<p>Rear corner sensor: 1.8 ft. (55 cm) to 1.2 ft. (37.5 cm)</p> <p>Rear center sensor: 2.1 ft. (65 cm) to 1.6 ft. (50 cm)</p>
 <p>(continuous)</p>	 <p>(blinking rapidly)</p>	<p>Front corner sensor: 1.3 ft. (40 cm) to 1.0 ft. (30 cm)</p> <p>Front center sensor: 1.5 ft. (45 cm) to 1.0 ft. (30 cm)</p>	<p>Rear corner sensor: 1.2 ft. (37.5 cm) to 0.8 ft. (25 cm)</p> <p>Rear center sensor: 1.6 ft. (50 cm) to 1.3 ft. (40 cm)</p>
 <p>(blinking)</p>	 <p>(continuous)</p>	<p>Less than 1.0 ft. (30 cm)</p>	<p>Rear corner sensor: Less than 0.8 ft. (25 cm)</p> <p>Rear center sensor: Less than 1.3 ft. (40 cm)</p>

■ Buzzer operation and distance to an obstacle

A buzzer sounds when the sensors are operating.

- The buzzer sounds faster as the vehicle approaches an obstacle.
When the vehicle comes within the following distance of the obstacle, the buzzer sounds continuously.
 - Front corner sensors: Approximately 1.0 ft. (30 cm)
 - Front center sensors: Approximately 1.0 ft. (30 cm)
 - Rear corner sensors: Approximately 0.8 ft. (25 cm)
 - Rear center sensors: Approximately 1.3 ft. (40 cm)
- When an obstacle is detected by multiple sensors simultaneously, the buzzer sounds according to the distance to the closest obstacle.
- When obstacles are simultaneously detected to the front and rear of the vehicle, separate buzzers sound patterns according to the distance to each obstacle.
- You can change the volume of the warning beeps. (→P. 274)

Detection range of the sensors

- ① Approximately 3.3 ft. (100 cm)
- ② Approximately 4.9 ft. (150 cm)
- ③ Approximately 1.6 ft. (50 cm)
- ④ Approximately 1.8 ft. (55 cm)

The diagram shows the detection range of the sensors. Note that the sensors may not be able to detect obstacles that are extremely close to the vehicle.

The range of the sensors may change depending on the shape of the object etc.

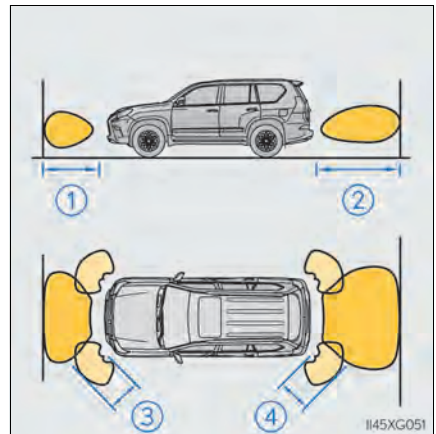

■ The intuitive parking assist can be operated when

- Front corner sensors:
 - The engine switch is in IGNITION ON mode.
 - The shift lever is in a position other than P.
 - The vehicle speed is less than approximately 6 mph (10 km/h).
(At any speed when the shift lever is in R)
- Front center sensors:
 - The engine switch is in IGNITION ON mode.
 - The shift lever is in a position other than P or R.
 - The vehicle speed is less than about 6 mph (10 km/h).
- Rear corner and rear center sensors:
 - The engine switch is in IGNITION ON mode.
 - The shift lever is in R.

■ Intuitive parking assist display

When an obstacle is detected while the Lexus parking assist monitor or Multi-terrain Monitor is in use, the warning indicator will appear in the upper corner of the screen even if the display setting has been set to off.

■ Sensor detection information

- The sensor's detection areas are limited to the areas around the vehicle's bumper.
- The following situations may occur during use.
 - Depending on the shape of the object and other factors, the detection distance may shorten, or detection may be impossible.
 - Detection may be impossible if static objects draw too close to the sensor.
 - There will be a short delay between object detection and display. Even at low speeds, there is a possibility that the object will come within the sensor's detection areas before the display is shown and the warning beep sounds.
 - It might be difficult to hear the buzzer due to the volume of the audio system or air flow noise of the air conditioning system.
 - It may be difficult to hear the sound of this system due to the buzzers of other systems.

■ Objects which the system may not properly detect

The shape of the obstacle may prevent a sensor from detecting it. Pay particular attention to the following obstacles:

- Wires, fences, ropes, etc.
- Cotton, snow and other materials that absorb sound waves
- Sharply-angled objects
- Low obstacles
- Tall obstacles with upper sections projecting outwards in the direction of your vehicle

■ Situations in which the system may not operate properly

Certain vehicle conditions and the surrounding environment may affect the ability of a sensor to correctly detect objects. Particular instances where this may occur are listed below.

- There is dirt, snow, water drops or ice on a sensor. (Cleaning the sensors will resolve this problem.)
- A sensor is frozen. (Thawing the area will resolve this problem.) In especially cold weather, if a sensor is frozen the sensor display may be displayed abnormally, or objects, such as a wall, may not be detected.
- When a sensor or the area around a sensor is extremely hot or cold.

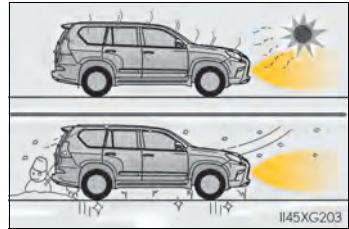

- On an extremely bumpy road, on an incline, on gravel, or on grass.
- When vehicle horns, vehicle detectors, motorcycle engines, air brakes of large vehicles, the clearance sonar of other vehicles or other devices which produce ultrasonic waves are near the vehicle.
- A sensor is coated with a sheet of spray or heavy rain.
- If objects draw too close to the sensor.
- When a pedestrian is wearing clothing that does not reflect ultrasonic waves (ex. skirts with gathers or frills).
- When objects that are not perpendicular to the ground, not perpendicular to the vehicle traveling direction, uneven, or waving are in the detection range.
- Strong wind is blowing.
- When driving in inclement weather such as fog, snow or a sandstorm.
- When an object that cannot be detected is between the vehicle and a detected object.
- If an object such as a vehicle, motorcycle, bicycle or pedestrian cuts in front of the vehicle or runs out from the side of the vehicle.
- If the orientation of a sensor has been changed due to a collision or other impact.
- When equipment that may obstruct a sensor is installed, such as a towing eyelet, bumper protector (an additional trim strip, etc.), bicycle carrier, or snow plow.
- If the front of the vehicle is raised or lowered due to the carried load.
- If the vehicle cannot be driven in a stable manner, such as when the vehicle has been in an accident or is malfunctioning.
- When tire chains, a compact spare tire or an emergency tire puncture repair kit are used.

■ Situations in which the system may operate even if there is no possibility of a collision

In some situations, such as the following, the system may operate even though there is no possibility of a collision.

- When driving on a narrow road.

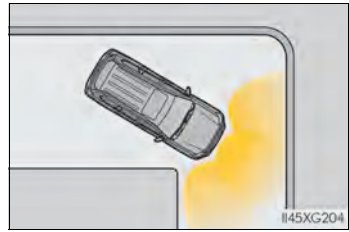

- When driving toward a banner, flag, low-hanging branch or boom barrier (such as those used at railroad crossings, toll gates and parking lots).
- When there is a rut or hole in the surface of the road.
- When driving on a metal cover (grating), such as those used for drainage ditches.
- When driving up or down a steep slope.
- If a sensor is hit by a large amount of water, such as when driving on a flooded road.
- There is dirt, snow, water drops or ice on a sensor. (Cleaning the sensors will resolve this problem.)
- A sensor is coated with a sheet of spray or heavy rain.
- When driving in inclement weather such as fog, snow or a sandstorm.
- When strong winds are blowing.







- When vehicle horns, vehicle detectors, motorcycle engines, air brakes of large vehicles, the clearance sonar of other vehicles or other devices which produce ultrasonic waves are near the vehicle.
- If the front of the vehicle is raised or lowered due to the carried load.
- If the orientation of a sensor has been changed due to a collision or other impact.
- The vehicle is approaching a tall or curved curb.
- Driving close to columns (H-shaped steel beams, etc.) in multi-story parking garages, construction sites, etc.
- If the vehicle cannot be driven in a stable manner, such as when the vehicle has been in an accident or is malfunctioning.

- On an extremely bumpy road, on an incline, on gravel, or on grass.



- When tire chains, a compact spare tire or an emergency tire puncture repair kit are used.
- If **“Parking Assist Unavailable Clean Parking Assist Sensor”** is displayed on the multi-information display
- A sensor may be dirty or covered with snow or ice. In such cases, if it is removed from the sensor, the system should return to normal.
- Also, due to the sensor being frozen at low temperatures, a malfunction display may appear or an obstacle may not be detected. If the sensor thaws out, the system should return to normal.
- If **“Parking Assist Malfunction Visit Your Dealer”** is displayed on the multi-information display
- Depending on the malfunction of the sensor, the device may not be working normally. Have the vehicle inspected by your Lexus dealer.

■ Adjusting the buzzer volume

- 1 Press **<** or **>** of the meter control switches and select  on the multi-information display.
- 2 Press **▲** or **▼** of the meter control switches and select , and then press .
- 3 Select the volume and then press .

Each time the switch is pressed, the volume level will change between 1, 2 and 3.

■ Customization

Detection distance of the sensor can be changed.
(Customizable features: →P. 600)

■ Muting a buzzer temporarily

A mute button will be displayed on the multi-information display when an object is detected. To mute the buzzer, press .

Mute will be automatically canceled in the following situations:

- When the shift position is changed.
 - When there is a malfunction in a sensor or the system is temporarily unavailable.
 - When the function is disabled while it is operating.
 - When the power switch is turned off.
 - When the shift lever is in D or S and the vehicle speed is 9 mph (15 km/h) or higher.
- **Certification for the intuitive parking assist (Canada only)**

This ISM device complies with Canadian ICES-001.

 **WARNING****■ Cautions regarding the use of the system**

There is a limit to the degree of recognition accuracy and control performance that this system can provide, do not overly rely on this system. The driver is always responsible for paying attention to the vehicle's surroundings and driving safely.

■ To ensure the system can operate properly

Observe the following precautions.

Failing to do so may result in the vehicle being unable to be driven safely and possibly cause an accident.

- Do not damage the sensors, and always keep them clean.
- Do not attach a sticker or install an electronic component, such as a backlit license plate (especially fluorescent type), fog lights, fender pole or wireless antenna near a radar sensor.
- Do not subject the surrounding area of the sensor to a strong impact. If subjected to an impact, have the vehicle inspected by your Lexus dealer. If the front or rear bumper needs to be removed/installed or replaced, contact your Lexus dealer.
- Do not modify, disassemble or paint the sensors.
- Do not attach a license plate cover.
- Keep your tires properly inflated.

■ When to disable the function

In the following situations, disable the function as it may operate even though there is no possibility of a collision.

- Failing to observe the warnings above.
- A non-genuine Lexus suspension (lowered suspension, etc.) is installed.

■ Notes when washing the vehicle

Do not apply intensive bursts of water or steam to the sensor area.

Doing so may result in the sensor malfunctioning.

- When using a high pressure washer to wash the vehicle, do not spray the sensors directly, as doing so may cause a sensor to malfunction.
- When using steam to clean the vehicle, do not direct steam too close to the sensors as doing so may cause a sensor to malfunction.



NOTICE

■ When using intuitive parking assist

In the following situations, the system may not function correctly due to a sensor malfunction etc. Have the vehicle checked by your Lexus dealer.

- A buzzer does not sound when you turn the intuitive parking assist on.
- The intuitive parking assist operation display flashes, and a buzzer sounds when no obstacles are detected.
- If the area around a sensor collides with something, or is subjected to strong impact.
- If the bumper collides with something.
- If the display shows continuously without a beep.
- If a display error occurs, first check the sensor.
If the error occurs even if there is no ice, snow or mud on the sensor, it is likely that the sensor is malfunctioning.

Lexus parking assist monitor*

The parking assist monitor assists the driver by displaying an image of the view behind the vehicle while backing up, for example while parking.

When the display is changed to the wide rear view mode, a wider lateral view behind the vehicle will be displayed.

The screen illustrations used in this text are intended as examples, and may differ from the image that is actually displayed on the screen.

The rear view image is displayed when the shift lever is in R and the engine switch is in IGNITION ON mode.

The parking assist monitor system will be deactivated when the shift lever is in any position other than R.

When the shift lever is shifted to R and any mode button (such as "SETUP") is pressed, the parking assist monitor is canceled, and the screen is switched to the mode of the button that was pressed.

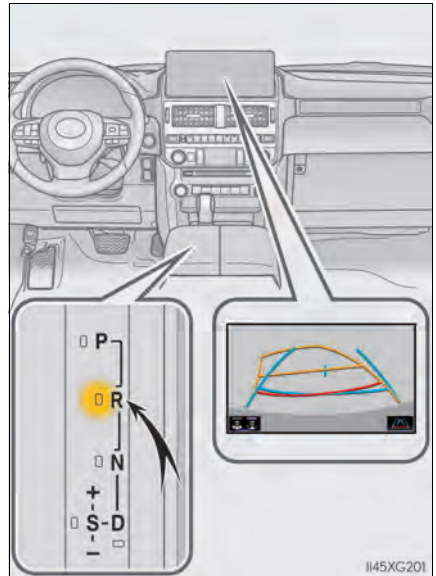

Driving precautions

The parking assist monitor is a supplemental device intended to assist the driver when backing up. When backing up, be sure to visually check all around the vehicle both directly and using the mirrors before proceeding. If you do not, you may hit another vehicle, and could possibly cause an accident.

Pay attention to the following precautions when using the parking assist monitor.

*: If equipped

Using the Lexus parking assist monitor

■ Screen display

The parking assist monitor screen will be displayed if the shift lever is shifted to R while the engine switch is in IGNITION ON mode.

Each time the display mode switching button is selected, the mode will change as follows:

▶ Rear view

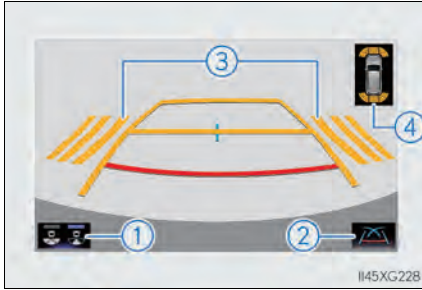

▶ Wide rear view

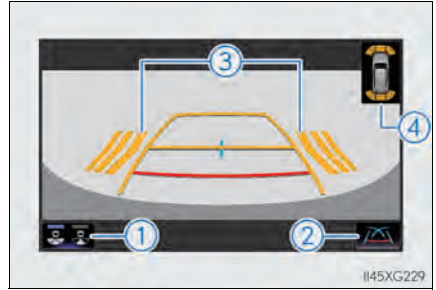

① Display mode switch screen button

Each time the button is selected, the rear view mode and the wide rear view mode are switched.

② Guide line switching button

Select to switch the guide line mode.

- Each time the button is selected, the display mode changes in the following order:

Estimated course line display mode → Parking assist guide line display mode
→ Distance guide line display mode.

③ Rear Cross Traffic Alert

When a sensor detects a vehicle approaching from the rear, the direction of the vehicle approaching from the rear is displayed and the buzzer sounds.

④ Intuitive parking assist

When a sensor detects a stationary object, the direction of and the approximate distance to the stationary object are displayed and the buzzer sounds.

■ Using the system when perpendicular parking

Use any of the following modes.



● Estimated course line display mode (→P. 280)

Estimated course lines are displayed which move in accordance with the operation of the steering wheel.

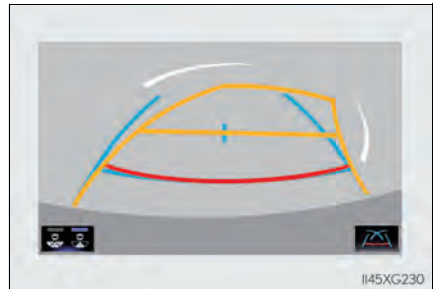

● Parking assist guide line display mode (→P. 281)

The steering wheel return points (parking assist guide lines) are displayed.

This mode is recommended for those who are comfortable with parking the vehicle without the aid of the estimated course lines.



● Distance guide line display mode (→P. 282)

Distance guide lines only are displayed.

This mode is recommended for those who are comfortable with parking the vehicle without the aid of the guide lines.



Estimated course line display mode

■ Screen description

▶ Rear view

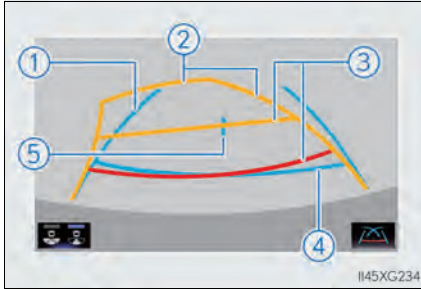

▶ Wide Rear view

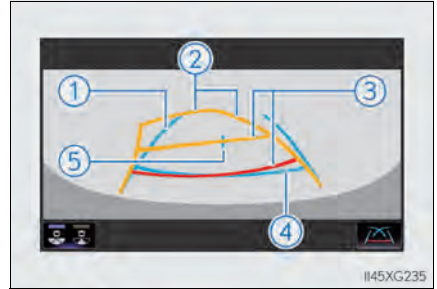

① Vehicle width extension guide line

Displays a guide path when the vehicle is being backed straight up.

② Estimated course lines

Show an estimated course when the steering wheel is turned.

③ Distance guide line

Show distance behind the vehicle when the steering wheel is turned.

- The guide lines move in conjunction with the estimated course lines.
- The guide lines display points approximately 1.5 ft. (0.5 m) (red) and approximately 3 ft. (1 m) (yellow) from the center of the edge of the bumper.

④ Distance guide line

Show distance behind the vehicle.

- Displays a point approximately 1.5 ft. (0.5 m) (blue) from the edge of the bumper.

⑤ Vehicle center guide line

Indicates the estimated vehicle center on the ground.

Parking assist guide line display mode

■ Screen description

▶ Rear view

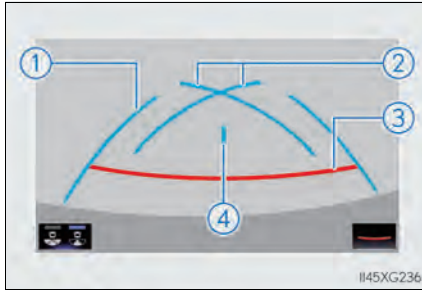

▶ Wide Rear view

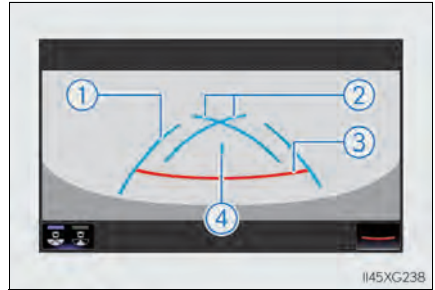

- ① Vehicle width guide lines
 - Displays a guide path when the vehicle is being backed straight up.
 - The displayed width is wider than the actual vehicle width.
- ② Parking assist guide lines
 - Show the path of the smallest turn possible behind the vehicle.
- ③ Distance guide line
 - Shows distance behind the vehicle.
 - Displays points approximately 1.5 ft. (0.5 m) (red) from the edge of the bumper.
- ④ Vehicle center guide line
 - Indicates the estimated vehicle center on the ground.

Distance guide line display mode

■ Screen description

▶ Rear view

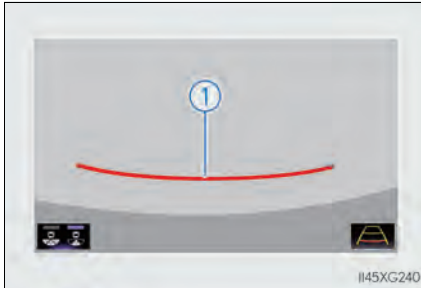

▶ Wide Rear view



① Distance guide line

Shows distance behind the vehicle.

- Displays points approximately 1.5 ft. (0.5 m) (red) from the edge of the bumper.

Lexus parking assist monitor precautions

■ Area displayed on screen

▶ Rear view

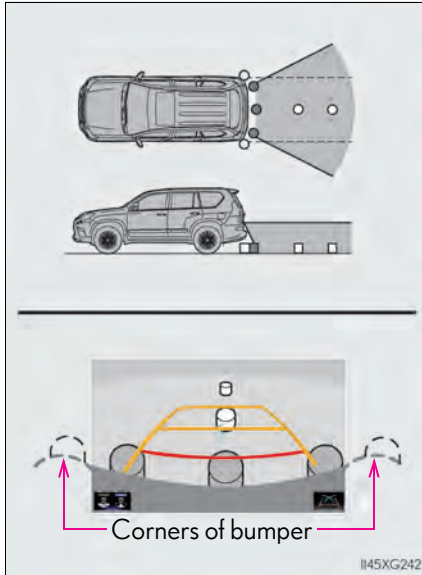

▶ Wide Rear view

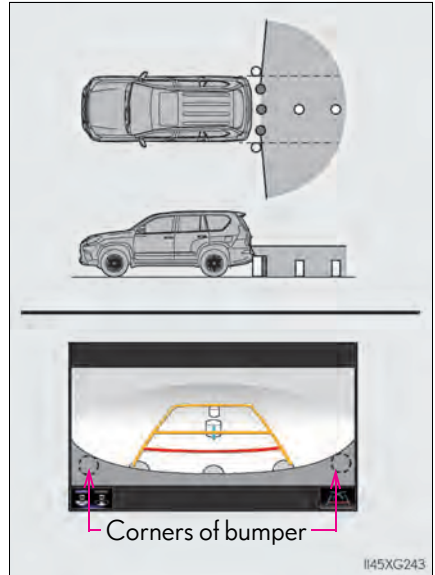

The parking assist monitor displays an image of the view from the bumper of the rear area of the vehicle.

The area around both corners of the bumper will not be displayed.

- The image on the rear view monitor system screen can be adjusted, refer to the "NAVIGATION SYSTEM OWNER'S MANUAL".
- The area displayed on the screen may vary according to vehicle orientation conditions.
- Objects which are close to either corner of the bumper or under the bumper cannot be seen on the screen.
- The camera uses a special lens. The distance of the image that appears on the screen differs from the actual distance.
- Items which are located higher than the camera may not be displayed on the monitor.
- If your vehicle is equipped with a backlit license plate, it may interfere with the display.

■ Lexus parking assist monitor camera

The camera for the parking assist monitor is located above the license plate.

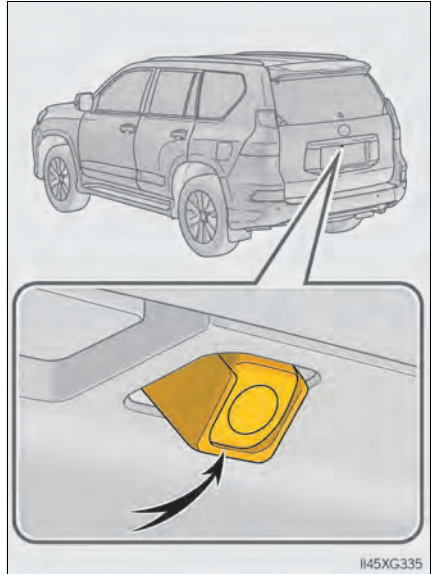

● Using the camera

If dirt or foreign matter (such as water droplets, snow, mud etc.) is adhering to the camera, it cannot transmit a clear image. In this case, flush it with a large quantity of water and wipe the camera lens clean with a soft and wet cloth.

■ Differences between the screen and the actual road

The distance guide lines and the vehicle width extension guide lines may not actually be parallel with the dividing lines of the parking space, even when they appear to be so. Be sure to check visually.

The distances between the vehicle width extension guide lines and the left and right dividing lines of the parking space may not be equal, even when they appear to be so. Be sure to check visually.

The distance guide lines give a distance guide for flat road surfaces. In any of the following situations, there is a margin of error between the guide lines on the screen and the actual distance/course on the road.

- When the ground behind the vehicle slopes up sharply

The distance guide lines will appear to be closer to the vehicle than the actual distance. Because of this, objects will appear to be farther away than they actually are. In the same way, there will be a margin of error between the guidelines and the actual distance/course on the road.

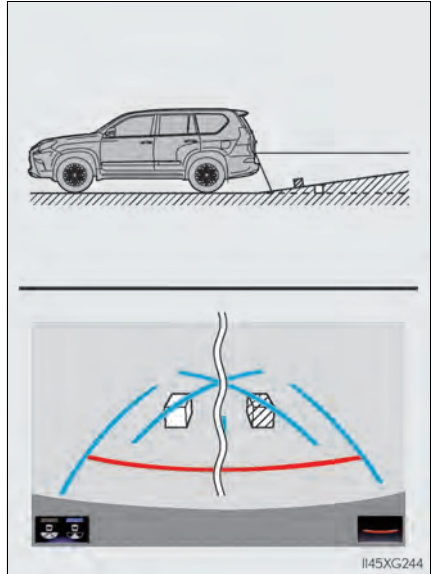

- When the ground behind the vehicle slopes down sharply

The distance guide lines will appear to be further from the vehicle than the actual distance. Because of this, objects will appear to be closer than they actually are. In the same way, there will be a margin of error between the guidelines and the actual distance/course on the road.

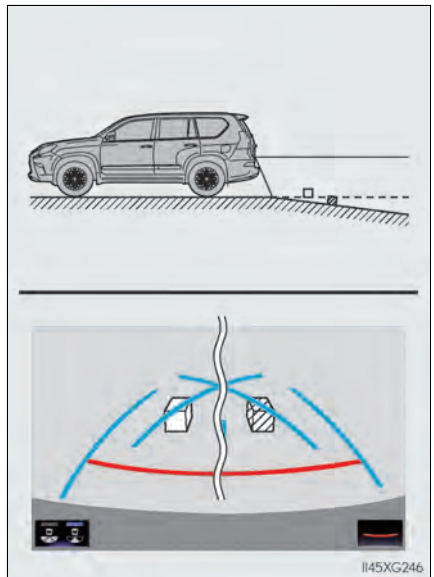

- When any part of the vehicle sags
When any part of the vehicle sags due to the number of passengers or the distribution of the load, there is a margin of error between the guide lines on the screen and the actual distance/course on the road.

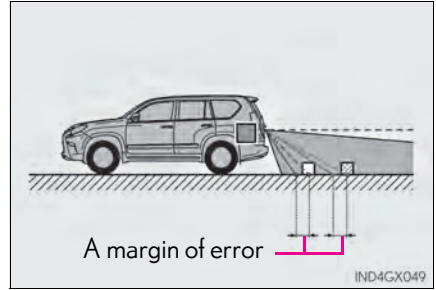

■ When approaching three-dimensional objects

The estimated course lines target a flat surfaced objects (such as the road). It is not possible to determine the position of three-dimensional objects (such as vehicles) using the estimated course lines and distance guide lines. When approaching a three-dimensional object that extends outward (such as the flatbed of a truck), be careful of the following.

- Estimated course lines

Visually check the surroundings and the area behind the vehicle. In the case shown in the illustration, the truck appears to be outside of the estimated course lines and the vehicle does not look as if it will hit the truck. However, the rear body of the truck may actually cross over the estimated course lines. In reality if you back up as guided by the estimated course lines, the vehicle may hit the truck.

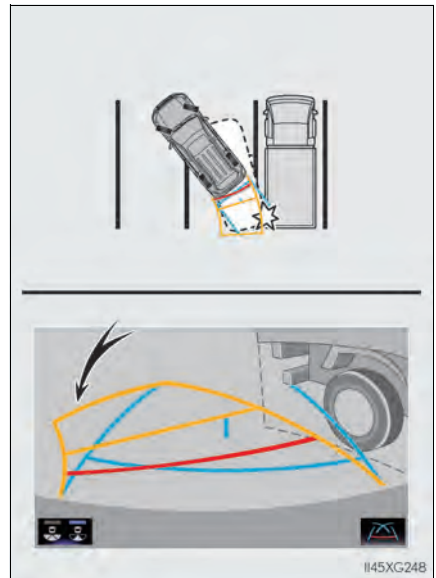

- Distance guidelines

Visually check the surroundings and the area behind the vehicle. On the screen, it appears that a truck is parking at point ②. However, in reality if you back up to point ①, you will hit the truck. On the screen, it appears that ① is closest and ③ is farthest away. However, in reality, the distance to ① and ③ is the same and ② is farther than ① and ③.

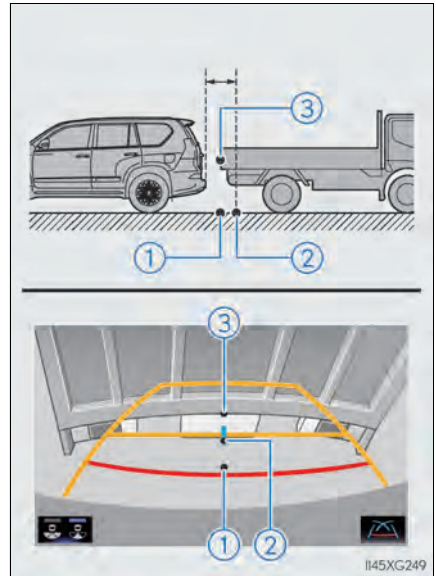

Things you should know

■ If you notice any symptoms

If you notice any of the following symptoms, refer to the likely cause and the solution, and re-check.

If the symptom is not resolved by the solution, have the vehicle inspected by your Lexus dealer.

Likely cause	Solution
❑ The image is difficult to see	
<ul style="list-style-type: none"> • The vehicle is in a dark area • The temperature around the lens is either high or low • The outside temperature is low • There are water droplets on the camera • It is raining or humid • Foreign matter (mud etc.) is adhering to the camera • There are scratches on the camera • Sunlight or headlights are shining directly into the camera • The vehicle is under fluorescent lights, sodium lights, mercury lights etc. 	<p>If this happens due to these causes, it does not indicate a malfunction. Back up while visually checking the vehicle's surroundings. (Use the monitor again once conditions have been improved.)</p> <p>The image on the rear view monitor system screen can be adjusted, refer to the "NAVIGATION SYSTEM OWNER'S MANUAL".</p>
❑ The image is blurry	
Dirt or foreign matter (such as water droplets, snow, mud etc.) is adhering to the camera.	Flush the camera with a large quantity of water and wipe the camera lens clean with a soft and wet cloth.
❑ The image is out of alignment	
The camera or surrounding area has received a strong impact.	Have the vehicle inspected by your Lexus dealer.

Likely cause	Solution
❑ The guide lines are very far out of alignment	
The camera position is out of alignment.	Have the vehicle inspected by your Lexus dealer.
<ul style="list-style-type: none"> • The vehicle is tilted (there is a heavy load on the vehicle, tire pressure is low due to a tire puncture, etc.) • The vehicle is used on an incline. 	If this happens due to these causes, it does not indicate a malfunction. Back up while visually checking the vehicle's surroundings.
❑ The estimated course lines move even though the steering wheel is straight	
There is a malfunction in the signals being output by the steering sensor.	Have the vehicle inspected by your Lexus dealer.
❑ Guide lines are not displayed	
The back door is open.	Close the back door. If this does not resolve the symptom, have the vehicle inspected by your Lexus dealer.
❑ "!" is displayed	
<ul style="list-style-type: none"> • The battery has been reinstalled. • The steering wheel has been moved while the battery was being reinstalled. • Battery power is low. • The steering sensor has been reinstalled. • There is a malfunction in the signals being output by the steering sensor. 	Stop the vehicle, and turn the steering wheel as far as it will go to the left and right. (Selecting "?" on the screen displays the operating procedure above.) If this does not resolve the symptom, have the vehicle inspected by your Lexus dealer.

**WARNING****■ When using the Lexus parking assist monitor system**

The parking assist monitor is a supplemental device intended to assist the driver when backing up. When backing up, be sure to check visually behind and all around the vehicle before proceeding.

Observe the following precautions to avoid an accident that could result in death or serious injuries.

- Never depend on the parking assist monitor entirely when backing up. The image and the position of the guide lines displayed on the screen may differ from the actual state.
Use caution, just as you would when backing up any vehicle.
- Be sure to back up slowly, depressing the brake pedal to control vehicle speed.
- If you seem likely to hit nearby vehicles, obstacles, people or mount the shoulder, depress the brake pedal to stop the vehicle.
- The instructions given are only guidelines.
When and how much to turn the steering wheel will vary according to traffic conditions, road surface conditions, vehicle condition, etc. when parking. It is necessary to be fully aware of this before using the parking assist system.
- When parking, be sure to check that the parking space will accommodate your vehicle before maneuvering into it.
- Do not use the parking assist monitor in the following cases:
 - On icy or slick road surfaces, or in snow
 - When using tire chains
 - When the back door is not closed completely
 - On roads that are not flat or straight, such as curves or slopes.
 - If the suspension has been modified or tires of a size other than specified are installed
- In low temperatures, the screen may darken or the image may become faint. The image could distort when the vehicle is moving, or you may become unable to see the image on the screen. Be sure to check direct visually and with the mirrors all around the vehicle before proceeding.
- If the tire sizes are changed, the position of the guide lines displayed on the screen may change.
- The camera uses a special lens. The distances between objects and pedestrians that appear in the image displayed on the screen will differ from the actual distances. (→P. 284)
- As the Rear Cross Traffic Alert display is displayed over the camera view, it may be difficult to see the Rear Cross Traffic Alert display depending on the color and brightness of the surrounding area.
- If the steering wheel is straight and the vehicle width guide lines and the estimated course lines are not in alignment, have the vehicle inspected by your Lexus dealer.

 NOTICE**■ How to use the camera**

- The parking assist monitor may not operate properly in the following cases.
 - If the back of the vehicle is hit, the position and mounting angle of the camera may change.
 - As the camera has a water proof construction, do not detach, disassemble or modify it. This may cause incorrect operation.
 - When cleaning the camera lens, flush the camera with a large quantity of water and wipe it with a soft and wet cloth. Strongly rubbing the camera lens may cause the camera lens to be scratched and unable to transmit a clear image.
 - Do not allow organic solvent, car wax, window cleaner or glass coat to adhere to the camera. If this happens, wipe it off as soon as possible.
 - If the temperature changes rapidly, such as when hot water is poured on the vehicle in cold weather, the system may not operate normally.
 - When washing the vehicle, do not apply intensive bursts of water to the camera or camera area. Doing so may result in the camera malfunctioning.
- Do not expose the camera to strong impact as this could cause a malfunction. If this happens, have the vehicle inspected by your Lexus dealer as soon as possible.

Multi-terrain Select*

Multi-terrain Select is a system that helps drivability in off-road situations.

- ▶ When the Crawl Control is turned off

Select a mode that most closely matches the type of terrain on which you are driving from among 5 modes.

Brake control can be optimized in accordance with the selected mode.

- ▶ When the Crawl Control is turned on

A mode which matches the road conditions is automatically selected by depressing the accelerator pedal (AUTO mode).

Multi-terrain Select dial/indicators

- ① Multi-information display
The selected Multi-terrain Select mode will be displayed on the multi-information display.
- ② Multi-terrain Select mode selector dial
- ③ Multi-terrain Select indicator

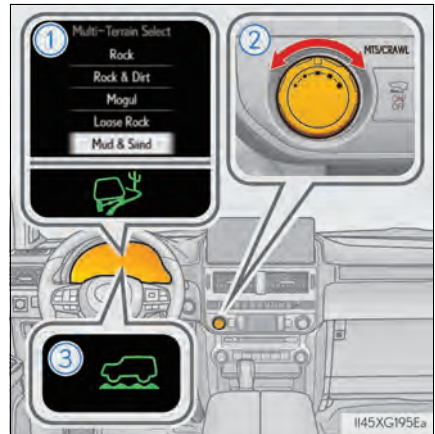

Selectable modes

- ▶ When the Crawl Control is turned off

A mode which matches the road conditions can be selected from among the following 5 modes.

- ①  : MUD & SAND mode

Suitable for muddy roads, sandy roads, snow-covered roads, dirt trails and other slippery or dirty conditions. The MUD&SAND mode indicator illuminates on the multi-information display.

- ②  : LOOSE & ROCK mode

Suitable for slippery conditions consisting of mixtures of earth and loose rock. The LOOSE & ROCK mode indicator illuminates on the multi-information display.

- ③  : MOGUL mode

Suitable for very bumpy road conditions, such as mogul roads. MOGUL mode indicator illuminates on the multi-information display.

- ④  : ROCK & DIRT mode

Suitable for very bumpy road conditions, such as mogul or rocky roads. ROCK &DIRT mode indicator illuminates on the multi-information display.

- ⑤  : ROCK mode

Suitable for rocky roads. ROCK mode indicator illuminates on the multi-information display.

- ▶ When the Crawl Control is turned on

-  : MTS AUTO mode

The most suitable mode is automatically selected according to the selected Crawl Control mode. MTS AUTO indicator illuminates on the multi-information display.

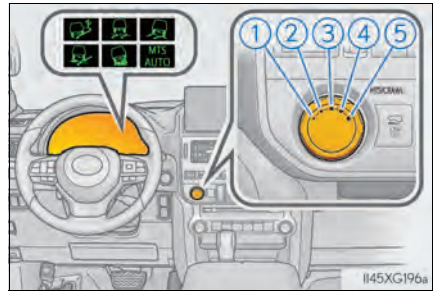

Multi-terrain Select control starting conditions

When all of the following conditions are satisfied, the Multi-terrain Select indicator will come on, the mode select screen will be displayed on the multi-information display, and Multi-terrain Select control will begin.

- The four-wheel drive control switch is in “L4”.
- Both Active TRAC and VSC are not off.

Switching modes

Operate the Multi-terrain Select mode selector dial during Multi-terrain Select control to select a mode.

Once the mode is confirmed, the mode name will be displayed and the control will switch.



■ Automatic system cancelation

In the following situations, the Multi-terrain Select indicator will go off, and Multi-terrain Select will be canceled automatically.

- When the four-wheel drive control switch is in H4.
- When Active TRAC and VSC are off.

■ When it is difficult to generate traction

MUD & SAND mode provides the largest amount of tire slippage, followed by LOOSE ROCK, MOGUL, ROCK & DIRT and ROCK mode.

Drivability can be improved by selecting a mode which provides a smaller amount of tire slippage than the current mode when the amount of tire slippage is large, or conversely selecting a mode which provides a larger amount of tire slippage than the current mode when the amount of tire slippage is small.

■ When the vehicle is stuck

Switching the transfer and differential

For the operation of the following functions, refer to the following pages.

- Four-wheel drive system (→P. 357)
- Center differential lock (→P. 358)

■ When the brake system operates continuously

The brake system may overheat. In this case, a buzzer will sound, the TRAC OFF indicator will flash, and Multi-terrain Select will be temporarily inoperable. In this event, stop the vehicle immediately in a safe place, and allow the brake system to cool down sufficiently. (There is no problem with continuing normal driving.)

After a short time, the TRAC OFF indicator will go off, and you will be able to use Multi-terrain Select.

■ When there is a malfunction in the system

The slip indicator light will come on. Have the vehicle inspected by your Lexus dealer immediately.

 WARNING**■ When using the Multi-terrain Select**

Observe the following precautions to avoid an accident that could result in death or serious injuries:

- There is a chance that the selected mode may not be the most appropriate in terms of road conditions such as pitch, slipperiness, undulation, etc. (→P. 293)
- Multi-terrain Select is not intended to expand the limits of the vehicle. Check the road conditions thoroughly beforehand, and drive safely and carefully.

 NOTICE**■ Precaution for use**

The Multi-terrain Select is intended for use during off-road driving. Do not use the system at any other time.

Multi-terrain Monitor*

The Multi-terrain Monitor helps the driver to check the vehicle surroundings. It assists in determining the conditions around the driver in a variety of situations, such as when judging conditions during off-road driving or checking for obstacles when parking.

The screen illustrations used in this text are intended as examples, and may differ from the image that is actually displayed on the screen.

WARNING

■ When using the Multi-terrain Monitor system

Observe the following precautions to avoid an accident that could result in death or serious injuries.

- Never rely solely on the Multi-terrain Monitor. As with unequipped vehicles, drive carefully while directly confirming the safety of your surroundings and the area to the rear of the vehicle. Take particular care to avoid parked cars and other obstacles.
- Due to the characteristics of the camera lens, the actual position and distance of people and other obstacles will differ from those shown on the Multi-terrain Monitor screen. Directly confirm the safety of your surroundings before driving.
- Do not drive while only looking at the screen. When driving, make sure to directly confirm the safety of your surroundings, such as by visually checking the area and using the vehicle's mirrors.
- In low temperatures, the screen may darken or the images may become faint. Images of moving objects in particular may distort or disappear from the screen. Therefore, make sure to drive carefully while directly visually confirming the safety of your surroundings.

Multi-terrain Monitor screens

The following screens can be selected according to driving conditions.

- Screens that can be selected vary depending on conditions such as shift position and vehicle speed. (→P. 304)
- Depending on the displayed screen, the display can be switched from normal to wide view display.

■ Screens when the four-wheel drive control switch is in L4

- When checking the area to the front and sides of the vehicle

▶ Front view & dual side views

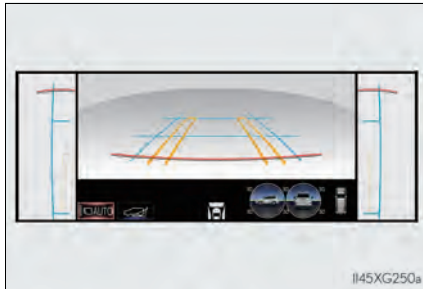

→P. 308

▶ Front view (magnified)

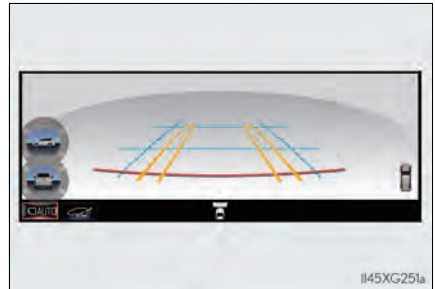

→P. 308

- When checking the condition of the road surface under the vehicle

▶ Under vehicle terrain view & dual side views



→P. 311

▶ Under vehicle terrain view (magnified)

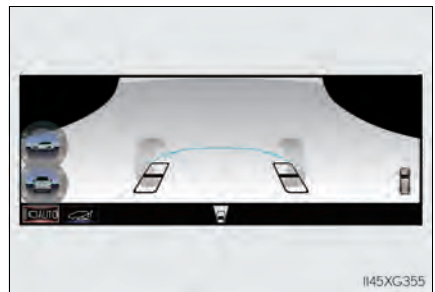

→P. 311

▶ Under vehicle terrain view (rear wheel) & dual side views



→P. 314

▶ Under vehicle terrain view (rear wheel) (magnified)

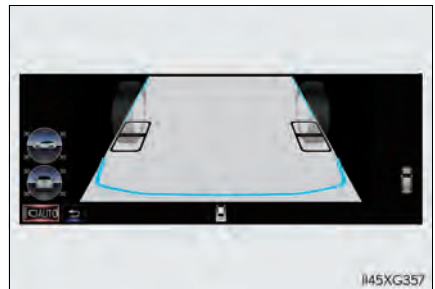

→P. 314

- When checking the area to the rear of the vehicle

▶ Rear view & dual side views



→P. 317

▶ Wide rear view & dual side views



→P. 317

■ Screens when the four-wheel drive control switch is in H4

- When checking the area to the around of the vehicle

▶ Moving view

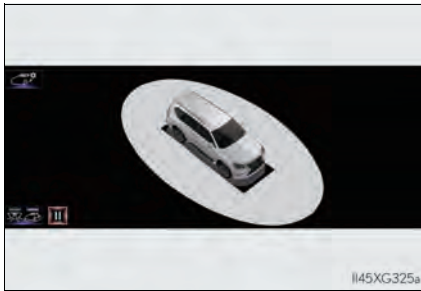

→P. 319

▶ See-through view



→P. 319

- When checking the area to the front of the vehicle (panoramic view & wide front view)

→P. 320



- When checking the area to the sides of the vehicle (panoramic view & side views)

→P. 323

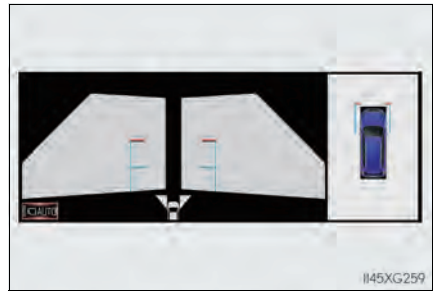

- When checking the area to the rear of the vehicle

▶ Panoramic view & rear view

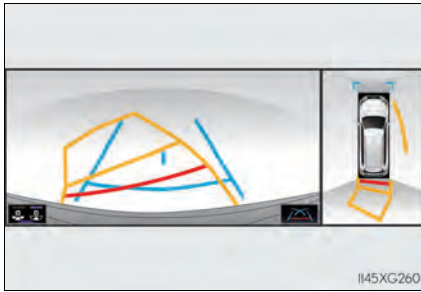

→P. 326

▶ Panoramic view & wide rear view



→P. 326

- When checking the area to the sides, front and rear of the vehicle (with outside rear view mirrors retracted)

▶ Wide front view & dual side views



→P. 332

▶ Rear view & dual side views

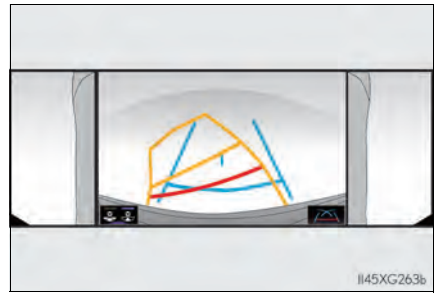

→P. 332

▶ Wide rear view & dual side views



→P. 332

Using the Multi-terrain Monitor screen

■ Displaying the Multi-terrain Monitor screen

The Multi-terrain Monitor screen will be displayed when the VIEW switch is pressed while the engine switch is in IGNITION ON mode.

When the vehicle speed exceeds a certain value for a specific amount of time, the display returns to the navigation or information display screen.

The amount of time that the Multi-terrain Monitor is displayed differs depending on conditions such as the vehicle speed. (→P. 308)

- ① VIEW switch
- ② Display

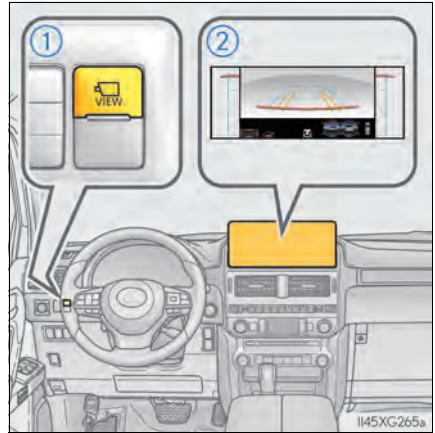

■ Switch operations

On some screens, the display mode or display settings can be changed using the switches.

● Automatic display mode switch

When automatic display mode is turned on, the Multi-terrain Monitor screen is displayed in the following conditions, even if the VIEW switch has not been operated.

- The shift lever is shifted to D or N
- While driving, the vehicle speed drops to approximately 6 mph (10 km/h) or less (except when the shift lever is in R)

The automatic display mode switches between on and off each

time  is selected.



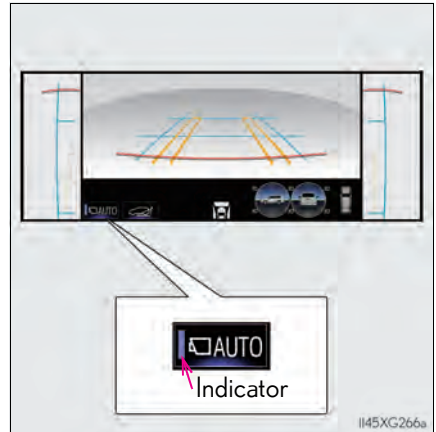

When automatic display mode is on, an indicator illuminates on the icon.

Even when automatic display mode is on, the display can still be switched by pressing the VIEW switch.



- Display selection switches

The following switches can be pressed or selected to switch the Multi-terrain Monitor display screen and to switch from normal to wide view display.

Switch		Switch Function
VIEW switch		Changing a display (→P. 304)
Angle mode selection switch		Switches between the wide rear view and wide view display (→P. 317, 326)
Under vehicle terrain view selection switch		Switch the under vehicle terrain view (rear wheel) & dual side views (→P. 314)
Return switch		Return to the previous screen
Display mode selection switch		Switches between the moving view and see-through view (→P. 319)

Changing the Multi-terrain Monitor screen

The screen display can be switched by operating the switches as follows while the Multi-terrain Monitor screen is displayed. (Screens that can be displayed will vary depending on the positions of the shift lever and four-wheel drive control switch)

The monitor displays various views of the position of the vehicle. (The following is an example)

■ Screens when the four-wheel drive control switch is in L4

- When the shift lever is in the P, D or N position

➡ : Press 

➡ : Select 

➡ : Select 

➡ : Select the Multi-terrain Monitor screen

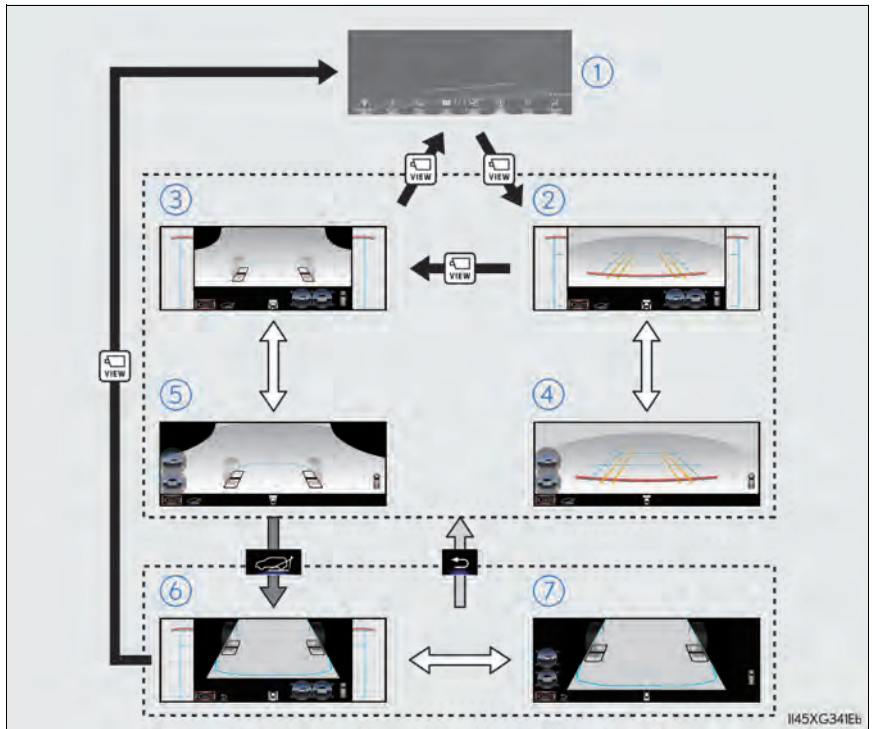

- ① Audio screen, etc.
- ② Front view & dual side views: →P. 308
- ③ Under vehicle terrain view & dual side views: →P. 311
- ④ Front view (magnified): →P. 308
- ⑤ Under vehicle terrain view (magnified): →P. 311
- ⑥ Under vehicle terrain view (rear wheel) & dual side views: →P. 314
- ⑦ Under vehicle terrain view (rear wheel) (magnified): →P. 314

- When the shift lever is in the R position

➡ : Select 



① Rear view & dual side views:
→P. 317

② Wide rear view & dual side views:
→P. 317

■ Screens when the four-wheel drive control switch is in H4

- When the shift lever is in the P position

➡ : Press 

➡ : Select 

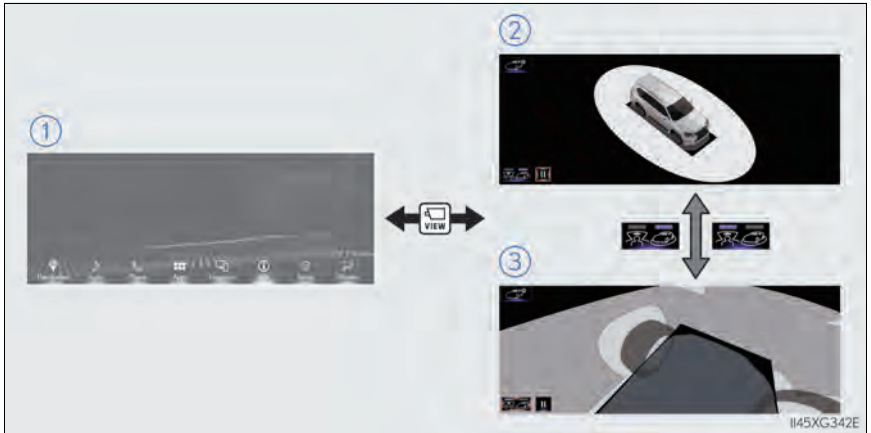

① Audio screen, etc.

② Moving view: →P. 319

③ See-through view: →P. 319

- When the shift lever is in the D or N position

➡ : Press 

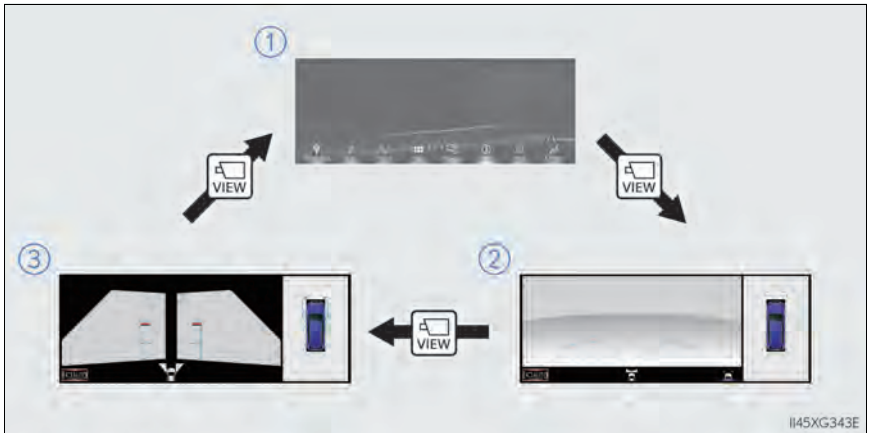

- ① Audio screen, etc.
- ② Panoramic view & wide front view: →P. 320
- ③ Panoramic view & side views: →P. 323

- When the shift lever is in the R position

➡ : Select 

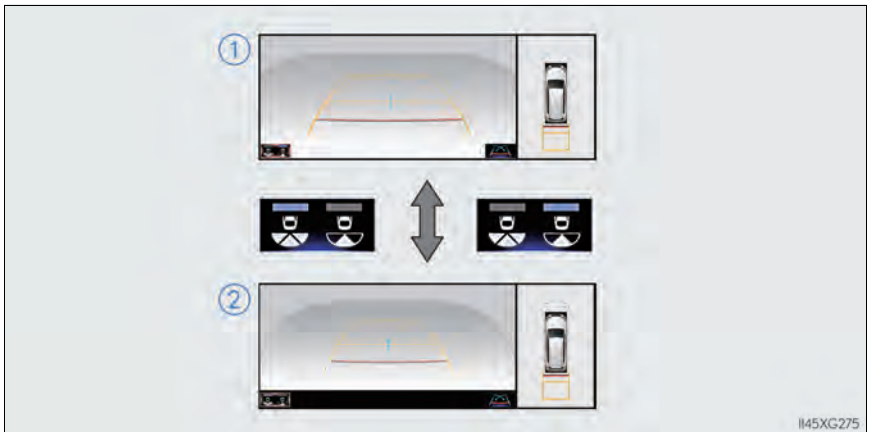

- ① Panoramic view & rear view: →P. 326
- ② Panoramic view & wide rear view: →P. 326

■ Multi-terrain Monitor screen display

The amount of time that the Multi-terrain Monitor screen is displayed changes as follows according to the vehicle speed at the time the VIEW switch was pressed.

The Multi-terrain Monitor screen is displayed if the vehicle speed is approximately 7 mph (12 km/h) or less when the camera switch is pressed.

If the vehicle speed exceeds approximately 7 mph (12 km/h), the Multi-terrain Monitor display is canceled.

Screen display and functions

When the four-wheel drive control switch is in L4, the various screens display information to support several different driving situations, such as when checking for obstacles when moving forward or in reverse, or when judging road surface conditions during off-road driving.

■ Front view & dual side views

Front view & dual side views can be used to check the area around the front of the vehicle.

To display the screen, press the VIEW switch when the shift lever is in the P, D or N position.

- In addition to an image of the front of the vehicle, guide lines are displayed in a composite view to provide reference for when deciding a direction to move forward in.
- If the front view display is selected while the screen is displayed, the screen switches from normal to magnified display. (Selecting the display again returns the screen to the normal display)
- If the steering wheel is turned 270° or more, guide lines and other features to support turning are automatically displayed.

● Screen description

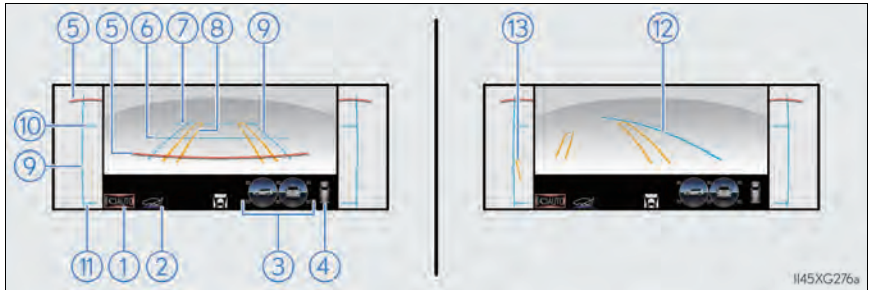

- ① Automatic display mode selection switch
→P. 302
- ② Under vehicle terrain view (rear wheel) selection switch
Switch the under vehicle terrain view (rear wheel) & dual side views.
(→P. 314)
- ③ Tilt meter
Displays the vehicle's estimated degree of incline. (→P. 310)
- ④ Intuitive parking assist/slip display
Displayed if an obstacle is detected while the intuitive parking assist is turned on.
- ⑤ 1.5 ft. (0.5 m) distance guide line (red)
- ⑥ 3 ft. (1 m) distance guide line (blue)
- ⑦ 6 ft. (2 m) distance guide line (blue)
Items ⑤ to ⑦ indicate the estimated distance from the front end of the vehicle.
- ⑧ Front tire course line (yellow)
Indicates the estimated course of the front tires according to steering wheel position.
- ⑨ Vehicle width lines (blue)
Indicate the width of the vehicle including the outside rear view mirror.
- ⑩ Front tire contact line (blue)
- ⑪ Rear tire contact line (blue)
Items ⑩ and ⑪ indicate estimated tire positions on the image.
- ⑫ Forward movement guide line (blue)
Indicates the estimated tire course of the tightest possible turn.
- ⑬ Rear tire course line (yellow)
Indicates the estimated course of the rear tires.

● Tilt meter

Tilt meter displays the vehicle inclination to the front, rear, left and right within a range of 0° to approximately 40°.

① Degree markers of incline to the left and right

Indicates the vehicle inclination in degrees in the left and right directions.

② Degree markers of incline to the front and rear

Indicates the vehicle inclination in degrees in the front and rear directions.

③ Pointer

Indicates the degree of the vehicle inclination in comparison to a parallel line.

● Slip display

When tire slippage is detected, the tilt meter display area is automatically switched to the slip display.

① Tire display

Indicates the position of freely spinning tires in amber if the tire spins. (During Crawl Control is operating, all of the tires are indicated in amber.)

② Pop-up display of the intuitive parking assist

Displayed if an obstacle is detected while the intuitive parking assist is turned on.

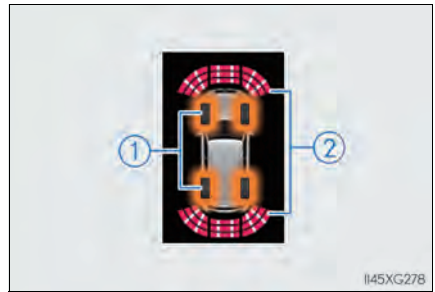
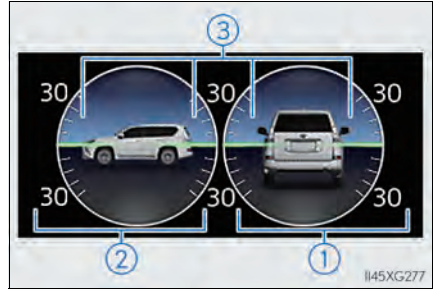

■ Front view & dual side views display

The screen can be displayed when the shift lever is in P, D or N.

■ Tilt meter display

- The display indicates the incline of the vehicle in degrees shown by the movement of the pointer and the rotation of the vehicle image.
- The color of the degree markers of incline to the front, rear, left and right changes according to the current incline of the vehicle.
- After the engine switch is turned to IGNITION ON mode, the degree of incline is not displayed until such information is determined.
- The degree of incline showed on the tilt meter is only an approximate indication, and may differ from the degree of incline measured using other equipment.

■ Under vehicle terrain view & dual side views

Lines indicating current vehicle and tire position are displayed in a composite view on an image taken behind the current vehicle position and assists the driver to check conditions underneath the vehicle or determine the position of the front tires.

To display the screen, press the VIEW switch when the shift lever is in the P, D or N position.

- If the under vehicle terrain view display is selected while the screen is displayed, the screen switches from normal to magnified display. (Selecting the display again returns the screen to the normal display)



- ① Current vehicle position
- ② Image displayed in the under vehicle terrain view (image taken behind the current vehicle position)
Switches the screen to under vehicle terrain view (magnified) display when you touch the display.
- ③ Vehicle position at the time the image was taken (behind the current vehicle position)

● Screen description



- ① Tire position indicator lines (black, white)
Indicates the estimated position of the front tires.
- ② Vehicle position indicator lines (blue)
Indicates the estimated position of the vehicle.

■ Under vehicle terrain view & dual side view

- The screen can be displayed when the shift lever is in P, D or N.
- While the under vehicle terrain view is displayed, if the vehicle speed reaches or exceeds approximately 7 mph (12 km/h), under vehicle terrain view will disappear.
- In the following situations, under vehicle terrain view will disappear.
 - After the engine starts or the system returns to normal, a fixed distance or more has not yet been driven
 - When the tires are slipping or spinning
 - ABS is activated
 - When there is a malfunction in the system
 - When the steering wheel is operated at or more than a specified steering angle
- If the outside rear view mirrors are folded while the under vehicle terrain view is being displayed, a separate screen is displayed.
- In the following situations, the system may not operate normally.
 - The road is covered with snow
 - When there are shadows due to light sources such as sunlight or illumination
 - When driving on slippery roads or tires are spinning
 - Dirt or foreign matter is adhering to the camera lens
 - There is water in front of the vehicle (a river, puddle, sea water, etc.)
 - Optional equipment has been installed
 - When the camera is covered or there is an object in the image capture range
 - Tires have been replaced
 - When the back door is open
 - When the steering wheel is operated at or more than a specified steering angle
 - On roads that are not flat, such as slopes



WARNING

■ Guide lines

The tire position indicator lines and vehicle position indicator lines may differ from actual vehicle positions depending on the number of passengers, cargo weight, road grade, road surface conditions, brightness of the surrounding environment, whether tires or suspension parts other than those specified are equipped, etc. Always drive the vehicle while confirming the safety of your surroundings.

■ Under vehicle terrain view display

The image displayed is one that was previously taken at a point behind the current vehicle position. In cases such as when objects move after the image is taken, the image displayed on the screen may differ from the actual state. In addition, when driving in the dark such as at night, there are cases when obstacles cannot be confirmed from the image.

■ Under vehicle terrain view (rear wheel) & dual side views

Lines indicating current vehicle and tire position are displayed in a composite view on an image taken behind the current vehicle position and assists the driver to check conditions underneath the vehicle or determine the position of the rear tires.

To display the screen, press the VIEW switch when the shift lever is in the P, D or N position, select the under vehicle terrain view (rear wheel) selection switch.

- If the under vehicle terrain view (rear wheel) display is selected while the screen is displayed, the screen switches from normal to magnified display. (Selecting the display again returns the screen to the normal display)

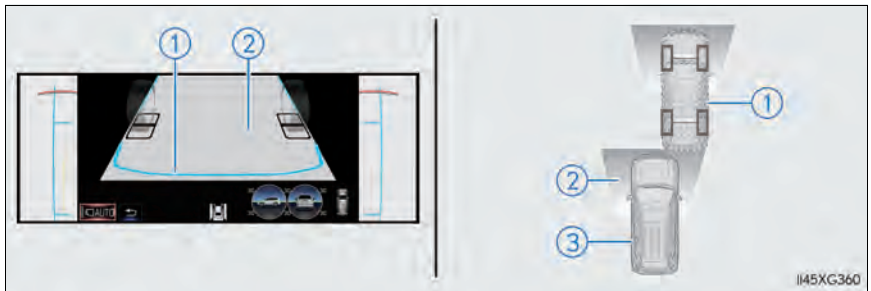

- ① Current vehicle position
- ② Image displayed in the under vehicle terrain view (rear wheel) (image taken behind the current vehicle position)
Switches the screen to under vehicle terrain view (rear wheel) (magnified) display when you touch the display.
- ③ Vehicle position at the time the image was taken (behind the current vehicle position)

● Screen description

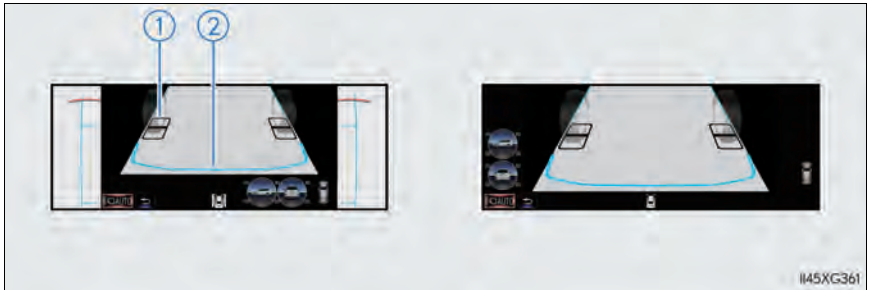

- ① Tire position indicator lines (black, white)
Indicates the estimated position of the rear tires.
- ② Vehicle position indicator lines (blue)
Indicates the estimated position of the vehicle.

■ Under vehicle terrain view (rear wheel)

- The screen can be displayed when the shift lever is in P, D or N.
- While the under vehicle terrain view (rear wheel) is displayed, if the vehicle speed reaches or exceeds approximately 3 mph (5 km/h), the screen automatically returns to the previous display.
- In the following situations, the display of the under vehicle terrain view (rear wheel) ends and the screen automatically returns to the most recently used camera screen. In addition, the under vehicle terrain view (rear wheel) selection switch cannot be operated until the next screen can be displayed.
 - After the engine starts or the system returns to normal, a fixed distance or more has not yet been driven
 - When the tires are slipping or spinning
 - ABS is activated
 - When there is a malfunction in the system
 - When the steering wheel is operated at or more than a specified steering angle
- If the outside rear view mirrors are folded while the under vehicle terrain view (rear wheel) is being displayed, a separate screen is displayed.

- In the following situations, the system may not operate normally or may not be able to switch to the under vehicle terrain view (rear wheel). In addition, the under vehicle terrain view (rear wheel) selection switch cannot be operated until the next screen can be displayed.
 - The road is covered with snow
 - When there are shadows due to light sources such as sunlight or illumination
 - When driving on slippery roads or tires are spinning
 - Dirt or foreign matter is adhering to the camera lens
 - There is water in front of the vehicle (a river, puddle, sea water, etc.)
 - Optional equipment has been installed
 - When the camera is covered or there is an object in the image capture range
 - Tires have been replaced
 - When the back door is open
 - When the steering wheel is operated at or more than a specified steering angle
 - On roads that are not flat, such as slopes

**WARNING****■ Guide lines**

The tire position indicator lines and vehicle position indicator lines may differ from actual vehicle positions depending on the number of passengers, cargo weight, road grade, road surface conditions, brightness of the surrounding environment, whether tires or suspension parts other than those specified are equipped, etc. Always drive the vehicle while confirming the safety of your surroundings.

■ Under vehicle terrain view (rear wheel) display

The image displayed is one that was previously taken at a point behind the current vehicle position. In cases such as when objects move after the image is taken, the image displayed on the screen may differ from the actual state. In addition, when driving in the dark such as at night, there are cases when obstacles cannot be confirmed from the image.

■ Rear view & dual side views/wide rear view & dual side views

The rear view & dual side views and the wide rear view & dual side views screen provide support when checking the areas of behind the vehicle and around the vehicle while backing up, for example while parking.

The screens will be displayed when the shift lever is in the R position.

● Screen description

The following 2 types of display mode can be selected according to conditions.

- ▶ Rear view & dual side views display
- ▶ Wide rear view display & dual side views display

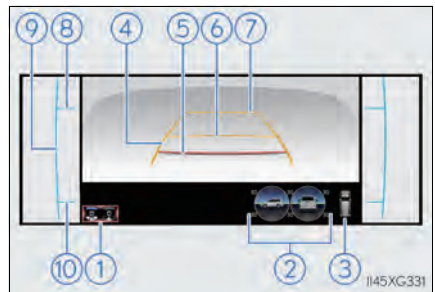
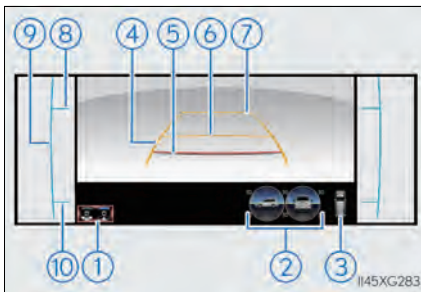

① Angle selection switch

Switches between rear view & dual side view display and wide rear view display each time the switch is selected.

② Tilt meter

→P. 310

③ intuitive parking assist/slip display

→P. 310

④ Projected course lines (yellow)

Indicate the estimated course of the vehicle according to steering operations.

⑤ 1.5 ft. (0.5 m) distance guide line (red)

⑥ 3 ft. (1 m) distance guide line (yellow)

⑦ 8 ft. (2.5 m) distance guide line (yellow)

⑤, ⑥ and ⑦ indicate the estimated distance from the rear end of the vehicle.

⑧ Front tire contact line (blue)

⑨ Vehicle width extension guide line (blue)

Indicates the estimated vehicle width including the outside rear view mirrors.

⑩ Rear tire contact line (blue)

Items ⑧ and ⑩ indicate estimated tire positions on the image.

- **Rear view & dual side views/wide rear view & dual side views**

The screen can be displayed when the shift lever is in R.

- **Guide lines**

If the back door is not closed, guide lines will not be displayed. If the guide lines do not display even when the back door is closed, have the vehicle inspected at your Lexus dealer.

**WARNING**

- **Guide lines**

The tire position indicator lines and vehicle position indicator lines may differ from actual vehicle positions depending on the number of passengers, cargo weight, road grade, road surface conditions, brightness of the surrounding environment, etc. Always drive the vehicle while confirming the safety of your surroundings.

Screen display and functions

When the four-wheel drive control switch is in H4, the various screens display information to support several different driving situations, such as when checking for obstacles when moving forward.

■ Moving view/See-through view

The moving view screen and the see-through view screen provide support when checking the areas of around the vehicle while parking. These screens display an image of the vicinity of the vehicle combined from the 4 cameras. The screen will display a 360° view around the vehicle from either inside the vehicle or from a birds-eye view at an angle.

To display the moving view/see-through view screen, press the VIEW switch when the shift lever is in the "P" position and the intuitive parking assist is enabled.

● Screen display

▶ Moving view



▶ See-through view

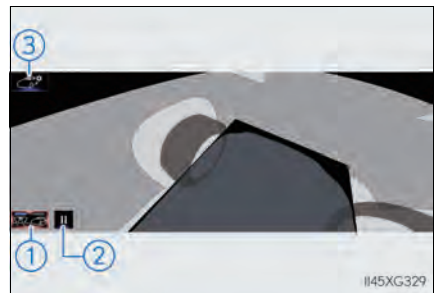

① Display mode selection switch

Select to change the display mode between the moving view and the see-through view.

② Rotation pause switch

Select to pause the rotation of the screen.

To resume rotation, select switch again.

③ Body color setting switch

Select to display the body color setting screen and change the color of the vehicle displayed on the panoramic view monitor.

- Changing the body color displayed in the panoramic view monitor

Select the desired color.

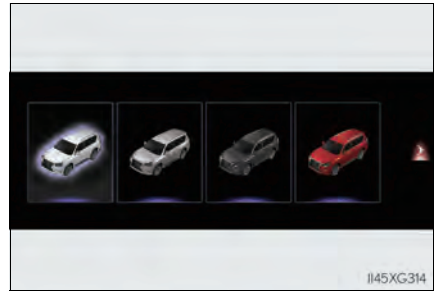

■ Panoramic view & wide front view

The panoramic view & wide front view screen provides support when checking the areas in front of the vehicle and around the vehicle when taking-off at T-intersections or other intersections during poor visibility.

To display the screen, press the VIEW switch when the shift lever is in the D or N position with the vehicle moving approximately 7 mph (12 km/h) or less.

This screen will be displayed if the intuitive parking assist detects an object in front of your vehicle when the vehicle is moving at approximately 6 mph (10 km/h) or less (intuitive parking assist linked display).

● Screen description

The following 2 types of display mode can be selected according to conditions.

▶ Distance guide line display mode

▶ Estimated course line display mode

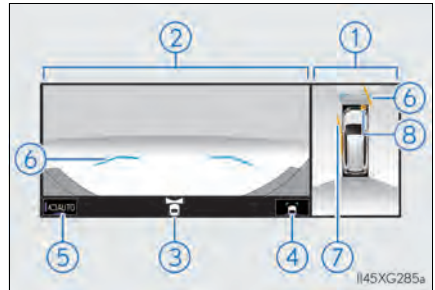
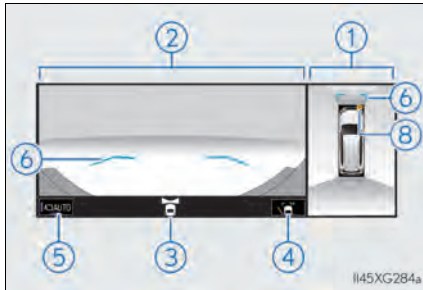

① Panoramic view

Displays an image looking down at the vehicle from above.

② Wide front view

Displays an image of the area to the front of the vehicle.

③ Display area

④ Guide line display selection switch

→P. 322

⑤ Automatic display mode selection switch

→P. 302

⑥ Front distance guide line (blue)

Indicates a distance approximately 3 ft. (1 m) from the front end of the vehicle.

⑦ Forward projected course lines

Automatically displayed when the steering wheel is turned 90° or more from the center position.

Indicates the estimated course of the vehicle according to steering wheel operations.

⑧ Intuitive parking assist



When the intuitive parking assist is on, an icon will be displayed when an obstacle is detected. (Refer to P. 267 for information about the intuitive parking assist.)

- Switching to automatic display mode

→P. 302

- Switching guide line display modes

The mode switches and the switch display changes each time the guide line display selection switch is selected.

Selected mode	Distance guide line display mode	Estimated course line display mode
Switch display		

■ Panoramic view & wide front view

The screen can be displayed when the shift lever is in D or N.

WARNING

■ Guide lines

The tire position indicator lines and vehicle position indicator lines may differ from actual vehicle positions depending on the number of passengers, cargo weight, road grade, road surface conditions, brightness of the surrounding environment, etc. Always drive the vehicle while confirming the safety of your surroundings.

■ Panoramic view & side views

The panoramic view & side views screen displays images from the cameras installed on each outside rear view mirror. This screen is designed to support the driver in safe driving in situations such as when driving on a narrow road, by allowing them to check the areas around the sides of the vehicle.

To display the screen, press the VIEW switch when the shift lever is in the D or N position with the vehicle moving approximately 7 mph (12 km/h) or less.

● Screen description

- ① Side view (left front side)
- ② Side view (right front side)
- ③ Display area
- ④ Vehicle width lines (blue)

Indicate the estimated vehicle width including the outside rear view mirrors.

- ⑤ Front distance guide line (red)

Indicates a distance approximately 1.6 ft. (0.5 m) from the front end of the vehicle.

- ⑥ Front tire contact line (blue)

Indicates the estimated front tire position on the image.

- ⑦ Automatic display mode selection switch

→P. 302

- ⑧ Intuitive parking assist

When the intuitive parking assist is on, an icon will be displayed when an obstacle is detected. (Refer to P. 267 for information about the intuitive parking assist.)

- ⑨ Panoramic view

Displays an image looking down at the vehicle from above.

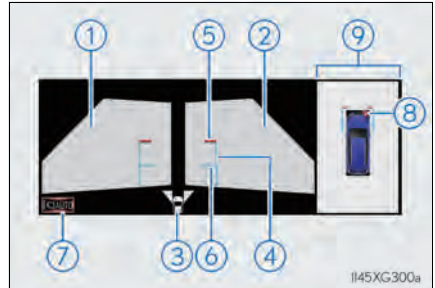

- Using the vehicle width lines

The relative distance of obstacles from the vehicle width lines can be confirmed.

Example 1: When there is an obstacle in front of the vehicle
Operate the steering wheel so that the vehicle width line and the obstacle do not overlap.



Example 2: When parking on the shoulder
Approach the shoulder, but do not allow the vehicle width line to overlap the curb or other obstacles.
After confirming the distance to the shoulder of the road, maneuvering the vehicle so that the vehicle width line and the curb or other obstacle are parallel allows the vehicle to be parked evenly.



■ Panoramic view & side views

- The screen can be displayed when the shift lever is in D or N.
- When the outside rear view mirrors are retracted, the displayed area changes. (→P. 332)

**WARNING****■ Guide lines**

The tire position indicator lines and vehicle position indicator lines may differ from actual vehicle positions depending on the number of passengers, cargo weight, road grade, road surface conditions, brightness of the surrounding environment, etc. Always drive the vehicle while confirming the safety of your surroundings.

■ Panoramic view & rear view/panoramic view & wide rear view

- Panoramic view & rear view:

The image looking down at the vehicle from above and the image from the rear camera are displayed simultaneously and assist the driver to check the safety of the area when parking.

- Panoramic view & wide rear view:

The image from the rear camera is displayed in a range of approximately 180° and assists the driver to check the safety of the area when backing up.

● Screen description

- ▶ Panoramic view & rear view

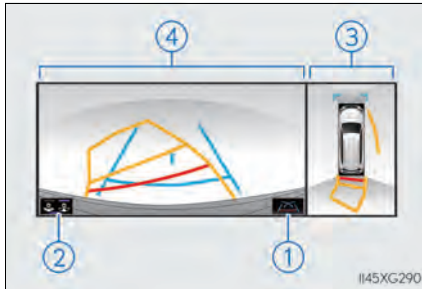

- ▶ Panoramic view & wide rear view

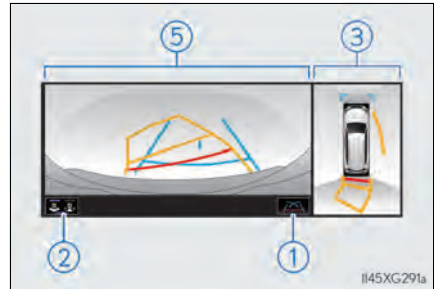

- ① Guide line selection switch

→P. 322

- ② Angle mode selection switch

Switches between the panoramic view & rear view and panoramic view & wide rear view display each time the switch is selected.



- ③ Panoramic view

- ④ Rear view

- ⑤ Wide rear view

● Switching modes

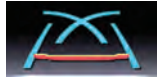
The display mode switches and the icon display changes each time the guide line display selection switch is selected.

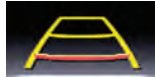
Selected mode	Estimated course line display mode	Parking assist guide line display mode	Distance guide line display mode
Icon display			

- Estimated course line display mode:
Estimated course lines that change according to steering wheel operations are displayed.
- Parking assist guide line display mode:
Inverted steering wheel operations (parking assist guide line) are displayed. Use this mode if you are used to how the vehicle handles (if you can park without needing the course line display).
- Distance guide line display mode:
Only distance guide lines are displayed.

● Guide lines

The panoramic view & rear view screen is explained here as an example.

▶ Distance guide line mode

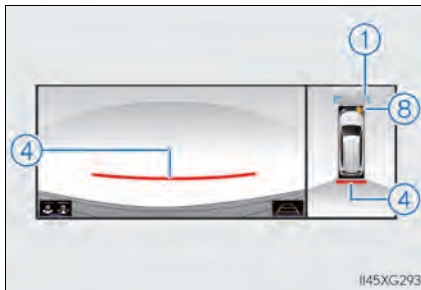

▶ Estimated course line display mode

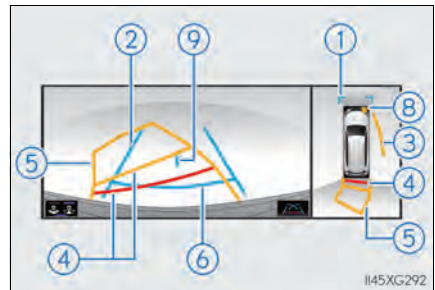

► Parking assist guide line display mode

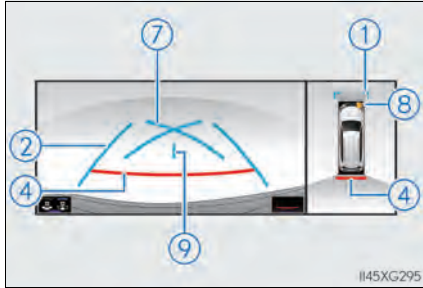

① Front distance guide line (blue)

Indicates a distance approximately 3 ft. (1 m) from the front end of the vehicle.

② Rear vehicle width extension guide lines

Indicate the estimated course of the vehicle when backing up straight.

- The displayed width is wider than the actual vehicle width.
- In projected course line display mode, this item overlaps the projected course lines when going straight.

③ Side projected course line (yellow)

Indicates the projected reverse course calculated by the angle of the steering wheel.

The projected reverse course line on the outside of the turn is displayed according to the direction of the steering wheel.

④ Rear distance guide line

Indicates the estimated distance from the end of the rear bumper (at the center). (Red line: approximately 1.5 ft. [0.5 m] away. Yellow line: approximately 3 ft. [1 m] away.)

In projected course line display mode, the rear distance guide line changes according to steering wheel operations.

⑤ Projected reverse course (yellow)

Changes according to steering wheel operations and indicates the estimated course of the vehicle.

⑥ Rear distance guide line (blue)

Indicates a distance approximately 1.5 ft. (0.5 m) from the end of the rear bumper (at the center).

⑦ Parking assist guide line (blue)

Indicates the estimated tire course of the tightest possible turn in reverse.

⑧ Intuitive parking assist

When the intuitive parking assist is on, an icon will be displayed when an obstacle is detected. (Refer to P. 267 for information about the intuitive parking assist.)

⑨ Vehicle center line (blue)

Indicates the estimated vehicle center on the ground.

● Parking operation (using the estimated course line)

When parking in a space which is in the reverse direction to the space described in the procedure below, the steering directions will be reversed.

1 Shift the shift lever to the R position.

2 Turn the steering wheel so that the estimated course lines are within the parking space, and back up slowly.

① Parking space

② Estimated course lines

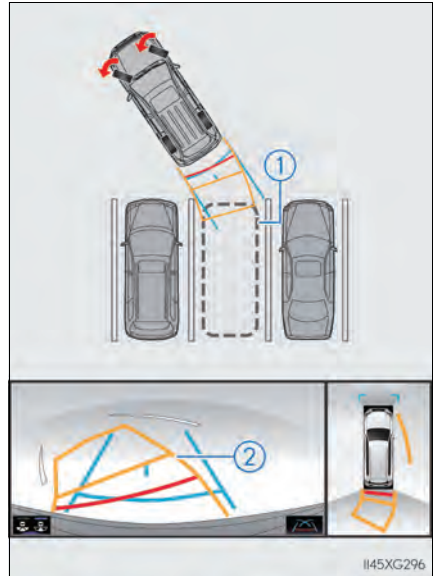

3 When the rear position of the vehicle has entered the parking space, turn the steering wheel so that the vehicle width extension guide lines are within the left and right dividing lines of the parking space.

③ Vehicle width extension guide line

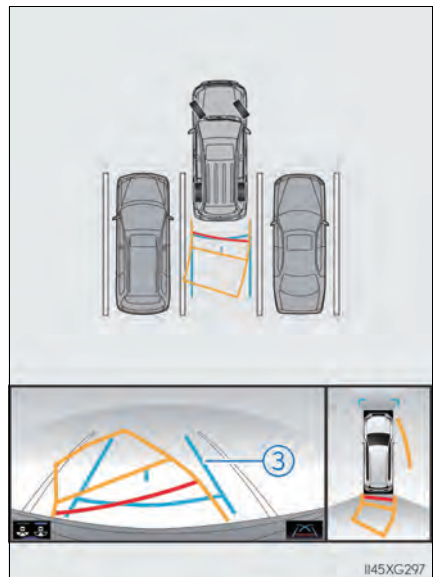

4 Once the vehicle width extension guide lines and the parking space lines are parallel, straighten the steering wheel and back up slowly until the vehicle has completely entered the parking space.

5 Stop the vehicle in an appropriate place, and finish parking.

● Parking operation (using the parking assist guide line)

When parking in a space which is in the reverse direction to the space described in the procedure below, the steering directions will be reversed.

1 Shift the shift lever to the R position.

2 Back up until the parking assist guide line meets the edge of the left-hand dividing line of the parking space.

① Parking assist guide line

② Parking space dividing line

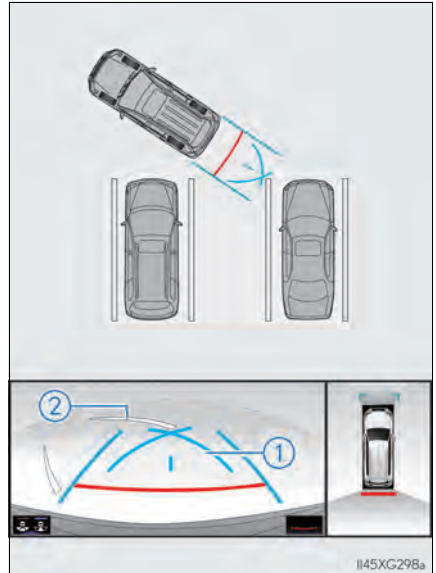

3 Turn the steering wheel all the way to the right, and back up slowly.

4 Once the vehicle is parallel with the parking space, straighten the steering wheel and back up slowly until the vehicle has completely entered the parking space.

5 Stop the vehicle in an appropriate place, and finish parking.

■ Panoramic view & rear view/panoramic view & wide rear view

The screen can be displayed when the shift lever is in R.

■ Guide lines

If the back door is not closed, guide lines will not be displayed. If the guide lines do not display even when the back door is closed, have the vehicle inspected at your Lexus dealer.

⚠ WARNING**■ Guide lines**

The tire position indicator lines and vehicle position indicator lines may differ from actual vehicle positions depending on the number of passengers, cargo weight, road grade, road surface conditions, brightness of the surrounding environment, etc. Always drive the vehicle while confirming the safety of your surroundings.

■ When using panoramic view & rear view or wide rear view

Rear vehicle width extension guide lines are displayed wider than the actual vehicle width. When backing up, always confirm the safety of your surroundings and the area to the rear of the vehicle.

■ Display when the outside rear view mirrors are retracted

Even when outside rear view mirrors are stored, the monitor can display various images of the vicinity of the vehicle and assist the operation in the confirming safe conditions in a narrow places, parking, etc.

● Screen description

- ▶ When the wide front view & dual side views is displayed
- ▶ When the rear view & dual side views is displayed

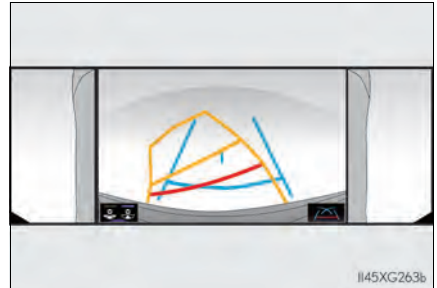

- ▶ When the wide rear view & dual side views is displayed



■ Screen display

When the main switch is pressed while the side view and wide front view are displayed, the navigation screen or information setting screen is displayed.

⚠ WARNING

■ Guide lines

The tire position indicator lines and vehicle position indicator lines may differ from actual vehicle positions depending on the number of passengers, cargo weight, road grade, road surface conditions, brightness of the surrounding environment, etc. Always drive the vehicle while confirming the safety of your surroundings.

■ Intuitive parking assist and RCTA cooperative display

When either the Intuitive parking assist (→P. 267) or Blind Spot Monitor (→P. 374) is turned on, a pop-up icon warns the driver when an obstacle is detected.

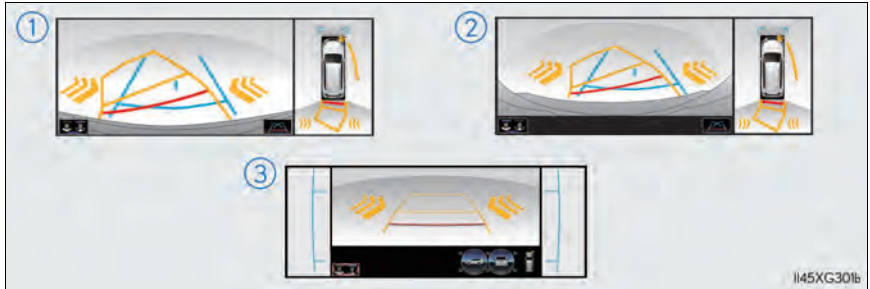

- ① Example of pop-up display in the panoramic view & rear view
- ② Example of pop-up display in the Panoramic view & wide rear view
- ③ Example of pop-up display in the Rear view & dual side views

■ Intuitive parking assist pop-up display

While the Intuitive parking assist is in use, a pop-up icon is displayed when an obstacle is detected (→P. 267).

However, this function only informs the driver that an obstacle is close to the vehicle and the detected obstacle is not displayed on the screen. Be sure to visually confirm the safety of your surroundings.

Magnifying function

If displayed objects are too small to see clearly when the panoramic view is displayed, the area around the front side or rear side of the vehicle can be magnified.

■ Magnifying the display

Select the area on the panoramic view display you wish to magnify.

- Selecting one of the 2 areas within the dotted lines will magnify that area. (Dotted lines are not displayed on the actual display.)
- To return to the normal view, select the panoramic view display again.

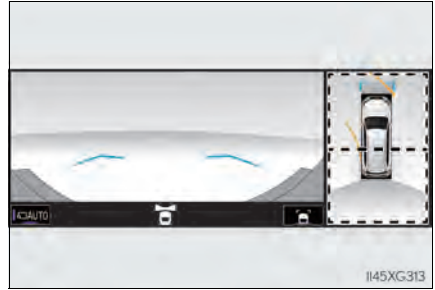

■ Magnifying the display

- The magnifying function is enabled when all of the following conditions are met:
 - The panoramic view & wide front view/panoramic view & side views/panoramic view & rear view/panoramic view & wide rear view is displayed.
 - The vehicle speed is below approximately 7 mph (12 km/h).
 - The intuitive parking assist is available.
- In the following situations, the magnified display will be canceled automatically:
 - The vehicle speed is approximately 7 mph (12 km/h) or higher.
 - The intuitive parking assist is unavailable.
- When the display is magnified, the guide lines will not be displayed.

When using the Multi-terrain Monitor

Observe the following precautions. Failure to do so may result in an unexpected accident. Also, when driving, make sure to directly confirm the safety of your surroundings and the area to the rear of the vehicle.

WARNING

■ Conditions under which the Multi-terrain Monitor should not be used

Do not use the Multi-terrain Monitor in the following situations. The system may not operate properly, resulting in an unexpected accident.

- When driving on an icy, snow-covered or otherwise slippery road surface
- When using tire chains or a spare tire
- When either front door or the back door is not completely closed
- When driving on an uneven road, such as a hill
- When tires or suspension parts other than those specified are equipped
When the tires are replaced, the position indicated by the guide lines displayed on the screen may differ.
- When any aftermarket parts have been installed on the bumper area which is displayed by the camera.

■ Guide lines

The tire position indicator lines and vehicle position indicator lines may differ from actual vehicle positions depending on the number of passengers, cargo weight, road grade, road surface conditions, brightness of the surrounding environment, etc. Always drive the vehicle while confirming the safety of your surroundings.

 NOTICE**■ Panoramic view**

- In the panoramic view, the system combines images taken from the front, back, left and right side cameras into a single image. There are limits to the range and content that can be displayed. Understand the characteristics of this system before using.
- Image clarity may decline at the four corners of the panoramic view. However, this is not a malfunction, as these are the regions along the border of each camera image where the images are combined.
- Depending on lighting conditions near each of the cameras, bright and dark patches may appear on the panoramic view.
- The panoramic view display does not extend higher than the installation position and image capture range of each camera.
- There are blind spots around the vehicle and there are regions that are not displayed in the panoramic view.
- Three-dimensional objects displayed in wide front view or rear view may not be displayed in the panoramic view.
- People and other three-dimensional obstacles may appear differently when displayed in the panoramic view. (These differences include, among others, cases in which displayed objects appear to have fallen over, disappear near image processing areas, appear from image processing areas, or when the actual distance to an object differs from the displayed position.)
- The panoramic view will not be properly displayed when either front door or the back door is open.
- The vehicle icon displayed in the panoramic view is a computer generated image, and properties such as the color, shape and size will differ from the actual vehicle. Therefore, nearby three-dimensional objects may appear to be touching the vehicle, and actual distances to three-dimensional objects may differ from those displayed.

■ Display range

● Panoramic view

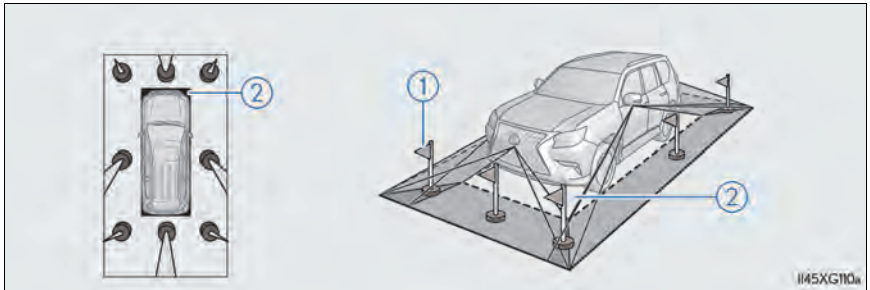

- ① Not displayed.
- ② Not displayed. (Displayed in black around the vehicle icon.)

● Wide front view

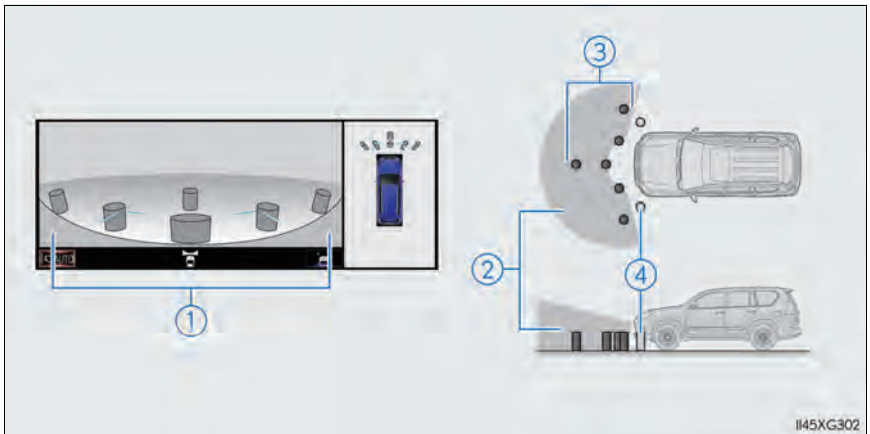

- ① Parts of the vehicle (such as the bumper or grille) are displayed on the screen.
- ② Camera visibility range
- ③ Object detectable by camera
- ④ Object not detectable by camera

- Side views

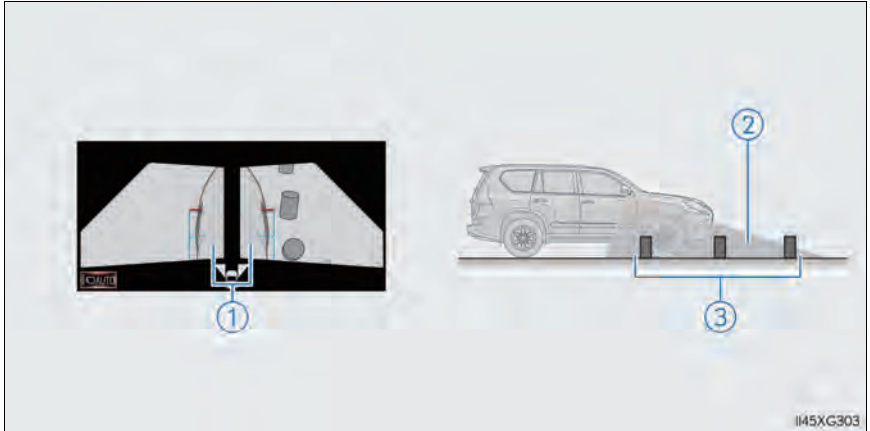

- ① The side of the vehicle is displayed on the screen.
- ② Camera visibility range
- ③ Object detectable by camera

- Side view

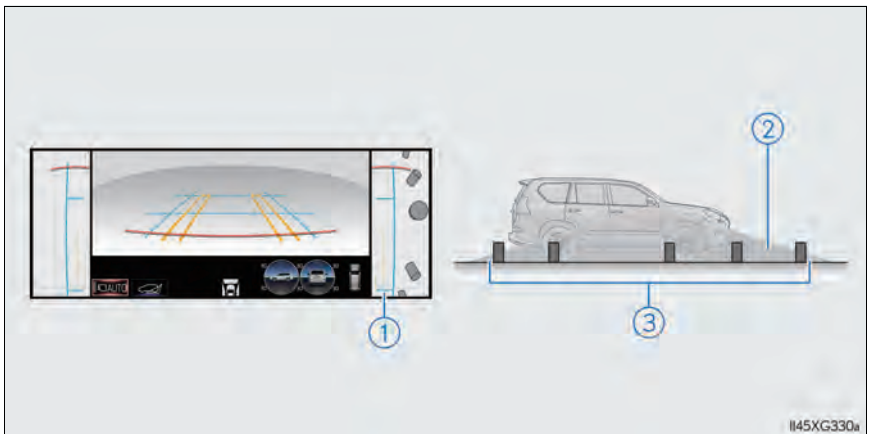

- ① The side of the vehicle is displayed on the screen.
- ② Camera visibility range
- ③ Object detectable by camera

- Rear view

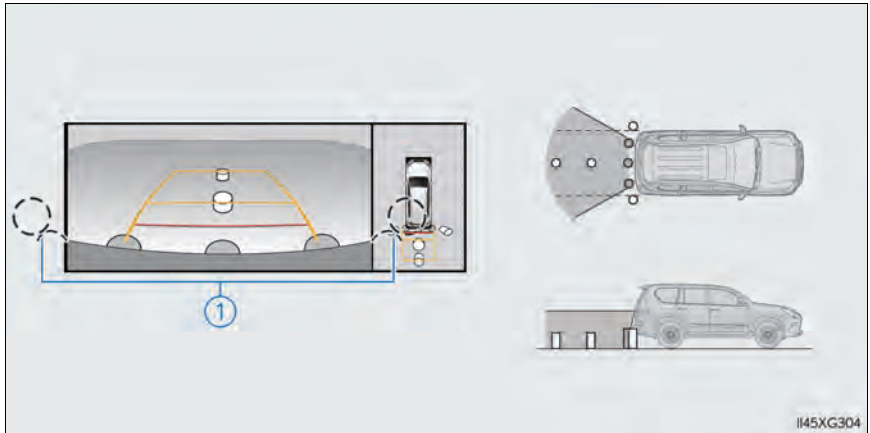

① The corners of the bumper are not seen on the screen.

- Wide rear view

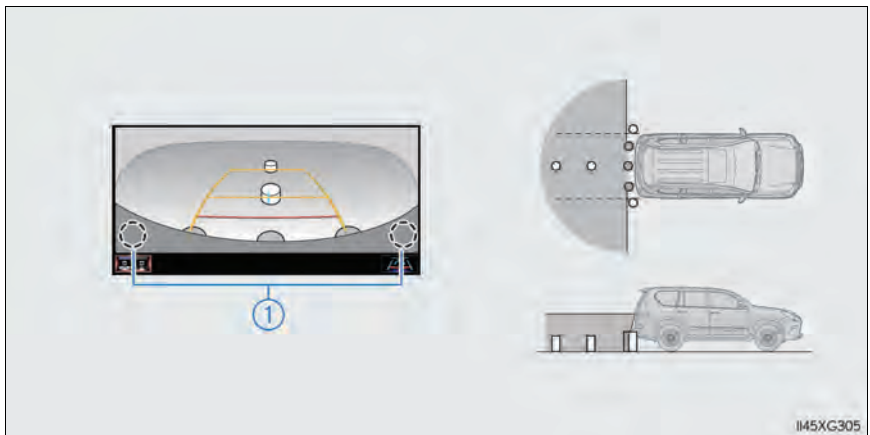

① The corners of the bumper are not seen on the screen.

■ Panoramic view display range

- In the panoramic view, the system processes and displays images acquired from the 4 cameras under the assumption that the vehicle is on a flat road surface. Therefore, the display may appear as follows.
 - Three-dimensional objects may appear to have fallen over, and be long and thin or bigger than they actually are
 - Three-dimensional objects at a point higher than the surface of the road may appear further away than they actually are, or may not appear
 - Tall objects may appear to emerge from the image processing seams
- Inconsistencies in the brightness of images from each camera may occur depending on lighting conditions.
- The displayed image may not be aligned when the tilt or height of the vehicle changed due to the number of passengers, cargo weight or remaining quantity of gasoline.
- The displayed image may not be aligned when the vehicle is in other than "N" (normal) height mode. (→P. 352)
- Images and guide lines may not be properly displayed when the doors are not completely closed.
- The relative distances between the vehicle icon and road surface or an obstacle displayed in the panoramic view may differ from the actual state.
- If an illuminated license plate is used, it may appear on the screen.
- The black area around the vehicle icon is an area that is not appear in the camera. Check these areas directly.
- The circled areas shown in the illustration may be difficult to see, as these are points where images are combined.

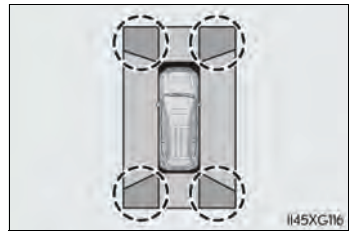

■ Wide front view display range

- There are limits to the range displayed on the screen. Objects at either corner of the bumper or directly below the bumper are not displayed.
- The perceived distance in images displayed on the screen differs from the actual distance.

■ Images displayed on the screen

Cameras of the Multi-terrain Monitor system use special lenses. The distance of the image that appears on the screen differs from the actual distance.

■ Multi-terrain Monitor cameras

● Camera positions

The cameras of the Multi-terrain Monitor system are installed as follows.

- ① Side camera (left and right sides)
- ② Front camera
- ③ Rear camera

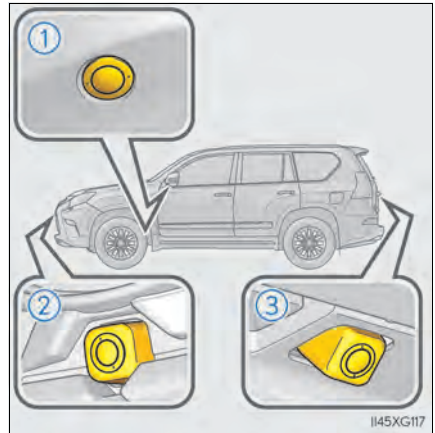

● Using the cameras

If dirt or foreign matter (such as water droplets, snow, mud, etc.) is adhering to the camera, it cannot transmit a clear image. In this case, flush it with a large quantity of water and wipe the camera lens with a soft and wet cloth.

⚠ NOTICE

■ How to use the cameras

- Observe the following precautions. Failure to do so may prevent the Multi-terrain Monitor from operating properly.
 - Do not strike the camera area, or allow any objects to bump into it
If the camera or surrounding area has received a strong impact, the camera position, installation angle, etc., may deviate. If the camera is accidentally subjected to an impact, have the vehicle inspected at your Lexus dealer.
 - Do not remove, disassemble or modify the camera or surrounding parts
Doing so may result in the camera malfunctioning. This also may result in a loss of waterproof performance.
 - If the camera lens is dirty, follow the above procedures to clean it
If the camera lens is damaged it cannot transmit a clear image.
Do not allow organic solvent, car wax, oil film remover, glass coating, etc. to contact the camera cover
Doing so will negatively affect the camera cover (resin). If this happens, wipe it off immediately.
 - When the outside temperature is cold, do not cause any sudden changes in temperature, such as by applying hot water
- When washing the vehicle, do not apply water with a high-pressure washer to the camera or surrounding area. Doing so may cause the camera to receive a strong impact, and the camera may not operate properly

■ Differences between the panoramic view screen and the actual road

The distance guide lines, the combined panoramic view image, guide lines, etc., indicate estimated distances on a flat road surface. In the following situations, actual distances and vehicle course will differ from the guide lines on the screen.

● When the ground behind the vehicle slopes up sharply

The distance guide lines will appear to be closer to the vehicle than the actual distance. Therefore, obstacles on an upward slope appear further away than they actually are. In the same way, the actual course of the vehicle will differ from the course indicated by the guide lines.

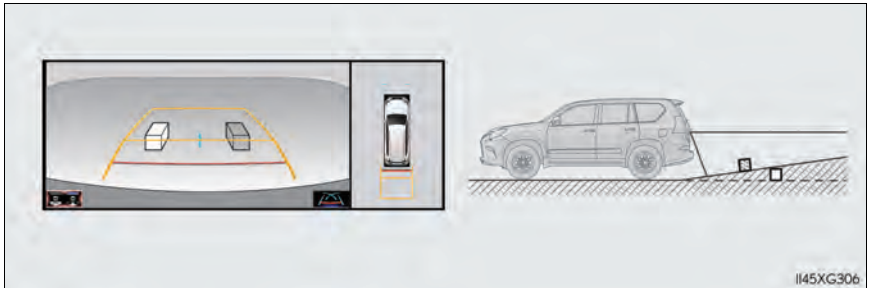

- When the ground behind the vehicle slopes down sharply

The distance guide lines are displayed further away than the actual distance. Therefore, obstacles on a downward slope appear closer than they actually are. In the same way, the actual course of the vehicle will differ from the course indicated by the guide lines.

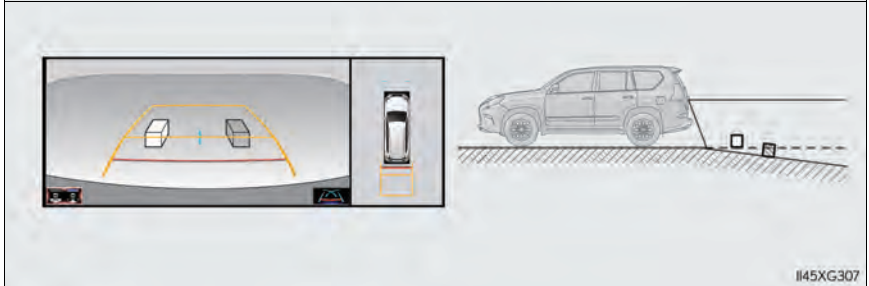

- When the vehicle is tilted

When the vehicle is tilted due to the number of passengers or weight of the load, actual distances and vehicle course will differ.

- ① Margin of error

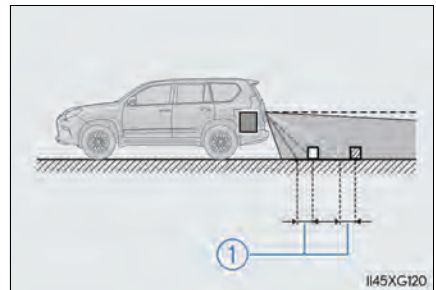

■ Differences between the panoramic view display and actual three-dimensional objects

Be aware of the following points when three-dimensional objects higher than the surface of the road (such as a vehicle bumper) are nearby.

● Panoramic view display

In the panoramic view, the system processes and displays images under the assumption that the vehicle is on a flat road surface. Therefore, the position of three-dimensional objects higher than the road surface (such as a vehicle bumper) cannot be determined. Even if it seems that a collision will not occur according to the screen, there may not actually be any extra space between the vehicle and an obstacle higher than the road surface, resulting in a collision. In these cases, confirm the safety of your surroundings directly.

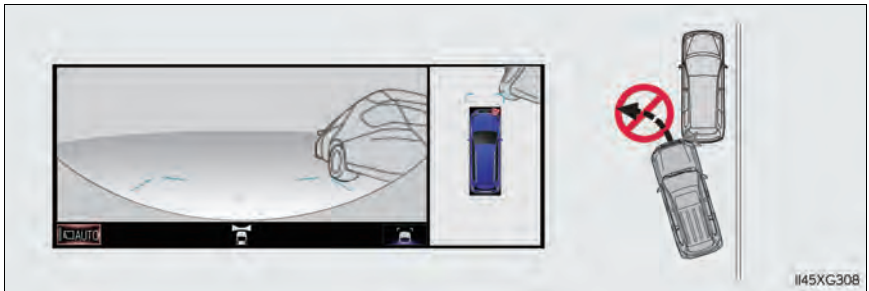

⚠ WARNING

■ Intuitive parking assist pop-up display

When the intuitive parking assist pop-up display is red, park the vehicle and make sure to confirm the safety of your surroundings.

Failure to do so may lead to an unexpected accident.

- Estimated course lines

Estimated course lines are displayed under the assumption that the vehicle is on a flat road surface. Therefore, the position of three-dimensional objects higher than the road surface (such as a vehicle bumper) cannot be determined. Even if it seems that an obstacle is outside of the estimated course lines and a collision will not occur according to the screen, an obstacle may actually be in the vehicle course, resulting in a collision.



- ① Estimated course lines

Three-dimensional objects in high positions (such as walls with protrusions or the loading areas of trucks) may not be displayed on the screen. Confirm the safety of your surroundings directly.



- ① Protrusion of a wall

■ Differences between the rear view or wide rear view and actual roads

The guide lines on the screen are intended for flat surfaces (such as the road). Be aware of the following points when three-dimensional objects with protrusions (obstacles such as the cargo bed of a truck) are nearby.

● Estimated course lines

Guide lines are displayed in reference to a level road surface and cannot be used to determine the location of three-dimensional objects. Confirm the safety of your surroundings directly. Even if it seems that the cargo bed of a truck is outside the estimated course lines and a collision will not occur according to the screen, it may actually be in the vehicle course, resulting in a collision.

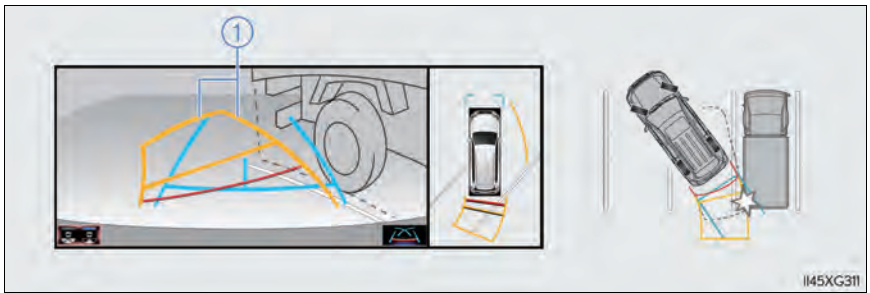

I145XG311

① Estimated course lines

■ Differences between the panoramic view, rear view and wide rear view and actual roads

● Distance guide lines

Guide lines are displayed in reference to the road surface and cannot be used to determine the distance of three-dimensional objects from the vehicle. Confirm the safety of your surroundings directly. On the screen, it appears that a truck is parking at point ② according to the distance guide lines. However, in reality if you back up to point ①, you will hit the truck. On the screen, it appears that ① is closest and ③ is farthest away. However, in reality, the distance to ① and ③ is same, and ② is farther than ① and ③.



● Under vehicle terrain view

The tire position indicator lines and vehicle position indicator lines may differ from actual vehicle positions depending on the number of passengers, weight of the load, road grade, road surface conditions, brightness of the surrounding environment, etc. Always drive the vehicle while directly confirming the safety of your surroundings.

■ Using under vehicle terrain view

- The images displayed were previously taken behind the current vehicle position. Therefore, actual conditions may differ from those shown on the screen in the following situations.
 - When conditions changed such as when an object moved or entered the frame after the image was taken.
 - Loose material like sand or snow has crumbled or shifted
 - An obstacle has moved
 - There is a puddle, tract of mud, etc., within the display range
 - The vehicle slips
- In the following situations, actual tire positions and vehicle position may differ from those indicated by the tire position indicator lines and vehicle position indicator lines.
 - Tires have been replaced
 - Optional equipment has been installed



WARNING

■ Guide lines

The displayed guide lines are composed with the image that was previously taken and may differ from the actual state.

Always drive the vehicle while confirming your surroundings.

■ If you notice any symptoms

If you notice any of the following symptoms, refer to the likely cause and the solution, and re-check.

If the symptom is not resolved by the solution, have the vehicle inspected by your Lexus dealer.

Likely cause	Solution
❑ The image is difficult to see	
<ul style="list-style-type: none"> • The vehicle is in a dark area • The temperature around the lens is either high or low • The outside temperature is low • There are water droplets on the camera • It is raining or humid • Foreign matter (mud etc.) is adhering to the camera • Sunlight or headlights are shining directly into the camera • The vehicle is under fluorescent lights, sodium lights, mercury lights, etc. 	<p>Drive while visually checking the vehicle's surroundings. (Use the Multi-terrain Monitor again once conditions have been improved.)</p> <p>The procedure for adjusting the picture quality of the Multi-terrain Monitor is same as the procedure for adjusting the navigation screen. Refer to the "NAVIGATION SYSTEM OWNER'S MANUAL".</p>
❑ The image is blurry	
Dirt or foreign matter (such as water droplets, snow, mud, etc.) is adhering to the camera	Flush the camera with a large quantity of water and wipe the camera lens with a soft and wet cloth.
❑ The image is out of alignment	
The camera or surrounding area has received a strong impact	Have the vehicle inspected by your Lexus dealer.
❑ The guide lines are very far out of alignment	
The camera position is out of alignment	Have the vehicle inspected at your Lexus dealer.
<ul style="list-style-type: none"> • The vehicle is tilted (there is a heavy load on the vehicle, tire pressure is low due to a tire puncture, etc.) • The vehicle is used on an incline 	<p>If this happens due to these causes, it does not indicate a malfunction.</p> <p>Drive while visually checking the vehicle's surroundings.</p>

Likely cause	Solution
<input type="checkbox"/> The projected course lines move even though the steering wheel is straight (vehicle width extension guide lines and projected course lines are not aligned)	
There is a malfunction in the signals being output by the steering sensor	Have the vehicle inspected by your Lexus dealer.
<input type="checkbox"/> Guide lines are not displayed	
The back door is open	Close the back door. If this does not resolve the symptom, have the vehicle inspected by your Lexus dealer.
<input type="checkbox"/> “!” is displayed	
<ul style="list-style-type: none"> • Battery has been reinstalled. • The steering wheel has been moved while the battery was being reinstalled. • Battery power is low. • The steering sensor has been reinstalled. • There is a malfunction in the signals being output by the steering sensor. 	Turn the steering wheel fully to right and left. If this does not resolve the symptom, have the vehicle inspected by your Lexus dealer.
<input type="checkbox"/> The panoramic view display cannot be magnified <input type="checkbox"/> The See-through view/Moving view cannot be displayed	
The intuitive parking assist may be malfunctioning or dirty.	Follow the correction procedures for malfunctions of the intuitive parking assist.

 NOTICE**■ How to use the camera**

- The Multi-terrain Monitor system may not operate properly in the following cases.
 - If the front or the rear of the vehicle or the outside rear view mirror has been hit, the camera's position and mounting angle may have changed.
 - As the camera has a water proof construction, do not detach, disassemble or modify it. This may cause incorrect operation.
 - When cleaning the camera lens, flush the camera with a large quantity of water and wipe it with a soft and wet cloth. Strongly rubbing the camera lens may cause the camera lens to be scratched and unable to transmit a clear image.
 - Do not allow organic solvent, car wax, window cleaner or glass coat to adhere to the camera. If this happens, wipe it off as soon as possible.
 - If the temperature changes rapidly, such as when hot water is poured on the vehicle in cold weather, the system may not operate normally.
 - When washing the vehicle, do not apply intensive bursts of water to the camera or camera area. Doing so may result in the camera malfunctioning.
 - When the camera is used under fluorescent lights, sodium light or mercury light etc., the lights and the illuminated areas may appear to flicker.
 - The camera can be damaged by flying rocks and other debris.
- Do not expose the camera to strong impact as this could cause a malfunction. If this happens, have the vehicle inspected by your Lexus dealer as soon as possible.

■ Product license**About Free / Open-Source Software Information**

This product includes the free / open-source software.

You can obtain either or both of the licensing information and the source code of these free / open-source software from the following URL.

<https://www.denso-ten.com/support/source/oem/pvm/info-t3/>

Rear height control air suspension *

The rear height control air suspension allows the driver to control vehicle rear height in order to adjust driving conditions. Select the desired height with the height control switch.

- ① Height control switch
- ② Height control OFF switch

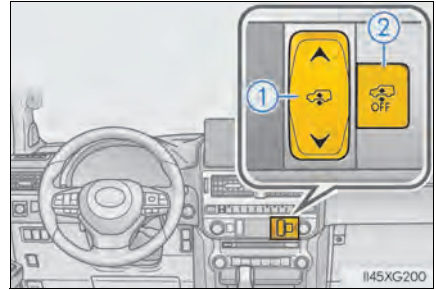

Selecting vehicle height

Operating the switch changes vehicle rear height as follows:

- ① Higher
- ② Lower

Vehicle height can be adjusted only when the engine is running.

The selected height mode will be shown on the multi-information display.

The selected mode will flash while the height mode is being changed.

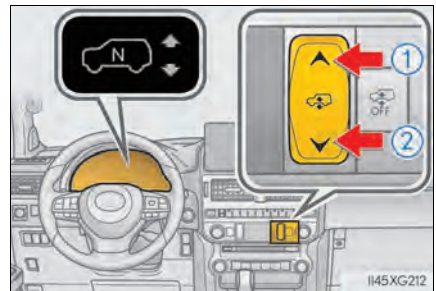

■ Height modes

- N mode (normal mode): For ordinary driving
Normal height
- HI mode (high mode): For driving on bumpy roads
1.6 in. (40 mm) higher than the normal rear height
HI mode cannot be selected when vehicle speed exceeds 18 mph (30 km/h).
- LO mode (low mode): For the ease of egress/ingress and loading luggage
0.8 in. (20 mm) lower than the normal rear height
LO mode cannot be selected when vehicle speed exceeds 7 mph (12 km/h).

Disabling the height control

When the height control OFF switch is pressed with the vehicle stopped, the vehicle height is fixed at the current height.

This status is memorized in the system even after the engine is stopped.

The height can be adjusted by pressing the height control OFF switch again.

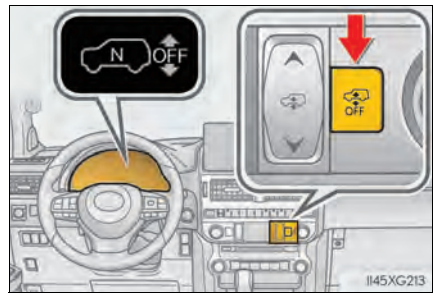

When vehicle speed exceeds 18 mph (30 km/h), the rear height control air suspension turns on automatically.

■ When HI mode is selected

The vehicle height will change to N mode when driving at the speeds of 18 mph (30 km/h). Even if vehicle speed is then reduced to under 18 mph (30 km/h), height will not return to HI mode.

■ When LO mode is selected

The vehicle height will change to N mode when vehicle speed exceeds 7 mph (12 km/h). Even if vehicle speed is then reduced to under 7 mph (12 km/h), height will not return to LO mode.

■ Automatic leveling function

Regardless of the number of occupants and the luggage load, vehicle height in any mode is always adjusted to a fixed height by the automatic leveling function.

■ The rear height control air suspension will not operate in the following cases:

- The underbody of the vehicle is touching the surface of the road.
- The area around the suspension is covered with ice.

■ Even if you hear an operating noise

This does not indicate a problem in the rear height control air suspension.

■ Parking and stopping tips

- If you immediately stop the engine after off-road driving, or park the vehicle for a long time, the vehicle height may gradually lower. When parking, make sure there is nothing under the vehicle that may come in contact with the underbody. The vehicle will return to the set height when the engine is started.
- The vehicle height may change as the temperature changes when the engine is stopped. The vehicle will return to the set height when the engine is started.

■ When lowering the vehicle

In order to prevent the vehicle height from rising as occupants leave the vehicle, lowering control will occur for a short while after the engine has been stopped.

■ The rear height control air suspension failure warning

- If a malfunction occurs in the rear height control air suspension, N mode is automatically selected. However, the system may not switch to N mode depending on the location of the malfunction.
- The "CHECK AIR SUSPENSION SYSTEM"/"Check air suspension system" is displayed on the multi-information display, and the rear height control air suspension cannot be activated until the malfunction is corrected.
Stop the engine and start it again. If the warning message turns off, the system is operating correctly. If the warning message continues to be displayed, have your vehicle inspected by your Lexus dealer as soon as possible.

 **WARNING****■ The rear height control air suspension must be turned off**

Be sure to observe the following precautions. Otherwise, the automatic leveling function may cause vehicle height to change, and you may catch part of your body in the vehicle, resulting in an accident:

- When jacking up the vehicle, installing tire chains or tying the vehicle with chains/wires for transportation via flatbed truck, turn off the rear height control air suspension and stop the engine.
- When the vehicle must be towed or disconnecting a trailer, put the vehicle height in N mode and turn off the rear height control air suspension.
- When the vehicle is stuck, turn off the rear height control air suspension.

■ Selecting the correct height mode

- HI mode should only be used when driving on rough roads, for example when driving off-road.
Because the vehicle's center of gravity will become higher when in the mode, the vehicle may become unstable when turning abruptly, resulting in an accident.
- Do not select HI mode when loading cargo on the roof luggage carrier.
Because the vehicle's center of gravity will become higher when in the mode, the vehicle may become unstable when turning abruptly, resulting in an accident.
- Before lowering vehicle height, check that there is no one under the vehicle.

 **NOTICE****■ Be careful in any place where overhead space is limited**

The vehicle height will rise when a higher mode is selected or cargo is unloaded. This may cause damage to the vehicle.

■ Do not select LO mode when driving on bumpy roads

If the underbody of the vehicle touches a rugged road surface, the vehicle may be damaged.

■ Changing vehicle height

Do not change vehicle height frequently.
The compressor may overheat and stop operation.

■ When on the extremely uneven roads with rocks

Sometimes the vehicle height is not adjusted because it is judged as uneven road driving.

AVS (Adaptive Variable Suspension System)*

The driving modes can be selected to suit driving condition.

① Sport mode

For winding mountain road driving or high speed driving.

When in Sport mode, the "SPORT" indicator comes on in the multi-information display.

While in sport mode, press the COMF switch to change the driving mode to normal mode.

② Normal mode

For normal driving.

While in normal mode, press the SPORT switch to change the driving mode to sports mode.

While in normal mode, press the COMF switch to change the driving mode to comfort mode.

③ Comfort mode

When compared to normal mode, ride comfort is improved.

When in Comfort mode, the "COMFORT" indicator comes on in the multi-information display.

While in comfort mode, press the SPORT switch to change the driving mode to normal mode.

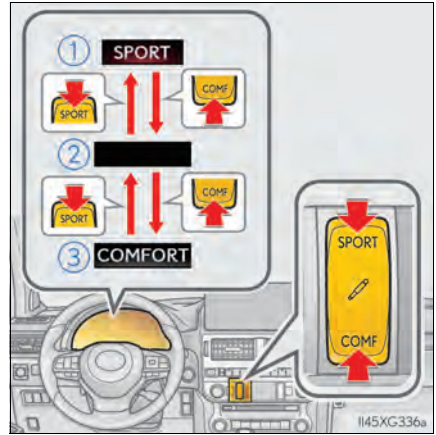

■ Driving mode

- Mode ① is suitable for heavy load or driving on a unpaved road.
- With the four-wheel drive control switch at L4, the damping effect suitable for off-road driving will be provided, regardless of the position of the AVS switch.

*: If equipped

Four-wheel drive system

Use the four-wheel drive control switch and center differential lock/unlock switch to select the following transfer and center differential modes.

Four-wheel drive control switch

- ① H4 (high speed position)
Normal driving on all types of roads.
- ② L4 (low speed position)
Driving requiring maximum power and traction such as climbing or descending steep hills, off-road driving, and hard pulling in sand or mud, etc.
The low speed four-wheel drive indicator will come on.



Center differential lock/unlock switch

Lock the center differential when your vehicle's wheels get stuck in a ditch or when driving on a slippery or bumpy surface.

The center differential lock indicator will come on.

Unlock the center differential after the wheels have been freed, or after moving to a flat, non-slippery surface.

To unlock the center differential, push the switch again.

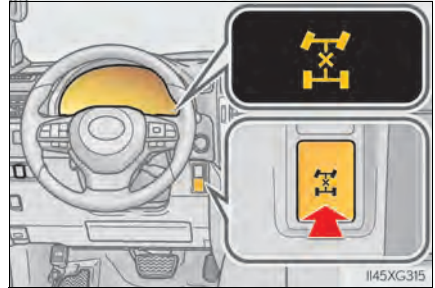

Shifting between H4 and L4

■ Shifting from H4 to L4

- 1 Stop the vehicle completely with brake pedal held down.
- 2 Shift the shift lever to N.
- 3 Push and shift the four-wheel drive control switch to L4.

Maintain this condition until the low speed four-wheel drive indicator turns on.

■ Shifting from L4 to H4

- 1 Stop the vehicle completely with brake pedal held down.
- 2 Shift the shift lever to N.
- 3 Push and shift the four-wheel drive control switch to H4.

Maintain this condition until the low speed four-wheel drive indicator turns off.

■ When the four-wheel drive control switch can be operated

- The engine switch is in IGNITION ON mode.
- The shift lever is in the N position.
- The vehicle is stopped completely.

■ The low speed four-wheel drive indicator

- The indicator blinks while switching between H4 and L4.
- If the low speed four-wheel drive indicator continues to blink when you operate the four-wheel drive control switch to the H4 or L4 position, stop the vehicle completely, shift the shift lever securely into N and then operate the switch again.
- If the shift lever is moved before the low speed four-wheel drive indicator turns on/off, the transfer mode may not be shifted completely. The transfer mode disengages both the front and rear drive shafts from the powertrain and allows the vehicle to move regardless of the shift position. (At this time, the indicator blinks and the buzzer sounds.) Therefore, the vehicle is free to roll even if the shift lever is in P. You or someone else could be seriously injured. You must complete the shifting of the transfer mode and confirm that the indicator has turned off (H4) or turned on (L4).
- If the engine coolant temperature is too low, the four-wheel drive control system may not be able to shift. When the engine is warmer operate the switch again.

If the indicator continue to blink even if doing so, have the vehicle inspected by your Lexus dealer as soon as possible. There may be a trouble in the four-wheel drive system.

■ When the transfer mode is switched to L4

VSC is automatically turned off. (The VSC OFF indicator will come on.)

■ When the center differential lock/unlock switch can be operated

The engine switch is in IGNITION ON mode.

■ The center differential lock indicator

- The indicator blinks while locking/unlocking the center differential.
- If the center differential lock indicator blinks and the buzzer sounds when the center differential is locked, stop the slipping or spinning and push the switch again.

If the indicator continue to blink even if doing so, have the vehicle inspected by your Lexus dealer as soon as possible. There may be a trouble in the four-wheel drive system.

■ Locking/unlocking the center differential

- If the operation is not completed, the center differential lock indicator blinks. If the indicator does not turn off when unlocking the center differential, drive straight ahead while accelerating or decelerating, or drive in reverse.
- Avoid turning suddenly while the center differential is locked. If you do turn suddenly, the difference in turning speeds between the front and rear wheels may have a similar effect to braking, thus making driving difficult.

**WARNING****■ While driving**

Observe the following precautions. Failure to do so may cause an accident resulting in death or serious injury.

- Never move the four-wheel drive control switch if the wheels have lost traction.
- Do not operate the center differential lock/unlock when the vehicle is turning or when its wheels are spinning freely off the ground.

**NOTICE****■ To prevent damage to the center differential**

- For normal driving on dry and hard surface roads, unlock the center differential.
- Unlock the center differential after the wheels are out of the ditch or off the slippery or bumpy surface.

Crawl Control*

Allows travel on extremely rough off-road surfaces at a fixed low speed without pressing the accelerator or brake pedal. Minimizes loss of traction or vehicle slip when driving on slippery road surfaces, helping for stable driving.

Crawl Control switch/indicators

- ① Crawl Control ON/OFF switch
The indicator light on the switch comes on when operating.
- ② Crawl Control speed selector dial
- ③ Crawl Control indicators
The Crawl Control indicator is lit and the slip indicator flashes when operating.
- ④ Multi-information display
The selected multi-terrain select mode will be displayed on the multi-information display.

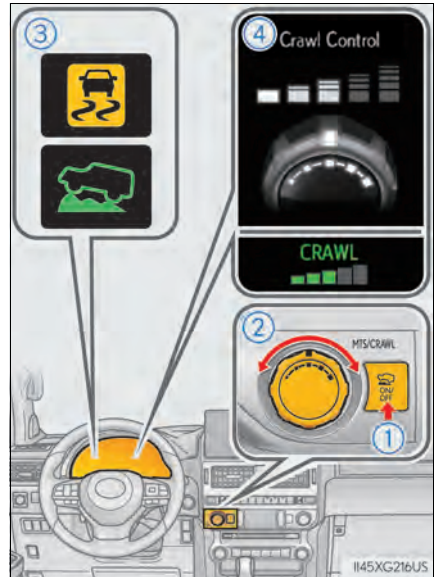

Speed modes

The following table shows some typical terrains and the recommended speed modes.

- ① Lo
- ② Lo-Med
- ③ Med
- ④ Med-Hi
- ⑤ Hi

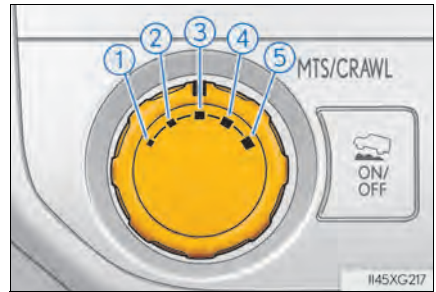

Mode		Road condition
①	Lo	Rock, mogul (downhill) and gravel (downhill)*
②	Lo-Med	Mogul (uphill)*
③	Med	Snow, mud, gravel (uphill), sand, dirt, mogul (uphill) and grass*
④	Med-Hi	
⑤	Hi	

*: Depending on the road surface, it may not be the most effective.

Switching modes

Operate the Crawl Control speed selector dial during Crawl Control to select a mode.

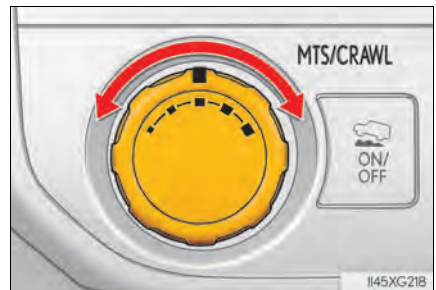

■ The Crawl Control can be operated when

- The shift lever is in any gear other than P or N.
- The four-wheel drive control switch is in L4.
- The driver's door is closed.

■ Automatic system cancelation

In the following situations, the system is canceled automatically:

At that time, the buzzer will sound, the slip indicator turns off, and the Crawl Control indicator flashes.

A notification will be displayed on the multi-information display for several seconds. (→P. 544)

- When the shift lever is moved to P or N.
- When the four-wheel drive control switch is in H4.
- When the driver's door is opened.

When turning off Crawl Control while traveling, stop the vehicle before the Crawl Control indicator turns off, or drive extremely carefully.

■ Function limit

- In the following situations, you will be able to use brake control to drive downhill at a fixed low speed, but you will be unable to use engine control to drive uphill at a fixed low speed.
 - When the driving mode is set to second start mode.
 - When the vehicle speed is higher than 6 mph (10 km/h).
- When the vehicle speed is higher than 15 mph (25 km/h), engine control and brake control will stop temporarily. At that time, the Crawl Control indicator flashes.

■ When the Crawl Control system is operated continuously

This may cause the brake actuator to overheat. In this case, the Crawl Control system will stop operating, a buzzer will sound, the Crawl Control indicator will turn off after flashing and the "TRAC OFF" indicator will come on. In this case, quickly stop the vehicle in a safe place and give the actuator adequate time to cool off. Refrain from using the system until the "TRAC OFF" indicator turns off. (The vehicle can be driven normally during this time.)

■ When depressing the accelerator pedal while the Crawl Control is operating

Multi-terrain Select operates in AUTO mode. (→P. 292)

■ If the automatic transmission system overheats

The system will cease operation, a buzzer will sound and a warning message will be displayed to alert the driver. Stop the vehicle in a safe place until the warning message turns off. (→P. 545)

■ Sounds and vibrations caused by the Crawl Control system

- A sound may be heard from the engine compartment when the engine is started or just after the vehicle begins to move. This sound does not indicate that a malfunction has occurred in Crawl Control system.
- Either of the following conditions may occur when the Crawl Control system is operating. None of these are indicators that a malfunction has occurred.
 - Vibrations may be felt through the vehicle body and steering.
 - A motor sound may be heard after the vehicle comes to a stop.

■ If the slip indicator comes on...

It may indicate a malfunction in the system. Consult your Lexus dealer.

**WARNING****■ When using Crawl Control**

Do not rely solely on the Crawl Control. This function does not extend the vehicle's performance limitations. Always thoroughly check the road conditions, and drive safely.

■ These conditions may cause the system not to operate properly

When driving on the following surfaces, the system may not be able to maintain a fixed low speed, which may result in an accident:

- Extremely steep inclines.
- Extremely uneven surfaces.
- Snow-covered roads, or other slippery surfaces.

Downhill assist control system*

The downhill assist control system helps to prevent excessive speed on steep downhill slopes.

The system will operate when the vehicle is traveling under 15 mph (25 km/h) with the accelerator and brake pedals released and the transfer mode is in L4.

System operation

Shift the “DAC” switch to ON. The downhill assist control system indicator will come on and the system will operate.

When the system is in operation, the slip indicator will flash, and the stop lights/high mounted stop lights will be lit. A sound may also occur during the operation. This does not indicate a malfunction.

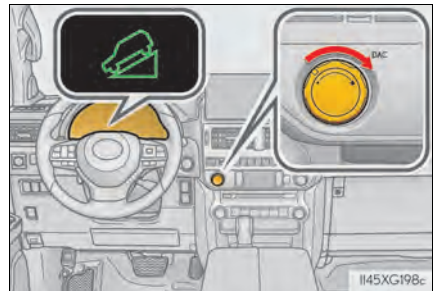

Turning off the system

Shift the “DAC” switch to OFF while the system is in operation. The downhill assist control system indicator will flash as the system gradually ceases operation, and will turn off when the system is fully off.

Shift the “DAC” switch to ON while the downhill assist control system indicator is flashing to start the system again.

*: If equipped

■ Operating tips

The system will operate when the shift lever is in a position other than P, however to make effective use of the system it is recommended to select a lower shift range.

■ The system will not operate when

The transfer mode is in H4.

■ If the downhill assist control system indicator flashes

● In the following situations, the indicator flashes and the system will not operate:

- The transfer mode is not in L4.
- The shift lever is in P.
- The accelerator or brake pedal is depressed.
- The vehicle speed exceeds approximately 15 mph (25 km/h).
- The brake system overheats.

● In the following situations, the indicator flashes to alert the driver, but the system will operate:

- The shift lever is in N.
- The “DAC” switch is turned off while the system is operating.
The system will gradually cease operation. The indicator will flash during operation, and then go off when the system is fully off.

■ When the downhill assist control system is operated continuously

This may cause the brake actuator to overheat. In this case, the downhill assist control system will stop operating, a buzzer will sound and the downhill assist control system indicator will start flashing, and the “TRAC OFF” indicator light will come on. Refrain from using the system until the downhill assist control system indicator stays on and “TRAC OFF” indicator light turns off. (The vehicle can be driven normally during this time.)

■ Sounds and vibrations caused by the downhill assist control system

- A sound may be heard from the engine compartment when the engine is started or just after the vehicle begins to move. This sound does not indicate that a malfunction has occurred in downhill assist control system.
- Either of the following conditions may occur when the downhill assist control system is operating. None of these are indicators that a malfunction has occurred.
 - Vibrations may be felt through the vehicle body and steering.
 - A motor sound may be heard after the vehicle comes to a stop.

■ System malfunction

In the following cases, have your vehicle checked by your Lexus dealer.

- The downhill assist control system indicator does not come on when the engine switch is turned to IGNITION ON mode.
- The downhill assist control system indicator does not come on when the “DAC” switch is shifted to ON.
- The slip indicator comes on.

 **WARNING****■ When using downhill assist control system**

Do not rely overmuch on the downhill assist control system. This function does not extend the vehicle's performance limitations. Always thoroughly check the road conditions, and drive safely.

■ The system may not operate on the following surfaces, which may lead to an accident causing death or serious injury

- Slippery surfaces such as wet or muddy roads
- Icy surface
- Unpaved roads

Driving assist systems

To keep driving safety and performance, the following systems operate automatically in response to various driving situations. Be aware, however, that these systems are supplementary and should not be relied upon too heavily when operating the vehicle.

◆ ABS (Anti-lock Brake System)

Helps to prevent wheel lock when the brakes are applied suddenly, or if the brakes are applied while driving on a slippery road surface

◆ Multi Terrain ABS (Anti-lock Brake System)

Helps to prevent wheel lock when the brakes are applied suddenly, or if the brakes are applied while driving on a slippery road surface, or in off-road conditions (such as rough roads, sand and mud)

Vehicles with Multi-terrain Select system: The Multi Terrain ABS operates in synchronization with the Multi-terrain Select

◆ Brake assist

Generates an increased level of braking force after the brake pedal is depressed when the system detects a panic stop situation

◆ VSC (Vehicle Stability Control)

Helps the driver to control skidding when swerving suddenly or turning on slippery road surfaces

◆ TRAC (Traction Control) for H4 position

Helps to maintain drive power and prevent the drive wheels from spinning when starting the vehicle or accelerating on slippery roads

◆ Active TRAC (Traction Control) for L4 position *

Helps to maintain drive power and prevent the 4 wheels from spinning when starting the vehicle or accelerating on slippery roads, or in off-road conditions

*: The function only works in vehicles with Multi-terrain Select when Multi-terrain Select is switched on

◆ Hill-start assist control

Helps to prevent the vehicle from rolling backward when starting on an incline or slippery slope

◆ KDSS (Kinetic Dynamic Suspension System)

KDSS helps to enhance ride comfort and handling response by using a hydraulic control system to control the suspension stabilizer bars in response to road surface and driving conditions during cornering or off-road driving

◆ Trailer Sway Control

Helps the driver to control trailer sway by selectively applying brake pressure for individual wheels and reducing driving torque when trailer sway is detected.

When the TRAC/Active TRAC/VSC/ABS/Multi Terrain ABS/Trailer Sway Control systems are operating

The slip indicator light will flash while the TRAC/Active TRAC/VSC/ABS/Multi Terrain ABS/Trailer Sway Control systems are operating.

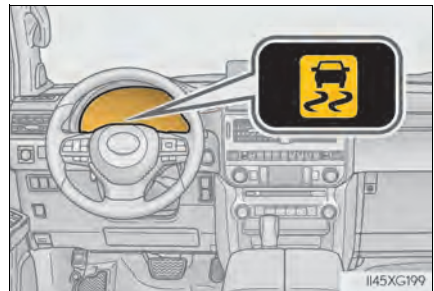

Disabling the TRAC/Active TRAC system

If the vehicle gets stuck in mud, dirt or snow, the TRAC/Active TRAC system may reduce power from the engine to the wheels. Pressing  to turn the system off may make it easier for you to rock the vehicle in order to free it.

To turn the TRAC/Active TRAC system off, quickly press and release .

The “TRAC OFF” indicator light will come on.

Press  again to turn the system back on.

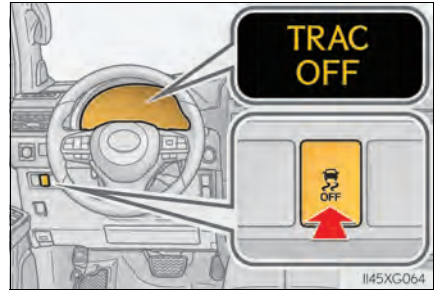

■ Turning off TRAC/Active TRAC, VSC and Trailer Sway Control systems

To turn the TRAC/Active TRAC, VSC and Trailer Sway Control systems off, press and hold  for more than 3 seconds while the vehicle is stopped.

The “TRAC OFF” indicator light and the VSC OFF indicator light will come on*.

Press  again to turn the systems back on.

*: Pre-collision brake assist and pre-collision braking will also be disabled. The PCS warning light will come on and the message will be shown on the multi-information display. (→P. 246)

■ When the “TRAC OFF” indicator light comes on even if has not been pressed

TRAC/Active TRAC is temporary deactivated. If the indicator light continues to remain on, contact your Lexus dealer.

■ Hill-start assist control operation conditions

- The shift lever is in D or S.
- The brake pedal is not depressed.

■ **Sounds and vibrations caused by the ABS/Multi Terrain ABS, brake assist, VSC, Trailer Sway Control, TRAC/Active TRAC and hill-start assist control systems**

- A sound may be heard from the engine compartment when the brake pedal is depressed repeatedly, when the engine is started or just after the vehicle begins to move. This sound does not indicate that a malfunction has occurred in any of these systems.
- Any of the following conditions may occur when the above systems are operating. None of these indicates that a malfunction has occurred.
 - Vibrations may be felt through the vehicle body and steering.
 - A motor sound may be heard also after the vehicle comes to a stop.
 - The brake pedal may pulsate slightly after the ABS/Multi Terrain ABS is activated.
 - The brake pedal may move down slightly after the ABS/Multi Terrain ABS is activated.

■ **Automatic reactivation of TRAC/Active TRAC, Trailer Sway Control and VSC systems**

After turning the TRAC/Active TRAC, Trailer Sway Control and VSC systems off, the systems will be automatically re-enabled in the following situations:

- When the engine switch is turned off
- If only the TRAC/Active TRAC system is turned off, the TRAC/Active TRAC will turn on when vehicle speed increases

If both the TRAC/Active TRAC and VSC systems are turned off, automatic re-enabling will not occur when vehicle speed increases.

■ **When the brake system operates continuously**

The brake actuator may overheat. In this case, the TRAC/Active TRAC and hill-start assist control systems will stop operating, a buzzer will sound and the "TRAC OFF" indicator will come on. Refrain from using the system until the message goes off. (There is no problem with continuing normal driving.)

■ **If the slip indicator comes on...**

It may indicate a malfunction in the TRAC/Active TRAC, VSC/Trailer Sway Control or hill-start assist control system. Consult your Lexus dealer.

■ **KDSS**

Some difference of vehicle height between left and right side can appear. This does not indicate a malfunction in the KDSS system. For more information, contact your Lexus dealer.

 **WARNING****■ The ABS/Multi Terrain ABS does not operate effectively when**

- The limits of tire gripping performance have been exceeded (such as excessively worn tires on a snow covered road).
- The vehicle hydroplanes while driving at high speed on wet or slick roads.

■ Stopping distance when the ABS/Multi Terrain ABS is operating may exceed that of normal conditions

The ABS/Multi Terrain ABS is not designed to shorten the vehicle's stopping distance. Always maintain a safe distance from the vehicle in front of you, especially in the following situations:

- When driving on dirt, gravel or snow-covered roads
- When driving with tire chains
- When driving over bumps in the road
- When driving over roads with potholes or uneven surfaces

■ TRAC/Active TRAC/VSC may not operate effectively when

Directional control and power may not be achievable while driving on slippery road surfaces, even if the TRAC/Active TRAC/VSC system is operating.

Drive the vehicle carefully in conditions where stability and power may be lost.

■ Hill-start assist control does not operate effectively when

Do not overly rely on the hill-start assist control. The hill-start assist control may not operate effectively on steep inclines and roads covered with ice.

■ When the TRAC/Active TRAC/VSC/Trailer Sway Control is activated

The slip indicator light flashes. Always drive carefully.

Reckless driving may cause an accident. Exercise particular care when the indicator light flashes.

■ When the TRAC/Active TRAC/VSC/Trailer Sway Control systems are turned off

Be especially careful and drive at a speed appropriate to the road conditions. As these are the systems to help ensure vehicle stability and driving force, do not turn the TRAC/Active TRAC/VSC/Trailer Sway Control systems off unless necessary.

Trailer Sway Control is part of the VSC system and will not operate if VSC is turned off or experiences a malfunction.

 **WARNING****■ Replacing tires**

Make sure that all tires are of the specified size, brand, tread pattern and total load capacity. In addition, make sure that the tires are inflated to the recommended tire inflation pressure level.

The ABS/Multi Terrain ABS, TRAC/Active TRAC, Trailer Sway Control and VSC systems will not function correctly if different tires are installed on the vehicle.

Contact your Lexus dealer for further information when replacing tires or wheels.

■ Handling of tires and the suspension

Using tires with any kind of problem or modifying the suspension will affect the driving assist systems, and may cause a system to malfunction.

■ Trailer Sway Control precaution

The Trailer Sway Control system is not able to reduce trailer sway in all situations. Depending on many factors such as the conditions of the vehicle, trailer, road surface and driving environment, the Trailer Sway Control system may not be effective. Refer to your trailer owner's manual for information on how to tow your trailer properly.

■ If trailer sway occurs

Observe the following precautions.

Failing to do so may cause death or serious injury.

- Firmly grip the steering wheel. Steer straight ahead.
Do not try to control trailer sway by turning the steering wheel.
- Begin releasing the accelerator pedal immediately but very gradually to reduce speed.
Do not increase speed. Do not apply vehicle brakes.

If you make no extreme correction with the steering or brakes, your vehicle and trailer should stabilize. (→P. 195)

BSM (Blind Spot Monitor)

Summary of the Blind Spot Monitor

The Blind Spot Monitor is a system that has 2 functions;

- The Blind Spot Monitor function
Assists the driver in making the decision when changing lanes
- The Rear Cross Traffic Alert function
Assists the driver when backing up

These functions use same sensors.

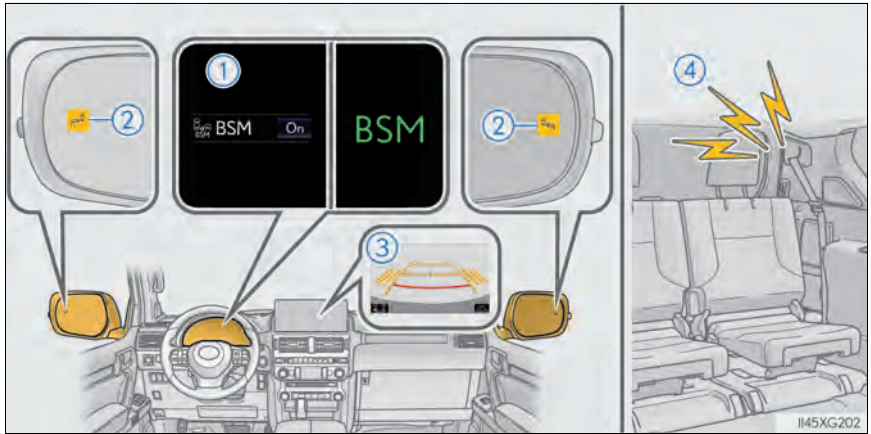

① The Blind Spot Monitor on/off screen and indicator

The Blind Spot Monitor system can be turned on/off on the multi-information display. When the system is set to on, the indicator illuminates in the meter and the buzzer sounds. The Blind Spot Monitor function and the Rear Cross Traffic Alert function are turned on/off simultaneously.

② Outside rear view mirror indicator

The Blind Spot Monitor function:

When a vehicle is detected in the blind spot, the outside rear view mirror indicator comes on while the turn signal lever is not operated. If the turn signal lever is operated toward the detected side, the outside rear view mirror indicator flashes.

The Rear Cross Traffic Alert function:

When a vehicle approaching from the right or left rear of the vehicle is detected, the outside rear view mirror indicators flash.

③ Monitor screen display (The Rear Cross Traffic Alert function only)



If a vehicle approaching from the right or left at the rear of the vehicle is detected, the Rear Cross Traffic Alert icon (→P. 381) for the detected side will be displayed on the monitor screen.





This illustration shows an example of a vehicle approaching from the left at the rear of the vehicle.

④ The Rear Cross Traffic Alert buzzer (The Rear Cross Traffic Alert function only)

When a vehicle approaching from the right or left rear of the vehicle is detected, a buzzer sounds from behind the rear seat.

Turning the Blind Spot Monitor system on/off

1 Press  or  of the meter control switches and select  on the multi-information display.

2 Press  or  of the meter control switches and select , and then press .

Each pressing of the switch turns the Blind Spot Monitor on and off.

■ The outside rear view mirror indicators visibility

When under strong sunlight, the outside rear view mirror indicator may be difficult to see.

■ The Rear Cross Traffic Alert buzzer hearing

The Rear Cross Traffic Alert buzzer may be difficult to hear over loud noises such as high audio volume.

■ When “BSM NOT AVAILABLE”/“BSM not available” is shown on the multi-information display

The sensor voltage has become abnormal, water, snow mud, etc., may be built up in the vicinity of the sensor area of bumper (→P. 376). Removing the water, snow, mud, etc., from the vicinity of the sensor area bumper should return it to normal. Also, the sensor may not function normally when used in extremely hot or cold weather.

■ When “CHECK BSM SYSTEM”/“Check BSM system” is shown on the multi-information display

There may be a sensor malfunction or misaligned. Have the vehicle inspected by your Lexus dealer.



WARNING

■ To ensure the system can operate properly

One Blind Spot Monitor sensor is installed inside the left and right side of the vehicle rear bumper respectively. Observe the following to ensure the Blind Spot Monitor can function correctly.

- Keep the sensor and its surrounding area on the bumper clean at all times.

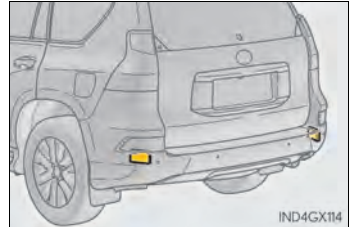

- Do not subject a sensor or its surrounding area on the rear bumper to a strong impact.
If a sensor is moved even slightly off position, the system may malfunction and vehicles may not be detected correctly.
In the following situations, have your vehicle inspected by your Lexus dealer.
 - A sensor or its surrounding area is subject to a strong impact.
 - If the surrounding area of a sensor is scratched or dented, or part of them has become disconnected.
- Do not disassemble the sensor.
- Do not attach accessories or stickers to the sensor or surrounding area on the bumper.
- Do not modify the sensor or surrounding area on the bumper.
- Do not paint the rear bumper any color other than an official Lexus color.

The Blind Spot Monitor function

The Blind Spot Monitor function uses radar sensors to detect vehicles that are traveling in an adjacent lane in the area that is not reflected in the outside rear view mirror (the blind spot), and advises the driver of the vehicle's existence via the outside rear view mirror indicator.

The Blind Spot Monitor function detection areas

The areas that vehicles can be detected in are outlined below.

The range of the detection area extends to:

- ① Approximately 11.5 ft. (3.5 m) from the side of the vehicle
The first 1.6 ft. (0.5 m) from the side of the vehicle is not in the detection area
- ② Approximately 9.8 ft. (3 m) from the rear bumper
- ③ Approximately 3.3 ft. (1 m) forward of the rear bumper

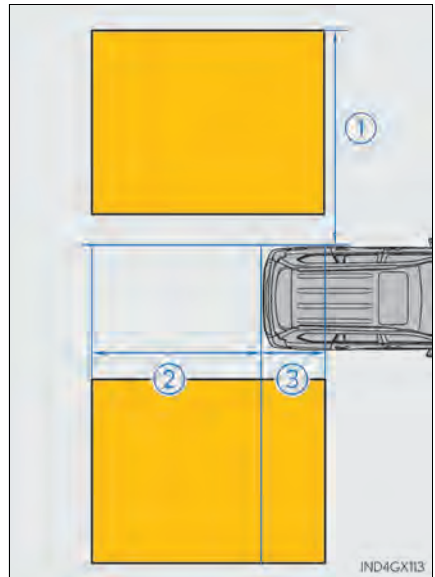

WARNING

■ Cautions regarding the use of the system

The driver is solely responsible for safe driving. Always drive safely, taking care to observe your surroundings.

The Blind Spot Monitor function is a supplementary function which alerts the driver that a vehicle is present in the blind spot. Do not overly rely on the Blind Spot Monitor function. The function cannot judge if it is safe to change lanes, therefore over reliance could cause an accident resulting in death or serious injury.

According to conditions, the system may not function correctly. Therefore the driver's own visual confirmation of safety is necessary.

■ The Blind Spot Monitor function is operational when

- The Blind Spot Monitor system turned on.
- Vehicle speed is greater than approximately 10 mph (16 km/h).

■ The Blind Spot Monitor function will detect a vehicle when

- A vehicle in an adjacent lane overtakes your vehicle.
- You overtake a vehicle in adjacent lane slowly.
- Another vehicle enters the detection area when it changes lanes.

■ Conditions under which the system will not detect a vehicle

The Blind Spot Monitor function is not designed to detect the following types of vehicles and/or objects:

- Small motorcycles, bicycles, pedestrians etc.*
- Vehicles traveling in the opposite direction
- Guardrails, walls, signs, parked vehicles and similar stationary objects*
- Following vehicles that are in the same lane*
- Vehicles driving 2 lanes across from your vehicle*
- Vehicles which are being overtaken rapidly by your vehicle*

*: Depending on conditions, detection of a vehicle and/or object may occur.

■ Conditions under which the system may not function correctly

- The Blind Spot Monitor function may not detect vehicles correctly in the following situations:
 - When the sensor is misaligned due to a strong impact to the sensor or its surrounding area
 - When mud, snow, ice, a sticker, etc. is covering the sensor or surrounding area on the rear bumper
 - When driving on a road surface that is wet with standing water during bad weather, such as heavy rain, snow, or fog
 - When multiple vehicles are approaching with only a small gap between each vehicle
 - When the distance between your vehicle and a following vehicle is short
 - When there is a significant difference in speed between your vehicle and the vehicle that enters the detection area
 - When the difference in speed between your vehicle and another vehicle is changing
 - When a vehicle enters a detection area traveling at about the same speed as your vehicle
 - As your vehicle starts from a stop, a vehicle remains in the detection area
 - When driving up and down consecutive steep inclines, such as hills, dips in the road, etc.
 - When driving on roads with sharp bends, consecutive curves, or uneven surfaces
 - When vehicle lanes are wide, or when driving on the edge of a lane, and the vehicle in an adjacent lane is far away from your vehicle
 - When your vehicle is towing a trailer (with towing hitch)
 - When a bicycle carrier or other accessory is installed to the rear of the vehicle
 - When there is a significant difference in height between your vehicle and the vehicle that enters the detection area
 - Immediately after the Blind Spot Monitor function is turned on
- Instances of the Blind Spot Monitor function unnecessarily detecting a vehicle and/or object may increase in the following situations:
 - When the sensor is misaligned due to a strong impact to the sensor or its surrounding area
 - When the distance between your vehicle and a guardrail, wall, etc. that enters the detection area is short
 - When driving up and down consecutive steep inclines, such as hills, dips in the road, etc.
 - When vehicle lanes are narrow, or when driving on the edge of a lane, and a vehicle traveling in a lane other than the adjacent lanes enters the detection area
 - When driving on roads with sharp bends, consecutive curves, or uneven surfaces
 - When the tires are slipping or spinning
 - When the distance between your vehicle and a following vehicle is short
 - When a bicycle carrier or other accessory is installed to the rear of the vehicle

The Rear Cross Traffic Alert function

The Rear Cross Traffic Alert functions when your vehicle is in reverse. It can detect other vehicles approaching from the right or left rear of the vehicle. It uses radar sensors to alert the driver of the other vehicle's existence through flashing the outside rear view mirror indicators and sounding a buzzer.

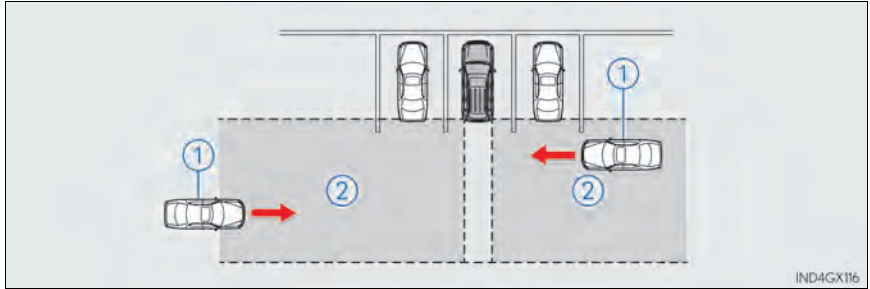

① Approaching vehicles

② Detection areas

■ The Rear Cross Traffic Alert icon display

When a vehicle approaching from the right or left at the rear of the vehicle is detected, the following will be displayed on the monitor screen

- ▶ When the Lexus parking assist monitor (if equipped) is displayed
- ▶ When the panoramic view monitor (if equipped) is displayed

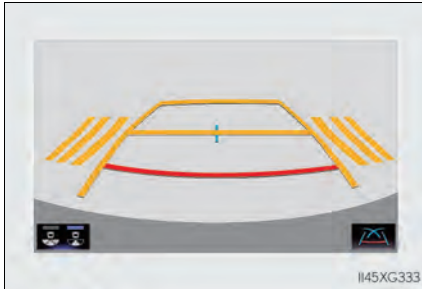

⚠ WARNING

■ Cautions regarding the use of the system

There is a limit to the degree of recognition accuracy and control performance that this system can provide, do not overly rely on this system. The driver is always responsible for paying attention to the vehicle's surroundings and driving safely. (→P. 377)

■ To ensure the system can operate properly

→P. 376

The Rear Cross Traffic Alert function detection areas

The areas that vehicles can be detected in are outlined below.

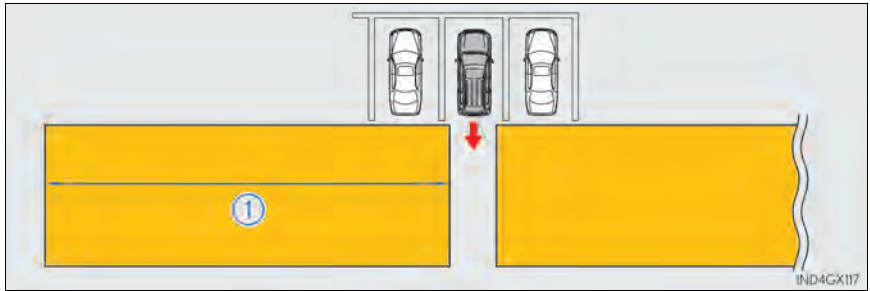

To give the driver a more consistent time to react, the buzzer can alert for faster vehicles from farther away.

Example:

Approaching vehicle	Speed	① Approximate alert distance
Fast	18 mph (28 km/h)	65 ft. (20 m)
Slow	5 mph (8 km/h)	18 ft. (5.5 m)

■ The Rear Cross Traffic Alert function is operational when

- The Blind Spot Monitor system turned on.
- The shift lever is in R.
- Vehicle speed is less than approximately 5 mph (8 km/h).
- Approaching vehicle speed is between approximately 5 mph (8 km/h) and 18 mph (28 km/h).

■ Conditions under which the system will not detect a vehicle

The Rear Cross Traffic Alert function is not designed to detect the following types of vehicles and/or objects:

- Vehicles approaching from directly behind
- Vehicles backing up in a parking space next to your vehicle
- Vehicles that the sensors cannot detect due to obstructions

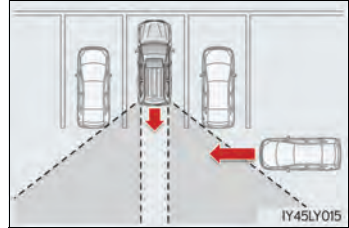

- Guardrails, walls, signs, parked vehicles and similar stationary objects *
 - Small motorcycles, bicycles, pedestrians, etc. *
 - Vehicles moving away from your vehicle
 - Vehicles approaching from the parking spaces next to your vehicle *
 - The distance between the sensor and approaching vehicle gets too close
- *: Depending on the conditions, detection of a vehicle and/or object may occur.

■ Situations in which the system may not operate properly

The Rear Cross Traffic Alert function may not detect vehicles correctly in the following situations:

- When the sensor is misaligned due to a strong impact to the sensor or its surrounding area
- When mud, snow, ice, a sticker, etc. is covering the sensor or surrounding area on the rear bumper
- When driving on a road surface that is wet with standing water during bad weather, such as heavy rain, snow, or fog
- When multiple vehicles are approaching with only a small gap between each vehicle
- When a vehicle is approaching at high speed
- When equipment that may obstruct a sensor is installed, such as a towing eyelet, bumper protector (an additional trim strip, etc.), bicycle carrier, or snow plow

- When backing up on a slope with a sharp change in grade

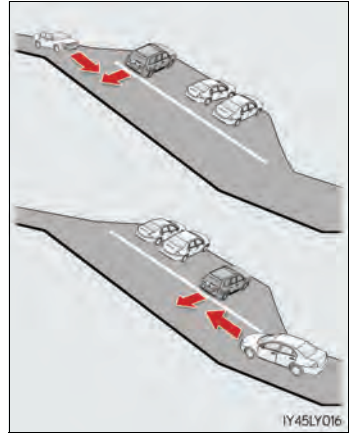

- When backing out of a sharp angle parking spot

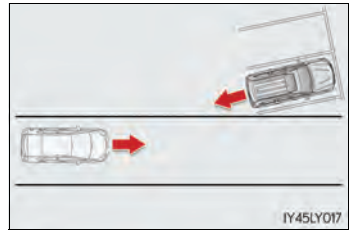

- When towing a trailer
- When there is a significant difference in height between your vehicle and the vehicle that enters the detection area
- When a sensor or the area around a sensor is extremely hot or cold
- If the suspension has been modified or tires of a size other than specified are installed
- If the front of the vehicle is raised or lowered due to the carried load
- When turning while backing up

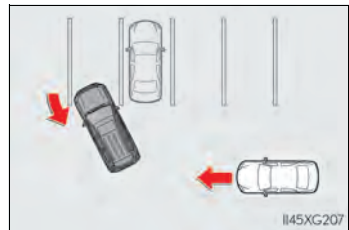

- When a vehicle turns into the detection area

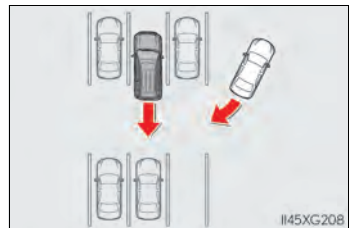

■ **Situations in which the system may operate even if there is no possibility of a collision**

Instances of the Rear Cross Traffic Alert function unnecessarily detecting a vehicle and/or object may increase in the following situations:

- When the parking space faces a street and vehicles are being driven on the street

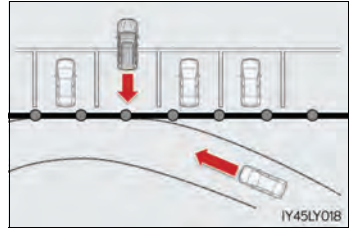

- When the distance between your vehicle and metal objects, such as a guardrail, wall, sign, or parked vehicle, which may reflect electrical waves toward the rear of the vehicle, is short

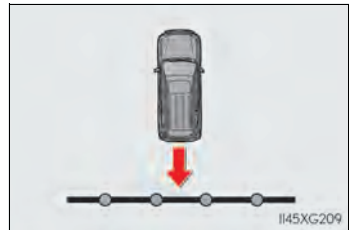

- When equipment that may obstruct a sensor is installed, such as a towing eyelet, bumper protector (an additional trim strip, etc.), bicycle carrier, or snow plow

- When a vehicle passes by the side of your vehicle



- When a detected vehicle turns while approaching the vehicle

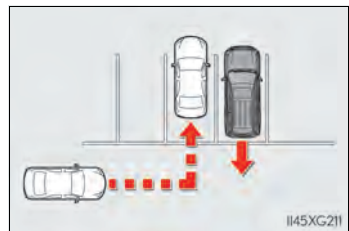

- When there are spinning objects near your vehicle such as the fan of an air conditioning unit
- When water is splashed or sprayed toward the rear bumper, such as from a sprinkler
- Moving objects (flags, exhaust fumes, large rain droplets or snowflakes, rain water on the road surface, etc.)
- When the distance between your vehicle and a guardrail, wall, etc., that enters the detection area is short
- Gratings and gutters
- When a sensor or the area around a sensor is extremely hot or cold
- If the suspension has been modified or tires of a size other than specified are installed
- If the front of the vehicle is raised or lowered due to the carried load

Winter driving tips

Carry out the necessary preparations and inspections before driving the vehicle in winter. Always drive the vehicle in a manner appropriate to the prevailing weather conditions.

Pre-winter preparations

- Use fluids that are appropriate to the prevailing outside temperatures.
 - Engine oil
 - Engine coolant
 - Washer fluid
- Have a service technician inspect the condition of the battery.
- Have the vehicle fitted with four snow tires or purchase a set of tire chains for the rear tires.

Ensure that all tires are the same size and brand, and that chains match the size of the tires.

Before driving the vehicle

Perform the following according to the driving conditions:

- Do not try to forcibly open a window or move a wiper that is frozen. Pour warm water over the frozen area to melt the ice. Wipe away the water immediately to prevent it from freezing.
- To ensure proper operation of the climate control system fan, remove any snow that has accumulated on the air inlet vents in front of the windshield.
- Check for and remove any excess ice or snow that may have accumulated on the exterior lights, vehicle's roof, chassis, around the tires or on the brakes.
- Remove any snow or mud from the bottom of your shoes before getting in the vehicle.

When driving the vehicle

Accelerate the vehicle slowly, keep a safe distance between you and the vehicle ahead, and drive at a reduced speed suitable to road conditions.

When parking the vehicle

- Park the vehicle and move the shift lever to P without setting the parking brake. The parking brake may freeze up, preventing it from being released. If the vehicle is parked without setting the parking brake, make sure to block the wheels.

Failure to do so may be dangerous because it may cause the vehicle to move unexpectedly, possibly leading to an accident.

- If the vehicle is parked without setting the parking brake, confirm that the shift lever cannot be moved out of P*.

*: The shift lever will be locked if it is attempted to be shifted from P to any other position without depressing the brake pedal. If the shift lever can be shifted from P, there may be a problem with the shift lock system. Have the vehicle inspected by your Lexus dealer immediately.

Selecting tire chains

Use the correct tire chain size when mounting the tire chains.

Chain size is regulated for each tire size.

- ① Side chain
(0.20 in. [5 mm] in diameter)
- ② Cross chain
(0.25 in. [6.3 mm] in diameter)

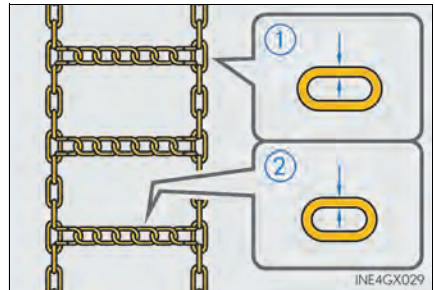

Regulations on the use of tire chains

Regulations regarding the use of tire chains vary depending on location and type of road. Always check local regulations before installing chains.

■ Tire chain installation

Observe the following precautions when installing and removing chains:

- Install and remove tire chains in a safe location.
- Install tire chains on the rear tires. Do not install tire chains on the front tires.
- Install tire chains on rear tires as tightly as possible. Retighten chains after driving 1/4 - 1/2 mile (0.5 - 1.0 km).
- Install tire chains following the instructions provided with the tire chains.



WARNING

■ Driving with snow tires

Observe the following precautions to reduce the risk of accidents.

Failure to do so may result in a loss of vehicle control and cause death or serious injury.

- Use tires of the specified size.
- Maintain the recommended level of air pressure.
- Do not drive in excess of 75 mph (120 km/h), regardless of the type of snow tires being used.
- Use snow tires on all, not just some wheels.
- Do not use LDA (Lane Departure Alert) system.

■ Driving with tire chains

Observe the following precautions to reduce the risk of accidents.

Failing to do so may result in the vehicle being unable to be driven safely, and may cause death or serious injury.

- Do not drive in excess of the speed limit specified for the tire chains being used, or 30 mph (50 km/h), whichever is lower.
- Avoid driving on bumpy road surfaces or over potholes.
- Avoid sudden acceleration, abrupt steering, sudden braking and shifting operations that cause sudden engine braking.
- Slow down sufficiently before entering a curve to ensure that vehicle control is maintained.
- Do not use LDA (Lane Departure Alert) system.



NOTICE

■ Repairing or replacing snow tires

Request repairs or replacement of snow tires from Lexus dealers or legitimate tire retailers.

This is because the removal and attachment of snow tires affects the operation of the tire pressure warning valves and transmitters.

■ Fitting tire chains

The tire pressure warning valves and transmitters may not function correctly when tire chains are fitted.

Off-road precautions

This vehicle belongs to the utility vehicle class, which has higher ground clearance and narrower tread in relation to the height of its center of gravity to make it capable of performing in a wide variety of off-road applications.

Off-road vehicle features

- Specific design characteristics give it a higher center of gravity than ordinary passenger cars. This vehicle design feature causes this type of vehicle to be more likely to rollover. And, utility vehicles have a significantly higher rollover rate than other types of vehicles.
- An advantage of the higher ground clearance is a better view of the road allowing you to anticipate problems.
- It is not designed for cornering at the same speeds as ordinary passenger cars any more than low-slung sports cars are designed to perform satisfactorily under off-road conditions. Therefore, sharp turns at excessive speeds may cause the vehicle to rollover.

 **WARNING****■ Off-road vehicle precautions**

Always observe the following precautions to minimize the risk of death, serious injury or damage to your vehicle:

- In a rollover crash, an unbelted person is significantly more likely to die than a person wearing a seat belt. Therefore, the driver and all passengers should always fasten their seat belts.
- Avoid sharp turns or abrupt maneuvers, if at all possible.
Failure to operate this vehicle correctly may result in loss of control or vehicle rollover causing death or serious injury.
- Loading cargo on the roof luggage carrier will make the center of the vehicle gravity higher. Avoid high speeds, sudden starts, sharp turns, sudden braking or abrupt maneuvers, otherwise it may result in loss of control or vehicle rollover due to failure to operate this vehicle correctly.
- Always slow down in gusty crosswinds. Because of its profile and higher center of gravity, your vehicle is more sensitive to side winds than an ordinary passenger car. Slowing down will allow you to have better control.
- Do not drive horizontally across steep slopes. Driving straight up or straight down is preferred. Your vehicle (or any similar off-road vehicle) can tip over sideways much more easily than forward or backward.

Off-road driving

When driving your vehicle off-road, please observe the following precautions to ensure your driving enjoyment and to help prevent the closure of areas to off-road vehicles:

- Drive your vehicle only in areas where off-road vehicles are permitted to travel.
- Respect private property. Get owner's permission before entering private property.
- Do not enter areas that are closed. Honor gates, barriers and signs that restrict travel.
- Stay on established roads. When conditions are wet, driving techniques should be changed or travel delayed to prevent damage to roads.

■ Additional information for off-road driving

► For owners in U.S. mainland, Hawaii and Puerto Rico:

To obtain additional information pertaining to driving your vehicle off-road, consult the following organizations:

- State and Local Parks and Recreation Departments
- State Motor Vehicle Bureau
- Recreational Vehicle Clubs
- U.S. Forest Service and Bureau of Land Management

 **WARNING****■ Off-road driving precautions**

Always observe the following precautions to minimize the risk of death, serious injury or damage to your vehicle:

- Drive carefully when off the road. Do not take unnecessary risks by driving in dangerous places.
- Do not grip the steering wheel spokes when driving off-road. A bad bump could jerk the wheel and injure your hands. Keep both hands and especially your thumbs on the outside of the rim.
- Always check your brakes for effectiveness immediately after driving in sand, mud, water or snow.
- After driving through tall grass, mud, rock, sand, rivers, etc., check that there is no grass, bush, paper, rags, stone, sand, etc. adhering or trapped on the underbody. Clear off any such matter from the underbody. If the vehicle is used with these materials trapped or adhering to the underbody, a breakdown or fire could occur.
- When driving off-road or in rugged terrain, do not drive at excessive speeds, jump, make sharp turns, strike objects, etc. This may cause loss of control or vehicle rollover causing death or serious injury. You are also risking expensive damage to your vehicle's suspension and chassis.

**NOTICE****■ To prevent the water damage**

Take all necessary safety measures to ensure that water damage to the engine or other components does not occur.

- Water entering the engine air intake will cause severe engine damage.
- Water entering the automatic transmission will cause deterioration in shift quality, locking up of your transmission accompanied by vibration, and ultimately damage.
- Water can wash the grease from wheel bearings, causing rusting and premature failure, and may also enter the differentials, transmission and transfer case, reducing the gear oil's lubricating qualities.

■ When you drive through water

If driving through water, such as when crossing shallow streams, first check the depth of the water and the bottom of the riverbed for firmness. Drive slowly and avoid deep water.

■ Inspection after off-road driving

- Sand and mud that has accumulated in brake drums and around brake discs may affect braking efficiency and may damage brake system components.
- Always perform a maintenance inspection after each day of off-road driving that has taken you through rough terrain, sand, mud, or water. For scheduled maintenance information, refer to the "Warranty and Services Guide", "Owner's Manual Supplement" or "Scheduled Maintenance".

Interior features

5

5-1. Remote Touch/Display

Remote Touch.....396

Center display.....399

5-2. Using the air conditioning system and defogger

Front automatic air conditioning system402

Rear air conditioning system 414

Heated steering wheel/seat heaters/seat ventilators..... 417

5-3. Using the interior lights

Interior lights list420

- Personal/interior lights main switch.....421
- Personal/interior lights.....421

5-4. Using the storage features

List of storage features 423

- Glove box 424
- Console box..... 424
- Coin holder 425
- Cup holders/bottle holders/door pockets..... 426
- Auxiliary boxes 429

Luggage compartment features 431

5-5. Using the other interior features

Other interior features 438

- Cool box.....438
- Sun visors440
- Vanity mirror.....440
- Conversation mirror441
- Clock441
- Power outlets..... 442
- USB charging ports 446
- Armrest.....448
- Coat hooks 449
- Assist grips..... 449

Garage door opener450

Remote Touch

The Remote Touch can be used to operate the Center Display.

For details on the Remote touch, refer to the “NAVIGATION SYSTEM OWNER’S MANUAL”.

Remote Touch operation

■ Switches

- ① “MAP” button
Press this button to display the current location.
- ② “MENU” button
Press this button to display the menu screen.
- ③ Back button
Press this button to display the previous screen.
- ④ Touchpad
Press the touchpad to enter the selected function, letter or screen button. Certain finger movements on the touchpad can perform functions, such as changing map scalings and scrolling list screens.

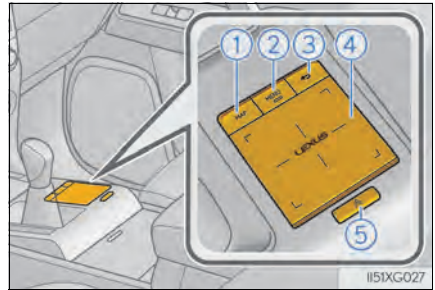

- ⑤ Sub function button
When  is displayed on the screen, a function screen assigned to the screen can be displayed.

■ Using the touchpad

- ① Select: Touch the touchpad to select the desired button on the screen.
- ② Enter: The buttons on the screen can be selected by either depressing or double tapping on the touchpad. Once a button has been selected, the screen will change.

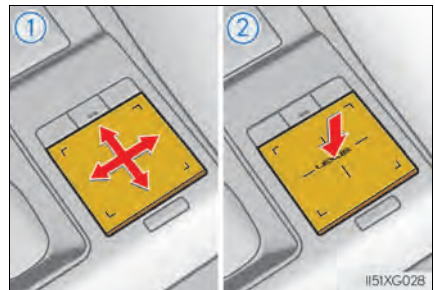

■ Touch operation

Operations are performed by touching the touchpad with your finger.

● Trace

Trace the pad surface while maintaining contact with the touchpad. Moving the cursor and the pointer.

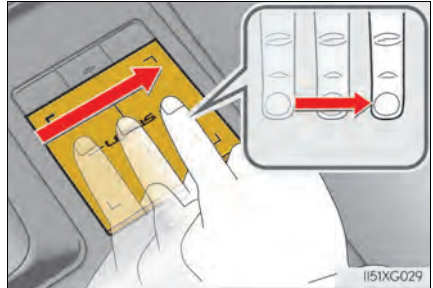

● Double tap

Tap the touchpad twice, quickly. Select the button on the screen.

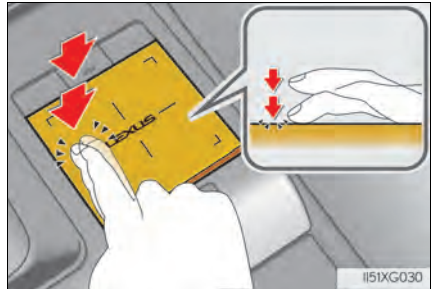

● Flick

Quick and long movement along the touchpad with your finger. Move the list screen.



● Pinch in/Pinch out

Slide fingers toward each other or apart on the touchpad. Change the scale of the map.

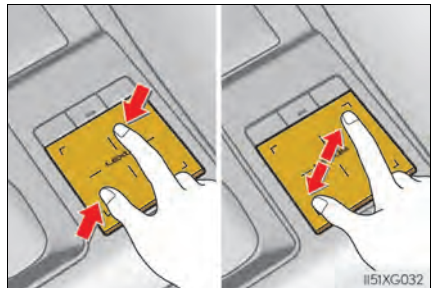

**NOTICE****■ To prevent damage to the Remote Touch**

Observe the following precautions. Failure to do so may cause damage to the Remote Touch.

- Do not allow the Remote Touch to come into contact with food, liquid, stickers or lit cigarettes.
- Do not subject the Remote Touch to excessive pressure or strong impact.
- Do not push the touchpad with a strong force or use a sharp pointed object to operate the pad.

Center Display

Center Display overview

■ Menu screen







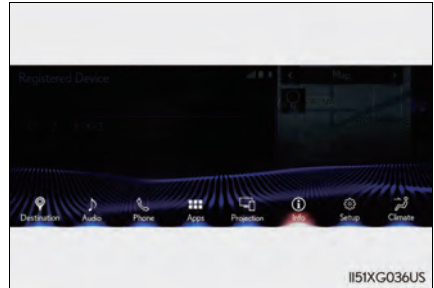

Press the “MENU” button on the Remote Touch to display the menu screen.

This system can also be operated by the touch screen.

For details, refer to “NAVIGATION SYSTEM OWNER’S MANUAL”.

The displays shown in the illustrations are used for example only and may differ from the actual vehicle.



Switch	Function
	Select to display the destination screen. *1,2
	Select to display the audio control screen. *2
	Select to display the hands-free control screen. *2
	Select to display the "Apps" screen. *2,3
	When an Apple CarPlay/Android Auto connection is established and this button displays "Apple CarPlay"/"Android Auto", select to display the home screen of Apple CarPlay/Android Auto. *2,3
	Select to display the information screen. *2 (→P.88, 91)
	Select to display the general settings screen. *2
	Select to display the air conditioning control screen. (→P.403)

*1: If equipped

*2: Refer to the "NAVIGATION SYSTEM OWNER'S MANUAL".

*3: This function is not made available in some countries or areas.

■ Split-screen display

Different information can be displayed on the left and right of the screen. For example, air conditioning system screen can be displayed and operated while the fuel consumption information screen is being displayed. The large screen on the left of the display is called the main display, and the small screen to the right is called the side display.

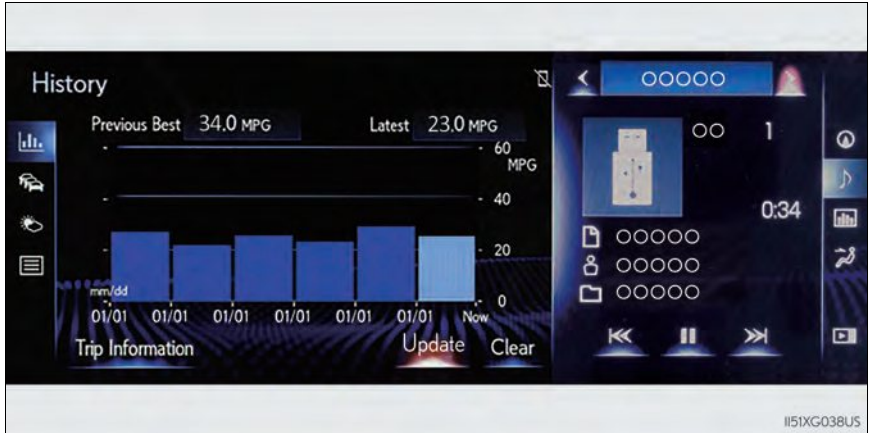

■ Main display

For details about the functions and operation of the main display, refer to the respective section and “NAVIGATION SYSTEM OWNER’S MANUAL”.

■ Side display

The following functions can be displayed and operated on the side display.

Select **<** or **>** to display the desired screen.

- ① Navigation system*
- ② Audio*
- ③ Vehicle information (→P.99)
- ④ Air conditioning system (→P.403)
- ⑤ Show/hide the side display

*: Refer to the “NAVIGATION SYSTEM OWNER’S MANUAL”.

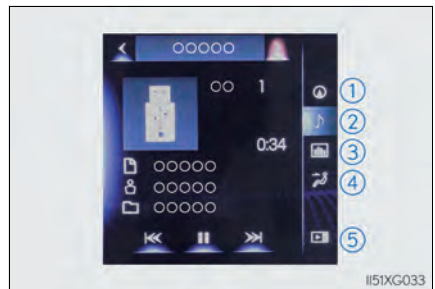

■ Screen display during low temperatures

When the ambient temperature is extremely low, screen response may be delayed even if the Remote Touch is operated.

Front automatic air conditioning system

Air outlets and fan speed are automatically adjusted according to the temperature setting.

Press the “MENU” button on the Remote Touch, then select “Climate” to display the air conditioning control screen. (→P. 396)

The air conditioning system can be displayed and operated on the side display.

Control panel

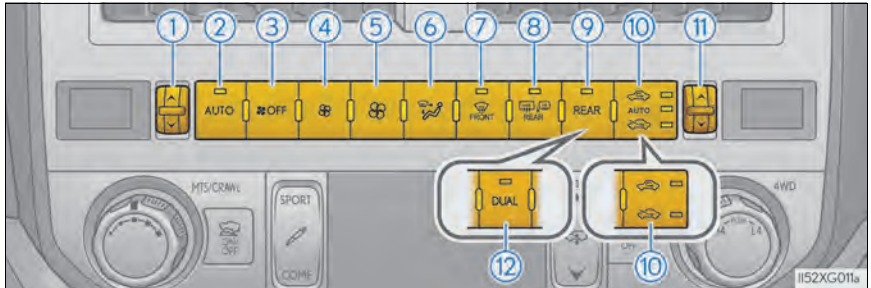

- ① Left-hand side temperature control switch
- ② Automatic mode switch
- ③ OFF switch
- ④ Fan speed decrease switch
- ⑤ Fan speed increase switch
- ⑥ Airflow mode control switch
- ⑦ Windshield defogger switch
- ⑧ Rear window defogger and outside rear view mirror defoggers switch
- ⑨ REAR switch
- ⑩ Outside/recirculated air mode switch
- ⑪ Right-hand side temperature control switch
- ⑫ DUAL switch

Control screen

■ Main control screen

Using the touchpad of the Remote Touch, select the button on the screen.

This system can also be operated by the touch screen.

① Sub menu

Selecting the sub menu item to switch the main screen.

: Display the air conditioning control screen

: Display the rear air conditioning control screen (vehicles with “3-ZONE” mode) (→P. 405)

: Display the option control screen

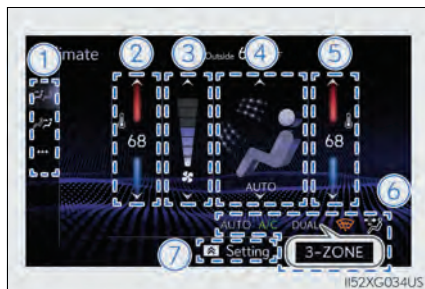

② Adjust the left-hand side temperature setting

③ Adjust the fan speed setting

④ Select the air flow mode

: Air flows to the upper body

: Air flows to the upper body and feet

: Air flows to the feet

: Air flows to the feet and the windshield defogger operates

⑤ Adjust the right-hand side temperature setting

⑥ Function on/off indicators

When the function is on, the indicator illuminates on the control screen.

⑦ Sub function menu

When the sub function button on the Remote Touch is pressed, the following functions can be switched on and off.

“AUTO”: Set automatic mode on/off (→P. 406)

“Off”: Turn the fan off

“A/C”: Set cooling and dehumidification function

“DUAL” (if equipped): Adjust the temperature for driver and front passenger seats separately (“DUAL” mode) (→P. 407)

“3-ZONE” (if equipped): Adjust the temperature for the driver, front passenger and rear seats separately (“3-ZONE” mode) (→P. 407)

■ Option control screen

Select **...** on the sub menu to display the option control screen.

The functions can be switched on and off.

When the function is on, the indicator illuminates on the screen.

- ① Adjust the temperature for the driver and front passenger seats separately

- “DUAL” (if equipped)
(→P. 407)
- “3-ZONE” (if equipped)
(→P. 407)

- ② Cooling and dehumidification function

- ③ Prevent ice from building up on the windshield and wiper blades (Windshield wiper de-icer) (if equipped)

- ④ Removing pollen from the air (Micro dust and pollen filter)



■ Side display

- ① Adjust the left-hand side temperature setting

- ② Adjust the fan speed setting

- ③ Adjust the right-hand side temperature setting

- ④ Set cooling and dehumidification function on/off

- ⑤ Adjust the temperature for the driver's and front passenger's seats separately

- “DUAL” (if equipped) (→P. 407)
- “3-ZONE” (if equipped) (→P. 407)

- ⑥ Select the air flow mode





■ Rear air conditioning control screen (if equipped)

Using the touchpad of the Remote Touch, select the button on the screen. This system can also be operated by the touch screen.

① Sub menu

Selecting the sub menu item to switch the main screen.

: Display the air conditioning control screen

: Display the rear air conditioning control screen

: Display the option control screen

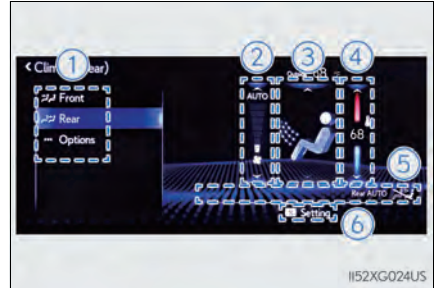

② Adjust the fan speed setting

③ Select the air flow mode

: Air flows to the upper body

: Air flows to the upper body and feet

: Air flows to the feet

④ Adjust the temperature setting

⑤ Function on/off indicators

When the function is on, the indicator illuminates on the control screen.

⑥ Sub function menu

When the sub function button on the Remote Touch is pressed, the following functions can be switched on and off.

“Rear AUTO”: Set automatic mode on/off

“Rear Off”: Turn the fan off

: Disables operation of the rear air conditioning system using the Rear air conditioning system control panel.

Air conditioning controls

■ Adjusting the temperature setting

Operate the temperature control switch upwards to increase the temperature and downwards to decrease the temperature.

If the "A/C" indicator is turned off, the system will blow ambient temperature air or heated air.

■ Adjusting the fan speed setting

Operate the fan speed increase switch to increase the fan speed and the fan speed decrease switch to decrease the fan speed.

Press the OFF switch to turn the fan off.

■ Changing the air flow mode

Press the airflow mode control switch.

The mode changes as follows each time the switch is pressed.

(→P. 402, 403)

Using the voice command system

Press  to operate the voice command system. (Refer to the "NAVIGATION SYSTEM OWNER'S MANUAL".)

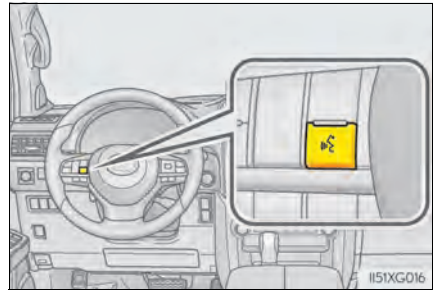

Using automatic mode

- 1 Press the automatic mode switch or select "AUTO" on the sub function menu. (→P. 402, 403)
- 2 Press the outside/recirculated air mode switch to switch to automatic air intake mode. (if equipped)
The air conditioning system automatically switches between outside air and recirculated air modes.
- 3 Adjust the temperature setting.
- 4 To stop the operation, press the OFF switch or select "Off" on the sub function menu. (→P. 402, 403)

If the fan speed setting or air flow modes are operated, the automatic mode indicator goes off. However, automatic mode for functions other than that operated is maintained.

Other functions

■ Adjusting the temperature for driver and passenger seats separately

▶ Vehicles with “DUAL” mode

Adjust the temperature for driver and passenger seats separately.

While in “DUAL” mode, the temperature of the rear air outlets is set at the passenger’s side temperature setting.

To turn on the “DUAL” mode, perform any of the following procedures:

- Press the DUAL switch. (→P. 402)
- Select “DUAL” on the sub function menu. (→P. 403)
- Select “DUAL” on the option control screen. (→P. 404)
- Select “DUAL” on the side display. (→P. 404)
- Adjust the front passenger’s side temperature setting.

The indicator on the main control screen comes on when the “DUAL” mode is on.

▶ Vehicles with “3-ZONE” mode

Adjust the temperature for the driver, front passenger and rear passenger seats separately.

To turn on the “3-ZONE” mode, perform any of the following procedures:

- Select “3-ZONE” on the sub function menu. (→P. 403)
- Select “3-ZONE” on the option control screen. (→P. 404)
- Select “3-ZONE” on the side display. (→P. 404)
- Adjust any passenger seat temperature.

The indicator on the main control screen comes on when the “3-ZONE” mode is on.

■ Adjusting the temperature for rear seats (vehicles with rear air conditioning system)

Adjusting the temperature for rear seats, perform of the following procedures:



- 1 Press the REAR switch.
- 2 Adjust the rear seats temperature setting on the rear air conditioning control screen. (→P. 405)

■ Switching between outside air and recirculated air modes

Press the outside/recirculated air mode switch.

The mode changes as follows each time the switch is pressed.

 (recirculated air mode) → automatic mode* (if equipped)

→  (outside air mode) →  (recirculated air mode)

When the system is switched to automatic mode, the air conditioning system operates automatically.

*: This item cannot be selected when the air conditioning is off.

■ Defogging the windshield

Defoggers are used to defog the windshield and front side windows.

Press the windshield defogger switch.

Set the outside/recirculated air mode button to outside air mode if the recirculated air mode is used. (It may switch automatically.)

To defog the windshield and the side windows early, turn the air flow and temperature up.

To return to the previous mode, press the windshield defogger switch again when the windshield is defogged.

■ Defogging the rear window and outside rear view mirrors

Defoggers are used to defog the rear window, and to remove raindrops, dew and frost from the outside rear view mirrors.

Press rear window defogger and outside rear view mirror defoggers switch.

The defoggers will automatically turn off after a period of time.

■ Micro dust and pollen filter mode

Pollen is removed from the air and the air flows to the upper part of the body.

Select  on the option control screen. (→P. 403)

When the micro dust and pollen filter mode is on,  is displayed on the control screen.

In order to prevent the windshield from fogging up when the outside air is cold, the dehumidification function may operate.

The pollens are filtered out even if the micro dust and pollen filter mode is turned off.

■ Windshield wiper de-icer (if equipped)

This feature is used to prevent ice from building up on the windshield and wiper blades.

Select  on the option control screen. (→P. 404)

When the windshield wiper de-icer is on,  is displayed on the control screen.

The windshield wiper de-icer will automatically turn off after a period of time.

■ The windshield wiper de-icer can be operated when (vehicles with windshield wiper de-icer)

The engine switch is in IGNITION ON mode.

■ When the windshield wiper de-icer is on (vehicles with windshield wiper de-icer)

The windshield wiper de-icer will automatically turn off after approximately 15 minutes.

WARNING

■ When the windshield wiper de-icer is on (vehicles with windshield wiper de-icer)

Do not touch the glass at the lower part of the windshield or the side of the front pillars as the surfaces can become very hot and burn you.

Air outlets

■ Location of air outlets

The air outlets and air volume changes according to the selected air flow mode.

← : Vehicles without rear air conditioning system

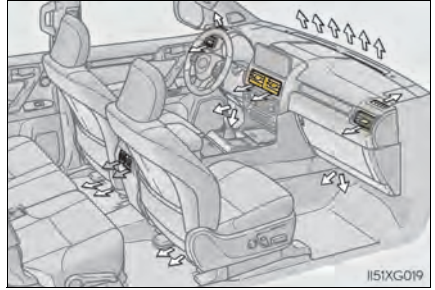

■ Adjusting the air flow direction and opening/closing the air outlets

▶ Front outlets

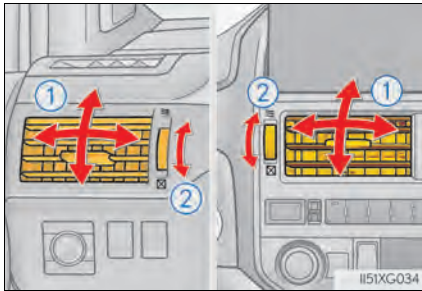

▶ Rear outlets (vehicles without rear air conditioning system)

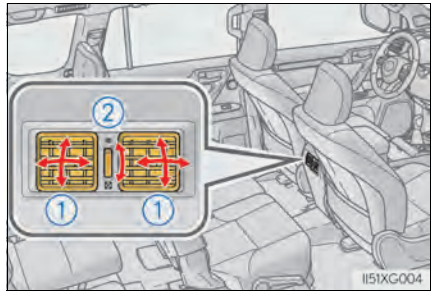

① Direct air flow to the left or right, up or down.

② Turn the knob to open or close the vent.

■ Registering air conditioning settings to electronic keys

- Unlocking the vehicle using an electronic key and turning the engine switch to IGNITION ON mode will recall that key's registered air conditioning settings.
- When the engine switch is turned off, the current air conditioning settings will automatically be registered to the electronic key that was used to unlock the vehicle.

The system may not operate correctly if more than one electronic key is in the vicinity or if the smart access system with push-button start is used to unlock a passenger door.

Settings for the electronic key and the corresponding door can be changed.

Contact your Lexus dealer.

■ Using automatic mode

Fan speed is adjusted automatically according to the temperature setting and the ambient conditions.

Therefore, the fan may stop for a while until warm or cool air is ready to flow immediately after the Automatic mode switch is pressed.

■ When the outside temperature exceeds 75°F (24°C) and the air conditioning system is on

- In order to reduce the air conditioning power consumption, the air conditioning system may switch to recirculated air mode automatically. This may also reduce fuel consumption.
- Recirculated air mode is selected as a default mode when the engine switch is turned to IGNITION ON mode.
- It is possible to switch to outside air mode at any time by pressing the outside/recirculated air mode switch.

■ Fogging up of the windows

- The windows will easily fog up when the humidity in the vehicle is high. Touching "A/C" on will dehumidify the air from the outlets and defog the windshield effectively.
- If you turn "A/C" off, the windows may fog up more easily.
- The windows may fog up if the recirculated air mode is used.

■ When driving on dusty roads

Close all windows. If dust thrown up by the vehicle is still drawn into the vehicle after closing the windows, it is recommended that the air intake mode be set to outside air mode and the fan speed to any setting except off.

■ Outside/recirculated air mode

- Setting to the recirculated air mode temporarily is recommended in preventing dirty air from entering the vehicle interior and helping to cool the vehicle when the outside air temperature is high.
- Outside/recirculated air mode may automatically switch depending on the temperature setting or the inside temperature.

■ Automatic mode for air intake control (vehicles with rear air conditioning system)

In automatic mode, the system detects exhaust gas and other pollutants and automatically switches between outside air and recirculated air modes.

When the dehumidification function is off, and the fan is operating, turning automatic mode on will activate the dehumidification function.

■ When the outside temperature is low

The dehumidification function may not operate even when "A/C" is touched.

■ Ventilation and air conditioning odors

- To let fresh air in, set the air conditioning system to the outside air mode.
- During use, various odors from inside and outside the vehicle may enter into and accumulate in the air conditioning system. This may then cause odor to be emitted from the vents.
- To reduce potential odors from occurring:
 - It is recommended that the air conditioning system be set to outside air mode prior to turning the vehicle off.
 - The start timing of the blower may be delayed for a short period of time immediately after the air conditioning system is started in automatic mode.

■ Air conditioning filter



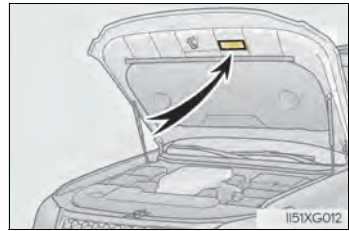

→P. 505

■ Air conditioning system refrigerant

- A label regarding the refrigerant of the air conditioning system is attached to the hood at the location shown in the following illustration.



- The meaning of each symbol on the label are as follows:

	Caution
	Air conditioning system
	Air conditioning system lubricant type
	Requires registered technician to service air conditioning system
	Flammable refrigerant

■ Customization

Settings (e.g. A/C automatic mode switch operation) can be changed.
(Customizable features: →P. 600)

⚠ WARNING

■ To prevent the windshield from fogging up

- Do not use windshield defogger switch during cool air operation in extremely humid weather. The difference between the temperature of the outside air and that of the windshield can cause the outer surface of the windshield to fog up, blocking your vision.
- Do not place anything on the instrument panel which may cover the air outlets. Otherwise, air flow may be obstructed, preventing the windshield defoggers from defogging.

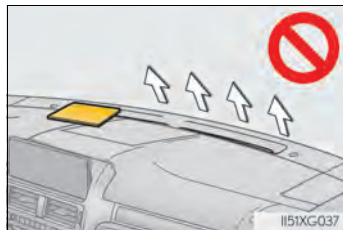

■ To prevent burns

- Do not touch the rear view mirror surfaces when the outside rear view mirror defoggers are on.
- Do not touch the glass at lower part of the windshield or to the side of the front pillars when the windshield wiper de-icer is on. (vehicles with windshield wiper de-icer)

⚠ NOTICE

■ To prevent battery discharge

Do not leave the air conditioning system on longer than necessary when the engine is off.

■ When repairing/replacing parts of the air conditioning system

Have repair/replacement performed by your Lexus dealer. When a part of the air conditioning system, such as the evaporator, is to be replaced, it must be replaced with a new one.

Rear air conditioning system *

Air outlets and fan speed are automatically adjusted according to the temperature setting.

Control panel

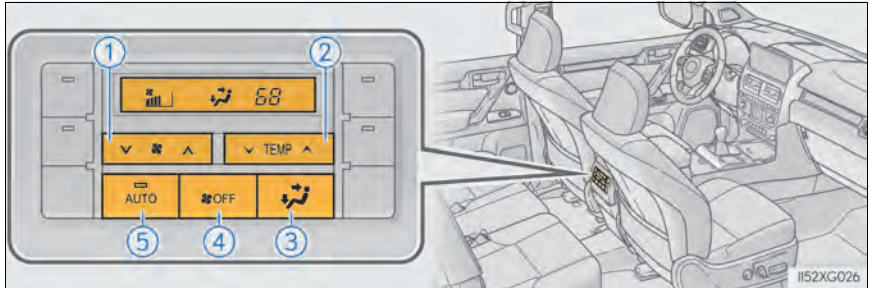

- ① Rear fan speed setting switch
- ② Rear temperature setting switch
- ③ Airflow mode select switch
- ④ OFF switch
- ⑤ Automatic mode switch

When the function is on, the indicator illuminates on the control screen.

Control screen

Using the touchpad of the Remote Touch, select the button on the screen. This system can also be operated by the touch screen. (→P. 405)

Air conditioning controls

■ Adjusting the temperature setting

Press “^” on the rear temperature setting switch to increase the temperature and “v” to decrease the temperature.

Select  on the sub menu to display the option control screen. (→P. 405)

If the “A/C” indicator is turned off, the system will blow ambient temperature air or heated air.

■ Adjusting the fan speed setting

Press “^” on the rear fan speed setting switch to increase the fan speed and “v” to decrease the fan speed.

Press the OFF switch to turn the fan off.

■ Changing the air flow mode

Press the airflow mode select switch.

The air flow mode change as follows each time the airflow mode select switch is pressed.

 : Air flows to the upper body.

 : Air flows to the upper body and feet.

 : Air flows to the feet.

Using automatic mode

■ Using the automatic mode

- 1 Press the automatic mode switch.
- 2 Adjust the temperature setting.
- 3 To stop the operation, press the OFF switch.

■ If the system is operated manually in automatic mode

If the fan speed setting or air flow modes are operated, the automatic mode indicator goes off. However, automatic mode for functions other than that operated are maintained.

Air outlets

■ Location of air outlets

The air outlets and air volume changes according to the selected air flow mode.



■ Adjusting the air flow direction and opening/closing the air outlets

- ① Direct air flow to the left or right, up or down.
- ② Turn the knob fully to the back of the vehicle to close the vent.

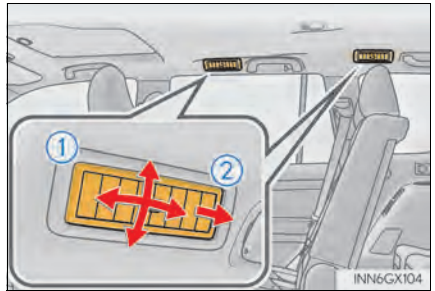

■ Registering air conditioning settings to electronic keys

- Unlocking the vehicle using an electronic key and turning the engine switch to IGNITION ON mode will recall that key's registered air conditioning settings.
- When the engine switch is turned off, the current air conditioning settings will automatically be registered to the electronic key that was used to unlock the vehicle.

The system may not operate correctly if more than one electronic key is in the vicinity or if the smart access system with push-button start is used to unlock a passenger door.

Settings for the electronic key and the corresponding door can be changed. Contact your Lexus dealer.

⚠ NOTICE

■ To prevent battery discharge

Do not leave the air conditioning system on longer than necessary when the engine is off.

Heated steering wheel* /seat heaters* /seat ventilators*

Heated steering wheel and seat heaters heat the side grips of the steering wheel and seats. Seat ventilators maintain good airflow by blowing air from the seats.

⚠ WARNING

- Care should be taken to prevent injury if anyone in the following categories comes in contact with the steering wheel and seats when the heater is on:
 - Babies, small children, the elderly, the sick and the physically challenged
 - Persons with sensitive skin
 - Persons who are fatigued
 - Persons who have taken alcohol or drugs that induce sleep (sleeping drugs, cold remedies, etc.)
- Observe the following precautions to prevent the minor burns or overheating:
 - Do not cover the seat with a blanket or cushion when using the seat heater.
 - Do not use seat heater more than necessary.

⚠ NOTICE

- Do not put heavy objects that have an uneven surface on the seat and do not stick sharp objects (needles, nails, etc.) into the seat.
- To prevent battery discharge, do not use the functions when the engine is off.

Heated steering wheel (if equipped)

Turns the heated steering wheel on/off

The indicator light comes on when the heated steering wheel is operating.

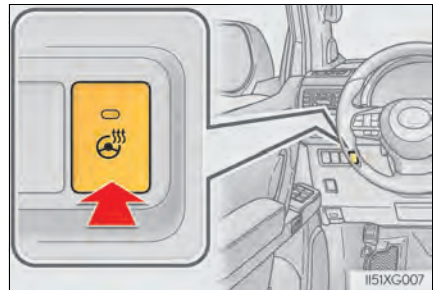

*: If equipped

- The heated steering wheel can be used when the engine switch is in IGNITION ON mode.
- The heated steering wheel will automatically turn off after about 30 minutes.
- If the indicator light flashes, press the switch to turn the heated steering wheel off and then press the switch again. If the indicator light still flashes, a malfunction may be occurring. Turn the heated steering wheel off and have the vehicle inspected by your Lexus dealer.

Seat heaters (if equipped)

■ Front seat

Turns the seat heater on

The indicator light comes on.
The higher the number of dots, the warmer the seat becomes.

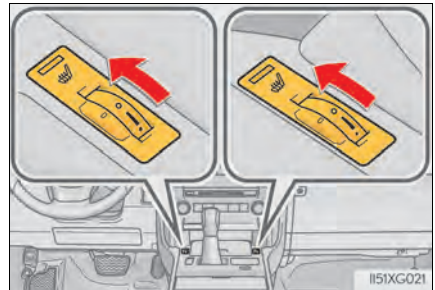

■ Rear seat (if equipped)

- ① For left second seat
- ② For right second seat
- ③ High heating temperature
- ④ Low heating temperature

To turn on the seat heater, press "HI" or "LO".

The indicator light on "HI" or "LO" switch indicates that the seat heater is on.

- ⑤ Off

To turn off, press "OFF".

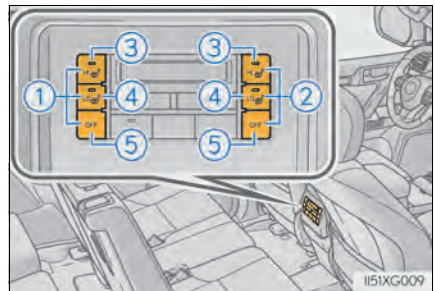

The seat heaters can be used when the engine switch is in IGNITION ON mode.

Seat heaters and ventilators (if equipped)**① Heats the seat**

The indicator light comes on.
The higher the number of dots, the warmer the seat becomes.

② Blows air from the seat

The indicator light comes on.
The higher the number of dots, the stronger the airflow becomes.

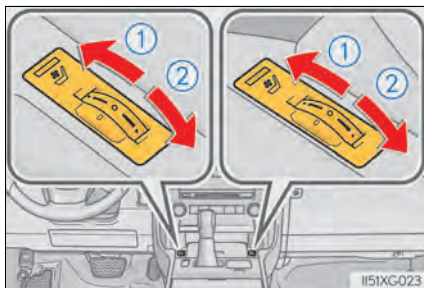

The seat heaters and ventilators can be used when the engine switch is in IGNITION ON mode.

Interior lights list

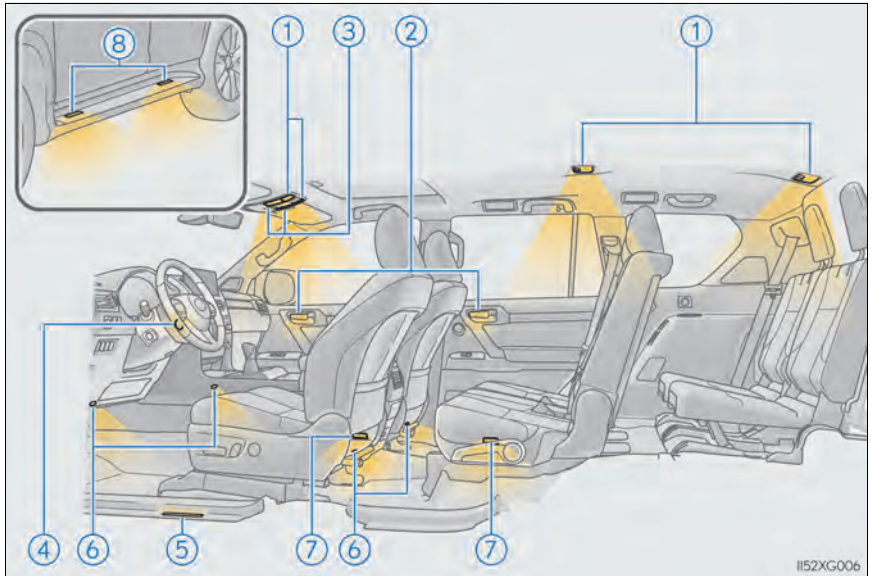

1152XG006

- | | |
|--------------------------------------|------------------------------|
| ① Personal/interior lights (→P. 421) | ⑤ Scuff lights (if equipped) |
| ② Inside door handle lights | ⑥ Footwell lights |
| ③ Shift lever lights | ⑦ Door courtesy lights |
| ④ Engine switch light | ⑧ Running board lights |

Personal/interior lights main switch

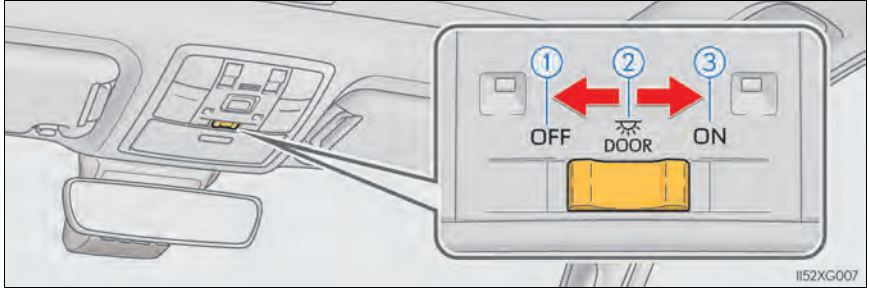

- ① Turns the lights off
- ② Turns the door position on
- ③ Turns the lights on

Personal/interior lights

► Front

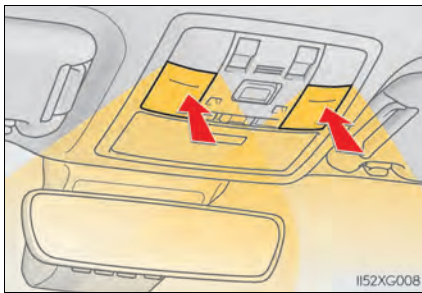

Turns the lights on/off

► Rear

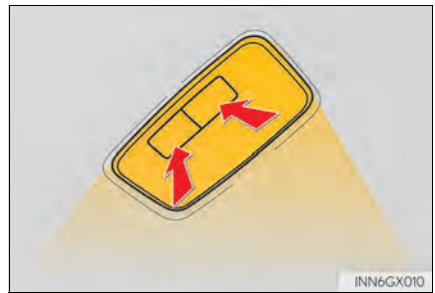

Turns the lights on/off

■ Illuminated entry system

The lights automatically turn on/off according to engine switch mode, the presence of the electronic key, whether the doors are locked/unlocked, and whether the doors are open/closed.

■ To prevent battery discharge

If the following lights remain on when the engine switch is turned off the lights will go off automatically after 20 minutes:

- Personal/interior light
- Inside door handle lights
- Footwell lights
- Running board lights

■ Customization

Settings (e.g. adjust the time elapsed before the interior lights automatically turn off) can be changed. (Customizable features: →P. 600)

**NOTICE**

To prevent battery discharge, do not leave the lights on longer than necessary when the engine is not running.

List of storage features

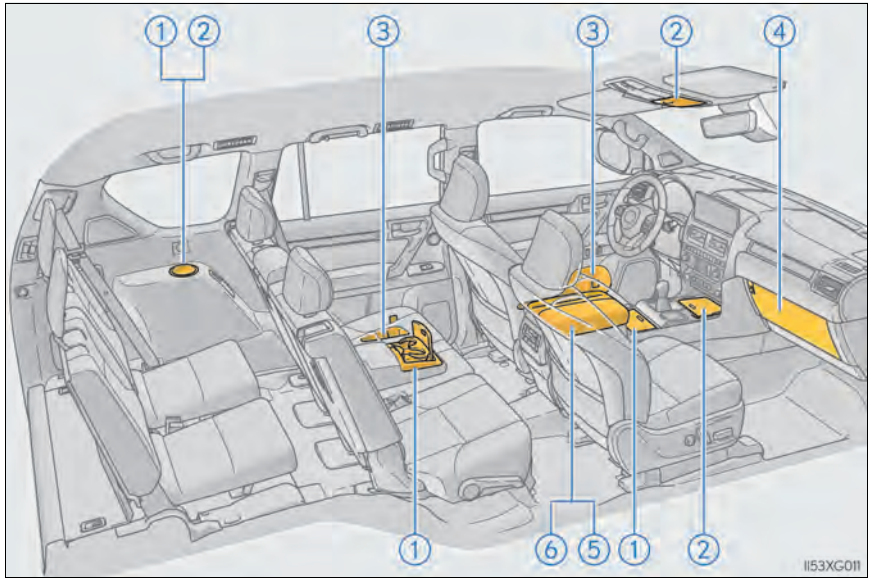

- | | | | |
|-------------------------------|-----------|-----------------------------|-----------|
| ① Cup holders | (→P. 426) | ⑤ Console box (if equipped) | (→P. 424) |
| ② Auxiliary boxes | (→P. 429) | Cool box (if equipped) | (→P. 438) |
| ③ Bottle holders/door pockets | (→P. 427) | ⑥ Coin holder (if equipped) | (→P. 425) |
| ④ Glove box | (→P. 424) | | |

WARNING

- Do not leave glasses, lighters or spray cans in the storage spaces, as this may cause the following when cabin temperature becomes high:
 - Glasses may be deformed by heat or cracked if they come into contact with other stored items.
 - Lighters or spray cans may explode. If they come into contact with other stored items, the lighter may catch fire or the spray can may release gas, causing a fire hazard.
- When driving or when the storage compartments are not in use, keep the lids closed. In the event of sudden braking or sudden swerving, an accident may occur due to an occupant being struck by an open lid or the items stored inside.

Glove box

- ① Unlock with the mechanical key
- ② Lock with the mechanical key
- ③ Open (push the button)

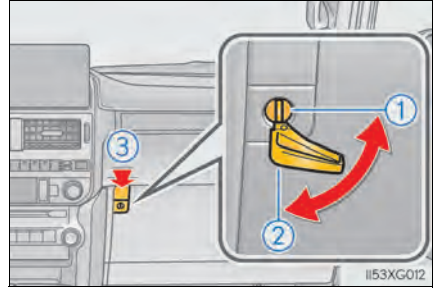

The glove box light turns on when the tail lights are on.

Console box (if equipped)

Your vehicle is equipped with either a console box or cool box.

For vehicles with the cool box, refer to P. 438.

Lift the lid while pulling up the lower lever to release the lock.

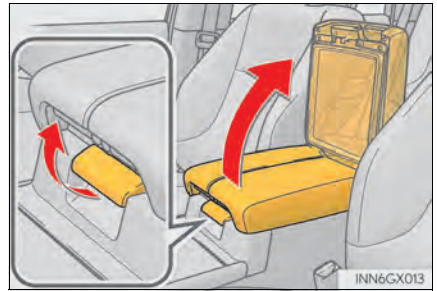

- The console box light turns on when the tail lights are on.
- When using the console box lid as an armrest, slide the console box lid forward or backward as needed. Slide the lid while pulling up the upper lever to release the lock.

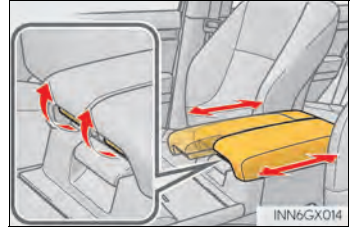

- The tray slides forward/backward and can be removed.

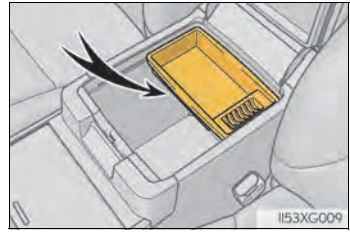

NOTICE

Do not insert items exceeding the height of the tray. Doing so may prevent opening and closing of the lid.

Coin holder (if equipped)

The coin holder is located in the console box.

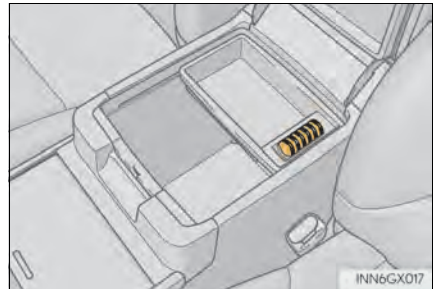

Cup holders/bottle holders/door pockets

■ Cup holders

▶ Front seats



Press down and release the cup holder lid.

▶ Second seats (6-passenger models)

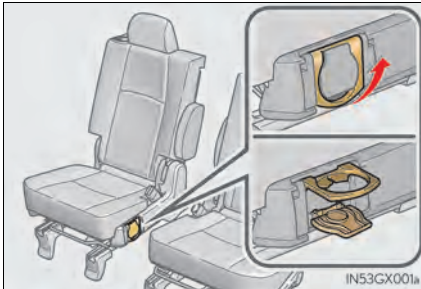

Pull the cup holder up.

▶ Second seats (7-passenger models)

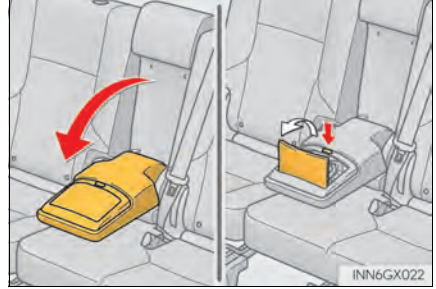

Pull the armrest down, and then press in and release the button.

▶ Third seats (if equipped)

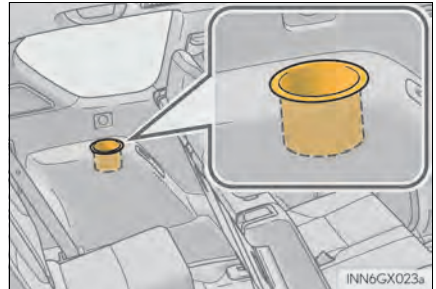

■ Bottle holders/door pockets

▶ Front

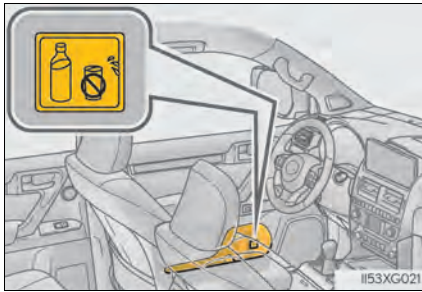

▶ Rear



■ Cup holder lights (front seats)

- The cup holder lights turn on when the tail lights are on.
- The brightness of the cup holder lights change in conjunction with the instrument cluster light. (→P. 89)

■ When using the holder as a bottle holder

- Close the cap.
- The bottle may not be stored depending on its size or shape.

■ Removing the cup holders (second seats for 6-passenger models)

The cup holders can be removed.

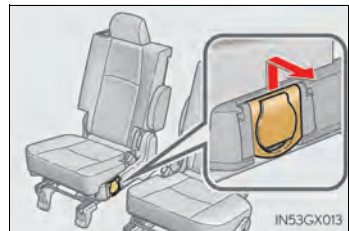

**WARNING****■ Items unsuitable for the cup holders/bottle holders**

- Do not place anything other than cups or beverage cans in the cup holders. Even when the lid is closed, items must not be stored in the cup holders. Other items may be thrown out of the holders in the event of sudden braking, sudden swerving or an accident, cause injury. If possible, cover hot drinks to prevent burns.
- Do not place anything other than bottles in the bottle holders. In the event of an accident or sudden braking, other items may be thrown out of the holders and cause injury.

■ When not in use

Keep the cup holders closed.

Injuries may result in the event of sudden braking, sudden swerving or an accident.

**NOTICE**

- To prevent damage, stow the rear cup holders before stowing the armrest. (second seats for 7-passenger models)
- To prevent damage, do not fold down the second seatbacks when using a cup holder on the second seats. (6-passenger models)
- To prevent damage, do not rest your hands on the cup holders or kick them.
- Do not place open bottles or glass and paper cups containing liquid in the bottle holders. The contents may spill and glasses may break.

Auxiliary boxes

► Type A

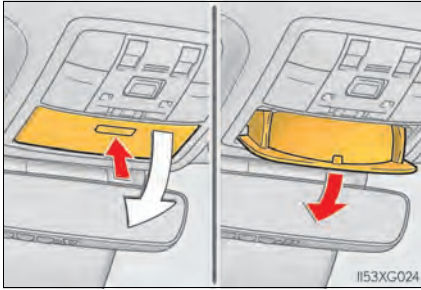

Press in the button and then pull down the lid.

The overhead console is useful for temporarily storing sunglasses and similar small items.

► Type C (if equipped)

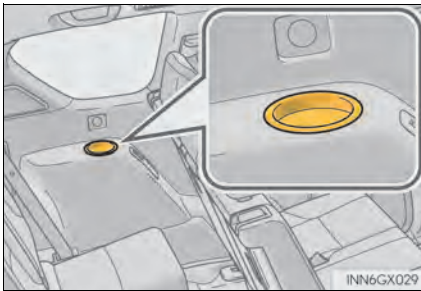

► Type B



Push the lid.

■ Auxiliary box light (type B)

- The auxiliary box light turns on when the tail lights are on.
- The brightness of the auxiliary box light changes in conjunction with the instrument cluster light. (→P. 89)

■ Closing the auxiliary box lid

Slide the auxiliary box lid forward.

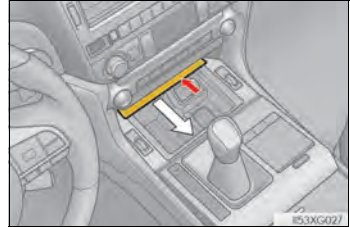
**⚠ WARNING****■ Caution while driving**

Do not place cups, beverage cans or bottles in the box. They may be thrown out of the box in the event of sudden braking, sudden swerving or an accident, resulting in injury. (type B and C)

■ Items unsuitable for storing (type A)

- Do not store items heavier than 0.4 lb. (0.2 kg).
Doing so may cause the auxiliary box to open and the items inside may fall out, resulting in an accident.
- Do not put large items in the overhead console.
The overhead console may not be able to be shut from the conversation mirror state.

Luggage compartment features

Cargo hooks

Raise the hook to use.

The cargo hooks are provided for securing loose items.

When using the cargo hooks, the third seat must be fold down. (→P. 138, 140)

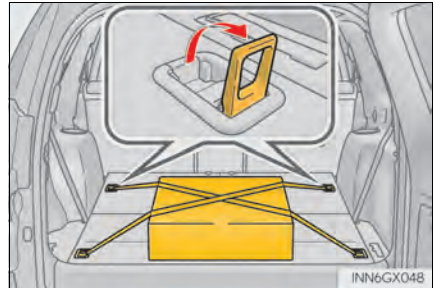

Warning reflector holder

- 1 Open the cover.
 - ① Turn the knob clockwise.
 - ② Open the cover.

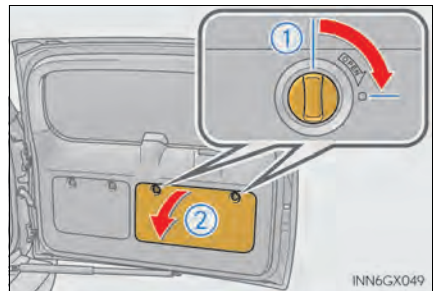

- 2 Secure the warning reflector.

The warning reflector itself is not included as an original equipment.

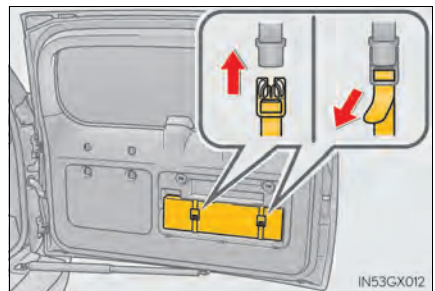

Cargo net hooks

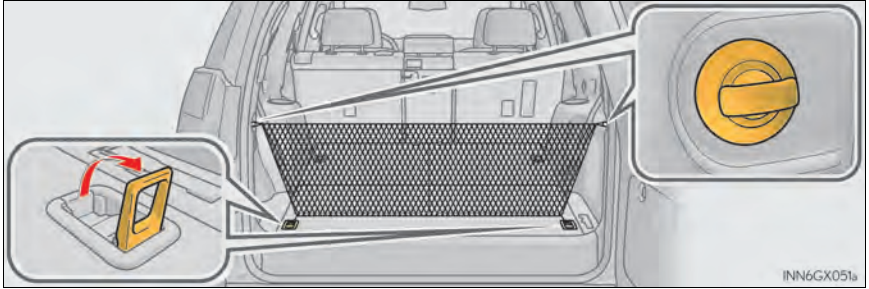

To hang the cargo net, use the cargo net hooks.

The cargo net itself is not included as an original equipment.

Auxiliary box (if equipped)

Remove the cover.

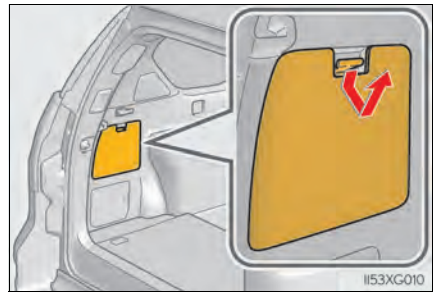

Luggage cover (if equipped)

■ Installing the luggage cover

- 1 Attach the hooks to the head restraints.

When using the luggage cover, the third seats must be folded down. (→P. 138, 140)

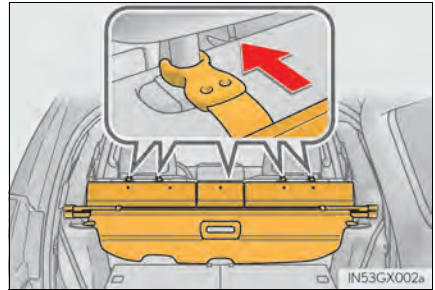

6-passenger models only: Secure the middle part of the luggage cover as shown.

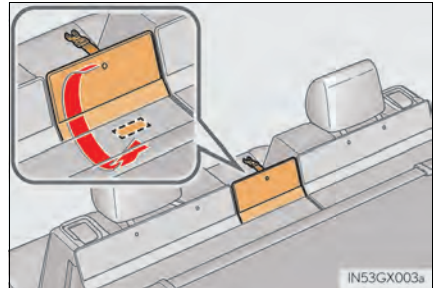

- 2 Pull out the luggage cover and hook it on the anchors.

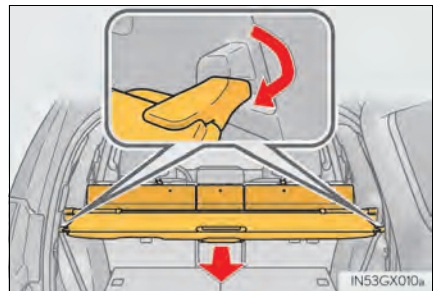

■ Removing the luggage cover

Retract the cover and release both ends, then lift it out.



■ Stowing the luggage cover

- 1** Push the case while pressing the lock release button.

Vehicles without rear automatic air conditioning system: Shorten one side only.

Vehicles with rear automatic air conditioning system: Shorten both sides.

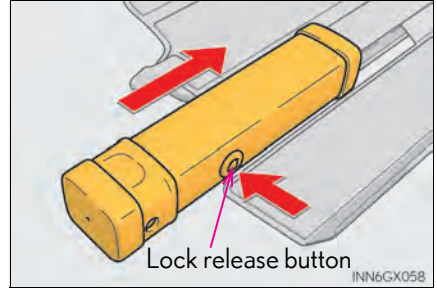

- 2** Push the case until it locks.

Check that the lock release button can be seen.

Vehicles without a rear automatic air conditioning system: Shorten one side only.

Vehicles with a rear automatic air conditioning system: Shorten both sides.

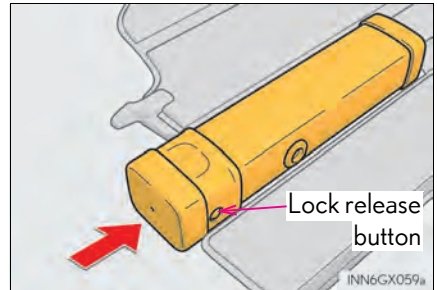

- 3** Secure the luggage cover with luggage cover restraining bands.

Check that luggage cover and luggage cover restraining bands are secured.

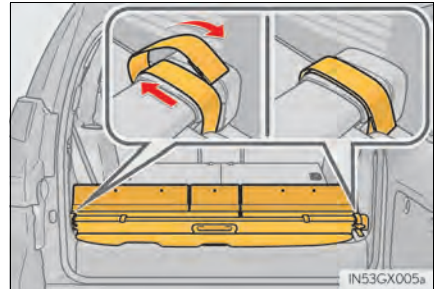

- 4** Fold over the cover and the sub cover.

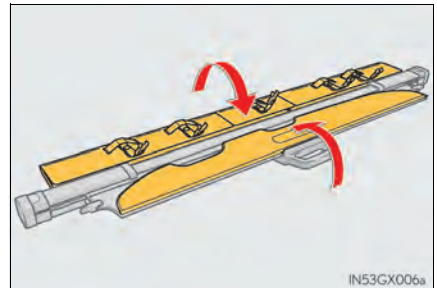

- 5 Stow the hooks.

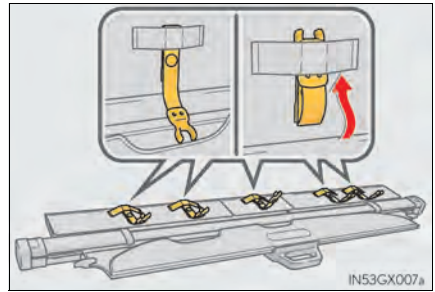

- 6 Fold over the sub cover.

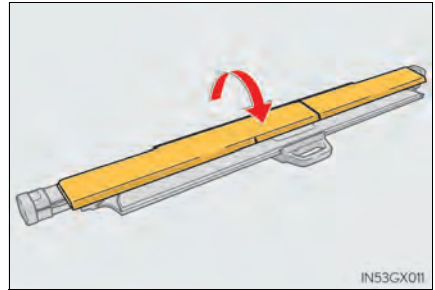

■ Extending the case

- 1 Push the lock release button.

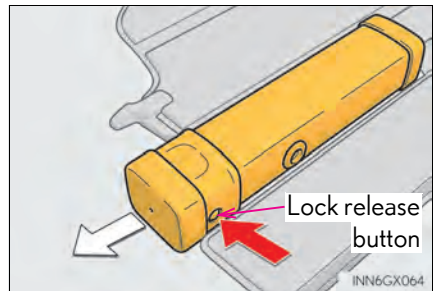

- 2 Pull the case until it locks.
Check that the lock release button can be seen.

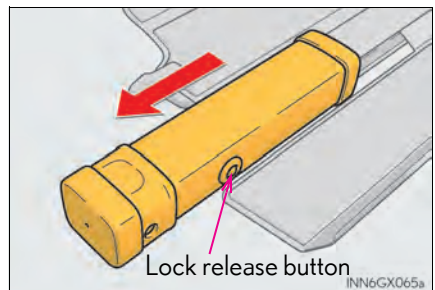

■ Adjusting the sub cover

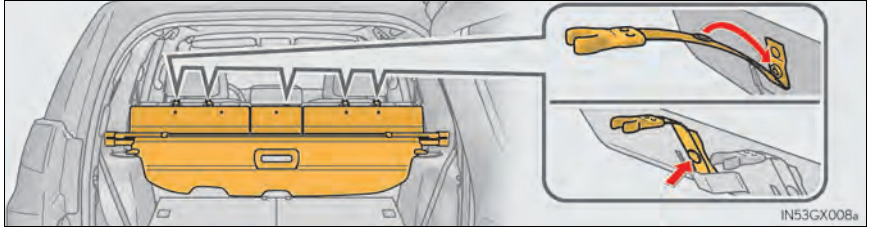

Fasten the button when the second seats are in the rear-most position.
Unfasten the buttons before sliding the second seats forward.

⚠ WARNING

- To avoid injury, always return the cargo hooks to their stowed positions when not in use.
- Keep the auxiliary box closed. In the event of sudden braking or sudden swerving, an accident may occur due to an occupant being struck by an open auxiliary box or the items stored inside.
- Keep the both sides of the luggage cover case locked. Otherwise, the luggage cover may fly out in case of the sudden braking, sudden swerving or an accident, resulting in death or serious injury.
- When stowing the luggage cover in the luggage compartment, use the luggage cover restraining bands to secure the left and right sides of the luggage cover. Otherwise, the luggage cover may fly out in case of the sudden braking, sudden swerving or an accident, resulting in death or serious injury.
- Do not allow children to climb on the luggage cover. Climbing on the luggage cover could result in damage to the luggage cover, possibly causing death or serious injury to the child.

 NOTICE**■ To prevent damage to the luggage cover**

When stowing the luggage cover, do not put luggage on the luggage cover.

- Do not insert coins etc. into the area shown in the illustration.



- Do not use the luggage cover restraining bands for anything other than securing the luggage cover.

Other interior features

Cool box (if equipped)

- 1 Lift the lid while pulling up the lower lever to release the lock.

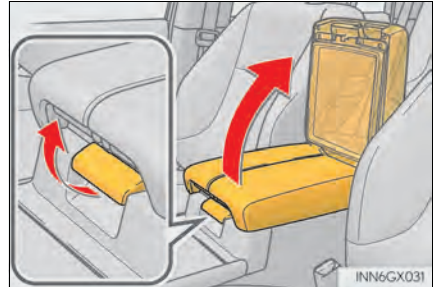

- 2 Turns the cool box on/off
When on, the indicator light comes on.

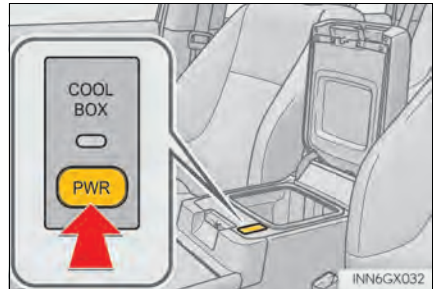

- **The cool box can be operated when**
The engine switch is in IGNITION ON mode.
- **If the front air conditioning system is not in use when the cool box is turned on**
The front air conditioning system is automatically turned on.

■ **While the cool box is on**

The front air conditioning system cannot be turned off.

■ **Items unsuitable for the cool box**

- Drinks in unsealed containers
- Fragile items, perishables or anything with strong odor
- Owner's manual, electronic devices, CDs, etc.

■ **When the indicator light flashes**

The cool box is not operated when any of the following conditions occurs.

- When the air conditioning system is off
Turn the air conditioning system on also turns on the cool box.
- When outside air temperature is about 32°F (0°C) or below.

If the indicator light continues to flash, there may be a malfunction in the system. Turn the air conditioning system off and have it inspected by your Lexus dealer.

■ **When using the cool box lid as an armrest**

Slide the cool box lid forward or backward as needed. Slide the lid while pulling up the upper lever to release the lock.

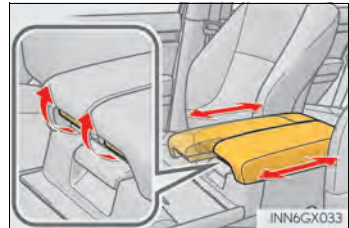

⚠ WARNING

Keep the cool box closed. In the event of sudden braking or sudden swerving, an accident may occur due to an occupant being struck by the open cool box or the items stored inside.

⚠ NOTICE

To prevent battery discharge, do not leave the cool box on longer than necessary when the engine is not running.

Sun visors

- ① To set the visor in the forward position, flip it down.
- ② To set the visor in the side position, flip down, unhook, and swing it to the side.
- ③ To use the side extender, place the visor in the side position, then slide it backward.

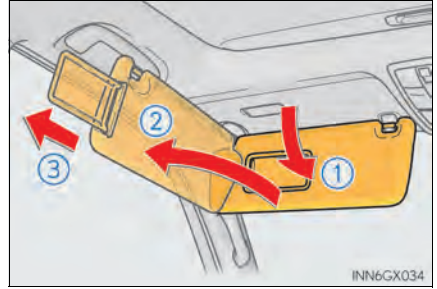

Vanity mirror

Slide the cover to open.

The light turns on when the cover is opened.

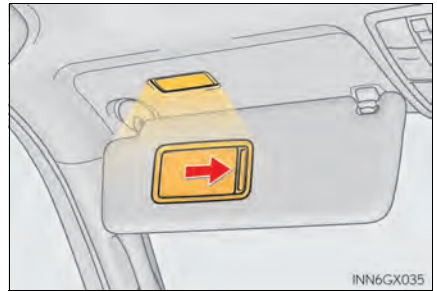

If the vanity lights remain on when the engine switch is turned off, the lights will go off automatically after 20 minutes.

⚠ NOTICE

To prevent battery discharge, do not leave the vanity lights on for extended periods when the engine is not running.

Conversation mirror

The conversation mirror can provide the driver and the front passenger with a view of the rear seat area without the need to turn around.

Press in the button.

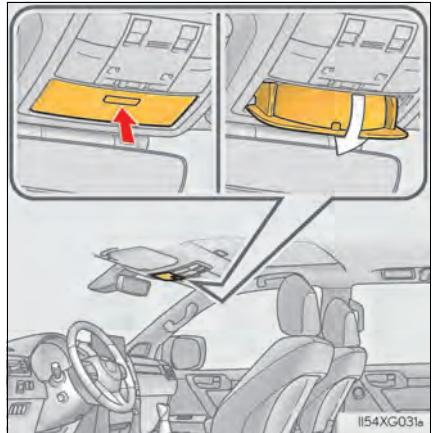

To use the overhead console when the conversation mirror is open, further extend the lid. (→P. 429)

Clock

The GPS clock's time is automatically adjusted by utilizing GPS time information.

For details, refer to "NAVIGATION SYSTEM OWNER'S MANUAL".

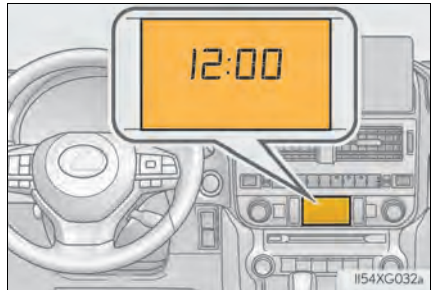

■ The clock is displayed when

The engine switch is in ACCESSORY ON mode or IGNITION ON mode.

■ When disconnecting and reconnecting battery terminals

The clock data will be reset.

Power outlets

■ Center of console (12 V DC)

Please use as a power supply for electronic goods that use less than 12 VDC / 10 A (power consumption of 120 W).

Slide the auxiliary box lid.

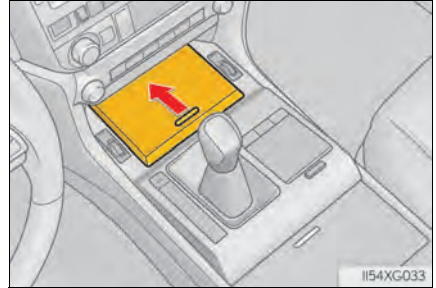

Open the lid.

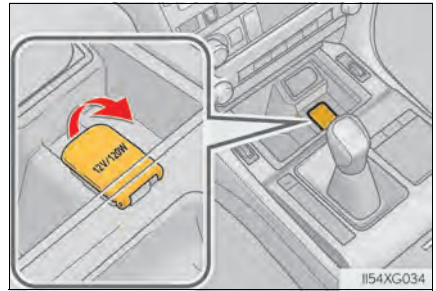

■ Luggage compartment (120 V AC)

The power outlet can be used for 120 V AC accessories that run on less than 100 W.



■ The power outlet can be used when

12 V DC: The engine switch is in ACCESSORY or IGNITION ON mode.

120 V AC: The engine switch is in IGNITION ON mode.

■ When turning the engine switch off (12 V DC)

Disconnect electrical devices with charging functions, such as mobile battery packs. If such devices are left connected, the engine switch may not be turned off normally.

■ The protection circuit may be activated to cut the power supply if any of the following conditions apply (120 V AC):

- Use of electrical appliances exceeding 100 W is attempted.

A sound may be heard when the protection circuit is activated. This is normal and does not indicate a malfunction.

- The total power usage by all electrical features (headlights, air conditioning, etc.) has exceeded the total vehicle maximum for an extended period of time.

■ If the protection circuit is activated and the power supply is cut, conduct the following procedure (120 V AC):

- 1 Park the vehicle in a safe place, and then securely apply the parking brake.
- 2 Make sure that the power consumption of the electric appliance is within the maximum capacity of the power outlet and the appliance is not broken.
- 3 Turn the engine switch to IGNITION ON mode again.

When the cabin temperature is high, open the windows to cool the temperature down. Once it reaches the normal temperature, turn the engine switch to IGNITION ON mode again.

If the power supply does not resume even after the above procedure has been performed, have the vehicle inspected by your Lexus dealer.

**WARNING****■ Using a power outlet (120 V AC)**

Observe the following precautions to reduce the risk of injury.

- Use of the power outlet when it is wet with water or snow may result in electrical shocks and is extremely dangerous. The power outlet must be thoroughly dried before use.
 - Do not allow children to use or play with the power outlet.
 - Be careful not to get any part of your body caught in the power outlet lid.
 - When using electrical appliances, strictly follow any cautions and notices written on their labels and in the manufacturers' instruction manuals.
 - Do not modify, disassemble or repair the power outlet or its inverter in any way. Doing so may result in unexpected malfunctions or accidents, which could cause serious damage or injuries. Contact your Lexus dealer for any necessary repairs.
- To prevent injuries and accidents, secure all electric appliances before use and do not use any appliances that may do any of the following (120 V AC):**
- Distract the driver while driving, or hamper safe driving.
 - Result in a fire or burn injuries due to the appliance rolling, falling or overheating while driving.
 - Emit steam while the windows of the cabin are closed.
- To prevent unexpected accidents, such as electric shocks, do not perform any of the following actions (120 V AC):**
- Using the power outlet for electric heaters while sleeping.
 - Contaminating the power outlet with liquid substances or mud.
 - Handling electrical appliance plugs at the power outlet with wet hands or feet.
 - Inserting foreign objects into the power outlet.
 - Using malfunctioning electric appliances.
 - Inserting inappropriate or badly fitting plugs into the power outlet.

**NOTICE****■ To avoid damaging the power outlet and the plug (120 V AC)**

- Close the power outlet lid when not in use.
- Do not allow foreign objects or liquids to enter the power outlet, as this may cause a short circuit.
- Do not use plug adaptors to connect too many plugs to the power outlet.
- After removing a plug, gently close the power outlet lid.

 NOTICE**■ To prevent the fuse from being blown**

12 V DC: Do not use an accessory that uses more than 12 V 10 A.

120 V AC: Do not use a 120 V AC appliance that requires more than 100 W.

If a 120 V AC appliance that consumes more than 100 W is used, the protection circuit will cut the power supply.

■ Appliances that may not operate properly (120 V AC)

The following 120 V AC appliances may not operate even if their power consumption is under 100 W.

- Appliances with high initial peak wattage
- Measuring devices that process precise data.
- Other appliances that require an extremely stable power supply

■ To prevent battery discharge

12 V DC: Do not use the power outlet longer than necessary when the engine is not running.

120 V AC: Turn off all the vehicle's electronic equipment and accessories, such as the headlights and air conditioning, when electrical appliances that consume in excess of 100 W are used continuously for long periods of time.

■ To prevent any damage caused by heat (120 V AC)

- Do not use any electrical appliances that give off intense heat, such as toasters, in any locations including the internal or external trim, seats and deck.
- Do not use any electrical appliances that are easily affected by vibration or heat inside the vehicle. Vibration while driving, or the heat of the sun while parking, may result in damage to those electrical appliances.

■ If any electrical appliances are to be used while driving (120 V AC)

Securely fasten both the appliances and their cables to prevent them from falling or getting caught in any of the power train components.

■ If the power outlet is loose when an electrical appliance plug is connected (120 V AC)

Replace the outlet. Contact your Lexus dealer for any necessary replacements.

■ If the power outlet gets dirty (120 V AC)

Turn the main switch off and use a soft, clean cloth to wipe it gently. Do not use any cleansing materials, such as organic solvents, wax, or compound cleaners, as these may damage the power outlet or cause it to malfunction.

USB charging ports

The USB charging ports are used to supply 2.1 A of electricity at 5 V to external devices.

The USB charging ports are for charging only. They are not designed for data transfer or other purposes.

Depending on the external device, it may not charge properly. Refer to the manual included with the device before using a USB charging port.

■ Using the USB charging ports

▶ Type A

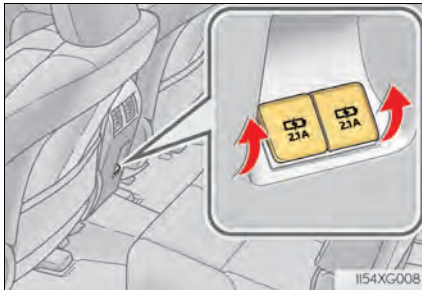

Open the lid.

▶ Type B



Open the lid.

■ The USB charging ports can be used when

The engine switch is in ACCESSORY or IGNITION ON mode.

■ Situations in which the USB charging ports may not operate correctly

- If a device which consumes more than 2.1 A at 5 V is connected
- If a device designed to communicate with a personal computer, such as a USB memory device, is connected
- If the connected external device is turned off (depending on device)
- If the temperature inside the vehicle is high, such as after the vehicle has been parked in the sun

■ About connected external devices

Depending on the connected external device, charging may occasionally be suspended and then start again. This is not a malfunction.

 NOTICE**■ To prevent damage to the USB charging ports**

- Do not insert foreign objects into the ports.
- Do not spill water or other liquids into the ports.
- When the USB charging ports are not in use, close the lids. If a foreign object or liquid enters a port may cause a short circuit.
- Do not apply excessive force to or impact the USB charging ports.
- Do not disassemble or modify the USB charging ports.

■ To prevent damage to external devices

- Do not leave external devices in the vehicle. The temperature inside the vehicle may become high, resulting in damage to an external device.
- Do not push down on or apply unnecessary force to an external device or the cable of an external device while it is connected.

■ To prevent battery discharge

Do not use the USB charging ports for a long period of time with the engine stopped.

Armrest

▶ 7-passenger models

Fold down the armrest for use.

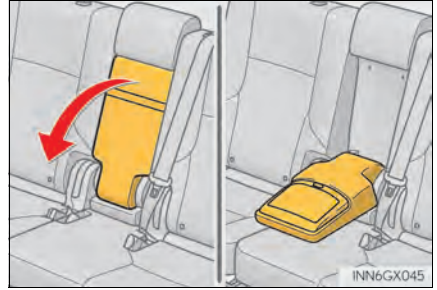

▶ 6-passenger models

To adjust the armrest angle, raise the armrest to the highest position and then lower the armrest to the lowest position. Raise the armrest again to the desired position and the armrest will be locked at that position.

When the armrest is locked, the armrest cannot be lowered.

To lower the armrest, raise the armrest to the highest position again.

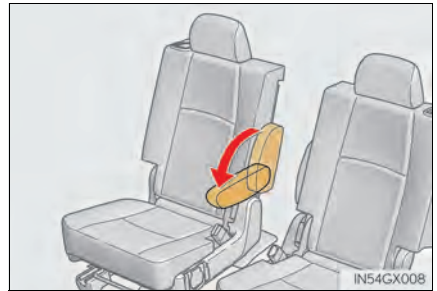

NOTICE

To prevent damage, do not apply a too heavy load on the armrest.

Coat hooks

The coat hooks are provided with the second rear assist grips.

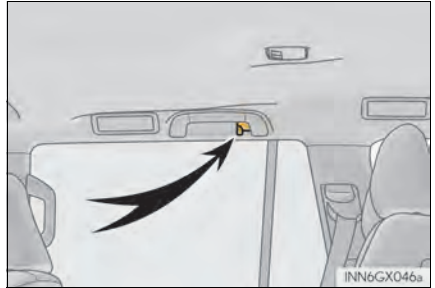

⚠️ WARNING

Do not hang coat hangers or other hard or sharp objects on the hook. If the SRS curtain shield airbags deploy, these items may become projectiles, causing death or serious injury.

Assist grips

An assist grip (type A) can be used to support your body while sitting on the seat. An assist grip (type B) can be used when getting in or out of the vehicle and others.

- ① Assist grip (type A)
- ② Assist grip (type B)

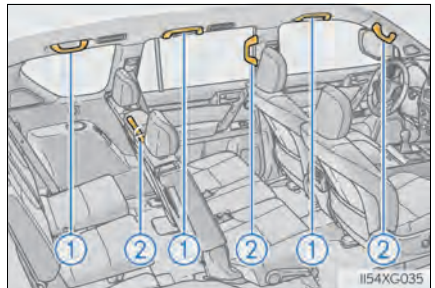

⚠️ WARNING

Do not use the assist grip (type A) when getting in or out of the vehicle or rising from your seat.

⚠️ NOTICE

To prevent damage, do not hang heavy objects or put a heavy load on the assist grip.

Garage door opener

The garage door opener can be programmed to operate garage doors, gates, entry doors, door locks, home lighting systems, security systems, and other devices.

■ HomeLink[®] programming procedure

The programming procedures can also be found at the following URL.
Website: www.homelink.com/lexus



For support, contact customer support at the following.
Help Line: 1-800-355-3515

Programming HomeLink[®]

The HomeLink[®] wireless control system in your vehicle has 3 buttons which can be programmed to operate 3 different devices. Refer to the programming methods on the following pages to determine the method which is appropriate for the device.

- ① HomeLink[®] indicator light
 - ② Garage door operation indicators
 - ③ HomeLink[®] icon
 - ④ Buttons
- Illuminates while HomeLink[®] is operating.

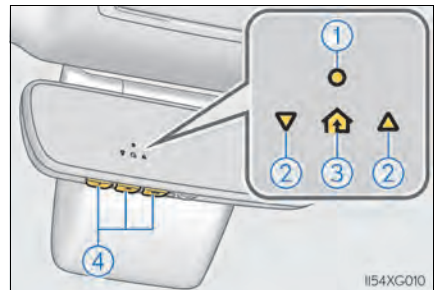

I154XG010

■ Before programming HomeLink®

- During programming, it is possible that garage doors, gates, or other devices may operate. For this reason, make sure that people and objects are clear of the garage door or other devices to prevent injury or other potential harm.
- It is recommended that a new battery be placed in the remote control transmitter for more accurate programming.
- Garage door opener motors manufactured after 1995 may be equipped with rolling code protection. If this is the case, you may need a stepladder or other sturdy, safe device to reach the “Learn” or “Smart” button on the garage door opener motor.

■ Programming the HomeLink®

Steps **1** through **3** must be performed within 60 seconds, otherwise the indicator light will stop flashing and programming will not be able to be completed.

- 1** Press and release the HomeLink® button you want to program and check that the HomeLink® indicator light flashes (orange).
- 2** Point the remote control transmitter for the device at the rear view mirror, 1 to 3 in. (25 to 75 mm) from the HomeLink® buttons.
Keep the HomeLink® indicator light in view while programming.

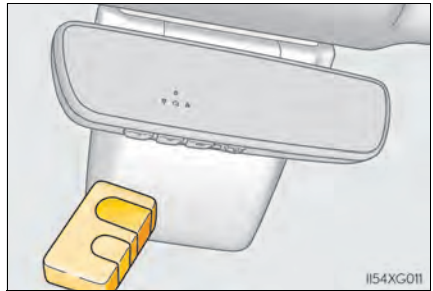

3 Program a device.

- ▶ Programming a device other than an entry gate (for U.S.A. owners)

Press and hold the remote control transmitter button until the HomeLink[®] indicator light changes from slowly flashing orange to rapidly flashing green (rolling code) or continuously lit green (fixed code), then release the button.

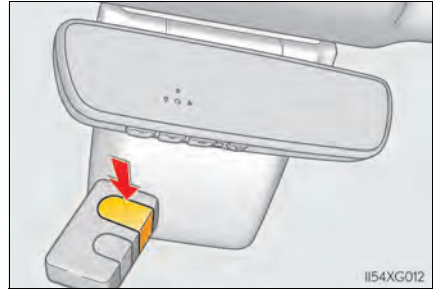

- ▶ Programming an entry gate (for U.S.A. owners)/Programming a device in the Canadian market

Press and release the remote control transmitter button at 2 second intervals, repeatedly, until the HomeLink[®] indicator light changes from slowly flashing (orange) to rapidly flashing (green) (rolling code) or continuously lit (green) (fixed code).

4 Test the HomeLink[®] operation by pressing the newly programmed button and observing the indicator light:

- Indicator light illuminates: Programming of a fixed code device has completed. The garage door or other device should operate when a HomeLink[®] button is pressed and released.
- Indicator light flashes rapidly: The garage door opener motor or other device is equipped with a rolling code. To complete programming, firmly press and hold the HomeLink[®] button for 2 seconds then release it.
- If the garage door or other device does not operate, proceed to “Programming a rolling code system”.

5 Repeat the steps above to program another device for any of the remaining HomeLink[®] buttons.

■ Programming a rolling code system

2 or more people may be necessary to complete rolling code programming.

- 1 Locate the “Learn” or “Smart” button on the garage door opener motor in the garage.

This button can usually be found where the hanging antenna wire is attached to the unit. The name and color of the button may vary by manufacturer. Refer to the owner’s manual supplied with the garage door opener motor for details.

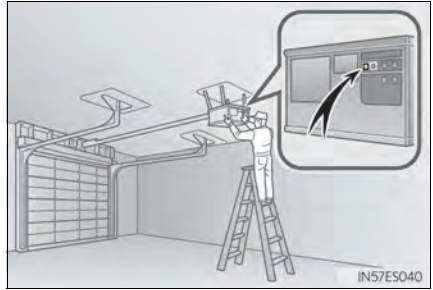

- 2 Press and release the “Learn” or “Smart” button.

Perform 3 within 30 seconds after performing 2.

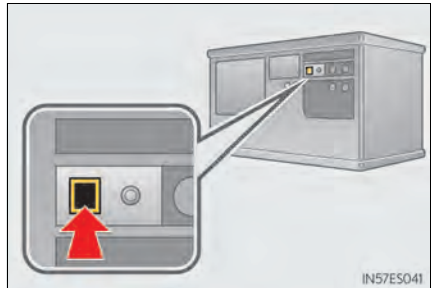

- 3 Press and hold the desired HomeLink® button (inside the vehicle) for 2 seconds and release it. Repeat this sequence (press/hold/release) up to 3 times to complete programming.

If the garage door opener motor operates when the HomeLink® button is pressed, the garage door opener motor recognizes the HomeLink® signal.

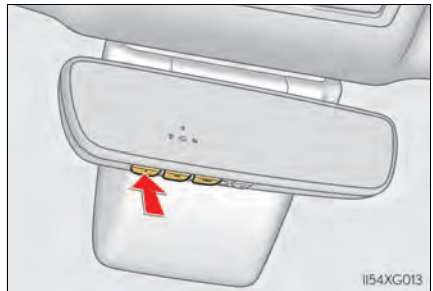

■ Enabling 2-way communication with a garage door (only available for compatible devices)

When enabled, 2-way communication allows you to check the status of the opening and closing of a garage door through indicators in your vehicle.

2-way communication is only available if the garage door opener motor used is a compatible device. (To check device compatibility, refer to www.HomeLink.com.)

- 1 Within 5 seconds after programming the garage door opener has been completed, if the garage door opener motor is trained to HomeLink[®], both garage door operation indicators will flash rapidly (green) and the light on the garage door opener motor will blink twice, indicating that 2-way communication is enabled.

If the indicators do not flash, perform **2** and **3** within the first 10 presses of the HomeLink[®] button after programming has been completed.

- 2 Press a programmed HomeLink[®] button to operate a garage door.
- 3 Within 1 minute of pressing the HomeLink[®] button, after the garage door operation has stopped, press the “Learn” or “Smart” button on the garage door opener motor. Within 5 seconds of the establishment of 2-way communication with the garage door opener, both garage door operation indicators in the vehicle will flash rapidly (green) and the light on the garage door opener motor will blink twice, indicating that 2-way communication is enabled.

■ Reprogramming a single HomeLink[®] button

When the following procedure is performed, buttons which already have devices registered to them can be overwritten:

- 1 With one hand, press and hold the desired HomeLink[®] button.
- 2 When the HomeLink[®] indicator starts flashing (orange), continue to hold the HomeLink[®] button and perform “Programming HomeLink[®]” **1** (it takes 20 seconds for the HomeLink[®] indicator to start flashing).

Operating HomeLink[®]

Press the appropriate HomeLink[®] button. The HomeLink[®] indicator light should turn on.

Garage door operation indicators

The status of the opening and closing of a garage door is shown by the indicators.





- ① Opening
- ② Closing

This function is only available if the garage door opener motor used is a compatible device. (To check device compatibility, refer to www.HomeLink.com.)



Color	Status
Orange (flashing)	Currently opening/closing
Green	Opening/closing has completed
Red (flashing)	Feedback signals cannot be received

The indicators can operate within approximately 820 ft. (250 m) of the garage door. However, if there are obstructions between the garage door and the vehicle, such as houses and trees, feedback signals from the garage door may not be received.

To recall the previous door operation status, press and release either HomeLink® buttons  and  or  and  simultaneously.

The last recorded status will be displayed for 3 seconds.

Erasing the entire HomeLink® memory (all three codes)

Press and hold the 2 outside buttons for 10 seconds until the HomeLink® indicator light changes from continuously lit (orange) to rapidly flashing (green).

If you sell your vehicle, be sure to erase the programs stored in the HomeLink® memory.



- **Codes stored in the HomeLink® memory**
 - The registered codes are not erased even if the battery cable is disconnected.
 - If learning failed when registering a different code to a HomeLink® button that already has a code registered to it, the already registered code will not be erased.
- **Before programming**
 - Install a new battery in the transmitter.
 - The battery side of the transmitter must be pointed away from the HomeLink®.

**WARNING****■ When programming a garage door or other remote control device**

The garage door or other device may operate, so ensure people and objects are out of danger to prevent potential harm.

■ Conforming to federal safety standards

Do not use the HomeLink® compatible transceiver with any garage door opener or device that lacks safety stop and reverse features as required by federal safety standards.

This includes any garage door that cannot detect an interfering object. A door or device without these features increases the risk of death or serious injury.

■ When operating or programming HomeLink®

Never allow a child to operate or play with the HomeLink® buttons.

6-1. Maintenance and care	
Cleaning and protecting the vehicle exterior	458
Cleaning and protecting the vehicle interior	461
6-2. Maintenance	
Maintenance requirements	464
General maintenance	467
Emission inspection and maintenance (I/M) programs	470
6-3. Do-it-yourself maintenance	
Do-it-yourself service precautions	471
Hood	474
Engine compartment	475
Tires	488
Tire inflation pressure	499
Wheels	503
Air conditioning filter	505
Electronic key battery	507
Checking and replacing fuses	509
Headlight aim	512
Light bulbs	514

Cleaning and protecting the vehicle exterior

Perform the following to protect the vehicle and maintain it in prime condition:

- Working from top to bottom, liberally apply water to the vehicle body, wheel wells and underside of the vehicle to remove any dirt and dust.
- Wash the vehicle body using a sponge or soft cloth, such as a chamois.
- For hard-to-remove marks, use car wash soap and rinse thoroughly with water.
- Wipe away any water.
- Wax the vehicle when the waterproof coating deteriorates.
If water does not bead on a clean surface, apply wax when the vehicle body is cool.

■ Automatic car washes

- Fold the mirrors back before washing the vehicle. Start washing from the front of the vehicle. Make sure to extend the mirrors before driving.
- Brushes used in automatic car washes may scratch the vehicle surface, parts (wheel, etc.) and harm your vehicle's paint.

■ High pressure car washes

- As water may enter the cabin, do not bring the nozzle tip near the gaps around the doors or perimeter of the windows, or spray these areas continuously.
- For vehicles with rear height control air suspension, do not bring the nozzle tip near the rear air suspension unit.

■ Wheels and wheel ornaments

- Remove any dirt immediately by using a neutral detergent.
- Wash detergent off with water immediately after use.
- To protect the paint from damage, make sure to observe the following precautions.
 - Do not use acidic, alkaline or abrasive detergent
 - Do not use hard brushes
 - Do not use detergent on the wheels when they are hot, such as after driving or parking in hot weather

■ Brake pads and calipers

Rust may form if the vehicle is parked with wet brake pads or disc rotors, causing them to stick. Before parking the vehicle after it is washed, drive slowly and apply the brakes several times to dry the parts.

■ Bumpers and side moldings

Do not scrub with abrasive cleaners.

■ Front side windows water-repellent coating

- The following precautions can extend the effectiveness of the water-repellent coating.
 - Remove any dirt, etc. from the front side windows regularly.
 - Do not allow dirt and dust to accumulate on the windows for a long period. Clean the windows with a soft, damp cloth as soon as possible.
 - Do not use wax or glass cleaners that contain abrasives when cleaning the windows.
 - Do not use any metallic objects to remove condensation build up.
- When the water-repellent performance has become insufficient, the coating can be repaired. Contact your Lexus dealer.

■ Plated portions

If dirt cannot be removed, clean the parts as follows:

- Use a soft cloth dampened with an approximately 5% solution of neutral detergent and water to clean the dirt off.
- Wipe the surface with a dry, soft cloth to remove any remaining moisture.
- To remove oily deposits, use alcohol wet wipes or a similar product.

⚠ WARNING

■ When washing the vehicle

Do not apply water to the inside of the engine compartment. Doing so may cause the electrical components etc. to catch fire.

■ When cleaning the windshield (vehicles with rain-sensing windshield wiper)

Set the wiper switch to off.

If the wiper switch is in "AUTO", the wipers may operate unexpectedly in the following situations, and may result in hands being caught or other serious injuries and cause damage to the wiper blades.

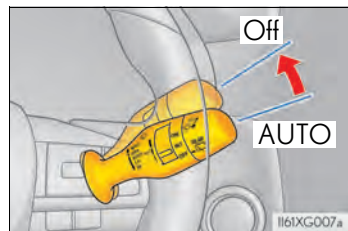

- When the upper part of the windshield where the raindrop sensor is located is touched by hand
- When a wet rag or similar is held close to the raindrop sensor
- If something bumps against the windshield
- If you directly touch the raindrop sensor body or if something bumps into the raindrop sensor

■ Precautions regarding the exhaust pipe

Exhaust gasses cause the exhaust pipe to become quite hot.

When washing the vehicle, be careful not to touch the pipe until it has cooled sufficiently, as touching a hot exhaust pipe can cause burns.

■ Precautions regarding the Blind Spot Monitor

If the paint of the rear bumper is chipped or scratched, the system may malfunction. If this occurs, consult your Lexus dealer.

 NOTICE**■ To prevent paint deterioration and corrosion on the body and components (aluminum wheels etc.)**

- Wash the vehicle immediately in the following cases:
 - After driving near the sea coast
 - After driving on salted roads
 - If coal tar or tree sap is present on the paint surface
 - If you see dead insects, insect droppings or bird droppings on the paint
 - After driving in an area contaminated with soot, oily smoke, mine dust, iron powder or chemical substances
 - If the vehicle becomes heavily soiled in dust or mud
 - If liquids such as benzene and gasoline are spilled on the paint surface
- If the paint is chipped or scratched, have it repaired immediately.
- To prevent the wheels from corroding, remove any dirt and store in a place with low humidity when storing wheels.

■ Cleaning the exterior lights

- Wash carefully. Do not use organic substances or scrub with a hard brush. This may damage the surfaces of the lights.
- Do not apply wax on the surfaces of the lights. Wax may cause damage to the lenses.

■ To prevent damage to the windshield wiper arms

When lifting the wiper arms away from the windshield, pull the driver side wiper arm upward first, and repeat for the passenger side. When returning the wipers to their original position, do so from the passenger side first.

■ When using an automatic car wash (vehicles with rain-sensing windshield wiper)

Set the wiper switch to the off position.

If the wiper switch is in "AUTO", the wipers may operate and the wiper blades may be damaged.

■ When using a high pressure car wash

Do not spray water directly on the radar which is equipped behind the emblem. Otherwise it may cause the device to be damaged.

- Do not bring the nozzle tip close to boots (rubber or resin manufactured cover), connectors or the following parts. The parts may be damaged if they come into contact with high-pressure water.
 - Traction related parts
 - Steering parts
 - Suspension parts
 - Brake parts
- Keep the cleaning nozzle at least 11.9 in. (30 cm) away from the vehicle body. Otherwise resin section, such as moldings and bumpers, may be deformed and damaged. Also, do not continuously hold the nozzle in the same place.
- Do not spray the lower part of the windshield continuously. If water enters the air conditioning system intake located near the lower part of the windshield, the air conditioning system may not operate correctly.
- Do not wash the underside of the vehicle using a high pressure car washer.

Cleaning and protecting the vehicle interior

The following procedures will help protect your vehicle's interior and keep it in top condition:

Protecting the vehicle interior

- Remove dirt and dust using a vacuum cleaner. Wipe dirty surfaces with a cloth dampened with lukewarm water.
- If dirt cannot be removed, wipe it off with a soft cloth dampened with neutral detergent diluted to approximately 1%.
- Wring out any excess water from the cloth and thoroughly wipe off remaining traces of detergent and water.

Cleaning the areas with satin-finish metal accents

- Remove dirt using a water-dampened soft cloth or synthetic chamois.
- Wipe the surface with a dry soft cloth to remove any remaining moisture.

Cleaning the leather areas

- Remove dirt and dust using a vacuum cleaner.
- Wipe any excess dirt and dust with a soft cloth dampened with diluted detergent.
Use a diluted water solution of approximately 5% neutral wool detergent.
- Wring out any excess water from the cloth and thoroughly wipe off all remaining traces of detergent.
- Wipe the surface with a dry, soft cloth to remove any remaining moisture. Allow the leather to dry in a shaded ventilated area.

Cleaning the synthetic leather areas

- Remove dirt and dust using a vacuum cleaner.
- Wipe it off with a soft cloth dampened with neutral detergent diluted to approximately 1%.
- Wring out any excess water from the cloth and thoroughly wipe off remaining traces of detergent and water.

■ Cleaning the areas with satin-finish metal accents

The metal areas use a layer of real metal for the surface. It is necessary to clean them regularly. If dirty areas are left uncleaned for long periods of time, they may be difficult to clean.

■ Caring for leather areas

Lexus recommends cleaning the interior of the vehicle at least twice a year to maintain the quality of the vehicle's interior.

■ Shampooing the carpets

There are several commercial foaming-type cleaners available. Use a sponge or brush to apply the foam. Rub in overlapping circles. Do not use water. The excellent results are obtained when keeping the carpet as dry as possible.

■ Seat belts

Clean with mild soap and lukewarm water using a cloth or sponge. Also check the belts periodically for excessive wear, fraying or cuts.



WARNING

■ Water in the vehicle

- Do not splash or spill liquid in the vehicle.
Doing so may cause electrical components etc. to malfunction or catch fire.
- Do not get any of the SRS components or wiring in the vehicle interior wet. (→P. 38)
An electrical malfunction may cause the airbags to deploy or not function properly, resulting in death or serious injury.

■ Cleaning the interior (especially instrument panel)

Do not use polish wax or polish cleaner. The instrument panel may reflect off the windshield, obstructing the driver's view and leading to an accident, resulting in death or serious injury.



NOTICE

■ Cleaning detergents

- Do not use the following types of detergent, as they may discolor the vehicle interior or cause streaks or damage to painted surfaces:
 - Non-seat portions: Organic substances such as benzene or gasoline, alkaline or acidic solutions, dye, and bleach
 - Seats: Alkaline or acidic solutions, such as thinner, benzene, and alcohol
- Do not use polish wax or polish cleaner. The instrument panel's or other interior part's painted surface may be damaged.

 NOTICE**■ Preventing damage to leather surfaces**

Observe the following precautions to avoid damage to and deterioration of leather surfaces:

- Remove any dust or dirt from leather surfaces immediately.
- Do not expose the vehicle to direct sunlight for extended periods of time. Park the vehicle in the shade, especially during summer.
- Do not place items made of vinyl, plastic, or containing wax on the upholstery, as they may stick to the leather surface if the vehicle interior heats up significantly.

■ When cleaning the inside of the windshield

Do not allow glass cleaner to contact the lens. Also, do not touch the lens. (→P. 233)

■ Water on the floor

Do not wash the vehicle floor with water.

Vehicle systems such as the audio system may be damaged if water comes into contact with electrical components such as the audio system above or under the floor of the vehicle. Water may also cause the body to rust.

■ Cleaning the inside of the rear window

- Do not use glass cleaner to clean the rear window, as this may cause damage to the rear window defogger heater wires or antenna. Use a cloth dampened with luke-warm water to gently wipe the window clean. Wipe the window in strokes running parallel to the heater wires or antenna.
- Be careful not to scratch or damage the heater wires or antenna.

Maintenance requirements

To ensure safe and economical driving, day-to-day care and regular maintenance are essential. It is the owner's responsibility to perform regular checks. Lexus recommends the following maintenance:

General maintenance

General maintenance should be performed on a daily basis. This can be done by yourself or by a Lexus dealer.

Scheduled maintenance

Scheduled maintenance should be performed at specified intervals according to the maintenance schedule.

For details about maintenance items and schedules, refer to the "Warranty and Service Guide", "Owner's Manual Supplement" or "Scheduled Maintenance".

Do-it-yourself maintenance

You can perform some maintenance procedures by yourself.

Please be aware that do-it-yourself maintenance may affect warranty coverage.

The use of Lexus repair manuals is recommended.

For details about warranty coverage, refer to the separate "Owner's Guide", "Warranty and Service Guide", "Owner's Manual Supplement" or "Warranty Booklet".











■ Repair and replacement

It is recommended that genuine Lexus parts be used for repairs to ensure performance of each system. If non-Lexus parts are used in replacement or if a repair shop other than a Lexus dealer performs repairs, confirm the warranty coverage.

■ Resetting the message indicating maintenance is required (U.S.A. only)

After the required maintenance is performed according to the maintenance schedule, please reset the message.

To reset the message, follow the procedures described below:

- 1 Press  or  of the meter control switches and select  on the multi-information display.
- 2 Press  or  of the meter control switches and select "Vehicle Settings", and then press .
- 3 Press  or  of the meter control switches and select "Scheduled Maintenance", and then press .
- 4 Select the "Yes" and press .

"The Data Has Been Reset" will be displayed when the reset procedure has been completed.

■ Allow inspection and repairs to be performed by a Lexus dealer

- Lexus technicians are well-trained specialists and are kept up to date with the latest service information. They are well informed about the operation of all systems on your vehicle.
- Keep a copy of the repair order. It proves that the maintenance that has been performed is under warranty coverage. If any problem should arise while your vehicle is under warranty, your Lexus dealer will promptly take care of it.

**WARNING****■ If your vehicle is not properly maintained**

Improper maintenance could result in serious damage to the vehicle and possible serious injury or death.

■ Handling of the battery

- Engine exhaust, some of its constituents, and a wide variety of automobile components contain or emit chemicals known to the State of California to cause cancer and birth defects and other reproductive harm. Work in a well ventilated area.
- Oils, fuels and fluids contained in vehicles as well as waste produced by component wear contain or emit chemicals known to the State of California to cause cancer and birth defects or other reproductive harm. Avoid exposure and wash any affected area immediately.
- Battery posts, terminals and related accessories contain lead and lead compounds which are known to cause brain damage. Wash your hands after handling. (→P. 484)

General maintenance

Listed below are the general maintenance items that should be performed at the intervals specified in the “Warranty and Service Guide” or “Owner’s Manual Supplement”. It is recommended that any problem you notice should be brought to the attention of your Lexus dealer or qualified service shop for advice.

Engine compartment

Items	Check points
Battery	Check the connections. (→P. 484)
Brake fluid	Is the brake fluid at the correct level? (→P. 481)
Engine coolant	Is the engine coolant at the correct level? (→P. 479)
Engine oil	Is the engine oil at the correct level? (→P. 477)
Exhaust system	There should not be any fumes or strange sounds.
Power steering fluid	Is the power steering fluid at the correct level? (→P. 483)
Radiator/condenser	The radiator and condenser should be free from foreign objects. (→P. 481)
Washer fluid	Is there sufficient washer fluid? (→P. 487)

Vehicle interior

Items	Check points
Accelerator pedal	<ul style="list-style-type: none"> The accelerator pedal should move smoothly (without uneven pedal effort or catching).
Automatic transmission "Park" mechanism	<ul style="list-style-type: none"> When parked on a slope and the shift lever is in P, is the vehicle securely stopped?
Brake pedal	<ul style="list-style-type: none"> Does the brake pedal move smoothly? Does the brake pedal have appropriate clearance from the floor? (→P. 583) Does the brake pedal have the correct amount of free play? (→P. 583)
Brakes	<ul style="list-style-type: none"> The vehicle should not pull to one side when the brakes are applied. The brakes should work effectively. The brake pedal should not feel spongy. The brake pedal should not get too close to the floor when the brakes are applied.
Head restraints	<ul style="list-style-type: none"> Do the head restraints move smoothly and lock securely?
Indicators/buzzers	<ul style="list-style-type: none"> Do the indicators and buzzers function properly?
Lights	<ul style="list-style-type: none"> Do all the lights come on? Are the headlights aimed correctly? (→P. 512)
Parking brake	<ul style="list-style-type: none"> Does the parking brake pedal move smoothly? When parked on a slope and the parking brake is on, is the vehicle securely stopped?
Seat belts	<ul style="list-style-type: none"> Do the seat belts operate smoothly? The seat belts should not be damaged.
Seats	<ul style="list-style-type: none"> Do the seat controls operate properly?
Steering wheel	<ul style="list-style-type: none"> Does the steering wheel rotate smoothly? Does the steering wheel have the correct amount of free play? There should not be any strange sounds coming from the steering wheel.

Vehicle exterior

Items	Check points
Doors	<ul style="list-style-type: none"> • Do the doors operate smoothly?
Engine hood	<ul style="list-style-type: none"> • Does the engine hood lock system work properly?
Fluid leaks	<ul style="list-style-type: none"> • There should not be any signs of fluid leakage after the vehicle has been parked.
Tires	<ul style="list-style-type: none"> • Is the tire inflation pressure correct? • The tires should not be damaged or excessively worn. • Have the tires been rotated according to the maintenance schedule? • The wheel nuts should not be loose.
Windshield wipers/rear window wiper	<ul style="list-style-type: none"> • The wiper blades should not show any signs of cracking, splitting, wear, contamination or deformation. • The wiper blades should clear the windshield/rear window without streaking or skipping.



WARNING

■ If the engine is running

Turn off the engine and ensure that there is adequate ventilation before performing maintenance checks.

Emission inspection and maintenance (I/M) programs

Some states have vehicle emission inspection programs which include OBD (On Board Diagnostics) checks. The OBD system monitors the operation of the emission control system.

If the malfunction indicator lamp comes on

The OBD system determines that a problem exists somewhere in the emission control system. Your vehicle may not pass the I/M test and may need to be repaired. Contact your Lexus dealer to service the vehicle.

Your vehicle may not pass the I/M test in the following situations:

- When the battery is disconnected or discharged
Readiness codes that are set during ordinary driving are erased. Also, depending on your driving habits, the readiness codes may not be completely set.
- When the fuel tank cap is loose
The malfunction indicator lamp comes on indicating a temporary malfunction and your vehicle may not pass the I/M test.

When the malfunction indicator lamp still remains on after several driving trips

The error code in the OBD system will not be cleared unless the vehicle is driven 40 or more times.

If your vehicle does not pass the I/M test

Contact your Lexus dealer to prepare the vehicle for re-testing.

Do-it-yourself service precautions

If you perform maintenance yourself, be sure to follow the correct procedures as given in these sections.

Items	Parts and tools
Battery condition (→P. 484)	<ul style="list-style-type: none"> • Warm water • Baking soda • Grease • Conventional wrench (for terminal clamp bolts)
Brake fluid level (→P. 481)	<ul style="list-style-type: none"> • FMVSS No.116 DOT 3 or SAE J1703 brake fluid • Rag or paper towel • Funnel (used only for adding brake fluid)
Engine coolant level (→P. 479)	<ul style="list-style-type: none"> • “Toyota Super Long Life Coolant” or similar high quality ethylene glycol based non-silicate, non-amine, non-nitrite and non-borate coolant with long-life hybrid organic acid technology. For the U.S.A.: “Toyota Super Long Life Coolant” is pre-mixed with 50 % coolant and 50 % deionized water. For Canada: “Toyota Super Long Life Coolant” is pre-mixed with 55 % coolant and 45 % deionized water. • Funnel (used only for adding coolant)
Engine oil level (→P. 477)	<ul style="list-style-type: none"> • “Toyota Genuine Motor Oil” or equivalent • Rag or paper towel • Funnel (used only for adding engine oil)
Fuses (→P. 509)	<ul style="list-style-type: none"> • Fuse with same amperage rating as original

Items	Parts and tools
Headlight aim (→P. 512)	<ul style="list-style-type: none"> • Phillips-head screwdriver
Light bulbs (→P. 514)	<ul style="list-style-type: none"> • Bulb with same number and wattage rating as original • Phillips-head screwdriver • Flathead screwdriver • Wrench
Power steering fluid level (→P. 483)	<ul style="list-style-type: none"> • Automatic transmission fluid DEXRON® II or III • Rag or paper towel • Clean funnel
Radiator and condenser (→P. 481)	—
Tire inflation pressure (→P. 499)	<ul style="list-style-type: none"> • Tire pressure gauge • Compressed air source
Washer fluid (→P. 487)	<ul style="list-style-type: none"> • Water or washer fluid containing antifreeze (for winter use) • Funnel (used only for adding water or washer fluid)

 **WARNING**

The engine compartment contains many mechanisms and fluids that may move suddenly, become hot, or become electrically energized. To avoid death or serious injury, observe the following precautions:

■ When working on the engine compartment

- Keep hands, clothing and tools away from the moving fan and engine drive belt.
- Be careful not to touch the engine, radiator, exhaust manifold, etc. right after driving as they may be hot. Oil and other fluids may also be hot.
- Do not leave anything that may burn easily, such as paper or rags, in the engine compartment.
- Do not smoke, cause sparks or expose an open flame to fuel or the battery. Fuel and battery fumes are flammable.
- Be extremely cautious when working on the battery. It contains poisonous and corrosive sulfuric acid.

■ When working near the electric cooling fans or radiator grille

Be sure the engine switch is off. With the engine switch in IGNITION ON mode, the electric cooling fans may automatically start to run if the air conditioning is on and/or the coolant temperature is high. (→P. 481)

■ When working on or under the vehicle

Do not get under the vehicle with just the jack supporting it.
Always use automotive jack stands or other solid supports.

■ Safety glasses

Wear safety glasses to prevent flying or falling material, fluid spray, etc. from getting in your eyes.

 **NOTICE****■ If you remove the air cleaner filter**

Driving with the air cleaner filter removed may cause excessive engine wear due to dirt in the air.

Hood

Release the lock from the inside of the vehicle to open the hood.

- 1** Pull the hood lock release lever.
The hood will pop up slightly.

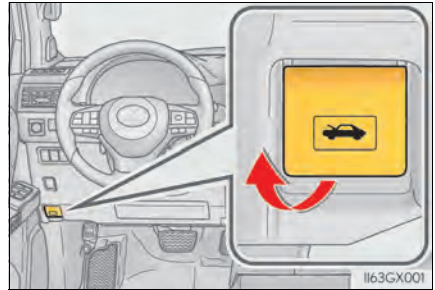

- 2** Move the auxiliary catch lever to side direction and lift the hood.

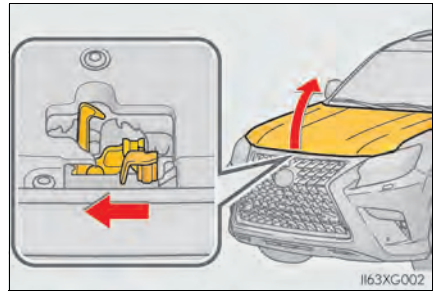

WARNING

■ Pre-driving check

Check that the hood is fully closed and locked.

If the hood is not locked properly, it may open while the vehicle is in motion and cause an accident, which may result in death or serious injury.

Engine compartment

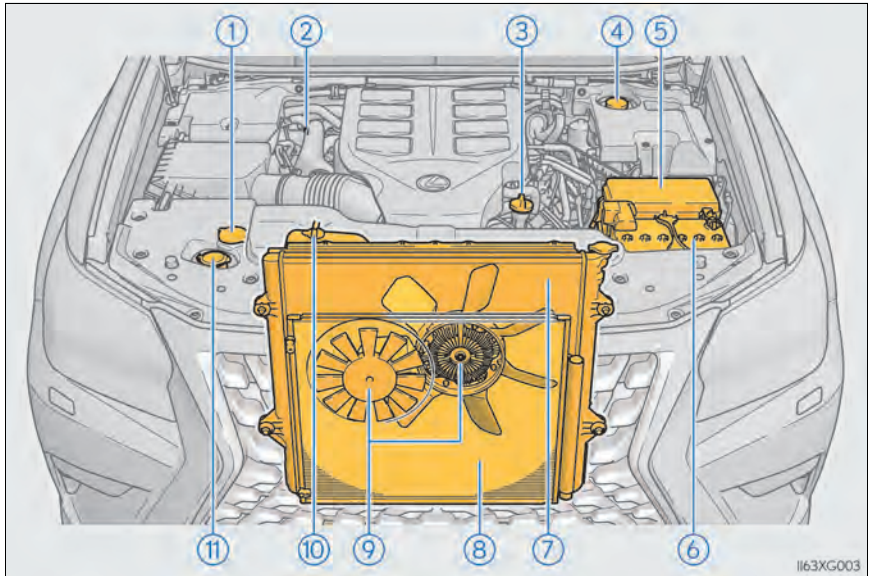

- | | |
|---|---|
| ① Power steering fluid reservoir
(→P. 483) | ⑥ Battery
(→P. 484) |
| ② Engine oil level dipstick
(→P. 477) | ⑦ Radiator
(→P. 481) |
| ③ Engine oil filler cap
(→P. 478) | ⑧ Condenser
(→P. 481) |
| ④ Brake fluid reservoir
(→P. 481) | ⑨ Cooling fans |
| ⑤ Fuse box
(→P. 509) | ⑩ Engine coolant reservoir
(→P. 479) |
| | ⑪ Washer fluid tank
(→P. 487) |

Engine compartment cover

■ Removing the engine compartment cover

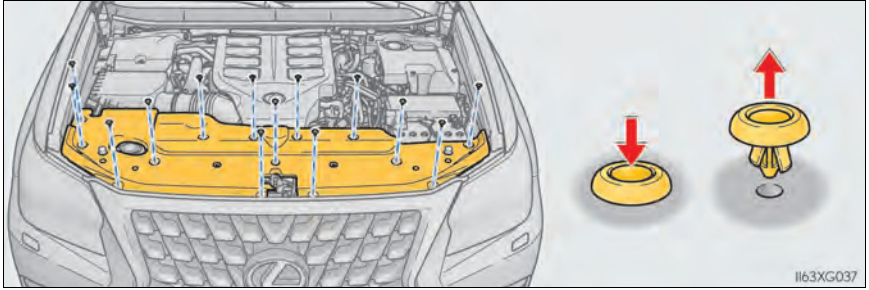

■ Installing the clips

- ① Push up center portion
- ② Insert
- ③ Press

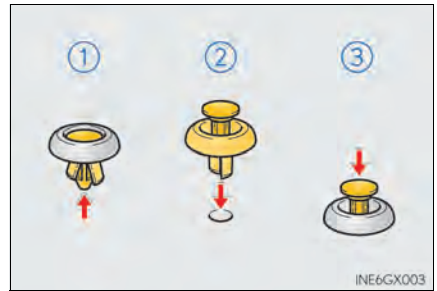

NOTICE

■ After installing an engine compartment cover

Make sure the cover is securely installed in its original position.

Engine oil

With the engine at operating temperature and turned off, check the oil level on the dipstick.

■ Checking the engine oil

- 1 Park the vehicle on level ground. After warming up the engine and turning it off, wait more than 5 minutes for the oil to drain back into the bottom of the engine.
- 2 Holding a rag under the end, pull the dipstick out.

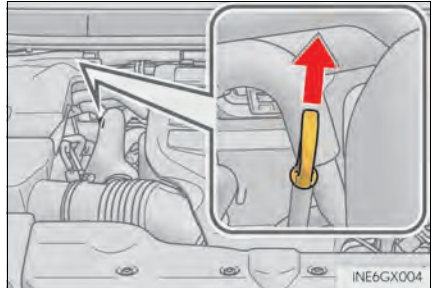

- 3 Wipe the dipstick clean.
- 4 Reinsert the dipstick fully.
- 5 Holding a rag under the end, pull the dipstick out and check the oil level.

- ① Low
- ② Normal
- ③ Excessive

The shape of the dipstick may differ depending on the type of vehicle or engine.

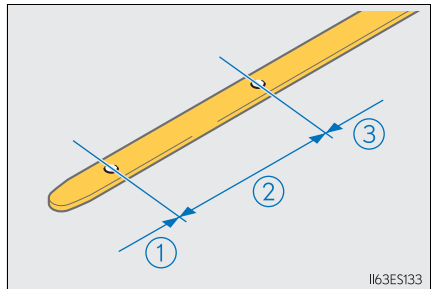

- 6 Wipe the dipstick and reinsert it fully.

■ Adding engine oil

If the oil level is below or near the low level mark, add engine oil of the same type as already in the engine.

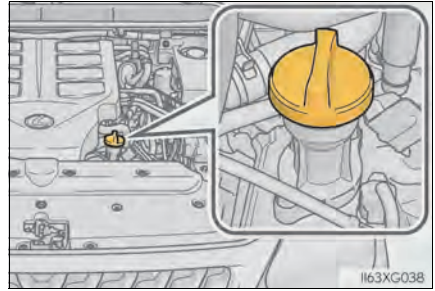

Make sure to check the oil type and prepare the items needed before adding oil.

Engine oil selection	→P. 578
Oil quantity (Low → Full)	1.6 qt. (1.5 L, 1.3 Imp.qt.)
Items	Clean funnel

- 1 Remove the oil filler cap by turning it counter-clockwise.
- 2 Add engine oil slowly, checking the dipstick.
- 3 Install the oil filler cap by turning it clockwise.





■ Engine oil consumption

A certain amount of engine oil will be consumed while driving. In the following situations, oil consumption may increase, and engine oil may need to be refilled in between oil maintenance intervals.

- When the engine is new, for example directly after purchasing the vehicle or after replacing the engine
- If low quality oil or oil of an inappropriate viscosity is used
- When driving at high engine speeds or with a heavy load, when towing, or when driving while accelerating or decelerating frequently
- When leaving the engine idling for a long time, or when driving frequently through heavy traffic

■ After changing the engine oil

The engine oil maintenance data should be reset. Perform the following procedures:

- 1 Press **<** or **>** of the meter control switches and select  on the multi-information display.
- 2 Press **▲** or **▼** of the meter control switches and select “Vehicle Settings”, and then press .
- 3 Press **▲** or **▼** of the meter control switches and select “Oil Maintenance”, and then press .
- 4 Select the “Yes” and press .

“Reset Complete” will be displayed when the reset procedure has been completed.

⚠ WARNING

■ Used engine oil

- Used engine oil contains potentially harmful contaminants which may cause skin disorders such as inflammation or skin cancer, so care should be taken to avoid prolonged and repeated contact. To remove used engine oil from your skin, wash thoroughly with soap and water.
- Dispose of used oil and filters only in a safe and acceptable manner. Do not dispose of used oil and filters in household trash, in sewers or onto the ground. Call your Lexus dealer, service station or auto parts store for information concerning recycling or disposal.
- Do not leave used engine oil within the reach of children.

⚠ NOTICE

■ To prevent serious engine damage

Check the oil level on regular basis.

■ When replacing the engine oil

- Be careful not to spill engine oil on the vehicle components.
- Avoid overfilling, or the engine could be damaged.
- Check the oil level on the dipstick every time you refill the vehicle.
- Be sure the engine oil filler cap is properly tightened.

Engine coolant

The coolant level is satisfactory if it is between the “F” and “L” lines on the reservoir when the engine is cold.

- ① Reservoir cap
- ② “F”
- ③ “L”

If the level is on or below the “L” line, add coolant up to the “F” line.

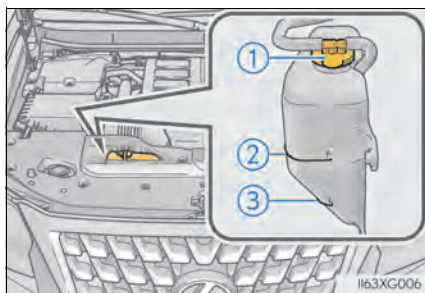

■ Coolant selection

Only use "Toyota Super Long Life Coolant" or a similar high quality ethylene glycol based non-silicate, non-amine, non-nitrite, and non-borate coolant with long-life hybrid organic acid technology.

U.S.A.: "Toyota Super Long Life Coolant" is a mixture of 50 % coolant and 50 % deionized water. (Minimum temperature: -31°F [-35°C])

Canada: "Toyota Super Long Life Coolant" is a mixture of 55 % coolant and 45 % deionized water. (Minimum temperature: -44°F [-42°C])

For more details about engine coolant, contact your Lexus dealer.

■ If the coolant level drops within a short time of replenishing

Visually check the radiator, hoses, engine coolant reservoir cap, radiator cap, drain cock and water pump. If you cannot find a leak, have your Lexus dealer test the cap and check for leaks in the cooling system.



WARNING

■ When the engine is hot

Do not remove the radiator cap.

The cooling system may be under pressure and may spray hot coolant if the cap is removed, causing serious injuries, such as burns.



NOTICE

■ When adding coolant

Coolant is neither plain water nor straight antifreeze. The correct mixture of water and antifreeze must be used to provide proper lubrication, corrosion protection and cooling. Be sure to read the antifreeze or coolant label.

■ If you spill coolant

Be sure to wash it off with water to prevent it from damage to parts or paint.

Radiator and condenser

Check the radiator and condenser and clear any foreign objects.

If either of the above parts is extremely dirty or you are not sure of their condition, have your vehicle checked by your Lexus dealer.

WARNING

■ When the engine is hot

Do not touch the radiator or condenser as they may be hot and cause serious injuries, such as burns.

Brake fluid

■ Checking fluid level

The brake fluid level should be between the “MAX” and “MIN” lines on the tank.

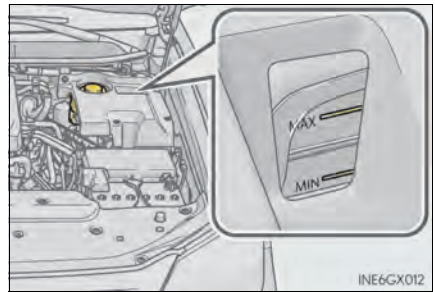

■ Adding fluid

Make sure to check the fluid type and prepare the necessary item.

Fluid type	FMVSS No.116 DOT 3 or SAE J1703 brake fluid
Items	Clean funnel

■ **Brake fluid can absorb moisture from the air**

Excess moisture in the fluid can cause a dangerous loss of braking efficiency. Use only newly opened brake fluid.



WARNING

■ **When filling the reservoir**

Take care because brake fluid can harm your hands or eyes and damage painted surfaces. If fluid gets on your eyes, flush the affected area with clean water immediately. If you still experience discomfort, see a doctor.



NOTICE

■ **If the fluid level is low or high**

It is normal for the brake fluid level to go down slightly as the brake pads wear or when the fluid level in the accumulator is high. If the reservoir needs frequent refilling, it may indicate a serious problem.

Power steering fluid

■ Fluid level

The fluid level should be within the appropriate range.

- ① Full (when cold)
- ② Add fluid (when cold)
- ③ Full (when hot)
- ④ Add fluid (when hot)

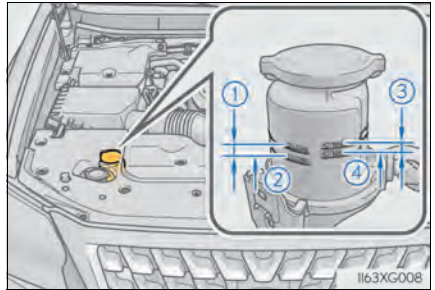

Hot: The vehicles has been driven around 50 mph (80 km/h) for 20 minutes, or slightly longer in frigid temperatures.
(Fluid temperature, 140°F - 175°F [60°C - 80°C]).

Cold: The engine has not been run for about 5 hours.
(Room temperature, 50°F - 85°F [10°C - 30°C]).

■ Checking the fluid level

Make sure to check the fluid type and prepare the necessary items.

Fluid type	Automatic transmission fluid DEXRON® II or III
Items	Rag or paper, clean funnel (only for adding fluid)

- 1 Clean all dirt off the reservoir.
- 2 Remove the cap by turning it counterclockwise.
- 3 Wipe the dipstick clean.
- 4 Reinstall the cap and remove it again.
- 5 Check the fluid level.

⚠ WARNING**■ When checking the reservoir**

Take care as the reservoir may be hot.

⚠ NOTICE**■ When adding fluid**

Avoid overfilling, or the power steering may be damaged.

■ After replacing the reservoir cap

Check the steering box case, vane pump and hose connections for leaks or damage.

Battery

Check the battery as follows.

■ Battery exterior

Make sure that the battery terminals are not corroded and that there are no loose connections, cracks, or loose clamps.

- ① Terminals
- ② Hold-down clamp

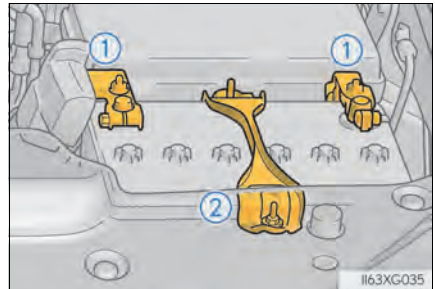

■ Before recharging

When recharging, the battery produces hydrogen gas which is flammable and explosive. Therefore, observe the following before recharging:

- If recharging with the battery installed on the vehicle, be sure to disconnect the ground cable.
- Make sure the power switch on the charger is off when connecting and disconnecting the charger cables to the battery.

■ After recharging/reconnecting the battery

The engine may not start. Follow the procedure below to initialize the system.

- 1 Shift the shift lever to P
 - 2 Open and close any of the doors.
 - 3 Restart the engine.
- Unlocking the doors using the smart access system with push-button start may not be possible immediately after reconnecting the battery. If this happens, use the wireless remote control or the mechanical key to lock/unlock the doors.
 - Start the engine with the engine switch in ACCESSORY mode. The engine may not start with the engine switch turned off. However, the engine will operate normally from the second attempt.
 - The engine switch mode is recorded by the vehicle. If the battery is reconnected, the vehicle will return the engine switch mode to the status it was in before the battery was disconnected. Make sure to turn off the engine before disconnect the battery. Take extra care when connecting the battery if the engine switch mode prior to discharge is unknown.

If the system will not start even after multiple attempts, contact your Lexus dealer.



WARNING

■ Chemicals in the battery

Batteries contain poisonous and corrosive sulfuric acid and may produce hydrogen gas which is flammable and explosive. To reduce the risk of death or serious injury, take the following precautions while working on or near battery:

- Do not cause sparks by touching the battery terminals with tools.
- Do not smoke or light a match near the battery.
- Avoid contact with eyes, skin and clothes.
- Never inhale or swallow electrolyte.
- Wear protective safety glasses when working near the battery.
- Keep children away from the battery.

■ Where to safely charge the battery

Always charge the battery in an open area. Do not charge the battery in a garage or closed room where there is not sufficient ventilation.

**WARNING****■ How to recharge the battery**

Only perform a slow charge (5A or less). The battery may explode if charged at a quicker rate.

■ Emergency measures regarding electrolyte**● If electrolyte gets in your eyes**

Flush your eyes with clean water for at least 15 minutes and get immediate medical attention. If possible, continue to apply water with a sponge or cloth while traveling to the nearest medical facility.

● If electrolyte gets on your skin

Wash the affected area thoroughly. If you feel pain or burning, get medical attention immediately.

● If electrolyte gets on your clothes

It can soak through clothing on to your skin. Immediately take off the clothing and follow the procedure above if necessary.

● If you accidentally swallow electrolyte

Drink a large quantity of water or milk. Get emergency medical attention immediately.

**NOTICE****■ When recharging the battery**

Never recharge the battery while the engine is running. Also, be sure all accessories are turned off.

Washer fluid

If any washer does not work or “Windshield Washer Fluid Low” appears on the multi-information display, the washer tank may be empty. Add washer fluid.

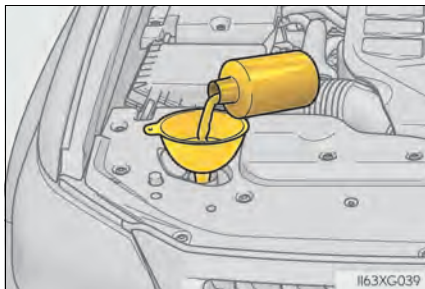

WARNING

■ When adding washer fluid

Do not add washer fluid when the engine is hot or running as washer fluid contains alcohol and may catch fire if spilled on the engine etc.

NOTICE

■ Do not use any fluid other than washer fluid

Do not use soapy water or engine antifreeze instead of washer fluid.

Doing so may cause streaking on the vehicle's painted surfaces, as well as damaging the pump leading to problems of the washer fluid not spraying.

■ Diluting washer fluid

Dilute washer fluid with water as necessary.

Refer to the freezing temperatures listed on the label of the washer fluid bottle.

Tires

Replace or rotate tires in accordance with maintenance schedules and treadwear.

Checking tires

Check if the treadwear indicators are showing on the tires. Also check the tires for uneven wear, such as excessive wear on one side of the tread.

Check the spare tire condition and pressure if not rotated.

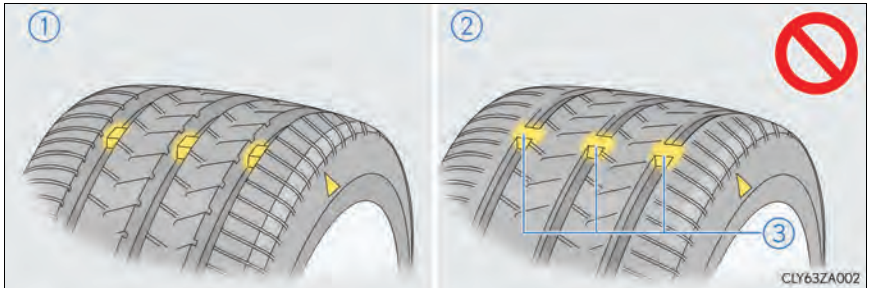

- ① New tread
- ② Worn tread
- ③ Treadwear indicator

The location of treadwear indicators is shown by a "TWI" or "△" mark, etc., molded into the sidewall of each tire.

Replace the tires if the treadwear indicators are showing on a tire.

Tire rotation

Rotate the tires in the order shown.

To equalize tire wear and extend tire life, Lexus recommends that tire rotation is carried out at the same interval as tire inspection.

Do not fail to initialize the tire pressure warning system after tire rotation.

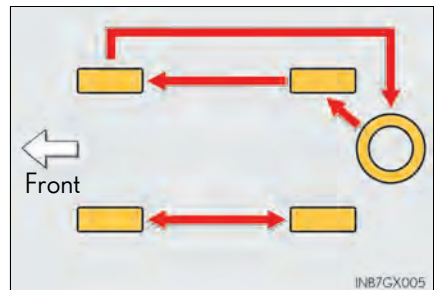

Tire pressure warning system

Your vehicle is equipped with a tire pressure warning system that uses tire pressure warning valves and transmitters to detect low tire inflation pressure before serious problems arise.

- If the tire pressure drops below a predetermined level, the driver is warned by a screen display and a warning light. (→P. 537)
- The tire pressure detected by the tire pressure warning system can be displayed on the multi-information display. (→P. 91)

The illustration used is intended as an example, and may differ from the image that is actually displayed on the multi-information display.

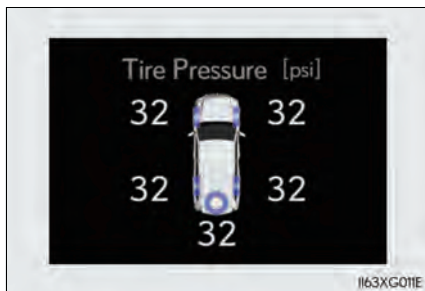

◆ Installing tire pressure warning valves and transmitters

When replacing tires or wheels, tire pressure warning valves and transmitters must also be installed.

When new tire pressure warning valves and transmitters are installed, new ID codes must be registered in the tire pressure warning computer and the tire pressure warning system must be initialized. (→P. 491)

◆ Initializing the tire pressure warning system

- **The tire pressure warning system must be initialized in the following circumstances:**
 - When changing the tire size.
 - When rotating the tires.
 - When the tire inflation pressure is changed such as when changing traveling speed or load weight.
 - After registering the ID codes. (→P. 491)

When the tire pressure warning system is initialized, the current tire inflation pressure is set as the benchmark pressure.

■ How to initialize the tire pressure warning system



- 1 Park the vehicle in a safe place and stop the engine for 20 minutes or more.



Initialization cannot be performed while the vehicle is moving.



- 2 Adjust the tire inflation pressure to the specified cold tire inflation pressure level. (→P. 584)



Make sure to adjust the tire pressure to the specified cold tire inflation pressure level. The tire pressure warning system will operate based on this pressure level.

- 3 Start the engine. (→P. 200)

- 4 Press  or  of the meter control switches and select .

- 5 Press  or  of the meter control switches and select "Vehicle Settings", and then press .

- 6 Press  or  of the meter control switches and select "TPWS", and then press .

- 7 Press  or  of the meter control switches and select "Set Pressure", and then press and hold  until the tire pressure warning light starts blinking.

A message is displayed on the multi-information display. Also, "--" is displayed for inflation pressure of each tire on the multi-information display while the tire pressure warning system determines the position.



- 8 Drive at approximately 25 mph (40 km/h) or more for approximately 10 to 30 minutes.

When initialization is complete, the inflation pressure of each tire will be displayed on the multi-information display.





Even if the vehicle is not driven at approximately 25 mph (40 km/h) or more, initialization can be completed by driving for a long time. However, if initialization does not complete after driving for 1 hour or more, park the vehicle in a safe place for approximately 20 minutes and then drive the vehicle again.

◆ Registering ID codes

Every tire pressure warning valve and transmitter has a unique ID code.

When replacing a tire pressure warning valve and transmitter, it is necessary to register the ID code.

When registering the ID codes, perform the following procedure.

- 1 Park the vehicle in a safe place, wait for approximately 20 minutes, and then start the engine. (→P. 200)
- 2 Press **<** or **>** of the meter control switches and select .
- 3 Press **^** or **v** of the meter control switches and select “Vehicle Settings”, and then press .
- 4 Press **^** or **v** of the meter control switches and select “TPWS”, and then press .
- 5 Press **^** or **v** of the meter control switches and select “Change Wheel Set”, and then press and hold  until the tire pressure warning light starts slowly blinking 3 times.

Then a message will be displayed on the multi-information display.



When registration is being performed, the tire pressure warning light will blink for approximately 1 minute then illuminate and “--” will be displayed for the inflation pressure of each tire on the multi-information display.

- 6 Drive at approximately 25 mph (40 km/h) or more for approximately 10 to 30 minutes.

Registration is complete when the tire pressure warning light turns off and the inflation pressure of each tire is displayed on the multi-information display.

Even if the vehicle is not driven at approximately 25 mph (40 km/h) or more, registration can be completed by driving for a long time. However, if registration does not complete after driving for 1 hour or more, perform the procedure again from the beginning.

- 7 Initialize the tire pressure warning system. (→P. 490)

■ When to replace your vehicle's tires

Tires should be replaced if:

- The treadwear indicators are showing on a tire.
- You have tire damage such as cuts, splits, cracks deep enough to expose the fabric, and bulges indicating internal damage
- A tire goes flat repeatedly or cannot be properly repaired due to the size or location of a cut or other damage

If you are not sure, consult with your Lexus dealer.

■ Replacing tires and wheels

If the ID code of the tire pressure warning valve and transmitter is not registered, the tire pressure warning system will not work properly. After driving for about 20 minutes, the tire pressure warning light blinks for 1 minute and stays on to indicate a system malfunction.

■ Tire life

Any tire over 6 years old must be checked by a qualified technician even if it has seldom or never been used or damage is not obvious.

■ Routine tire inflation pressure checks

The tire pressure warning system does not replace routine tire inflation pressure checks. Make sure to check tire inflation pressure as part of your routine of daily vehicle checks.

■ Maximum load of tire

Check that the number given by dividing the maximum load by 1.10 of the replacement tire is greater than 1/2 of the Gross Axle Weight Ratings (GAWR) of either the front axle or the rear axle, whichever is greater.

For the GAWR, see the Certification Label. For the maximum load of the tire, see the load limit at maximum cold tire inflation pressure mentioned on the sidewall of the tire. (→P. 589)

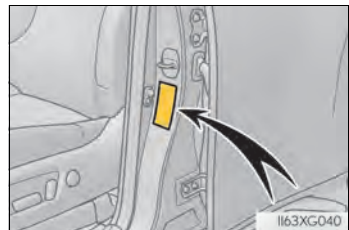

■ Tire types

● Summer tires

Summer tires are high-speed performance tires best suited to highway driving under dry conditions. Since summer tires do not have the same traction performance as snow tires, summer tires are inadequate for driving on snow-covered or icy roads. For driving on snow-covered roads or icy roads, the use of snow tires is recommended. When installing snow tires, be sure to replace all four tires.

● All season tires

All season tires are designed to provide better traction in snow and to be adequate for driving in most winter conditions as well as for use year-round. All season tires, however, do not have adequate traction performance compared with snow tires in heavy or loose snow. Also, all season tires fall short in acceleration and handling performance compared with summer tires in highway driving.

● Snow tires

For driving on snow-covered roads or icy roads, we recommend using snow tires. If you need snow tires, select tires of the same size, construction and load capacity as the originally installed tires. Since your vehicle has radial tires as original equipment, make sure your snow tires also have radial construction. Do not install studded tires without first checking local regulations for possible restrictions. Snow tires should be installed on all wheels. (→P. 387)

■ If the tread on snow tires wears down below 0.16 in. (4 mm)

The effectiveness of the tires as snow tires is lost.

■ Situations in which the tire pressure warning system may not operate properly

- In the following cases, the tire pressure warning system may not operate properly.
 - If non-genuine Lexus wheels are used.
 - A tire has been replaced with a tire that is not an OE (Original Equipment) tire.
 - A tire has been replaced with a tire that is not of the specified size.
 - Tire chains etc. are equipped.
 - An auxiliary-supported run-flat tire is equipped.
 - If a window tint that affects the radio wave signals is installed.
 - If there is a lot of snow or ice on the vehicle, particularly around the wheels or wheel housings.
 - If the tire inflation pressure is extremely higher than the specified level.
 - If the spare tire is in a location subject to poor radio wave signal reception.
 - If a large metallic object which can interfere with signal reception is put near the spare tire.
 - If tires not equipped with the tire pressure warning valves and transmitters are used.
 - If the ID code on the tire pressure warning valves and transmitters is not registered in the tire pressure warning computer.
- Performance may be affected in the following situations.
 - Near a TV tower, electric power plant, gas station, radio station, large display, airport or other facility that generates strong radio waves or electrical noise
 - When carrying a portable radio, cellular phone, cordless phone or other wireless communication device

If tire position information is not correctly displayed due to the radio wave conditions, the display may be corrected by driving and changing the radio wave conditions.
- When the vehicle is parked, the time taken for the warning to start or go off could be extended.
- When tire inflation pressure declines rapidly for example when a tire has burst, the warning may not function.

■ The initialization operation

- Make sure to carry out initialization after adjusting the tire inflation pressure. Also, make sure the tires are cold before carrying out initialization or tire inflation pressure adjustment.
- If you have accidentally turned the engine switch off during initialization, it is not necessary to manually restart the initialization again, as initialization will restart automatically the next time the engine switch is turned to IGNITION ON mode.
- If you accidentally perform initialization when initialization is not necessary, adjust the tire inflation pressure to the specified level when the tires are cold, and conduct initialization again.
- While the position of each tire is being determined and the inflation pressures are not being displayed on the multi-information display, if the inflation pressure of a tire drops, the tire pressure warning light will come on.

■ Warning performance of the tire pressure warning system

The warning of the tire pressure warning system will change in accordance with the conditions under which it was initialized. For this reason, the system may give a warning even if the tire pressure does not reach a low enough level, or if the pressure is higher than the pressure that was adjusted to when the system was initialized.

■ When initialization of the tire pressure warning system has failed

- Do not move the vehicle backward during initialization. Initialization is started again from the beginning and it may take longer than usual.
- Initialization may take longer to complete if the vehicle is driven on an unpaved road. When performing initialization, drive on a paved road if possible. Depending on the driving environment and condition of the tires, initialization will be completed in approximately 10 to 30 minutes.
 - If initialization is not complete after driving approximately 30 minutes, continue driving for a while.
 - If initialization is not complete after driving approximately 1 hour, park the vehicle in a safe place for approximately 20 minutes. Then drive straight (with occasional left and right turns) at approximately 25 mph (40 km/h) or more* for approximately 10 to 30 minutes.

If initialization is still not complete, have the vehicle inspected by your Lexus dealer.

*: Except when making a left/right turn

- In the following situations, the tire inflation pressure will not be recorded and the system will not operate properly. Perform initialization again.
 - If, when attempting to start initialization, the tire pressure warning light does not blink 3 times.
 - If, when the vehicle has been driven for about 20 minutes after performing initialization, the tire pressure warning light blinks for approximately 1 minute and then illuminates.

■ When registering ID codes

- ID code registration is performed while driving at a vehicle speed of approximately 25 mph (40 km/h) or more.
- Before performing ID code registration, make sure that no wheels with tire pressure warning valve and transmitters installed are near the vehicle.
- Initialize the tire pressure warning system after ID code registration. Initialization is disabled if the system was initialized before registration.
- After ID code registration, the tires are hot by driving. Initialize the tire pressure warning system after the tires become cold.
- ID codes can be registered by yourself, but depending on the driving conditions and driving environment, registration may take some time to complete.

■ Canceling the change wheel set mode

- If turning the engine switch off when in the change wheel set mode before driving, the change wheel set mode is canceled.
- After driving when in the change wheel set mode, the change wheel set mode cannot be canceled. To cancel the mode, perform the procedure for ID code registration again and turn the engine switch off before driving.
- If the change wheel set mode is canceled, the ID codes that have already been registered are communicated. When communication is finished, the tire pressure warning light will turn off.

■ When ID code registration has failed

- Registration may take long time or the ID codes may not be registered in the following situations.
 - When the vehicle is moved backward during registration.
Registration is started again from the beginning and it may take longer than usual.
 - When another vehicle is running the side of the vehicle such as in heavy traffic.
It may take longer to detect the vehicle's tire pressure warning valves and transmitters.
 - If tire pressure warning valves and transmitters are in the vehicle.
The ID codes may not be registered.
- When performing registration, drive on a paved road if possible. Depending on the driving environment and condition of the tires, registration will be completed in approximately 10 to 30 minutes.
 - If registration is not complete after driving approximately 30 minutes, continue driving for a while.
 - If registration is not complete after driving approximately 1 hour, park the vehicle in a safe place for approximately 20 minutes. Then drive straight* (with occasional left and right turns) at approximately 25 mph (40 km/h) or more* for approximately 10 to 30 minutes.

If registration is still not complete, have the vehicle inspected by your Lexus dealer.

*: Except when making a left/right turn

- When the tire pressure warning light does not blink slowly 3 times, the ID code will not be registered and the system will not operate properly. Perform registration again.

**WARNING****■ Tire pressure warning system operation**

The tire pressure warning system may not provide warning immediately if a tire bursts or if sudden air leakage occurs.

■ When inspecting or replacing tires

Observe the following precautions to prevent accidents. Failure to do so may cause damage to parts of the drive train as well as dangerous handling characteristics, which may lead to an accident resulting in death or serious injury.

- Do not mix tires of different makes, models or tread patterns.
Also, do not mix tires of remarkably different treadwear.
- Do not use tire sizes other than those recommended by Lexus.
- Do not mix differently constructed tires (radial, bias-belted or bias-ply tires).
- Do not mix summer, all season and snow tires.
- Do not use tires that have been used on another vehicle.
Do not use tires if you do not know how they were used previously.

■ When initializing the tire pressure warning system

Do not initialize tire inflation pressure without first adjusting the tire inflation pressure to the specified level. Otherwise, the tire pressure warning light may not come on even if the tire inflation pressure is low, or it may come on when the tire inflation pressure is actually normal.



NOTICE

■ Repairing or replacing tires, wheels, tire pressure warning valves, transmitters and tire valve caps

- When removing or fitting the wheels, tires or the tire pressure warning valves and transmitters, contact your Lexus dealer as the tire pressure warning valves and transmitters may be damaged if not handled correctly.
- Make sure to install the tire valve caps. If the tire valve caps are not installed, water could enter the tire pressure warning valves and the tire pressure warning valves could be bound.
- When replacing tire valve caps, do not use tire valve caps other than those specified. The cap may become stuck.

■ To avoid damage to the tire pressure warning valves and transmitters

When a tire is repaired with liquid sealants, the tire pressure warning valve and transmitter may not operate properly. If a liquid sealant is used, contact your Lexus dealer or other qualified service shop as soon as possible. Make sure to replace the tire pressure warning valve and transmitter when replacing the tire. (→P. 489)

■ Driving on rough roads

Take particular care when driving on roads with loose surfaces or potholes. These conditions may cause losses in tire inflation pressure, reducing the cushioning ability of the tires. In addition, driving on rough roads may cause damage to the tires themselves, as well as the vehicle's wheels and body.

■ If tire inflation pressure of each tire becomes low while driving

Do not continue driving, or your tires and/or wheels may be ruined.

Tire inflation pressure

Tire inflation pressure

The recommended cold tire inflation pressure and tire size are displayed on the tire and loading information label.
(→P. 584)

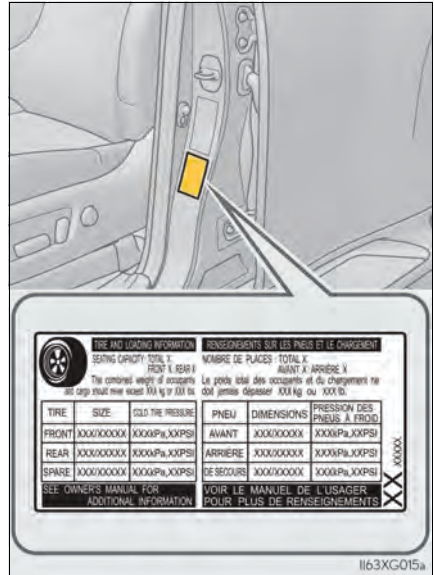

Inspection and adjustment procedure

- ① Tire valve
- ② Tire pressure gauge

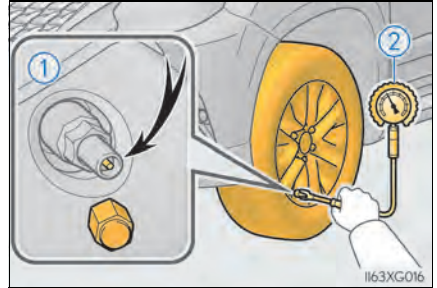

- ① Remove the tire valve cap.
- ② Press the tip of the tire pressure gauge onto the tire valve.
- ③ Read the pressure using the gauge gradations.
- ④ If the tire inflation pressure is not at the recommended level, adjust the pressure.
If you add too much air, press the center of the valve to deflate.
- ⑤ After completing the tire inflation pressure measurement and adjustment, apply soapy water to the valve and check for leakage.
- ⑥ Put the tire valve cap back on.

■ Tire inflation pressure check interval

You should check tire inflation pressure every two weeks, or at least once a month. Do not forget to check the spare.

■ Effects of incorrect tire inflation pressure

Driving with incorrect tire inflation pressure may result in the following:

- Reduced fuel economy
- Reduced driving comfort and poor handling
- Reduced tire life due to wear
- Reduced safety
- Damage to the drive train

If a tire needs frequent inflating, have it checked by your Lexus dealer.

■ Instructions for checking tire inflation pressure

When checking tire inflation pressure, observe the following:

- Check only when the tires are cold.
If your vehicle has been parked for at least 3 hours and has not been driven for more than 1 mile or 1.5 km, you will get an accurate cold tire inflation pressure reading.
- Always use a tire pressure gauge.
It is difficult to judge if a tire is properly inflated based only on its appearance.
- It is normal for the tire inflation pressure to be higher after driving as heat is generated in the tire. Do not reduce tire inflation pressure after driving.
- Never exceed the vehicle capacity weight.
Passengers and luggage weight should be placed so that the vehicle is balanced.

**WARNING****■ Proper inflation is critical to save tire performance**

Keep your tires properly inflated.

If the tires are not properly inflated, the following conditions may occur which could lead to an accident resulting in death or serious injury:

- Excessive wear
- Uneven wear
- Poor handling
- Possibility of blowouts resulting from overheated tires
- Air leaking from between tire and wheel
- Wheel deformation and/or tire damage
- Greater possibility of tire damage while driving (due to road hazards, expansion joints, sharp edges in the road, etc.)

**NOTICE****■ When inspecting and adjusting tire inflation pressure**

Be sure to put the tire valve caps back on.

If a valve cap is not installed, dirt or moisture may get into the valve and cause an air leak, resulting in decreased tire inflation pressure.

Wheels

If a wheel is bent, cracked or heavily corroded, it should be replaced. Otherwise, the tire may separate from the wheel or cause loss of handling control.

Wheel selection

When replacing wheels, care should be taken to ensure that they are equivalent to those removed in load capacity, diameter, rim width, and inset*.

Replacement wheels are available at your Lexus dealer.

*: Conventionally referred to as "offset".

Lexus does not recommend using the following:

- Wheels of different sizes or types
- Used wheels
- Bent wheels that have been straightened

Aluminum wheel precautions

- Use only Lexus wheel nuts and wrenches designed for use with your aluminum wheels.
- When rotating, repairing or changing your tires, check that the wheel nuts are still tight after driving 1000 miles (1600 km).
- Be careful not to damage the aluminum wheels when using tire chains.
- Use only Lexus genuine balance weights or equivalent and a plastic or rubber hammer when balancing your wheels.

■ When replacing wheels

The wheels of your vehicle are equipped with tire pressure warning valves and transmitters that allow the tire pressure warning system to provide advance warning in the event of a loss in tire inflation pressure. Whenever wheels are replaced, tire pressure warning valves and transmitters must be installed. (→P. 489)

**WARNING****■ When replacing wheels**

- Do not use wheels that are a different size from those recommended in the Owner's Manual, as this may result in a loss of handling control.
- Never use an inner tube in a leaking wheel which is designed for a tubeless tire. Doing so may result in an accident, causing death or serious injury.

■ Use of defective wheels prohibited

Do not use cracked or deformed wheels.
Doing so could cause the tire to leak air during driving, possibly causing an accident.

**NOTICE****■ Replacing tire pressure warning valves and transmitters**

- Because tire repair or replacement may affect the tire pressure warning valves and transmitters, make sure to have tires serviced by your Lexus dealer or other qualified service shop. In addition, make sure to purchase your tire pressure warning valves and transmitters at your Lexus dealer.
- Ensure that only genuine Lexus wheels are used on your vehicle.
Tire pressure warning valves and transmitters may not work properly with non-genuine wheels.

Air conditioning filter

The air conditioning filter must be changed regularly to maintain air conditioning efficiency.

Removal method

- 1 Turn the engine switch off.
- 2 Open the glove box and remove the glove box cover.
- 3 Remove the filter cover.

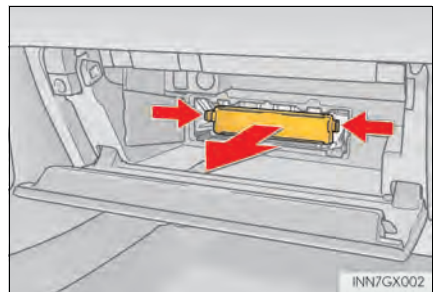
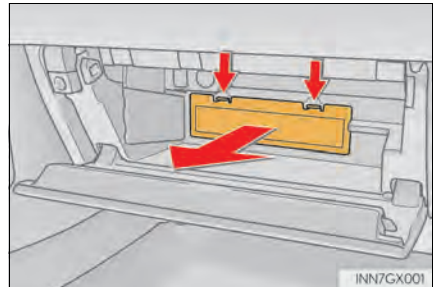

- 4 Slide and pull out the filter. Replace the filter with a new one.
The “↑UP” marks shown on the filter should be pointing up.

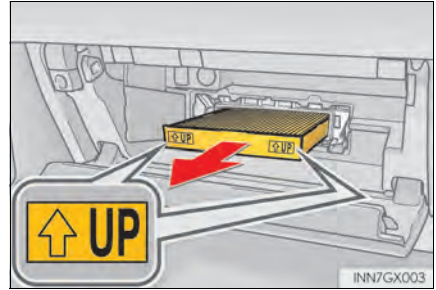

■ Changing interval

Inspect and replace the air conditioning filter according to the maintenance schedule. In dusty areas or areas with heavy traffic flow, early replacement may be required. (For scheduled maintenance information, please refer to the “Owner’s Manual Supplement” or “Scheduled Maintenance”.)

■ If air flow from the vents decreases dramatically

The filter may be clogged. Check the filter and replace if necessary.



NOTICE

■ When using the air conditioning system

Make sure that a filter is always installed.

Using the air conditioning system without a filter may cause damage to the system.

Electronic key battery

Replace the battery with a new one if it is depleted.

You will need the following items:

- Flathead screwdriver
- Small flathead screwdriver
- Lithium battery CR2032

Replacing the battery

- 1 Take out the mechanical key.

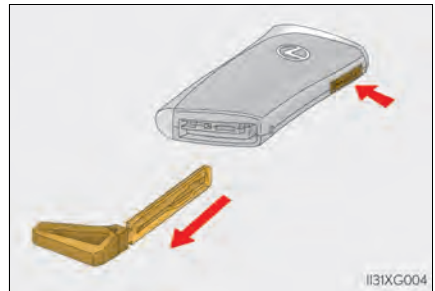

- 2 Remove the cover.
To prevent damage to the key, cover the tip of the screwdriver with tape.

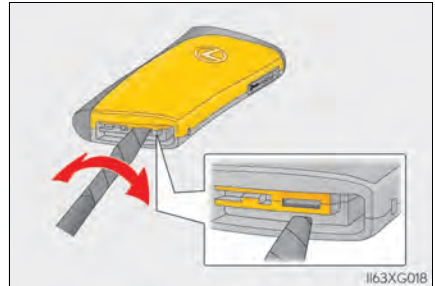

- 3 Remove the depleted battery.
Insert a new battery with the "+" terminal facing up.

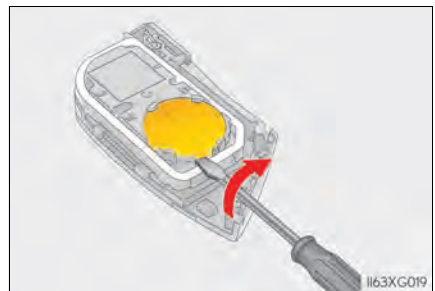

■ Use a CR2032 lithium battery

- Batteries can be purchased at your Lexus dealer, local electrical appliance shops or camera stores.
- Replace only with the same or equivalent type recommended by the manufacturer.
- Dispose of used batteries according to the local laws.

■ If the electronic key battery is depleted

The following symptoms may occur:

- The smart access system with push-button start and wireless remote control will not function properly.
- The operational range will be reduced.

**WARNING****■ Battery precautions**

Observe the following precautions.

Failure to do so may result in death or serious injury.

- Do not swallow the battery. Doing so may cause chemical burns.
 - A coin battery or button battery is used in the electronic key. If a battery is swallowed, it may cause severe chemical burns in as little as 2 hours and may result in death or serious injury.
 - Keep away new and removed batteries from children.
 - If the cover cannot be firmly closed, stop using the electronic key and stow the key in the place where children cannot reach, and then contact your Lexus dealer.
 - If you accidentally swallow a battery or put a battery into a part of your body, get emergency medical attention immediately.
- To prevent battery explosion or leakage of flammable liquid or gas**
- Replace the battery with a new battery of the same type. If a wrong type of battery is used, it may explode.
 - Do not expose batteries to extremely low pressure due to high altitude or extremely high temperatures.
 - Do not burn, break or cut a battery.

**NOTICE****■ For normal operation after replacing the battery**

Observe the following precautions to prevent accidents:

- Always work with dry hands.
Moisture may cause the battery to rust.
- Do not touch or move any other component inside the remote control.
- Do not bend either of the battery terminals.

Checking and replacing fuses

If any of the electrical components do not operate, a fuse may have blown. If this happens, check and replace the fuses as necessary.

- 1 Turn the engine switch off.
- 2 Open the fuse box cover.

► Engine compartment

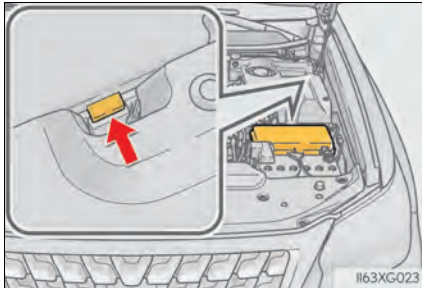

Push the tab in and lift the lid off.

► Driver's side instrument panel

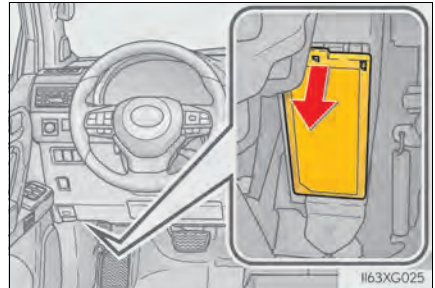

Remove the lid.

- 3 Remove the fuse with the pull-out tool.
Only type A fuse can be removed using the pull-out tool.



4 Check if the fuse is blown.

- ① Normal fuse
- ② Blown fuse

Type A:

Replace the blown fuse with a new fuse of an appropriate amperage rating. The amperage rating can be found on the fuse box lid.

Type B, C and D:

Contact your Lexus dealer.

▶ Type A

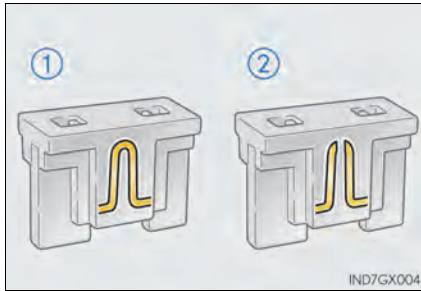

▶ Type B

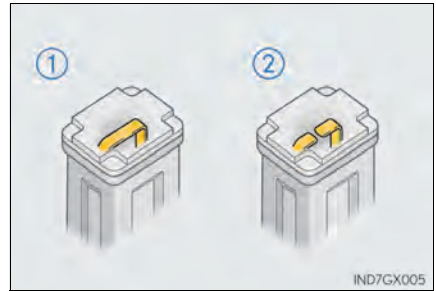

▶ Type C

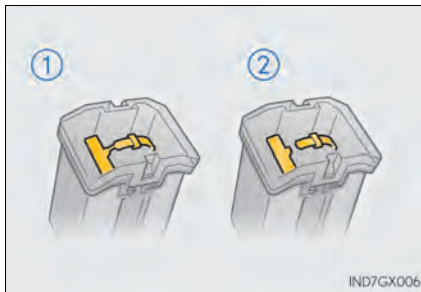

▶ Type D

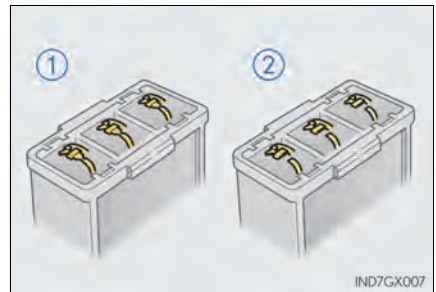

■ After a fuse is replaced

- If the lights do not turn on even after the fuse has been replaced, a bulb may need replacement. (→P. 514)
- If the replaced fuse blows again, have the vehicle inspected by your Lexus dealer.

■ If there is an overload in a circuit

The fuses are designed to blow, protecting the wiring harness from damage.

**WARNING****■ To prevent system breakdowns and vehicle fire**

Observe the following precautions.

Failure to do so may cause damage to the vehicle, and possibly a fire or injury.

- Never use a fuse of a higher amperage rating than indicated, or use any other object in place of a fuse.
- Always use a genuine Lexus fuse or equivalent.
Never replace a fuse with a wire, even as a temporary fix.
- Do not modify the fuses or the fuse boxes.

**NOTICE****■ Before replacing fuses**

Have the cause of electrical overload determined and repaired by your Lexus dealer, as soon as possible.

Headlight aim

Vertical movement adjusting bolts

- ① Adjustment bolt A
- ② Adjustment bolt B

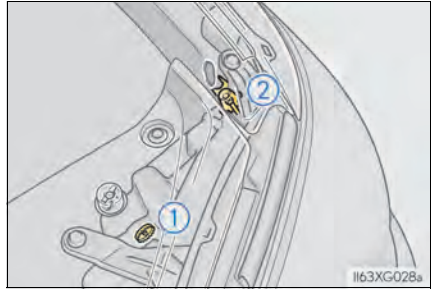

Before checking the headlight aim

- 1 Make sure the vehicle has a full tank of gasoline and the area around the headlight is not deformed.
- 2 Park the vehicle on level ground.
- 3 Sit in the driver's seat.
- 4 Bounce the vehicle several times.

Adjusting the headlight aim

- 1 Using a Phillips-head screwdriver, turn bolt A in either direction.
Remember the turning direction and the number of turns.

▶ Left-hand side

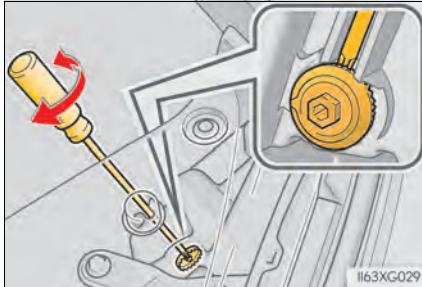

▶ Right-hand side

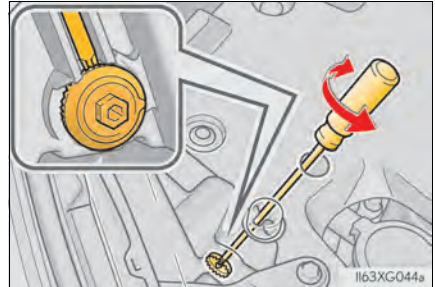

- 2 Turn bolt B the same number of turns and in the same direction as step 1.

If the headlight cannot be adjusted using this procedure, take the vehicle to your Lexus dealer to adjust the headlight aim.

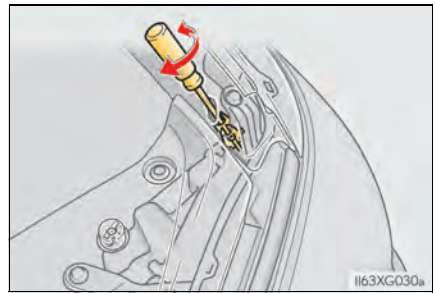

Light bulbs

You may replace the following bulbs yourself. The difficulty level of replacement varies depending on the bulb. If necessary bulb replacement seems difficult to perform, contact your Lexus dealer.

For more information about replacing other light bulbs, contact your Lexus dealer.

Preparing for light bulb replacement

Check the wattage and color of the light bulb being replaced. (→P. 585)

Bulb locations

■ Front

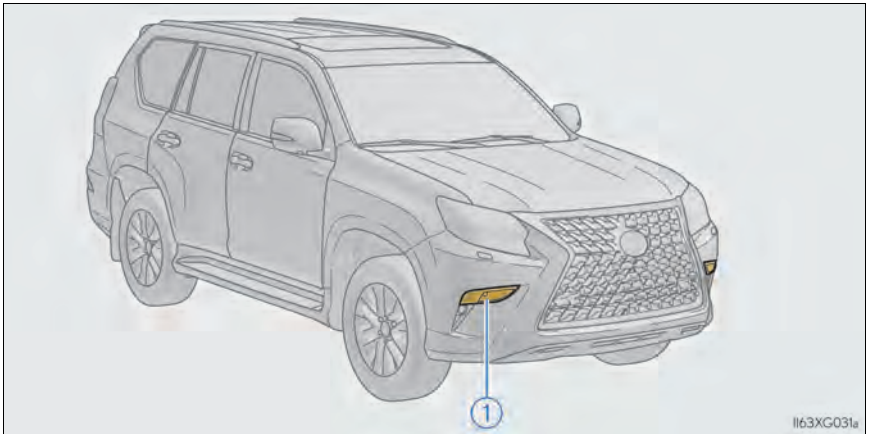

- ① Front turn signal light

■ Rear

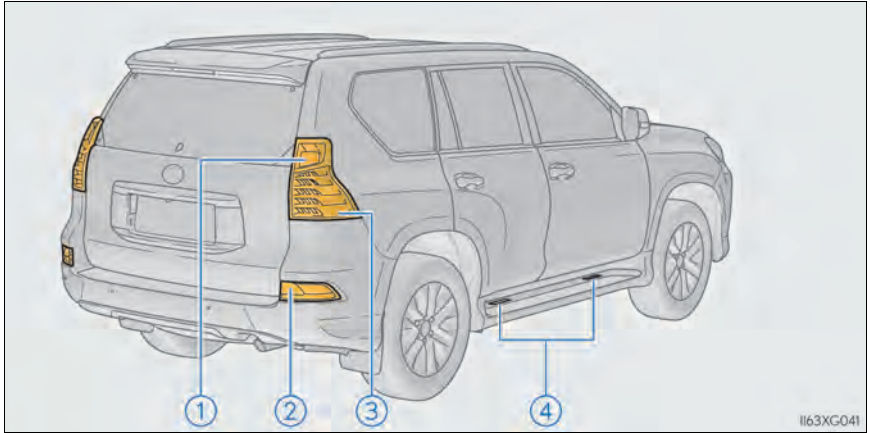

① Rear turn signal light

② Back-up light

③ Rear side marker light

④ Running board lights

Replacing light bulbs

■ Front turn signal lights

- 1 Turn the bulb base counterclockwise.

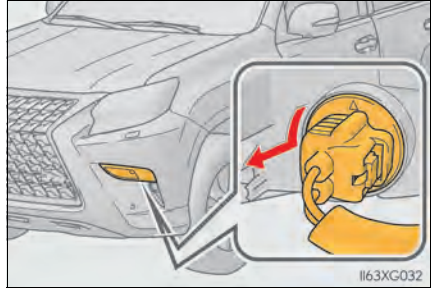

- 2 Remove the light bulb.

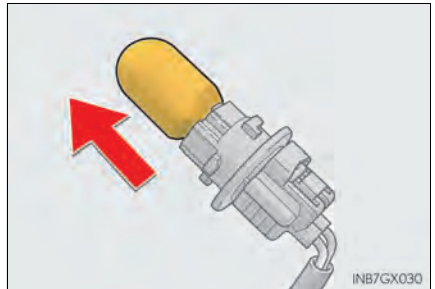

- 3 When installing, reverse the steps listed.

■ Rear turn signal lights and rear side marker lights

1 Open the back door.

▶ Left-hand side

Remove the bolts and lamp assembly.

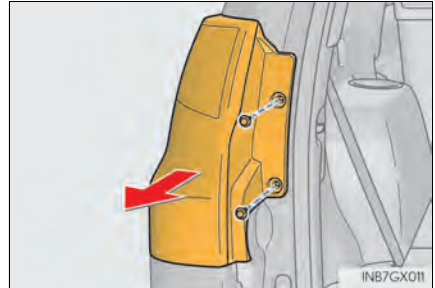

▶ Right-hand side

1 Remove the bolts.

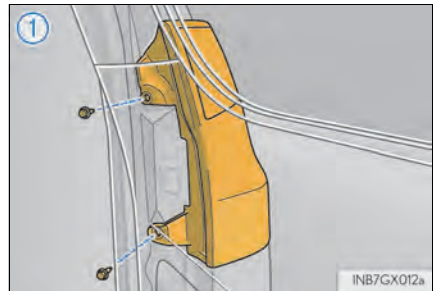

2 Close the back door half way and remove the lamp assembly.

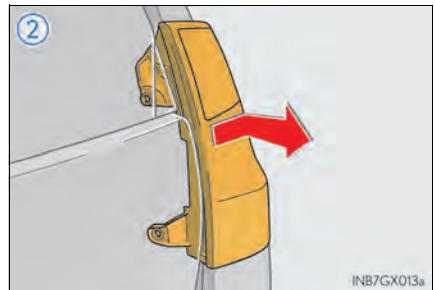

- 2 Unplug the connector while pushing the lock release.

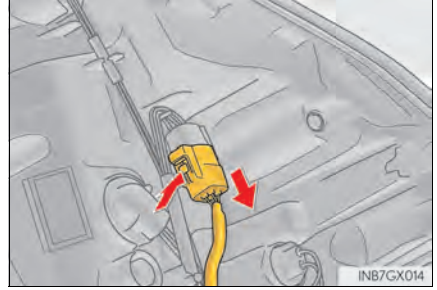

- 3 Turn the bulb bases counter-clockwise.

- 1 Rear turn signal light
- 2 Rear side marker light

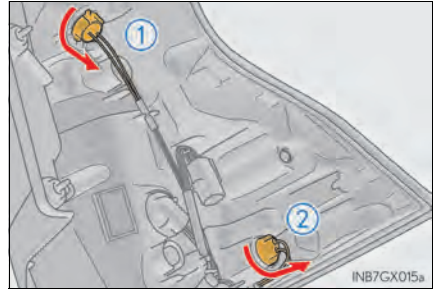

- 4 Remove the light bulb.

- 1 Rear turn signal light
- 2 Rear side marker light

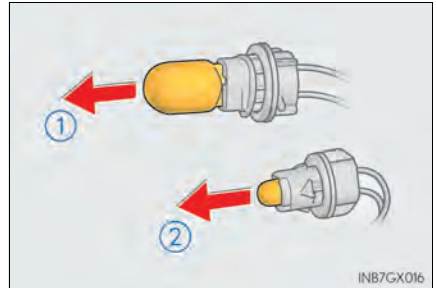

- 5 When installing, reverse the steps listed.

■ Back-up lights

- 1** Remove the bolts and pull down the under cover.

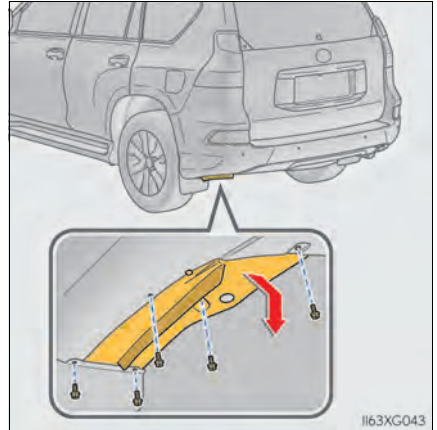

- 2** Turn the bulb base counterclockwise.

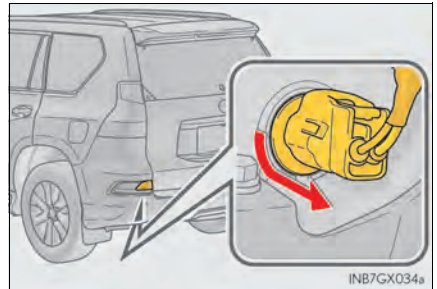

- 3** Remove the light bulb.

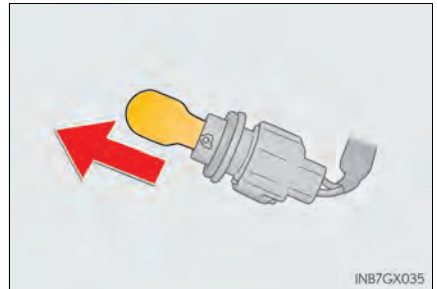

- 4** When installing, reverse the steps listed.

■ Running board lights

- 1 Turn the bulb bases counter-clockwise.

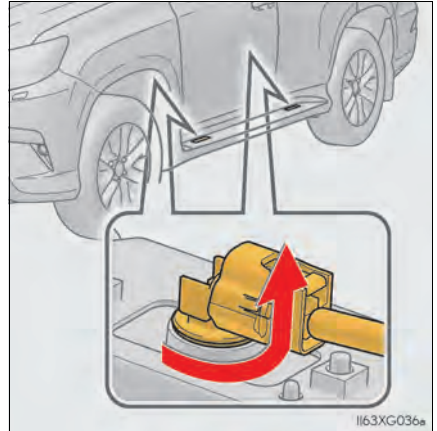

- 2 Remove the light bulb.

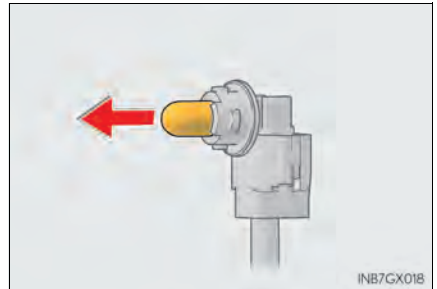

- 3 When installing, reverse the steps listed.

■ Replacing the following bulbs

If any of the lights listed below has burnt out, have it replaced by your Lexus dealer.

- Headlights
- Parking lights/daytime running lights
- Front side marker lights
- Fog lights (if equipped)
- Side turn signal lights
- High mounted stoplight
- Stop/tail lights
- License plate lights

■ LED lights

The headlights, parking lights/daytime running lights, front side marker lights, fog lights, side turn signal lights, high mounted stoplight, stop/tail lights and license plate lights consist of a number of LEDs. If any of the LEDs burn out, take your vehicle to your Lexus dealer to have the light replaced.

■ Condensation build-up on the inside of the lens

Temporary condensation build-up on the inside of the headlight lens does not indicate a malfunction. Contact your Lexus dealer for more information in the following situations:

- Large drops of water are built up on the inside of the lens.
- Water has built up inside the headlight.



WARNING

■ Replacing light bulbs

- Turn off the headlights. Do not attempt to replace the bulb immediately after turning off the headlights.
The bulbs become very hot and may cause burns.
- Do not touch the glass portion of the light bulb with bare hands. When it is unavoidable to hold the glass portion, use and hold with a clean dry cloth to avoid getting moisture and oils on the bulb.
Also, if the bulb is scratched or dropped, it may blow out or crack.
- Fully install light bulbs and any parts used to secure them. Failure to do so may result in heat damage, fire, or water entering the headlight unit. This may damage the headlights or cause condensation to build up on the lens.
- Do not attempt to repair or disassemble light bulbs, connectors, electric circuits or component parts.
Doing so may result in death or serious injury due to electric shock.

■ To prevent damage or fire

- Make sure bulbs are fully seated and locked.
- Check the wattage of the bulb before installing to prevent heat damage.

7-1. Essential information

Emergency flashers	524
If your vehicle has to be stopped in an emergency	525
If the vehicle is submerged or water on the road is rising	526

7-2. Steps to take in an emergency

If your vehicle needs to be towed	528
If you think something is wrong	533
Fuel pump shut off system	534
If a warning light turns on or a warning buzzer sounds	535
If a warning message is displayed	544
If you have a flat tire	548
If the engine will not start	562
If the electronic key does not operate properly	564
If the vehicle battery is discharged	567
If your vehicle overheats	570
If the vehicle becomes stuck	573

Emergency flashers

The emergency flashers are used to warn other drivers when the vehicle has to be stopped in the road due to a breakdown, etc.

Press the switch.

All the turn signals will flash.

To turn them off, press the switch once again.

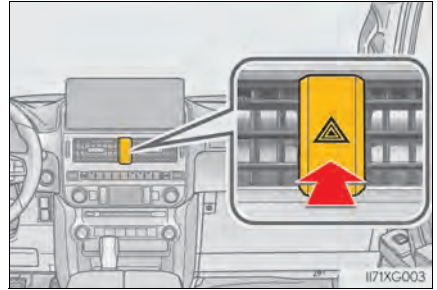

■ Emergency flashers

If the emergency flashers are used for a long time while the engine is not operating, the battery may discharge.

If your vehicle has to be stopped in an emergency

Only in an emergency, such as if it becomes impossible to stop the vehicle in the normal way, stop the vehicle using the following procedure:

- 1 Steadily step on the brake pedal with both feet and firmly depress it.
Do not pump the brake pedal repeatedly as this will increase the effort required to slow the vehicle.
- 2 Shift the shift lever to N.
 - ▶ If the shift lever is shifted to N
- 3 After slowing down, stop the vehicle in a safe place by the road.
- 4 Stop the engine.
 - ▶ If the shift lever cannot be shifted to N
- 3 Keep depressing the brake pedal with both feet to reduce vehicle speed as much as possible.
- 4 To stop the engine, press and hold the engine switch for 2 consecutive seconds or more, or press it briefly 3 times or more in succession.

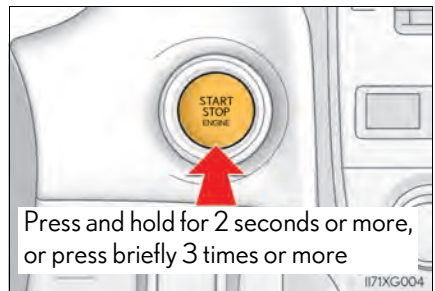

- 5 Stop the vehicle in a safe place by the road.

WARNING

■ If the engine has to be turned off while driving

Power assist for the brakes and steering wheel will be lost, making the brake pedal harder to depress and the steering wheel heavier to turn. Decelerate as much as possible before turning off the engine.

If the vehicle is submerged or water on the road is rising

This vehicle is not designed to be able to drive on roads that are deeply flooded with water. Do not drive on roads where the roads may be submerged or the water may be rising. It is dangerous to remain in the vehicle, if it anticipated that the vehicle will be flooded or set a drift. Remain calm and follow the following.

- If the door can be opened, open the door and exit the vehicle.
- If the door can not be opened, open the window using the power window switch and ensure an escape route.
- If the window can be opened, exit the vehicle through the window.
- If the door and window cannot be opened due to the rising water, remain calm, wait until the water level inside the vehicle rises to the point that the water pressure inside of the vehicle equals the water pressure outside of the vehicle and then open the door after waiting for the rising water to enter the vehicle, and exit the vehicle. When the outside water level exceeds half the height of the door, the door cannot be opened from the inside due to water pressure.

■ Water level exceeds the floor

When the water level exceeds the floor and time has passed, the electrical equipment will get damaged, the power windows will not operate, the engine stop, and the vehicle may not be able to get moving.

■ Using an emergency escape hammer^{*1}

Laminated glass^{*2} is used in the windshield and the windows on this vehicle.

Laminated glass cannot be shattered with an emergency hammer^{*1}.

^{*1}: Contact your Lexus dealer or aftermarket accessory manufacturer for further information about an emergency hammer.

^{*2}: If equipped

■ How to distinguish laminated glass

When looking from the cross-sectional view point, laminated glass is two sheets of glass pasted together.

- ① Laminated glass
- ② Tempered glass

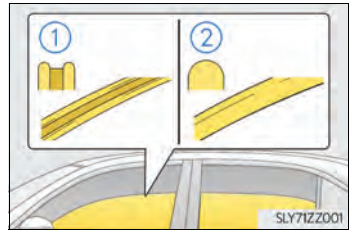

⚠ WARNING

■ Caution while driving

Do not drive on roads where the roads may be submerged or the water may be rising. Otherwise the vehicle may be damaged and cannot move, as well as become flooded and set a drift, which may lead to death.

If your vehicle needs to be towed

If towing is necessary, we recommend having your vehicle towed by your Lexus dealer or commercial towing service, using a wheel-lift type truck or flatbed truck.

Use a safety chain system for all towing, and abide by all state/provincial and local laws.

If towing your vehicle with a wheel-lift type truck, use a towing dolly.
(→P. 529, 531)

Situations when it is necessary to contact dealers before towing

The following may indicate a problem with your transmission. Contact your Lexus dealer or commercial towing service before towing.

- The engine is running but the vehicle does not move.
- The vehicle makes an abnormal sound.

Towing with a wheel-lift type truck

► From the front

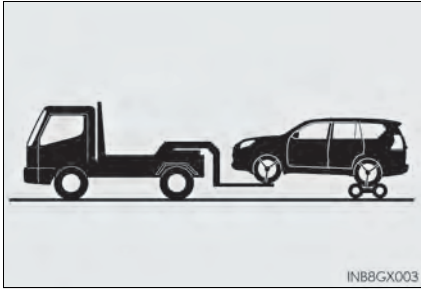

Use a towing dolly under the rear wheels.

► From the rear

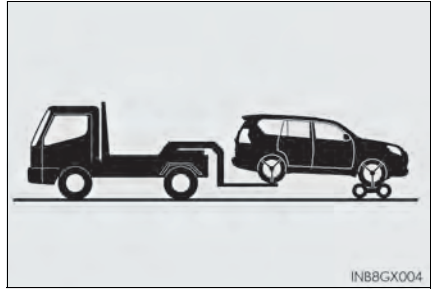

Use a towing dolly under the front wheels.

Using a flatbed truck

When using a flatbed truck to transport the vehicle, use tire strapping belts. Refer to the owner's manual of the flatbed truck for the tire strapping method.

In order to suppress vehicle movement during transportation, set the parking brake and turn the engine switch off.

Emergency towing

If a tow truck is not available in an emergency, your vehicle may be temporarily towed using cables or chains secured to the emergency towing hooks. This should only be attempted on hard surfaced roads for at most 50 miles (80 km) at under 18 mph (30 km/h).

A driver must be in the vehicle to steer and operate the brakes. The vehicle's wheels, drive train, axles, steering and brakes must be in good condition.

Emergency towing procedure

- 1 Securely attach cables or chains to the towing hooks.

Take care not to damage the vehicle body.

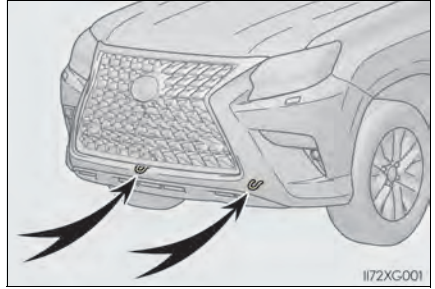

- 2 Enter the vehicle being towed and start the engine.
If the engine does not start, turn the engine switch to IGNITION ON mode.
- 3 Set the four-wheel drive control switch in H4 and push the center differential lock/unlock switch to unlock the center differential. (→P. 357)
- 4 For models with the rear height control air suspension: Change the vehicle height to N (normal) mode and end the vehicle height control operation. (→P. 352)
- 5 Shift the shift lever to N and release the parking brake.
When the shift lever cannot be shifted: →P. 209

■ While towing

If the engine is not running, the power assist for the brakes and steering will not function, making steering and braking more difficult.

⚠ WARNING

Observe the following precautions.
Failure to do so may result in death or serious injury.

■ When towing the vehicle

Be sure to transport the vehicle with all four wheels raised off the ground. If the vehicle is towed with the tires contacting the ground, the drivetrain or related parts may be damaged, the vehicle may fly off the truck.

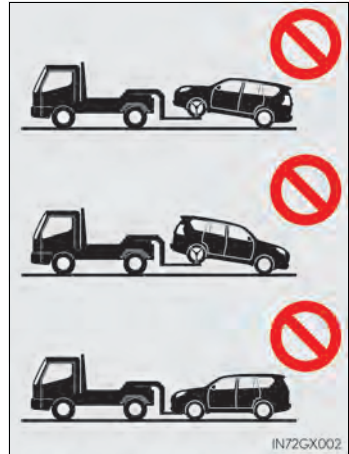

■ While towing

- When towing using cables or chains, avoid sudden starts, etc. which place excessive stress on the towing eyelets, cables or chains. The towing eyelets, cables or chains may become damaged, broken debris may hit people, and cause serious damage.
- For models with the rear height control air suspension: Make sure to disable all functions of the vehicle height control of the rear height control air suspension. Otherwise, the vehicle height may change and part of your body may be caught under the vehicle, possibly causing injury. (→P. 352)
- Do not turn the engine switch off.
There is a possibility that the steering wheel is locked and cannot be operated.

 NOTICE

■ To avoid serious damage to your vehicle

Do not use the rear emergency towing hook.

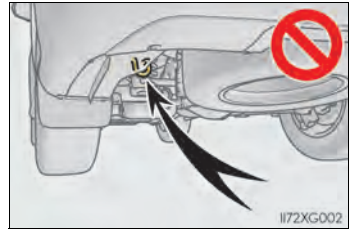
■ Towing with a sling-type truck

Do not tow with a sling-type truck to prevent body damage.

■ To prevent damage to the vehicle when towing using a wheel-lift type truck

- Do not tow the vehicle from the rear when the engine switch is off. The steering lock mechanism is not strong enough to hold the front wheels straight.
- When raising the vehicle, ensure adequate ground clearance for towing at the opposite end of the raised vehicle. Without adequate clearance, the vehicle could be damaged while being towed.

■ To prevent damage to the vehicle when towing with a sling-type truck

Do not tow with a sling-type truck, either from the front or rear.

■ To prevent damage to the vehicle during emergency towing

Do not secure cables or chains to the suspension components.

■ Recreational towing (behind motor home, etc.)

Never dinghy tow your vehicle to prevent causing serious damage to the Four-wheel drive system and transmission. (→P. 199)



If you think something is wrong

If you notice any of the following symptoms, your vehicle probably needs adjustment or repair. Contact your Lexus dealer as soon as possible.

Visible symptoms

- Fluid leaks under the vehicle
(Water dripping from the air conditioning after use is normal.)
- Flat-looking tires or uneven tire wear
- Engine coolant temperature gauge needle continually points higher than normal

Audible symptoms

- Changes in exhaust sound
- Excessive tire squeal when cornering
- Strange noises related to the suspension system
- Pinging or other noises related to the engine

Operational symptoms

- Engine missing, stumbling or running roughly
- Appreciable loss of power
- Vehicle pulls heavily to one side when braking
- Vehicle pulls heavily to one side when driving on a level road
- Loss of brake effectiveness, spongy feeling, pedal almost touches the floor

Fuel pump shut off system

To minimize the risk of fuel leakage when the engine stalls or when an airbag inflates upon collision, the fuel pump shut off system stops the supply of fuel to the engine.

Follow the procedure below to restart the engine after the system is activated.

- 1 Turn the engine switch to ACCESSORY mode or turn it off.
- 2 Restart the engine.



NOTICE

■ Before starting the engine









Inspect the ground under the vehicle.







If you find that fuel has leaked onto the ground, the fuel system has been damaged and is in need of repair. Do not restart the engine.







If a warning light turns on or a warning buzzer sounds



Calmly perform the following actions if any of the warning lights comes on or flashes. If a light comes on or flashes, but then goes off, this does not necessarily indicate a malfunction in the system. However, if this continues to occur, have the vehicle inspected by your Lexus dealer.

Warning light and warning buzzer list

Warning light	Warning light/Details/Actions
 (U.S.A.)  (Canada)	Brake system warning light (warning buzzer) Indicates that: <ul style="list-style-type: none"> • The brake fluid level is low; or • The brake system is malfunctioning. → Immediately stop the vehicle in a safe place and contact your Lexus dealer. Continuing to drive the vehicle may be dangerous.
	Charging system warning light Indicates a malfunction in the vehicle's charging system → Immediately stop the vehicle in a safe place and contact your Lexus dealer.
	Low engine oil pressure warning light*¹ Indicates that the engine oil pressure is too low → Immediately stop the vehicle in a safe place and contact your Lexus dealer.
 (U.S.A.)  (Canada)	Malfunction indicator lamp Indicates a malfunction in: <ul style="list-style-type: none"> • The electronic engine control system; • The electronic throttle control system; or • The electronic automatic transmission control system → Have the vehicle inspected by your Lexus dealer immediately.
	High coolant temperature warning light (warning buzzer)*¹ Indicates that the engine coolant temperature is too high → Immediately stop the vehicle in a safe place. Handling method (→P.570)
	SRS warning light Indicates a malfunction in: <ul style="list-style-type: none"> • The SRS airbag system; • The front passenger occupant classification system; or • The seat belt pretensioner system → Have the vehicle inspected by your Lexus dealer immediately.

Warning light	Warning light/Details/Actions
 <p>(U.S.A.)</p>  <p>(Canada)</p>	<p>ABS warning light Indicates a malfunction in:</p> <ul style="list-style-type: none"> • The ABS; or • The brake assist system <p>→ Have the vehicle inspected by your Lexus dealer immediately.</p>
 <p>(Flashes or illuminates)</p>	<p>PCS warning light When a buzzer sounds simultaneously: Indicates a malfunction has occurred in the PCS (Pre-Collision System). → Have the vehicle inspected by your Lexus dealer immediately. When a buzzer does not sound: The PCS (Pre-Collision System) has become temporarily unavailable, corrective action may be necessary. → Follow the instructions displayed on the multi-information display. (→P. 236) If the PCS (Pre-Collision System) or VSC (Vehicle Stability Control) system is disabled, the PCS warning light will illuminate. → P. 246</p>
	<p>Slip indicator Indicates a malfunction in:</p> <ul style="list-style-type: none"> • The Multi-terrain Select (if equipped); • The Crawl Control (if equipped); • The downhill assist control system (if equipped); • The VSC (Vehicle Stability Control) system; • The TRAC (Traction Control) system; • Active TRAC (Traction Control) system; • Trailer Sway Control; or • The hill-start assist control system <p>The light will flash when any of the above systems other than the Multi-terrain Select are operating. → Have the vehicle inspected by your Lexus dealer immediately.</p>
 <p>(Flashes) (U.S.A.)</p>  <p>(Flashes) (Canada)</p>	<p>Parking brake indicator Indicates a malfunction in the parking brake system → Have the vehicle inspected by your Lexus dealer immediately.</p>
	<p>Kinetic dynamic suspension system warning light Indicates a malfunction in the kinetic dynamic suspension system. → Have the vehicle inspected by your Lexus dealer immediately.</p>

Warning light	Warning light/Details/Actions
 <p>(Flashes)</p>	<p>Low speed four-wheel drive indicator light Indicates a malfunction in the four-wheel drive system if the light continues flashing. (→P. 357) → Have the vehicle inspected by your Lexus dealer immediately.</p>
 <p>(Flashes)</p>	<p>Center differential lock indicator light Indicates a malfunction in the four-wheel drive system if the light continues flashing. (→P. 357) → Have the vehicle inspected by your Lexus dealer immediately.</p>
	<p>Open door warning light (warning buzzer)*2 Indicates that a hood, door or the glass hatch is not fully closed → Check that all the doors and the glass hatch are closed.</p>
	<p>Low fuel level warning light Indicates that remaining fuel is approximately 3.5 gal. (13.1L, 2.9 Imp. gal.) or less → Refuel the vehicle.</p>
	<p>Driver's and front passenger's seat belt reminder light (warning buzzer)*3 Warns the driver and/or front passenger to fasten their seat belts → Fasten the seat belt. If the front passenger's seat is occupied, the front passenger's seat belt also needs to be fastened to make the warning light (warning buzzer) turn off.</p>
	<p>Tire pressure warning light Indicates that:</p> <ul style="list-style-type: none"> • Flat tire • Natural causes • The tire pressure warning system is malfunctioning <p>→ Immediately stop the vehicle in a safe place. Handling method(→P. 540)</p>

Warning light	Warning light/Details/Actions
	<p>Brake Override System warning light/Drive-Start Control warning light*1</p> <p>Brake Override System Indicates that the accelerator and brake pedals are being depressed simultaneously, and the Brake Override System is operating → Release the accelerator pedal and depress the brake pedal. Indicates a malfunction in the Brake Override System (with warning buzzer) → Have the vehicle inspected by your Lexus dealer immediately.</p> <p>Drive-Start Control Indicates that the shift position was changed and Drive-Start Control was operated while depressing the accelerator pedal (with warning buzzer) → Momentarily release the accelerator pedal. Indicates a malfunction in the Drive-Start Control system (with warning buzzer) → Have the vehicle inspected by your Lexus dealer immediately.</p>
	<p>LDA indicator*1 Indicates a malfunction in the LDA (Lane Departure Alert) → When “Lane Departure Alert Unavailable” is displayed on the multi-information display, turn the LDA system off, drive the vehicle for a short time, and then turn the LDA system back on. (→P. 249) When a message other than above is displayed, follow the instructions displayed in the message.</p>

- *1: This light illuminates on the multi-information display.
- *2: Open door warning buzzer:
The open door warning buzzer sounds to alert hood or one or more of the doors or glass hatch are not fully closed (with the vehicle having reached a speed of 3 mph [5 km/h]).
- *3: Driver's seat belt warning buzzer:
The driver's seat belt warning buzzer sounds to alert the driver that his or her seat belt is not fastened. Once the engine switch is turned to ON, the buzzer sounds. If the seat belt is still unfastened, the buzzer sounds intermittently for a certain period of time after the vehicle reaches a certain speed.
- Front passenger's seat belt warning buzzer:
The front passenger's seat belt warning buzzer sounds to alert the front passenger that his or her seat belt is not fastened. If the seat belt is unfastened, the buzzer sounds intermittently for a certain period of time after the vehicle reaches a certain speed.

■ SRS warning light

This warning light system monitors the airbag sensor assembly, front airbag sensors, side and curtain shield airbag sensors, rear side and curtain shield airbag sensors, floor sensor, driver's seat belt buckle switch, front passenger occupant classification system (ECU and sensors), "PASSENGER AIR BAG" indicator lights, front passenger's seat belt buckle switch, seat belt pretensioner assemblies, airbags, interconnecting wiring and power sources. (→P. 36)

■ Front passenger detection sensor, seat belt reminder and warning buzzer

- If luggage is placed on the front passenger seat, the front passenger detection sensor may cause the warning light to flash and the warning buzzer to sound even if a passenger is not sitting in the seat.
- If a cushion is placed on the seat, the sensor may not detect a passenger, and the warning light may not operate properly.

■ If the malfunction indicator lamp comes on while driving

First check the following:

- Is the fuel tank empty?
If it is, fill the fuel tank immediately.
- Is the fuel tank cap loose?
If it is, tighten it securely.

The light will go off after several driving trips.

If the light does not go off even after several trips, contact your Lexus dealer as soon as possible.

- **If the low speed four-wheel drive indicator light or the center differential lock indicator light blinks**

Take the specified steps. (→P. 359)

- **When the tire pressure warning light comes on**

Inspect the tires to check if a tire is punctured.

If a tire is punctured: →P. 548

If none of the tires are punctured:

Turn the engine switch off then turn it to IGNITION ON mode. Check if the tire pressure warning light comes on or flashes.

▶ If the tire pressure warning light comes on

- 1 After the temperature of the tires has lowered sufficiently, check the inflation pressure of each tire and adjust them to the specified level.
- 2 If the warning light does not turn off even after several minutes have elapsed, check that the inflation pressure of each tire is at the specified level and perform initialization. (→P. 490)

If the warning light does not turn off even after several minutes have elapsed, have the vehicle inspected by your Lexus dealer immediately.

▶ If the tire pressure warning light flashes for 1 minute then stay on

There may be a malfunction in the tire pressure warning system. Have the vehicle inspected by your Lexus dealer immediately.

- **The tire pressure warning light may turn on due to natural causes**

The tire pressure warning light may turn on due to natural causes such as natural air leaks or tire inflation pressure changes caused by temperature. In this case, adjusting the tire inflation pressure will turn off the warning light (after a few minutes).

- **When a tire is replaced with a spare tire**

The tire pressure warning light will turn on if the tire inflation pressure of the spare tire is low. If a tire goes flat, the tire pressure warning light will not turn off even though the flat tire has been replaced with the spare tire.

- **Conditions that the tire pressure warning system may not function properly**

→P. 494

- **If the tire pressure warning light frequently comes on after blinking for 1 minute**

If the tire pressure warning light frequently comes on after blinking for 1 minute when the engine switch is turned to IGNITION ON mode, have it checked by your Lexus dealer.

- **Warning buzzer**

In some cases, the buzzer may not be heard due to being in a noisy location or audio sound.

- **Customization**

The vehicle speed linked seat belt reminder buzzer can be disabled.
(Customizable features: →P. 600)

 **WARNING****■ If both the ABS and the brake system warning lights remain on**

Stop your vehicle in a safe place immediately and contact your Lexus dealer. The vehicle will become extremely unstable during braking, and the ABS system may fail, which could cause an accident resulting in death or serious injury.

■ If the tire pressure warning light comes on

Be sure to observe the following precautions. Failure to do so could cause loss of vehicle control and result in death or serious injury.

- Stop your vehicle in a safe place as soon as possible. Adjust the tire inflation pressure immediately.
- If the tire pressure warning light comes on even after tire inflation pressure adjustment, it is probable that you have a flat tire. Check the tires. If the tire is flat, change to the spare tire and have the flat tire repaired by the nearest Lexus dealer.
- Avoid abrupt maneuvering and braking. If the vehicle tires deteriorate, you could lose control of the steering wheel or the brakes.

■ If a blowout or sudden air leakage should occur

The tire pressure warning system may not activate immediately.

 **WARNING****■ Maintenance of the tires**

Each tire, including the spare (if provided), should be checked monthly when cold and inflated to the inflation pressure recommended by the vehicle manufacturer on the vehicle placard or tire inflation pressure label (tire and load information label). (If your vehicle has tires of a different size than the size indicated on the vehicle placard or tire inflation pressure label [tire and load information label], you should determine the proper tire inflation pressure for those tires.)

As an added safety feature, your vehicle has been equipped with a tire pressure monitoring system (TPMS-tire pressure warning system) that illuminates a low tire pressure telltale (tire pressure warning light) when one or more of your tires is significantly under-inflated. Accordingly, when the low tire pressure telltale (tire pressure warning light) illuminates, you should stop and check your tires as soon as possible, and inflate them to the proper pressure. Driving on a significantly under-inflated tire causes the tire to overheat and can lead to tire failure. Under-inflation also reduces fuel efficiency and tire tread life, and may affect the vehicle's handling and stopping ability.

Please note that the TPMS (tire pressure warning system) is not a substitute for proper tire maintenance, and it is the driver's responsibility to maintain correct tire pressure, even if under-inflation has not reached the level to trigger illumination of the TPMS low tire pressure telltale (tire pressure warning light).

Your vehicle has also been equipped with a TPMS (tire pressure warning system) malfunction indicator to indicate when the system is not operating properly. The TPMS (tire pressure warning system) malfunction indicator is combined with the low tire pressure telltale (tire pressure warning light). When the system detects a malfunction, the telltale will flash for approximately one minute and then remain continuously illuminated. This sequence will continue upon subsequent vehicle start-ups as long as the malfunction exists. When the malfunction indicator is illuminated, the system may not be able to detect or signal low tire pressure as intended.

TPMS (tire pressure warning system) malfunctions may occur for a variety of reasons, including the installation of replacement or alternate tires or wheels on the vehicle that prevent the TPMS (tire pressure warning system) from functioning properly. Always check the TPMS (tire pressure warning system) malfunction telltale after replacing one or more tires or wheels on your vehicle to ensure that the replacement or alternate tires and wheels allow the TPMS (tire pressure warning system) to continue to function properly.

**NOTICE****■ To ensure the tire pressure warning system operates properly**

Do not install tires with different specifications or makers, as the tire pressure warning system may not operate properly.

If a warning message is displayed

The multi-information display shows warnings of system malfunctions, incorrectly performed operations, and messages that indicate a need for maintenance. When a message is shown, perform the correction procedure appropriate to the message.

① Multi-information display

② Handling method

Follow the instructions of the message on the multi-information display.

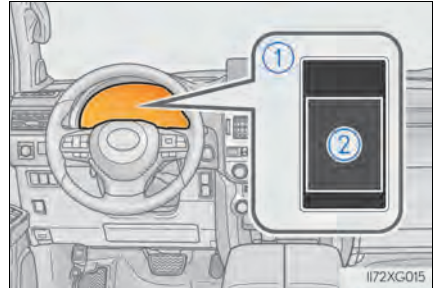

If any of the warning lights comes on again after the following actions have been performed, contact your Lexus dealer.

Messages and warnings

The warning lights and warning buzzers operate as follows depending on the content of the message. If a message indicates the need for inspection by a dealer, have the vehicle inspected by your Lexus dealer immediately.

Warning light	Warning buzzer [*]	Warning
—	Sounds	<ul style="list-style-type: none"> Indicates an important situation, such as when a system related to driving is malfunctioning or that danger may result if the correction procedure is not performed Indicates a situation, such as when damage to the vehicle or danger may result
Comes on or flashes	Sounds	Indicates an important situation, such as when the systems shown on the multi-information display may be malfunctioning
—	Does not sound	<ul style="list-style-type: none"> Indicates a condition, such as malfunction of electrical components, their condition, or indicates the need for maintenance Indicates a situation, such as when an operation has been performed incorrectly, or indicates how to perform an operation correctly

^{*}: A buzzer sounds the first time a message is shown on the multi-information display.

■ Warning messages

The warning messages explained below may differ from the actual messages according to operation conditions and vehicle specifications.

■ Warning buzzer

In some cases, the buzzer may not be heard due to being in a noisy location or audio sound.

■ If “ENGINE OIL LOW”/“Engine Oil Level Low Add or Replace” is shown

The engine oil level is low. Check the level of the engine oil, and add if necessary.

This message may appear if the vehicle is stopped on a slope. Move the vehicle to a level surface and check to see if the message disappears.

■ If “AUTOPOWER OFF TO CONSERVE BATTERY”/“Auto power off to conserve battery” is shown

Power was turned off due to the automatic power off function. Next time when starting the engine, increase the engine speed slightly and maintain that level for approximately 5 minutes to recharge the battery.

■ If “ENGINE OIL PRESSURE LOW”/“Oil Pressure Low Stop in a Safe Place See Owner’s Manual” is shown

Indicates abnormal engine oil pressure.

Immediately stop the vehicle in a safe place and contact your Lexus dealer. Continuing to drive the vehicle may be dangerous.

■ If “HIGH TRANSMISSION FLUID TEMPERATURE”/“High Transmission Fluid Temp See Owner’s Manual” is shown.

It indicates that the automatic transmission fluid temperature is too high.

Immediately stop the vehicle in a safe place, shift the shift lever to P and wait until the warning message disappears. If the warning message disappears, you may start the vehicle again. If the warning message does not disappear, contact your Lexus dealer.

■ If “Check Transmission System” is shown.

The automatic transmission system is malfunctioning.

Have the vehicle inspected by your Lexus dealer.

■ If “ACCELERATOR AND BRAKE PEDALS PRESSED SIMULTANEOUSLY”/“Accelerator and Brake Pedals Pressed Simultaneously” is shown on the multi-information display

The accelerator and brake pedal are being depressed simultaneously. (→P. 169)

Release the accelerator pedal and depress the brake pedal.

■ If “HEADLIGHT SYSTEM MALFUNCTION VISIT YOUR DEALER”/“Headlight System Malfunction Visit Your Dealer” is displayed

The following systems may be malfunctioning. Have the vehicle inspected by your Lexus dealer immediately.

- The LED headlight system
- The automatic headlight leveling system
- Automatic High Beam

■ **If a message that indicates the malfunction of front camera is displayed**

The following systems may be suspended until the problem shown in the message is resolved. (→P. 236, 535)

- PCS (Pre-Collision System)
- LDA (Lane Departure Alert)
- Automatic High Beam
- Dynamic radar cruise control

■ **If a message that indicates the malfunction of radar sensor is displayed**

The following systems may be suspended until the problem shown in the message is resolved. (→P. 236, 535)

- PCS (Pre-Collision System)
- LDA (Lane Departure Alert)
- Dynamic radar cruise control

■ **If “Radar Cruise Control Unavailable” is shown**

The dynamic radar cruise control system cannot be used temporarily.

Use the system when it becomes available again.

■ **If “Maintenance Required Soon” is shown (U.S.A. only)**

Indicates that all maintenance according to the driven distance on the maintenance schedule* should be performed soon. Comes on approximately 4500 miles (7200 km) after the message has been reset. If necessary, perform maintenance. Please reset the message after the maintenance is performed. (→P. 465)

*: Refer to the separate “Scheduled Maintenance” or “Owner’s Manual Supplement” for the maintenance interval applicable to your vehicle.

■ **If “Maintenance Required Visit Your Dealer” is shown (U.S.A. only)**

Indicates that all maintenance is required to correspond to the driven distance on the maintenance schedule*.

Comes on approximately 5000 miles (8000 km) after the message has been reset. (The indicator will not work properly unless the message has been reset.) Perform the necessary maintenance. Please reset the message after the maintenance is performed. (→P. 465)

*: Refer to the separate “Scheduled Maintenance” or “Owner’s Manual Supplement” for the maintenance interval applicable to your vehicle.

■ **If “Oil Maintenance Required Soon” is shown**

Indicates that the engine oil should be scheduled to be changed.

Check the engine oil and change it if necessary. After changing the engine oil, make sure to reset the message. (→P. 478)

■ **If “OIL MAINTENANCE REQUIRED” “Oil Maintenance Required Visit Your Dealer” is shown**

Indicates that the engine oil should be scheduled to be changed.

Check and change the engine oil, and oil filter by your Lexus dealer. After changing the engine oil, make sure to reset the message. (→P. 478)

■ **If “Check Access System with Elec. Key” is shown**

The smart access system with push-button start may be malfunctioning. Have the vehicle inspected by your Lexus dealer immediately.

- If **“SEE OWNER’S MANUAL”/“See Owner’s Manual”** is shown
 - If any of the following messages are shown on the multi-information display, follow the instructions.
 - “Engine Coolant Temp High” (→P. 570)
 - If any of the following messages are shown on the multi-information display, it may indicate a malfunction. Immediately stop the vehicle and contact your Lexus dealer.
 - “BRAKING POWER LOW”/“Braking Power Low”
 - “Charging System Malfunction”
- If a following message is shown, take appropriate action and confirm that the message has disappeared. (→P. 361) (if equipped)
 - “CRAWL NOT AVAILABLE SELECT L4 AND SHIFT TO D OR R POSITION”/“Crawl Not Available Select L4 and Shift to D or R Position”
 - “CRAWL NOT AVAILABLE CHECK SYSTEM OPERATION CONDITIONS”/“Crawl Not Available Check System Operation Conditions”
- If **“VISIT YOUR DEALER”/“Visit Your Dealer”** or **“CHECKED BY A DEALER”/“checked by a dealer”** is shown

The system or part shown on the multi-information display is malfunctioning. Have the vehicle inspected by your Lexus dealer immediately.

If you have a flat tire

Your vehicle is equipped with a spare tire. The flat tire can be replaced with the spare tire.

For details about tires: →P. 488



WARNING

■ If you have a flat tire

Do not continue driving with a flat tire.

Driving even a short distance with a flat tire can damage the tire and the wheel beyond repair, which could result in an accident.

Before jacking up the vehicle

- Stop the vehicle in a safe place on a hard, flat surface.
- Set the parking brake.
- Shift the shift lever to P.
- Turn off the rear height control air suspension (if equipped). (→P. 352)
- Stop the engine.
- Turn on the emergency flashers. (→P. 524)

Location of the spare tire, jack and tools

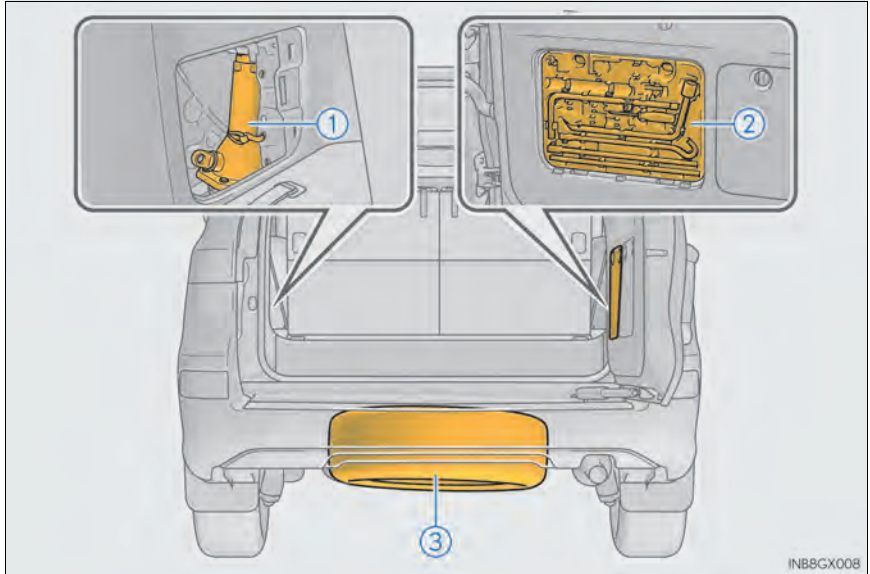

- ① Jack
- ② Tool box
- ③ Spare tire

**WARNING****■ Using the tire jack**

Improper use of the tire jack may cause the vehicle to suddenly fall off the jack, leading to death or serious injury.

- Do not use the tire jack for any purpose other than replacing tires or installing and removing tire chains.
- Only use the tire jack that comes with this vehicle for replacing a flat tire. Do not use it on other vehicles, and do not use other tire jacks for replacing tires on this vehicle.
- Always check that the tire jack is securely set to the jack point.
- Do not put any part of your body under the vehicle while it is supported by the jack.
- Do not start or run the engine while your vehicle is supported by the jack.
- Do not raise the vehicle while someone is inside.
- When raising the vehicle, do not put an object on or under the jack.
- Do not raise the vehicle to a height greater than that required to replace the tire.
- Use a jack stand if it is necessary to get under the vehicle.
- Vehicles with rear height control air suspension: Be sure to turn off the height control and stop the engine.

Take particular care when lowering the vehicle to ensure that no one working on or near the vehicle will be injured.

■ Using the jack handle

Tighten all the jack handle bolts securely using a Phillips-head screwdriver, to prevent the extension parts from coming apart unexpectedly.

Taking out the jack

1 Remove the cover.



2 Unhook the rubber band and take out the jack.

① For loosening

② For tightening

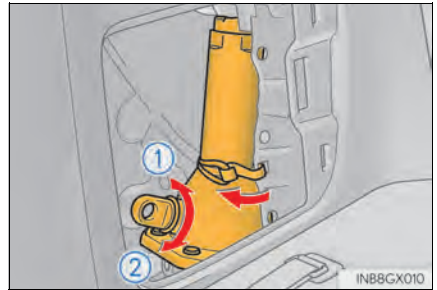

Taking out the tool box

1 Remove the cover.

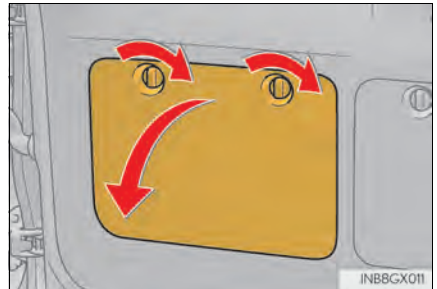

2 Take out the tool box.

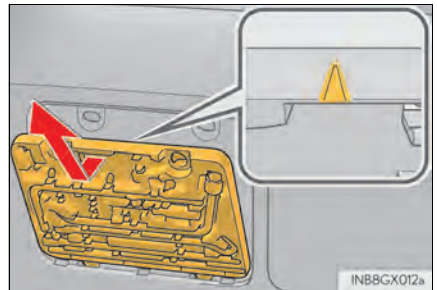

Taking out the spare tire

1 Assembling the jack handle.

Remove the jack handle and the jack handle extension bar from the tool box and assemble by following these steps.

- ① Loosen the bolt and the screw using either the jack handle end or a screwdriver.

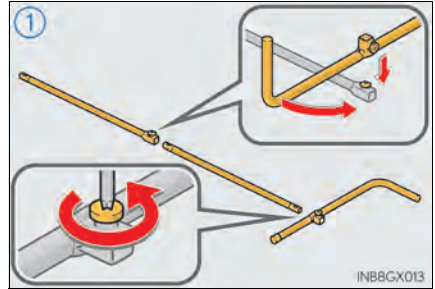

- ② Assemble the jack handle extension bar and the jack handle and tighten the bolt and the screw.

Check that the bolt and screw are firmly tightened.

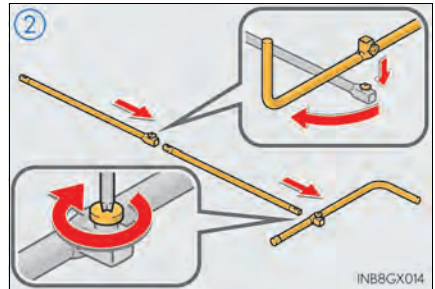

2 Remove the cover.

To protect the bodywork, place a rag between the screwdriver and the vehicle body.

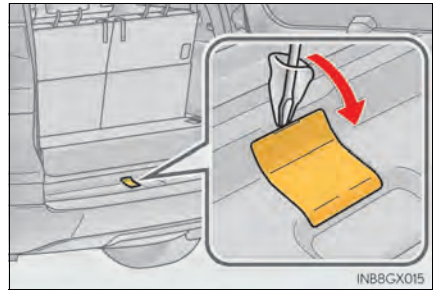

3 Insert the jack handle extension into the lowering socket.

① Lower

② Raise

Place a rag under the jack handle extension to protect the rear bumper.

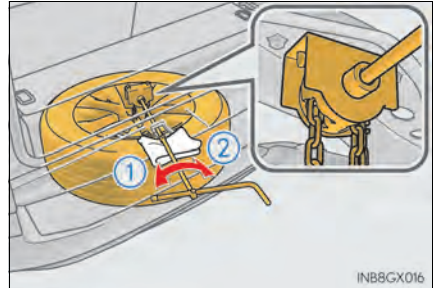

4 Lower the spare tire completely to the ground.

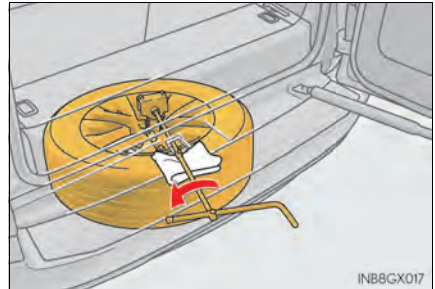

If the spare tire becomes caught on the suspension components, raise the tire, pull it towards the rear of the vehicle, and begin lowering it again.

5 Pull out the spare tire and remove the holding bracket.

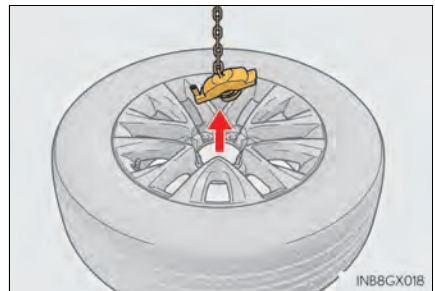

Replacing a flat tire

- 1** Chock the tires.

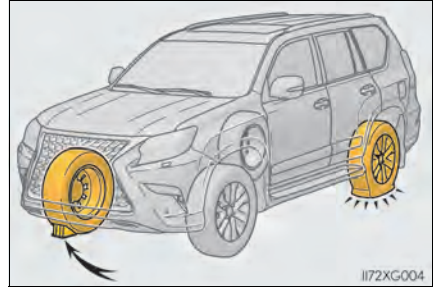

Flat tire		Wheel chock position
Front	Left-hand side	Behind the rear right-hand side tire
	Right-hand side	Behind the rear left-hand side tire
Rear	Left-hand side	In front of the front right-hand side tire
	Right-hand side	In front of the front left-hand side tire

- 2** Pry off the wheel ornament, using the beveled end of the wheel nut wrench as shown.

To protect the wheel ornament, place a rag between the wheel nut wrench and the wheel ornament.

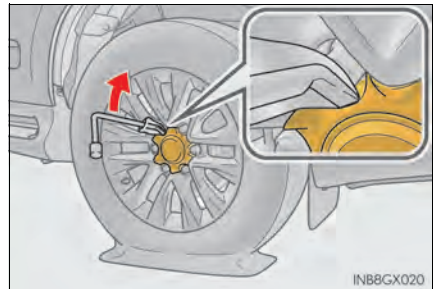

- 3** Slightly loosen the wheel nuts (one turn).

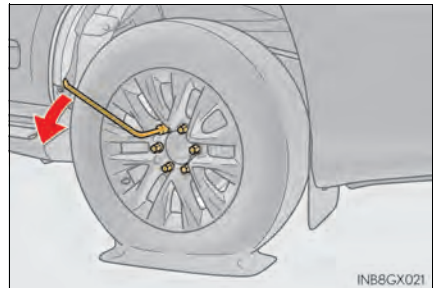

4 Assembling the jack handle.

Remove the jack handle, jack handle extension bar and jack handle bar from the tool box and assemble by following these steps.

- ① Loosen the bolt and the screw using either the jack handle end or a screwdriver.

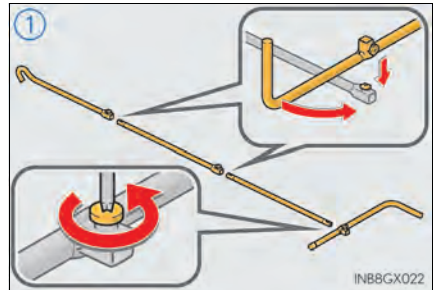

- ② Assemble the jack handle extension bar and the jack handle bar and tighten the bolts.

Check that the bolts are firmly tightened.

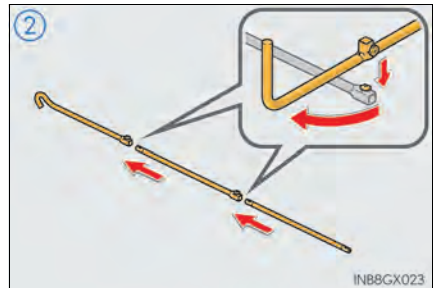

- ③ Assemble the jack handle extension bar and the jack handle and tighten the screw.

Check that the screw is firmly tightened.

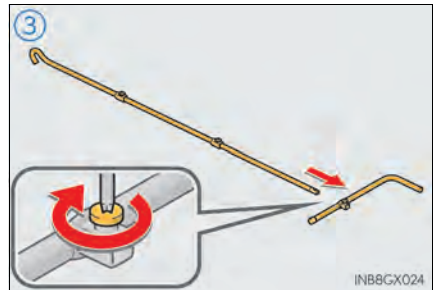

- 5** Position the jack at the jack points as shown.
- ① Front
Under the chassis frame side rail
 - ② Rear
Under the rear axle housing

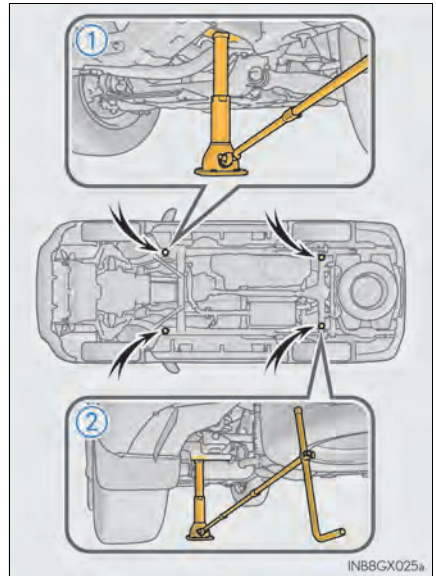

- 6** Raise the vehicle until the tire is slightly raised off the ground.

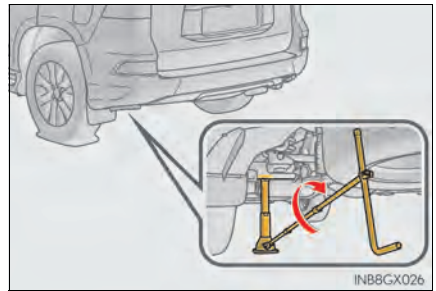

- 7** Remove all the wheel nuts and the tire.

When resting the tire on the ground, place the tire so that the wheel design faces up to avoid scratching the wheel surface.

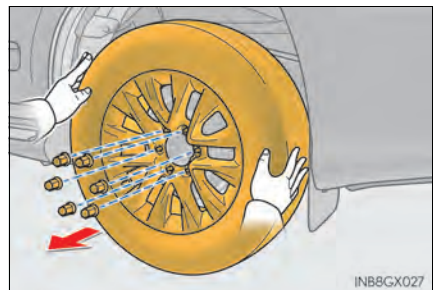

 **WARNING****■ Replacing a flat tire**

- Observe the following precautions.

Failure to do so may result in serious injury:

- Lower the spare tire completely to the ground before removing it from under the vehicle.
- Do not try to remove the wheel ornament by hand. Take due care in handling the ornament to avoid unexpected personal injury.
- Do not touch the disc wheels or the area around the brakes immediately after the vehicle has been driven.

After the vehicle has been driven the disc wheels and the area around the brakes will be extremely hot. Touching these areas with hands, feet or other body parts while changing a tire, etc. may result in burns.

- Failure to follow these precautions could cause the nuts to loosen and the wheel may fall off, which could lead to an accident causing death or serious injury.
 - Never use oil or grease on the wheel bolts or wheel nuts.
Oil and grease may cause the wheel nuts to be excessively tightened, leading to bolt or disc wheel damage. In addition, the oil or grease can cause the wheel nuts to loosen and the wheel may fall off, causing a serious accident. Remove any oil or grease from the wheel bolts or wheel nuts.
 - Have the wheel nuts tightened with a torque wrench to 76 ft•lbf (103 N•m, 10.5 kgf•m) as soon as possible after changing wheels.
 - Do not attach a heavily damaged wheel ornament, as it may fly off the wheel while the vehicle is moving.
 - When installing a tire, only use wheel nuts that have been specifically designed for that wheel.
 - If there are any cracks or deformations in the bolt screws, nut threads or bolt holes of the wheel, have the vehicle inspected by your Lexus dealer.

Installing the spare tire

- 1 Remove any dirt or foreign matter from the wheel contact surface.

If foreign matter is on the wheel contact surface, the wheel nuts may loosen while the vehicle is in motion, and the tire may come off the vehicle.

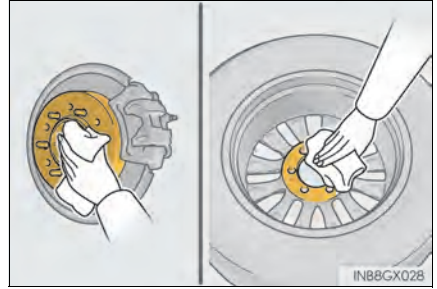

- 2 Install the spare tire and loosely tighten each nut by hand to approximately the same amount.

Turn the wheel nuts until the washers come into contact with the disc wheel.

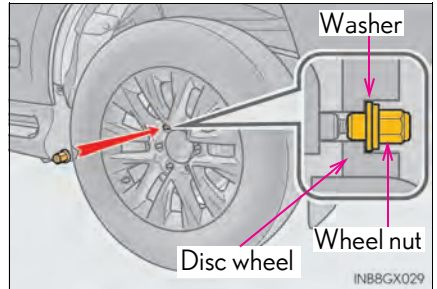

- 3 Lower the vehicle.

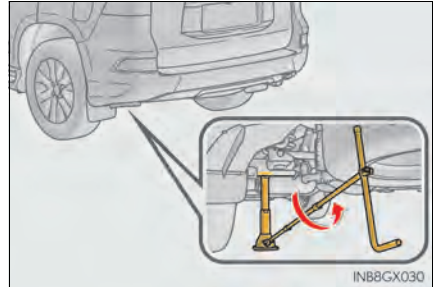

- 4 Firmly tighten each nut two or three times in the order shown in the illustration.

Tightening torque:

76 ft•lbf (103 N•m, 10.5 kgf•m)

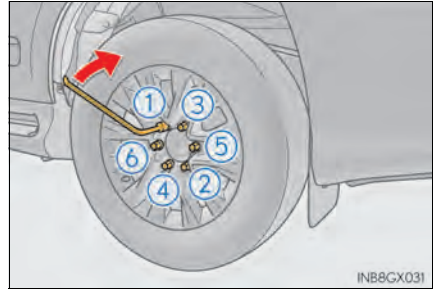

- 5 Reinstall the wheel ornament.

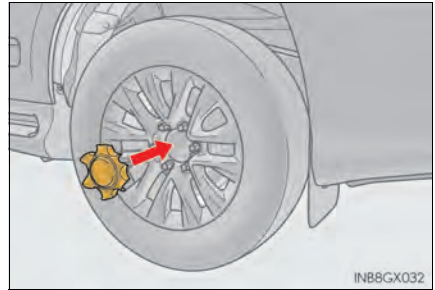

! WARNING

■ Stowing the flat tire

Failure to follow steps listed under stowing the tire may result in damage to the spare tire carrier and loss of the tire, which could result in death or serious injury.

Stowing the flat tire, jack and all tools

- 1 Lay down the tire with the valve stem facing up and install the holding bracket, inserting the claw into the wheel lug nut hole. Turn the jack handle extension clockwise to take up slack in the chain.

Then, check to ensure the claw is in the wheel lug nut hole and the holding bracket is centered in the wheel hub.

- 1 Claw
- 2 Holding bracket

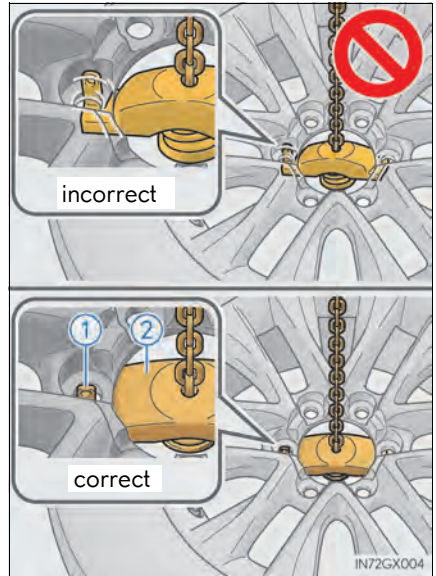

- 2 Raise the tire.

While raising, pull the tire towards the rear of the vehicle, taking care that the tire goes up without catching on any surrounding part, to prevent it from flying forward during a collision or sudden braking.

After the tire goes half way up, check that the suspended chain is able to enter the tire hole, for proper storage.

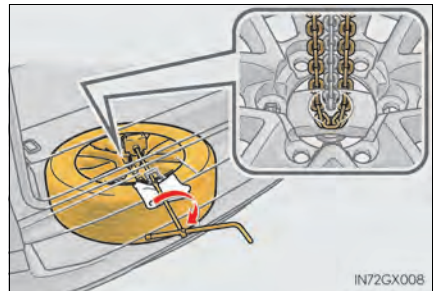

Tightening torque:

34.4 ft•lbf (46.6 N•m, 4.8 kgf•m)

- 3 Confirm that the tire is not loose after tightening:

- 1 Push and pull the tire
- 2 Try rotating

Visually check to ensure the tire is not hung on surrounding parts.

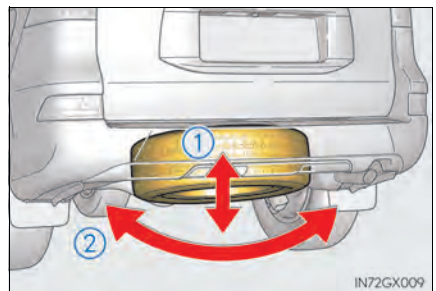

If looseness or misassembly exists, repeat step 2 and step 3.

- 4 Repeat step 3, any time the tire is lowered or disturbed.
- 5 Stow the tools and jack securely.

**WARNING****■ After using the tools and jack**

Before driving, make sure all the tools and jack are securely in place in their storage location to reduce the possibility of personal injury during a collision or sudden braking.

**NOTICE****■ When stowing the flat tire**

Ensure that there is no object caught between the tire and the vehicle underbody.

If the engine will not start

If the engine will not start even though correct starting procedures are being followed (→P. 200), consider each of the following points:

The engine will not start even when the starter motor operates normally.

One of the following may be the cause of the problem:

- There may not be sufficient fuel in the vehicle's tank.
Refuel the vehicle.
- The engine may be flooded.
Try to restart the engine again following correct starting procedures.
(→P. 200)
- There may be a malfunction in the engine immobilizer system. (→P. 76)

The starter motor turns over slowly, the interior lights and headlights are dim, or the horn does not sound or sounds at a low volume.

One of the following may be the cause of the problem:

- The battery may be discharged. (→P. 567)
- The battery terminal connections may be loose or corroded.

The starter motor does not turn over.

The engine starting system may be malfunctioning due to an electrical problem such as an open circuit or a blown fuse. However, an interim measure is available to start the engine. (→P. 563)

The starter motor does not turn over, the interior lights and headlights do not turn on, or the horn does not sound.

One of the following may be the cause of the problem:

- One or both of the battery terminals may be disconnected.
- The battery may be discharged. (→P. 567)
- There may be a malfunction in the steering lock system.

Contact your Lexus dealer if the problem cannot be repaired, or if repair procedures are unknown.

Emergency start function

When the engine does not start, the following steps can be used as an interim measure to start the engine if the engine switch is functioning normally.

- 1 Set the parking brake.
- 2 Shift the shift lever to P.
- 3 Turn the engine switch to the ACCESSORY mode.
- 4 Press and hold the engine switch for about 15 seconds while depressing the brake pedal firmly.

Even if the engine can be started using the above steps, the system may be malfunctioning. Have the vehicle inspected by your Lexus dealer.

If the electronic key does not operate properly

If communication between the electronic key and vehicle is interrupted (→P. 128) or the electronic key cannot be used because the battery is depleted, the smart access system with push-button start and wireless remote control cannot be used. In such cases, the doors can be opened and the engine can be started by following the procedure below.

Locking and unlocking the doors and key linked functions

Use the mechanical key (→P. 105) in order to perform the following operations (driver's door only):

- ① Locks all the doors
- ② Closes the windows and moon roof* (turn and hold)
- ③ Unlocks the doors
Turning the key rearward unlocks the driver's door. Turning the key once again unlocks the other doors.
- ④ Opens the windows and moon roof* (turn and hold)

*: These settings must be customized at your Lexus dealer.

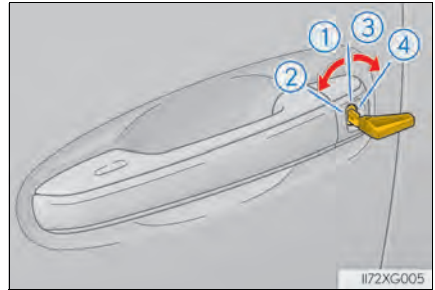

Starting the engine

1 Ensure that the shift lever is in P and depress the brake pedal.

2 Touch the Lexus emblem side of the electronic key to the engine switch.

When the electronic key is detected, a buzzer sounds and the engine switch will turn to IGNITION ON mode.

When the smart access system with push-button start is deactivated in customization setting, the engine switch will turn to ACCESSORY mode.

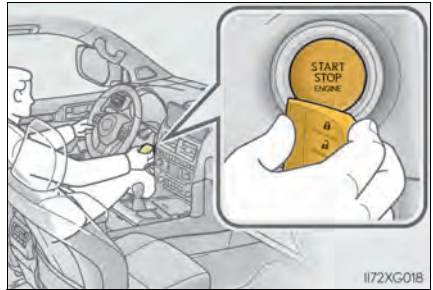

3 Firmly depress the brake pedal and check that  is shown on the multi-information display.

4 Press the engine switch shortly and firmly.

In the event that the engine still cannot be started, contact your Lexus dealer.

■ Stopping the engine

Shift the shift lever to P and press the engine switch as you normally do when stopping the engine.

■ Replacing the key battery

As the above procedure is a temporary measure, it is recommended that the electronic key battery be replaced immediately when the battery is depleted. (→P. 507)

■ Alarm (for Canada)

Using the mechanical key to lock the doors will not set the alarm system. If a door is unlocked using the mechanical key when the alarm system is set, the alarm may be triggered. (→P. 77)

■ Changing engine switch modes

Within 10 seconds of the buzzer sounding, release the brake pedal and press the engine switch.

The engine does not start and modes will be changed each time the switch is pressed. (→P. 201)

■ When the electronic key does not work properly

- Make sure that the smart access system with push-button start has not been deactivated in the customization setting. If it is off, turn the function on.
(Customizable features: →P. 600)
- Check if battery-saving mode is set. If it is set, cancel the function. (→P. 128)

**WARNING****■ When using the mechanical key and operating the power windows or moon roof**

Operate the power window or moon roof after checking to make sure that there is no possibility of any passenger having any of their body parts caught in the window or moon roof.

Also, do not allow children to operate the mechanical key. It is possible for children and other passengers to get caught in the power window or moon roof.

If the vehicle battery is discharged

The following procedures may be used to start the engine if the vehicle's battery is discharged.

You can call your Lexus dealer, or qualified repair shop.

If you have a set of jumper (or booster) cables and a second vehicle with a 12-volt battery, you can jump start your Lexus by following the steps below.

- 1 Confirm that the electronic key is being carried.

When connecting the jumper (or booster) cables, depending on the situation, the alarm may activate and the doors locked. (→P. 78)



- 2 Open the hood. (→P. 474)
- 3 Connecting the jumper cables according to the following procedure:

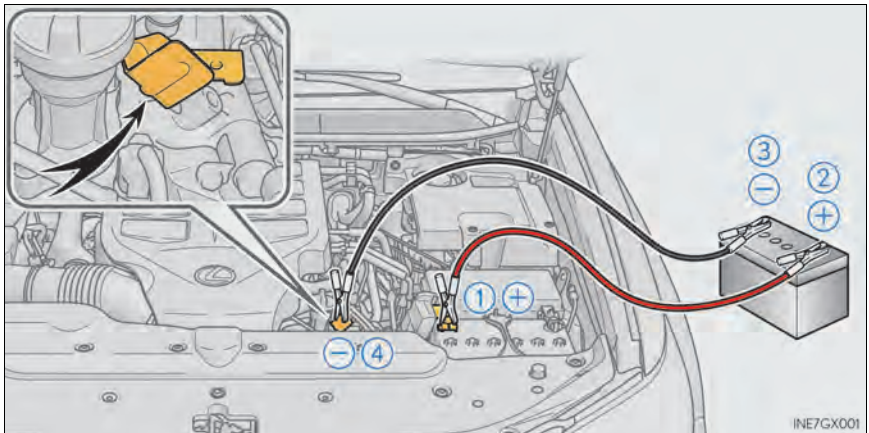

- 1 Positive (+) battery terminal on your vehicle.
- 2 Positive (+) battery terminal on the second vehicle.
- 3 Negative (-) battery terminal on the second vehicle.
- 4 Connect the jumper cable to ground on your vehicle as shown in the illustration.

- 4 Start the engine of the second vehicle. Increase the engine speed slightly and maintain at that level for approximately 5 minutes to recharge the battery of your vehicle.
- 5 Open and close any of the doors of your vehicle with the engine switch off.
- 6 Maintain the engine speed of the second vehicle and start the engine of your vehicle by turning the engine switch to IGNITION ON mode.
- 7 Once your vehicle's engine has started, remove the jumper cables in the exact reverse order in which they were connected.

Once the engine starts, have the vehicle checked at your Lexus dealer as soon as possible.

■ Starting the engine when the battery is discharged

The engine cannot be started by push-starting.

■ To prevent battery discharge

- Turn off the headlights and the audio system while the engine is off.
- Turn off any unnecessary electrical components when the vehicle is running at a low speed for an extended period, such as in heavy traffic.

■ Charging the battery

The electricity stored in the battery will discharge gradually even when the vehicle is not in use, due to natural discharge and the draining effects of certain electrical appliances. If the vehicle is left for a long time, the battery may discharge, and the engine may be unable to start. (The battery recharges automatically during driving.)

■ When recharging or replacing the battery

- In some cases, it may not be possible to unlock the doors using the smart access system with push-button start when the battery is discharged. Use the wireless remote control or the mechanical key to lock or unlock the doors.
- The engine may not start on the first attempt after the battery has recharged but will start normally after the second attempt. This is not a malfunction.
- The engine switch mode is memorized by the vehicle. When the battery is reconnected, the system will return to the mode it was in before the battery was discharged. Before disconnecting the battery, turn the engine switch off. If you are unsure what mode the engine switch was in before the battery discharged, be especially careful when reconnecting the battery.

 **WARNING****■ Avoiding battery fires or explosions**

Observe the following precautions to prevent accidentally igniting the flammable gas that may be emitted from the battery:

- Make sure the jumper cable is connected to the correct terminal and that it is not unintentionally in contact with any other than the intended terminal.
- Do not allow the + and - clamps of the jumper cables to come into contact with each other.
- Do not smoke, use matches, cigarette lighters or allow open flame near the battery.

■ Battery precautions

The battery contains poisonous and corrosive acidic electrolyte, while related parts contain lead and lead compounds. Observe the following precautions when handling the battery:

- When working with the battery, always wear safety glasses and take care not to allow any battery fluids (acid) to come into contact with skin, clothing or the vehicle body.
- Do not lean over the battery.
- In the event that battery fluid comes into contact with the skin or eyes, immediately wash the affected area with water and seek medical attention.
Place a wet sponge or cloth over the affected area until medical attention can be received.
- Always wash your hands after handling the battery support, terminals, and other battery-related parts.
- Do not allow children near the battery.

 **NOTICE****■ When handling jumper cables**

When connecting the jumper cables, ensure that they do not become entangled in the cooling fans or belt.

If your vehicle overheats

The following may indicate that your vehicle is overheating.

- The needle of the engine coolant temperature gauge (→P. 88) enters the red zone or a loss of engine power is experienced. (For example, the vehicle speed does not increase.)
- Steam is coming from under the hood.

Correction procedures

- 1 Stop the vehicle in a safe place and turn off the air conditioning system, and then stop the engine.
- 2 If you see steam:
Carefully lift the hood after the steam subsides.

If you do not see steam:
Carefully lift the hood.
- 3 After the engine has cooled down sufficiently, inspect the hoses and radiator core (radiator) for any leaks.

① Radiator

② Cooling fans

If a large amount of coolant leaks, immediately contact your Lexus dealer.

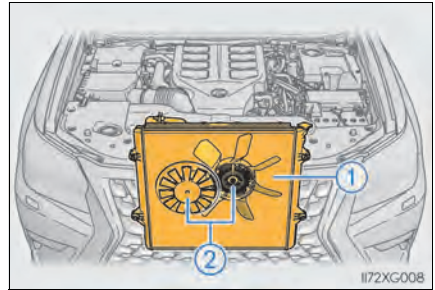

- 4** The coolant level is satisfactory if it is between the “F” and “L” lines on the reservoir.

- ① Reservoir
- ② “F”
- ③ “L”
- ④ Radiator cap

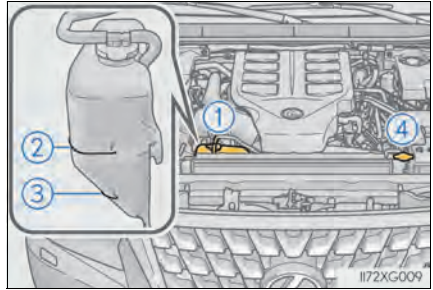

- 5** Add coolant if necessary.

Water can be used in an emergency if coolant is unavailable.

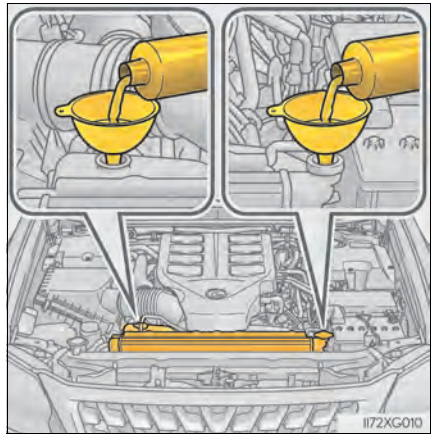

- 6** Start the engine and turn the air conditioning system on to check that the radiator cooling fans operate and to check for coolant leaks from the radiator or hoses.

The fans operate when the air conditioning system is turned on immediately after a cold start. Confirm that the fans are operating by checking the fan sound and air flow. If it is difficult to check these, turn the air conditioning system on and off repeatedly. (The fans may not operate in freezing temperatures.)

- 7** If the fans are not operating:
Stop the engine immediately and contact your Lexus dealer.
- If the fans are operating:
Have the vehicle inspected at the nearest Lexus dealer.

**WARNING****■ When inspecting under the hood of your vehicle**

Observe the following precautions.

Failure to do so may result in serious injury such as burns.

- If steam is seen coming from under the hood, do not open the hood until the steam has subsided. The engine compartment may be very hot.
- Keep hands and clothing (especially a tie, a scarf or a muffler) away from the fans and belts. Failure to do so may cause the hands or clothing to be caught, resulting in serious injury.
- Do not loosen the radiator cap or the coolant reservoir cap while the engine and radiator are hot. High temperature steam or coolant could spray out.

**NOTICE****■ When adding engine coolant**

Add coolant slowly after the engine has cooled down sufficiently. Adding cool coolant to a hot engine too quickly can cause damage to the engine.

■ To prevent damage to the cooling system

Observe the following precautions:

- Avoid contaminating the coolant with foreign matter (such as sand or dust etc.).
- Do not use any coolant additive.

If the vehicle becomes stuck

Carry out the following procedures if the tires spin or the vehicle becomes stuck in mud, dirt, or snow:

- 1 Stop the engine. Set the parking brake and shift the shift lever to P.
- 2 Remove the mud, snow or sand from around the stuck tire.
- 3 Place wood, stones or some other material under the tires to help provide traction.
- 4 Restart the engine.
- 5 Lock the center differential. (→P. 358)
- 6 Shift the shift lever to the D or R position and release the parking brake. Then, while exercising caution, depress the accelerator pedal.

■ When it is difficult to free the vehicle

Turn off TRAC/Active TRAC/VSC/Trailer Sway Control if these functions are hampering your attempts to free the vehicle. (→P. 370)

Press to turn off TRAC/Active TRAC/VSC/Trailer Sway Control.

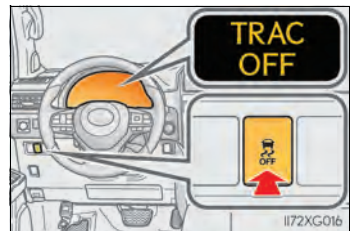

**WARNING****■ When attempting to free a stuck vehicle**

If you choose to push the vehicle back and forth to free it, make sure the surrounding area is clear, to avoid striking other vehicles, objects or people. The vehicle may also lunge forward or lunge back suddenly as it becomes free. Use extreme caution.

■ When shifting the shift lever

Be careful not to shift the shift lever with the accelerator pedal depressed. This may lead to unexpected rapid acceleration of the vehicle that may cause an accident and result in death or serious injury.

**NOTICE****■ To avoid damaging the transmission and other components**

- Avoid spinning the wheels and depressing the accelerator pedal more than necessary.
- If the vehicle remains stuck even after these procedures are performed, the vehicle may require towing to be freed.
- When a warning message for the automatic transmission fluid temperature is displayed while attempting to free a stuck vehicle, immediately remove your foot from the accelerator pedal and wait until the warning message disappears. Otherwise, the transmission may become damaged. (→P. 545)

8-1. Specifications

Maintenance data (fuel, oil level, etc.)	576
Fuel information.....	586
Tire information	589

8-2. Customization

Customizable features	600
-----------------------------	-----

8-3. Items to initialize

Items to initialize.....	609
--------------------------	-----

Maintenance data (fuel, oil level, etc.)

Dimensions and weights

Overall length		189.2 in. (4880 mm)
Overall width		74.2 in. (1885 mm)
Overall height ^{*1}	Without shark fin antenna	71.7 in. (1820 mm) ^{*2,6} 72.0 in. (1830 mm) ^{*2,5} 72.2 in. (1835 mm) ^{*3,6} 72.6 in. (1845 mm) ^{*3,5} 74.2 in. (1885 mm) ^{*4,5}
	With shark fin antenna	73.8 in. (1875 mm) ^{*6} 74.2 in. (1885 mm) ^{*5}
Wheelbase		109.8 in. (2790 mm)
Front and rear tread		62.4 in. (1585 mm)
Vehicle capacity weight (Occupants + luggage)		1280 lb. (580 kg) ^{*6} 1315 lb. (595 kg) ^{*5}
TWR (trailer weight + cargo weight) (With towing hitch)	With brake	6500 lb. (2950 kg)
	Without brake	1000 lb. (453 kg)

*1: Unladen vehicles

*2: Vehicles without roof rails

*3: Vehicles with flat type roof rails

*4: Vehicles with bridge type roof rails

*5: Vehicles without rear height control air suspension

*6: Vehicles with rear height control air suspension

Seating capacity

Seating capacity	7-passenger models	6-passenger models
	7 (Front 2, Rear 5)	6 (Front 2, Rear 4)

Vehicle identification

■ Vehicle identification number

The vehicle identification number (VIN) is the legal identifier for your vehicle. This is the primary identification number for your Lexus. It is used in registering the ownership of your vehicle.

This number is stamped on the front right frame.

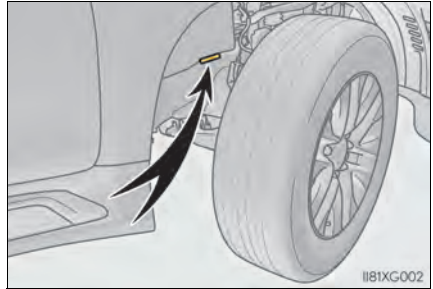

This number is also stamped on the top left of the instrument panel.

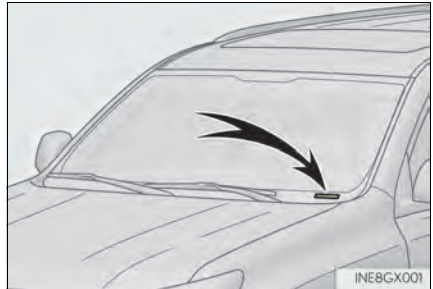

This number is also on the Certification label on the left-hand side center pillar.

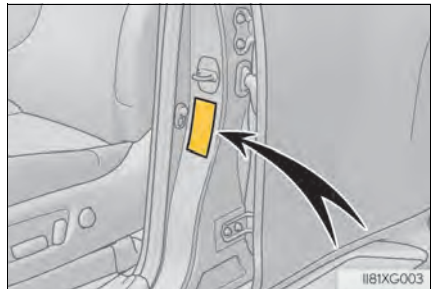

■ Engine number

The engine number is stamped on the engine block as shown.

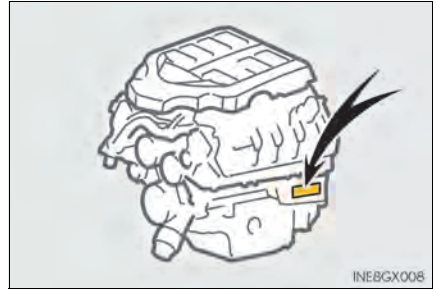

Engine

Model	4.6 L 8-cylinder (1UR-FE)
Type	8-cylinder V type, 4-cycle, gasoline
Bore and stroke	3.70 × 3.27 in. (94.0 × 83.0 mm)
Displacement	281.2 cu.in. (4608 cm ³)
Valve clearance	Automatic adjustment
Drive belt tension	Automatic adjustment

Fuel

Fuel type	Unleaded gasoline only
Octane rating	91 (Research Octane Number 96) or higher
Fuel tank capacity (Reference)	23.0 gal. (87 L, 19.1 Imp.gal.)

Lubrication system

Oil capacity (Drain and refill – reference*)	
With filter	8.2 qt. (7.8 L, 6.9 Imp.qt.)
Without filter	7.8 qt. (7.4 L, 6.5 Imp.qt.)

*: The engine oil capacity is a reference quantity to be used when changing the engine oil. Warm up and turn off the engine, wait more than 5 minutes, and check the oil level on the dipstick.

■ Engine oil selection

“Toyota Genuine Motor Oil” is used in your Lexus vehicle. Use Lexus approved “Toyota Genuine Motor Oil” or equivalent to satisfy the following grade and viscosity.

Oil grade:

ILSAC GF-6A multigrade engine oil

Recommended viscosity:

SAE 0W-20

SAE 0W-20 is the best choice for good fuel economy and good starting in cold weather.

If SAE 0W-20 is not available, SAE 5W-20 oil may be used. However, it must be replaced with SAE 0W-20 at the next oil change.

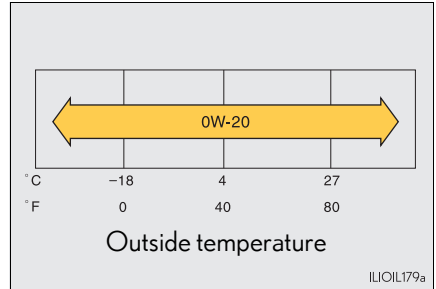

Oil viscosity (0W-20 is explained here as an example):

- The 0W in 0W-20 indicates the characteristic of the oil which allows cold startability. Oils with a lower value before the W allow for easier starting of the engine in cold weather.
- The 20 in 0W-20 indicates the viscosity characteristic of the oil when the oil is at high temperature. An oil with a higher viscosity (one with a higher value) may be better suited if the vehicle is operated at high speeds, or under extreme load conditions.

How to read oil container label:

The International Lubricant Specification Advisory Committee (ILSAC) Certification Mark is added to some oil containers to help you select the oil you should use.



Cooling system

Capacity (reference)	With rear heater	16.2 qt. (15.3 L, 13.5 Imp.qt.)
	Without rear heater	14.4 qt. (13.6 L, 12.0 Imp.qt.)
Coolant type		<p>Use either of the following:</p> <ul style="list-style-type: none"> • “Toyota Super Long Life Coolant” • A similar high-quality ethylene glycol-based non-silicate, non-amine, non-nitrite, and non-borate coolant with long-life hybrid organic acid technology <p>Do not use plain water alone.</p>

Ignition system (spark plug)

Make	DENSO SK20HR11
Gap	0.043 in. (1.1 mm)



NOTICE

■ Iridium-tipped spark plugs

Use only iridium-tipped spark plugs. Do not adjust the spark plug gap.

Electrical system (battery)

Specific gravity reading at 68°F (20°C):	12.3 V or higher In the case the voltage is less than standard, charge battery. (Voltage is checked 20 minutes after the engine)
Charging rates	5 A max.

Front differential

Oil capacity	1.48 qt. (1.40 L, 1.23 Imp.qt.)
Oil type and viscosity*	Toyota Genuine Differential Gear Oil LT 75W-85 GL-5 or equivalent

*: Your Lexus vehicle is filled with "Toyota Genuine Differential Gear Oil" at the factory. Use Lexus approved "Toyota Genuine Differential Gear Oil" or an equivalent of matching quality to satisfy the above specification. Please contact your Lexus dealer for further details.

Rear differential

Oil capacity	2.85 qt. (2.70 L, 2.38 Imp.qt.)
Oil type and viscosity*	Toyota Genuine Differential Gear Oil LT 75W-85 GL-5 or equivalent

*: Your Lexus vehicle is filled with "Toyota Genuine Differential Gear Oil" at the factory. Use Lexus approved "Toyota Genuine Differential Gear Oil" or an equivalent of matching quality to satisfy the above specification. Please contact your Lexus dealer for further details.

Automatic transmission

Fluid capacity *	With air-cooled type ATF cooler	11.8 qt. (11.2 L, 9.9 Imp.qt.)
	Without air-cooled type ATF cooler	11.6qt. (11.0 L, 9.7 Imp.qt.)
Fluid type		Toyota Genuine ATF WS

*: The fluid capacity is a reference quantity. If replacement is necessary, contact your Lexus dealer.



NOTICE

■ Transmission fluid type

Using transmission fluid other than the above type may cause abnormal noise or vibration, or damage the transmission of your vehicle.

Transfer

Oil capacity	1.5 qt. (1.4 L, 1.2 Imp.qt.)
Oil type *	Toyota Genuine Transfer Gear oil LF or equivalent
Recommended oil viscosity	SAE 75W

*: Your Lexus vehicle is filled with "Toyota Genuine Transfer Gear oil LF" at the factory. Use Lexus approved "Toyota Genuine Transfer Gear oil LF" or an equivalent of matching quality to satisfy the above specification. Please contact your Lexus dealer for further details.

Brakes

Pedal clearance ^{*1}	3.5 in. (90 mm) Min.
Pedal free play	0.04 — 0.24 in. (1 — 6 mm)
Brake pad wear limit	0.04 in. (1.0 mm)
Parking brake lining wear limit	0.04 in. (1.0 mm)
Parking brake pedal travel ^{*2}	5 — 7 clicks
Fluid type	SAE J1703 or FMVSS No. 116 DOT 3 SAE J1704 or FMVSS No. 116 DOT 4

*1: Minimum pedal clearance when depressed with a force of 110 lbf (490 N, 50 kgf) while the engine is running

*2: Parking brake pedal travel when pulled up with a force of 44.1 lbf (196 N, 20.0 kgf)

Chassis lubrication (Propeller shafts)

Spider Slide yoke	Lithium base chassis grease, NLGI No.2
----------------------	--

Steering

Free play	Less than 1.2 in. (30 mm)
Power steering fluid type	Automatic transmission fluid DEXRON® II or III

Tires and wheels

► 18-inch tires

Tire size	P265/60R18 109H
Tire inflation pressure (Recommended cold tire inflation pressure)	Front tire 32 psi (220 kPa, 2.2 kgf/cm ² or bar) Rear tire 32 psi (220 kPa, 2.2 kgf/cm ² or bar) Spare tire 32 psi (220 kPa, 2.2 kgf/cm ² or bar)
Wheel size	18 × 7 1/2J
Wheel nut torque	76 ft•lbf (103 N•m, 10.5 kgf•m)

► 19-inch tires

Tire size	265/55R19 109V
Tire inflation pressure (Recommended cold tire inflation pressure)	Front tire 32 psi (220 kPa, 2.2 kgf/cm ² or bar) Rear tire 32 psi (220 kPa, 2.2 kgf/cm ² or bar) Spare tire 32 psi (220 kPa, 2.2 kgf/cm ² or bar)
Wheel size	19 × 7 1/2J
Wheel nut torque	76 ft•lbf (103 N•m, 10.5 kgf•m)

Light bulbs

	Light bulbs		Bulb No.	W	Type
Exterior	Front turn signal lights		—	21	A
	Rear turn signal lights		—	21	A
	Back-up lights		921	16	B
	Rear side marker lights		—	5	B
	Running board lights		—	5	B
Interior	Personal/ Interior lights	Front	—	5	B
		Rear	—	5	B
	Vanity lights		—	8	B
	Door courtesy lights		—	5	B

A: Wedge base bulb (amber)

B: Wedge base bulb (clear)

Fuel information

You must only use unleaded gasoline.

Select premium unleaded gasoline with an octane rating of 91 (Research Octane Number 96) or higher required for optimum engine performance and fuel economy. If the octane rating is less than 91, damage to the engine may occur and may void the vehicle warranty.

At minimum, the gasoline you use should meet the specifications of ASTM D4814 in the U.S.A..

■ Gasoline quality

In very few cases, driveability problems may be caused by the brand of gasoline you are using. If driveability problems persist, try changing the brand of gasoline. If this does not correct the problem, consult your Lexus dealer.

■ Recommendation of the use of gasoline containing detergent additives

- Lexus recommends the use of gasoline that contains detergent additives to avoid the build-up of engine deposits.
- All gasoline sold in the U.S.A. contains minimum detergent additives to clean and/or keep clean intake systems, per EPA's lowest additives concentration program.
- Lexus strongly recommends the use of Top Tier Detergent Gasoline. For more information on Top Tier Detergent Gasoline and a list of marketers, please go to the official website www.toptiergas.com.

■ Recommendation of the use of low emissions gasoline

Gasolines containing oxygenates such as ethers and ethanol, as well as reformulated gasolines, are available in some cities. These fuels are typically acceptable for use, providing they meet other fuel requirements.

Lexus recommends these fuels, since the formulations allow for reduced vehicle emissions.

■ Non-recommendation of the use of blended gasoline

- Use only gasoline containing up to 15% ethanol.
DO NOT use any flex-fuel or gasoline that could contain more than 15% ethanol, including from any pump labeled E30, E50, E85 (which are only some examples of fuel containing more than 15% ethanol).

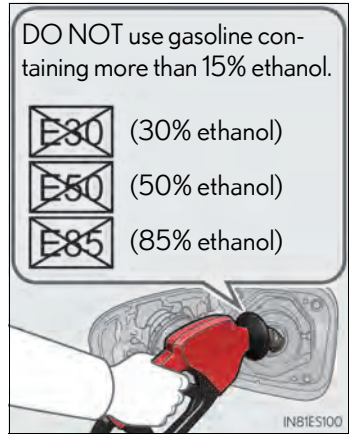

- If you use gasohol in your vehicle, be sure that it has an octane rating no lower than 91.
- Lexus does not recommend the use of gasoline containing methanol.

■ Non-recommendation of the use of gasoline containing MMT

Some gasoline contains an octane enhancing additive called MMT (Methylcy clopenta-dienyl Manganese Tricarbonyl).

Lexus does not recommend the use of gasoline that contains MMT. If fuel containing MMT is used, your emission control system may be adversely affected.

The malfunction indicator lamp on the instrument cluster may come on. If this happens, contact your Lexus dealer for service.

■ If your engine knocks

- Consult your Lexus dealer.
- You may occasionally notice light knocking for a short time while accelerating or driving uphill. This is normal and there is no need for concern.

**NOTICE****■ Notice on fuel quality**

- Do not use improper fuels. If improper fuels are used, the engine will be damaged.
- Do not use leaded gasoline.
Leaded gasoline can cause damage to your vehicle's three-way catalytic converters causing the emission control system to malfunction.
- Do not use gasohol other than the type previously stated.
Other gasohol may cause fuel system damage or vehicle performance problems.
- Using unleaded gasoline with an octane number or rating lower than the level previously stated may cause persistent heavy knocking.
At worst, this may lead to engine damage and will void the vehicle warranty.

■ Fuel-related poor driveability

If poor driveability (poor hot starting, vaporization, engine knocking, etc.) is encountered after using a different type of fuel, discontinue the use of that type of fuel.

■ When refueling with gasohol

Take care not to spill gasohol. It can damage your vehicle's paint.

Tire information

Typical tire symbols

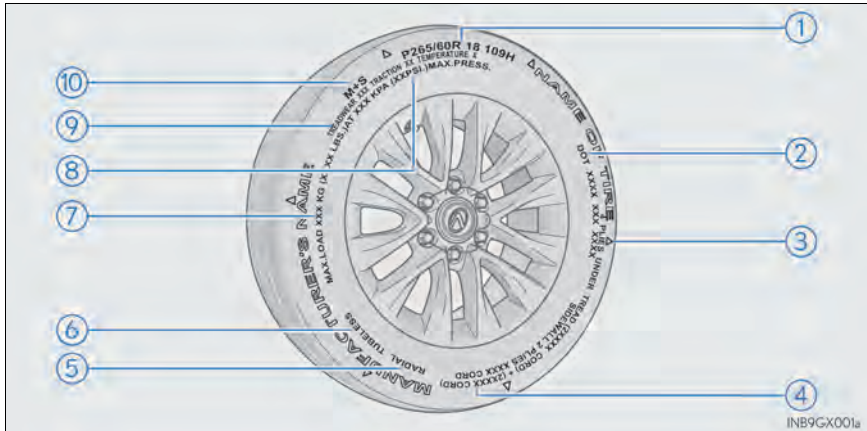

① Tire size (→P. 591)

② DOT and Tire Identification Number (TIN) (→P. 590)

③ Location of treadwear indicators (→P. 488)

④ Tire ply composition and materials

Ply is a layer of rubber-coated parallel cords. Cords are the strands which form the plies in a tire.

⑤ Radial tires or bias-ply tires

A radial tire has “RADIAL” on the sidewall. A tire not marked “RADIAL” is a bias-ply tire.

⑥ TUBELESS or TUBE TYPE

A tubeless tire does not have a tube and air is directly put into the tire. A tube type tire has a tube inside the tire and the tube maintains the air pressure.

⑦ Load limit at maximum cold tire inflation pressure (→P. 595)

⑧ Maximum cold tire inflation pressure (→P. 595)

This means the pressure to which a tire may be inflated.

⑨ Uniform tire quality grading

For details, see “Uniform Tire Quality Grading” that follows.

⑩ Summer tires or all season tires (→P. 493)

An all season tire has “M+S” on the sidewall. A tire not marked “M+S” is a summer tire.

Typical DOT and Tire Identification Number (TIN)

► Type A

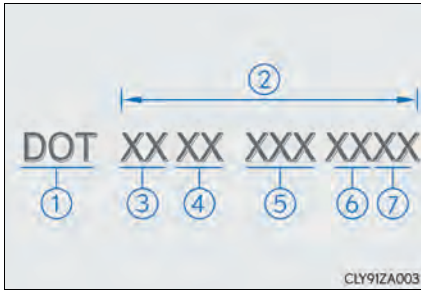

► Type B

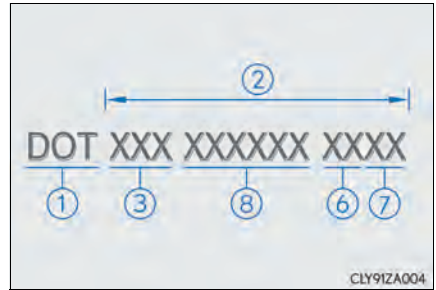

- ① DOT symbol*
- ② Tire Identification Number (TIN)
- ③ Tire manufacturer's identification mark
- ④ Tire size code
- ⑤ Manufacturer's optional tire type code (3 or 4 letters)
- ⑥ Manufacturing week
- ⑦ Manufacturing year
- ⑧ Manufacturer's code

*: The DOT symbol certifies that the tire conforms to applicable Federal Motor Vehicle Safety Standards.

Tire size

■ Typical tire size information

The illustration indicates typical tire size.

- ① Tire use (P = Passenger car, T = Temporary use)
- ② Section width (millimeters)
- ③ Aspect ratio (tire height to section width)
- ④ Tire construction code (R = Radial, D = Diagonal)
- ⑤ Wheel diameter (inches)
- ⑥ Load index (2 digits or 3 digits)
- ⑦ Speed symbol (alphabet with one letter)

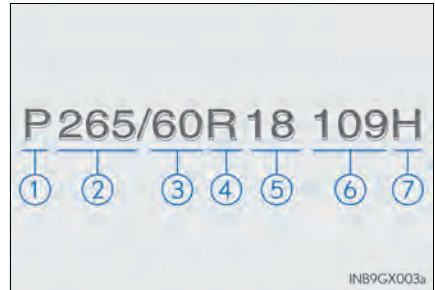

■ Tire dimensions

- ① Section width
- ② Tire height
- ③ Wheel diameter

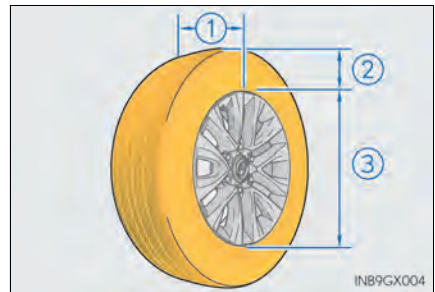

Tire section names

- ① Bead
- ② Sidewall
- ③ Shoulder
- ④ Tread
- ⑤ Belt
- ⑥ Inner liner
- ⑦ Reinforcing rubber
- ⑧ Carcass
- ⑨ Rim lines
- ⑩ Bead wires
- ⑪ Chafer

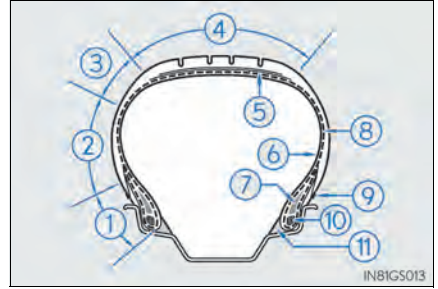

Uniform Tire Quality Grading

This information has been prepared in accordance with regulations issued by the National Highway Traffic Safety Administration of the U.S. Department of Transportation.

It provides the purchasers and/or prospective purchasers of Lexus vehicles with information on uniform tire quality grading.

Your Lexus dealer will help answer any questions you may have as you read this information.

■ DOT quality grades

All passenger vehicle tires must conform to Federal Safety Requirements in addition to these grades. Quality grades can be found where applicable on the tire sidewall between tread shoulder and maximum section width.

For example: Treadwear 200 Traction AA Temperature A

■ Treadwear

The treadwear grade is a comparative rating based on the wear rate of the tire when tested under controlled conditions on a specified government test course.

For example, a tire graded 150 would wear one and a half (1 - 1/2) times as well on the government course as a tire graded 100.

The relative performance of tires depends upon the actual conditions of their use. Performance may differ significantly from the norm due to variations in driving habits, service practices and differences in road characteristics and climate.

■ Traction AA, A, B, C

The traction grades, from highest to lowest, are AA, A, B and C, and they represent the tire's ability to stop on wet pavement as measured under controlled conditions on specified government test surfaces of asphalt and concrete.

A tire marked C may have poor traction performance.

Warning: The traction grade assigned to this tire is based on braking (straight ahead) traction tests and does not include cornering (turning) traction.

■ Temperature A, B, C

The temperature grades are A (the highest), B, and C, representing the tire's resistance to the generation of heat and its ability to dissipate heat when tested under controlled conditions on a specified indoor laboratory test wheel.

Sustained high temperature can cause the material of the tire to degenerate and reduce tire life, and excessive temperature can lead to sudden tire failure.

Grade C corresponds to a level of performance which all passenger car tires must meet under the Federal Motor Vehicle Safety Standard No. 109.

Grades B and A represent higher levels of performance on the laboratory test wheel than the minimum required by law.

Warning: The temperature grades of a tire assume that it is properly inflated and not overloaded.

Excessive speed, underinflation, or excessive loading, either separately or in combination, can cause heat buildup and possible tire failure.

Glossary of tire terminology

Tire related term	Meaning
Cold tire inflation pressure	Tire pressure when the vehicle has been parked for three hours or more, or has not been driven more than 1 mile or 1.5 km under that condition
Maximum inflation pressure	The maximum cold inflated pressure to which a tire may be inflated, shown on the sidewall of the tire
Recommended inflation pressure	Cold tire inflation pressure recommended by a manufacturer
Accessory weight	The combined weight (in excess of those standard items which may be replaced) of automatic transmission, power steering, power brakes, power windows, power seats, radio and heater, to the extent that these items are available as factory-installed equipment (whether installed or not)
Curb weight	The weight of a motor vehicle with standard equipment, including the maximum capacity of fuel, oil and coolant, and if so equipped, air conditioning and additional weight optional engine
Maximum loaded vehicle weight	The sum of: (a) Curb weight (b) Accessory weight (c) Vehicle capacity weight (d) Production options weight
Normal occupant weight	150 lb. (68 kg) times the number of occupants specified in the second column of Table 1* that follows
Occupant distribution	Distribution of occupants in a vehicle as specified in the third column of Table 1* below
Production options weight	The combined weight of installed regular production options weighing over 5 lb. (2.3 kg) in excess of the standard items which they replace, not previously considered in curb weight or accessory weight, including heavy duty brakes, ride levelers, roof rack, heavy duty battery, and special trim
Rim	A metal support for a tire or a tire and tube assembly upon which the tire beads are seated

Tire related term	Meaning
Rim diameter (Wheel diameter)	Nominal diameter of the bead seat
Rim size designation	Rim diameter and width
Rim type designation	The industry manufacturer's designation for a rim by style or code
Rim width	Nominal distance between rim flanges
Vehicle capacity weight (Total load capacity)	The rated cargo and luggage load plus 150 lb. (68 kg) times the vehicle's designated seating capacity
Vehicle maximum load on the tire	The load on an individual tire that is determined by distributing to each axle its share of the maximum loaded vehicle weight, and dividing by two
Vehicle normal load on the tire	The load on an individual tire that is determined by distributing to each axle its share of curb weight, accessory weight, and normal occupant weight (distributed in accordance with Table 1* below), and dividing by two
Weather side	The surface area of the rim not covered by the inflated tire
Bead	The part of the tire that is made of steel wires, wrapped or reinforced by ply cords and that is shaped to fit the rim
Bead separation	A breakdown of the bond between components in the bead
Bias ply tire	A pneumatic tire in which the ply cords that extend to the beads are laid at alternate angles substantially less than 90 degrees to the centerline of the tread
Carcass	The tire structure, except tread and sidewall rubber which, when inflated, bears the load
Chunking	The breaking away of pieces of the tread or sidewall
Cord	The strands forming the plies in the tire
Cord separation	The parting of cords from adjacent rubber compounds
Cracking	Any parting within the tread, sidewall, or innerliner of the tire extending to cord material

Tire related term	Meaning
CT	A pneumatic tire with an inverted flange tire and rim system in which the rim is designed with rim flanges pointed radially inward and the tire is designed to fit on the underside of the rim in a manner that encloses the rim flanges inside the air cavity of the tire
Extra load tire	A tire designed to operate at higher loads and at higher inflation pressures than the corresponding standard tire
Groove	The space between two adjacent tread ribs
Innerliner	The layer(s) forming the inside surface of a tubeless tire that contains the inflating medium within the tire
Innerliner separation	The parting of the innerliner from cord material in the carcass
Intended outboard sidewall	<p>(a) The sidewall that contains a whitewall, bears white lettering, or bears manufacturer, brand, and/or model name molding that is higher or deeper than the same molding on the other sidewall of the tire, or</p> <p>(b) The outward facing sidewall of an asymmetrical tire that has a particular side that must always face outward when mounted on a vehicle</p>
Light truck (LT) tire	A tire designated by its manufacturer as primarily intended for use on lightweight trucks or multipurpose passenger vehicles
Load rating	The maximum load that a tire is rated to carry for a given inflation pressure
Maximum load rating	The load rating for a tire at the maximum permissible inflation pressure for that tire
Maximum permissible inflation pressure	The maximum cold inflation pressure to which a tire may be inflated
Measuring rim	The rim on which a tire is fitted for physical dimension requirements
Open splice	Any parting at any junction of tread, sidewall, or innerliner that extends to cord material
Outer diameter	The overall diameter of an inflated new tire

Tire related term	Meaning
Overall width	The linear distance between the exteriors of the sidewalls of an inflated tire, including elevations due to labeling, decorations, or protective bands or ribs
Passenger car tire	A tire intended for use on passenger cars, multipurpose passenger vehicles, and trucks, that have a gross vehicle weight rating (GVWR) of 10,000 lb. or less.
Ply	A layer of rubber-coated parallel cords
Ply separation	A parting of rubber compound between adjacent plies
Pneumatic tire	A mechanical device made of rubber, chemicals, fabric and steel or other materials, that, when mounted on an automotive wheel, provides the traction and contains the gas or fluid that sustains the load
Radial ply tire	A pneumatic tire in which the ply cords that extend to the beads are laid at substantially 90 degrees to the centerline of the tread
Reinforced tire	A tire designed to operate at higher loads and at higher inflation pressures than the corresponding standard tire
Section width	The linear distance between the exteriors of the sidewalls of an inflated tire, excluding elevations due to labeling, decoration, or protective bands
Sidewall	That portion of a tire between the tread and bead
Sidewall separation	The parting of the rubber compound from the cord material in the sidewall
Snow tire	A tire that attains a traction index equal to or greater than 110, compared to the ASTM E-1136 Standard Reference Test Tire, when using the snow traction test as described in ASTM F-1805-00, Standard Test Method for Single Wheel Driving Traction in a Straight Line on Snow-and Ice-Covered Surfaces, and which is marked with an Alpine Symbol () on at least one sidewall

Tire related term	Meaning
Test rim	The rim on which a tire is fitted for testing, and may be any rim listed as appropriate for use with that tire
Tread	That portion of a tire that comes into contact with the road
Tread rib	A tread section running circumferentially around a tire
Tread separation	Pulling away of the tread from the tire carcass
Treadwear indicators (TWI)	The projections within the principal grooves designed to give a visual indication of the degrees of wear of the tread
Wheel-holding fixture	The fixture used to hold the wheel and tire assembly securely during testing

*: Table 1— Occupant loading and distribution for vehicle normal load for various designated seating capacities







Designated seating capacity, Number of occupants	Vehicle normal load, Number of occupants	Occupant distribution in a normally loaded vehicle
2 through 4	2	2 in front
5 through 10	3	2 in front, 1 in second seat
11 through 15	5	2 in front, 1 in second seat, 1 in third seat, 1 in fourth seat
16 through 20	7	2 in front, 2 in second seat, 2 in third seat, 1 in fourth seat

Customizable features

Your vehicle includes a variety of electronic features that can be personalized to suit your preferences. The settings of these features can be changed by using the meter control switches, the Remote Touch or at your Lexus dealer.

Customizing vehicle features

■ Changing by using the meter control switches

- 1 Press  or  of the meter control switches, select .
- 2 Press  or  of the meter control switches, select the item or the desired setting, and then press .

To go back to the previous screen, press .

■ Changing by using the Remote Touch

- 1 Press the "MENU" button on the Remote Touch.
- 2 Select "Setup" on the menu screen and select "Vehicle".
- 3 Select "Vehicle Customization".

Various setting can be changed. Refer to the list of settings that can be changed for details.

For details on the Remote Touch, refer to the "NAVIGATION SYSTEM OWNER'S MANUAL".

Customizable features

Some function settings are changed simultaneously with other functions being customized. Contact your Lexus dealer for further details.

- ① Settings that can be changed using the meter control switches
- ② Settings that can be changed using the Remote Touch
- ③ Settings that can be changed by your Lexus dealer

Definition of symbols: ○ = Available, - = Not available

■ Multi-information display (→P. 91)



Function	Default setting	Customized setting	①	②	③
Language	English	French*1	○	-	○
		Spanish			
Units*2	miles (MPG US)	km (km/L)	○	-	○
		km (L/100km)			
Eco Driving Indicator Light	On	Off	○	-	○
 switch settings	Drive information 1	Desired status screen*3	○	-	-

*1: The customized setting varies according to country.



*2: The default setting varies according to countries.

*3: Some status screens cannot be registered (indicated on the multi-information display)

■ LDA (Lane Departure Alert) (→P. 247)

Function	Default setting	Customized setting	①	②	③
Adjust alert type	 (Steering vibration)	 (Buzzer)	○	-	-
Alert sensitivity	Standard	High	○	-	-
Vehicle sway warning function	On	Off	○	-	-
Vehicle sway warning sensitivity	Standard	Low	○	-	-
		High			

■ PCS (Pre-Collision System) (→P. 237)

Function	Default setting	Customized setting	①	②	③
PCS (Pre-Collision System)	On	Off	<input type="radio"/>	-	-
Adjust alert timing	 (Middle)	 (Far)	<input type="radio"/>	-	-
		 (Near)			

■ Door lock (→P. 108, 116, 564)

Function	Default setting	Customized setting	①	②	③
Unlocking using mechanical key	Driver's door unlocked in one step, all doors unlocked in two steps	All doors unlocked in one step	-	-	<input type="radio"/>
Automatic door locking function	Shift position linked door locking operation	Off	-	<input type="radio"/>	<input type="radio"/>
		Speed linked door locking operation			
Automatic door unlocking function	Shift position linked door unlocking operation	Off	-	<input type="radio"/>	<input type="radio"/>
		Driver's door linked door unlocking operation			

■ BSM (Blind Spot Monitor) (→P. 374)

Function	Default setting	Customized setting	①	②	③
BSM (Blind Spot Monitor)	On	Off	○	-	-

■ Smart access system with push-button start and wireless remote control (→P. 108, 126)

Function	Default setting	Customized setting	①	②	③
Operation buzzer volume	Level 5	Off	-	○	○
		Level 1 to 7			
Operation signal (buzzer)	On	Off	-	-	○
Operation signal (emergency flashers)	On	Off	-	○	○
Time elapsed before the automatic door lock function is activated if a door is not opened after being unlocked	60 seconds	Off	-	○	○
		30 seconds			
		120 seconds			
Open door warning buzzer (when locking the vehicle)	On	Off	-	-	○

■ Smart access system with push-button start (→P. 126)

Function	Default setting	Customized setting	①	②	③
Smart door unlocking	Driver's door	All the doors	-	○	○
Smart access system with push-button start	On	Off	-	○	-
Number of consecutive door lock operations	2 times	As many as desired	-	-	○

■ Wireless remote control (→P. 104)

Function	Default setting	Customized setting	①	②	③
Wireless remote control	On	Off	-	-	○
Unlocking operation	Driver's door unlocked in one step, all doors unlocked in two steps	All doors unlocked in one step	-	○	○
Panic function	On	Off	-	-	○
Glass hatch opening operation	Push and hold (Short)	Push twice	-	-	○
		One short push			
		Push and hold (Long)			
		Off			

■ Automatic light control system (→P. 213)

Function	Default setting	Customized setting	①	②	③
Time elapsed before headlights automatically turn off after doors are closed	30 seconds	Off			
		60 seconds	-	○	○
		90 seconds			
Light sensor sensitivity	Standard	-2 to 2	-	○	○
Daytime running light system	On	Off*	-	○	○
Welcome lighting illumination control	On	Off	-	-	○

*: Except for Canada

■ Interior lights (→P. 420)

Function	Default setting	Customized setting	①	②	③
Time elapsed before the interior lights turn off	15 seconds	Off			
		7.5 seconds	-	○	○
		30 seconds			
Operation after the engine switch is turned to OFF	On	Off	-	-	○
Operation when the doors are unlocked with the smart access system with push-button start or wireless remote control	On	Off	-	-	○
Operation when you approach the vehicle with the electronic key on your person	On	Off	-	-	○
Shift lever light	On	Off	-	-	○
Footwell lighting	On	Off	-	-	○
Lounge illumination control	On	Off	-	-	○

■ Exterior lights (→P. 420)

Function	Default setting	Customized setting	①	②	③
Time elapsed before the running board lights turn off	15 seconds	Off	-	○	○
		7.5 seconds			
		30 seconds			
Operation of the running board lights when the doors are unlocked with the smart access system with push-button start or wireless remote control	On	Off	-	-	○
Operation of the running board lights when you approach the vehicle with the electronic key on your person	On	Off	-	-	○
Running board lights	On	Off	-	-	○
Operation of the running board lights when the door is opened	On	Off	-	-	○

■ Front automatic air conditioning system (→P. 402)

Function	Default setting	Customized setting	①	②	③
A/C automatic mode switch operation	Auto	Manual	-	○	○
Exhaust gas sensor sensitivity*	Standard	-3 to 3	-	○	○

*: If equipped

■ Driving position memory (→P. 145)

Function	Default setting	Customized setting	①	②	③
Driver's seat movement when exiting the vehicle	Full	Off	-	○	○
		Partial			
Selecting the door linking driving position memory with door unlock operation	Driver's door	All doors	-	-	○

■ Seat belt reminder buzzer (→P. 535)

Function	Default setting	Customized setting	①	②	③
Speed-linked seat belt reminder function	On	Off	-	-	○

■ Rear seat reminder (→P. 114)

Function	Default setting	Customized setting	①	②	③
Rear seat reminder function	On	Off	○	-	-

■ Power windows (→P. 160) and moon roof (→P. 163)

Function	Default setting	Customized setting	①	②	③
Mechanical key linked operation (close)	Off	On	-	-	○
Mechanical key linked operation (open)	Off	On	-	-	○
Wireless remote control linked operation (open)	Off	On	-	-	○
Wireless remote control linked operation signal (buzzer)	On	Off	-	-	○

■ Intuitive parking assist* (→P. 267)

Function	Default setting	Customized setting	①	②	③
Intuitive parking assist	On	Off	○	-	-
Buzzer volume	Level 2	Level 1 to 3	○	-	○
Detection distance of the front center sensor	Far	Near	-	-	○
Detection distance of the rear center sensor	Far	Near	-	-	○

*: If equipped

■ Alarm (→P. 77)

Function	Default setting	Customized setting	①	②	③
Deactivates the alarm when the doors are unlocked using the mechanical key*	On	Off	-	-	○

*: The default setting varies according to country.

■ In the following situations, customize mode will automatically be turned off.

- A warning message appears after the customize mode screen is displayed.
- The engine switch is turned to OFF.
- The vehicle begins to move while the customize mode screen is displayed.



WARNING

■ During customization

As the engine needs to be running during customization, ensure that the vehicle is parked in a place with adequate ventilation. In a closed area such as a garage, exhaust gases including harmful carbon monoxide (CO) may collect and enter the vehicle. This may lead to death or a serious health hazard.



NOTICE

■ During customization

To prevent battery discharge, ensure that the engine is running while customizing features.

Items to initialize

The following item must be initialized for normal system operation after such cases as the battery being reconnected, or maintenance being performed on the vehicle:

Item	When to initialize	Reference
Message indicating maintenance is required ^{*1}	After the maintenance is performed	P. 465
Oil maintenance		P. 478
Tire pressure warning system	<ul style="list-style-type: none"> • When rotating the tires • When the tire inflation pressure is changed by changing tire size. (When there are multiple specified pressures) • After registering the ID codes 	P. 490
Power window	When functioning abnormally	P. 161
Moon roof		P. 164
Multi-terrain Monitor ^{*2}	After reconnecting or changing the battery	P. 349

*1: U.S.A. only

*2: If equipped

Reporting safety defects for U.S. owners.....	612
Reporting safety defects for Canadian owners.....	613
Seat belt instructions for Canadian owners (in French).....	614
SRS airbag instructions for Canadian owners (in French).....	616
Headlight aim instructions for Canadian owners (in French).....	624

Reporting safety defects for U.S. owners

If you believe that your vehicle has a defect which could cause a crash or could cause injury or death, you should immediately inform the National Highway Traffic Safety Administration (NHTSA) in addition to notifying the Lexus Division of Toyota Motor Sales, U.S.A., Inc. (Toll-free: 1-800-25-LEXUS).

If NHTSA receives similar complaints, it may open an investigation, and if it finds that a safety defect exists in a group of vehicles, it may order a recall and remedy campaign. However, NHTSA cannot become involved in individual problems between you, your dealer, or Lexus Division of Toyota Motor Sales, U.S.A., Inc.

To contact NHTSA, you may call the Vehicle Safety Hotline toll-free at 1-888-327-4236 (TTY: 1-800-424-9153); go to <http://www.safercar.gov>; or write to: Administrator, NHTSA, 1200 New Jersey Ave. SE., Washington, DC 20590. You can also obtain other information about motor vehicle safety from <http://www.safercar.gov>.

Reporting safety defects for Canadian owners

Canadian customers who wish to report a safety-related defect to Transport Canada, Defects Investigations and Recalls, may telephone the toll-free hotline 1-800-333-0510, mail Transport Canada - ASFAD, 330 Sparks Street,

Ottawa, ON, K1A 0N5, or complete the online form at <https://www.tc.gc.ca/recalls>.

Seat belt instructions for Canadian owners (in French)

The following is a French explanation of seat belt instructions extracted from the seat belt section in this manual.

See the seat belt section for more detailed seat belt instructions in English.

Utilisation adéquate des ceintures de sécurité

- Tirez sur la ceinture épaulière jusqu'à ce qu'elle recouvre entièrement l'épaule; elle ne doit cependant pas toucher le cou ni glisser de l'épaule.
- Placez la ceinture abdominale le plus bas possible sur les hanches.
- Réglez la position du dossier. Tenez-vous assis bien au fond du siège, le dos droit.
- Ne vrillez pas la ceinture de sécurité.

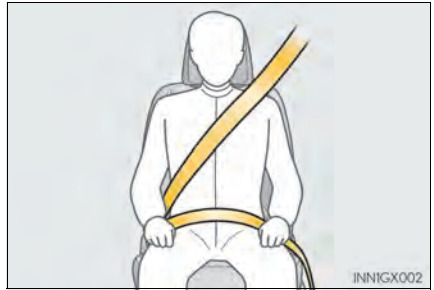

Entretien et soin

■ Ceintures de sécurité

Avec un chiffon ou une éponge, nettoyez à l'aide d'un savon doux et de l'eau tiède. Vérifiez aussi les ceintures régulièrement pour vous assurer qu'elles ne présentent pas d'usure excessive, d'effilochage ou de coupures.



AVERTISSEMENT

■ Dommages et usure de la ceinture de sécurité

Vérifiez périodiquement le système de ceintures de sécurité. Vérifiez qu'il n'y a pas de coupures, d'effilochures ni de pièces desserrées. N'utilisez pas une ceinture de sécurité endommagée avant qu'elle ne soit remplacée. Une ceinture de sécurité endommagée ne peut pas protéger les occupants contre des blessures graves, voire mortelles.

SRS airbag instructions for Canadian owners (in French)

The following is a French explanation of SRS airbag instructions extracted from the SRS airbag section in this manual.

See the SRS airbag section for more detailed SRS airbag instructions in English.

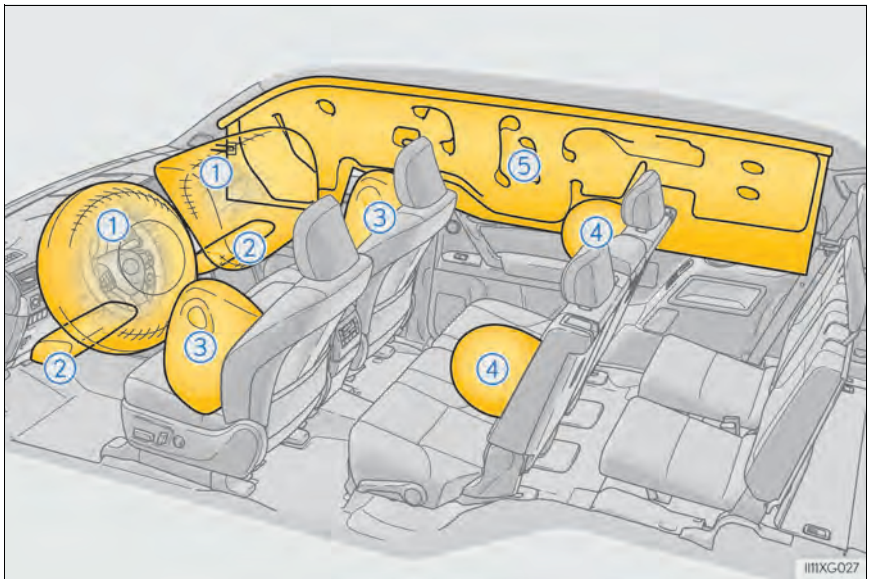

◆ Coussins gonflables SRS avant

- ① Coussin gonflable SRS du conducteur/coussin gonflable SRS du passager avant
Peuvent aider à protéger la tête et la poitrine du conducteur et du passager avant contre les impacts avec des composants intérieurs
- ② Coussins gonflables SRS de protection des genoux
Peuvent aider à protéger le conducteur et le passager avant

◆ Coussins gonflables SRS latéraux et en rideau

- ③ Coussins gonflables SRS latéraux avant
Peuvent aider à protéger le torse des occupants des sièges avant
- ④ Coussins gonflables SRS latéraux arrière
Peuvent aider à protéger le torse des occupants des sièges latéraux de la deuxième rangée de sièges (modèles à 7 passagers) ou des sièges de la deuxième rangée (modèles à 6 passagers)
- ⑤ Coussins gonflables SRS en rideau
 - Peuvent aider à protéger principalement la tête des occupants des sièges latéraux
 - Peuvent aider à empêcher les occupants d'être éjectés du véhicule en cas de tonneaux

Composants du système de coussins gonflables SRS

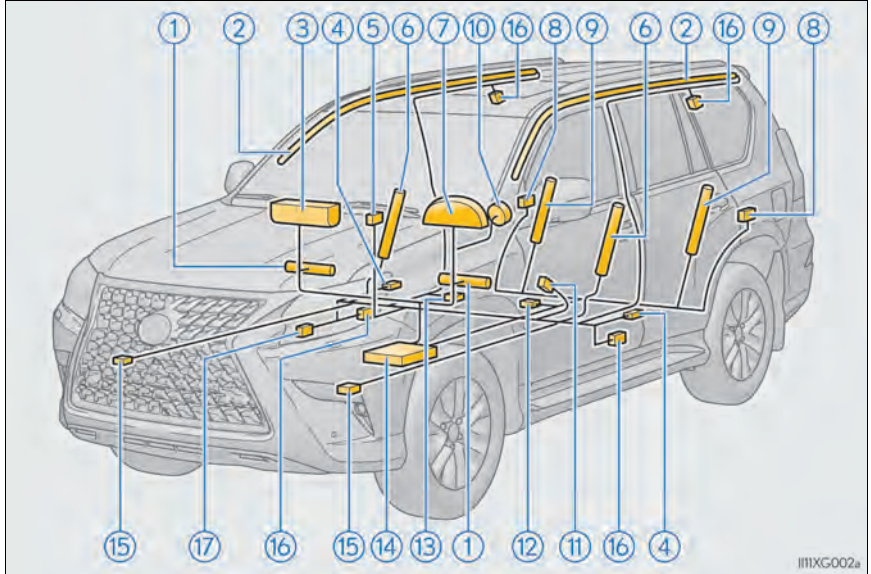

III1XG002a

- | | |
|--|--|
| ① Coussins gonflables de protection des genoux | ⑩ Coussin gonflable du conducteur |
| ② Coussins gonflables en rideau | ⑪ Contacteur de boucle de ceinture de sécurité du conducteur |
| ③ Coussin gonflable du passager avant | ⑫ Capteur de sûreté (arrière) |
| ④ Capteurs d'impact latéral (portière avant) | ⑬ Contacteur de boucle de ceinture de sécurité du passager avant |
| ⑤ Voyants "PASSENGER AIR BAG" | ⑭ Module de capteur de coussin gonflable |
| ⑥ Coussins gonflables latéraux avant | ⑮ Capteurs d'impact avant |
| ⑦ Lampe témoin SRS | ⑯ Limiteurs de force et dispositifs de tension des ceintures de sécurité |
| ⑧ Capteurs d'impact latéral (arrière) | ⑰ Système de classification de l'occupant du siège du passager avant (ECU et capteurs) |
| ⑨ Coussins gonflables latéraux arrière (sièges latéraux de la deuxième rangée de sièges [modèles à 7 passagers] ou sièges de la deuxième rangée [modèles à 6 passagers]) | |

Votre véhicule est doté de COUSSINS GONFLABLES ÉVOLUÉS dont la conception s'appuie sur les normes de sécurité des véhicules à moteur américains (FMVSS208). Le module de capteur de coussin gonflable (ECU) contrôle le déploiement des coussins gonflables en fonction des informations obtenues des capteurs et d'autres éléments affichés dans le diagramme des composants du système ci-dessus. Ces informations comprennent des données relatives à la gravité de l'accident et aux occupants. Au moment du déploiement des coussins gonflables, une réaction chimique se produit dans les gonfleurs de coussin gonflable et les coussins gonflables se remplissent rapidement d'un gaz non toxique pour aider à limiter le mouvement des occupants.



AVERTISSEMENT

■ Précautions relatives aux coussins gonflables SRS

Observez les précautions suivantes en ce qui concerne les coussins gonflables SRS. Négliger de le faire pourrait occasionner des blessures graves, voire mortelles.

- Le conducteur et tous les passagers du véhicule doivent porter leur ceinture de sécurité de la manière appropriée. Les coussins gonflables SRS sont des dispositifs supplémentaires qui doivent être utilisés avec les ceintures de sécurité.

- Le coussin gonflable SRS du conducteur se déploie avec une force considérable et peut occasionner des blessures graves, voire mortelles, notamment lorsque le conducteur se trouve très près du coussin gonflable. La National Highway Traffic Safety Administration (NHTSA), aux États-Unis, fait les recommandations suivantes :

La zone à risque du coussin gonflable du conducteur couvre 2 à 3 in. (50 à 75 mm) de la zone de déploiement du coussin gonflable. Pour assurer une marge de sécurité suffisante, restez à 10 in. (250 mm) du coussin gonflable. Cette distance est mesurée depuis le centre du volant jusqu'à votre sternum. Si maintenant vous vous tenez assis à moins de 10 in. (250 mm), vous pouvez changer votre position de conduite de plusieurs manières :

- Reculez votre siège à la position maximale vous permettant d'atteindre encore aisément les pédales.
- Inclinez légèrement le dossier du siège. Bien que les véhicules soient conçus différemment, la plupart des conducteurs peuvent maintenir une distance de 10 in. (250 mm), même si leur siège se trouve complètement vers l'avant, simplement en inclinant un peu le dossier du siège vers l'arrière. Si la visibilité avant est moindre après avoir incliné le dossier de votre siège, utilisez un coussin ferme et non glissant pour être assis plus haut ou relevez le siège si cette option est disponible sur votre véhicule.
- Si votre volant est réglable en hauteur, inclinez-le vers le bas. Cela vous permet d'orienter le coussin gonflable vers votre buste plutôt que vers votre tête et vers votre cou.

Le siège doit être réglé de la manière recommandée ci-dessus par la NHTSA, tout en gardant le contrôle des pédales et du volant, ainsi que la vue sur les commandes du tableau de bord.

⚠ AVERTISSEMENT

■ Précautions relatives aux coussins gonflables SRS

- Si la rallonge de ceinture de sécurité a été reliée à la boucle des ceintures de sécurité des sièges avant sans avoir aussi été attachée à la plaque de blocage des ceintures de sécurité, les coussins gonflables SRS avant considéreront que le conducteur et le passager avant portent tout de même leur ceinture de sécurité même si les ceintures de sécurité ne sont pas attachées. Les coussins gonflables SRS avant peuvent alors ne pas s'activer correctement lors d'une collision, ce qui pourrait occasionner des blessures graves, voire mortelles, en cas de collision. Assurez-vous de toujours porter la ceinture de sécurité avec la rallonge de ceinture de sécurité.



- Le coussin gonflable SRS du passager avant se déploie également avec une force considérable et peut occasionner des blessures graves, voire mortelles, notamment lorsque le passager avant se trouve très près du coussin gonflable. Le siège du passager avant doit se trouver le plus loin possible du coussin gonflable et le dossier doit être réglé de manière à ce que le passager avant soit assis bien droit.
- Le déploiement d'un coussin gonflable risque d'infliger des blessures graves, voire mortelles, aux bébés et aux enfants mal assis et/ou mal attachés. Un bébé ou un enfant trop petit pour utiliser une ceinture de sécurité doit être correctement retenu à l'aide d'un dispositif de retenue pour enfants. Lexus recommande vivement de placer et d'attacher correctement tous les bébés et tous les enfants sur les sièges arrière du véhicule à l'aide de dispositifs de retenue adaptés. Les sièges arrière sont plus sécuritaires pour les bébés et les enfants que le siège du passager avant.
- N'installez jamais un dispositif de retenue pour enfants de type dos à la route sur le siège du passager avant, même si le voyant "PASSENGER AIR BAG OFF" est allumé. En cas d'accident, la force et la vitesse de déploiement du coussin gonflable du passager avant pourraient infliger à l'enfant des blessures graves, voire mortelles, si le dispositif de retenue pour enfants de type dos à la route était installé sur le siège du passager avant.

⚠ AVERTISSEMENT

■ Précautions relatives aux coussins gonflables SRS

- Ne vous asseyez pas sur le bord du siège et ne vous appuyez pas sur la planche de bord.



- Ne laissez pas un enfant se tenir face au coussin gonflable SRS du passager avant ni s'asseoir sur les genoux d'un passager avant.



- Ne laissez pas les occupants des sièges avant tenir des objets sur leurs genoux.

- Ne vous appuyez pas sur la portière ou sur le brancard de pavillon, ni sur les montants avant, latéraux ou arrière.



- Ne laissez personne s'agenouiller face à la portière sur les sièges des passagers ni sortir la tête ou les mains à l'extérieur du véhicule.



- Ne fixez et n'appuyez rien sur des zones telles que la planche de bord, le tampon de volant ou encore la partie inférieure du tableau de bord.

Ces objets peuvent se transformer en projectiles lorsque les coussins gonflables SRS du conducteur, du passager avant et de protection des genoux se déploient.

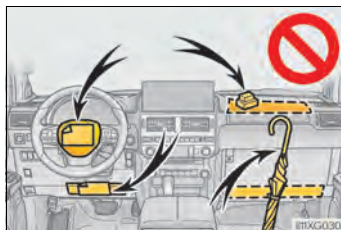



AVERTISSEMENT

■ Précautions relatives aux coussins gonflables SRS

- Ne fixez rien sur des zones telles que les portières, le pare-brise, les glaces de portières, les montants avant ou arrière, le brancard de pavillon et la poignée de maintien.

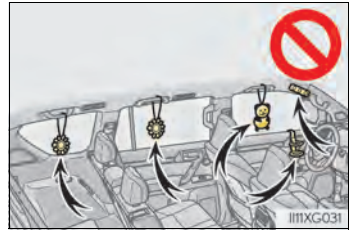

- N'accrochez pas de cintres ni d'autres objets rigides sur les crochets porte-vêtements. Tous ces objets pourraient se transformer en projectiles et vous occasionner des blessures graves, voire mortelles, en cas de déploiement des coussins gonflables SRS en rideau.
- Si un recouvrement de vinyle est placé sur la zone de déploiement du coussin gonflable SRS de protection des genoux, veillez à le retirer.
- N'utilisez pas d'accessoires recouvrant les parties du siège où les coussins gonflables SRS latéraux se déploient, car ces accessoires pourraient entraver le déploiement des coussins gonflables SRS. De tels accessoires peuvent empêcher les coussins gonflables latéraux de se déployer correctement, rendre le système inopérant ou provoquer accidentellement le déploiement des coussins gonflables latéraux, occasionnant des blessures graves, voire mortelles.
- Ne frappez pas et n'appliquez pas une pression importante à l'emplacement des composants des coussins gonflables SRS. Cela peut provoquer un mauvais fonctionnement des coussins gonflables SRS.
- Ne touchez à aucun composant des coussins gonflables SRS immédiatement après leur déploiement (gonflage), car ils pourraient être chauds.
- Si vous avez de la difficulté à respirer après le déploiement des coussins gonflables SRS, ouvrez une portière ou une glace pour laisser entrer l'air frais, ou quittez le véhicule si vous pouvez le faire en toute sécurité. Dès que possible, nettoyez tous les résidus afin d'éviter les irritations cutanées.
- Si les emplacements de stockage des coussins gonflables SRS, tels que le tampon de volant et les garnitures des montants avant et arrière, sont endommagés ou fissurés, faites-les remplacer par votre concessionnaire Lexus.
- Ne placez aucun objet, par exemple un coussin, sur le siège du passager avant. Cela disperserait le poids du passager, ce qui empêcherait le capteur de le détecter correctement. Cela pourrait empêcher le déploiement des coussins gonflables SRS du passager avant en cas de collision.

**AVERTISSEMENT****■ Modification et mise au rebut des composants du système de coussins gonflables SRS**

Ne mettez pas votre véhicule au rebut et n'effectuez aucune des modifications suivantes sans d'abord consulter votre concessionnaire Lexus. Les coussins gonflables SRS pourraient fonctionner de manière incorrecte ou se déployer (gonfler) accidentellement, ce qui serait susceptible d'occasionner des blessures graves, voire mortelles.

- Installation, retrait, démontage et réparation des coussins gonflables SRS
- Réparations, modifications, retrait ou remplacement du volant, du tableau de bord, de la planche de bord, des sièges ou du capitonnage des sièges, des montants avant, latéraux et arrière ou des brancards de pavillon
- Réparations ou modifications de l'aile avant, du pare-chocs avant ou du côté de l'habitacle
- Installation d'une protection de calandre (barre safari, barre kangourou, etc.), de lames de déneigement, de treuils ou d'un porte-bagages de toit
- Modifications du système de suspension du véhicule
- Installation d'appareils électroniques tels qu'un émetteur-récepteur radio ou un lecteur de CD
- Modifications à votre véhicule pour une personne aux capacités physiques réduites

Headlight aim instructions for Canadian owners (in French)

The following is a French explanation of headlight aim instructions from the headlight aim section in this manual.

Boulons de réglage vertical

- ① Boulon de réglage A
- ② Boulon de réglage B

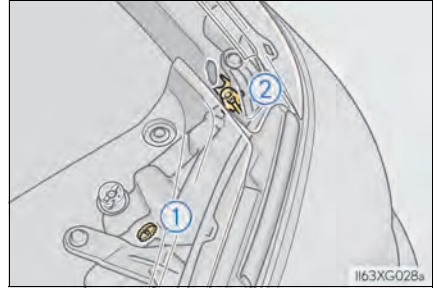

Avant de vérifier la portée des phares

- 1 Assurez-vous que le réservoir de carburant du véhicule est plein et que la partie de carrosserie située autour des phares n'est pas déformée.
- 2 Garez le véhicule sur un sol parfaitement horizontal.
- 3 Asseyez-vous sur le siège du conducteur.
- 4 Faites rebondir le véhicule à plusieurs reprises.

Réglage de la portée des phares

- 1** Tournez le boulon A vers la droite ou vers la gauche à l'aide d'un tournevis cruciforme.

Retenez le sens de rotation et le nombre de tours.

► Côté gauche

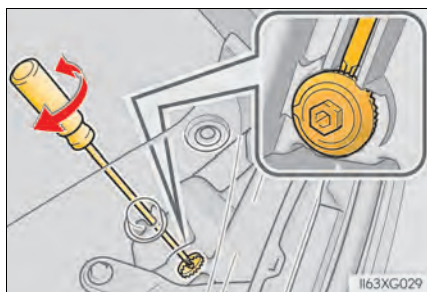

► Côté droit

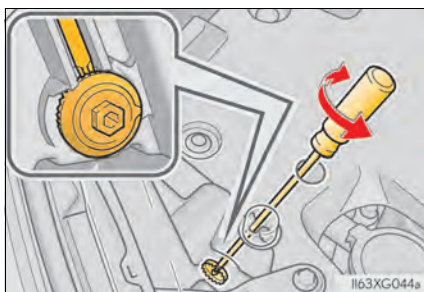

- 2** Tournez le boulon B du même nombre de tours et dans le même sens qu'à l'étape **1**.

Si vous n'arrivez pas à régler vos phares en suivant cette procédure, apportez le véhicule chez votre concessionnaire Lexus afin qu'il règle la portée des phares.

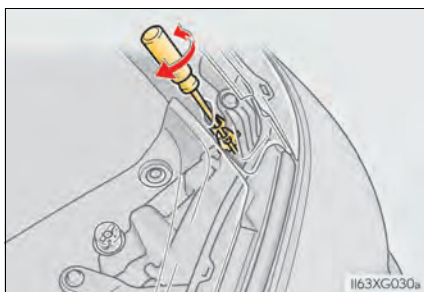

Index

What to do if... (Troubleshooting).....	628
Alphabetical index.....	632

For vehicles with navigation system, refer to the “NAVIGATION SYSTEM OWNER’S MANUAL” for information regarding the equipment listed below.

- Navigation system
- Audio/video system
- Hands-free system (for cellular phone)
- Lexus Enform

What to do if... (Troubleshooting)

If you have a problem, check the following before contacting your Lexus dealer.

The doors cannot be locked, unlocked, opened or closed



You lose your keys

- If you lose your mechanical keys, new genuine mechanical keys can be made by your Lexus dealer. (→P. 105)
- If you lose your electronic keys, the risk of vehicle theft increases significantly. Contact your Lexus dealer immediately. (→P. 107)



The doors cannot be locked or unlocked

- Is the electronic key battery weak or depleted? (→P. 507)
- Is the engine switch in IGNITION ON mode?
When locking the doors, turn the engine switch off. (→P. 201)
- Is the electronic key left inside the vehicle?
When locking the doors, make sure that you have the electronic key on your person.
- The function may not operate properly due to the condition of the radio wave. (→P. 128)



The rear door cannot be opened

- Is the child-protector lock set?
The rear door cannot be opened from inside the vehicle when the lock is set. Open the rear door from outside and then unlock the child-protector lock. (→P. 111)

If you think something is wrong



The engine does not start

- Did you press the engine switch while firmly depressing the brake pedal? (→P. 200)
- Is the shift lever in P? (→P. 200)
- Is the electronic key anywhere detectable inside the vehicle? (→P. 127)
- Is the steering wheel unlocked? (→P. 203)
- Is the electronic key battery weak or depleted?
In this case, the engine can be started in a temporary way. (→P. 565)
- Is the battery discharged? (→P. 567)



The shift lever cannot be shifted from P even if you depress the brake pedal

- Is the engine switch in IGNITION ON mode?
If you cannot release the shift lever by depressing the brake pedal with the engine switch in IGNITION ON mode (→P. 209)



The steering wheel cannot be turned after the engine is stopped

- It is locked automatically to prevent theft of the vehicle. (→P. 202)



The windows do not open or close by operating the power window switches

- Is the window lock switch pressed?
The power window except for the one at the driver's seat cannot be operated if the window lock switch is pressed. (→P. 160)



The engine switch is turned off automatically

- The auto power off function will be operated if the vehicle is left in ACCESSORY or IGNITION ON mode (the engine is not running) for a period of time. (→P. 202)



A warning buzzer sounds during driving

- The seat belt reminder light is flashing
Are the driver and the front passenger wearing the seat belts?
(→P. 537)
- The parking brake indicator is on
Is the parking brake released? (→P. 212)

Depending on the situation, other types of warning buzzer may also sound.
(→P. 535, 544)



An alarm is activated and the horn sounds

- Did anyone inside the vehicle open a door during setting the alarm?
The sensor detects it and the alarm sounds. (→P. 77)

To stop the alarm, turn the engine switch to IGNITION ON mode or start the engine.

**A warning buzzer sounds when leaving the vehicle**

- Is the electronic key left inside the vehicle or the moon roof opened?
Check the message on the multi-information display. (→P. 544)

**A warning light turns on or a warning message is displayed**

- When a warning light turns on or a warning message is displayed, refer to P. 535, 544.

When a problem has occurred**If you have a flat tire**

- Stop the vehicle in a safe place and replace the flat tire with the spare tire.
(→P. 548)

**The vehicle becomes stuck**

- Try the procedure for when the vehicle becomes stuck in mud, dirt, or snow.
(→P. 573)

Alphabetical index

A

A/C	402, 414
Air conditioning filter	505
ABS (Anti-lock Brake System)	368
Function	368
Warning light	536
Active Traction Control	369
Air conditioning filter	505
Air conditioning system	402, 414
Air conditioning filter	505
Micro dust and pollen filter	409
Airbags	36
Airbag operating conditions	44
Airbag precautions	
for your child	39
Airbag warning light	535
Correct driving posture	28
Curtain shield airbag	
operating conditions	44
Curtain shield airbag	
precautions	39
General airbag precautions	39
Locations of airbags	36
Modification and	
disposal of airbags	43
Side airbag operating	
conditions	44
Side airbag precautions	39
Side and curtain shield airbags	
operating conditions	44
Side and curtain shield airbags	
precautions	39
SRS airbags	36
SRS warning light	535
Alarm	
Alarm	77
Warning buzzer	535

Anchor brackets	58
Antennas (smart access system	
with push-button start)	126
Anti-lock brake system (ABS)	368
Function	368
Warning light	536
Armrest	448
Assist grip	449
Audio input *	
Audio system *	
Automatic headlight	
leveling system	215
Automatic High Beam	216
Automatic light control system	214
Automatic transmission	206
If the shift lever cannot be	
shifted from P	209
S mode	207
AUX port *	
Auxiliary boxes	429, 432
AVS	356

B

Back door	116
Back-up lights	
Replacing light bulbs	519
Wattage	585
Battery	484
Battery checking	484
If the vehicle battery is	
discharged	567
Preparing and checking	
before winter	387
Warning light	535
Bluetooth®*	

Bottle holders.....427

Brake

- Fluid.....583
- Parking brake.....212
- Warning light535

Brake assist368

Break-in tips.....170

Brake Override System.....169

Brightness control

- Instrument panel light control89

BSM (Blind Spot Monitor)..... 374

- The Blind Spot Monitor function.....377
- The Rear Cross Traffic Alert function.....380

C

Care.....458, 461

- Aluminum wheels458
- Exterior.....458
- Interior461
- Seat belts462

Cargo hooks431

Cargo net hooks.....432

Center differential.....357

Center display399

CD player*

Chains.....388

Child restraint system..... 54

- Booster seats, definition55
- Booster seats, installation.....65
- Convertible seats, definition.....55
- Convertible seats, installation.....62

- Installing child restraint system with LATCH system.....60
- Installing child restraint system with seat belts.....62
- Installing child restraint system with top tether strap.....66
- Infant seats, definition.....55
- Infant seats, installation.....62

Child safety..... 53

- Airbag precautions.....39
- Back door precautions.....118
- Battery precautions485, 569
- Child restraint system.....54
- Glass hatch precaution123
- How your child should wear the seat belt.....32
- Installing child restraints58
- Moon roof precautions166
- Power window lock switch.....160
- Power window precautions.....162
- Rear door child-protectors111
- Removed key battery precautions508
- Seat belt precautions33
- Seat heater precautions417

Child-protectors111

Cleaning

- Aluminum wheels.....458
- Exterior458
- Interior461
- Seat belts.....462

Clock.....441

Coat hooks449

Condenser.....481

Console box.....424

Cool box.....438

*: Refer to the "NAVIGATION SYSTEM OWNER'S MANUAL".

Cooling system	479
Engine overheating.....	570
Conversation mirror	441
Crawl Control	361
Cruise control	
Dynamic radar cruise control....	255
Cup holders.....	426
Curtain shield airbags	36
Current fuel consumption	93
Customizable features.....	600

D

DAC (Downhill Assist Control system).....	365
Daytime running light system.....	214
Defogger	
Front windshield.....	408
Outside rear view mirrors.....	409
Rear window	409
Dial	
Multi-terrain Select mode selector dial	292
Differential.....	581
Dimension	576
Display	
Drive information	93
Multi-information display	91
Warning message.....	544
Do-it-yourself maintenance.....	471
Doors.....	108
Back door.....	116
Door glasses	160
Door lock	108
Open door warning light.....	537
Outside rear view mirrors.....	157
Rear door child-protector.....	111
Drive information	93

Drive-Start Control.....	170
Driver's seat position memory.....	145
Driving.....	168
AVS switch.....	356
Break-in tips	170
Correct posture	28
Procedures.....	168
Winter drive tips	387
Dynamic radar cruise control.....	255

E

Eco Driving Indicator	96
EDR (Event data recorder).....	10
Electronic key.....	104
Battery-saving function	128
If the electronic key does not operate properly.....	564
Replacing the battery	507
Emergency, in case of	
If the electronic key does not operate properly.....	564
If the engine will not start	562
If the vehicle has discharged battery.....	567
If the vehicle is submerged or water on the road is rising.....	526
If the warning buzzer sounds.....	535
If the warning light turns on.....	535
If you have a flat tire.....	548
If you lose your keys.....	105, 107
If you think something is wrong.....	533
If your vehicle becomes stuck.....	573
If your vehicle needs to be towed.....	528
If your vehicle overheats.....	570

Emergency flashers.....524

Engine

Accessory mode.....201

Brake Override System169

Compartment.....475

Drive-Start Control.....170

Hood.....474

How to start the engine.....200

Identification number578

If the engine will not start.....562

Ignition switch (engine switch)...200

Overheating.....570

Engine compartment cover476

Engine coolant.....479

Capacity580

Checking.....479

Preparing and checking
before winter387

Engine immobilizer system76

Engine oil477

Capacity578

Checking.....477

Preparing and checking
before winter387

Warning message.....546

Engine oil maintenance data478

Engine switch.....200

Engine switch light420

Event data recorder (EDR).....10

F

Flat tire.....548

Floor mats.....26

Fluid

Automatic transmission.....582

Brake.....583

Steering.....584

Washer.....487

Fog lights.....220

Replacing light bulbs520

Switch.....220

Four-wheel drive system.....357

Front passenger occupant

classification system47

Front passenger's seat belt

reminder light537

Front seats.....132

Adjustment.....132

Cleaning.....461

Correct driving posture.....28

Driving position memory.....145

Head restraints150

Seat heaters.....418

Seat position memory145

Front turn signal lights211

Replacing light bulbs516

Turn signal lever211

Wattage585

Fuel.....	578
Capacity.....	578
Fuel gauge.....	88
Fuel pump shut off system.....	534
Information.....	586
Refueling.....	228
Type.....	578, 586
Warning light.....	537
Fuel consumption information.....	98
Fuel filler door.....	228
Refueling.....	228
Fuel gauge.....	88
Fuel pump shut off system.....	534
Fuses.....	509

G

Garage door opener.....	450
Gauges.....	88
Glass hatch.....	121
Glove box.....	424

H

Hands-free system (for cellular phone)*	
Head restraints.....	150
Headlights.....	213
Light switch.....	213
Replacing light bulbs.....	520
Headlights cleaner.....	227
Heaters	
Automatic air conditioning system.....	402, 414
Seat heaters.....	418
Outside rear view mirrors.....	409
Height control.....	352
Hill-start assist control.....	369

Hood.....	474
Hooks	
Cargo hooks.....	431, 432
Coat hooks.....	449
Retaining hooks (floor mat).....	26
Horn.....	153

I

I/M test.....	470
Identification	
Engine.....	578
Vehicle.....	577
Ignition switch (engine switch).....	200
Ignition switch light.....	420
Illuminated entry system.....	422
Immobilizer system.....	76
Indicators.....	82
Initialization	
Items to initialize.....	609
Maintenance data.....	465, 478
Moon roof.....	164
Power windows.....	161
Tire pressure warning system.....	490
Inside rear view mirror.....	155
Instrument panel light control.....	89
Interior lights.....	420
Switch.....	421
Wattage.....	585
Intuitive parking assist.....	267

J

Jack	
Vehicle-equipped jack.....	549
Jack handle.....	552
Jam protection function	
Moon roof.....	164
Power windows.....	161

K

Keyless entry	
Smart access system with	
push-button start	126
Wireless remote control	104
Keys.....	104
Battery-saving function.....	128
Electronic key	104
If the electronic key does not	
operate properly.....	564
If you lose your keys	105, 107
Key number plate	104
Keyless entry	108, 116, 126
Mechanical key	105
Replacing the battery	507
Wireless remote control	104
KDSS.....	369
Warning light	536

L

Lane Departure Alert (LDA)	247
Lever	
Auxiliary catch lever	474
Hood lock release lever	474
Shift lever	206
Turn signal lever	211
Wiper lever	221
Lexus Enform Safety Connect.....	71
Lexus parking assist monitor	277
Lexus Safety System +	232
Automatic High Beam	216
Dynamic radar cruise control.....	255
LDA (Lane Departure Alert).....	247
PCS (Pre-Collision System).....	237

License plate lights	213
Light switch.....	213
Replacing light bulbs	520

Light

Engine switch light.....	420
Fog light switch.....	220
Headlight switch	213
Illuminated entry system.....	422
Interior light.....	421
Interior light list.....	420
Personal light	421
Replacing light bulbs	514
Turn signal lever	211
Vanity lights.....	440
Wattage	585
Welcome lighting.....	215

Light bulbs

Replacing.....	514
Wattage	585
Lock steering column.....	202
Luggage cover	433

*: Refer to the "NAVIGATION SYSTEM OWNER'S MANUAL".

M

Maintenance	
Do-it-yourself maintenance.....	471
Maintenance data.....	576
Maintenance requirements.....	464
Resetting the message indicating maintenance is required.....	465
Malfunction indicator lamp.....	535
Meter	
Indicators.....	82
Instrument panel light control.....	89
Meters.....	88
Multi-information display.....	91
Warning lights.....	82
Micro dust and pollen filter.....	409
Mirrors	
Inside rear view mirror.....	155
Outside rear view mirror defoggers.....	409
Outside rear view mirrors.....	157
Vanity mirrors.....	440
Moon roof.....	163
Jam protection function.....	164
Operation.....	163
MP3 disc*	
Multi-information display.....	91
BSM (Blind Spot Monitor).....	374
Crawl Control.....	361
Display contents.....	91
Drive information.....	93
Dynamic radar cruise control.....	255
Intuitive parking assist.....	268
Language.....	601
LDA (Lane Departure Alert).....	250
Multi-terrain Select.....	292
Warning message.....	544

Multi-terrain Monitor.....	296
Multi-terrain Select.....	292

N

Navigation system*	
--------------------	--

O

Odometer.....	88
Off-road precautions.....	390
Oil	
Engine oil.....	578
Front differential oil.....	581
Rear differential oil.....	581
Transfer.....	582
Opener	
Back door.....	117
Fuel filler door.....	230
Hood.....	474
Outside rear view mirrors.....	157
Adjusting and folding.....	157
Blind Spot Monitor.....	374
Outside rear view mirror defoggers.....	409
Outside temperature display.....	88
Overheating, Engine.....	570

P

Parking assist sensors (intuitive parking assist).....	267
Parking brake.....	212
Operation.....	212
Parking brake engaged warning buzzer.....	212
Parking lights	
Light switch.....	213
Replacing light bulbs.....	520

Personal lights.....	420
Switch.....	421
Wattage.....	585
Power outlet.....	442
Power windows.....	160
Jam protection function.....	161
Operation.....	160
Window lock switch.....	160
Pre-Collision System (PCS).....	237
Enabling/disabling the system.....	240
Function.....	237
Warning light.....	536

R

Radiator.....	481
Radio*	
Rear seat.....	134
Adjustment.....	134
Rear turn signal lights.....	211
Replacing light bulbs.....	517
Turn signal lever.....	211
Wattage.....	585
Rear view mirror	
Inside rear view mirror.....	155
Outside rear view mirrors.....	157
Rear window defogger.....	409
Rear window wiper.....	225
Refueling.....	228
Capacity.....	578
Fuel types.....	578
Opening the fuel tank cap.....	230
Remote touch.....	396

Replacing

Electronic key battery.....	507
Fuses.....	509
Light bulbs.....	514
Tires.....	548
Wireless remote control battery.....	507
Reporting safety defects for U.S. owners.....	612
Reset the maintenance data.....	465

S

Safety connect.....	71
Seat belts.....	30
Adjusting the seat belt.....	31
Automatic Locking Retractor.....	32
Child restraint system installation.....	58
Cleaning and maintaining the seat belt.....	462
Emergency Locking Retractor.....	32
How to wear your seat belt.....	28
How your child should wear the seat belt.....	32
Pregnant women, proper seat belt use.....	33
Reminder light and buzzer.....	537
Seat belt pretensioners.....	31
Seat belt extender.....	32
SRS warning light.....	535

*: Refer to the "NAVIGATION SYSTEM OWNER'S MANUAL".

- Seat heaters..... 418
- Seat ventilators..... 419
- Seat position memory..... 145
- Seats..... 132, 134
 - Adjustment..... 132, 134
 - Adjustment precautions..... 133, 144
 - Child seats/child restraint
 - system installation..... 58
 - Cleaning..... 461
 - Driving position memory..... 145
 - Head restraint..... 150
 - Properly sitting in the seat..... 28
 - Seat position memory..... 145
 - Ventilators..... 419
- Sensor
 - Automatic headlight system..... 214
 - Automatic High Beam system..... 216
 - Inside rear view mirror..... 156
 - Intuitive parking assist-sensor..... 267
 - LDA (Lane Departure Alert)..... 247
 - Radar sensor..... 233
 - Rain-sensing windshield
 - wipers..... 223
- Service reminder indicators..... 82
- Shift lever
 - Automatic transmission..... 206
 - If the shift lever cannot be
 - shifted from P..... 209
- Shift lock system..... 208
- Side airbags..... 36
- Side mirrors..... 157
 - Adjusting and folding..... 157
 - Blind Spot Monitor..... 374
- Side turn signal lights..... 211
 - Replacing light bulbs..... 520
 - Turn signal lever..... 211
- Smart access system with
 - push-button start..... 126
 - Antenna location..... 126
 - Starting the engine..... 200
- Snow tires..... 389
- Spare tire..... 548
 - Inflation pressure..... 584
 - Storage location..... 549
- Spark plug..... 580
- Specifications..... 576
- Speedometer..... 88
- Steering lock
 - Column lock release..... 203
- Steering wheel..... 153
 - Adjustment..... 153
 - Audio switches*.....
 - Heated steering wheel..... 417
 - Steering wheel position
 - memory..... 145
- Stop/tail lights
 - Replacing light bulbs..... 520
- Storage feature..... 423
- Stuck
 - If the vehicle becomes stuck..... 573
- Sunshade
 - Roof..... 164
- Sun visors..... 440
- Switch
 - Automatic High Beam switch..... 216
 - AVS switch..... 356
 - BSM (Blind Spot Monitor)
 - switch..... 375
 - Center differential lock/
 - unlock switch..... 358

Crawl Control ON/OFF
switch..... 361

Crawl Control speed selector
dial..... 361

Cruise control switch..... 255

“DAC” switch..... 365

Door lock switches 110

Driving position memory
switches..... 145

Emergency flashers switch 524

Engine switch..... 200

Fog light switch 220

Four-wheel drive control
switch..... 357

Headlight cleaner switch 227

Height control OFF switch..... 352

Height control switch..... 352

LDA (Lane Departure Alert)..... 249

Light switches 213

Moon roof switches..... 163

Multi-terrain Select mode
selector dial 292

Multi-terrain Monitor switch 296

“ODO TRIP” button..... 89

Outside rear view mirror
switches 157

Parking assist..... 267

Power door lock switch 116

Power window switch 160

Rear window wiper and
washer switch..... 225

Rear window and outside
rear view mirror
defoggers switch..... 409

Second start mode switch..... 207

Seat heater switches..... 418

Talk switch*

Tilt and telescopic steering
control switch..... 153

Vehicle-to-vehicle distance
switch 261

VSC OFF switch..... 370

Window lock switch 160

Windshield wipers and
washer switch 221

T

Tachometer 88

Tail lights 213
Light switch..... 213
Replacing light bulbs 520

Talk switch*

Telephone switch*

Theft deterrent system
Alarm..... 77
Engine immobilizer system 76

Tire inflation pressure..... 499
Maintenance data..... 584

Tire pressure warning system..... 489
Function..... 489
Initializing..... 489
Initializing procedures..... 490
Installing tire pressure warning
valves and transmitters..... 489
Registering ID codes..... 491
Warning light..... 537

Tires 488
Chains 387
Checking..... 488
If you have a flat tire..... 548
Inflation pressure..... 499

*: Refer to the “NAVIGATION SYSTEM OWNER’S MANUAL”.

Information	589
Replacing	548
Rotating tires	488
Size.....	584
Snow tires	387
Spare tire.....	548
Tire pressure warning system	489
Tools.....	549
Towing	
Dinghy towing.....	199
Emergency towing.....	529
Towing hooks	530
Trailer Sway Control.....	369
Trailer towing	181
Trailer Sway Control.....	369
TRAC (Traction Control).....	368
Transmission	
Automatic transmission.....	206
AVS switch	356
If the shift lever cannot be shifted from P	209
Trip meters	88
Turn signal lights	211
Replacing light bulbs.....	516, 517, 520
Turn signal lever	211
Wattage.....	585

U

USB port*

V

Vanity lights	
Vanity lights.....	440
Wattage	585
Vanity mirrors.....	440
Vehicle identification number	577
VSC (Vehicle Stability Control)....	368

W

Warning buzzers	535
Brake system	535
Downshifting.....	209
Intuitive parking assist.....	270
LDA (Lane Departure Alert).....	247
Open back door.....	114
Open door	114
Pre-collision warning.....	237
Radar cruise control	262
Seat belt reminder	537
Warning lights	535
ABS	536
Brake Override System.....	538
Brake system	535
Charging system	535
Drive-Start Control	538
High coolant temperature	535
KDSS.....	536
Low engine oil pressure	535
Low fuel level.....	537
Malfunction indicator lamp.....	535
Open door	537
Parking brake indicator	536
PCS	536
Seat belt reminder light	537
Slip indicator	536
SRS.....	535
Tire pressure warning light.....	537

Warning message.....	544
Warning reflector holder.....	431
Washer.....	221
Checking.....	487
Preparing and checking	
before winter.....	387
Switch.....	221
Washing and waxing.....	458
Weight	
Cargo capacity.....	180
Load limits.....	180
Weight.....	576
Wheels.....	503
Replacing wheels.....	548
Size.....	584
Window glasses.....	160
Window lock switch.....	160
Windows	
Power windows.....	160
Rear window defogger.....	409
Windshield wipers.....	221
Rain-sensing windshield	
wipers.....	222
Windshield wiper de-icer.....	409
Winter driving tips.....	387
Wireless remote control.....	104
Battery-Saving Function.....	128
Locking/Unlocking.....	104
Replacing the battery.....	507
WMA disc*	

X

XM® Satellite Radio*

*: Refer to the "NAVIGATION SYSTEM OWNER'S MANUAL".

Certifications

Lexus Enform Safety Connect

- ▶ For vehicles sold in the U.S.A., Canada and Puerto Rico

FCC ID: JOYDA39

NOTE

This device complies with part 15 of the FCC Rules. Operation is subject to the following two conditions: (1) This device may not cause harmful interference, and (2) this device must accept any interference received, including interference that may cause undesired operation.

FCC WARNING

Changes or modifications not expressly approved by the party responsible for compliance could void the user's authority to operate the equipment.

Co-location: This transmitter must not be co-located or operated in conjunction with any other antenna or transmitter.

CAUTION : Radio Frequency Radiation Exposure

This equipment complies with FCC radiation exposure limits set forth for an uncontrolled environment and meets the FCC radio frequency (RF) Exposure Guidelines. This equipment should be installed and operated keeping the radiator at least 20cm or more away from person's body.

IC: 574B-DA39

NOTE

This device contains licence-exempt transmitter(s)/receiver(s) that comply with Innovation, Science and Economic Development Canada's licence-exempt RSS(s). Operation is subject to the following two conditions:

- (1) This device may not cause interference.
- (2) This device must accept any interference, including interference that may cause undesired operation of the device.

The antenna cannot be removed (and changed) by user.

Co-location: This transmitter must not be co-located or operated in conjunction with any other antenna or transmitter.

CAUTION: Radio Frequency Radiation Exposure

This equipment complies with ISED radiation exposure limits set forth for an uncontrolled environment and meets RSS-102 of the ISED radio frequency (RF) Exposure rules. This equipment should be installed and operated keeping the radiator at least 20 cm or more away from person's body.

NOTE

L'émetteur/récepteur exempt de licence contenu dans le présent appareil est conforme aux CNR d'Innovation, Sciences et Développement économique Canada applicables aux appareils radio exempts de licence. L'exploitation est autorisée aux deux conditions suivantes :

- (1) L'appareil ne doit pas produire de brouillage;
- (2) L'appareil doit accepter tout brouillage radioélectrique subi, même si le brouillage est susceptible d'en compromettre le fonctionnement.

L'utilisateur n'est pas autorisé à retirer (ou modifier) l'antenne.

Emplacement: Cet émetteur ne doit pas être installé ou utilisé conjointement avec d'autres antennes ou émetteurs.

ATTENTION : exposition aux radiofréquences

Cet équipement est conforme aux limites d'exposition aux rayonnements ISDE établies pour un environnement non contrôlé et satisfait à la norme CNR-102 de la réglementation ISDE sur l'exposition aux radiofréquences (RF). Cet équipement doit être installé et utilisé avec un minimum de 20 cm de distance entre la source de rayonnement et le corps.

Engine immobilizer system

- For vehicles sold in the U.S.A., Hawaii, Guam, Saipan and Puerto Rico

FCC ID: NI4TMIMB-3

This device complies with part 15 of the FCC Rules. Operation is subject to the following two conditions: (1) This device may not cause harmful interference, and (2) this device must accept any interference received, including interference that may cause undesired operation.

Changes or modifications not expressly approved by the party responsible for compliance could void the user's authority to operate the equipment.

- For vehicles sold in Canada

This device complies with Industry Canada's licence-exempt RSSs. Operation is subject to the following two conditions: (1) This device may not cause interference; and (2) This device must accept any interference, including interference that may cause undesired operation of the device.

Le présent appareil est conforme aux CNR d'Industrie Canada applicables aux appareils radio exempts de licence. L'exploitation est autorisée aux deux conditions suivantes : 1) l'appareil ne doit pas produire de brouillage; 2) l'utilisateur de l'appareil doit accepter tout brouillage radioélectrique subi, même si le brouillage est susceptible d'en compromettre le fonctionnement.

Smart access system with push-button start

- ▶ For vehicles sold in the U.S.A., Hawaii, Guam, Saipan and Puerto Rico

FCC ID:HYQ23ABL

FCC ID:HYQ14FBZ

NOTE:

This device complies with part 15 of the FCC Rules. Operation is subject to the following two conditions: (1) This device may not cause harmful interference, and (2) this device must accept any interference received, including interference that may cause undesired operation.

FCC WARNING:

Changes or modifications not expressly approved by the party responsible for compliance could void the user's authority to operate the equipment.

<For 14FBZ>

The FCC ID is affixed inside the equipment. You can find the ID when replacing the battery.

FCC ID:NI4TMLF12-1

This device complies with part 15 of the FCC Rules. Operation is subject to the following two conditions: (1) This device may not cause harmful interference, and (2) this device must accept any interference received, including interference that may cause undesired operation.

Changes or modifications not expressly approved by the party responsible for compliance could void the user's authority to operate the equipment.

- For vehicles sold in Canada

NOTE:

This device contains licence-exempt transmitter(s)/receiver(s) that comply with Innovation, Science and Economic Development Canada's licence-exempt RSS(s).

Operation is subject to the following two conditions:

- (1) This device may not cause interference.
- (2) This device must accept any interference, including interference that may cause undesired operation of the device.

<For 14FBZ>

The IC Certification number is affixed inside the equipment. You can find the number when replacing the battery.

NOTE:

L'émetteur/récepteur exempt de licence contenu dans le présent appareil est conforme aux CNR d'Innovation, Sciences et Développement économique Canada applicables aux appareils radio exempts de licence.

L'exploitation est autorisée aux deux conditions suivantes :

- (1) L'appareil ne doit pas produire de brouillage;
- (2) L'appareil doit accepter tout brouillage radioélectrique subi, même si le brouillage est susceptible d'en compromettre le fonctionnement.

<Pour 14FBZ>

Le numéro d'accréditation IC est apposé à l'intérieur de l'appareil. Ce numéro est visible au remplacement de la pile.

This device complies with Industry Canada's licence-exempt RSSs. Operation is subject to the following two conditions: (1) This device may not cause interference; and (2) This device must accept any interference, including interference that may cause undesired operation of the device.

Le présent appareil est conforme aux CNR d'Industrie Canada applicables aux appareils radio exempts de licence. L'exploitation est autorisée aux deux conditions suivantes : 1) l'appareil ne doit pas produire de brouillage; 2) l'utilisateur de l'appareil doit accepter tout brouillage radioélectrique subi, même si le brouillage est susceptible d'en compromettre le fonctionnement.

Millimeter wave radar sensor

- ▶ For vehicles sold in the U.S.A., Hawaii, Guam, Puerto Rico and Saipan

FCC ID: HYQDNMWR008

NOTE:

This device complies with part 15 of the FCC Rules. Operation is subject to the following two conditions: (1) This device may not cause harmful interference, and (2) this device must accept any interference received, including interference that may cause undesired operation.

FCC WARNING:

Changes or modifications not expressly approved by the party responsible for compliance could void the user's authority to operate the equipment.

Radiofrequency radiation exposure Information:

This equipment complies with FCC radiation exposure limits set forth for an uncontrolled environment. This equipment should be installed and operated with minimum distance of 20 cm between the radiator (antenna) and your body. This transmitter must not be co-located or operating in conjunction with any other antenna or transmitter.

- For vehicles sold in Canada

NOTE:

This device contains licence-exempt transmitter(s)/receiver(s) that comply with Innovation, Science and Economic Development Canada's licence-exempt RSS(s). Operation is subject to the following two conditions:

- (1) This device may not cause interference.
- (2) This device must accept any interference, including interference that may cause undesired operation of the device.

This equipment complies with ISED radiation exposure limits set forth for an uncontrolled environment and meets RSS-102 of the ISED radio frequency (RF) Exposure rules. This equipment should be installed and operated keeping the radiator at least 20 cm or more away from person's body.

NOTE:

L'émetteur/récepteur exempt de licence contenu dans le présent appareil est conforme aux CNR d'Innovation, Sciences et Développement économique Canada applicables aux appareils radio exempts de licence. L'exploitation est autorisée aux deux conditions suivantes :

- 1) L'appareil ne doit pas produire de brouillage;
- 2) L'appareil doit accepter tout brouillage radioélectrique subi, même si le brouillage est susceptible d'en compromettre le fonctionnement.

Cet équipement est conforme aux limites d'exposition aux rayonnements énoncées pour un environnement non contrôlé et respecte les règles d'exposition aux fréquences radioélectriques (RF) CNR-102 de l'ISDE. Cet équipement doit être installé et utilisé en gardant une distance de 20 cm ou plus entre le dispositif rayonnant et le corps.

Blind Spot Monitor

- ▶ For vehicles sold in the U.S.A., Hawaii, Guam, Puerto Rico and Saipan

FCC ID : OAYSRR3A

This device complies with part 15 of the FCC Rules. Operation is subject to the following two conditions:

- (1) This device may not cause harmful interference, and
- (2) this device must accept any interference received, including interference that may cause undesired operation.

FCC Warning

Changes or modifications not expressly approved by the party responsible for compliance could void the user's authority to operate the equipment.

C3-002

► For vehicles sold in Canada

This device contains licence-exempt transmitter(s)/receiver(s) that comply with Innovation, Science and Economic Development Canada's licence-exempt RSS(s). Operation is subject to the following two conditions:

1. This device may not cause interference.
2. This device must accept any interference, including interference that may cause undesired operation of the device.

Radiofrequency radiation exposure information:

This equipment complies with radiation exposure limits set forth for an uncontrolled environment. This equipment should be installed and operated with minimum distance of 20 cm between the radiator and your body.

C3-005

L'émetteur/récepteur exempt de licence contenu dans le présent appareil est conforme aux CNR d'Innovation, Sciences et Développement économique Canada applicables aux appareils radio exempts de licence. L'exploitation est autorisée aux deux conditions suivantes:

1. L'appareil ne doit pas produire de brouillage;
2. L'appareil doit accepter tout brouillage radioélectrique subi, même si le brouillage est susceptible d'en compromettre le fonctionnement.

Informations sur l'exposition aux rayonnements radiofréquences:

Cet équipement est conforme aux limites d'exposition aux rayonnements définies pour un environnement non contrôlé. Cet équipement doit être installé et utilisé avec un minimum de 20 cm de distance entre la source de rayonnement et votre corps.

C3-006

Garage door opener

► For vehicles sold in the U.S.A., Hawaii, Guam, Saipan and Puerto Rico

This device complies with FCC rules part 15 and Innovation, Science, and Economic Development Canada RSS-210. Operation is subject to the following two conditions: (1) This device may not cause harmful interference, and (2) This device must accept any interference that may be received including interference that may cause undesired operation. WARNING: The transmitter has been tested and complies with FCC and ISED rules. Changes or modifications not expressly approved by the party responsible for compliance could void the user's authority to operate the device.

This equipment complies with FCC and ISED radiation exposure limits set forth for an uncontrolled environment. End Users must follow the specific operating instructions for satisfying RF exposure compliance. This transmitter must be at least 20 cm from the user and must not be co-located or operating in conjunction with any other antenna or transmitter.

► For vehicles sold in Canada

This device complies with FCC rules part 15 and Innovation, Science, and Economic Development Canada RSS-210. Operation is subject to the following two conditions: (1) This device may not cause harmful interference, and (2) This device must accept any interference that may be received including interference that may cause undesired operation. WARNING: The transmitter has been tested and complies with FCC and ISED rules. Changes or modifications not expressly approved by the party responsible for compliance could void the user's authority to operate the device.

This equipment complies with FCC and ISED radiation exposure limits set forth for an uncontrolled environment. End Users must follow the specific operating instructions for satisfying RF exposure compliance. This transmitter must be at least 20 cm from the user and must not be co-located or operating in conjunction with any other antenna or transmitter.

Cet appareil est conforme aux règlements de la FCC, section 15, et au CNR-210 d'Innovation, Sciences et Développement économique Canada. Le fonctionnement est assujéti aux deux conditions suivantes : (1) cet appareil ne doit pas causer d'interférences nuisibles et (2) cet appareil doit accepter toute interférence reçue, y compris celle qui pourrait entraîner un dysfonctionnement. MISE EN GARDE : L'émetteur a subi des tests et est conforme aux règlements de la FCC et d'ISDE. Les changements ou modifications non approuvés explicitement par la partie responsable de la conformité pourraient rendre caduque l'autorisation de l'utilisateur de se servir du dispositif.

Cet appareil est conforme aux limites d'exposition aux radiations de la FCC et d'ISDE établies pour un environnement non contrôlé. Les utilisateurs finaux doivent respecter les instructions d'utilisation spécifiques pour satisfaire aux exigences de conformité aux expositions de RF. L'émetteur doit se trouver à 20 cm au minimum de l'utilisateur et ne doit pas être situé au même endroit que tout autre émetteur ou antenne ni fonctionner avec un autre émetteur ou antenne.

Tire pressure warning system

- ▶ For vehicles sold in the U.S.A., Hawaii, Guam, Saipan, Puerto Rico

FCC ID: PAXPMVE000

NOTE

This device complies with part 15 of the FCC Rules. Operation is subject to the following two conditions:
(1) This device may not cause harmful interference, and (2) this device must accept any interference received, including interference that may cause undesired operation.

FCC WARNING

Changes or modifications not expressly approved by the party responsible for compliance could void the user's authority to operate the equipment.

FCC ID: PAXPMVE100

NOTE

This device complies with part 15 of the FCC Rules. Operation is subject to the following two conditions:
(1) This device may not cause harmful interference, and (2) this device must accept any interference received, including interference that may cause undesired operation.

FCC WARNING

Changes or modifications not expressly approved by the party responsible for compliance could void the user's authority to operate the equipment.

"Perchlorate Material – special handling may apply, See www.dtsc.ca.gov/hazardouswaste/perchlorate."

- ▶ For vehicles sold in Canada

NOTE

This device complies with Industry Canada licence-exempt RSS standard(s). Operation is subject to the following two conditions: (1) this device may not cause interference, and (2) this device must accept any interference, including interference that may cause undesired operation of the device.

NOTE

Le présent appareil est conforme aux CNR d'Industrie Canada applicables aux appareils radio exempts de licence. L'exploitation est autorisée aux deux conditions suivantes : (1) l'appareil ne doit pas produire de brouillage, et (2) l'utilisateur de l'appareil doit accepter tout brouillage radioélectrique subi, même si le brouillage est susceptible d'en compromettre le fonctionnement.

GAS STATION INFORMATION

Auxiliary catch lever

P. 474

Fuel filler door

P. 230

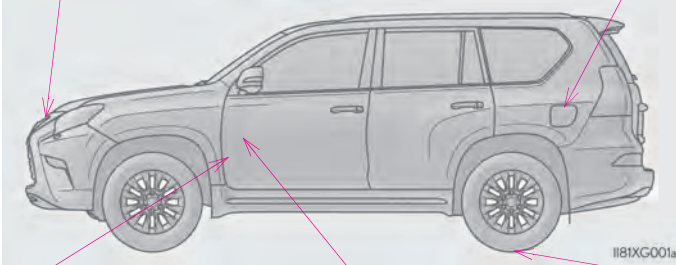

Hood lock release lever

P. 474

Fuel filler door opener

P. 230

Tire inflation pressure

P. 584

Fuel tank capacity
(Reference)

23.0 gal. (87 L, 19.1 Imp.gal.)

Fuel type

Unleaded gasoline with a Octane Rating of 91 or higher
(Research Octane Number 96)

P. 578, 586

Cold tire inflation
pressure

P. 584

Engine oil capacity
(Drain and refill –
reference)

With filter
Without filter

8.2 qt. (7.8 L, 6.9 Imp.qt.)
7.8 qt. (7.4 L, 6.5 Imp.qt.)

Engine oil type

“Toyota Genuine Motor Oil” or equivalent

P. 578



Owner's Manual:

Publication No. OM60U05U

Part No. 01999-60U05

Printed in Japan 01-2108-00 

GX 460 (北米U)