



FOREWORD

Dear Customer,

Thank you for selecting your new Kia vehicle.

As a global car manufacturer focused on building high-quality vehicles with exceptional value, Kia is dedicated to providing you with a customer service experience that exceeds your expectations.

An authorized Kia dealership where factory-trained technicians, recommended special tools, and genuine Kia replacement parts are provided can help if you need technical assistance.

This Owner's Manual will acquaint you with the operation of features and equipment that are either standard or optional on this vehicle, along with the maintenance needs of this vehicle. Therefore, you may find some descriptions and illustrations not applicable to your vehicle. You are advised to read this publication carefully and follow the instructions and recommendations. Please always keep this manual in the vehicle for your, and any subsequent owner's, reference.

All information contained in this Owner's Manual was accurate at the time of publication. However, as Kia continues to make improvements to its products, the company reserves the right to make changes to this manual or any of its vehicles at any time without notice and without incurring any obligations.

Please drive safely, and enjoy your Kia vehicle!

© 2021 Kia Canada Inc.

All rights reserved. Reproduction by any means, electronic or mechanical, including photocopying, recording, or by any information storage and retrieval system or translation in whole or part is not permitted without written authorization from Kia Canada Inc.

Printed in Korea

How to use this manual

We want to help you get the greatest possible driving pleasure from your vehicle. Your Owner's Manual can assist you in many ways.

We strongly recommend that you read the entire manual. In order to minimize the chance of death or injury, you must read the WARNING and CAUTION sections in the manual.

Illustrations complement the words in this manual to best explain how to enjoy your vehicle. By reading your manual, you learn about features, important safety information, and driving tips under various road conditions.

The general layout of the manual is provided in the Table of Contents. Use the index when looking for a specific area or subject, it has an alphabetical listing of all information in your manual.

Chapters: This manual has nine chapters plus an index. Each chapter begins with a brief list of contents so you can tell at a glance if that chapter has the information you want.

You will find various WARNINGS, CAUTIONS, and NOTICES in this manual. These WARNINGS were prepared to enhance your personal safety. You should carefully read and follow ALL procedures and recommendations provided in these WARNINGS, CAUTIONS and NOTICES.

WARNING

A WARNING indicates a situation in which harm, serious bodily injury or death could result if the warning is ignored.

CAUTION

A CAUTION indicates a situation in which damage to your vehicle could result if the caution is ignored.

NOTICE

A NOTICE indicates interesting or helpful information is being provided.

Table of Contents

Introduction	1
Your vehicle at a glance	2
Safety features of your vehicle	3
Features of your vehicle	4
Driving your vehicle	5
What to do in an emergency	6
Maintenance	7
Specifications & Consumer information	8
Abbreviation	A
Index	I

Fuel requirements	1-2
Vehicle modifications	1-5
Vehicle break-in process	1-5
Risk of burns when parking or stopping vehicle.....	1-6
Vehicle handling instructions	1-6
Vehicle data collection and Event Data Recorders.....	1-7

Introduction

Fuel requirements

Your new vehicle is designed to use only unleaded fuel having a pump octane number $((R+M)/2)$ of 87 (Research Octane Number 91) or higher. (Do not use methanol blended fuels.)

Your new vehicle is designed to obtain maximum performance with UNLEADED FUEL, as well as minimize exhaust emissions and spark plug fouling.

Never add any fuel system cleaning agents to the fuel tank other than what has been specified. (Consult an authorized Kia dealer for details.)

- Tighten the cap until it clicks one time, otherwise the Check Engine light will illuminate.

WARNING

Refueling

- Do not "top off" after the nozzle automatically shuts off. Attempts to force more fuel into the tank can cause fuel overflow onto you and the ground, causing a risk of fire.
- Always check that the fuel cap is installed securely to prevent fuel spillage, especially in the event of an accident.

Gasoline containing alcohol and methanol

Gasohol, a mixture of gasoline and ethanol (also known as grain alcohol), and gasoline or gasohol containing methanol (also known as wood alcohol) are being marketed along with or instead of leaded or unleaded gasoline.

Do not use gasohol containing more than 15% ethanol, and do not use gasoline or gasohol containing any methanol. Either of these fuels may cause drivability problems and damage to the fuel system, engine control system and emission control system.

Discontinue using gasohol of any kind if drivability problems occur.

Vehicle damage or drivability problems may not be covered by the manufacturer's warranty if they result from the use of:

1. Gasoline or gasohol containing methanol.
2. Leaded fuel or leaded gasohol.
3. Gasohol containing more than 15% ethanol.

"E85" fuel is an alternative fuel comprised of 85% ethanol and 15% gasoline, and is manufactured exclusively for use in Flexible Fuel Vehicles. "E85" is not compatible with your vehicle. Use of "E85" may result in poor engine performance

and damage to your vehicle's engine and fuel system. Kia recommends that customers do not use fuel with an ethanol content exceeding 15%.

* NOTICE

Your New Vehicle Limited Warranty does not cover damage to the fuel system or any performance problems caused by the use of "E85" fuel.

* NOTICE

Never use any fuel containing methanol. Discontinue use of any methanol containing products which may inhibit proper drivability.

Other fuels

Using fuels that contain Silicone (Si), MMT (Methylcyclopentadienyl Manganese Tricarbonyl), Manganese (Mn) contained fuel, and other metallic additives, may cause vehicle and engine damage or cause misfiring, poor acceleration, engine stalling, catalyst melting, clogging, abnormal corrosion, life cycle reduction, etc.

Also, the Malfunction Indicator Lamp (MIL) may illuminate.

* NOTICE

Damage to the fuel system or performance problems caused by the use of these other fuels may not be covered by your New Vehicle Limited Warranty.

Use of MTBE

Kia recommends avoiding fuels containing MTBE (Methyl Tertiary Butyl Ether) over 15.0% vol. (Oxygen Content 2.7% weight) in your vehicle.

Fuel containing MTBE over 15.0% vol. (Oxygen Content 2.7% weight) may reduce vehicle performance and produce vapor lock or hard starting.

* NOTICE

Your New Vehicle Limited Warranty may not cover damage to the fuel system and any performance problems that are caused by the use of fuels containing methanol or fuels containing MTBE (Methyl Tertiary Butyl Ether) over 15.0% vol. (Oxygen Content 2.7% weight.)

Gasoline containing MMT

Some gasoline contains harmful manganese-based fuel additives such as MMT (Methylcyclopentadienyl Manganese Tricarbonyl). Kia does not recommend the use of gasoline containing MMT. This type of fuel can reduce vehicle performance and affect your emission control system. The Malfunction Indicator Lamp (MIL) on the cluster may come on.

Do not use methanol

Fuels containing methanol (wood alcohol) should not be used in your vehicle. This type of fuel can reduce vehicle performance and damage components of the fuel system, engine control system and emission control system.

Fuel Additives

Kia recommends that you use good quality gasolines treated with detergent additives such as TOP TIER Detergent Gasoline, which help prevent deposit formation in the engine. These gasolines will help the engine run cleaner and enhance performance of the emission control system.

For more information on TOP TIER Detergent Gasoline, please go to the website (www.toptiergas.com) For customers who do not use TOP TIER

Detergent Gasoline regularly, and have problems starting or the engine does not run smoothly, additives that you can buy separately may be added to the gasoline.

If TOP TIER Detergent Gasoline is not available, one bottle of additive should be added to the fuel tank at every 13,000 km (8,000 miles) or every engine oil change is recommended. Additives are available from your authorized Kia dealer along with information on how to use them. Do not mix other additives.

Operation in foreign countries

If you are going to drive your vehicle in another country, be sure to:

- Observe all regulations regarding registration and insurance.
- Determine that acceptable fuel is available.

Vehicle modifications

This vehicle should not be modified. Modification of your vehicle could affect its performance, safety or durability and may even violate governmental safety and emissions regulations.

In addition, damage or performance problems resulting from any modification may not be covered under warranty.

- If you use unauthorized electronic devices, it may cause the vehicle to operate abnormally, wire damage, battery discharge and fire. For your safety, do not use unauthorized electronic devices.

Vehicle break-in process

By following a few simple precautions for the first 1,000 km (600 miles) you may add to the performance, economy and life of your vehicle.

- Do not race the engine.
- While driving, keep your engine speed (rpm, or revolutions per minute) between 2,000 rpm and 4,000 rpm.
- Do not maintain a single engine speed for long periods of time, either fast or slow. Varying engine speeds is needed to properly break-in the engine.
- Avoid hard stops, except in emergencies, to allow the brakes to seat properly.
- Don't tow a trailer during the first 2,000 km (1,200 miles) of operation.
- Fuel economy and engine performance may vary depending on vehicle break-in process and be stabilized after 6,000 km (4,000 miles). New engines may consume more oil during the vehicle break-in period.

Risk of burns when parking or stopping vehicle

- Do not park or stop the vehicle near flammable items such as leaves, paper, oil, and tire. Such items placed near the exhaust system can become a fire hazard.
- When an engine idles at a high speed with the rear side of the vehicle touching the wall, heat of the exhaust gas can cause discoloration or fire. Keep enough space between the rear part of the vehicle and the wall.
- Be sure not to touch the exhaust/catalytic systems while engine is running or right after the engine is turned off. There is a risk of burns since the systems are extremely hot.

Vehicle handling instructions

As with other vehicles of this type, failure to operate this vehicle correctly may result in loss of control, an accident or vehicle rollover.

Specific design characteristics (higher ground clearance, track, etc.) give this vehicle a higher center of gravity than other types of vehicles. In other words they are not designed for cornering at the same speeds as conventional 2-wheel drive vehicles.

Avoid sharp turns or abrupt maneuvers. Again, failure to operate this vehicle correctly may result in loss of control, an accident or vehicle rollover.

Be sure to read the "Reducing the risk of a rollover" on page 5-184.

Vehicle data collection and Event Data Recorders

This vehicle is equipped with an Event Data Recorder (EDR). The main purpose of an EDR is to record, in certain crash or near crash-like situations, such as an air bag deployment or hitting a road obstacle, data that will assist in understanding how a vehicle's systems performed. The EDR is designed to record data related to vehicle dynamics and safety systems for a short period of time, typically 30 seconds or less. The EDR in this vehicle is designed to record such data as:

- How various systems in your vehicle were operating;
- Whether or not the driver and passenger safety belts were buckled/fastened;
- How far (if at all) the driver was depressing the accelerator and/or brake pedal; and,
- How fast the vehicle was traveling.

These data can help provide a better understanding of the circumstances in which crashes and injuries occur. NOTE: EDR data are recorded by your vehicle only if a non-trivial crash situation occurs; no data are recorded by the EDR under normal driving conditions and no personal data (e.g., name, gen-

der, age, and crash location) are recorded. However, other parties, such as law enforcement, could combine the EDR data with the type of personally identifying data routinely acquired during a crash investigation.

To read data recorded by an EDR, special equipment is required, and access to the vehicle or the EDR is needed. In addition to the vehicle manufacturer, other parties, such as law enforcement, that have the special equipment, can read the information if they have access to the vehicle or the EDR.

Exterior overview.....	2-2
Interior overview.....	2-4
Instrument panel overview	2-6
Engine compartment	2-8

Your vehicle at a glance

Exterior overview

Front view



OKA4010001N

* The actual shape may differ from the illustration.

- | | |
|----------------------------------|-------------------|
| 1. Hood | 4-66 |
| 2. Head lamp | 4-153, 7-65, 7-66 |
| 3. Front fog lamp | 7-66 |
| 4. Wheel and tire | 7-37, 8-5 |
| 5. Outside rearview mirror | 4-95 |
| 6. Sunroof | 4-73 |
| 7. Front windshield wiper blades | 4-161, 7-30 |
| 8. Windows | 4-61 |
| 9. Front ultrasonic sensor | 4-147 |
| 10. Front radar | 5-61 |

- 11.Front view camera
- 12.Roof rack

- 5-61
- 4-222

Rear view



OKA4010002N

* The actual shape may differ from the illustration.

- | | |
|-------------------------------------|------------------|
| 1. Doors | 4-22 |
| 2. Sliding doors | 4-34 |
| 3. Fuel filler door | 4-68 |
| 4. Rear combination lamp | 7-64, 7-67, 7-69 |
| 5. High mounted stop lamp | 7-69 |
| 6. Rear wiper | 4-161, 7-29 |
| 7. Liftgate | 4-46, 4-49, 4-55 |
| 8. Antenna | 4-224 |
| 9. Rear view camera | 4-135 |
| 10. Rear ultrasonic sensor | 4-143, 4-147 |
| 11. Reversing lamp/Turn signal lamp | 7-68 |

Interior overview

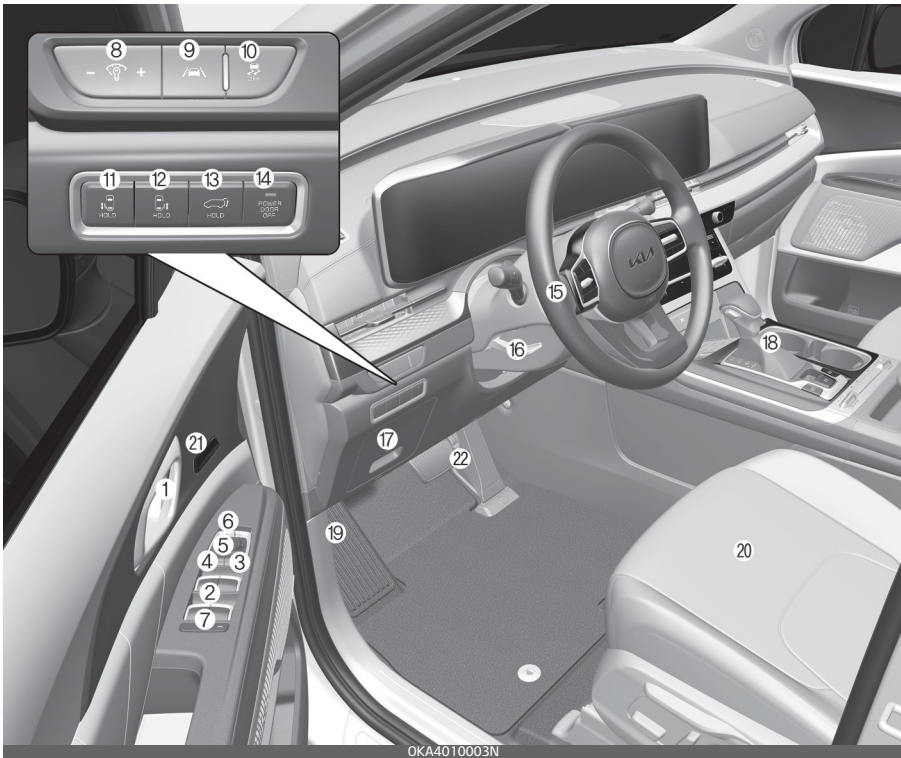

* The actual shape may differ from the illustration.

- | | |
|--|------------------------|
| 1. Inside door handle | 4-25 |
| 2. Power window switch | 4-61 |
| 3. Central door lock switch | 4-25 |
| 4. Central door unlock switch | 4-25 |
| 5. Outside rearview mirror control switch | 4-96 |
| 6. Outside rearview mirror folding switch | 4-96 |
| 7. Power window/sunroof lock button | 4-64, 4-78 |
| 8. Instrument panel illumination control switch | 4-101 |
| 9. Lane Safety button | 5-78 |
| 10. ESC OFF button | 5-39 |
| 11. Power sliding door button (driver's side) | 4-35, 4-41, 4-43 |
| 12. Power sliding door button (passenger's side) | 4-35, 4-41, 4-43 |
| 13. Power liftgate open/close button | 4-41, 4-49, 4-57, 4-55 |

14.Power door ON/OFF button	4-40
15.Steering wheel	4-79
16.Steering wheel tilt/telescopic lever	4-80
17.Instrument fuse panel	7-51
18.Shift lever	5-16
19.Hood release lever	4-66
20.Seat	3-5
21.Seat position memory system	4-31
22.Brake pedal	5-23

Instrument panel overview



OKA4010004N

* The actual shape may differ from the illustration.

- 1. Driver's front air bag 3-71
- 2. Horn 4-83
- 3. Instrument cluster 4-99
- 4. Wiper and washer control lever 4-161
- 5. Light control/turn signals lever 4-153
- 6. ENGINE START/STOP button 5-11
- 7. Driving Assist button 5-123, 5-126
- 8. Infotainment system 4-224
- 9. Hazard warning flasher switch 6-3
- 10. Climate control system 4-174, 4-184
- 11. Shift lever 5-16
- 12. EPB switch 5-25
- 13. Drive mode integrated control system 5-44

14.AUTO HOLD button	5-31
15.Front seat warmer/air ventilation seat switch	4-207, 4-210
16.Steering wheel heater button	4-81
17.Parking Safety button	4-143, 4-147
18.Parking/View button	4-135, 4-138
19.Center console storage box	4-205
20.Glove box	4-205
21.Power outlet	4-213
22.AC Inverter	4-214
23.Passenger's front air bag	3-71
24.Wireless charging system	4-215

Engine compartment

Smartstream G3.5 GDI (Gasoline)

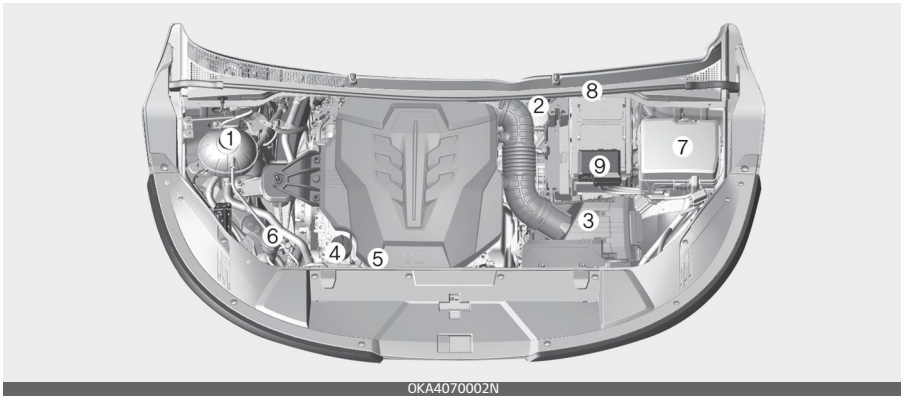

OKA4070002N

* The actual engine room in the vehicle may differ from the illustration.

- | | |
|--------------------------------------|-----------|
| 1. Engine coolant reservoir | 7-20 |
| 2. Brake fluid reservoir | 7-23 |
| 3. Air cleaner | 7-25 |
| 4. Engine oil filler cap | 7-18 |
| 5. Engine oil dipstick | 7-18 |
| 6. Windshield washer fluid reservoir | 7-24 |
| 7. Fuse box | 7-57 |
| 8. Negative battery terminal | 6-6, 7-33 |
| 9. Positive battery terminal | 6-6, 7-33 |

Important safety precautions	3-3
Seat	3-5
• Feature of Seat Leather	3-10
• Front seat adjustment for manual seat	3-10
• Front seat adjustment for power seat	3-12
• Headrest (for front seat)	3-14
• Seatback pocket	3-17
• Rear seat adjustment.....	3-17
• Rear seat adjustment (VIP Lounge Seat).....	3-26
• Headrest (for rear seat).....	3-30
Seat belts	3-33
• Seat belt restraint system	3-33
• Seat belt precautions.....	3-44
• Care of seat belts	3-45
Child Restraint System (CRS)	3-47
• Children always in the rear	3-47
• Selecting a CRS	3-48
• Installing a CRS.....	3-50
Air bag – Advanced Supplemental Restraint System	3-57
• How does the air bag system operate?	3-58
• Air bag warning and indicator	3-60
• Supplemental Restraint System (SRS) components and functions	3-61
• Occupant Detection System (ODS).....	3-64
• Driver's and passenger's front air bag.....	3-71
• Side air bag	3-74
• Curtain air bag	3-75
• Air bag collision sensors	3-77

3 Safety features of your vehicle

- Why didn't my air bag go off in a collision?
(Inflation and non-inflation conditions of the air bag).... 3-78
- Supplemental Restraint System (SRS) care3-82
- Additional safety precautions3-83
- Adding equipment to or modifying your
air bag-equipped vehicle3-84
- Air bag warning labels3-84

Safety features of your vehicle

For the safety of the driver and vehicle passengers, you should become familiar with the vehicle's safety features.

Important safety precautions

You will find many safety precautions and recommendations throughout this section, and throughout this manual.

The safety precautions in this section are among the most important.

Always wear your seat belt

A seat belt is your best protection in all types of accidents. Air bags are designed to supplement seat belts, not replace them. So even though your vehicle is equipped with air bags, ALWAYS make sure you and your passengers always wear their seat belts, and wear them properly.

Restrain all children

All children under age 13 should ride in your vehicle properly restrained in a rear seat, not the front seat. Infants and small children should be restrained in an appropriate child restraint. Larger children should use a booster seat with the lap/shoulder belt until they can use the seat belt properly without a booster seat.

Air bag hazards

While air bags can save lives, they can also cause serious or fatal injuries to occupants who sit too close to them, or who are not properly restrained. Infants, young children, and shorter adults are at the greatest risk of being injured by an inflating air bag. Follow all instructions and warnings in this manual.

Driver distraction

Driver distraction presents a serious and potentially deadly danger, especially for inexperienced drivers. Safety should be the first concern when behind the wheel and drivers need to be aware of the wide array of potential distractions, such as drowsiness, reaching for objects, eating, personal grooming, other passengers, and using cellular phones.

Drivers can become distracted when they take their eyes and attention off the road or their hands off the wheel to focus on activities other than driving. To reduce your risk of distraction or getting into an accident:

- ALWAYS set up your mobile devices (i.e., MP3 players, phones, navigation units, etc.) when your vehicle is parked or safely stopped.

- ONLY use your mobile device when allowed by laws and when conditions permit safe use. NEVER text or email while driving. Most countries have laws prohibiting drivers from texting. Some countries and cities also prohibit drivers from using handheld phones.
- NEVER let the use of a mobile device distract you from driving. You have a responsibility to your passengers and others on the road to always drive safely, with your hands on the wheel as well as your eyes and attention on the road.

Control your speed

Excessive speed is a major factor in crash injuries and deaths. Generally, the higher the speed, the greater the risk, but serious injuries can also occur at lower speeds. Never drive faster than is safe for current driving conditions, regardless of the maximum speed posted.

Keep your vehicle in safe condition

Having a tire blowout or a mechanical failure can be extremely hazardous. To reduce the possibility of such problems, check your tire pressures and conditions frequently, and perform all regularly scheduled maintenance.

Seat

Front seat

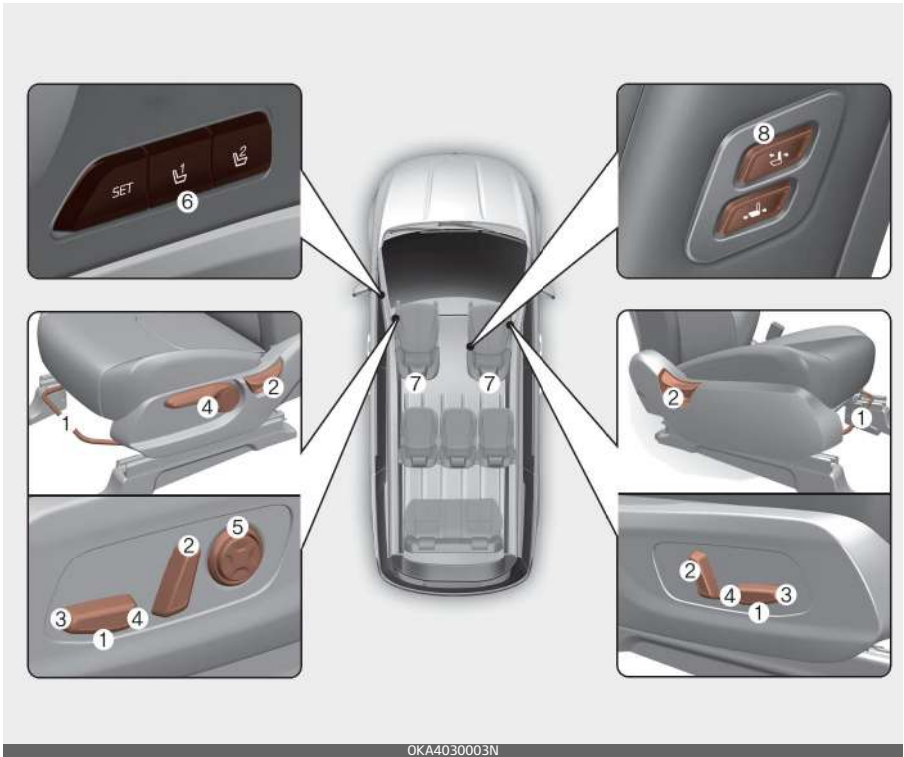

OKA4030003N

* The actual feature in the vehicle may differ from the illustration.

* There is no center seat on rear 2nd row for vehicle with 7 seats.

Front seat

1. Forward and backward
2. Seatback angle
3. Seat cushion tilt
4. Seat cushion height
5. Lumbar support
6. Driver position memory system
7. Headrest
8. Walk-in switch (Passenger's seat)

Rear seat

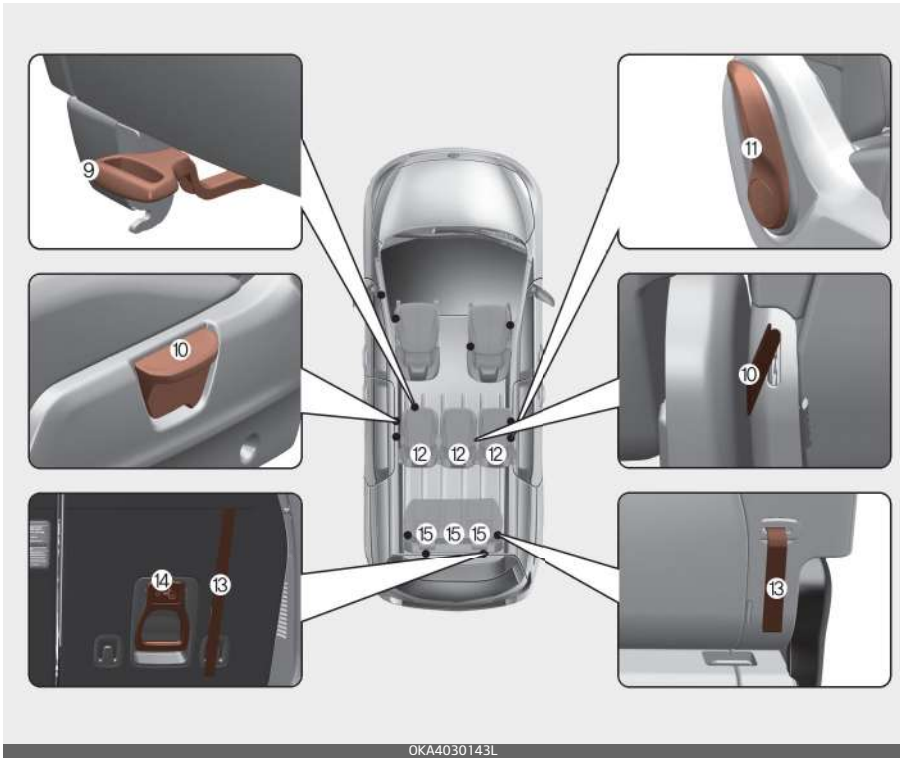

OKA4030143L

* There is no center seat on rear 2nd row for vehicle with 7 seats.

2nd row seat

- 9. Forward and backward
- 10. Seatback angle
- 11. Walk-in lever
- 12. Headrest

3rd row seat

- 13. Seatback angle/folding
- 14. Seat sinking
- 15. Headrest

Rear seat (VIP Lounge Seat) (if equipped)

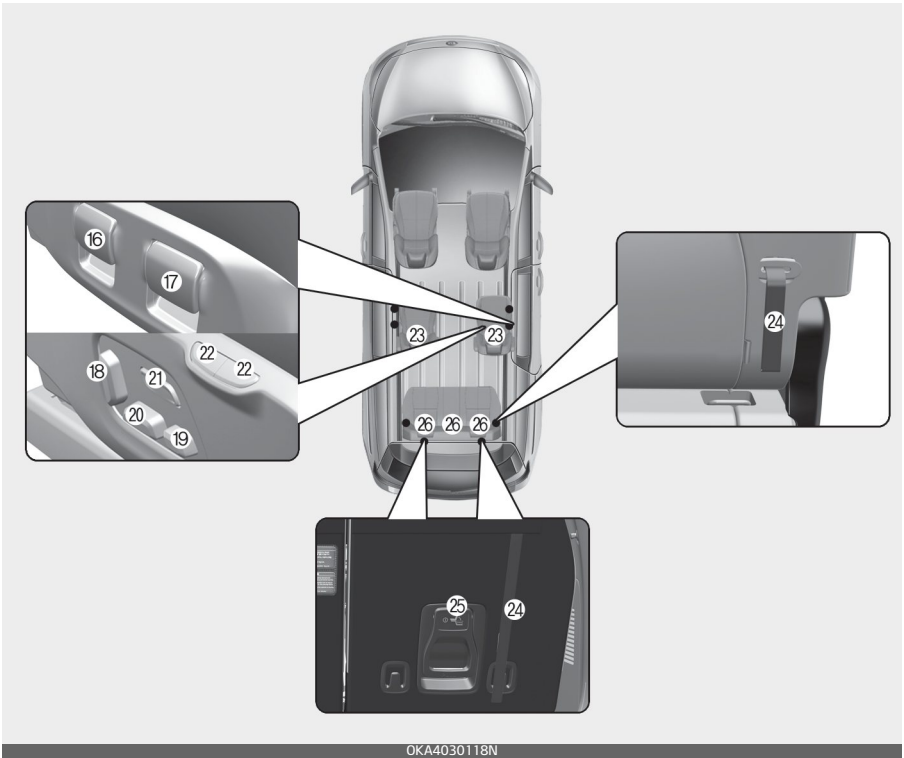

2nd row seat

- 16. Left and right
- 17. Forward and backward
- 18. Seatback angle
- 19. Leg support
- 20. Seat cushion height
- 21. VIP Lounge Seat adjustment
- 22. VIP Lounge Seat one touch
- 23. Headrest

3rd row seat

- 24. Seatback angle/folding
- 25. Seat sinking
- 26. Headrest

⚠ WARNING**Loose objects**

Loose objects in the driver's foot area could interfere with the operation of the foot pedals, possibly causing an accident. Do not place anything under the front seats.

⚠ WARNING**Uprighting seat**

Do not press the release lever on a manual seatback without holding and controlling the seatback. The seatback will spring upright, possibly impacting you or other passengers.

⚠ WARNING**Driver responsibility for passengers**

The driver must advise the passengers to keep the seatback in an upright position whenever the vehicle is in motion. If a seat is reclined during an accident, the restraint

system's ability to restrain the passenger will be greatly reduced.

⚠ WARNING**Seat cushion**

Occupants should never sit on after-market seat cushions or sitting cushions. The passenger Occupant Detection System (ODS) may not operate properly, or the passenger's hips may slide under the lap portion of the seat belt during an accident or a sudden stop.

⚠ WARNING**Driver's seat**

- Never attempt to adjust the seat while the vehicle is moving. This could result in loss of control of your vehicle.
- Do not allow anything to interfere with the normal position of the seatback. For example, storing items against the seatback could result in serious or fatal injury in a sudden stop or collision.
- Sit as far back as possible from the steering wheel while still maintaining comfortable control of the your vehicle. A distance of at least 25 cm (10 inches) from your chest to the steering wheel is recommended. Failure to do so

can result in air bag inflation injuries to the driver.

⚠ WARNING

Rear seatbacks

- Always lock the rear seatback before driving. Failure to do so could result in passengers or objects being thrown forward, injuring vehicle occupants.

⚠ WARNING

Unexpected seat movement

After adjusting a manual seat, always check that it is locked by shifting your weight to the front and to the back. Sudden or unexpected movement of the driver's seat could cause you to lose control of the vehicle.

⚠ WARNING

Seat adjustment

- Do not adjust the seat while wearing seat belts. Moving the seat forward will cause strong pressure on the abdomen.
- Do not place your hand near the seat bottom or seat track while adjusting the seat. Your hand could get caught in the seat mechanism.

⚠ WARNING

Luggage and cargo

Do not stack or pile luggage or cargo higher than the seatback in the cargo area. In an accident the cargo could strike and injure a passenger. If objects are large, heavy or must be piled, they must be secured in the cargo area.

⚠ WARNING

Cargo area

Do not allow passengers to ride in the cargo area under any circumstance. The cargo area is solely for the purpose of transporting luggage or cargo.

⚠ WARNING

Small objects

Use extreme caution when picking up small objects trapped under the seats or between the seat and the center console. Your hands might be cut or injured by the sharp edges of the seats mechanism.

⚠ CAUTION

Precautions with seat covers

Use caution when working on the seat cover. A short circuit or disconnection may occur, which could lead

to noise, damage the ventilation system.

⚠ WARNING

Seat short circuit risk

Be aware of wires or air vents when placing a seat cover or covering the seat with plastic cover. A short circuit may occur, which could lead to fire.

Feature of Seat Leather (if equipped)

- Wrinkles may appear as a natural result of stretching and shrinking depending on the temperature and humidity.
- The seat cover is made of stretchable material to improve comfort of passengers.
- The parts contacting the body are curved and the side supporting area is high which provides driving comfort and stability.

⚠ CAUTION

- Belts with metallic accessories, zippers or keys inside the back pocket may damage the seat fabric.
- Make sure not to wet the seat. It may change the nature of leather.

- Jeans or clothes which could bleach may contaminate the surface of the seat covering fabric.

*** NOTICE**

Wrinkles or abrasions may appear naturally from usage. It is not a fault of product. Wrinkles or abrasions are not covered by warranty.

Front seat adjustment for manual seat (if equipped)

The front seat can be adjusted by using the control levers located on the outside of the seat cushion.

Moving forward and backward

Adjust the seat before driving, and make sure the seat is locked securely by trying to move forward and backward without using the lever. If the seat moves, it is not locked properly.



To move the seat forward or backward:

1. Pull the seat slide adjustment lever up and hold it.
2. Slide the seat to the position you desire.
3. Release the lever and make sure the seat is locked in place.

Reclining seatback

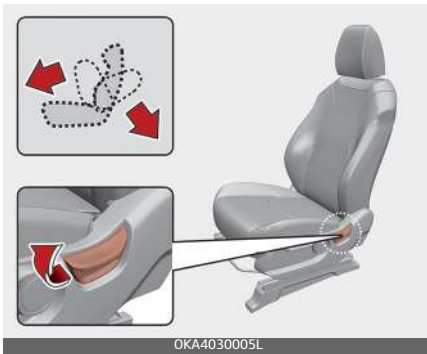

To recline the seatback:

1. Lean forward slightly and lift up the seatback recline lever.
2. Carefully lean back on the seat and adjust the seatback of the seat to the position you desire.
3. Release the lever and make sure the seatback is locked in place. (The lever **MUST** return to its original position for the seatback to lock.)

⚠ WARNING

Reclining seatback

Sitting in a reclined position when the vehicle is in motion can be dangerous. Even when buckled up, the protections of your restraint system (seat belts and/or air bags) is greatly reduced by reclining your seatback.

Seat belts must be snug against your hips and chest to work properly. When the seatback is reclined, the shoulder belt cannot do its job because it will not be snug against your chest. Instead, it will be in front of you. During an accident, you could be thrown into the seat belt, causing neck or other injuries.

The more the seatback is reclined, the greater chance the passenger's hips will slide under the lap belt or the passenger's neck will strike the shoulder belt.

Changing seat cushion height (for driver's seat)

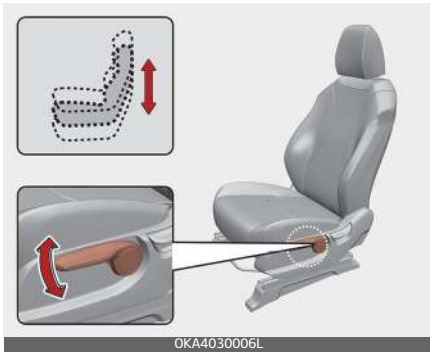

To change the height of the seat cushion, push the lever upwards or downwards.

- To lower the seat cushion, push down the lever several times.
- To raise the seat cushion, pull up the lever several times.

Adjusting lumbar support (if equipped)



The lumbar support can be adjusted by pressing the lumbar support switch on the side of the seat.

1. Press the front portion of the switch to increase support, or the rear portion of the switch, to decrease support.
2. Release the switch once it reaches the desired position.

Front seat adjustment for power seat (if equipped)

The driver's seat can be adjusted by using the control switches located on the outside of the seat cushion. Before driving, adjust the seat to the proper position so as to easily control the steering wheel, pedals and switches on the instrument panel.

⚠ WARNING

Unattended children

Never leave children unattended in a vehicle. Children might operate features of the vehicle that could injure them.

⚠ CAUTION

Power seating adjustments

- The power seating controls function by electronic motor. Excessive operation may cause damage to the electrical equipment.
- Do not operate two or more power seat control switches at the same time. Doing so may damage the power seat motor or electrical components.

Moving forward and backward



To move the seat forward or backward:

1. Push the control switch forward or backward to move the seat to the desired position.
2. Release the switch once the seat reaches the desired position.

Reclining seatback



To recline the seatback:

1. Push the control switch forward or backward to move the seatback to the desired angle.
2. Release the switch once the seat reaches the desired position.

Changing seat cushion tilt and height

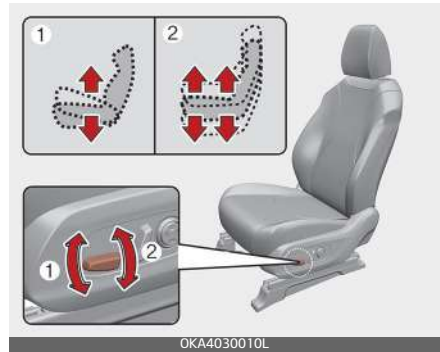

To change the height of the seat:

1. Pull the front portion of the control switch up to raise or press down to lower the front part of the seat cushion. Pull the rear portion of the control switch up to raise or press down to lower the seat cushion.
2. Release the switch once the seat reaches the desired position.

Adjusting lumbar support (if equipped)

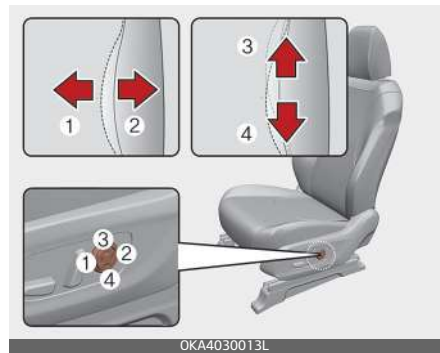

The lumbar support can be adjusted by pressing the lumbar support switch on the side of the seat.

1. Press the front portion of the switch to increase support, or the rear portion of the switch, to decrease support.
2. Release the switch once it reaches the desired position.

Passenger walk-in switch (if equipped)



The rear seat passenger may use the switches to control the front passenger seat.

Sliding forward or rearward:

- To move the front passenger seat forward, press the switch (1). To move the front passenger seat rearward, press the switch (2).

Angle adjustment:

- To recline the front passenger seatback forward, press the switch (3). To recline the front passenger seatback rearward, press the switch (4).

Headrest (for front seat)

The driver's and front passenger's seats are equipped with a headrest for the occupant's safety and comfort.



The headrest not only provides comfort for the driver and front passenger, but also helps protect the head and neck in the event of a collision.

To maximize the effectiveness in case of accidents, the headrest should be adjusted so the middle of the headrest is as high as the center of gravity of an occupant's head. Generally, the center of gravity of most people's heads is similar with the height as the top of their eyes.

Also, adjust the headrest as close to your head as possible. For this reason, the use of a cushion that holds the body away from the seatback is not recommended.

⚠ WARNING

Headrest removal/adjustment

- Do not operate the vehicle with the headrests removed. Headrests can provide critical neck and head support in a crash.
- Do not adjust the headrest height while the vehicle is in motion. Driver may lose control of the vehicle.

⚠ CAUTION

Excessive pulling or pushing may damage the headrest.

Adjusting the height up and down

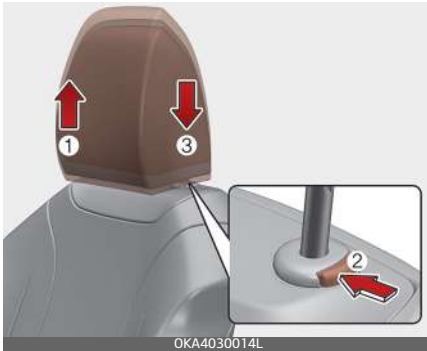

To raise the headrest:

1. Pull it up to the desired position (1).
2. To lower the headrest, push and hold the release button (2) on the headrest support.
3. Lower the headrest to the desired position (3).

⚠ WARNING

Make sure the headrest locks in position after adjusting it to properly protect the occupants.

⚠ CAUTION

If you recline the seatback towards the front with the headrest and seat cushion raised, the headrest may come in contact with the sun visor or other parts of the vehicle.



Removing headrest

Type A

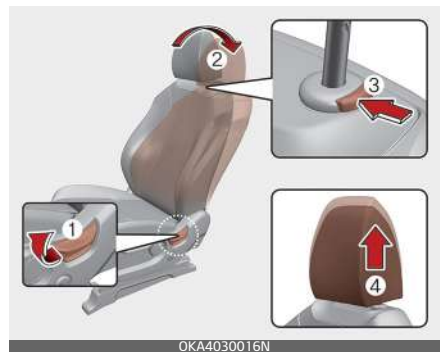

Type B

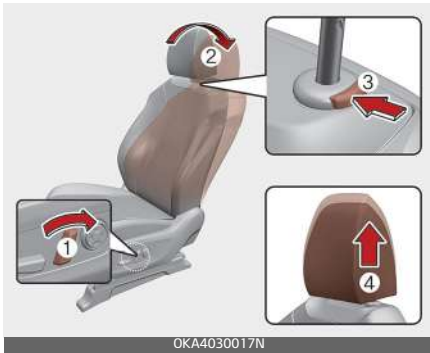

OKA4030017N

To remove the headrest:

1. Recline the seatback (2) with the recline lever or switch (1).
2. Raise headrest as far as it can go.
3. Press the headrest release button (3) while pulling the headrest up (4).

⚠ WARNING

Removing headrest

NEVER allow anyone to ride in a seat with the headrest removed or reversed. Headrests can provide critical neck and head support in a crash.

Reinstalling headrest

Type A

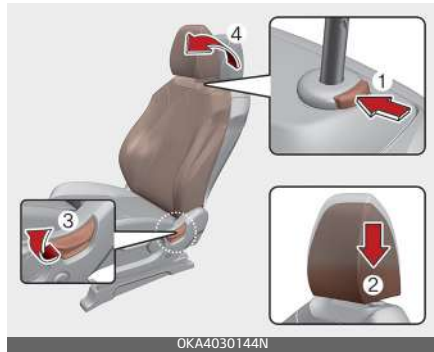

OKA4030144N

Type B

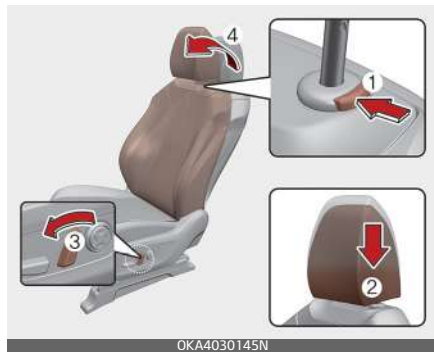

OKA4030145N

To reinstall the headrest:

1. Recline the seatback (4) with the recline lever or switch (3).
2. Put the headrest poles (2) into the holes while pressing the release button (1).
3. Adjust the headrest to the appropriate height.

⚠ WARNING**Headrest reinstallation**

To reduce the risk of injury to the head or neck, always make sure the headrest is locked into position and adjusted properly after reinstalling.

Seatback pocket

There is a double pocket (1) in the front seat back for storing simple books or atlases, USB charger (2), and the hook (3) (if equipped) for rear passengers.

**⚠ WARNING****Seatback pockets**

Do not put heavy or sharp objects in the seatback pockets. In an accident they could come loose from the pocket and injure vehicle occupants.

Rear seat adjustment***Forward and backward adjustment (2nd row seat)***

To move the seat forward or backward:

1. Pull the seat slide adjustment lever up and hold it.
2. Slide the seat to the position you desire.
3. Release the lever and make sure the seat is locked in place.

Adjust the seat before driving, and make sure the seat is locked securely by trying to move forward and backward without using the lever. If the seat moves, it is not locked properly.

Seatback angle (2nd, 3rd row seat)

2nd row outboard seat

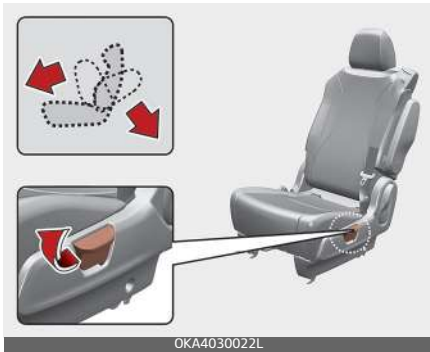

OKA4030022L

2nd row center seat (for 8 seats)

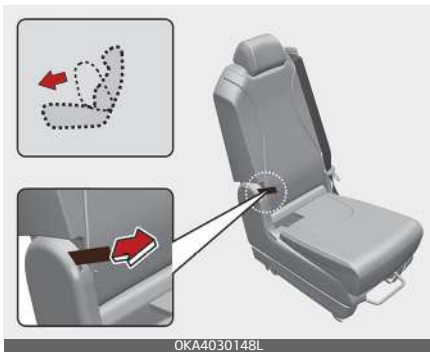

OKA4030148L

3rd row seat

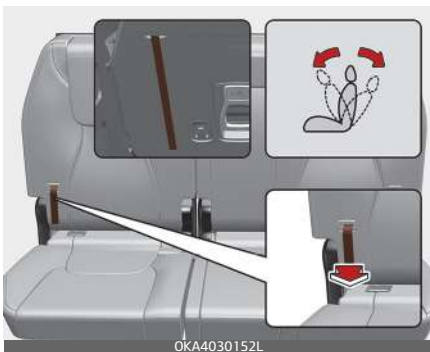

OKA4030152L

To recline the seatback:

1. Pull up the seatback recline lever (for 2nd row outboard seat) or strap (for 2nd row center or 3rd row seat).
2. Hold the lever or strap and adjust the seatback to the position you desire.
3. Release the lever or strap and make sure the seatback is locked in place. (The lever **MUST** return to its original position for the seatback to lock.)

Walk-in seat (2nd row seat) (if equipped)



OKA4030119N

To get in or out from the 3rd row seat:

1. Lift the armrest up and lower the headrest to the lowest position (if necessary).
2. Pull up the walk-in strap (1) or pull the walk-in lever (2) on the 2nd row seat when the passenger gets out from 3rd row seat.
3. After getting in or out, push the 2nd row seat to the original position.

tion until it clicks into place. Make sure that the seat is locked in place.

⚠ WARNING

Never attempt to adjust the 2nd row seat while the vehicle is moving or the seat is occupied as the seat may suddenly move and cause the passenger on the seat to be injured.

⚠ WARNING

Do not pull the strap when the 2nd row seats are occupied. Sudden movement of the seats may result in injury. Use the strap only when the folding switch in the 2nd row (in the upper part of the second-row seatback or the outer part of the seat) does not work.

Folding the rear seat (2nd, 3rd row seat)

The rear seatbacks can be folded to facilitate carrying long items or to increase the luggage capacity of the vehicle.

2nd row outboard seat

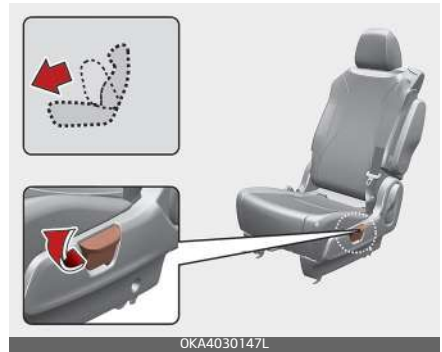

2nd row center seat (for 8 seats)

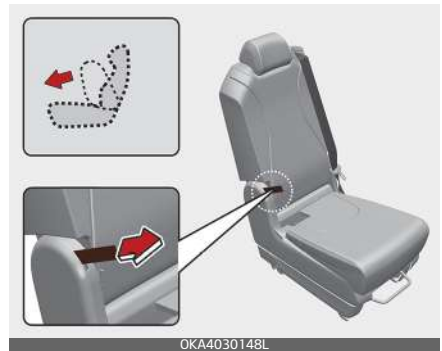

3rd row seat



1. Insert the rear seat belt webbing in the guide to prevent the seat belt from being damaged.

2. Set the front seatback to the upright position and if necessary, slide the front seat forward.
3. Lower the rear headrests to the lowest position.
4. Pull on the seatback folding lever or strap, then fold the seat toward the front of the vehicle. When you return the seatback to its upright position, always be sure it has locked into position by pushing on the top of the seatback.
5. To use the rear seat, lift and pull the seatback backward by pulling on the folding lever or strap. Pull the seatback firmly until it clicks into place. Make sure the seatback is locked in place.
6. Return the rear seat belt to the proper position.

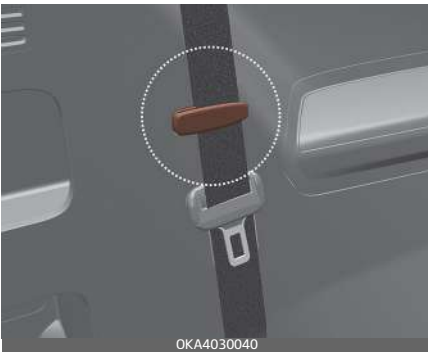

⚠ WARNING

Folded down seatback

Do not sit on folded down seatbacks. The purpose of the fold-down rear seatbacks is to allow you to carry longer objects that could not otherwise be accommodated.

- Never allow a passenger to sit on top of the folded down seatback while the car is moving. This is not a proper seating position since the seat has important crash protection features and seat belts are not available in this seat configuration.
- To reduce the risk of injury caused by sliding cargo within the passenger compartment of the vehicle, objects carried on the folded down seatback should not extend higher than the top of the front seats.

⚠ WARNING

Objects

Objects carried on the folded down seatback should not extend higher than the top of the front seatbacks. This could allow cargo to slide forward and cause injury or damage during sudden stops.

Removing the seat (2nd row seat)

1. Insert the seat belt buckle in the pocket between the rear seatback and cushion.



2. Lower the headrest to the lowest position.
3. Slide the seat to the farthest forward.
4. Fold the seat back by pulling up the reclining lever or strap.
5. Pull the removal lever or strap and lift the rear portion of the seat cushion.

2nd row outboard seat

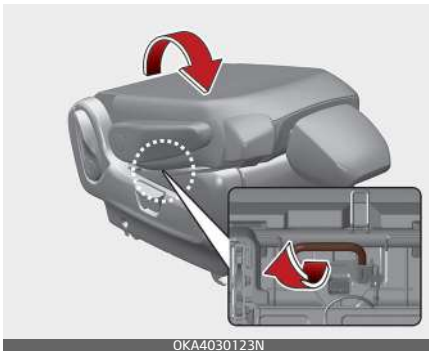

2nd row center seat

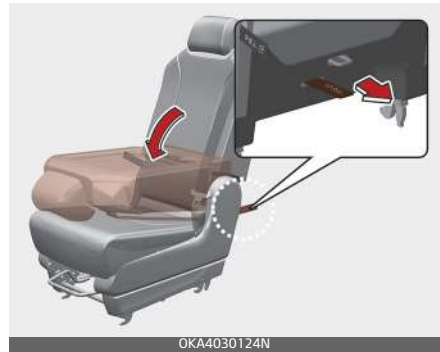

6. Remove the entire seat from the floor.

Installing the seat (2nd row seat)

1. Put the front hook (1) on the front install guide (A) that inside rail on the floor.



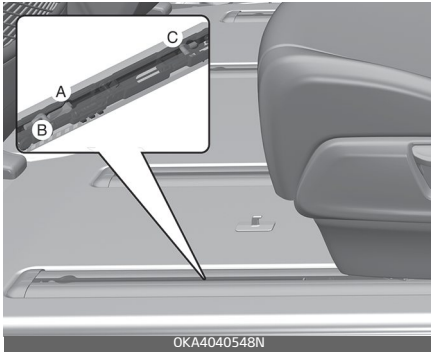

2. Insert two front hooks into the front strikers (B).
3. Lift the rear portion of the seat cushion then push down firmly to lock the catches into the rear strikers (C) until an audible "click" is heard.



4. Make sure the green mark on the rear seat cushion frame is visible and the catches are locked in position by moving the seat forward and backward or lifting the front portion of the seat. If the green mark is invisible and the seat moves, it is not locked properly.

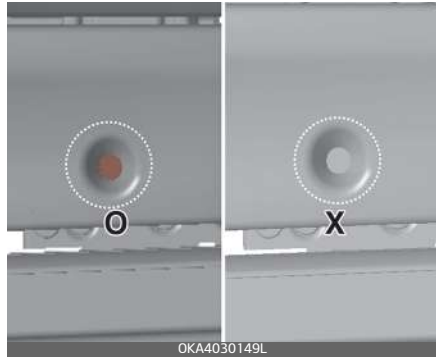

5. Pull up the seatback reclining lever or strap.
6. Lift and push the seatback backward firmly until it clicks into place. Make sure the seatback is locked in place.
7. Return the seat belt to the proper position.

⚠ WARNING

Installing or removing the seat

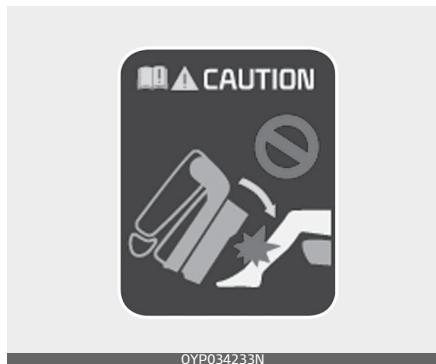

- Do not install or remove the 2nd row seat if there are occupants in the 3rd row seats, as this may injure occupants.

- Fold seatback before installing the tumble seat.

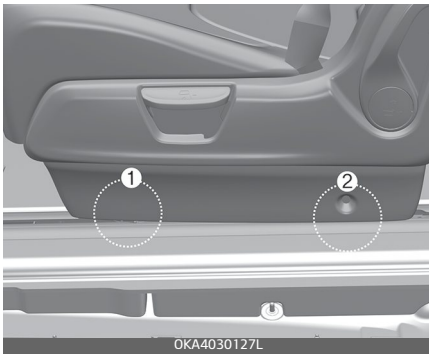

If the rear catches of the seat are locked into the rear anchors (2) while the front catches are not locked into the front anchors (1), do the followings to release the rear catches from the rear anchors.

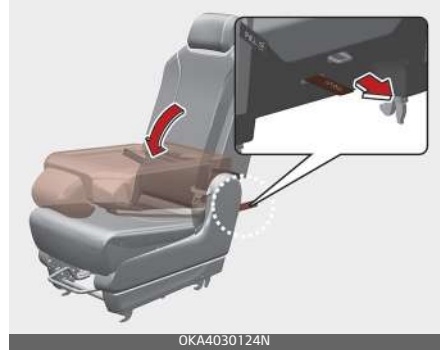
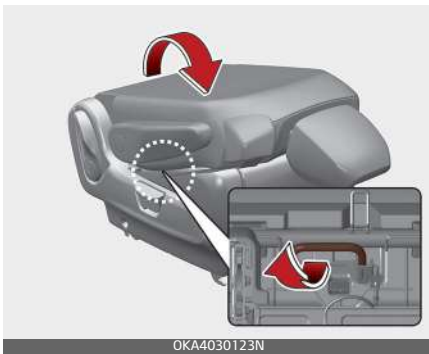

Pull the removal strap or lever and lift the rear portion of the seat cushion. Then the rear catches will be released. Remove the seat while lifting up the rear portion of seat cushion and then reinstalling the tumble seat.

Stowing the rear seat (3rd row)

The rear seat can be folded and stowed in the luggage compartment to provide additional cargo space.

To stow the rear seat:

1. Lower the headrest to the lowest position (1). To stow easily, adjust the seatback (2) to upright position. (if necessary)

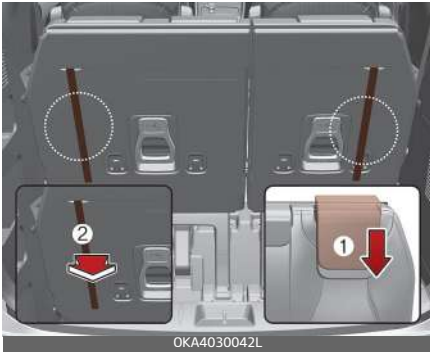

2. Pull up the seat by using the stowing lever (3).



3. Stow the seat by pushing down firmly.



Make sure there is nobody or object around the seat and be careful not

to injure your hands or body under the seat or in the moving parts when stowing or reinstalling the seat.

CAUTION

To stow 3rd row seat

Do not stow the 3rd row seat when the seatback is folded. It may damage the 3rd seat mechanism.



To use the rear seat:

1. Lift the seat by pulling up the stowing lever.



2. Release the lever and push the seat forward firmly until it clicks into place to insert the catches into the anchors.
3. Make sure the catches are locked in position by moving the seat forward and backward or lifting the front portion of the seat. If the seat moves, it is not locked properly. Do not push down the upper part of the seatback when pushing the seat forward. Doing so can prevent the catches from being locked in position.

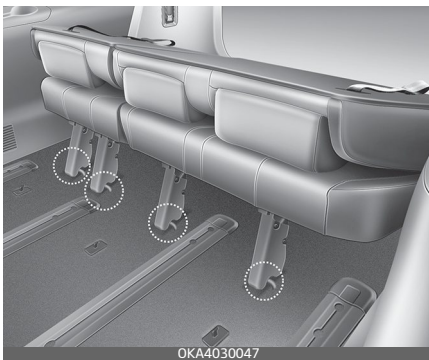

4. Pull out and hold the folding strap.



5. Hold the seat back when you adjust the seat back angle until it clicks into place and then release the folding strap. Make sure the seatback is locked in place.

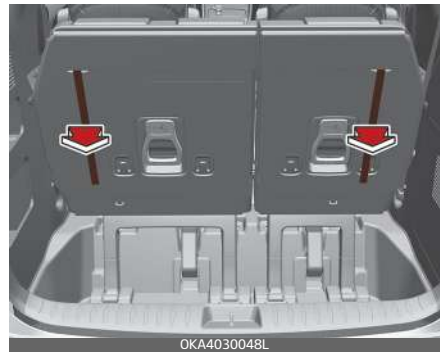

6. Return the rear seat belt to the proper position.

⚠ WARNING

Cargo

- Do not place heavy objects in the rear seats, since they cannot be properly secured and may hit vehicle occupants in a frontal collision.

- Do not place luggage on the folded down seat back of 3rd row seats. Put luggage behind 2nd row seats after the folded 3rd row seat is stowed away into the floor.

When you fold the rear (2nd and/or 3rd row) seatback, insert the buckle in the pocket between the rear seatback and cushion. Doing so can prevent the buckle from being damaged by the rear seatback.

When returning the rear (2nd and/or 3rd row) seatbacks to the upright position, remember to return the rear shoulder belts to their proper position. Routing the seat belt webbing through the rear seat belt guides will help keep the belts from being trapped behind or under the seats.

Make sure the engine is off, the shift lever is in P (Park) and the parking brake is securely applied whenever loading or unloading cargo. Failure to take these steps may allow the vehicle to move if the shift lever is inadvertently moved to another position.

⚠ WARNING

3rd row seat

3rd row occupants should always remain in the center of the seat cushion so the occupants' heads are protected by the headrest. If not, the liftgate may hit the occupant's head, which could cause injury.

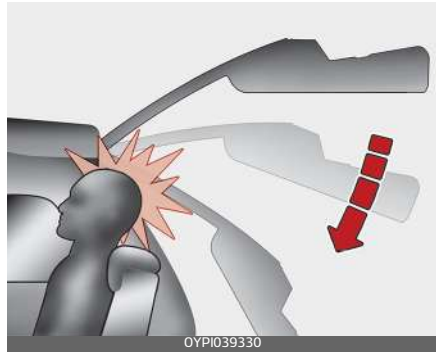

Rear seat adjustment (VIP Lounge Seat) (if equipped)

⚠ CAUTION

- Passenger's attention is required when the VIP Lounge Seat is operating.
- Be careful not to pinch your body or objects while the seat is operating. (Do not operate the Seat if you have a 3rd row seat occupant or other load.)
- Do not operate two types of seat controls (switches) at the same time as this can damage the seat system.

Forward and backward adjustment (VIP Lounge Seat)

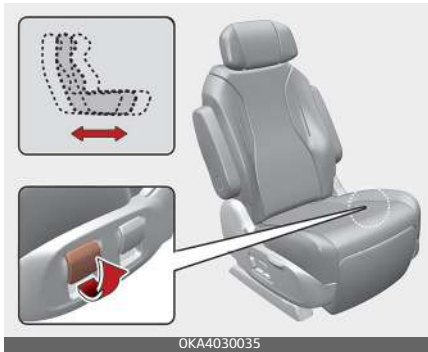

To move the seat forward or backward:

1. Pull the seat slide adjustment lever up and hold it.
2. Slide the seat to the position you desire.
3. Release the lever and make sure the seat is locked in place.

Adjust the seat before driving, and make sure the seat is locked securely by trying to move forward and backward without using the lever. If the seat moves, it is not locked properly.

Left and right adjustment (VIP Lounge Seat)



To move the seat left side or right side:

1. Pull the seat slide adjustment lever up and hold it.
2. Slide the seat to the position you desire.
3. Release the lever and make sure the seat is locked in place.

Adjust the seat before driving, and make sure the seat is locked securely by trying to move left side and right side without using the lever. If the seat moves, it is not locked properly.

Seat cushion height adjustment (VIP Lounge Seat)

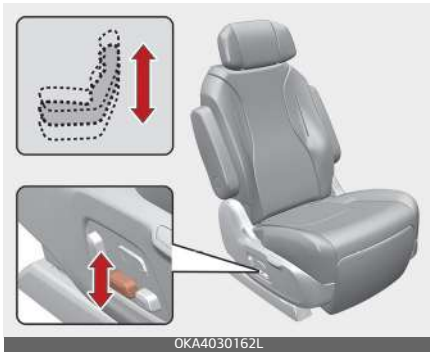

- To change the height of the seat cushion:
1. Push the lever upwards or downwards to adjust the seat cushion height.
 2. Release the switch once the seat reaches the desired position.

Seatback angle (VIP Lounge Seat)

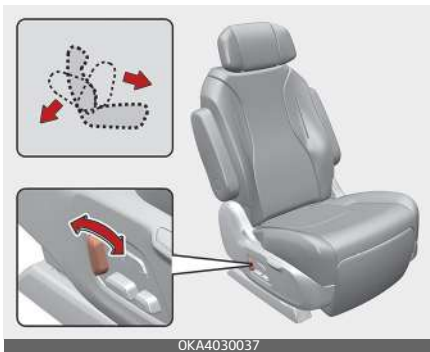

- To recline the seatback:
1. Push the control switch forward or backward to move the seatback to the desired angle.
 2. Release the switch once the seat reaches the desired position.

Leg support (VIP Lounge Seat)



- To use the leg support:
1. Pull the leg support lever up and hold it.
 2. Adjust the angle (1) and length (2) of the leg support while holding the leg support. When using the leg rest, move the seat to the inner position, and then toward the back. If the seat is not moved far back, it may come in contact with the first row seat.
 3. Release the switch and make sure the leg support is locked in place.

The leg support length switch operates after the leg support has been raised by more than a certain angle to prevent damage to parts due to floor interference.

VIP Lounge Seat (VIP Lounge Seat)



VIP Lounge Seat distribute body pressure and concentrated weight on specific body parts that occur while sitting in the same position for a long period of time. The seat relieves fatigue and discomfort by providing the optimal sit position.

CAUTION

Take the following precautions when using the VIP Lounge Seat:

- Do not use the VIP Lounge Seat while the vehicle is moving. Using the VIP Lounge Seat could increase the risk of injuries in the event of a collision or sudden stop.
- Do not use the VIP Lounge Seat while the vehicle is moving. The shoulder belt may not adhere to your chest firmly.

VIP Lounge Seat function



[A]: Moves simultaneously

If you push down the one touch switch (1), the seat will be adjusted to the VIP Lounge position without leg support. If you push the switch (2), the seat will be slightly adjusted to the desired VIP Lounge position with leg support.

Return function

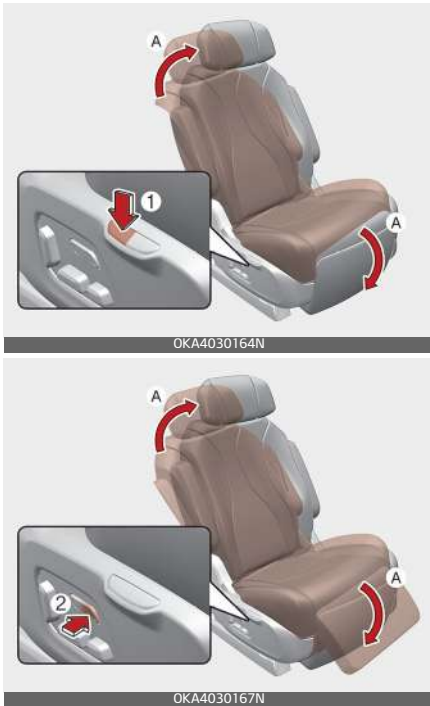

[A]: Moves simultaneously

If you push down the one touch switch (1), the seat will return to the previous position. If you push the switch (2), the seat will be slightly adjusted to the previous position.

Headrest (for rear seat)

The rear seats are equipped with headrests in all the seating positions for the occupant's safety and comfort.



* : 2nd-row center headrest for 8 seats

The headrest not only provides comfort for passengers, but also helps protect the head and neck in the event of a collision.

To maximize the effectiveness in case of accidents, the headrest should be adjusted so the middle of the headrest is as high as the center of gravity of an occupant's head. Generally, the center of gravity of most people's heads is similar with the height as the top of their eyes.

Also, adjust the headrest as close to your head as possible. For this reason, the use of a cushion that holds the body away from the seatback is not recommended.

Adjusting the height up and down

2nd row seat

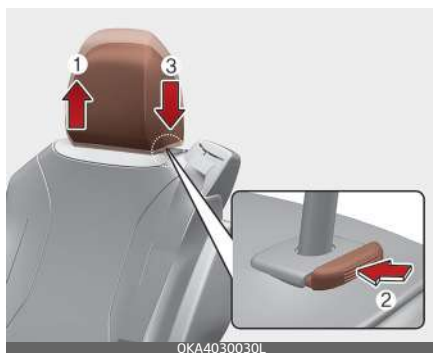

3rd row seat

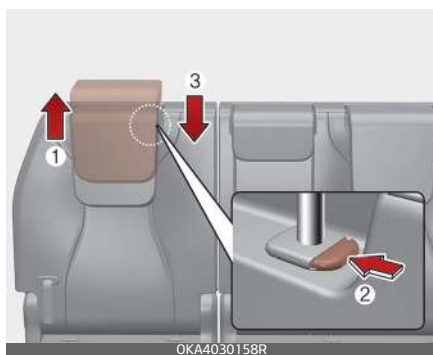

Removal and re-installation

2nd row seat



3rd row seat

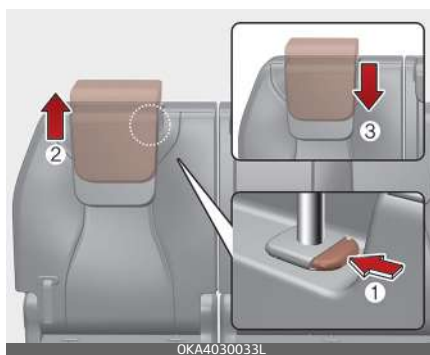

To raise the headrest:

1. Pull it up to the desired position (1).

To lower the headrest:

1. Push and hold the release button (2) on the headrest support.
2. Lower the headrest to the desired position (3).

To remove the headrest:

1. Raise it as far as it can go then press the release button (1) while pulling the headrest up (2).

To reinstall the headrest:

1. Put the headrest poles (3) into the holes while pressing the release button (1).
2. Adjust it to the appropriate height.

Make sure the headrest locks in position after adjusting it to properly protect the occupants.

After installing the headrest, make sure that it is installed in the right direction.

A headrest installed reversely could increase whiplash injury during rear impact.

⚠ WARNING

Make sure the headrest locks in position after adjusting it to properly protect the occupants.

Forward and backward adjustment (if equipped)



The headrest may be adjusted forward or backward by pulling the lower part of the headrest forward or backward to the desired detent in the direction of the arrow. Adjust the headrest so that it properly supports the head and neck.

Wing-out headrest (VIP Lounge Seat) (if equipped)



For rear outboard passenger's comfort, the ends of the headrest can be adjusted inward.

Seat belts

Seat belts are designed to bear upon the bony structure of the body, and should be worn low across the front of the pelvis, chest and shoulders.

Seat belt restraint system

For maximum restraint system protection, the seat belts must always be used whenever the vehicle is moving.

- A properly positioned shoulder belt should be positioned midway over your shoulder, across your collarbone.
- Never allow children to ride in the front passenger seat. See "Child Restraint System (CRS)" on page 3-47 for further discussion.

⚠ WARNING

Twisted seat belt

Make sure your seat belt is not twisted when worn. A twisted seat belt may not properly protect you in an accident and could even cut into your body.

⚠ WARNING

Shoulder belt

- Never wear the shoulder belt under your arm or behind your back. An improperly positioned shoulder belt cannot protect the occupant in the event of a crash.

- Always wear both the shoulder portion and lap portion of the lap/shoulder belt.

⚠ WARNING

Damaged seat belt

Any damage in webbing or hardware may lead to serious injury or death in a crash. For your safety, replace the entire seat belt assembly when any part of the webbing or hardware is damaged.

Seat belts are designed to bear upon the bony structure of the body, and should be worn low across the front of the pelvis, chest and shoulders, as applicable; wearing the lap section of the belt across the abdominal area must be avoided.

Seat belts should be adjusted as firmly as possible, consistent with comfort, to provide the protection for which they have been designed.

A slack belt will greatly reduce the protection afforded to the wearer.

Care should be taken to avoid contamination of the webbing with polishes, oils and chemicals, and particularly battery acid. Cleaning may safely be carried out using mild soap and water. The belt should be replaced if webbing becomes frayed, contaminated or damaged.

- No modifications or additions should be made by the user which would either prevent the seat belt adjusting devices from operating to remove slack, or prevent the seat belt assembly from being adjusted to remove slack.
- When you fasten the seat belt, be careful not to latch the seat belt in buckles of other seats. It is very dangerous and you may not be protected by the seat belt properly.
- Do not unfasten the seat belt and do not fasten and unfasten the seat belt repeatedly while driving. This could result in loss of control, and an accident causing death, serious injury, or property damage.
- When fastening the seat belt, make sure that the seat belt does not pass over objects that are hard or can break easily.

▲ WARNING

Seat belt buckle

Do not allow foreign material (gum, crumbs, coins, liquids, etc.) to obstruct the seat belt buckle. This may prevent the seat belt from fastening securely.

Seat belt warning



The seat belt warning light and warning chime operate under the following conditions.

Driver's seat belt warning

As a reminder to the driver, the seat belt warning light will illuminate for approximately 6 seconds each time you turn the ignition switch or ENGINE START/STOP button ON regardless of belt fastening. If the seatbelt is not fastened, the warning chime will sound for about 6 seconds.

If you start to drive without the seat belt fastened over approximately 9 km/h (5 mph) and less than approximately 20 km/h (12 mph), the corresponding warning light will illuminate. The warning light will turn off when the vehicle speed drops below approximately 9 km/h (5 mph).

If you start to drive without the seat belt fastened or you unfasten the seat belt when you drive approximately 20 km/h (12 mph) and faster, the warning light will blink and warning chime will sound for approximately 100 seconds.

When the seat belt is unfastened during driving, the warning light will illuminate when the speed is over approximately 9 km/h (5 mph) and less than approximately 20 km/h (12 mph). When the speed is approximately 20 km/h (12 mph) and faster, the warning light will blink and warning chime will sound for approximately 100 seconds.

Front passenger's seat belt warning

As a reminder to the front passenger, the seat belt warning light will illuminate for approximately 6 seconds each time you turn the ignition switch or ENGINE START/STOP button ON regardless of belt fastening. If you start to drive without the passenger seat belt fastened when you drive over approximately 9 km/h (5 mph) and less than approximately 20 km/h (12 mph), the corresponding warning light will illuminate. The warning light will turn off when the vehicle speed drops approximately below 9 km/h (5 mph).

If you start to drive without the passenger seat belt fastened or you unfasten the seat belt when you drive approximately 20 km/h (12 mph) and faster, the warning light will blink and warning chime will sound for approximately 100 seconds.

When the passenger seat belt is unfastened during driving, the warning light will illuminate when the speed is over approximately 9 km/h (5 mph) and less than approximately 20 km/h (12 mph). When the speed is approximately 20 km/h (12 mph) and faster, the warning light will blink and warning chime will sound for approximately 100 seconds.

*** NOTICE**

- Even if the front passenger seat is not occupied, the seat belt warning light will illuminate for approximately 6 seconds.
- The front passenger's seat belt warning may operate when luggage is placed on the front passenger seat.

Seat belt - Driver's 3-point system with emergency locking retractor

Fastening the seat belt

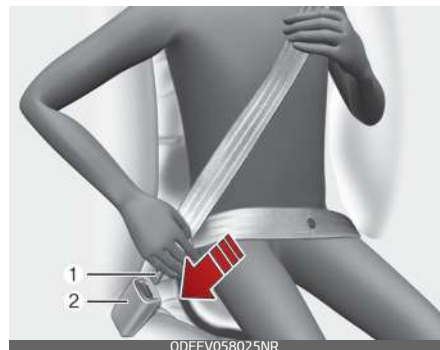

ODEEV058025NR

- To fasten your seat belt, pull it out of the retractor and insert the metal tab (1) into the buckle (2). There will be an audible "click" when the tab locks into the buckle.

The seat belt automatically adjusts to the proper length only after the lap belt portion is adjusted manually so that it fits snugly around your hips. If you lean forward in a slow, easy motion, the belt will extend and let you move around. If there is a sudden stop or impact, however, the belt will lock into position. It will also lock if you try to lean forward too quickly.

⚠ WARNING

You should place the lap belt portion as low as possible and snugly across your hips. If the lap belt is located too high on your waist, it may increase the chance of injury in the event of a collision.



The arm closest to the seat belt buckle should be over the belt while the other arm should be under the belt as shown in the illustration. Never wear the seat belt under the arm closest to the door.

*** NOTICE**

If you are not able to pull out the seat belt from the retractor, firmly pull the belt out and release it. Then you will be able to pull the belt out smoothly.

Releasing the seat belt



- Press the release button (1) in the locking buckle.

When it is released, the belt should automatically draw back into the retractor.

If this does not happen, check the belt to be sure it is not twisted, then try again.

Adjusting the height of shoulder belt

You can adjust the height of the shoulder belt anchor to one of 4 positions for maximum comfort and safety.

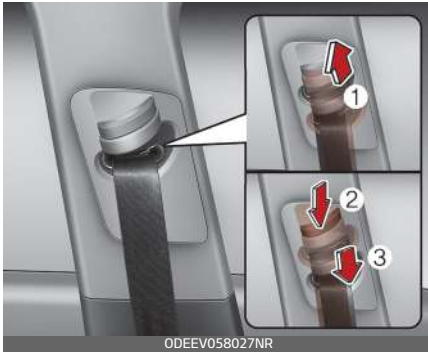

The height of the adjusting seat belt should not be too close to your neck. You will not be getting the most effective protection. The shoulder portion should be adjusted so that it lies across your chest and midway over your shoulder near the door and not your neck.

To adjust the height of the seat belt anchor, lower or raise the height adjuster into an appropriate position.

- To raise the height adjuster, pull it up (1).
- To lower it, push it down (3) while pressing the height adjuster button (2).

Release the button to lock the anchor into position. Try sliding the

height adjuster to make sure that it has locked into position.

Improperly positioned seat belts can cause serious injuries in an accident.

⚠ WARNING

Shoulder belt positioning

Verify the shoulder belt anchor is locked into position at the appropriate height. Never position the shoulder belt across your neck or face. Improperly positioned seat belts can cause serious injuries in an accident.

⚠ WARNING

Seat belt replacement

Replace your seat belts after being in an accident. Failure to replace seat belts after an accident could leave you with damaged seat belts that will not provide protection in the event of another collision.

The seat belt should be locked into the buckle on each seat cushion to be properly fastened.

2nd row seats

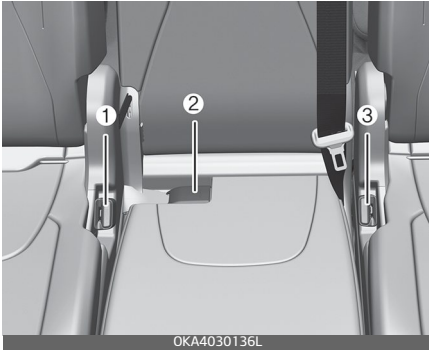

* The 2nd-row center seat is only available in 8 seating positions.

1. Rear right seat belt fastening buckle
2. Rear center seat belt fastening buckle
3. Rear left seat belt fastening buckle

3rd row seats

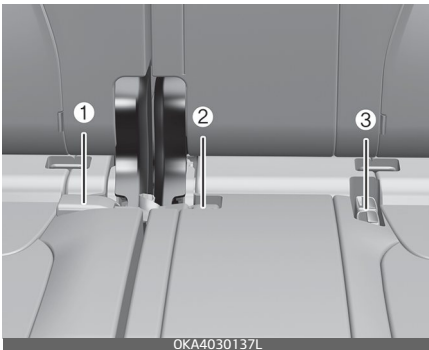

1. Rear right seat belt fastening buckle
2. Rear center seat anchor connector
3. Rear left and center seat belt fastening buckle

⚠ WARNING

Prior to fastening the rear seat belts, ensure the latch matches the seat belt buckle. Forcefully fastening the left or right seat belt to the center buckle can result in an improper fastening scenario that will not protect you in an accident.

3-point rear center belt (3rd row center seat)

To fasten the rear center belt

1. Pull out the mini tongue from hole on the belt assembly cover (1) and then slowly pull the seat belt out from the retractor.

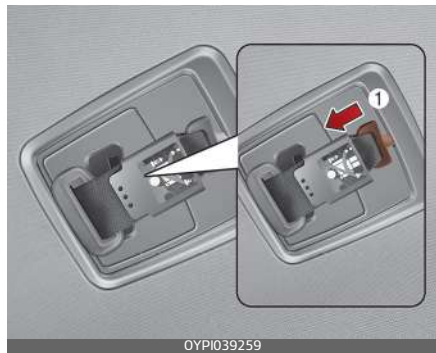

2. Pull out the tongue plate from the holder on the seat belt (2).



3. Insert the mini tongue (A) into the open end of the anchor connector (C) until an audible "click" is heard, indicating the latch is locked. Make sure the belt is not twisted.



4. Pull the tongue plate (B) and insert the tongue plate (B) into the open end of the buckle (D) until an audible "click" is heard, indicating the latch is locked. Make sure the belt is not twisted.

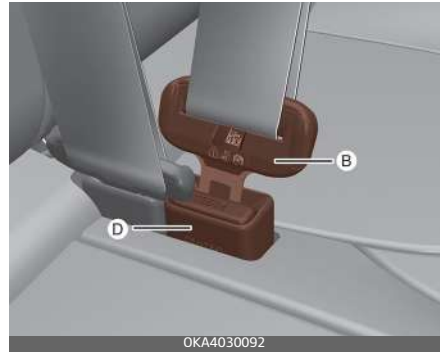

When using the rear center seat belt, the buckle with the "CENTER" mark must be used.

There will be an audible "click" when the tab locks in the buckle. The seat belt automatically adjusts to the proper length only after the lap belt is adjusted manually so that it fits snugly around your hips, if you lean forward in a slow, easy motion, the belt will extend and let you move around. If there is a sudden stop or impact, the belt will lock into position. It will also lock if you try to lean forward too quickly.

⚠ WARNING

When using the rear seat center belt, you must lock all tongue plates and buckles. If any tongue plate or buckle is not locked, it will increase the chance of injury in the event of collision.

To unfasten the rear center belt

1. Press the release button on the buckle (D) and remove the tongue plate (B) from the buckle (D).

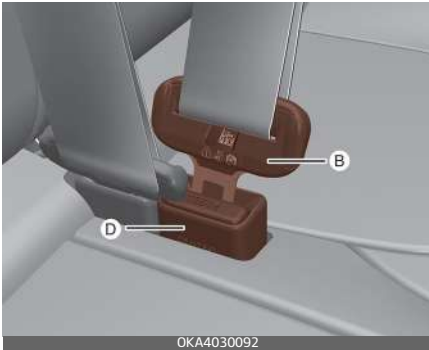

2. To retract the rear center seat-belt, insert the tongue plate or similar small rigid device into the web release hole (C). Pull up on the seat belt web (A) and allow the webbing to retract automatically.

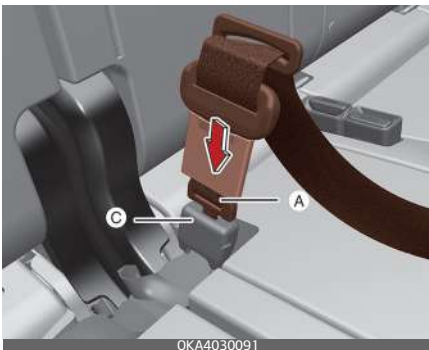
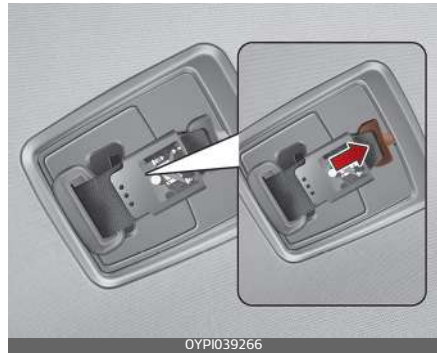

Stowing the rear seat belt

The rear seat belt buckles can be stowed in the pocket between the rear seatback and cushion when not in use.

The center seat belt can be stowed with the plate and webbing rolled in the pocket between the rear seatback and cushion.

3. Insert the tongue plate into the holder (1) in seat belt and then insert the mini tongue into the hole on the belt assembly cover.

2nd row seat



3rd row seat

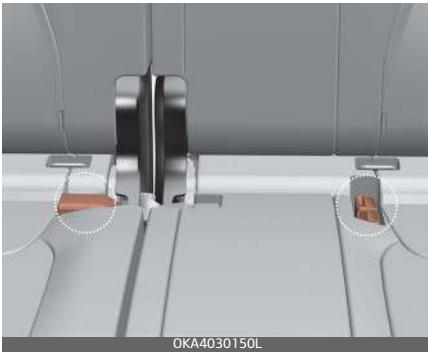

3rd row center seat



3rd row outboard seat

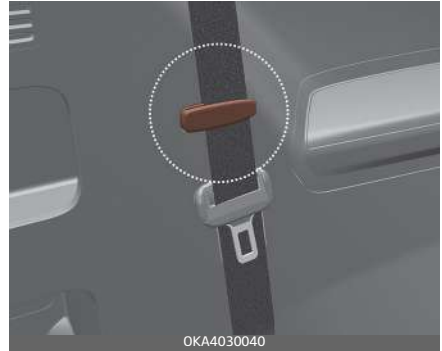

1. Route the seat belt webbing through the rear seat belt guides. It will help keep the belts from being trapped behind or under the seats.
2. After inserting the seat belt, tighten the belt webbing by pulling it up.

⚠ CAUTION

When pulling out to wear the seat belt, the tongue should be slowly pulled out of the seat belt guide so that the seat belt guide does not come off the trim.

Pre-tensioner seat belt



Your vehicle is equipped with driver's and front passenger's pre-tensioner seat belts.

The purpose of the pre-tensioner is to make sure that the seat belts fit tightly against the occupant's body in certain collisions.

The pre-tensioner seat belts may be activated in crashes where the collision is severe enough.

When the vehicle stops suddenly, or if the occupant tries to lean forward too quickly, the seat belt retractor will lock into position. In certain frontal collisions, the pre-tensioner will activate and pull the seat belt into tighter contact against the occupant's body.

If the system senses excessive tension on the driver or passenger's seat belt when the pre-tensioner system activates, the load limiter inside the retractor pre-tensioner

will release some of the pressure on the affected seat belt.

⚠ WARNING

For your safety, be sure that the belt webbing is not loose or twisted and always sit properly on your seat.

*** NOTICE**

The pre-tensioner may activate not only in a frontal collision but also in a side collision, if the vehicle is equipped with a side or curtain air bag.

The seat belt pre-tensioner system consists mainly of the following components. Their locations are shown in the illustration:

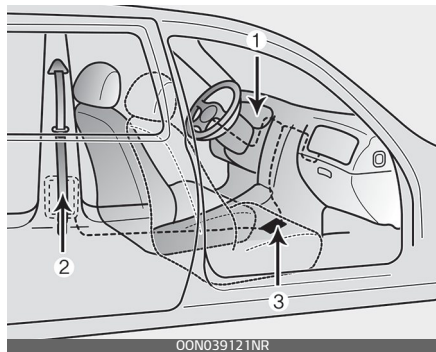

1. SRS air bag warning light
2. Front retractor pre-tensioner assembly
3. SRS control module

⚠ WARNING**Skin irritation**

Wash all exposed skin areas thoroughly after an accident in which the pre-tensioner seat belts were activated. The fine dust from the pre-tensioner activation may cause skin irritation and should not be inhaled for prolonged periods.

*** NOTICE**

- Both the driver's and front passenger's seat belt pre-tensioner systems may be activated not only in certain frontal collisions, but also in certain side collisions or rollovers, if the vehicle is equipped with a side or curtain air bag.
- Because the sensor that activates the SRS air bag is connected with the pre-tensioner seat belt, the SRS air bag warning light () on the instrument panel will illuminate for approximately 3 ~ 6 seconds after the ignition switch or ENGINE START/STOP button has been turned to the ON position, and then it should turn off.
- If the pre-tensioner seat belt system is not working properly, this warning light will illuminate even if there is not a malfunction with the SRS air bag. If the SRS air bag warning light does not illuminate

when the ignition switch or ENGINE START/STOP button has been turned to the ON position, or if it remains illuminated after illuminating for approximately 3 ~ 6 seconds, or if it illuminates while the vehicle is being driven, have an authorized Kia dealer inspect the pre-tensioner seat belt and SRS air bag system as soon as possible.

*** NOTICE**

Do not attempt to service or repair the pre-tensioner seat belt system in any manner. Do not attempt to inspect or replace the pre-tensioner seat belts yourself. This must be done by an authorized Kia dealer.

⚠ WARNING**Hot pre-tensioner**

Do not touch the pre-tensioner seat belt assemblies for several minutes after they have been activated. When the pre-tensioner seat belt mechanism fires during a collision the pre-tensioner becomes hot and can burn you.

Pre-tensioners are designed to operate only one time. After activation, pre-tensioner seat belts must be replaced. If the pre-tensioner must be replaced, contact an authorized Kia dealer.

Seat belt precautions

Take the following precautions when using seat belts.

Infant or small child

Most countries have child restraint laws. You should be aware of the specific requirements in your country. Child and/or infant seats must be properly placed and installed in the rear seat. For more information about the use of these restraints, refer to "Child Restraint System (CRS)" on page 3-47.

*** NOTICE**

Small children are best protected from injury in an accident when properly restrained in the rear seat by a Child Restraint System that meets the requirements of the Safety Standards of your country. Before buying any Child Restraint System, make sure that it has a label certifying that it meets Safety Standards of your country. The restraint must be appropriate for your child's height and weight. Check the label on the child restraint for this information. Refer to "Child Restraint System (CRS)" on page 3-47.

Larger children

Children who are too large for Child Restraint System should always occupy the rear seat and use the available lap/shoulder belts. The lap portion should be fastened and snug on the hips as low as possible. Check periodically to insure that the belt fits. A child's squirming could put the belt out of position. Children are given the most safety in the event of an accident when they are restrained by a proper restraint system in the rear seat. If a larger child (over age 13) must be seated in the front seat, the child should be securely restrained by the available lap/shoulder belt and the seat should be placed in the rearmost position. Children age 13 and under should be restrained securely in the rear seat. NEVER place a child age 13 and under in the front seat. NEVER place a rear facing child seat in the front seat of a vehicle.

If the shoulder belt portion slightly touches the child's neck or face, try placing the child closer to the center of the vehicle. If the shoulder belt still touches their face or neck they need to be returned to a Child Restraint System.

⚠ WARNING**Small children**

Do not allow small children to ride in the vehicle without an appropriate Child Restraint System. If the shoulder belt comes in contact with your child's neck or face, your child is too small to ride in the vehicle. In a crash, the seat belt will inflict injury to your child's neck, throat and face.

Restraint of pregnant women

Pregnant women should wear lap/shoulder belt assemblies whenever possible according to specific recommendations by their doctors. The lap portion of the belt should be worn **AS SECURELY AND LOW AS POSSIBLE**.

⚠ WARNING**Pregnant women**

Pregnant women must never place the lap portion of the seat belt above or on the abdomen where the fetus is located. The force of the seat belt during a collision will crush the fetus.

Injured person

A seat belt should be used when an injured person is being transported. When this is necessary, you should consult a physician for recommendations.

One person per belt

Two people (including children) should never attempt to use a single seat belt. This could increase the severity of injuries in case of an accident.

Do not lie down

To reduce the chance of injuries in the event of an accident and to achieve maximum effectiveness of the restraint system, all passengers should be sitting up and the front and rear seats should be in an upright position when the vehicle is moving. A seat belt cannot provide proper protection if the person is lying down in the rear seat or if the front and rear seats are in a reclined position.

Care of seat belts

Seat belt systems should never be disassembled or modified. In addition, care should be taken to assure that seat belts and belt hardware are not damaged by seat hinges, doors or other abuse.

⚠ WARNING**Pinched seat belt**

Make sure that the webbing and/or buckle does not get caught or pinched in the rear seat when returning the rear seatback to its upright position. A caught or pinched webbing/buckle may become damaged and could fail during a collision or sudden stop.

⚠ WARNING

Seat belts can become hot in a vehicle that has been closed up in sunny weather. Please handle with care, as they could burn infants and children, if used abruptly.

Periodic inspection

All seat belts should be inspected periodically for wear or damage of any kind. Any damaged parts should be replaced as soon as possible.

Keep belts clean and dry

Seat belts should be kept clean and dry. If belts become dirty, they can be cleaned by using a mild soap solution and warm water. Bleach, dye, strong detergents or abrasives should not be used because they may damage and weaken the fabric.

When to replace seat belts

The entire in-use seat belt assembly or assemblies should be replaced if the vehicle has been involved in an accident. This should be done even if no damage is visible. Additional questions concerning seat belt operation should be directed to an authorized Kia dealer.

Child Restraint System (CRS)

Infants and younger children must be restrained in an appropriate rear-facing or forward-facing Child Restraint System (CRS) that has first been properly secured to the rear seat of the vehicle.

Children always in the rear

Children under age 13 must always ride in the rear seats and must always be properly restrained to minimize the risk of injury in an accident, sudden stop or sudden maneuver.

WARNING

Restraint Location

Never install a child or infant seat on the front passenger's seat. A child riding in the front passenger seat can be forcefully struck by an inflating airbag and get seriously injured.

WARNING

Hot Child Restraint

A Child Restraint System can become very hot if it is left in a closed vehicle on a sunny day. Be sure to check the seat cover, buckles and latches before placing a child in the restraint system.

According to accident statistics, children are safer when properly

restrained in the rear seats than in the front seat. Even with air bags, children can be seriously injured or killed. Children too large for a child restraint must use the seat belts provided.

Most countries have child restraint laws which require children to travel in approved child restraint devices. The laws governing the age or height/weight restrictions at which seat belts can be used instead of child restraints differs among countries, so you should be aware of the specific requirements in your country, and where you are traveling.

Child restraint systems must be properly placed and installed in the rear seat. You must use a commercially available child restraint system that meets the requirements of the Safety Standards of your country.

A CRS is generally designed to be secured in a vehicle seat by lap belt portion of a lap/shoulder belt, or by a LATCH system in the rear seats of the vehicle.

Child Restraint System (CRS)

Infants and younger children must be restrained in an appropriate rear-facing or forward-facing CRS that has first been properly secured to the rear seat of the vehicle. Read and comply with the instructions for

installation and use provided by the manufacturer of the CRS.

Child Restraint Installation

An improperly secured child restraint can increase the risk of serious injury or death in an accident. Always take the following precautions when using a Child Restraint System:

- Always follow the Child Restraint System manufacturer's instructions for installation and use.
- Always properly restrain your child in the child restraint.
- If the vehicle head restraint prevents proper installation of a child seat (as described in the Child Restraint System manual), the head restraint of the respective seating position shall be readjusted or entirely removed.
- Do not use an infant carrier or a child safety seat that "hooks" over a seatback as it may not provide adequate protection in an accident.
- A child restraint in the center seating position may also contact or push up against the safety belt buckles, which can damage the buckles and make them unusable or unsafe. Always check that the child restraint does not contact any of the safety belt buckles. Check the placement of the child restraint regularly to make sure

that it has not shifted and come into contact with any of the safety belt buckles.

*** NOTICE**

After an accident, have a Kia dealer check the Child Restraint System, seat belts, tether anchors and lower anchors.

Selecting a CRS

When selecting a CRS for your child, always:

- Make sure the CRS has a label certifying that it meets applicable Safety Standards of your country.
- Select a child restraint based on your child's height and weight. The required label or the instructions for use typically provide this information.
- Select a child restraint that fits the vehicle seating position where it will be used.
- Read and comply with the warnings and instructions for installation and use provided with the CRS.
- The American Academy of Pediatrics provides helpful fit and safety information about child restraints at www.healthychildren.org.

⚠ WARNING**Holding children**

Never hold a child in your arms or lap when riding in a vehicle. The violent forces created during a crash will tear the child from your arms and throw the child against the car's interior. Always use a Child Restraint System which is appropriate for your child's height and weight.

⚠ WARNING**Unattended children**

Never leave children unattended in a vehicle. The car can heat up very quickly, resulting in injuries to the child in the vehicle.

⚠ WARNING**Seat belt use**

Do not use one seat belt for two occupants at the same time. This will eliminate any safety benefit provided by the seat belt to the occupants.

CRS types

There are three main types of the CRS: rear-facing seats, forward-facing seats, and booster seats. They are classified according to the child's age, height and weight.

Rear-facing child seats

A rear-facing child seat provides restraint with the seating surface against the back of the child. The harness system holds the child in place, and in an accident, acts to keep the child positioned in the seat and reduces the stress to the neck and spinal cord.

All children under age one must always ride in a rear-facing infant child restraint.

Convertible and 3-in-1 child seats typically have higher height and weight limits for the rear-facing position, allowing you to keep your child rear-facing for a longer period of time.

Continue to use a rear-facing child seat for as long as your child will fit within the height and weight limits allowed by the child seat manufacturer. It's the best way to keep them safe. Once your child has outgrown the rear-facing child restraint, your child is ready for a forward-facing child restraint with a harness.

Forward-facing child restraints



A forward-facing child seat provides restraint for the child's body with a harness. Keep children in a forward-facing child seat with a harness until they reach the top height or weight limit allowed by your child restraint's manufacturer. Once your child outgrows the forward-facing child restraint, your child is ready for a booster seat.

Booster seats

A booster seat is a restraint designed to improve the fit of the vehicle's seat belt system. A booster seat positions the seat belt so that it fits properly over the lap of your child.

Keep your child in a booster seat until they are big enough to sit in the seat without a booster and still have the seat belt fit properly. For a seat belt to fit properly, the lap belt must lie snugly across the upper thighs, not the stomach. The shoulder belt should lie snug across the shoulder and chest and not across the neck or face. Children under age

13 must always ride in the rear seats and must always be properly restrained to minimize the risk of injury.

Installing a CRS

After selecting a proper child seat for your child, check to make sure it fits properly in your vehicle.

Follow the instructions provided by the manufacturer when installing the child seat. Note these general steps when installing the seat to your vehicle:

- **Properly secure the child restraint to the vehicle.** All child restraints must be secured to the vehicle with the lap part of a lap/shoulder belt or with the LATCH system.
- **Make sure the child restraint is firmly secured.** After installing a child restraint to the vehicle, push and pull the seat forward and from side-to-side to verify that it is securely attached to the seat. A child restraint secured with a seat belt should be installed as firmly as possible. However, some side-to-side movement can be expected.
- **Secure the child in the child restraint.** Make sure the child is properly strapped in the child restraint according to the manufacturer instructions.

Lower Anchors and Tether for Children (LATCH) system

The LATCH system holds a child restraint during driving and in an accident. This system is designed to make installation of the child restraint easier and reduce the possibility of improperly installing your child restraint. The LATCH system uses anchors in the vehicle and attachments on the child restraint. The LATCH system eliminates the need to use seat belts to secure the child restraint to the rear seats.

Lower anchors are metal bars built into the vehicle. There are two lower anchors for each LATCH seating position that will accommodate a child restraint with lower attachments.

To use the LATCH system in your vehicle, you must have a child restraint with LATCH attachments.

The child seat manufacturer will provide you with instructions on how to use the child seat with its attachments for the LATCH lower anchors.

8 seats

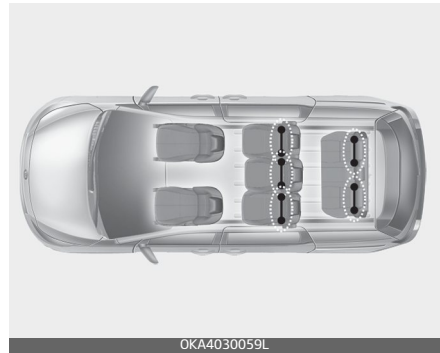

7 seats



For the 7 passenger vehicle, LATCH anchors have been provided in the left and right outboard rear seating positions. For the 8 passenger vehicle, a second row center seat LATCH anchor is also provided. Their locations are shown in the illustrations. There are no LATCH anchors provided for the 3rd row center seating position.

⚠ WARNING

LATCH Lower Anchors

On the third row seating position, never attempt to attach a LATCH equipped seat in the center seating position. LATCH lower anchors are only to be used in the left and right rear outboard seating positions. You may damage the anchors or the anchors may fail and break in a collision if the seat is in the center seating position.

The lower anchor position indicator symbols are located on the left and right rear seatbacks to identify the position of the lower anchors in your vehicle (see arrows in illustration).



1. Lower Anchor position indicator
2. Lower Anchor

The LATCH anchors are located between the seatback and the seat cushion of the rear seat left and right outboard seating positions.

To use the lower anchor, push the upper portion of the lower anchor cover.

Securing a child restraint with the LATCH anchors system

To install a LATCH-compatible child restraint in either of the rear outboard seating positions:

1. Move the seat belt buckle away from the lower anchors. Otherwise, the webbing or buckle can be damaged by the latch anchor, which can make them become unusable or unsafe.
2. Move any other objects away from the anchors that could prevent a secure connection between the child restraint and the lower anchors.
3. Place the child restraint on the vehicle seat, then attach the seat to the lower anchors according to the instructions provided by the child restraint manufacturer.
4. Follow the child restraint instructions for properly adjusting and tightening the lower attachments on the child restraint to the lower anchors.

⚠ WARNING

Take the following precautions when using the LATCH system:

- Read and follow all installation instructions provided with your Child Restraint System.

- To prevent the child from reaching and taking hold of the unused seat belts, buckle all unused rear seat belts before the child is placed into the vehicle. Lock each unused seatbelt following the instructions in the "automatic locking mode" subsection, and place the webbing behind the child seat or against an unused seat-back. Children can be strangled if a shoulder belt becomes wrapped around their neck and the seat belt tightens.
- NEVER attach more than one child restraint to a single anchor. This could cause the anchor or attachment to come loose or break.
- Always have the LATCH system inspected by your authorized Kia dealer after an accident. An accident can damage the LATCH system and may not properly secure the child restraint.

Securing a child restraint seat with "Tether Anchor" system

2nd row seat

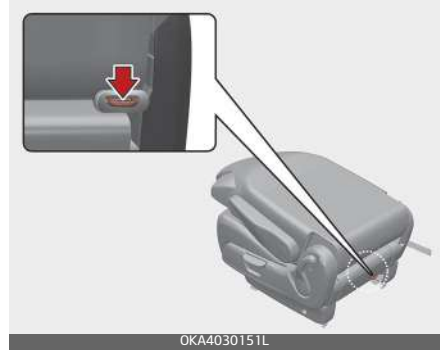

2nd row center seat



2nd row seat (VIP Lounge Seat) (if equipped)



3rd row seat



First secure the child restraint with the LATCH lower anchors or the seat belt. If the child restraint manufacturer recommends that the top tether strap be attached, attach and tighten the top tether strap to the top tether strap anchor.

Child restraint system tether anchorages are located on the back of the rear cushions.

⚠ WARNING

Take the following precautions when installing the tether strap:

- Read and follow all installation instructions provided with your Child Restraint System.
- NEVER attach more than one child restraint to a single tether anchor. This could cause the anchor or attachment to come loose or break.
- Do not attach the tether strap to anything other than the correct tether anchor. It may not work

properly if attached to something else.

- Do not use the tether anchors for adult seat belts or harnesses, or for attaching other items or equipment to the vehicle.
- Always fasten the seat belts behind the child restraint seat when they are not used to secure the child seat. Failure to do so may result in child strangulation.

To install the tether anchor:



1. Route the Child Restraint System seat strap over the seatback. For vehicles with adjustable headrest, route the tether strap under the headrest and between the headrest posts, otherwise route the tether strap over the top of the seatback.
2. Connect the top-tether to the top-tether anchorage, then tighten the top-tether according to the instructions of your Child Restraint System's manufacturer

to firmly attach the Child Restraint System to the seat.

3. Check that the child restraint is securely attached to the seat by pushing and pulling the seat forward and from side-to-side.

Securing a child restraint with a lap/shoulder belt

When not using the LATCH system, all child restraints must be secured to a vehicle rear seat with the lap part of a lap/shoulder belt.

Automatic locking mode



All passenger seat belts move freely under normal conditions and only lock under extreme or emergency conditions (emergency locking mode). So, in order to secure a child restraint, you must manually pull the seat belt all the way out to shift the retractor to the "automatic locking" mode.

The "automatic locking" mode will help prevent the normal movement of the child in the vehicle from caus-

ing the seat belt to loosen and compromise the CRS.

To install a CRS on the rear seats, do the following:

1. Place the CRS on a rear seat and route the lap/shoulder belt around or through the child restraint, following the restraint manufacturer's instructions. Be sure the seat belt webbing is not twisted.
2. Fasten the lap/shoulder belt latch into the buckle. Listen for the distinct "click" sound. Position the release button so that it is easy to access in case of an emergency.



3. Pull the shoulder portion of the seat belt all the way out. When the shoulder portion of the seat belt is fully extended, it will shift the retractor to the "automatic locking" (child restraint) mode.



4. Slowly allow the shoulder portion of the seat belt to retract and listen for an audible "clicking" or "ratcheting" sound. This indicates that the retractor is in the "automatic locking" mode. If no distinct sound is heard, repeat steps 3 and 4.



5. Remove as much slack from the belt as possible by pushing down on the CRS while feeding the shoulder belt back into the retractor.
6. Push and pull on the CRS to confirm that the seat belt is holding it firmly in place. If it is not, release the seat belt and repeat steps 2 through 6.

7. Double check that the retractor is in the "automatic locking" mode by attempting to pull more of the seat belt out of the retractor. If you cannot, the retractor is in the "automatic locking" mode.

If your CRS manufacturer instructs or recommends you to use a tether anchor with the lap/shoulder belt, refer to "Securing a child restraint seat with "Tether Anchor" system" on page 3-53 for more information.

*** NOTICE**

When the seat belt is allowed to retract to its fully stowed position, the retractor will automatically switch from the "automatic locking" mode to the emergency lock mode for normal adult usage.

⚠ WARNING

Auto lock mode

Set the retractor to Automatic Lock mode when installing any Child Restraint System. If the retractor is not in the automatic locking mode, the child restraint can move when your vehicle turns or stops suddenly. A child can be seriously injured or killed if the child restraint is not properly anchored in the car.

To remove the child restraint, press the release button on the buckle and then pull the lap/shoulder belt out of the restraint and allow the seat belt to retract fully.

Air bag – Advanced Supplemental Restraint System

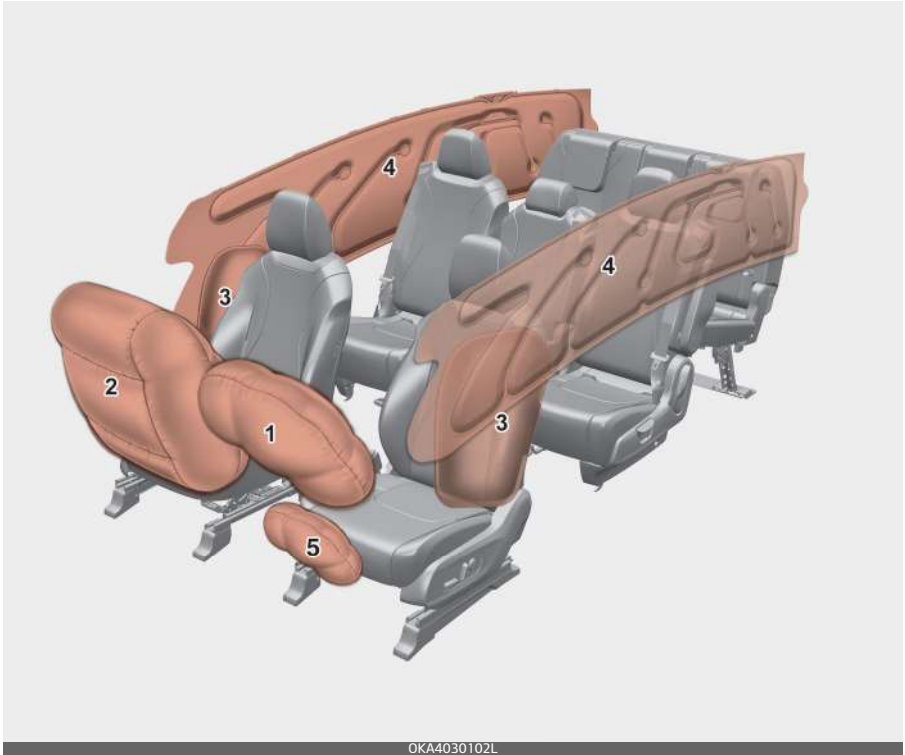

* The actual air bags in the vehicle may differ from the illustration.

1. Driver's front air bag
2. Passenger's front air bag
3. Side air bag
4. Curtain air bag
5. Driver's knee air bag

Even in vehicles with air bags, you and your passengers must always wear the safety belts provided in order to minimize the risk and severity of injury in the event of a collision or rollover.

How does the air bag system operate?

- Air bags are activated (able to inflate if necessary) only when the ignition switch or ENGINE START/STOP Button is in the ON Position and it can be activated within about 3 minutes after ignition off.
- The appropriate air bags inflate instantly in the event of a serious frontal collision or side collision in order to help protect the occupants from serious physical injury.
- There is no single speed at which the air bags will inflate. Generally, air bags are designed to inflate based upon the severity of a collision and its direction, etc. Several factors determine whether the sensors produce an electronic deployment/inflation signal.
- Air bags will not deploy in every crash or collision situations. Air bag deployment depends on a number of factors including vehicle speed, angles of impact, and, the density and stiffness of the vehicles or objects which your vehicle hits in the collision. The determining factors are not limited to those mentioned above.
- The front air bags will completely inflate and deflate in an instant. It is virtually impossible for you to see the air bags inflate during an accident. It is much more likely

that you will simply see the deflated air bags hanging out of their storage compartments after the collision.

- In addition to inflating in serious side collisions, side and/or curtain air bags will inflate if the sensing system detects a rollover.
- When a rollover is detected, side and/or curtain airbags will remain inflated longer. This helps provide protection from ejection, especially when used in conjunction with the seat belts.
- In order to help provide protection, the air bags must inflate rapidly. The airbag inflates extremely fast between the occupant and the vehicle structures before the occupant impacts the vehicle structures. This speed of inflation reduces the risk of serious or life-threatening injuries and is thus a necessary part of the air bag design. However, airbag inflation can also cause injuries which can include facial abrasions, bruises and broken bones. This is because the rapid inflation also causes the airbags to expand with a great deal of force.
- **There are even circumstances under which contact with the steering wheel or passenger air bag can cause fatal injuries, especially if the occupant is positioned**

excessively close to the steering wheel or passenger air bag.

⚠ WARNING

Airbag inflation

Sit as far back as possible from the steering wheel while still maintaining comfortable control of the vehicle. A distance of at least 25 cm (10 inches) from your chest to the steering wheel is recommended. Failure to do so can result in airbag inflation injuries to the driver.

Noise and smoke

When inflated, the air bags make a loud noise and leave smoke and powder in the air inside the vehicle. This is normal and is a result of the ignition of the air bag inflator. After the air bag inflates, you may feel substantial discomfort in breathing due to the contact of your chest with both the seat belt and the air bag, as well as from breathing the smoke and powder. **Open your doors and/or windows as soon as possible after impact in order to reduce discomfort and prevent prolonged exposure to the smoke and powder.**

Though smoke and powder are non-toxic, it may cause irritation to the skin (eyes, nose and throat, etc). If this is the case, wash and rinse with

cold water immediately and consult a doctor if the symptom persists.

⚠ WARNING

Hot components

Do not touch the air bag storage area's internal components immediately after airbag inflation. The air bag related parts in the steering wheel, instrument panel and the roof rails above the front and rear doors are very hot. Hot components can result in burn injuries.

⚠ WARNING

Do not install or place any accessories near air bag deployment areas, such as the instrument panel, windows, pillars, and roof rails.

Do not install a child restraint on the front passenger's seat



Never place a rear-facing child restraint in the front passenger's seat.

If the air bag deploys, it would impact the rear-facing child restraint, causing serious or fatal injury.

In addition, do not place front-facing child restraints in the front passenger's seat. If the front passenger air bag inflates, it could cause serious or fatal injuries to the child.

⚠ WARNING

Air bag deployment

When children are seated in the rear outboard seats of a vehicle equipped with side and/or curtain air bags, install the Child Restraint System as far away from the door side as possible. Inflation of the side and/or curtain air bags could impact the child.

Air bag warning and indicator

Air bag warning light

The purpose of air bag warning light in your instrument panel is to alert you of a potential problem with your air bag system, which could include your side and/or curtain air bags used for rollover protection.



If the air bag warning light is illuminated for more than 6 seconds after the ignition switch or ENGINE START/STOP button has been turned to the ON position, or if it illuminates during vehicle operation, an SRS component may not be functioning properly and you should have your vehicle checked by an authorized Kia dealer.

If any of the following conditions occur, this indicates a malfunction in the air bag system. Have an authorized Kia dealer inspect the air bag system as soon as possible.

- The light does not turn on briefly when you turn the ignition switch or ENGINE START/STOP button to the ON position.
- The light stays on after illuminating for approximately 3 ~ 6 seconds.
- The light comes on while the vehicle is in motion.
- The light blinks when the ignition switch or ENGINE START/STOP button to the ON position.

Supplemental Restraint System (SRS) components and functions

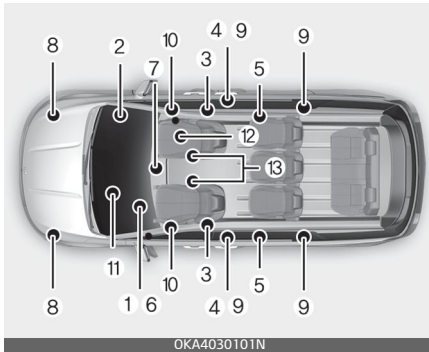

* The actual position of SRS components may differ from the illustration.

The SRS consists of the following components:

1. Driver's front air bag module
2. Passenger's front air bag module
3. Side air bag modules
4. Curtain air bag modules
5. Retractor pre-tensioner assemblies
6. Air bag warning light
7. SRS control module (SRSCM)/roll-over sensor
8. Front impact sensors
9. Side impact sensors
10. Side pressure sensors
11. Driver's knee air bag module
12. Occupant Detection System
13. Front driver/passenger's seatbelt buckle sensor

The SRSCM continually monitors all elements while the ignition switch or ENGINE START/STOP Button is in

the ON Position or approximately within 3 minutes after ignition off to determine if a frontal, near-frontal impact or side impact is severe enough to require air bag deployment or pre-tensioner seat belt deployment.

The SRS air bag warning light on the instrument panel will illuminate for about 3 ~ 6 seconds after the ignition switch or ENGINE START/STOP button is turned to the ON position, after which the air bag warning light should go out.

⚠ WARNING

If any of the following conditions occurs, this indicates a malfunction of the SRS. In this case, have the system inspected by an authorized Kia dealer.

- The light does not turn on briefly when you turn the ignition ON.
- The light stays on after illuminating for approximately 6 seconds.
- The light comes on while the vehicle is in motion.
- The light blinks when the ignition switch or ENGINE START/STOP button is in ON position.

Driver's front air bag (1)



The air bag modules are located both in the center of the steering wheel and in the front passenger's panel above the glove box and in the driver's side knee bolster. When the SRSCM detects a sufficiently severe impact to the front of the vehicle, it will automatically deploy the front air bags.

Driver's front air bag (2)



Upon deployment, tear seams molded directly into the pad covers will separate under pressure from the expansion of the air bags. Fur-

ther opening of the covers then allows full inflation of the air bags.

Driver's front air bag (3)



A fully inflated air bag, in combination with a properly worn seat belt, slows the driver's or the passenger's forward motion, reducing the risk of head and chest injury.

After complete inflation, the air bag immediately starts deflating, enabling the driver to maintain forward visibility and the ability to steer or operate other controls.

Passenger's front air bag



⚠ WARNING**Air bag obstructions**

Do not install or place any accessories on the steering wheel, instrument panel, or on the front passenger's panel above the glove box in a vehicle. Such objects may become dangerous projectiles if the air bag deploys.

⚠ WARNING**Flying objects**

Do not place any objects (an umbrella, bag, etc.) between the front door and the front seat. Such objects may become dangerous projectiles if the side airbag inflates.

- If an air bag deploys, there may be a loud noise followed by a fine dust released in the vehicle. These conditions are normal and are not hazardous – the air bags are packed in this fine powder. The dust generated during air bag deployment may cause skin or eye irritation as well as aggravate asthma for some persons. Always wash all exposed skin areas thoroughly with cold water and a mild soap after an accident in which the air bags were deployed.
- The SRS can function only when the ignition switch or ENGINE START/STOP button is in the ON Position or approximately within 3

minutes after ignition off. The SRS is not working properly if any of the following situations occur :

- the SRS airbag warning light does not illuminate
 - the SRS airbag warning light remains on continuously after illuminating for about 3 ~ 6 seconds when the ignition switch or ENGINE START/STOP button is turned to the ON position or after the vehicle is in ready mode
 - the SRS airbag warning light comes on while driving
- If this occurs, have your vehicle immediately inspected by an authorized Kia dealer.

*** NOTICE**

Before you replace a fuse or disconnect a battery terminal, turn the ignition switch or ENGINE START/STOP button to the OFF position. Never remove or replace the air bag related fuse(s) when the ignition switch or ENGINE START/STOP button is ON position. Failure to heed this warning will cause the SRS air bag warning light to illuminate.

Occupant Detection System (ODS)

Your vehicle is equipped with an Occupant Detection System (ODS) in the front passenger's seat.



The ODS is designed to detect the presence of a properly-seated front passenger and determine if the passenger's front air bag should be enabled (may inflate) or not. Only the front passenger front air bag is controlled by the ODS.

Do not put anything in front of the PASSENGER AIR BAG (⊗) indicator.

Main components of the ODS

- A detection device is located within the front passenger seat cushion.
- An electronic system determines whether the passenger air bag systems should be activated or deactivated.
- An indicator light located on the overhead console which illuminates the words PASSENGER AIR

BAG (⊗) indicates the front passenger air bag system is deactivated.

- The overhead console air bag warning light is interconnected with the ODS.

If the front passenger seat is occupied by a person that the system determines to be of appropriate size, and he/she sits properly (sitting upright with the seatback in an upright position, centered on the seat cushion with their seat belt on, legs comfortably extended and their feet on the floor), the PASSENGER AIR BAG (⊗) indicator will turn off and the front passenger's air bag will be able to inflate, if necessary, in frontal crashes.

You will find the PASSENGER AIR BAG (⊗) indicator on the overhead console. This system detects the conditions 1 ~ 4 in the following table and activates or deactivates the front passenger air bag based on these conditions.

Always be sure that you and all vehicle occupants are seated and restrained properly (sitting upright with the seat in an upright position, centered on the seat cushion, with the person's legs comfortably extended, feet on the floor, and wearing the safety belt properly)

for the most effective protection by the air bag and the safety belt.

The ODS may not function properly if the passenger takes actions which can defeat the detection system.

These include:

- Failing to sit in an upright position.
- Leaning against the door or center console.
- Sitting towards the sides or the front of the seat.
- Putting legs on the dashboard or resting them on other locations which reduce the passenger weight on the front seat.
- Improperly wearing the safety belt.
- Reclining the seatback.

Conditions and operation of the front passenger ODS

Condition detected by the occupant classification system	Indicator/Warning light		Devices
	"PASSENGER AIR BAG OFF" indicator light	SRS warning light	Front passenger air bag
1. Adult* ¹	Off	Off	Activated
2. Child Restraint System (CRS) with child under 12 months old* ² * ³ * ⁴	On	Off	Deactivated
3. Unoccupied	On	Off	Deactivated
4. Malfunction in the system	Off	On	Activated

* 1. The system judges a person of adult size as an adult. When a smaller adult sits in the front passenger seat, the system may recognize him/her as a child depending on his/her physique and posture.

* 2. Do not allow children to ride in the front passenger seat. When a larger child who has outgrown a CRS sits in the front passenger seat, the system may recognize him/her as an adult depending upon his/her physique or sitting position.

* 3. Never install a CRS on the front passenger seat.

* 4. The PASSENGER AIR BAG () indicator may turn on or off when a child above 12 months to 12 years old (with or without a CRS) sits in the front passenger seat. This is a normal condition.

⚠ WARNING

- Do not install a child restraint seat in the passenger seat when the seat is heavily soaked with any type of liquid.
- Do not alter or remodel the Occupant Detection System (ODS). This may damage the system and prevent its proper function in a collision.

*** NOTICE**

- Do not use car seat cushions that cover up the surface of the seat and aftermarket manufactured passenger seat heaters.
- After conducting car interior cleaning using steam or detergent, the seat should be dried properly. Afterward, check for normal operation of the PASSENGER AIR BAG "OFF" and air bag warning lights.
- Any service related to the passenger seat and the ODS must be done at an authorized Kia dealership.
- After the passenger seat has been removed or installed for repair purposes, check for normal operation of the PASSENGER AIR BAG  and air bag warning lights with a person seated or not seated in the passenger seat.

*** NOTICE**

When the PASSENGER AIR BAG  symbol is illuminated, the passenger air bag system will not operate. The passenger air bag system will operate when necessary if the symbol is not illuminated.

*** NOTICE**

Do not modify or replace the front passenger seat. Don't place anything on or attach anything such as a blanket, front seat cover or aftermarket seat heater to the front passenger seat. This can adversely affect the Occupant Detection System.

⚠ WARNING**Occupant Detection System**

Riding in an improper position adversely affects the Occupant Detection System and may result in the deactivation of the front passenger airbag. It is important for the driver to instruct the passenger as to the proper seating instructions as contained in this manual.

- Do not place a heavy load in the front passenger seatback pocket or on the front passenger seat.

Safety features of your vehicle

Air bag – Advanced Supplemental Restraint System



- Do not place feet on the front passenger seatback.



- Never place feet on the dashboard.



- Never sit with hips shifted towards the front of the seat.



- Never lean on the door or center console.
- Never sit on one side of the front passenger seat.



- Never excessively recline the front passenger seatback.



Safety features of your vehicle

Air bag – Advanced Supplemental Restraint System

- Do not use car seat accessories such as thick blankets and cushions which cover up the car seat surface.
- Do not sit on the passenger seat wearing heavily padded clothes such as ski wear and hip protector.



- Do not place electronic devices such as laptops, DVD player, or conductive materials such as water bottles on the passenger seat.
- Do not use electronic devices such as laptops and satellite radios which use inverter chargers.



- Wet passenger seat:
Do not spill liquid in the passenger seat. Spilled liquid on the passenger seat may cause the air bag warning light to illuminate or malfunction. If any liquid is spilled, make sure the seat has been completely dried before driving the vehicle.



Proper position





When an adult is seated in the front passenger seat, if the PASSENGER AIR BAG () indicator is on, change the ignition switch or ENGINE START/STOP button to the OFF

position and ask the passenger to sit properly (sitting upright with the seatback in an upright position, centered on the seat cushion with their seat belt on, legs comfortably extended and their feet on the floor). Restart the vehicle and have the person remain in that position. This will allow the system to detect the person and to enable the passenger air bag.

If the PASSENGER AIR BAG  indicator is still on, ask the passenger to move to the rear seat.

⚠ WARNING

PASSENGER AIR BAG  light

Do not allow an adult passenger to ride in the front seat when the PASSENGER AIR BAG  indicator is illuminated, because the air bag will not deploy in the event of a crash. The driver must instruct the passenger to reposition himself in the seat. Failure to properly position yourself may lead to air bag deactivation resulting in air bag non-deployment in a collision. If the PASSENGER AIR BAG  indicator remains illuminated after the passenger repositions themselves properly and the car is restarted, it is recommended that passenger move to the rear seat because the

passenger's front air bag will not deploy.

*** NOTICE**

The PASSENGER AIR BAG  indicator does not illuminate if the front passenger seat is occupied, the occupant detection sensor will then classify the front passenger after several more seconds. Also, if the ENGINE START/STOP button is turned to the ON position when about 3 minutes have elapsed since the vehicle is in OFF position.

- Even though your vehicle is equipped with the Occupant Detection System, never install a Child Restraint System in the front passenger's seat. A deploying air bag can forcefully strike a child resulting in serious injuries or death.

Any child age 13 and under should ride in the rear seat. Children too large for child restraints should use the available lap/shoulder belts. No matter what type of crash, children of all ages are safer when restrained in the rear seat.

If the ODS is not working properly, the Supplemental Restraint System (SRS) air bag warning light on the instrument panel will illuminate because the passenger's front air

bag is connected with the ODS. If there is a malfunction of the ODS the PASSENGER AIRBAG (⊗) indicator will not illuminate. In this case, the passenger's front airbag will inflate in frontal impact crashes even if there is no occupant in the front passenger seat.

Driver's and passenger's front air bag

Your vehicle is equipped with an advanced supplemental restraint (air bag) system and lap/shoulder belts at both the driver and passenger seating position.

Driver's front air bag



Driver's knee air bag



Passenger's front air bag



The indication of the function's presence are the letters "AIR BAG" located on the air bag pad cover on the steering wheel and on the cover of the driver's side knee bolster located below the steering wheel and the passenger's side front panel pad above the glove box.

The Supplemental Restraint System (SRS) consists of air bags installed under the pad covers in the center of the steering wheel, in the knee bolster below the steering wheel

column and the passenger's side front panel above the glove box.

The purpose of the SRS is to provide the vehicle's driver and/or the front passenger with additional protection than that offered by the seat belt system alone in case of a frontal impact of sufficient severity. The SRS uses sensors to gather information about the driver's and front passenger's seat belt usage and impact severity.

The seat belt buckle sensor determines if the front passenger's seat belt is fastened.

These sensors provide the ability to control the SRS deployment based on whether or not the seat belts are fastened, and how severe the impact is.

The advanced SRS offers the ability to control the air bag inflation with two levels. A first stage level is provided for moderate-severity impacts. A second stage level is provided for more severe impacts.

According to the impact severity and seat belt usage, the SRS Control Module (SRSCM) controls the air bag inflation. Failure to properly wear seat belts can increase the risk or severity of injury in an accident.

Additionally, your vehicle is equipped with an Occupant Detection System (ODS) in the front passenger's seat.

The ODS detects the presence of a passenger in the front passenger's seat and will turn off the front passenger's air bag under certain conditions. For more detail, see "Occupant Detection System (ODS)" on page 3-64.

WARNING

Modification to the seat structure is more likely to cause the air bag to deploy at a different level than should be provided.

Manufacturers are required by government regulations to provide a contact point concerning modifications to the vehicle for persons with disabilities, which modifications may affect the vehicle's advanced air bag system. That contact is Kia's toll-free Customer Experience Department at 1-877-KIA-AUTO (1-877-542-2886). However, Kia does not endorse nor will it support any changes to any part or structure of the vehicle that could affect the advanced air bag system, including the ODS.

WARNING

Replacement/modifications

The front passenger seat, dashboard or door should not be replaced except by an authorized Kia dealer using original Kia parts designed for

this vehicle and model. Any other such replacement or modification could adversely affect the operation of the Occupant Detection System and your advanced air bags.

Advanced air bags are combined with pre-tensioner seat belts to help provide enhanced occupant protection in frontal crashes. Front air bags are not intended to deploy in collisions in which sufficient protection can be provided by the seat belt.

* NOTICE

Air bags can only be used once – have an authorized Kia dealer replace the air bag immediately after deployment.

Front air bags are not intended to deploy in side-impact, rear-impact or rollover crashes. However, when frontal deployment threshold is satisfied at side-impact, front air bags may deploy. In addition, front air bags will not deploy in frontal crashes below the deployment threshold.

⚠ WARNING

SRS wiring

Do not tamper with or disconnect SRS wiring or other components of the SRS system. Doing so could

result in injury, due to accidental deployment of the air bags or by rendering the SRS inoperative.

⚠ WARNING

No attaching objects

No objects (such as crash pad cover, cellular phone holder, cup holder, perfume or stickers) should be placed over or near the air bag modules on the steering wheel, instrument panel, windshield glass, and the front passenger's panel above the glove box. Such objects could cause harm if the vehicle is in a crash severe enough to cause the air bags to deploy.

Do not place any objects over the air bag or between the air bag and yourself.

Additionally, never place or insert any object into any small opening near side airbag labels attached to the vehicle seats.

When the air bag deploys, the object may affect the deployment and result in unexpected accident or bodily harm.

Side air bag

Your vehicle is equipped with a side air bag in each front seat.

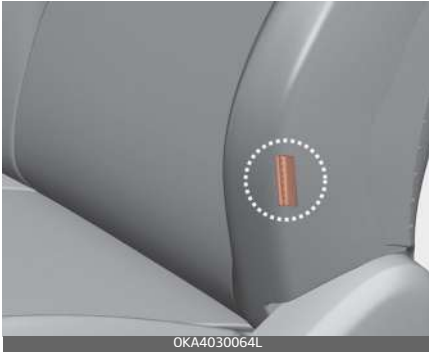

* The actual air bags in the vehicle may differ from the illustration.

The purpose of the air bag is to provide the vehicle's driver and/or the front passenger with additional protection than that offered by the seat belt alone.

- The side air bags are designed to deploy during certain side-impact collisions, depending on the crash severity of impact.

- The side air bags may deploy on the side of the impact or on both sides.
- The side and/or curtain air bags on both sides of the vehicle will deploy if a rollover or possible rollover is detected.
- The side air bags are not designed to deploy in all side impact or roll-over situations.

⚠ WARNING

Unexpected deployment

Avoid impact to the side impact air-bag sensor when the ignition switch or ENGINE START/STOP button is ON to prevent unexpected deployment of the side air bag.

- The side air bag is supplemental to the driver's and the passenger's seat belt systems and is not a substitute for them. Therefore your seat belts must be worn at all times while the vehicle is in operation.
- For best protection from the side air bag system and to avoid being injured by the deploying side air bag, both front seat occupants should sit in an upright position with the seat belt properly fastened. The driver's hands should be placed on the steering wheel at the 9:00 and 3:00 positions. The passenger's arms and hands should be placed on their laps.

⚠ WARNING

Deployment

Do not install any accessories including seat covers, on the side or near the side air bag as this may affect the deployment of the side air bags.

- If the seat or seat cover is damaged, have the vehicle checked and repaired by an authorized Kia dealer. Inform the dealer that your vehicle is equipped with side air bags and an Occupant Detection System (ODS).

⚠ WARNING

Flying objects

Do not place any objects (an umbrella, bag, etc.) between the front door and the front seat. Such objects may become dangerous projectiles if the side airbag inflates.

⚠ WARNING

No attaching objects

- Do not place any objects over the air bag or between the air bag and yourself. Also, do not attach any objects around the area the air bag inflates such as the door, side door glass, front and rear pillar.
- Do not put any objects between the side airbag label and seat cushion. It could cause harm if the

vehicle is in a crash severe enough to cause the air bags to deploy.

- Never place or insert any object into any small opening near side airbag labels attached to the vehicle seats. When the air bag deploys, the object may affect the deployment and result in unexpected accident or bodily harm.
- Do not install any accessories on the side or near the side air bags.

Curtain air bag

Curtain air bags are located along both sides of the roof rails above the front and rear doors.





* The actual air bags in the vehicle may differ from the illustration.

They are designed to help protect occupants in certain side impacts and to help prevent them from ejecting out of the vehicle as a result of a rollover, especially when the seat belts are also in use.

- The curtain air bags are designed to deploy during certain side impact collisions, depending on the severity of impact. However, when side deployment threshold is satisfied at front-impact, side air bags may deploy.
- The curtain air bags may deploy on the side of the impact or on both sides.
- Also, the curtain air bags on both sides of the vehicle will deploy in certain rollover situations.
- The curtain air bags are not designed to deploy in all side impact or rollover situations.

Do not allow the passengers to lean their heads or bodies against the doors, put their arms on the doors, stretch their arms out of the window or place objects between the doors and passengers when they are seated on seats equipped with side impact and/or curtain air bags.

*** NOTICE**

Never try to open or repair any components of the side and curtain air bag system. This should only be done by an authorized Kia dealer.

⚠ WARNING

No attaching objects

- Do not place any objects over the air bag. Also, do not attach any objects around the area the air bag inflates such as the door, side door glass, front and rear pillar, roof side rail.
- Do not hang hard, breakable, or heavy objects on the coat hooks for safety reasons.

Air bag collision sensors



OKA4030075N

1



OKA4030076N

2



OKA4030078N

3



OKA4030077

4



OKA4030079

* The actual shape and position of sensors may differ from the illustration.

1. Supplemental Restraint System (SRS) control module/rollover sensor*

2. Front impact sensor

3. Side impact sensors (B,C-pillar)

4. Side pressure sensors (front door)

* : if equipped

⚠ WARNING**Air bag sensors**

- Do not hit or allow any objects to impact the locations where air bags or sensors are installed. This may cause unexpected air bag deployment, which could result in serious personal injury or death.
- If the installation location or angle of the sensors is altered in any way, the air bags may deploy when they should not or they may not deploy when they should. Therefore, do not try to perform maintenance on or around the air bag sensors. Have the vehicle checked and repaired by an authorized Kia dealer.
- Do not arbitrarily touch the front impact sensor. When the angle of the sensor is changed, the air bag system may malfunction.

⚠ WARNING**If equipped with rollover sensor**

If your vehicle is equipped with side and curtain air bag, set the ignition switch or ENGINE START/STOP button to OFF or ACC position and wait for 3 minutes when the vehicle is being towed.

The side and curtain air bag may deploy when the ignitions is ON or

the ignition is OFF within 3 minutes, and the rollover sensor detects the situation as a rollover.

Problems may arise if the sensor installation angles are changed due to the deformation of the front bumper, front end module, body or front doors where side collision sensors are installed. Have the vehicle checked and repaired by an authorized Kia dealer.

Installing bumper guards (or side step or running board) or replacing a bumper (or front door module) with non-genuine parts may adversely affect your vehicle's collision and air bag deployment performance.

Why didn't my air bag go off in a collision? (Inflation and non-inflation conditions of the air bag)

There are many types of accidents in which the air bag would not be expected to provide additional protection.

These include rear impacts, second or third collisions in multiple impact accidents, as well as low speed impacts.

Air bag inflation conditions

Front air bags



Front air bags are designed to inflate in a frontal collision depending on several factors, including the severity of impact of the front collision.

Side and curtain air bags



* The actual air bags in the vehicle may differ from the illustration.

Side and/or curtain air bags are designed to inflate when an impact is detected by side collision sensors depending on several factors, including the severity of impact resulting from a side impact collision.

Also, the side and curtain air bags are designed to inflate when a rollover is detected by a rollover sensor.

Although the front air bags (driver's and front passenger's air bags) are primarily designed to inflate in frontal collisions, they may inflate in other types of collisions if the front impact sensors detect a sufficient frontal force in another type of impact.

Similarly, although side and curtain air bags are designed to inflate in certain side impact collisions, they may inflate in other types of collisions where a side force is detected

by the sensors. For instance, side air bag and/or curtain air bags may inflate if rollover sensors indicate the possibility of a rollover occurring (even if none actually occurs) or in other situations, including when the vehicle is tilted while being towed.

Even if side and/or curtain air bags do not provide impact protection in a rollover, they will deploy to prevent ejection of occupants, especially those who are restrained with seat belts.

If the vehicle chassis is impacted by bumps or objects on unimproved roads, the air bags may deploy. Drive carefully on unimproved roads or on surfaces not designed for vehicle traffic to prevent unintended air bag deployment.

*** NOTICE**

If equipped with rollover sensor

Also, the side and curtain air bags are designed to inflate when a roll-over is detected by a rollover sensor.

Air bag non-inflation conditions

- Air bags may not deploy in certain low-speed collisions where the air bag would not add any benefit beyond the protection already offered by the seat belts.



- Front air bags are not designed to inflate in rear collisions, because occupants are moved backward by the force of the impact. In this case, inflated air bags would not be able to provide any additional benefit.



- Front airbags may not inflate in side impact collisions, because passengers move in the direction of the collision. Thus, in side impacts, frontal airbag deployment would not provide additional occupant protection.



- In an angled collision, the force of impact may direct the occupants in a direction where the air bags would not be able to provide any additional benefit, and thus the sensors may not deploy any air bags.



- Just before impact, drivers often brake heavily. Such heavy braking lowers the front portion of the vehicle causing it to "ride" under a vehicle with a higher ground clearance. Air bags may not inflate in this "under-ride" situation because deceleration forces that are detected by sensors may

be significantly reduced by such "under-ride" collisions.

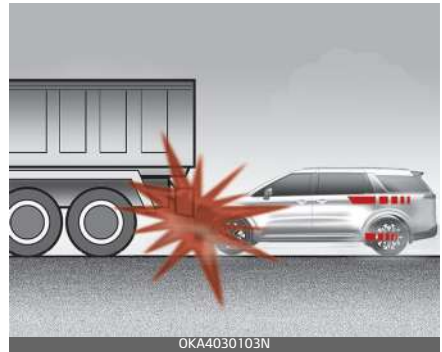

- Front air bags may not inflate in all rollover accidents when the SRS Control Module (SRSCM) indicates that the front air bag deployment would not provide additional occupant protection.

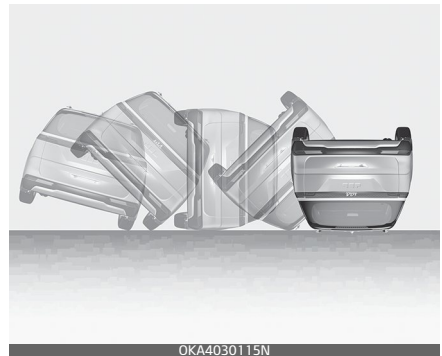

* NOTICE

If equipped with rollover sensor

However, if equipped with side and curtain air bags, the air bags may inflate in a rollover, when it is detected by the rollover sensor.

- Airbags may not inflate if the vehicle collides with an object such as a utility pole or tree. This is because the point of impact is concentrated in one area and the full force of the impact is not delivered to the sensors.



Supplemental Restraint System (SRS) care

The Supplemental Restraint System (SRS) is virtually maintenance-free and so there are no parts you can safely service by yourself.

If the SRS air bag warning light does not illuminate, or continuously remains on, have your vehicle immediately inspected by an authorized Kia dealer.

Any work on the SRS, such as removing, installing, repairing, or any work on the steering wheel, the front passenger's panel, front seats and roof rails must be performed by an authorized Kia dealer. Improper

handling of the SRS may result in serious personal injury.

For cleaning the air bag pad covers, use only a soft, dry cloth or one which has been moistened with plain water. Solvents or cleaners could adversely affect the air bag covers and proper deployment of the system.

If components of the air bag system must be discarded, or if the vehicle must be scrapped, certain safety precautions must be observed. An authorized Kia dealer knows these precautions and can give you the necessary information. Failure to follow these precautions and procedures could increase the risk of bodily injury.

⚠ WARNING

Tampering with SRS

Do not tamper with or disconnect SRS wiring or other components of the SRS system. Doing so could result in the accidental inflation of the air bag or render the SRS inoperative.

⚠ WARNING

Towing vehicle

Always have the ignition off and wait for 3 minutes when your vehicle is being towed. The side air bags may inflate if the vehicle is tilted

such as when being towed because of the rollover sensors in the vehicle.

Additional safety precautions

- **Never let passengers ride in the cargo area or on top of a folded-down back seat.** All occupants should sit upright, fully back in their seats with their seat belts on and their feet on the floor.
- **Passengers should not move out of or change seats while the vehicle is moving.** A passenger who is not wearing a seat belt during a crash or emergency stop can be thrown against the inside of the vehicle, against other occupants, or out of the vehicle.
- **Each seat belt is designed to restrain one occupant.** If more than one person uses the same seat belt, they could be seriously injured or killed in a collision.
- **Do not use any accessories on seat belts.** Devices claiming to improve occupant comfort or reposition the seat belt can reduce the protection provided by the seat belt and increase the chance of serious injury in a crash.
- **Passengers should not place hard or sharp objects between themselves and the air bags.** Carrying hard or sharp objects on your lap or in your mouth can result in injuries if an air bag inflates.
- **Keep occupants away from the air bag covers.** All occupants should sit upright, fully back in their seats with their seat belts on and their feet on the floor. If occupants are too close to the air bag covers, they could be injured if the air bags inflate.
- **Do not attach or place objects on or near the air bag covers.** Any object attached to or placed on the front or side air bag covers could interfere with the proper operation of the air bags.
- **Do not modify the front seats.** Modification of the front seats could interfere with the operation of the supplemental restraint system sensing components or side air bags.
- **Do not place items under the front seats.** Placing items under the front seats could interfere with the operation of the supplemental restraint system sensing components and wiring harnesses.
- **Never hold an infant or child on your lap.** The infant or child could be seriously injured or killed in the event of a crash. All infants and children should be properly restrained in appropriate child safety seats or seat belts in the rear seat.

⚠ WARNING

- Sitting improperly or out of position can cause occupants to be shifted too close to a deploying air bag, strike the interior structure or be thrown from the vehicle resulting in serious injury or death.
 - Always sit upright with the seat-back in an upright position, centered on the seat cushion with your seat belt on, legs comfortably extended and your feet on the floor.
-

Adding equipment to or modifying your air bag-equipped vehicle

If you modify your vehicle by changing your vehicle's frame, bumper system, front end or side sheet metal or ride height, this may affect the operation of your vehicle's air bag system.

Air bag warning labels

Air bag warning labels, some required by the Canada Motor Vehicle Safety Standards (CMVSS), are attached to the sun visor to alert the driver and passengers of potential risks of the air bag system.



Keys	4-8
• Remote key	4-8
• Smart key	4-10
• Battery replacement	4-15
Immobilizer system	4-17
• Folding key immobilizer system	4-17
• Smart key immobilizer system	4-18
Theft-alarm system	4-19
• Armed stage	4-19
• Theft-alarm stage	4-21
• Disarmed stage	4-21
Door locks	4-22
• With the smart key	4-22
• With the mechanical key	4-23
• Operating door locks from inside the vehicle	4-25
• Door lock/unlock features	4-27
• Child-protector rear door lock	4-27
• In case of an emergency	4-28
• Rear Occupant Alert (ROA) System	4-29
Driver Position Memory System	4-31
• Storing memory positions	4-32
• Recalling memory positions	4-32
• Driver position memory system reset	4-32
• Easy access function	4-33
Sliding door	4-34
Power sliding door	4-35
• Power sliding door operation	4-35
• Automatic stop and reversal	4-38

4 Features of your vehicle

• Power sliding door non-operating conditions	4-40
Power door ON/OFF button	4-40
Simultaneous Power Door	4-41
Smart Sliding Door with Auto Open	4-43
• How to use the Smart sliding door with auto open	4-43
• How to deactivate the smart sliding door with auto open function using the smart key	4-44
• Detecting area	4-45
Liftgate	4-46
• Opening the liftgate	4-46
• Closing the liftgate	4-47
• Emergency liftgate safety release	4-48
Power liftgate	4-49
• Opening the liftgate	4-51
• Closing the liftgate	4-52
• Power liftgate non-opening conditions	4-52
• How to reset the power liftgate	4-54
• Power liftgate speed adjustment	4-54
• Power liftgate opening height user setting	4-54
Liftgate Auto Close	4-55
• How to use the Liftgate Auto Close	4-55
• Releasing Liftgate Auto Close	4-56
Smart Liftgate with Auto Open	4-57
• How to use the Smart Liftgate with Auto Open	4-57
• How to deactivate the Smart Liftgate with Auto Open function using the smart key	4-58
• Detecting area	4-59
Windows	4-61

• Window opening and closing	4-63
• Power window lock button	4-64
Hood	4-66
• Opening the hood	4-66
• Hood open warning	4-67
• Closing the hood	4-67
Fuel filler door	4-68
• Opening the fuel filler door	4-68
• Closing the fuel filler door	4-69
Sunroof	4-73
• Sliding the sunroof	4-75
• Tilting the sunroof (front)	4-77
• Sunshade	4-78
• Resetting the sunroof	4-78
• Rear sunroof lock	4-78
• Sunroof open warning	4-79
Steering wheel	4-79
• Electric power steering (EPS)	4-79
• Tilt & telescopic steering wheel	4-80
• Heated steering wheel	4-81
• Horn	4-83
Mirrors	4-83
• Inside rear view mirror	4-83
• Outside rear view mirror	4-95
Instrument cluster	4-99
• Full LCD cluster	4-100
• Adjusting instrument cluster illumination	4-101
• Gauges	4-102
• Transmission shift indicator	4-106

4 Features of your vehicle

LCD display	4-107
• LCD display modes	4-108
LCD displays	4-117
• Trip information (trip computer)	4-117
• Service mode	4-120
• Driving info display	4-121
• LCD display messages	4-122
Warning lights and indicators	4-125
• Warning lights	4-125
• Indicator lights	4-131
Rear View Monitor (RVM)	4-135
• Function settings	4-135
• Function operation	4-136
• Malfunction and limitations	4-137
Surround View Monitor (SVM)	4-138
• Function settings	4-139
• Function operation	4-140
• Malfunction and limitations	4-142
Reverse Parking Distance Warning (PDW)	4-143
• Function settings	4-144
• Function operation	4-144
• Malfunction and limitations	4-145
Forward/Reverse Parking Distance Warning (PDW)	4-147
• Function settings	4-147
• Function operation	4-148
• Malfunction and limitations	4-150
Lighting	4-152
• Battery saver function	4-152

• Headlamp delay function	4-152
• Daytime Running Light (DRL)	4-153
• Lighting control	4-153
• Operating high beam	4-155
• Operating turn signals and lane change signals	4-156
• Operating front fog light	4-157
• High Beam Assist (HBA)	4-157
Wipers and washers	4-161
• Operating windshield washers	4-162
• Operating rear window wiper and washer switch	4-163
• Heated washer nozzle	4-163
Welcome system	4-164
Interior lights	4-165
• Automatic turn off function	4-165
• Map lamp	4-166
• Room lamp	4-167
• Luggage room lamp	4-167
• Vanity mirror lamp	4-168
• Glove box lamp	4-168
Climate control system	4-169
• System operation	4-169
• Climate control air filter	4-171
• Rear climate control air filter	4-171
• Checking the amount of air conditioner refrigerant and compressor lubricant	4-172
Manual climate control system	4-174
• Heating and air conditioning	4-176
Automatic climate control system	4-184
• Heating and air conditioning automatically	4-186

4 Features of your vehicle

- Heating and air conditioning manually 4-188
- Windshield defrosting and defogging..... 4-196**
- Defogging inside windshield with manual climate control system 4-197
- Defrosting outside windshield with manual climate control system 4-197
- Defogging inside windshield with automatic climate control 4-197
- Defrosting outside windshield with automatic climate control 4-198
- Auto defogging system (only for automatic climate control system)..... 4-198
- Defroster 4-199
- Front glass heater 4-200
- Defogging logic..... 4-201
- Activate upon Washer Fluid Use 4-202
- Scheduled Ventilation 4-203
- Storage compartment 4-203**
- Center console storage..... 4-205
- Glove box..... 4-205
- Interior features..... 4-206**
- Ambient light..... 4-206
- Cup holder 4-206
- Seat warmer..... 4-207
- Air ventilation seat 4-210
- Sun visor..... 4-211
- USB charger 4-211
- Power outlet..... 4-213
- AC Inverter..... 4-214
- Wireless smart phone charging system..... 4-215

• Coat hook	4-219
• Side curtain.....	4-219
• Floor mat anchors	4-220
• Luggage net holder	4-221
• Passenger view	4-221
Exterior features	4-222
• Roof rack.....	4-222
Infotainment system	4-224
• Audio system	4-224
Declaration of Conformity	4-227
• IC.....	4-227

Features of your vehicle

Keys

Record your key number



The key code number is stamped on the key code tag attached to the key set. Should you lose your keys, this number will enable an authorized Kia dealer to duplicate the keys easily. Remove the key code tag and store it in a safe place. Also, record the key code number and keep it in a safe and handy place, but not in the vehicle.

⚠ WARNING

Aftermarket keys

Use only Kia original parts for the ignition key in your vehicle. If an aftermarket key is used, the ignition switch or ENGINE START/STOP button may not return to ON after START. If this happens, the starter will continue to operate causing possible fire due to excessive current in the wiring.

Remote key (if equipped)

With a remote key, you can lock or unlock the door and liftgate.



Lock (1)

All doors are locked if the lock button is pressed. If all doors are closed, the hazard warning lights will blink and the chime will sound once to indicate that all doors are locked.

Also, if the lock button is pressed once more within 4 seconds, the hazard warning lights will blink and the chime will sound once to confirm that the door is locked.

However, if any door remains open, the hazard warning lights (and/or the chime) will not operate. But if all doors are closed after the lock button is pressed, the hazard warning lights will blink once.

Unlock (2)

The driver's door is unlocked if the unlock button is pressed once. The hazard warning lights will blink twice to indicate that the driver's door is unlocked.

All doors are unlocked if the unlock button is pressed once more within 4 seconds. The hazard warning lights will blink and the chime will sound twice again to indicate that all doors are unlocked. After pressing this button, the doors will lock automatically unless you open any door within 30 seconds.

If you attempt to lock or unlock the door by pressing the door lock/unlock button in any of the following states, the door will not be locked or unlocked.

- When you want to lock or unlock the door in the ACC or ON state.
- When you want to lock a door in a car with one or more doors open.

Depending on the vehicle, the driver can turn off or set the 2-press unlock setting function. For more information, see "User settings mode" on page 4-110.

*** NOTICE**

If the remote key is inoperative due to exposure to water or liquids, it will not be covered by your manufacturer's vehicle warranty.

Panic alarm (3)

The horn sounds and the hazard warning lights blink for about 30 seconds if this button is pressed for more than 0.5 seconds. To stop the horn and lights, press any button on the transmitter.

Mechanical key

If the remote key does not operate normally, you can lock or unlock the door by using the mechanical key.



To unfold the key, press the release button then the key will unfold automatically.

To fold the key, fold the key manually while pressing the release button.

⚠ CAUTION

Key button operation

Do not fold the key without pressing the release button. This may damage the key.

Transmitter precautions

The transmitter will not work if any of the following occurs:

- The ignition key is in the ignition switch.
- You exceed the operating distance limit. (about 10 m [32 ft].)
- The battery in the transmitter is weak.
- Other vehicles or objects may be blocking the signal.
- The weather is extremely cold.
- The remote key is close to a radio transmitter such as a radio station or an airport which can interfere with normal operation of the transmitter.

When the transmitter does not work properly, open and close the door with the ignition key. If you have a problem with the remote key, contact an authorized Kia dealer.

- If the transmitter is in close proximity to your cell phone or smart phone, the signal from the transmitter could be blocked by normal operation of your cell phone or smart phone. This is especially important when the phone is active such as making calls, receiving calls, text messaging, and/or sending/receiving emails. Avoid placing the remote key and your cell phone or smart phone in the same pants or jacket pocket

and maintain adequate distance between the two devices.

⚠ CAUTION

Transmitter

Keep the transmitter away from water or any liquid as, it can become damaged and not function properly.

*** NOTICE**

If the remote key is inoperative due to exposure to water or liquids, it will not be covered by your manufacturer's vehicle warranty.

Smart key (if equipped)

With a smart key, you can lock or unlock a door and even start the engine without inserting the key.

Type A



Type B



Type C



Lock (1)

All doors are locked if the lock button is pressed. If all doors are closed, the hazard warning lights will blink and the chime will sound once to indicate that all doors are locked.

Also, if the lock button is pressed once more within 4 seconds, the hazard warning lights will blink and the chime will sound once to confirm that the door is locked.

However, if any door remains open, the hazard warning lights (and/or

the chime) will not operate. But if all doors are closed after the lock button is pressed, the hazard warning lights will blink once.

Unlock (2)

The driver's door is unlocked if the unlock button is pressed once. The hazard warning lights will blink twice to indicate that the driver's door is unlocked.

All doors are unlocked if the unlock button is pressed once more within 4 seconds. The hazard warning lights will blink and the chime will sound twice again to indicate that all doors are unlocked. After pressing this button, the doors will lock automatically unless you open any door within 30 seconds.

If you attempt to lock or unlock the door by pressing the door lock/unlock button in any of the following states, the door will not be locked or unlocked.

- When you want to lock or unlock the door in the ACC or ON state.
- When you want to lock a door in a car with one or more doors open.

For some vehicles, you can remove or set the 2-press unlock (press it twice to unlock). For more information, see "User settings mode" on page 4-110.

* NOTICE

If the smart key is inoperative due to exposure to water or liquids, it will not be covered by your manufacturer's vehicle warranty.

Liftgate unlock/open (3) (if equipped)

If you press this button for longer than a second, the lock will be released or the liftgate will be unlocked or opened according to the options of the vehicle.

Once the liftgate is opened and then closed, the liftgate will lock automatically.

Panic alarm (4)

The horn sounds and the hazard warning lights blink for about 30 seconds if this button is pressed for more than 0.5 seconds. To stop the horn and lights, press any button on the transmitter.

Remote start (5)

You can start the vehicle using the remote start button (5) of the smart key.

To start the vehicle remotely:

- Lock the doors by pressing the door lock button (1) within 10 m (32 ft) distance from the vehicle.

- Press the remote start button for over 2 seconds within 4 seconds after locking the doors.

Press the remote start button once to turn off the vehicle.

If no further action for operating/driving the vehicle is taken, the vehicle will be turned off 10 minutes after starting the vehicle remotely.

Left or right power sliding door opening/closing (6, 7) (if equipped)

This function will be operated when the power door ON/OFF button is ON (not depressed).

Using the power sliding door handle

1. Carry the smart key.
2. Pull the power sliding door handle once.
3. The power sliding door will be opened or closed automatically. At this time, the hazard warning lights will blink and the chime will sound two times.

Using the button on the smart key

1. Press and hold the power sliding door opening or closing button (5, 6) more than 1 second.

For detailed information, refer to "Power sliding door (if equipped)" on page 4-35.

Start-up

You can start the vehicle without inserting the key.

* For more information, refer to "ENGINE START/STOP button (if equipped)" on page 5-11.

Mechanical key

If the smart key does not operate normally, you can lock or unlock the door by using the mechanical key.



To remove the mechanical key, press and hold the release button (1) and remove the mechanical key (2).

To reinstall the mechanical key, put the key into the hole and push it until a "click" sound is heard.

▲ WARNING

Smart key

Never leave the keys in your vehicle with unsupervised children. Leaving children unattended in a vehicle with

a manual ignition key or a smart key is dangerous.

Children copy adults and they could place the key in the ignition switch or press the start button. The key would enable children to operate power windows or other controls, or even make the vehicle move, which could result in serious bodily injury or death.

Smart key precautions

The smart key may not work if any of the following occur:

- The smart key is close to a radio transmitter such as a radio station or an airport which can interfere with normal operation of the smart key.
- The smart key is near a mobile two-way radio system or a cellular phone.
- Another vehicle's smart key is being operated close to your vehicle.

When the smart key does not work correctly, open and close the door with the mechanical key and contact an authorized Kia dealer.

If the smart key is in close proximity to your cell phone or smart phone, the signal from the smart key could be blocked by normal operation of your cell phone or smart phone. This is especially important when the phone is active, such as when mak-

ing calls, receiving calls, text messaging, and/or sending/receiving emails. Avoid placing the smart key and your cell phone or smart phone in the same pants or jacket pocket and maintain adequate distance between the two devices.

* NOTICE

Loss of the smart key

A maximum of 2 smart keys can be registered to a single vehicle.

If you happen to lose your smart key, you will not be able to start the vehicle. You should immediately take the vehicle and remaining key to your authorized Kia dealer (tow the vehicle, if necessary) to protect it from potential theft.

⚠ CAUTION

Transmitter

Keep the transmitter away from water or any liquid, as it can become damaged and not function properly.

* NOTICE

If the smart key is inoperative due to exposure to water or liquids, it will not be covered by your manufacturer's vehicle warranty.

* NOTICE

To prevent the electronic key from becoming damaged by magnetic fields, do not leave it near the following electrical appliances:

- TVs
- Personal computers
- Cellular phones, cordless phones and battery chargers
- Table lamps
- Induction cookers

* NOTICE

If you have to leave the vehicle's key with a parking attendant, remove the mechanical key for your own use and provide the attendant with the electronic key only.

* NOTICE

When bringing a smart key onto an airplane, make sure you do not press any button on the key while inside the cabin. If you are carrying the key in your bag etc., make sure that the buttons cannot be pressed accidentally. If you press a button, the key may emit radio waves that could interfere with the operation of the aircraft.

Battery replacement

The remote key or smart key uses a 3 volt lithium battery which will normally last for several years.



If you are unsure how to use or replace the battery, contact an authorized Kia dealer.

1. Detach mechanical key from your smart key.
2. Pry open the key cover.
3. Replace the smart key cover with a new battery. (CR2032) When replacing the battery, make sure the battery position is correct.
4. Install the battery in the reverse order of removal.

For remote key or smart key replacement, visit an authorized Kia dealer.

The remote key or smart key is designed to give you years of trouble-free use, however it can malfunction if exposed to moisture or static electricity. If you are unsure how to use or replace the battery, contact an authorized Kia dealer.

Using the wrong battery can cause the remote key or smart key to malfunction. Be sure to use the correct battery.



An inappropriately disposed battery can be harmful to the environment and human health. Dispose the battery according to your local law(s) or regulation.

⚠ WARNING

THIS PRODUCT CONTAINS A BUTTON BATTERY

If swallowed, a lithium button battery can cause severe or fatal injuries within 2 hours.

Keep batteries out of reach of children.

If you think batteries may have been swallowed or placed inside any part of the body, seek immediate medical attention.

⚠ CAUTION

Remote key/Smart key damage

The remote key or smart key can malfunction if dropped, exposed to moisture, static electricity, heat or direct sunlight.

⚠ WARNING**IC WARNING**

This device complies with Industry Canada licence-exempt RSS standard(s).

Operation is subject to the following two conditions:

1. This device may not cause interference, and
2. This device must accept any interference, including interference that may cause undesired operation of the device.

This device complies with Industry Canada licence-exempt RSS standard(s).

Operation is subject to the following conditions:

1. This device may not cause interference, and
2. This device must accept any interference, including interference that may cause undesired operation of the device.
3. Changes or modifications not expressly approved by the party responsible for compliance could void the user's authority to operate the device.

*** NOTICE**

Changes or modifications not expressly approved by the party responsible for compliance could

void the user's authority to operate the equipment. If the smart key is inoperative due to changes or modifications not expressly approved by the party responsible for compliance, it will not be covered by your manufacturer's vehicle warranty.

Immobilizer system

Folding key immobilizer system

Your immobilizer system is comprised of a small transponder in the ignition key and electronic devices inside the vehicle.

With the immobilizer system, whenever you insert your ignition key into the ignition switch and turn it to ON, it checks and determines and verifies that the ignition key is valid.

If the key is determined to be valid, the engine will start.

If the key is determined to be invalid, the engine will not start.

Deactivating the immobilizer system

Insert the ignition key into the key cylinder and turn it to the ON position.

Activating the immobilizer system

Turn the ignition key to the OFF position. The immobilizer system activates automatically. Without a valid ignition key for your vehicle, the engine will not start.

Your Immobilizer password is a customer unique password and should be kept confidential. Do not leave this number anywhere in your vehicle.

* NOTICE

Keep each key separately in order to avoid a starting malfunction.

* NOTICE

In order to prevent theft of your vehicle, do not leave spare keys anywhere in your vehicle. Your immobilizer password is a customer unique password should be kept confidential. Do not leave this number anywhere in your vehicle.

* NOTICE

- Do not put metal accessories near the ignition switch.
- Metal accessories may interrupt the transponder signal and may prevent the engine from being started.

* NOTICE

If you need additional keys or lose your keys, consult an authorized Kia dealer.

⚠ CAUTION**Immobilizer damage**

Do not expose your immobilizer system to moisture, static electricity or rough handling. This may damage your immobilizer.

⚠ CAUTION**Immobilizer alterations**

Do not change, alter or adjust the immobilizer system because it could cause the immobilizer system to malfunction.

Smart key immobilizer system

The immobilizer system protects your vehicle from theft. If an improperly coded key (or other device) is used, the vehicle's power system is disabled.

When the ENGINE START/STOP button is placed in the ON position, the immobilizer system indicator should come on briefly, then go off. If the indicator starts to blink, the system does not recognize the coding of the key.

Place the ENGINE START/STOP button in the OFF position, then place the ENGINE START/STOP button in the ON position again.

If the system repeatedly does not recognize the coding of the key, contact your Kia dealer.

Do not attempt to alter this system or add other devices to it. Electrical problems could result that may make your vehicle inoperable.

Deactivating the immobilizer system

Change the ENGINE START/STOP button to the ON position.

Activating the immobilizer system

Change the ENGINE START/STOP button to the OFF position. The immobilizer system activates automatically. Without a valid smart key for your vehicle, the engine will not start.

*** NOTICE**

When starting the vehicle, do not use the key with other immobilizer keys around. Otherwise, the vehicle may not start or may stop soon after it starts. Keep each key separate in order to avoid a starting malfunction.

*** NOTICE**

If you need additional keys or lose your keys, contact an authorized Kia dealer.

This device complies with Industry Canada licence-exempt RSS standard(s).

Operation is subject to the following two conditions:

1. This device may not cause interference, and
2. This device must accept any interference, including interference that may cause undesired operation of the device.

* NOTICE

Changes or modifications not expressly approved by the party responsible for compliance could void the user's authority to operate the equipment. If the smart key is inoperative due to changes or modifications not expressly approved by the party responsible for compliance, it will not be covered by your manufacturer's vehicle warranty.

Theft-alarm system

This system is designed to provide protection from unauthorized entry into the vehicle.

This system is operated in three stages:

- Armed stage
- Theft-alarm stage
- Disarmed stage

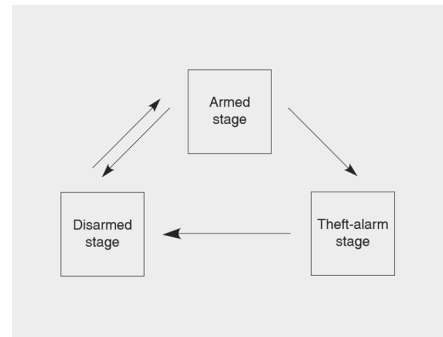

If triggered, the system provides an audible alarm with blinking of the hazard warning lights.

⚠ CAUTION

Do not attempt to alter this system or add other devices to it.

Armed stage

Using the remote key

Park the vehicle and stop the engine. Arm the system as described below.

1. Turn off the engine and remove the ignition key from the ignition switch.
2. Make sure that all doors (and lift-gate) and the engine hood are closed and latched.
3. Lock the doors by pressing the lock button on the folding key.

After completion of the steps above, the hazard warning lights will blink once to indicate that the system is armed.

If any door (and liftgate) or engine hood remains open, the hazard warning lights won't operate and theft-alarm will not arm. After this, if all doors (and liftgate) and engine hood are closed, the hazard warning lights blink once.

Using the smart key

Park the vehicle and stop the engine. Arm the system as described below.

1. Turn off the engine.
2. Make sure that all doors, the hood and liftgate are closed and latched.
3. Lock the doors by pressing the button of the front outside door handle with the smart key in your possession. After completion of the steps above, the hazard warning lights will operate once to indicate that the system is armed. If any door (or liftgate) or

hood remains open, the hazard warning lights and the chime will not operate and the theft-alarm will not arm. If all doors and lift-gate and hood are closed after the lock button is pressed, the hazard warning lights blink once. The system can also be armed by locking the doors with the key from the front doors; however, the hazard warning lights will not blink using this method.

4. Lock the doors by pressing the lock button on the smart key. After completion of the steps above, the hazard warning lights will operate once to indicate that the system is armed.

*** NOTICE**

The theft-alarm system can be deactivated by an authorized Kia dealer.

If you want this feature, consult an authorized Kia dealer.

*** NOTICE**

Do not arm the system until all passengers have left the vehicle. If the system is armed while a passenger(s) remains in the vehicle, the alarm may be activated when the remaining passenger(s) leaves the vehicle. If any door (or liftgate) or hood is opened within 30 seconds after the system enters the armed

stage, the system will be disarmed to prevent unnecessary alarm.

Theft-alarm stage

The alarm will be activated if any of the following occurs while the system is armed.

- A front or rear door is opened without using the smart key.
- The liftgate is opened without using the smart key.
- The hood is opened.

The horn will sound and the hazard warning lights will blink continuously for approximately 27 seconds, and repeat the horn 3 times unless the system is disarmed. To turn off the system, unlock the doors with the folding key or smart key.

Disarmed stage

The system will be disarmed when:

Using the remote key

- The door unlock button is pressed.
- The engine is started. (within 3 seconds)
- The ignition switch is in the "ON" position for 30 seconds or more.

Using the smart key

- The door unlock button is pressed.

- The button of the front outside door is pressed while carrying the smart key.
- The engine is started. (within 3 seconds)

After pressing the unlock button, the hazard warning lights will blink and the chime will sound twice (in smart key) to indicate that the system is disarmed.

After pressing the unlock button, if any door (or liftgate) is not opened within 30 seconds, the system will be rearmed.

* NOTICE

- Avoid trying to start the engine while the alarm is activated. The vehicle starting motor is disabled during the theft-alarm stage. If the system is not disarmed with the folding key, insert the key into the ignition switch, turn the ignition switch to the ON position and wait for 30 seconds. Then the system will be disarmed.
- If you lose your keys, consult your authorized Kia dealer.

⚠ CAUTION

Adjusting alarm system

Do not change, alter or adjust the theft alarm system in your vehicle. Improper installation of the alarm

system could damage the vehicle or cause the system to malfunction.

* NOTICE

Malfunctions caused by improper alterations, adjustments or modifications to the theft-alarm system are not covered by your vehicle manufacturer warranty.

Door locks

Know how to use the door lock so that you can lock or unlock the door if necessary.

With the smart key

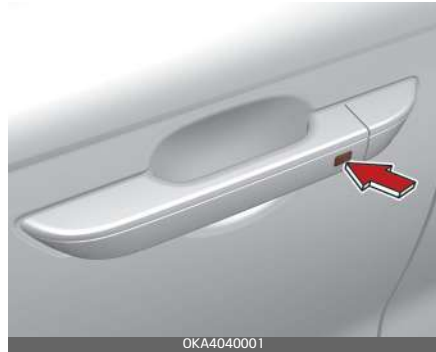

Carrying the smart key, you may lock and unlock the vehicle doors (and liftgate). Also, you may start the engine. Refer to the following for more details.

Locking

Pressing the button of the front driver side door handles with all doors closed and any door unlocked, locks all the doors. If all doors and engine hood are closed, the hazard warning lights will blink once to indicate that all doors are locked.

The button will only operate when the smart key is within 0.7 ~ 1 m (28 ~ 40 inches) from the driver side door handle. If you want to make sure that a door has locked or not,

you should pull the driver side door handle.

Even though you press the driver side door handle buttons, the doors will not lock and the chime will sound for 3 seconds if any of following occur:

- The smart key is in the vehicle.
- The ignition switch or ENGINE START/STOP button is in the ACC or ON position.
- Any door except the liftgate is open.

Unlocking

Pressing the button of the front driver side door handles with all doors closed and locked, unlocks all the doors. The hazard warning lights blink twice to indicate that all doors are unlocked.

The button will only operate when the smart key is within 0.7 ~ 1 m (28 ~ 40 inches) from the front driver side door handle.

When the smart key is recognized in the area of 0.7 ~ 1 m (28 ~ 40 inches) from the front driver side door handle, other people can also open the door without possession of the smart key.

After pressing the button, the doors will lock automatically unless you open any door within 30 seconds.

With the mechanical key



1. Pull out the door handle.
 2. Press the lever (1) located inside the bottom part of the cover with a key or flat-head screwdriver.
 3. Push out the cover (2) while pressing the lever (only the driver's door can be locked/unlocked).
 4. Turn the key toward the rear of the vehicle to unlock and toward the front of the vehicle to lock. Only the driver's door can be locked or unlocked.
- Doors can also be locked and unlocked with the transmitter.
 - Once the doors are unlocked, they may be opened by pulling the door handle.
 - When closing the door, push the door by hand. Make sure the doors are closed securely.

*** NOTICE**

- When locking the door with a mechanical key, be aware that only the driver's door can be locked/unlocked.
- To lock all doors, operate the central lock switch inside the vehicle. Open the car door using the inner handle, then close the door and lock the driver's door with a mechanical key.
- Refer to "Operating door locks from inside the vehicle" on page 4-25 to lock from inside the vehicle.

*** NOTICE**

- Be careful not to lose or scratch the cover when removing it.
- When the key cover freezes and does not open, tap it lightly or indirectly warm (hand temperature, etc.) it up.
- Do not apply excessive force to the door and door handle. It may be damaged.

*** NOTICE**

- In cold and wet climates, door lock and door mechanisms may not work properly due to freezing conditions.
- If the door is locked/unlocked multiple times in rapid succession with either the vehicle key or door

lock switch, the system may stop operating temporarily in order to protect the circuit and prevent damage to system components.

⚠ WARNING

- Securely close your door before you begin driving. Failure to fully close your door may cause it to open during vehicle operation.
- Keep your body out of the way of the closing door to prevent injuries.

⚠ WARNING

If any passengers must remain in the vehicle while it is very hot or cold outside, there is risk of injuries or danger to life. Do not lock the vehicle from the outside when there are passengers in the vehicle.

⚠ CAUTION

Do not unnecessarily open and close the door repeatedly or with excessive force. Such action can damage the vehicle door.

* NOTICE

Always place the ENGINE START/STOP button in the OFF position, engage the parking brake, close all windows, and lock all doors when leaving your vehicle unattended.

* NOTICE

Always remove the ignition key, engage the parking brake, close all windows, and lock all doors when leaving your vehicle unattended.

Operating door locks from inside the vehicle

You can operate door locks with the door lock handle or central door lock switch.

With the door handle



- Front door
If the inner door handle is pulled when the door is locked, the door will unlock and open.

Door lock malfunction

If a power door lock ever fails to function while you are in the vehicle, try one or more of the following techniques to exit:

- Operate the door unlock feature repeatedly (both electronic and manual) while simultaneously pulling on the door handle.
- Operate the other door locks and handles, front and rear.
- Lower a front window and use the key to unlock the door from outside.
- Move to the cargo area and open the liftgate.

⚠ WARNING

Do not pull the inner door handle of driver's (or passenger's) door while the vehicle is moving.

With central door lock switch

Driver side

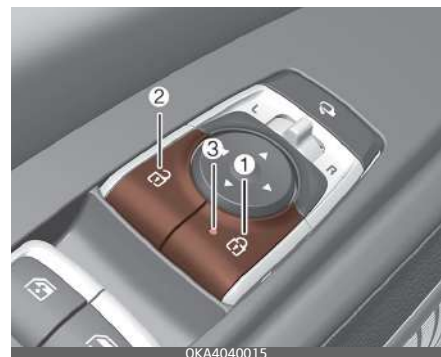

Passenger side

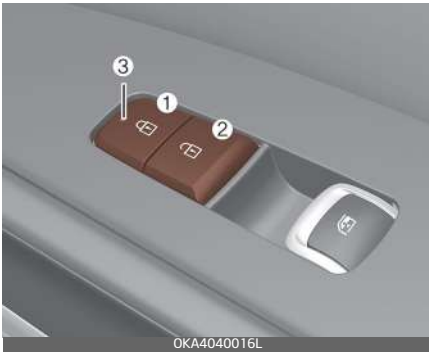

- 1. Door Lock
- 2. Door Unlock
- 3. Doors indicating light

Operate by pressing the central door lock switch.

- To lock all vehicle doors, press the central door lock switch (1) of driver and passenger side.
- To unlock all vehicle doors, press central door unlock switch (2) of driver and passenger side.

When all vehicle doors are locked, the indicating lights (3) on the driver's door and passenger's door will turn on. If any door is unlocked, it would go off.

With the door lock button

If the key is in the ignition switch (or if the smart key is in the vehicle) and any door is opened, the doors will not lock even though the central door lock switch is pressed.

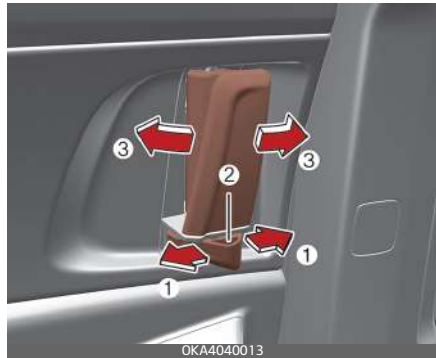

- To unlock a door, push the door lock button (1) to the "Unlock" position. The red mark (2) on the button will be visible.
- To lock a door, push the door lock button (1) to the "Lock" position. If the door is locked properly, the red mark (2) on the door lock button will not be visible.
- To open a door, pull the door handle (3) backward.
- To close a door, pull the door handle (3) forward.
- Front door cannot be locked if the ignition key is in the ignition switch (or if the smart key is in the vehicle) and the front door is opened.

⚠ WARNING**Doors**

- The doors should always be fully closed and locked while the vehicle is in motion to prevent accidental opening of the door. Locked doors will also discourage potential intruders when the vehicle stops or slows down.
- Be careful when opening doors and watch for vehicles, motorcycles, bicycles or pedestrians approaching the vehicle in the path of the door. Opening a door when something is approaching can cause damage or injury.

*** NOTICE****Unlocked vehicles**

Leaving your vehicle unlocked can invite theft or possible harm to you or others from someone hiding in your vehicle while you are gone. Always remove the ignition key, engage the parking brake, close all windows and lock all doors when leaving your vehicle unattended.

⚠ WARNING**Unattended children/animals**

Never leave children or animals unattended in your vehicle. An enclosed vehicle can become extremely hot, causing death or

severe injury to unattended children or animals who cannot escape the vehicle.

Door lock/unlock features

The vehicle is equipped with door lock/unlock features for the safety and convenience of passengers.

Impact sensing door unlock system

All doors will automatically unlock when an impact causes the air bags to deploy.

Child-protector rear door lock

The child safety lock is provided to help prevent children from accidentally opening the rear doors from inside the vehicle.

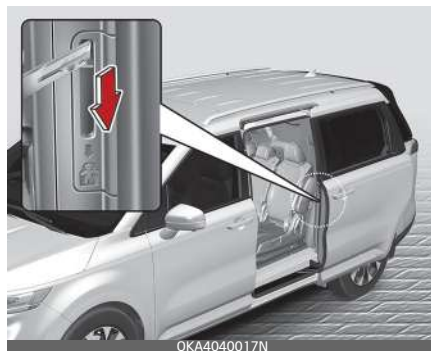

The rear door safety locks should be used whenever children are in the vehicle.

1. Open the rear door.
2. Push the child safety lock located on the rear edge of the door to

the lock (🔒) position. When the child safety lock is in the lock position, the rear door will not open even though the inner door handle is pulled.

3. Close the rear door.

To open the rear door, pull the outside door handle.

Even though the doors may be unlocked, the rear door will not open by pulling the inner door handle until the rear door child safety lock is unlocked.

⚠️ WARNING

Rear door locks

If children accidentally open the rear doors while the vehicle is in motion, they could fall out and be severely injured or killed. To prevent children from opening the rear doors from the inside, the rear door safety locks should be used whenever children are in the vehicle.

⚠️ WARNING

- The system does not detect every obstacle approaching the vehicle exit.
- The driver and passenger are responsible for the accident occurred while exiting the vehicle. Always check the surrounding before you exit the vehicle.

In case of an emergency

If the electrical power door lock switch is not operating (e.g., dead car battery) the only way to lock the door(s) is with the mechanical key from the outside key hole.

Doors without an outside key hole can be locked as follows:

1. Open the door.
2. Insert the key into the emergency door lock hole and turn the key to the lock position as shown.



3. Close the door securely.

* NOTICE

If the electrical power to door lock switch is not operating (e.g., dead car battery) and the liftgate is closed, you will not be able to open the liftgate until power is restored.

Rear Occupant Alert (ROA) System

The Rear Occupant Alert (ROA) is provided to help prevent exiting the vehicle with a rear passenger left in the vehicle.

Operation

You can activate or deactivate the ROA from the User Settings mode in the cluster LCD display.

The option can be found under the following menu:

1. Press the MODE button (📄) several times on the steering wheel until 'User Settings' menu appears on the LCD.
2. Select 'Convenience → Rear Occupant Alert' with the MOVE switch (↖↗) and the OK button on the steering wheel.

If your vehicle is equipped with the infotainment system, the option can be found under the following menu:

1. Press the SETUP button of the infotainment system.
2. Press 'Vehicle → Convenience → Rear Occupant Alert' on the infotainment system screen.

1st alert

When you open the front door after opening and closing the rear door and turning off the engine, the "Check rear seats" warning message appears on the cluster.



⚠ WARNING

The Rear Occupant Alert (ROA) system does not actually detect objects or people in the rear seat. By using a rear door opened and closed history, the system informs the driver that there may be something in the rear seat.

* NOTICE

The Rear Occupant Alert (ROA) uses a rear door opened and closed history. The history is reset after the driver turns off ignition exits the vehicle and locks the door remotely using the remote keyless entry. So even if a rear door does not reopen, the ROA system alert can occur. For example, after the ROA occurs if the driver does not lock the door, and drives again, the alert can occur.

⚠ WARNING

The door lock system may not work if the electrical system is compromised. Accordingly, please train children passengers regarding how to open the car door manually before an emergency situation arises. That way, they would be able to open the door manually in the event an emergency situation arises.

2nd alert (if equipped)

- After the 1st alert, the 2nd alert operates when any movement is detected in the rear seat after the driver's door is closed and all the doors are locked. The horn will activate for about 25 seconds. If the system continues to detect a movement the alert operates up to 8 times. UVO service users will receive a text message in UVO application. (if equipped)
- Unlock the door with the remote key or smart key to stop the alert.
- The system detects movement in the vehicle for 24 hours after the door is locked.

The 2nd alert is activated only after the prior activation of the 1st alert.

*** NOTICE**

- Make sure that all the windows are closed. If the window is open, the alert may activate by the sensor detecting an unintended movement (e.g., wind or bugs).



OMQ4AH040553

- If you do not want to use the Rear Occupant Alert (ROA) system, press OK button on the steering wheel when the 1st alert is displayed on the cluster. Doing so will deactivate the 2nd alert once.
- If boxes or objects are stacked in the vehicle, the system may not detect the obstacle. Also, the warning may generate if the box or object falls off.
- The sensor may not operate normally if the sensor is obscured by foreign substances.
- The alert may activate if movement in the driver or passenger seat is detected.
- The alert may activate with the doors locked due to car wash or surrounding vibration or noise.

- Inside movement detection is stopped under remote start status.

⚠ WARNING

- Even if your vehicle is equipped with the Rear Occupant Alert (ROA) system, always make sure you check the rear seat before you get off the vehicle.

The alert may not operate if:

- The movement does not continue for a certain period of time or the movement is small.
- If a child sits on a vehicle seat without a child car seat.
- The rear passenger is covered with an obstacle such as a blanket.
- Also, always be cautious of the passenger's safety as the detection function and 2nd alert may not operate depending on the surrounding environment and certain conditions.

⚠ WARNING

The door lock system may not work if the electrical system is compromised. Accordingly, please train children passengers regarding how to open the car door manually before an emergency situation arises. That way, they would be able to open the door manually in the event an emergency situation arises.

Driver Position Memory System (if equipped)

The Driver Position Memory System is provided to store and recall the following memory settings with a simple button operation.



- Driver's seat position
- Outside rear view mirror position

⚠ WARNING

Never attempt to operate the driver position memory system while the vehicle is moving.

This could result in loss of control, and an accident causing death, serious injury, or property damage.

*** NOTICE**

- If the battery is disconnected, the memory settings will be erased.
- If the Driver Position Memory System does not operate normally, have the system checked by an authorized Kia dealer.

Storing memory positions

1. The ignition switch or ENGINE START/STOP button is in the ON position.
2. Adjust the driver's seat position, outside rear view mirror position and instrument panel illumination intensity to the desired position.
3. Press the SET button. The system will beep once and notify you "Press button to save settings" on the LCD display.
4. Press one of the memory buttons (1 or 2) within 4 seconds. The system will beep twice when the memory has been successfully stored.
5. "Settings 1 (or 2) saved" will appear on the LCD display.

Recalling memory positions

1. The ignition switch or ENGINE START/STOP button is in the ON position.
2. Press the desired memory button (1 or 2). The system will beep once, and then the driver's seat position, outside rear view mirror position, instrument panel illumination intensity and head-up display height/brightness will automatically adjust to the stored positions.
3. "Settings 1 (or 2) applied" will appear on the LCD display.
 - While recalling the "1" memory position, pressing the SET or 1

button temporarily stops the adjustment of the recalled memory position. Pressing the 2 button recalls the "2" memory position.

- While recalling the "2" memory position, pressing the SET or 2 button temporarily stops the adjustment of the recalled memory position. Pressing the 1 button recalls the "1" memory position.
- While recalling the stored positions, pressing one of the control buttons for the driver's seat, outside rear view mirror, or instrument panel illumination will cause the movement of that component to stop and move in the direction that the control button is pressed.

Driver position memory system reset

If the Driver position memory system does not work properly, initialize the system as follows.

How to initialize:

1. Stop the vehicle and open the driver's door with the ignition switch or ENGINE START/STOP button in the ON position and the vehicle shifted to P (Park).
2. Pull the driver's seat forward as far as possible and have the seat-back upright as much as possible using the driver's seat forward/

backward adjustment and seat-back angle (recline) switches.

3. Push the SET button and seat forward movement switch for 2 seconds simultaneously.

Initialization in the process:

1. Initialization begins as the alarm sounds.
2. The seat and seatback will automatically move backwards. The alarm sound will continue while the system is in operation.
3. Initialization will be complete after the seat and seatback move to the center with an alarm sound. If, however, cases as follows occur, the initialization process will come to a stop and the alarm sound will stop as well.
 - When pushing driving position memory system button
 - When pushing driver's seat height adjustment switch
 - When shifting from P (Park) to other positions
 - When driving speed exceeds 3 km/h
 - When the driver's door is closed

Easy access function

The system will move the driver's seat automatically as follows:

Without smart key system

- It will move the driver's seat rearward when the ignition key is

removed and the driver's door is opened.

- It will move the driver's seat forward when the ignition switch or ENGINE START/STOP button is in the ACC or ON position.

With smart key system

- It will move the driver's seat rearward when the ENGINE START/STOP button is in the OFF position and the driver's door is opened.
- It will move the driver's seat forward when the vehicle is turned ON or the driver's door is closed with the smart key with you.

You can activate or deactivate the Easy Access Function from the User Settings Mode on the LCD display. For more details, refer to "User settings mode" on page 4-110. If your vehicle is equipped with additional navigation, please refer to the infotainment system manual separately supplied.

* NOTICE

Upward/downward movement of the seat may not work when passengers get on/off the vehicle in order to prevent foot injuries in certain places.

Sliding door

Opening the sliding door



- Once the doors are unlocked, it may be opened by pulling the door handle and sliding the door towards the rear of the vehicle (for manual sliding doors).
- Once the doors are unlocked, it may be opened by pulling the door handle once. And then the sliding door will be opened (for power sliding doors).

Closing the sliding door

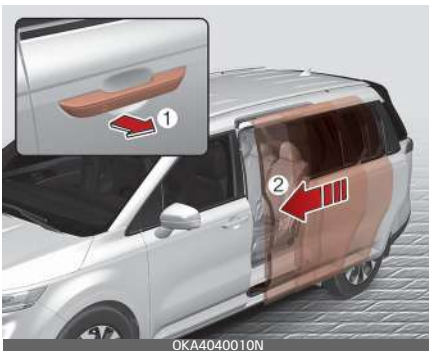

- When the door is fully open, the door will lock into an open position. To close the door, pull out the door handle (1) and sliding the door (2) towards the front of vehicle (for manual sliding doors).
- When the door is fully open, the door will lock into an open position. To close the door, pull out the door handle (1) once. And then the sliding door will be closed (for power sliding doors).

Sliding door spot lamp (if equipped)



The spot lamp located in each sliding door illuminate the surroundings for safe exit and entry.

⚠ WARNING

Partially opened sliding door

When opening the rear sliding doors, make sure the doors are fully opened and locked in position. The rear sliding doors may move unintentionally causing injuries if the doors are only partially opened.

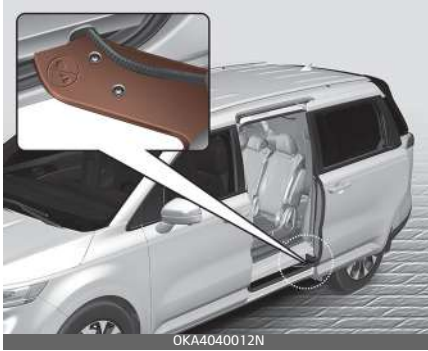
⚠ CAUTION**Sliding door hinge**

When getting in and out of the sliding door, do not step on the sliding door hinge or drop or put heavy objects on the hinge. The door may not open or close normally by damaging the door hinge or wire part.

⚠ CAUTION

The left sliding door cannot be opened when the fuel filler door is open. However, if the fuel filler door is opened after the door is opened slightly, the left sliding door can slide backward. Close the left sliding door to prevent possible damage to the door or the fuel filler door.

Power sliding door (if equipped)

The power sliding doors can be opened and closed automatically with the folding key or smart key, the main control buttons on the left side of the dashboard or the sub-control buttons on the center B-pillar trim.

Power sliding door operation**Smart key**

Press and hold the power sliding door open (or close) button for more than 1 second on the folding key or smart key to open the sliding doors automatically.

⚠ WARNING**Power sliding door**

Before operating the power sliding door, make sure no person or object is around the door.

Otherwise, it may cause serious damage to objects or occupants.

Double check the door is closed and latched before driving.

Do not leave children or pets unattended near the power door buttons.

Keep power door switch "OFF" when door is not in use.

Dashboard



Push the driver's side door button (1) or passenger's side door button (2) to open or close the power sliding door. However, you can operate the power sliding door by using the switch even when every sliding door and liftgate is locked and closed. This function will not operate when the vehicle is in theft alarm stage.

Center pillar trim

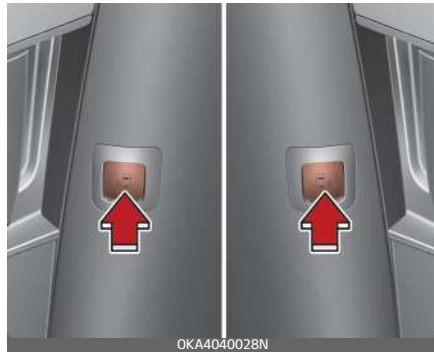

When the LED indicator of the power door ON/OFF button is OFF, follow the directions below to open or close the power sliding doors:

- Push the corresponding sub control button on the center pillar trim.
- Push the corresponding sub control button on the outside handle.
- Pull the door handle from inside or outside vehicle.
- If the sub control button is pushed while the door is locked or child safety lock is engaged, the chime sounds once, and the power sliding door will not open.

- If the door handle is pulled from inside or outside while the door is locked and child safety lock is engaged, the power sliding door will not open. However, the power sliding door can be opened by pulling the outside door handle or pushing the corresponding sub control button on the outside handle while the door is unlocked and child safety lock is engaged.

When the LED indicator of the power door ON/OFF button is ON, the power sliding door cannot be controlled with the sub control buttons or door handles, and if the sub control button is pushed, chime sounds once.

However, the doors can be opened and closed manually by pulling the door handles from inside or outside the vehicle.

* NOTICE

On a steep grade, the power sliding door will slide faster when closing. And the drive unit motor may operate additionally for a moment after the door is closed. This is a normal operation to ensure door closing, not a malfunction.

⚠ WARNING

Use the rear door safety locks whenever children are in the vehicle.

If a child accidentally opens the rear doors while the vehicle is moving, the children can fall out.

When the rear passenger operates the power sliding door, make sure there are no people or objects around the door, and have all occupants get in or out of the vehicle after the door is open fully and stopped. Let the rear passengers get in or out of the vehicle after the door is open fully. Sudden closing could cause a serious injury. Close the door by pulling the door handle after the door is fully opened. Do not pull the door handle while rear passengers are getting in or out. The door could suddenly close by itself and cause a serious injury. It takes about 5 seconds for the power sliding door to close and latch completely.

⚠ CAUTION

Be careful that the rear sliding doors may open by unintentionally by pressing the button.

⚠ WARNING

Do not accelerate before the door closes and latches completely. If the door is not completely closed while the vehicle is moving, the door can

open and passengers can fall out of the vehicle.

If the power sliding door is not closed and latched completely after power closing operation, the chime sounds 4 times. Open and close the door again.

If the power sliding door is operated while the door is in partially opened position, the door is fully opened.

If the power sliding door is operated while the door is in half-opened position, the door is completely closed.

If the power sliding door is operated again while the door is closing, the door is fully opened.

If the power sliding door is operated again while the door is opening, the door is automatically closed completely. However, if the power sliding door is operated again when the door is in partially opened position, the door is opened continuously.

The half-opened power sliding door is automatically opened or closed fully by pushing the door forward or backward without pulling the door handle while the LED indicator of the power door ON/OFF button is OFF. However, when the door is in partially opened position, the door is not automatically closed.

Automatic stop and reversal

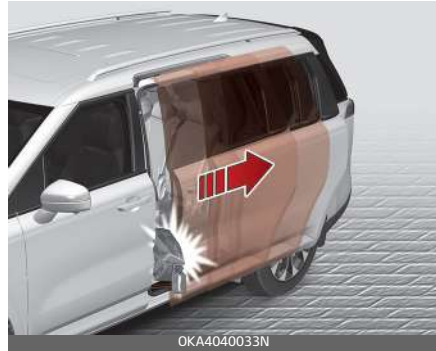

If the power opening or closing is blocked by an object or part of the body, the power sliding door will detect the resistance, then the chime will sound 3 times, and stop movement or move to the opposite direction to allow the object to be cleared. However, if the resistance is weak such as an object that is thin or soft, or the door is near latched position, the automatic stop and reversal may not detect the resistance and closing operation will continue. Also, if the power sliding door is forced by strong impact, the automatic stop and reversal may operate.

If the automatic stop and reversal feature operates continuously more than twice during one opening or closing operation, the power sliding door may stop at that position. At this time, close the doors manually and operate the door automatically again.

⚠ WARNING

The automatic stop and reversal feature is a supplemental feature. Do not solely rely on this function when closing the sliding door. Make sure that no objects or body parts are in the way of the sliding door before closing it.

*** NOTICE**

- In cold and wet climates, power sliding doors and liftgate may not work properly due to freezing conditions.
- When the sliding doors are opened manually, more effort will be required to open and close than non-power sliding doors.

*** NOTICE**

- The power sliding door can be operated when the engine is not running. However the power operation consumes large amounts of vehicle electric power. To prevent the battery from being discharged, do not operate them excessively.
- To prevent the battery from being discharged, do not leave the power sliding door at open position for a long time.
- Do not apply excessive force while operating the power sliding door.

This could cause damage to the power sliding door.

- When jacking up the vehicle to change a tire or repair the vehicle, do not operate the power sliding door. This could cause the power sliding door to operate improperly.
- It is recommended to wait until the power sliding doors are fully closed before starting the vehicle. The power sliding doors may not close fully if the vehicle is started during automatic closing.

⚠ WARNING**Unattended children/pets**

Never leave children or animals unattended in your vehicle. Children or animals might operate the power sliding door that could result in injury to themselves or others or damage to the vehicle.

⚠ CAUTION

Do not close or open the power sliding door manually. This may cause damage to the power sliding door. If it is necessary to close or open the power sliding door manually when the battery is discharged or disconnected, do not apply excessive force.

⚠ WARNING

Make sure there are no people or objects around the doors before opening or closing the power sliding door. Wait until the door is open fully and stopped.

Power sliding door non-operating conditions

The power sliding door is not automatically opened, but closed under the following conditions. If the main or sub control button is pushed for power opening operation, the chime sounds once.

When the ignition switch or ENGINE START/STOP button is in the ON position:

1. Vehicle is moving above 3 km/h (2 mph).
2. The gear is not in P (Park) position.

Power door ON/OFF button (if equipped)



When the LED indicator of the power door ON/OFF button is OFF, the power sliding door and power liftgate can be controlled with the sub control buttons on the center pillar trim or liftgate. Also, the doors can be opened and closed automatically by pulling the inside or outside door handles.

When the LED indicator of the power door ON/OFF button is ON, the power sliding door and power liftgate cannot be controlled with the sub control buttons or door handles. Also, the doors can be opened and closed manually by pulling the inside or outside door handles.

* NOTICE

Do not allow children to play with the power sliding door or power liftgate. Keep the LED indicator of the power door ON/OFF button ON when not in use.

* NOTICE

Close the sliding door and liftgate, and keep the LED indicator of the power door ON/OFF button ON before washing the vehicle in an automatic car wash.

* NOTICE

When the sliding doors and power liftgate are opened manually, more effort will be required to open and close than non-power sliding doors and non-power liftgate.

Simultaneous Power Door (if equipped)

The sliding doors and the liftgate can be opened simultaneously by pressing the door lock/unlock button on the smart key.

Automatic door opening

Sliding door only

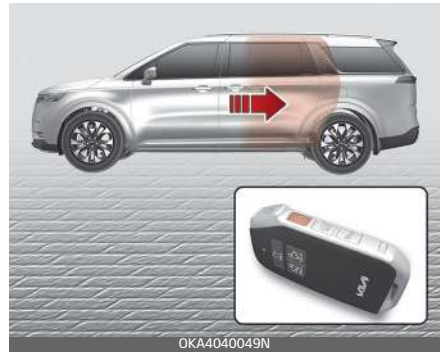

Sliding door and liftgate



Press the unlock button on the smart key for approximately 3 seconds to open the sliding door and the liftgate.

The sliding doors and the liftgate can be operated separately by setting the options in the LCD display or the infotainment system.

For more details, refer to "User settings mode" on page 4-110.

Automatic door closing



Press the lock button on the smart key for approximately 3 seconds to close the doors and the liftgate.

⚠ WARNING

Never leave children or animals unattended in your vehicle. Children or animals might operate the power liftgate that could result in injury to themselves or others, or damage the vehicle.

⚠ WARNING

Make sure there are no people or objects around the liftgate before opening or closing the power liftgate. Wait until the liftgate is open fully and stopped before loading or unloading cargo from the vehicle.

*** NOTICE**

Please make sure if all doors are closed and locked before you leave the car. Simultaneous power door closing does not engage the door lock.

Smart Sliding Door with Auto Open (if equipped)

On a vehicle equipped with a smart key, the sliding door can be opened using the Smart sliding door with auto open system.

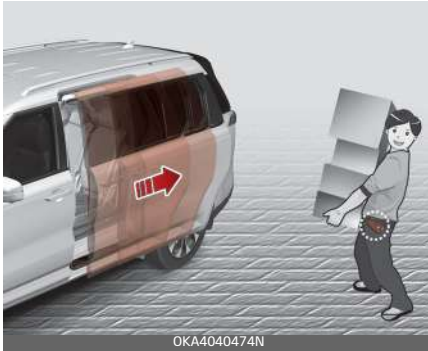

How to use the Smart sliding door with auto open

The sliding door can be opened with no-touch activation satisfying all the conditions below.

- After 15 seconds when all doors are closed and locked
- Positioned in the detecting area for more than 3 seconds.

* NOTICE

The Smart Sliding Door with Auto Open does not operate when:

- The smart key is detected within 15 seconds after the doors are closed and locked, and is continuously detected.
- The smart key is detected within 15 seconds after the doors are

closed and locked, and 1.5 m (60 in) from the front door handles. (for vehicles equipped with Welcome Light)

- A door is not locked or closed.
- The smart key is in the vehicle.

1. Setting

To activate the smart sliding door with auto open, select 'User Settings → Door → Smart Sliding Door' on the LCD display. For more details, refer to "User settings mode" on page 4-110.

2. Detect and Alert

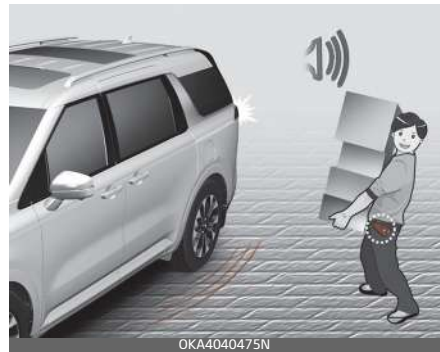

If you are positioned in the detecting area (within 30 ~ 60 cm (12 ~ 24 in) from the sliding door) carrying a smart key, the hazard warning lights will blink and chime will sound to alert you the smart key has been detected and the sliding door will open.

*** NOTICE**

Do not approach the detecting area if you do not want the sliding door to open. If you have unintentionally entered the detecting area and the hazard warning lights and chime starts to operate, leave the detecting area with the smart key. The sliding door will stay closed.

3. Automatic opening

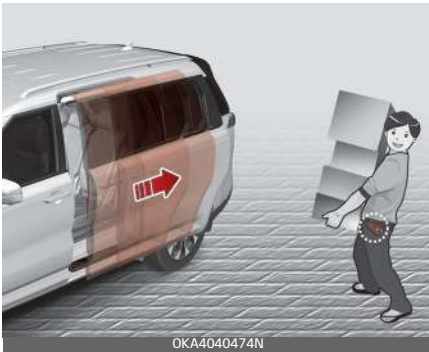

OKA4040474N

The hazard warning lights will blink and chime will sound 2 times and then the sliding door will open.

⚠ WARNING

- Make sure you close the sliding door before driving your vehicle.
- Make sure there are no people or objects around the sliding door before opening or closing the sliding door.
- Make sure objects in the sliding door do not come out when open-

- ing the sliding door on a slope. It may cause serious injury.
- Make sure to deactivate the smart sliding door with auto open when washing your vehicle. Otherwise, the sliding door may open inadvertently.
- The key should be kept out of reach of children. Children may inadvertently open the smart sliding door with auto open while playing around the rear area of the vehicle.

How to deactivate the smart sliding door with auto open function using the smart key



OKA4040044N



OKA4040045N

1. Remote start
2. Power sliding door opening (Driver's side)
3. Power sliding door opening (Passenger's side)
4. Door lock
5. Door unlock
6. Liftgate unlock/open
7. Panic button

If you press one of the buttons from the smart key during the Detect and Alert stage, the smart sliding door with auto open function will be deactivated.

Make sure to be aware of how to deactivate the smart sliding door with auto open function for emergency situations.

* NOTICE

- If you press the door unlock button (5), the smart sliding door with auto open function will be deactivated temporarily. But, if you do not open any door for 30 seconds, the smart sliding door with auto open function will be activated again.
- If you press the sliding door opening button (2, 3) for more than 1 second, the sliding door opens.
- If you press the door lock button (4) or liftgate open button (6) when the smart sliding door with auto open function is not in the Detect and Alert stage, the smart

sliding door with auto open function will not be deactivated.

- In case you have deactivated the smart sliding door with auto open function by pressing the smart key button and opened a door, the smart sliding door with auto open function can be activated again by closing and locking all doors.

Detecting area

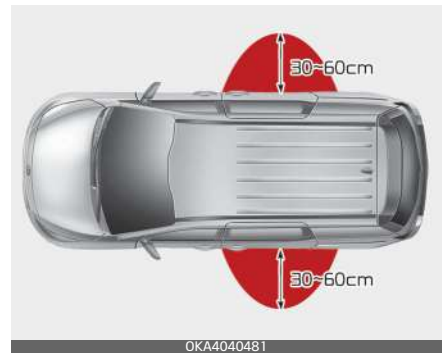

- The sliding door with auto open function operates with a welcome alert if the smart key is detected within 30 ~ 60 cm (12 ~ 24 in) from the sliding door.
- The alert stops at once if the smart key is positioned outside the detecting area during the Detect and Alert stage.

* NOTICE

- The sliding door with auto open function will not work if any of the following occurs:
 - The smart key is close to a radio transmitter such as a radio station or an airport which can interfere with normal operation of the transmitter.
 - The smart key is near a mobile two way radio system or a cellular phone.
 - Another vehicle's smart key is being operated close to your vehicle.
- The detecting range may decrease or increase when:
 - One side of the tire is raised to replace a tire or to inspect the vehicle.
 - The vehicle is slantingly parked on a slope or unpaved road, etc.

Liftgate

⚠ WARNING

Exhaust fumes

If you drive with the liftgate open, you will draw dangerous exhaust fumes into your vehicle which can cause serious injury or death to vehicle occupants.

If you must drive with the liftgate open, keep the air vents and all windows open so that additional outside air comes into the vehicle.

⚠ WARNING

Rear cargo area

Occupants should never ride in the rear cargo area where no restraints are available. To avoid injury in the event of an accident or sudden stops, occupants should always be properly restrained.

Opening the liftgate



- The liftgate is locked or unlocked when all doors are locked or unlocked with the transmitter (or smart key) or central door lock switch.
- Only the liftgate is unlocked if the liftgate unlock button on the transmitter or smart key is pressed for approximately 1 second.
- If unlocked, the liftgate can be opened by pressing the handle and pulling it up.
- Once the liftgate is opened and then closed, the liftgate locks automatically. (All doors must be locked.)

* NOTICE

In cold and wet climates, door lock and door mechanisms may not work properly due to freezing conditions.

⚠ WARNING

The liftgate swings upward. Make sure no objects or people are near the rear of the vehicle when opening the liftgate.

⚠ CAUTION

Make certain that you close the liftgate before driving your vehicle. Possible damage may occur to the liftgate gas lifters and attached

hardware if the liftgate is not closed prior to driving.

Closing the liftgate



- To close the liftgate, lower and push down the liftgate firmly. Make sure that the liftgate is securely latched.

⚠ WARNING

Make sure your hands, feet and other parts of your body are safely out of the way before closing the liftgate.

⚠ WARNING

Exhaust fumes

The liftgate lid should be always kept completely closed while the vehicle is in motion. If it is left open or ajar, poisonous exhaust gases may enter the car and serious illness or death may result.

⚠ CAUTION

Make sure nothing is near the liftgate latch and striker while closing the liftgate. It may damage the liftgate's latch.

Emergency liftgate safety release

Your vehicle is equipped with the emergency liftgate safety release lever located on the bottom of the liftgate. When someone is inadvertently locked in the luggage compartment.



The liftgate can be opened by doing as follows:

1. Input the mechanical key into the hole.
2. Push the mechanical key to the right (1).
3. Push up the liftgate.

⚠ WARNING

- You and your passengers must be aware of the location of the Emergency Liftgate Safety Release lever in this vehicle and how to open the liftgate in case you are accidentally locked in the liftgate.
- NEVER allow anyone to occupy the liftgate of the vehicle at any time. If the liftgate is partially or totally latched and the person is unable to get out, serious injury or death could occur due to lack of ventilation, exhaust fumes and rapid heat build-up, or because of exposure to cold weather conditions. The liftgate is also a highly dangerous location in the event of a crash because it is not a protected occupant space but is a part of the vehicle's crush zone.
- Your vehicle should be kept locked and the Smart Key should be kept out of the reach of children. Parents should teach their children about the dangers of playing in liftgates.
- Use the release lever for emergencies only.

⚠ WARNING

- No one should be allowed to occupy the cargo area of the vehicle at any time. The cargo area is a very dangerous location in the event of a crash.
- Use the release lever for emergencies only. Use with extreme caution, especially while the vehicle is in motion.

⚠ CAUTION

Make sure there are no people or objects around the liftgate before opening or closing the liftgate. Wait until the liftgate is open fully and stopped before loading or unloading cargo from the vehicle.

⚠ WARNING

Do not grasp the part supporting the liftgate (gas lifter), as this may cause serious injury.



Power liftgate (if equipped)

1. Power liftgate open/close button



2. Power liftgate handle switch



3. Power liftgate close button



4. Liftgate Auto Close OFF button



5. Power liftgate open/close button



When the power door ON/OFF button is OFF, the power liftgate can be opened and closed manually by pulling the door handles from inside or outside vehicle.

*** NOTICE**

If ignition switch or ENGINE START/STOP button is ON position, the power liftgate can operate when the gear is in P (Park).

⚠ CAUTION

Do not put heavy stuffs on the power liftgate when you operate the power liftgate. Additional weight on liftgate could cause damages to the system.

⚠ WARNING

Never leave children or animals unattended in your vehicle. Children or animals might operate the power liftgate that could result in injury to themselves or others, or damage the vehicle.

⚠ WARNING

Make sure that there are no people or objects in the path of the power liftgate (or smart liftgate) prior to use. Serious injury, damage to the vehicle or damage to surrounding objects may result if contact with the power liftgate (or smart liftgate) occurs.

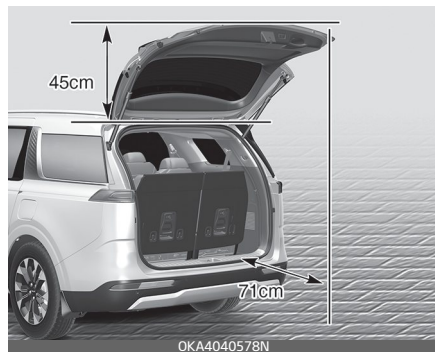

⚠ CAUTION

Do not close or open the power liftgate manually. This may cause damage to the power liftgate. If it is necessary to close or open the power liftgate manually when the battery is discharged or disconnected, do not apply excessive force.

⚠ WARNING

Make sure there are no people or objects around the liftgate before opening or closing the power liftgate. Wait until the liftgate is open fully and stopped before loading or unloading cargo from the vehicle.

Opening the liftgate

The power liftgate will open automatically by doing one of the followings:

- Press the power liftgate operating button on the key or the power liftgate open/close button on the dash panel for approximately one second.



OKA4040038N



OKA4040445N

- For emergency stop while power liftgate operating, press the power liftgate open/close button or the button on the smart key shortly.
- Press the liftgate handle switch carrying the smart key with you. If all the doors are unlocked, the liftgate can be opened without the smart key.



Closing the liftgate

The power liftgate will close automatically by doing one of the following:

- Press the power liftgate close button for approximately one second when the liftgate is opened.



The liftgate will close automatically.

- For emergency stop while power liftgate operating, press the power liftgate open/close button shortly.

- Press the power liftgate close button when the liftgate is opened.



The liftgate will close automatically.

Power liftgate non-opening conditions

The power liftgate will not open automatically, when the vehicle is moving more than 3 km/h (2 mph).

* NOTICE

The chime will sound continuously if you drive over 3 km/h (2 mph) with the liftgate opened. Stop your vehicle immediately at a safe place and check if your liftgate is opened.

⚠ CAUTION

Do not operate the power liftgate more than 5 times continuously. It may damage the power liftgate system. If the spindle is strained due to continuous operation, the

chime will sound 3 times and the power liftgate will not operate. At this time, stop operating the liftgate and leave it for more than 1 minute.

* NOTICE

- The power liftgate can be operated when the engine is not running. However the power liftgate operation consumes large amounts of vehicle electric power. To prevent the battery from being discharged, do not operate it excessively e.g.: more than approximately 10 times repeatedly.
- To prevent the battery from being discharged, do not leave the power liftgate in the open position for a long time.
- Do not modify or repair any part of the power liftgate by yourself, visit an authorized Kia dealer.
- When jacking up the vehicle to change a tire or repair the vehicle, do not operate the power liftgate. This could cause the power liftgate to operate improperly.
- In cold and wet climates, the power liftgate may not work properly due to freezing conditions.

Automatic reversal

During power opening and closing if the power liftgate is blocked by an object or part of the body, the power liftgate will detect the resistance.

- If the resistance is detected while opening the liftgate, it will stop and move in the opposite direction.
- If the resistance is detected while closing the liftgate, it will stop and move in the opposite direction.

However, if the resistance is weak such as from an object that is thin or soft, or the liftgate is near the latched position, the automatic stop and reversal may not detect the resistance. If the automatic reversal feature operates continuously more than twice during opening or closing operation, the power liftgate may stop at that position. At this time, check the surroundings and operate the liftgate automatically again.

* NOTICE

- Never intentionally place any object or part of your body in the path of the power liftgate to make sure the automatic reversal operates.
- Never operate power liftgate attached with any heavy objects (ex. bicycles). It could damage the power liftgate.

How to reset the power liftgate

If the battery has been discharged or disconnected, or if the related fuse has been replaced or disconnected, for the power liftgate to operate normally, reset the power liftgate as follow:

1. Make sure the gear is shifted to P (Park) position.
2. While pressing the liftgate close button, press the liftgate handle switch for more than 3 seconds. (the buzzer will sound)
3. Close the liftgate manually.

If the power liftgate does not work properly after the above procedure, have the system checked by an authorized Kia dealer.

* NOTICE

If the power liftgate does not operate normally, check again if the gear is in the correct position.

Power liftgate speed adjustment

To adjust the power liftgate speed, go to 'User Settings → Door → Power liftgate speed → Normal/ Fast' within the instrument cluster settings of the infotainment system.

- If power liftgate function turns off or liftgate is not fully closed, you can not adjust the power liftgate speed.
- Initial speed of Power liftgate is set as "Fast".

For more details, refer to "User settings mode" on page 4-110.

Power liftgate opening height user setting

The driver may set the height of a fully opened liftgate by following the instruction below.

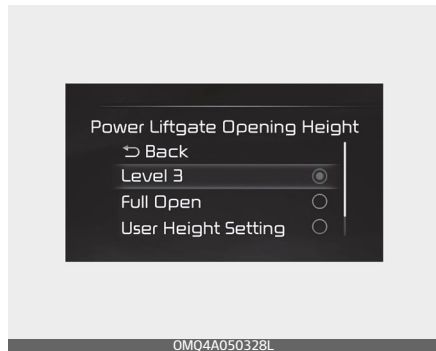

The liftgate opening height can be adjusted within the instrument cluster settings or the infotainment system.

To adjust the power liftgate opening height, go to 'User Settings → Door → Power Liftgate Opening Height → Level 1/Level 2/Level 3/Full Open/ User Height Setting' to adjust the vehicle's liftgate height.

Follow this instruction to adjust the liftgate height:

1. Adjust the liftgate to the preferred height.
2. Press the power liftgate close button for approximately 3 seconds.
3. After the beep sound appears, the setup is finished.

When the vehicle is first delivered, User Height Setting is set to 'Full Open'.

The liftgate will open to the height the driver has set up.

Liftgate Auto Close (if equipped)

On a vehicle equipped with a smart key, the liftgate can be closed using the Liftgate Auto Close system.



How to use the Liftgate Auto Close

The liftgate can be closed with no-touch activation satisfying all the conditions below.

- Liftgate is open.
- Positioned in the detecting area for more than 3 seconds.
- When you leave the vehicle carrying a smart key.

1. Setting

To activate the Liftgate Auto Close system, select Smart Liftgate on the LCD display or infotainment system.

For more details, refer to "User settings mode" on page 4-110. If your vehicle is equipped with an infotainment system, you can learn how to setup on the website via QR code in the infotainment quick reference guide.

2. Detect and Alert



If you are positioned in the detecting area (50 ~ 100 cm [20 ~ 40 in] behind the vehicle) carrying a smart key when the liftgate is opened, the hazard warning lights will blink and chime will sound to alert you the smart key has been detected.

3. Automatic closing



When you leave the vehicle carrying a smart key, the chime will sound 3 times preparatory to the function and then the liftgate will be closed after the chime sounds 2 times.

Releasing Liftgate Auto Close



If you press the Liftgate Auto close release button with the liftgate open, Liftgate Auto Close function will be disabled.

The liftgate will stay opened until the liftgate close button is pressed.

Smart Liftgate with Auto Open (if equipped)

On a vehicle equipped with a smart key, the liftgate can be opened using the Smart Liftgate with Auto Open system.

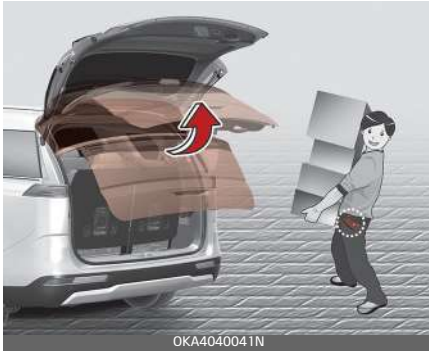

How to use the Smart Liftgate with Auto Open

The liftgate can be opened with no-touch activation satisfying all the conditions below.

- After 15 seconds when all doors are closed and locked
- Positioned in the detecting area for more than 3 seconds.

* NOTICE

The Smart Liftgate with Auto Open does not operate when:

- The smart key is detected within 15 seconds after the doors are closed and locked, and is continuously detected.
- The smart key is detected within 15 seconds after the doors are

closed and locked, and 1.5 m (60 in) from the front door handles. (for vehicles equipped with Welcome Light)

- A door is not locked or closed.
- The smart key is in the vehicle.

1. Setting

To activate the Smart Liftgate with Auto Open, go to 'User Settings → Door → Smart Liftgate with Auto Open' on the LCD display.

2. Detect and Alert



If you are positioned in the detecting area (50 ~ 100 cm [20 ~ 40 in] behind the vehicle) carrying a smart key, the hazard warning lights will blink and chime will sound to alert you the smart key has been detected and the liftgate will open.

*** NOTICE**

Do not approach the detecting area if you do not want the liftgate to open. If you have unintentionally entered the detecting area and the hazard warning lights and chime starts to operate, leave the detecting area with the smart key. The liftgate will stay closed.

- Make sure to deactivate the Smart Liftgate with Auto Open when washing your vehicle. Otherwise, the liftgate may open inadvertently.
- The key should be kept out of reach of children. Children may inadvertently open the Smart Liftgate with Auto Open while playing around the rear area of the vehicle.

3. Automatic opening

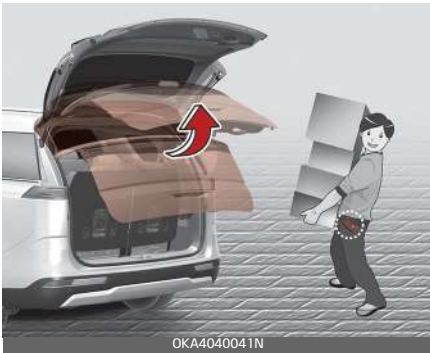

The hazard warning lights will blink and chime will sound 6 times and then the liftgate will open.

⚠ WARNING

- Make sure you close the liftgate before driving your vehicle.
- Make sure there are no people or objects around the liftgate before opening or closing the liftgate.
- Make sure objects in the liftgate do not come out when opening the liftgate on a slope. It may cause serious injury.

⚠ CAUTION

Liftgate lift

Make certain that you close the liftgate before driving your vehicle. Possible damage may occur to the liftgate gas lifters and attached hardware if the liftgate is not closed prior to driving.

How to deactivate the Smart Liftgate with Auto Open function using the smart key





OKA4040045N

1. Remote start
2. Power sliding door opening (Driver's side)
3. Power sliding door opening (Passenger's side)
4. Door lock
5. Door unlock
6. Liftgate unlock/open
7. Panic button

If you press any button of the smart key during the Detect and Alert stage, the Smart Liftgate with Auto Open function will be deactivated.

Make sure to be aware of how to deactivate the Smart Liftgate with Auto Open function for emergency situations.

*** NOTICE**

- If you press the door unlock button (5), the Smart Liftgate with Auto Open function will be deactivated temporarily. But, if you do not open any door for 30 seconds, the Smart Liftgate with Auto

Open function will be activated again.

- If you press the liftgate open button (6) for more than 1 second, the liftgate opens.
- If you press the door lock button (4) or liftgate open button (6) when the Smart Liftgate with Auto Open function is not in the Detect and Alert stage, the Smart Liftgate with Auto Open function will not be deactivated.
- In case you have deactivated the Smart Liftgate with Auto Open function by pressing the smart key button and opened a door, the Smart Liftgate with Auto Open function can be activated again by closing and locking all doors.

4

Detecting area



OKA4040579N

- The Smart Liftgate with Auto Open operates with a welcome alert if the smart key is detected within 50 ~ 100 cm (20 ~ 40 in) from the liftgate.

- The alert stops at once if the smart key is positioned outside the detecting area during the Detect and Alert stage.

*** NOTICE**

- The Smart Liftgate with Auto Open function will not work if any of the following occurs:
 - The smart key is close to a radio transmitter such as a radio station or an airport which can interfere with normal operation of the transmitter.
 - The smart key is near a mobile two way radio system or a cellular phone.
 - Another vehicle's smart key is being operated close to your vehicle.
 - The detecting range may decrease or increase when :
 - One side of the tire is raised to replace a tire or to inspect the vehicle.
 - The vehicle is slantingly parked on a slope or unpaved road, etc.
-

Windows

The doors of this vehicle are equipped with power windows that can be operated by a switch.

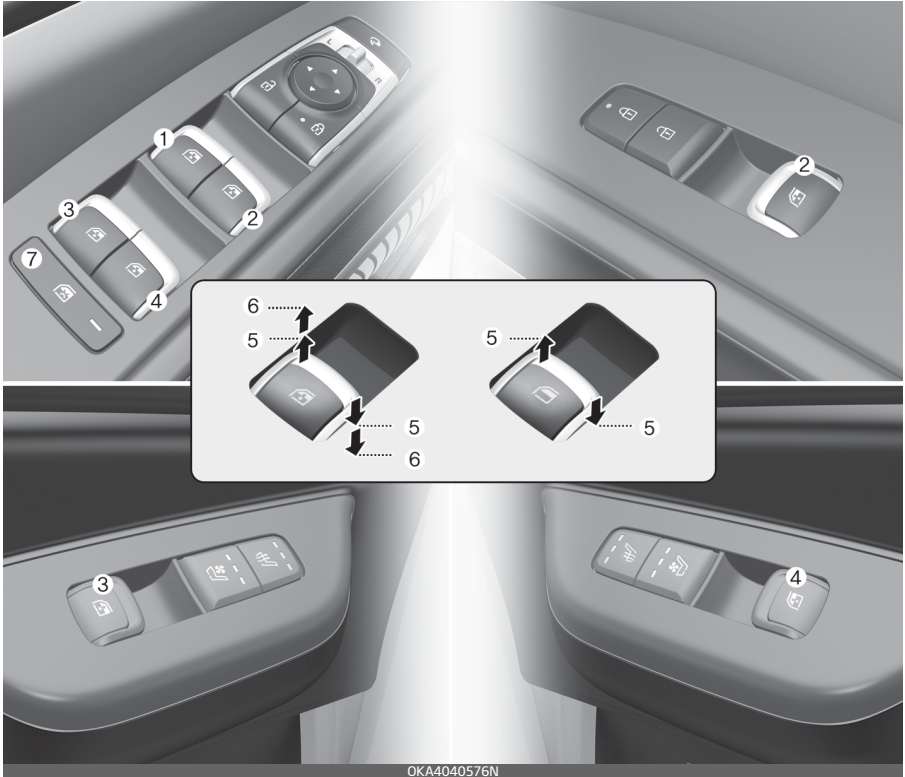

1. Driver's door power window switch
2. Front passenger's door power window switch
3. Rear door (left) power window switch
4. Rear door (right) power window switch
5. Window opening and closing
6. Automatic power window up*/down*
7. Power window/rear sunroof lock switch

*: if equipped

*** NOTICE**

In cold and wet climates, power windows may not work properly due to freezing conditions.

The ignition switch or ENGINE START/STOP button must be in the ON position for power windows to operate.

Each door has a power window switch that controls the door's window. The driver has a power window lock button which can block the operation of rear passenger windows. The power windows can be operated for approximately 3 minutes after ignition switch or ENGINE START/STOP button turned to the ACC or LOCK position. However, if the front doors are opened, the power windows cannot be operated even within the 3 minutes period.

The driver's door has a master power window switch that controls all the windows in the vehicle.

If the window cannot be closed because it is blocked by objects, remove the objects and close the window.

*** NOTICE**

While driving with the rear windows down or with the sunroof (if equipped) in an open (or partially open position), your vehicle may demonstrate a wind buffeting or pulsation noise. This noise is a normal occurrence and can be reduced or eliminated by taking the following actions. If the noise occurs with one or both of the rear windows down, partially lower both front windows approximately 2.5 cm (1 inch). If you experience the noise with the sunroof open, slightly reduce the size of the sunroof opening.

⚠ CAUTION

Do not install any accessories in the vehicle that extend into the open window area. Such objects will impact the proper function of the Automatic reversal "jam protection" feature.

*** NOTICE**

If you press the one-touch window button for micro adjustment, the glass will go down to a specific location to improve your convenience.

Window opening and closing

You can open and close windows using the power window switch.

Type A (if equipped)



OMQ4040444

To open or close a window, press down or pull up the front portion of the corresponding switch to the first detent position (5).

Type B - Auto up/down window (if equipped)



OMQ4040445

Pressing or pulling up the power window switch momentarily to the second detent position (6) completely lowers or raises the window

even when the switch is released. To stop the window at the desired position while the window is in operation, pull up or press down and release the switch.

To reset the power windows

If the power window does not operate normally, the automatic power window system must be reset as follows:

1. Turn the ignition switch or ENGINE START/STOP button to the ON position.
2. Close the window and continue pulling up the power window switch for at least 1 second after the window is completely closed.

Automatic reversal (if equipped)



ODEEV068020NR

If the upward movement of the window is blocked by an object or part of the body, the window will detect the resistance and will stop upward movement. The window will then lower approximately 30 cm

(11.8 inches) to allow the object to be cleared.

If the window detects the resistance while the power window switch is pulled up continuously, the window will stop upward movement then lower approximately 2.5 cm (1 inch).

And if the power window switch is pulled up continuously again within 5 seconds after the window is lowered by the automatic window reversal feature, the automatic window reversal will not operate.

* NOTICE

The automatic reverse feature for the window is only active when the "auto up" feature is used by fully pulling up the switch. The automatic reverse feature will not operate if the window is raised using the half-way position on the power window switch.

⚠ WARNING

Always check for obstructions before raising any window to avoid injuries or vehicle damage. If an object less than 4 mm (0.16 of an inch) in diameter is caught between the window glass and the upper window channel, the automatic reverse window may not detect the resistance and will not stop and reverse direction.

⚠ WARNING

The automatic reverse feature doesn't activate while resetting the power window system. Make sure body parts or other objects are safely out of the way before closing the windows to avoid injuries.

⚠ CAUTION

Do not install any accessories in the vehicle that extend into the open window area. Such objects could prevent the automatic reverse feature from functioning.

Power window lock button

The driver can disable the power window switches on a rear passenger door and the rear sunroof switch on a rear passenger room lamp by depressing the power window and rear sunroof lock switch on the driver's door to LOCK (pressed).



OKA4040020L

When the power window and rear sunroof lock switch is pressed:

- The driver's master control can operate all passengers' power windows.
 - The front passenger's control can operate the front passenger's power window.
 - The rear passengers' control cannot operate the rear passenger's power window.
 - The rear sunroof control cannot operate the rear sunroof. But the front master sunroof control can operate both front and rear sunroofs (if equipped).
- * If the power window lock switch is operated (indicator turns on), rear passenger cannot open the rear window.

CAUTION

- To prevent possible damage to the power window system, do not open or close two windows or more at the same time. This will also ensure the longevity of the fuse.
- Never try to operate the main switch on the driver's door and the individual door window switch in opposite directions at the same time. If this is done, the window will stop and cannot be opened or closed.

WARNING

Windows

- NEVER leave the keys in your vehicle with unsupervised children, when the engine is running.
- NEVER leave any child unattended in the vehicle. Even very young children may inadvertently cause the vehicle to move, entangle themselves in the windows, or otherwise injure themselves or others.
- Always double check to make sure all arms, hands, head and other obstructions are safely out of the way before closing a window.
- Do not allow children play with the power windows. Keep the driver's door power window lock button in the LOCK position (pressed). SERIOUS INJURY can result from unintentional window operation by the child.
- Do not extend heads or any limbs outside the window while the vehicle is in motion.

Hood

The hood serves as a cover for the engine compartment.

Open the hood if maintenance work needs to be performed in the engine compartment or if you need to look at the compartment.

Opening the hood

1. Pull the release lever to unlatch the hood. The hood should pop open slightly.

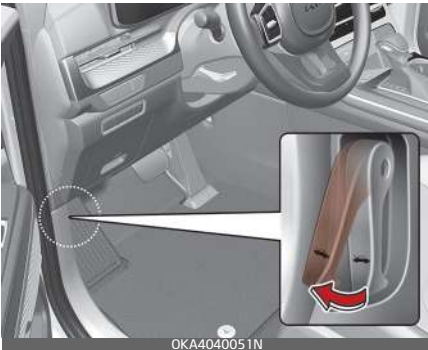

2. Go to the front of the vehicle, raise the hood slightly, push the secondary latch (1) to the left and lift the hood (2).



3. Pull out the support rod.



4. Hold the hood opened with the support rod.

⚠ WARNING

Support rod

- After driving, the engine compartment and support rod will be hot. Grasp the support rod in the area wrapped in rubber to prevent burns.



- The support rod must be inserted completely into the hole provided whenever you inspect the engine compartment. This will prevent

the hood from falling and possibly injuring you.

Hood open warning

The hood warning message will appear on the LCD display when hood is open.



OKA4040106

The warning chime will operate when the vehicle is being driven at or above 3 km/h (2 mph) with the hood open.

Closing the hood



OKA4041589N

1. Before closing the hood, check the following:

- All filler caps in the engine compartment must be correctly installed.
 - Gloves, rags or any other combustible material must be removed from the engine compartment.
2. Lower the hood until it is about 30 cm (12 in) above the closed position and let it drop. Make sure that it locks into place.
 3. Check that the hood has engaged properly.
 - If the hood can be raise slightly, it is not properly engaged.
 - Open it again and close it with a little more force.

⚠ CAUTION

Hood obstruction

Before closing the hood, ensure that all obstructions are removed from the hood opening. Closing the hood with an obstruction present in the hood opening may result in severe personal injury or property damage.

⚠ WARNING

Fire risk

Do not leave gloves, rags or any other combustible material in the motor compartment. Doing so may cause a heat-induced fire.

⚠ WARNING**Unsecured hood**

Always double check to be sure that the hood is firmly latched before driving away. If it is not latched, the hood could fly open while the vehicle is being driven, causing a total loss of visibility, which may result in an accident.

Fuel filler door

The vehicle's fuel filler door must be opened and closed by hand from outside the vehicle.

Opening the fuel filler door

To unlock fuel filler door:

- Press the unlock button on your smart key
 - Press the Central Door unlock button on armrest trim of driver's door
 - Pull the driver's inside door handle outward
1. Turn the engine off.
 2. Ensure the driver's door is unlocked for unlocking fuel filler door.
 3. Press the rear center edge of fuel filler door.



4. Pull the fuel filler door (1) out to fully open.



5. To remove the fuel tank cap (2), turn it counterclockwise. You may hear a hissing noise as the pressure inside the tank equalizes.
6. Place the cap on the fuel filler door.

* NOTICE

Before refueling, be sure to check what type of fuel is used for your vehicle.

If you put diesel or ethanol fuel into a gasoline-powered vehicle, it may affect the fuel system and cause serious damage to the vehicle.

* NOTICE

If the fuel filler door does not open because ice has formed around it, tap lightly or push on the door to break the ice and release the door. Do not pry on the door. If necessary, spray around the door with an approved de-icer fluid (do not use

radiator anti-freeze) or move the vehicle to a warm place and allow the ice to melt.

Closing the fuel filler door

To lock fuel filler door:

- Press the lock button on your smart key
 - Press the Central Door lock button on armrest trim of driver's door
- * All doors will automatically lock after the vehicle speed exceeds approximately 15 km/h (9 mph). Fuel door is also locked when vehicle speed exceeds approximately 15 km/h (9 mph).
1. To install the fuel tank cap, turn it clockwise until it "Clicks".
 2. Close the fuel filler door by pressing rear center edge of the fuel filler door.

* NOTICE

Press the vehicle's fuel door to LOCK position when the fuel filler door is completely closed in order to lock the fuel filler door.

If the fuel filler door is not completely closed, the fuel filler door will not be locked.

⚠ WARNING**Refueling**

Always remove the fuel cap carefully and slowly. If the cap is venting fuel or if you hear a hissing sound, wait until the condition stops before completely removing the cap.

If pressurized fuel sprays out, it can cover your clothes or skin and subject you to the risk of fire and burns.

*** NOTICE**

When refueling on unlevel ground, the fuel gauge may not point to the F position. It is not a malfunction. If you move your vehicle to a level ground, the fuel gauge will move to the full position.

*** NOTICE**

Tighten the cap until it clicks one time, otherwise, the engine warning indicator light will illuminate.

⚠ CAUTION

Keep the door into LOCK position when the vehicle is being washed (i.e. high pressure washer, automatic car washer, etc.)

⚠ WARNING

Always tighten your fuel cap before you leave the fuel station. Failure to securely install your fuel cap can lead to fuel spillage in an accident and increase fire risk.

⚠ WARNING**Fire/explosion risk**

Read and follow all warnings posted at the gas station facility. Failure to follow all warnings will result in severe personal injury, severe burns or death due to fire or explosion.

⚠ WARNING**Static electricity**

- Before touching the fuel nozzle, you should eliminate potentially dangerous static electricity discharge by touching another metal part of the vehicle, a safe distance away from the fuel filler neck, nozzle, or other gas source.
- Do not get back into a vehicle once you have begun refueling since you can generate static electricity by touching, rubbing or sliding against any item or fabric (polyester, satin, nylon, etc.) capable of producing static electricity. Static electricity discharge can ignite fuel vapors resulting in rapid burning. If you must reenter

the vehicle, you should once again eliminate potentially dangerous static electricity discharge by touching a metal part of the vehicle, away from the fuel filler neck, nozzle or other gasoline source.

⚠ WARNING

Portable fuel container

When using an approved portable fuel container, be sure to place the container on the ground prior to refueling. Static electricity discharge from the container can ignite fuel vapors causing a fire. Once refueling has begun, contact with the vehicle should be maintained until the filling is complete. Use only approved portable plastic fuel containers designed to carry and store gasoline.

⚠ WARNING

Cell phone fires

Do not use cellular phones while refueling. Electric current and/or electronic interference from cellular phones can potentially ignite fuel vapors causing a fire.

⚠ WARNING

Refueling & Vehicle fires

When refueling, always shut the engine off. Sparks produced by electrical components related to the engine can ignite fuel vapors causing a fire. Once refueling is complete, check to make sure the filler cap and filler door are securely closed, before starting the engine.

⚠ WARNING

Smoking

DO NOT use matches or a lighter and DO NOT SMOKE or leave a lit cigarette in your vehicle while at a gas station especially during refueling. Automotive fuel is highly flammable and can, when ignited, result in fire.

Make sure to refuel your vehicle according to "Fuel requirements" on page 1-2.

If the fuel filler cap requires replacement, use only a genuine Kia cap or the equivalent specified for your vehicle. An incorrect fuel filler cap can result in a serious malfunction of the fuel system or emission control system.

⚠ CAUTION**Exterior paint**

Do not spill fuel on the exterior surfaces of the vehicle. Any type of fuel spilled on painted surfaces may damage the paint.

⚠ WARNING

- Do not allow anyone that has not discharged static electricity from their body to come close to an open fuel tank.
 - Do not inhale vaporized fuel.
-

⚠ WARNING**Risk of injury from fuel**

Fuels are poisonous and harmful to your health.

- Fuel contains substances that are harmful if inhaled.
- Do not swallow fuel or let it come into contact with skin, eyes or clothing.
- Do not inhale fuel vapors.
- Keep children away from fuel.

If you or other people come into contact with fuel, observe the following:

- Immediately rinse fuel off your skin with soap and water.
- If fuel comes into contact with your eyes, immediately rinse them thoroughly with clean

water. Seek medical attention immediately.

- If you swallow fuel, seek medical attention immediately. Do not induce vomiting.
 - Change immediately out of clothing that has come into contact with fuel.
-

*** NOTICE****Damage caused by the wrong fuel**

Fuel that does not conform to the required quality can lead to increased wear as well as damage to the engine and exhaust system. Only use the fuel recommended.

*** NOTICE****Damage caused by the wrong fuel**

Vehicles with a gasoline engine: Even small amounts of the wrong fuel could result in damage to the fuel system, the engine and the emission control system.

*** NOTICE**

Do not use diesel or ethanol to refuel vehicles with a gasoline engine.

* NOTICE

Do not switch on the ignition if you accidentally refuel with the wrong fuel. Otherwise, fuel can enter the fuel system.

Even small amounts of the wrong fuel could result in damage to the fuel system and the engine. Have the system serviced by an authorized Kia dealer.

* NOTICE

Do not overfill the fuel tank

Do not overfill the fuel tank; otherwise fuel may spill, causing harm to the environment and damaging the vehicle.

Sunroof (if equipped)

If your vehicle is equipped with a sunroof, you can slide or tilt your sunroof with the sunroof control lever located on the overhead console.

Front



Rear



The sunroof can only be opened, closed, or tilted when the ignition switch or ENGINE START/STOP button is in the ON position.

The sunroof is operable for 3 minutes, after the ignition switch or

ENGINE START/STOP button is placed in the OFF or ACC position.

However, if the front doors are opened, the sunroof cannot be operated even within 3 minutes.

* NOTICE

- In cold and wet climates, the sunroof may not work properly due to freezing conditions.
- After the vehicle is washed or in a rainstorm, be sure to wipe off any water that is on the sunroof before operating it.

⚠ CAUTION

Sunroof motor damage

- To prevent damage to the sunroof, periodically remove any dirt that may accumulate on the guide rail.
- If you try to open the sunroof when the temperature is below freezing or when the sunroof is covered with snow or ice, the glass or the motor could be damaged.

* NOTICE

In order to prevent accidental operation of the sunroof, especially by a child, do not let a child operate the sunroof.

⚠ CAUTION

Sunroof control lever

Do not continue to press the sunroof control lever after the sunroof is fully opened, closed, or tilted. Damage to the motor or system components could occur.

⚠ WARNING

Sunroof operation

When closing the sunroof, make sure there are no body parts in the movement range of the sliding roof. Parts of the body could become trapped or crushed.

⚠ WARNING

Never adjust the sunroof or sunshade while driving. This could result in loss of control and an accident that may cause death, serious injury, or property damage.

⚠ CAUTION

Make sure the sunroof is fully closed when leaving your vehicle. If the sunroof is opened, rain or snow may leak through the sunroof and wet the interior as well as increase the risk of theft.

⚠ WARNING

Do not extend any luggage outside the sunroof while driving. Such action can increase the risk of an accident and cause injuries during an accident sequence.

⚠ WARNING

Roof cargo

Do not operate the sunroof while using the roof rack to transport cargo. This may cause the cargo to come loose and distract the driver.

⚠ WARNING

- Make sure heads, other body parts or other objects are safely out of the way before closing the sunroof to avoid injuries or vehicle damage.
- To avoid serious injury or death, do not extend your head, arms or body outside the sunroof while driving.
- Improper operation of the sunroof, especially by a child, may lead to an accident. Never leave a child unattended in the vehicle.
- Do not sit on the top of the vehicle. It may cause injuries or vehicle damage.
- Never adjust the sunroof or sunshade while driving. This may cause loss of vehicle control resulting in an accident.

*** NOTICE**

Periodically remove any dirt that may accumulate on the sunroof guide rail or between the sunroof and roof panel, which can make a noise.

Sliding the sunroof

Front



Rear



- To open the sunroof, pull the sunroof control lever backward.
- To close the sunroof, push the sunroof control lever forward.

To open the sunroof automatically

- Pull the sunroof control lever backward to the second detent position and then release it. The sunroof will open as below:
 - Front sunroof: sunroof will slide all the way open.
 - Rear sunroof: sunroof will not open fully. To open the sunroof fully, pull the sunroof control lever again.
- To stop the sunroof sliding at any point, pull or push the sunroof control lever momentarily.

⚠ CAUTION

Open the rear sunroof in the 1st position while driving. It minimizes the wind noise compared to 2nd position.

Automatic reversal



If an object or part of the body is detected while the sunroof glass is closing automatically, it will reverse the direction, and then stop.

The auto reverse function does not work if a tiny obstacle is between the sliding glass and the sunroof sash. You should always check that all passengers and objects are away from the sunroof before closing it.

⚠ WARNING

- Never try pinching any part of your body intentionally to activate the Automatic reversal function.
- The Automatic reversal function may not work if something gets caught just before the sunroof fully closes.

⚠ WARNING**Roof cargo**

Do not operate the sunroof while using the roof rack to transport cargo. This may cause the cargo to come loose and distract the driver.

*** NOTICE**

Small objects that can get caught between the sunroof glass and the front glass channel may not be detected by the automatic reverse system. In this case, the sunroof glass will not detect the object and will not reverse direction.

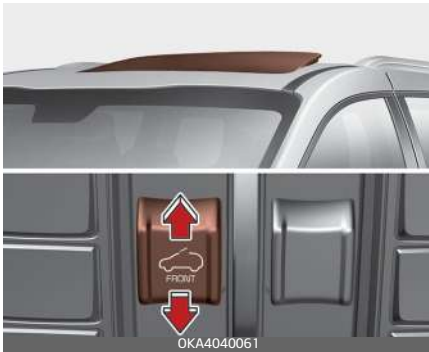
Tilting the sunroof (front)

To open the sunroof, push the sunroof control lever upward until the sunroof moves to the desired position.

To close the sunroof, push the sunroof lever forward until the sunroof moves to the desired position.

⚠ CAUTION

- If you try to open the sunroof when the temperature is below freezing or when the sunroof is covered with snow or ice, the glass or the motor could be damaged.
- while using sunroof for a long time, a dust between sunroof and roof panel can make a noise. Open the sunroof and remove regularly the dust using clean cloth.
- The sunroof is made to slide together with sunshade. Do not leave the sunshade closed while the sunroof is open.

⚠ WARNING**Sunroof**

Do not extend the face, neck, arms or body outside through the sunroof opening while driving or operating the sunroof.

⚠ CAUTION**Sunroof operation**

When closing the sunroof, make sure there are no body parts in the movement range of the sliding roof. Parts of the body could become trapped or crushed.

Sunshade

The sunshade will be opened with the glass panel automatically when the glass panel is slid.



You will have to close it manually if you want it closed.

* NOTICE

Wrinkles formed on the sunshade as material characteristic are normal.

⚠ CAUTION

Close the sunroof when driving in dusty environments. Dust may cause a malfunction of the vehicle system.

Resetting the sunroof

Reset the sunroof when:

- Battery is discharged or disconnected or the related fuse has been replaced or disconnected.

- The one-touch sliding function of the sunroof does not normally operate.

Reset the sunroof as described below.

1. The ignition switch or ENGINE START/STOP button must be in the ON position.
2. Close the sunroof completely.
3. Release the control lever.
4. Push the control lever forward until the sunroof tilts and slightly moves up. Then, release lever.
5. Push the control lever forward until the sunroof is operated as follows:
 - 1) SLIDE OPEN → SLIDE CLOSE
 - 2) Then, release the control lever.

Rear sunroof lock

When the power window/rear sunroof lock switch is pressed, the rear sunroof control cannot operate the rear sunroof. But the front master sunroof control can operate both front and rear sunroofs.



Sunroof open warning



OKA4040107

- If the driver turns off the engine when the sunroof is not fully closed, the warning chime will sound for a few seconds and the open sunroof warning appear on the LCD display.
- If the driver turns off the engine and opens the door when the sunroof is not fully closed, the sunroof open warning will appear on the LCD display until the door is closed or the sunroof is fully closed.

Close the sunroof securely when leaving your vehicle.

Steering wheel

The steering wheel of this vehicle is equipped with the Electric Power Steering (EPS) system.

Electric power steering (EPS)

Power steering uses the motor to assist you in steering the vehicle.

If the engine is off or if the power steering system becomes inoperative, the vehicle may still be steered, but it will require increased steering effort.

The EPS is controlled by the power steering control unit which senses the steering wheel torque and vehicle speed to command the motor.

The steering effort becomes heavier as the vehicle's speed increases and becomes lighter as the vehicle's speed decreases for better control of the steering wheel.

Should you notice any change in the effort required to steer during normal vehicle operation, have the system checked by an authorized Kia dealer.

* NOTICE

The following symptoms may occur during normal vehicle operation:

- When the ENGINE START/STOP button is the ON position, the steering wheel enters normal

operation mode after diagnosing the Electric Power Steering system (for about 3 seconds).

- A click noise may be heard from the EPS relay after turning the ENGINE START/STOP button is turned to the ON or OFF position.
- If the steering wheel is operated when the vehicle is not in motion or driven at a low speed, you may hear some noise.
- If the Electric Power Steering system does not operate normally, the warning light will illuminate or blink on the instrument cluster. If the power assistance of steering fails, you will need to use more force to steer.
- Operating the steering wheel at lower temperatures may require more force and accompany noise. However, when the temperature increases, it returns to normal.
- Take your vehicle to an authorized Kia dealer and have the vehicle checked as soon as possible.
- When the charging system warning light comes on due to the low voltage (when the alternator or battery does not operate normally or malfunctions), the steering wheel may require increased steering effort.

CAUTION

When you continuously operate the steering wheel, the overcurrent protection device is activated and it requires more force to operate the steering wheel. However, this doesn't indicate a malfunction, and it works for your safety and will return to normal after some time.

CAUTION

If the Electric Power Steering (EPS) system does not work or an error occurs, the warning light on the instrument panel may be turned on or blink and it may require more force to operate the steering wheel. In this case, please hold the steering wheel more tightly than usual and operate with greater force. And then immediately pull your vehicle over to a safe place and have your vehicle inspected by an authorized Kia dealer.

Tilt & telescopic steering wheel

A tilt and telescopic steering wheel allows you to adjust the steering wheel before you drive. You can also raise it to give your legs more room when you exit and enter the vehicle.

The steering wheel should be positioned so that it is comfortable for you to drive, while permitting you to

see the instrument panel warning lights and gauges.

⚠ WARNING

Steering wheel adjustment

Never adjust the angle and height of the steering wheel while driving. You may lose steering control.

Adjusting steering wheel angle and height



1. To change the steering wheel angle, pull down the lock release lever (1).
2. Adjust the steering wheel to the desired angle (2) and height (3). Move the steering wheel, so it points toward your chest, not toward your face. Make sure you can see the instrument panel warning lights and gauges. After adjusting, pull up the lock.
3. Pull up the lock-release lever to lock the steering wheel in place. Push the steering wheel both up and down to be certain it is locked in position.

4. Be sure to adjust the steering wheel to the desired position before driving.

*** NOTICE**

After adjustment, sometimes the lock-release lever may not lock the steering wheel.

It is not a malfunction. This occurs when two gears engage. In this case, adjust the steering wheel again and then lock the steering wheel.

Heated steering wheel (if equipped)

When the ignition switch or ENGINE START/STOP button is in the ON position, pressing the heated steering wheel button warms the steering wheel. The indicator on the button will illuminate.

Type A



Type B



To turn the heated steering wheel off, press the button once again. The indicator on the button will turn off.

- The heated steering wheel defaults to the OFF position whenever the ignition switch or ENGINE START/STOP button is in the ON position. However, if the Auto Comfort Control function is ON, the heated steering wheel will turn on and off depending on the outside temperature.

* NOTICE

The heated steering wheel will turn off automatically approximately 30 minutes after the heated steering wheel is turned on.

⚠ CAUTION

- Do not install any type of grip cover for the steering wheel, it may impair the function of the heated steering wheel system.
- When cleaning the heated steering wheel, do not use an organic solvent such as paint thinner, benzene, alcohol and gasoline. Doing so may damage the surface of the steering wheel.
- If the surface of the steering wheel is damaged by a sharp object, damage to the heated steering wheel components could occur.

⚠ WARNING

If the steering wheel becomes too warm, turn the system off. The heated steering wheel may cause burns even at low temperatures, especially if used for long periods of time.

Horn

To sound the horn, press the area indicated by the horn symbol on your steering wheel (see illustration).



The horn will operate only when this area is pressed. Check the horn regularly to be sure it operates properly.

⚠ CAUTION

Do not strike the horn severely to operate it, or hit it with your fist. Do not press on the horn with a sharp-pointed object.

Mirrors

This vehicle is equipped with inside and outside rear view mirrors to provide views of objects behind the vehicle.

Inside rear view mirror

Adjust the rear view mirror so that the center view through the rear window is seen. Make this adjustment before you start driving.

Do not place objects in the rear seat or cargo area which would interfere with your vision out the rear window.

⚠ WARNING

Mirror adjustment

Do not adjust the rear view mirror while the vehicle is moving. This could result in loss of control.

* NOTICE

Do not modify the inside mirror in any manner, including installing a wide mirror. Doing so could result in injury during an accident or deployment of the air bag.

CAUTION

Cleaning mirror

When cleaning the mirror, use a paper towel or similar material dampened with glass cleaner. Do not spray glass cleaner directly on the mirror. It may cause the liquid cleaner to enter the mirror housing.

Day/night rear view mirror (if equipped)

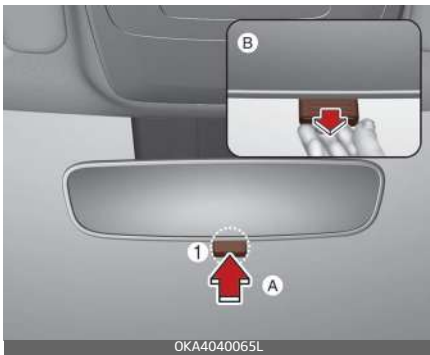

(A): Day, (B): Night

Make this adjustment before you start driving and while the day/night lever (1) is in the day position.

Pull the day/night lever (1) toward you to reduce the glare from the headlamps of the vehicles behind you during night driving.

Remember that you lose some rear view clarity in the night position.

Electric Chromic mirror (ECM) with HomeLink® system (if equipped)

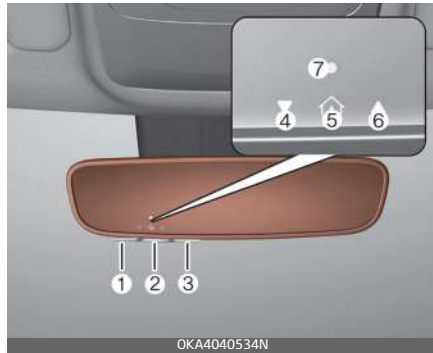

1. HomeLink Channel 1
2. HomeLink Channel 2
3. HomeLink Channel 3
4. Garage Door Opener Status Indicator: Closing or Closed
5. HomeLink Operation Indicator
6. Garage Door Opener Status Indicator: Opening or Opened
7. HomeLink User Interface Indicator

Your vehicle may be equipped with a Gentex Automatic-Dimming Mirror with an Integrated HomeLink® Wireless Control System.

During nighttime driving, this feature will automatically detect and reduce rear view mirror glare. The HomeLink® Universal Transceiver allows you to activate your garage door(s), electric gate, home lighting, etc.

Automatic-Dimming Night Vision Safety™ (NVS®) Mirror (if equipped)

The NVS® Mirror automatically reduces glare by monitoring light levels in the front and the rear of the vehicle. Any objects that obstructs the light sensor will degrade the automatic dimming control feature.

For more information regarding NVS® mirrors and other applications, please refer to the Gentex website: www.gentex.com

Your mirror will automatically dim upon detecting glare from the vehicles traveling behind you.

The mirror defaults to the ON position each time the vehicle is started.

Integrated HomeLink® Wireless Control System

The HomeLink® Wireless Control System provides a convenient way to replace up to three handheld radio-frequency (RF) transmitters used to activate compatible devices such as gate operators, garage door openers, entry door locks, security systems, and home lighting.

*** NOTICE**

Considering the Home Security when the vehicle is parked outside the garage, the HomeLink® will ONLY work while the vehicle is in the ACC or ON position.

⚠ CAUTION

Before programming HomeLink to a garage door opener or gate operator, make sure that people and objects are out of the way of the device to prevent potential harm or damage. When programming a garage door opener, it is advised to park outside of the garage.

Do not use HomeLink with any garage door opener that lacks safety stop and reverse features as required by U.S. federal safety standards (this includes any garage door opener model manufactured before April 1, 1982). A garage door that cannot detect an object signaling the door to stop and reverse – does not meet current U.S. federal safety standards. For more information, contact HomeLink at **www.homelink.com**, or call HomeLink customer support at **1-800-355-3515**.

It is also recommended that a new battery be replaced in the handheld transmitter of the device being trained to HomeLink for quicker

training and accurate transmission of the radio frequency.

1. Programming HomeLink®

The following steps show how to program HomeLink. If you have any questions or are having difficulty programming your HomeLink buttons, refer to the HomeLink website or call the HomeLink customer support toll-free number. Do this, before going back to the dealer who sold you the car.

- Visit the HomeLink website at: www.homelink.com. Then at the top of the page, choose your vehicle make. Then watch the YouTube video, and/or access additional website information.
- If you choose to access the website via your cell phone, scan the QR code.



- Or, call HomeLink customer support at **1-800-355-3515** (Please have the vehicle make/model AND the opener device make/model readily available.)

1) Programming Preparation

1. When programming a garage door opener, it is advised to park the vehicle outside of the garage.
2. It is recommended that a new battery be placed in the hand-held transmitter of the device being programmed to HomeLink for quicker training and accurate transmission of the radio-frequency signal.
3. Place the ignition switch or ENGINE START/STOP button to the ACC (Accessory) position for programming of HomeLink.

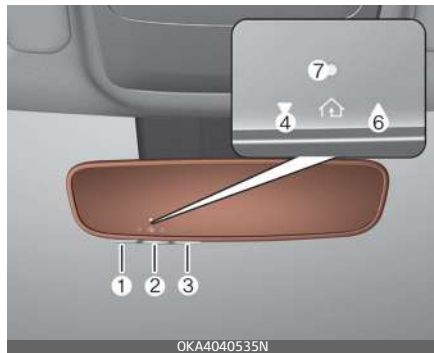

2) Programming a New HomeLink® Button

1. Press and release the HomeLink button (1), (2) or (3), you would like to program. The HomeLink indicator light (7) will flash orange slowly (if not, perform the steps of "Erasing HomeLink Buttons" section, and start over).



2. Position the garage door opener remote 2 - 8 cm (1 - 3 inches) away from the HomeLink buttons.



3. While the HomeLink indicator light (7) is flashing orange, press and hold the hand-held remote button. Continue pressing the hand-held remote button until the HomeLink indicator light (7) light changes from orange to green. You may now release the hand-held remote button.

4. Wait until your garage door comes to a complete stop,

regardless of position, before proceeding to the next steps.

5. Press and release the HomeLink button you are programming and observe the indicator light.

- If the indicator light remains solid green, your device should operate when the HomeLink button is pressed. At this point, if your device operates, programming is complete.
- If the indicator light rapidly flashes green, firmly press, hold for two seconds and release the HomeLink button up to three times in a row slowly to complete the programming process. Do not press the HomeLink button rapidly. At this point if your device operates, programming is complete. If the device does not operate, continue with step 6.

6. At the garage door opener motor, (security gate motor, etc.) locate the "Learn", "Smart", "Set" or "Program" button. This can usually be found where the hanging antenna wire is attached to the motor-head unit (see the device's manual to identify this button). The name and color of the button may vary by manufacturer.

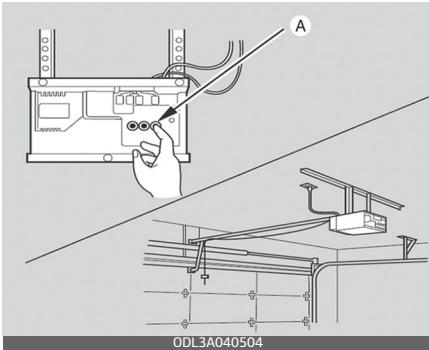

* A ladder and/or second person may simplify the following steps.

7. Firmly press and release the "Learn", "Smart", "Set" or "Program" button. You now have up to 30 seconds in which to complete the next step.
8. Return to the vehicle and firmly press, hold for two seconds and release, the HomeLink button up to three times in a row slowly. Do not press the HomeLink button rapidly. As soon as you see the garage door start to move, stop pressing any buttons until a few seconds after the garage door has come to a complete stop, regardless of position. At this point programming is complete and your device should operate when the HomeLink button is pressed and released.

3) Two-Way Communication Programming (For select garage door openers)

If your garage door opener has the 'myQ' logo on its side, your opener has Two-Way Communication capability. HomeLink has the capability to establish Two-Way Communication with your garage door opener. HomeLink can receive and display "closing" or "opening" status messages from compatible garage door openers. At any time, HomeLink can also recall and display the last recorded status communicated by the garage door opener to indicate your garage door being "closed" or "opened".

To check if your garage door opener is compatible with this feature, refer to www.homelink.com/compatible/Two-way-Communication. If your garage door opener has this functionality, AND the Two-Way Communication indicators (4), (6) in the mirror appear while the garage door is opening/closing, then no further steps are needed. Two-Way Communication Programming is already complete. However, if your garage door opener has this functionality, AND the Two-Way Communication indicators (4), (6) in the mirror DO NOT appear while the garage door is opening/closing, use the following instructions to enable this functionality.

1. In your vehicle, press and hold the programmed HomeLink button for 2 seconds, then release. Confirm that the garage door is moving. AFTER it stops, you will have one minute to complete the following steps:
 - * A ladder and/or second person may simplify the following steps.
2. On your garage door opener in your garage, locate the "Learn" button (usually near where the hanging antenna wire is attached to the garage door opener). If there is difficulty locating this button, refer to the device's owner's manual.
3. Press and release the "Learn" button.
4. A light on your garage door opener may flash, and your Two-Way Communication indicators (4), (6) in your vehicle may flash, confirming completion of the process.
5. Return to the vehicle and firmly press and release the programmed HomeLink button to activate your garage door. The Two-Way Communication indicators (4), (6) flash in orange when the door is moving. Do not make any additional button presses until AFTER the garage door has come to a complete stop.
6. Your Two-Way Communication programming is now complete.

* NOTICE

If your garage door opener has Two-Way Communication functionality, it is possible for HomeLink to stop functioning the garage door shortly after initial programming, if the Two-Way Communication Programming wasn't properly completed. This usually happens after the first 10 times a programmed HomeLink button is pressed. If you experience this, completing the "Programming a New HomeLink Button" and "Two-Way Communication Programming" will restore door operation.

4) Canadian Programming

Canadian radio-frequency laws require transmitter remote signals to "time-out" (or quit) after a couple seconds of transmission, which may not be long enough for HomeLink to pick up the signal during programming.

If you live in Canada or you are having difficulties programming a gate operator or garage door opener by using the programming procedures, replace "Programming a New HomeLink Button" step 3 with the following:

While the HomeLink indicator light (7) is flashing orange, press and release ("cycle") your device's hand-

held remote every two seconds until the HomeLink indicator light (7) changes from orange to green. You may now release the hand-held remote button. Then proceed with "Programming a New HomeLink Button" step 4.

2. Operating HomeLink®

1) Operating HomeLink®

1. Press and release the desired programmed HomeLink button (1, 2 or 3).



* NOTICE

The HomeLink indicator (7) should light green, solid or flashing, and your programmed device should operate.

If your device does not operate, the HomeLink programming was not successful, and you'll need to reprogram the button.

2) Two-Way Communication Display Behavior

1. Press and release one of the programmed HomeLink buttons (1, 2 or 3)



2. The indicator (4) and (6) operates as below, if your garage door opener has Two-Way Communication functionality.



- If the indicator (4) flashes in Orange, it indicates that the garage door is "Closing".
- The indicator (4) turns solid green once the garage door has closed.

- If the indicator (6) flashes in Orange, it indicates that the garage door is "Opening".
- The indicator (6) turns solid green once the garage door has fully opened.
- If the indicator (4) or (6) does not turn to green, it indicates that the last status of garage door was not received properly. The HomeLink mirror tries to receive the last known status of the garage door for a few seconds.

3) Recalling Garage Door Status

HomeLink mirror with Two-Way Communication provides a way to view the last stored message from the garage door opener. In order to recall the last known status of the last activated device, press the buttons "1 and 2" OR "2 and 3" simultaneously.

- If the indicator (4) appears solid Green, it indicates that the last activated device was "closed" properly.
- If the indicator (6) appears solid Green, it indicates that the last activated device was "open" properly.

3. Erasing HomeLink® Buttons

1) Erasing and Reprogramming a Single HomeLink® Button:

1. Press and hold the desired HomeLink button you want to re-program. DO NOT release the button.
2. The HomeLink indicator light (7) will illuminate solid green. Release the button as soon as the HomeLink indicator light (7) begins to flash orange, usually about 20 seconds.
3. Proceed with the steps in the "Programming a New HomeLink Button" section.

*** NOTICE**

If you do not complete the re-programming of a new device to the button, it will revert to the previously stored programming

2) The following instructions will erase ALL HomeLink® programming from ALL buttons:

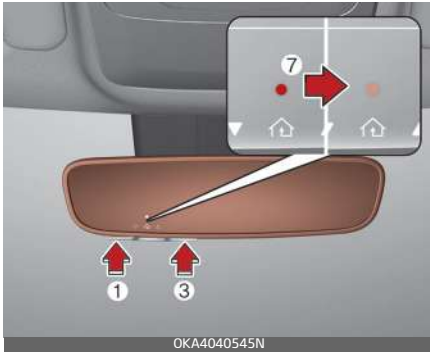

1. Press and hold the buttons (1) and (3) simultaneously
2. The HomeLink indicator light (7) will illuminate solid Orange for about 10 seconds
3. Release the buttons once the HomeLink indicator light (7) changes to Green and flashes rapidly
4. Now all three HomeLink buttons (1), (2) and (3) are cleared of any programming

Information

HomeLink and the HomeLink House logo are registered trademarks of Gentex Corporation.

The myQ logo is a registered trademark of The Chamberlain Group, Inc

FCC (USA) and ISED (Canada)

This device complies with FCC rules part 15 and Innovation, Science, and Economic Development Canada RSS-210. Operation is subject to the following two conditions: (1) This device may not cause harmful interference, and (2) This device must accept any interference that may be received including interference that may cause undesired operation. WARNING: The transmitter has been tested and complies with FCC and ISED rules. Changes or modifications not expressly approved by the party responsible for compliance could void the user's authority to operate the device.

This equipment complies with FCC and ISED radiation exposure limits set forth for an uncontrolled environment. End Users must follow the specific operating instructions for satisfying RF exposure compliance. This transmitter must be at least 20 cm from the user and must not be co-located or operating in conjunction with any other antenna or transmitter.

FCC (États-Unis) et ISED (Canada)

Cet appareil est conforme aux règlements de la FCC, section 15, et au CNR-210 d'Innovation, Sciences et Développement économique Canada. Le fonctionnement est assujéti aux deux conditions suivantes: (1) cet appareil ne doit pas causer d'interférences nuisibles et (2) cet appareil doit accepter toute interférence reçue, y compris celle qui pourrait entraîner un dysfonctionnement. MISE EN GARDE: L'émetteur a subi des tests et est conforme aux règlements de la FCC et d'ISDE. Les changements ou modifications non approuvés explicitement par la partie responsable de la conformité pourraient rendre caduque l'autorisation de l'utilisateur de se servir du dispositif.

Cet appareil est conforme aux limites d'exposition aux radiations de la FCC et d'ISDE établies pour un environnement non contrôlé. Les utilisateurs finaux doivent respecter les instructions d'utilisation spécifiques pour satisfaire aux exigences de conformité aux expositions de RF. L'émetteur doit se trouver à 20 cm au minimum de l'utilisateur et ne doit pas être situé au même endroit que tout autre émetteur ou antenne ni fonctionner avec un autre émetteur ou antenne.

HomeLink 5 Programing Flow Chart

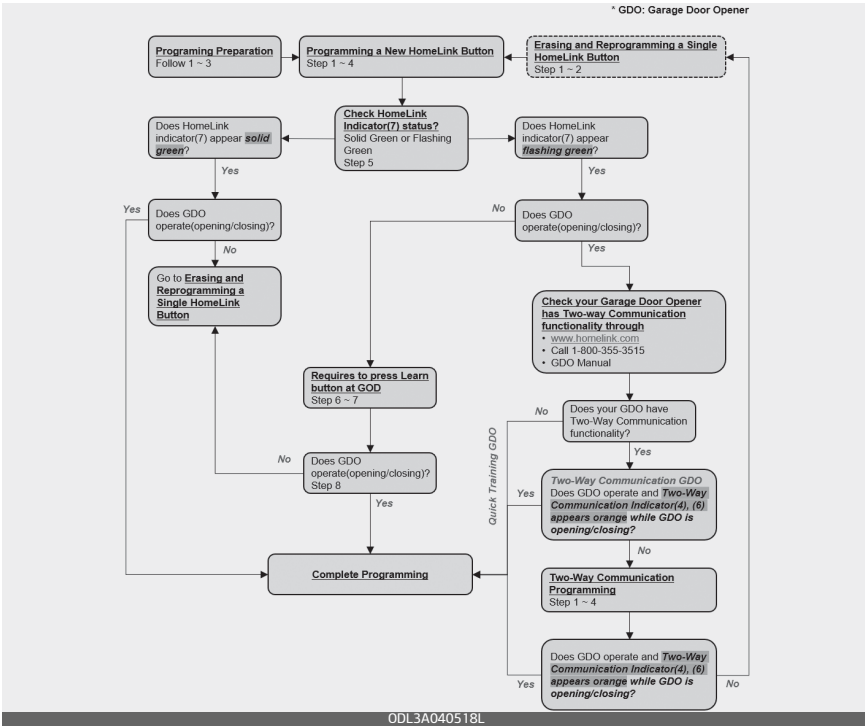

Outside rear view mirror

Your vehicle is equipped with both left-hand and right-hand outside rear view mirrors.

Be sure to adjust the mirror angles before driving.

The mirrors can be adjusted remotely with the control levers or remote switch, depending on the type of mirror control installed. The mirror heads can be folded back to prevent damage during an automatic car wash or when passing through a narrow street.

* NOTICE

Rear view mirrors

- The outside rear view mirror is convex. Objects seen in the mirror are closer than they appear.
- Use your interior rear view mirror or direct observation to determine the actual distance of following vehicles when changing lanes.

⚠ CAUTION

Do not scrape ice off the mirror face; this may damage the surface of the glass. If ice should restrict the movement of the mirror, do not force the mirror for adjustment. To remove ice, use a deicer spray, or a sponge or soft cloth with warm water.

⚠ CAUTION

If the mirror is jammed with ice, do not adjust the mirror by force. Use an approved spray de-icer (not radiator antifreeze) to release the frozen mechanism or move the vehicle to a warm place and allow the ice to melt.

⚠ WARNING

Do not adjust or fold the outside rear view mirrors while the vehicle is moving. This could result in loss of control, and an accident which could cause DEATH, SERIOUS INJURY, or property damage.

Adjusting the outside rear view mirrors

The electric remote control mirror switch allows you to adjust the position of the left and right outside rear view mirrors.

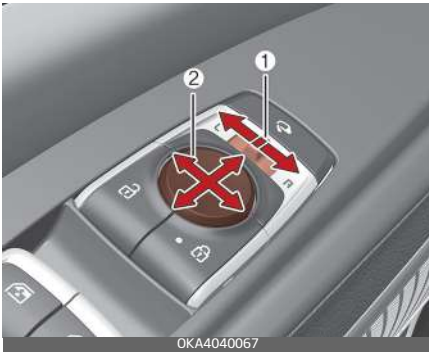

OKA4040067

Adjusting the rear view mirrors:

1. Move the R or L switch (1) to select the right side mirror or the left side mirror.
2. Press a corresponding point on the mirror adjustment control (2) to position the selected mirror up, down, left or right.

⚠ CAUTION

- The mirrors stop moving when they reach the maximum adjusting angles, but the motor continues to operate while the switch is pressed. Do not press the switch longer than necessary, the motor may be damaged.
- Do not attempt to adjust the outside rear view mirror by hand. Doing so may damage the parts.

Folding the outside rear view mirror

Manual type (if equipped)

To fold the outside rear view mirror, grasp the housing of the mirror and then fold it toward the rear of the vehicle.



OKA4040071

Electric type (if equipped)

The outside rear view mirror can be folded or unfolded by pressing the switch as below.



OKA4040068

- To fold the outside rear view mirror depress the button.
- To unfold it, depress the button again.

⚠ CAUTION

The electric type outside rear view mirror operates even though the ignition switch or ENGINE START/STOP button is in the LOCK or OFF position. However, to prevent unnecessary battery discharge, do not adjust the mirrors longer than necessary while the engine is not running.

⚠ CAUTION

In case it is an electric type outside rear view mirror, don't fold it by hand. It could cause motor failure.

Reverse parking aid function (if equipped)

When you shift the gear to the R (Reverse) position, the outside rear view mirror(s) will rotate downwards to aid with driving in reverse.

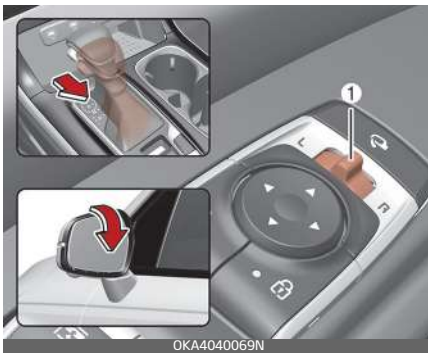

The position of the outside rear view mirror switch (1) determines

whether or not the mirrors will move:

Left/Right: When either the L (Left) or R (Right) switch is selected, both outside rear view mirrors will move.

Neutral: When neither switch is selected, the outside rear view mirrors will not move.

The outside rear view mirrors will automatically revert to their original positions if any of the followings occur:

- The ignition switch or ENGINE START/STOP button is placed to either the LOCK/OFF position or the ACC position.
- The gear is shifted to any position except R (Reverse).
- The remote control outside rear view mirror switch is not selected.

Auto reverse user settings

If you cannot secure enough visibility with the angles provided as factory default conditions, you can readjust and store the angles of outside rear view mirrors.

The factory default angles of the right and left rear view mirrors might be set differently to improve visibility.

1. Set the shift lever to P (Parking). Make sure that the vehicle is stopped and the mirrors are not working.

2. Position the lever to L (left) or R (right) depending on the mirror that you want to adjust.
3. Step on the brake pedal and shift the shift lever to R (Reverse).
4. When the downward movement of the rear view mirror is finished, adjust the mirror to the desired angle by pressing the switches, ▼, ▲, ◀, ▶.
5. If you shift the shift lever to a position other than R (Reverse), or change the rear view mirror selector lever to the neutral position, and the automatic return of the mirror is finished, the adjusted angle will be automatically saved.
6. You can adjust the rear view mirror on the other side by following the same procedures (1-5).
4. When the downward movement of the rear view mirror is finished, press the switch ▲ to locate the mirror in the position higher than before (P, N or D).
(Adjust the mirror in the higher position compared to its position in the driving mode)
5. It is initialized when the shift lever is shifted to a position other than R (Reverse), or the rear view mirror selector lever is changed to the neutral position. (Initialized position will be applied from next operation)
6. You can initialize settings for the mirror on the other side by following the same procedures (1-5).

How to reset auto reverse user settings

If you want to change the automatic control function of rear view mirrors to factory-default conditions, follow the steps below.

1. Shift the shift lever to P (Park).
Make sure that the vehicle is stopped and the mirror is not working.
2. Choose the mirror to be adjusted by positioning the lever to L (left) or R (right).
3. Step on the brake pedal and shift the shift lever to R (Reverse).

⚠ CAUTION

We recommend following the procedures in an orderly manner to change or initialize the auto reversing user settings.

If you move to the next step before completing the previous one, the changed angle may not be changed or initialization may not work properly.

Instrument cluster

Conventional cluster (Type A)



OKA4040100CF

Full LCD cluster (Type B)

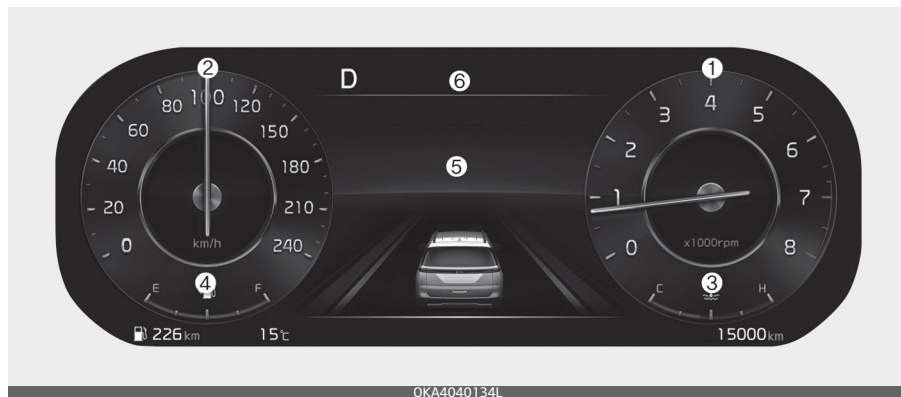

OKA4040134L

* The actual cluster in the vehicle may differ from the illustration.

1. Tachometer
2. Speedometer
3. Engine coolant temperature gauge
4. Fuel gauge
5. LCD display (including Trip computer)
6. Warning and indicator lights

Full LCD cluster (if equipped)

The full LCD type cluster provides two themes.

Type A

Type A is the basic theme of the full LCD type cluster and provides different graphic styles depending on drive mode.

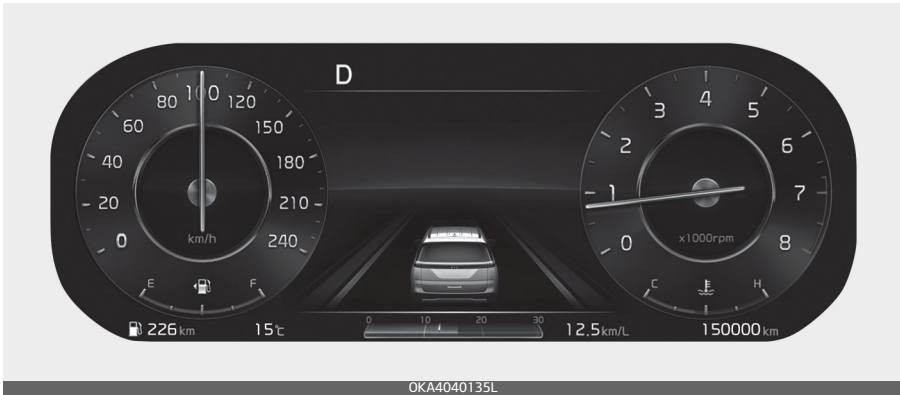

Type B (Dynamic)

Type B is set by the user and provides digital display. The background screen changes according to the weather and time.

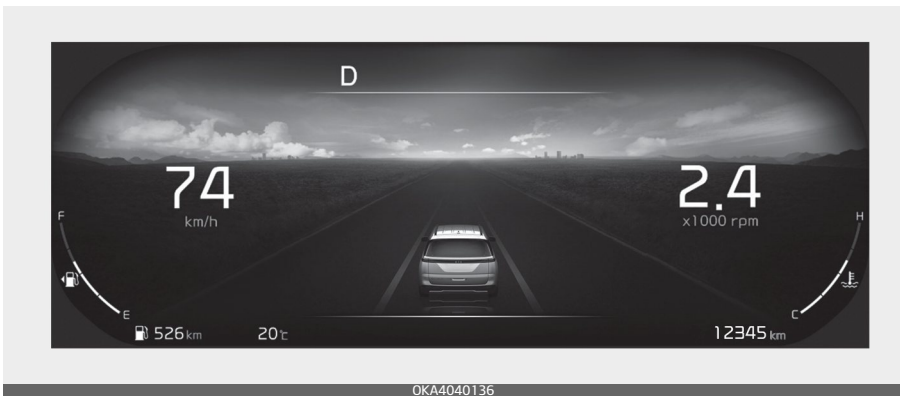

- Weather: sunny, cloudy, rainy, or snowy (4 types)
- Time: night, day, sunrise and sunset (4 types)

You can change the theme by selecting "Vehicle →Instrument Cluster Setting →Theme Selection" on the menu.

* NOTICE

The information is displayed after getting information from a weather information provider via GPS. Depending on conditions of GPS reception, the information may be different from the current weather in your area.

If no information is received via GPS (e.g., not subscribed to UVO service), the weather and time will be displayed as 'sunny' and 'night' on the cluster.

Adjusting instrument cluster illumination

The brightness of the instrument panel illumination is changed by pressing the illumination control button ("+" or "-") when the ignition switch or ENGINE START/STOP button is ON, or the taillamps are turned on.

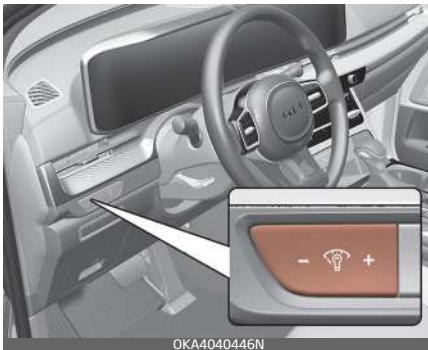

⚠ WARNING

Never adjust the instrument cluster while driving. This could result in loss of control and lead to an accident that may cause DEATH, SERIOUS INJURY, or property damage.

- If you hold the illumination control button ("+" or "-"), the brightness will be changed continuously.

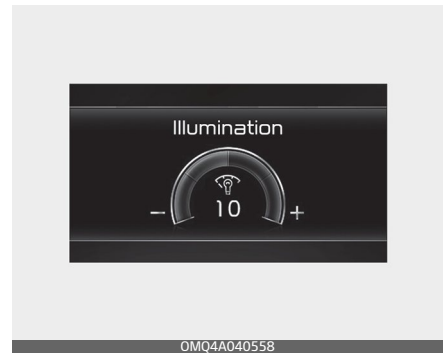

- If the brightness reaches to the maximum or minimum level, an alarm will sound.

Gauges

The gauges display various information such as the speed of the vehicle, and so on.

Speedometer

Type A
MPH, km/h km/h, MPH



Type B
MPH km/h



The speedometer indicates the speed of the vehicle and is calibrated in kilometers per hour (km/h) and miles per hour (mph).

Tachometer

Type A



Type B



The tachometer indicates the approximate number of engine revolutions per minute (rpm).

Use the tachometer to select the correct shift points and to prevent lugging and/or over-revving the engine.

CAUTION

Do not operate the engine within the tachometer's RED ZONE. This may cause severe engine damage.

Engine coolant temperature gauge

Type A



Type B

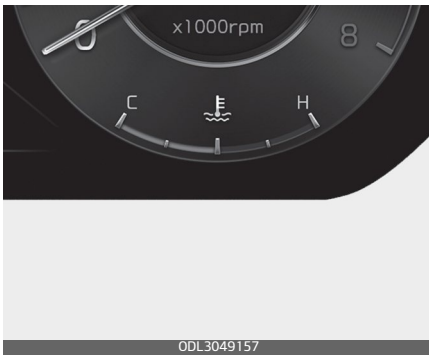

This gauge indicates the temperature of the engine coolant when the ignition switch or ENGINE START/STOP button is ON.

CAUTION

If the gauge pointer moves beyond the normal range area toward the "H" position, it indicates overheating that may damage the engine.

Do not continue driving with an overheated engine. If your vehicle

overheats, refer to "If the engine overheats" on page 6-8.

WARNING

Never remove the radiator cap when the engine is hot. The engine coolant is under pressure and could severely burn. Wait until the engine is cool before adding coolant to the reservoir.

Fuel gauge

Type A



Type B

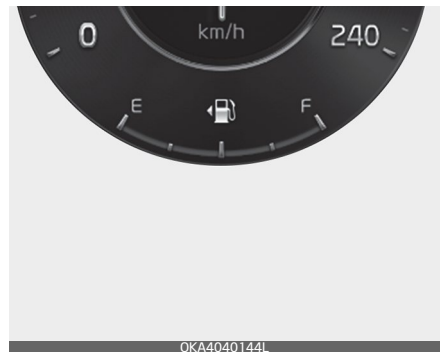

4

This gauge indicates the approximate amount of fuel remaining in the fuel tank.

*** NOTICE**

- The fuel tank capacity is given in "Recommended lubricants and capacities" on page 8-6.
- The fuel gauge is supplemented by a low fuel warning light, which will illuminate when the fuel tank is nearly empty.
- On inclines or curves, the fuel gauge pointer may fluctuate or the low fuel warning light may come on earlier than usual due to the movement of fuel in the tank.

*** NOTICE**

Fuel gauge

Running out of fuel can expose vehicle occupants to danger.

You must stop and obtain additional fuel as soon as possible after the warning light comes on or when the gauge indicator comes close to the "E" level.

⚠ CAUTION

Avoid driving with an extremely low fuel level. Running out of fuel could cause the engine to misfire, which could damage the catalytic converter.

*** NOTICE**

The fuel display may not be accurate if the vehicle is on an incline.

Odometer

Type A

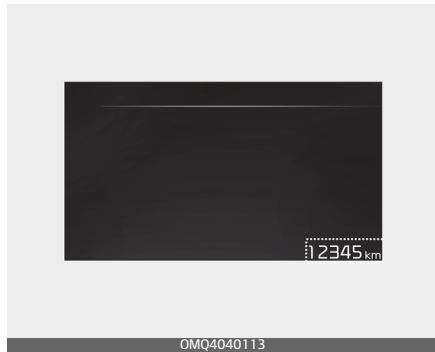

Type B



The odometer indicates the total distance that the vehicle has been driven and should be used to determine when periodic maintenance should be performed.

- Odometer range: 0 ~ 1,599,999 km or 999,999 miles.

Distance to empty

Type A



Type B

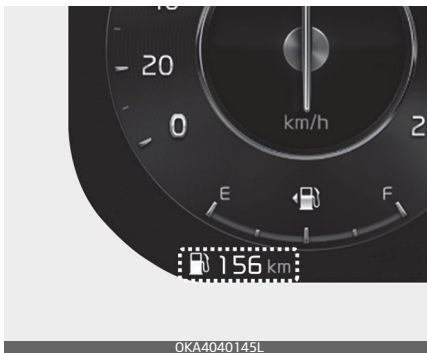

- The distance to empty is the estimated distance the vehicle can be driven with the remaining fuel.
 - Distance range: 1 ~ 9,999 km or 1 ~ 9,999 mi.
- If the estimated distance is below 1 km (1 mile), the trip computer will display "---" as distance to empty.
- If the level of the remaining fuel is more than three-quarters, more than 3 liters (0.8 gallons) of fuel must be refilled for the fuel gauge

to change. In other cases, more than 6 liters (1.6 gallons) of fuel must be refilled for the vehicle to change the fuel gauge.

*** NOTICE**

- If the vehicle is not on level ground or the battery power has been interrupted, the distance to empty function may not operate correctly.
- The distance to empty may differ from the actual driving distance as it is an estimate of the available driving distance.
- The trip computer may not register additional fuel if less than 6 liters (1.6 gallons) of fuel are added to the vehicle.
- The fuel economy and distance to empty may vary significantly based on driving conditions, driving habits, and condition of the vehicle.

Outside temperature gauge

Type A



Type B



The temperature unit can be changed by using the "User Settings" mode of the LCD Display.

* For more details, refer to "User settings mode" on page 4-110.

Transmission shift indicator

Transmission shift indicator displays gear information depending on your vehicle's transmission type.

Automatic transmission shift indicator

Type A



Type B

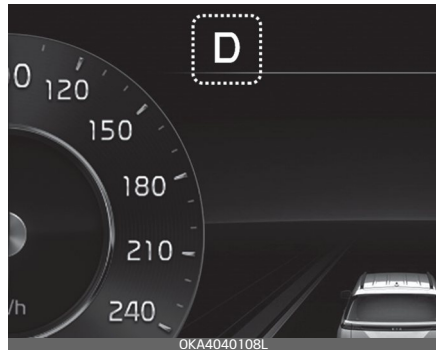

This gauge indicates the current outside air temperatures by 1 °C (1 °F).

- Temperature range: -40 °C ~ 60 °C (-40 °F ~ 140 °F)

The outside temperature on the display may not change immediately like a general thermometer to prevent the driver from being inattentive.

To change the temperature unit (from °C to °F or from °F to °C)

This indicator displays which automatic transmission gear is selected.

- Park: P
- Reverse: R
- Neutral: N
- Drive: D

Manual shift mode

- Shifting up: ▲2, ▲3, ▲4, ▲5, ▲6, ▲7, ▲8
- Shifting down: ▼1, ▼2, ▼3, ▼4, ▼5, ▼6, ▼7

Shift indicator pop-up

The pop-up that indicates the current gear position is displayed in the cluster for about 2 seconds when shifting into other positions (P/R/N/D).

The shift indicator pop-up function can be activated or deactivated from the User Settings mode in the cluster LCD display.

LCD display

The LCD display modes can be changed with the control buttons.







LCD Display Control



1. : MODE button for changing modes
2. : MOVE switch for changing items
3. : OK: SELECT/RESET button for setting or resetting the selected item

LCD display modes

The LCD display provides 5 modes. You can switch modes by pressing the Mode button.

		 Mode				
		 Trip Computer	 Turn By Turn (TBT)*	 Driving Assist	 User Settings*	 Master warning
 Up/Down	Drive Info	Route Guidance	Lane Safety/SCC*	Driver Assistance	The Master Warning mode displays warning messages related to the vehicle when one or more systems is not operating normally.	
	Since Refueling	Destination Info	DAW*	Cluster		
	Accumulated Info		TPMS*	Lights		
	Digital Speedometer			Door		
				Convenience		
			Units			
			Language			
			Reset			

The information provided may differ depending on which functions are applicable to your vehicle.

* : if equipped

* NOTICE

Keep the engine running when configuring the display settings to prevent the battery from discharging.

Trip computer mode

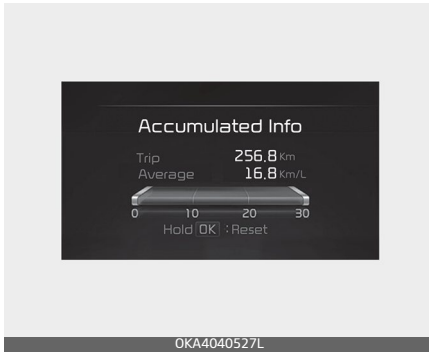

The trip computer mode displays information related to vehicle driving parameters including fuel economy, tripmeter information and vehicle speed.

* For more details, refer to "Trip information (trip computer)" on page 4-117.

Turn By Turn (TBT) mode (if equipped)



This mode displays the state of the navigation.

Driving Assist mode



This mode displays the state of:

- Lane Safety system
- Smart Cruise Control
- Driver Attention Warning
- Tire Pressure Monitoring System

This mode displays information related to tire pressure status.

* For more details, refer to "Tire Pressure Monitoring System (TPMS)" on page 6-10.

* For more details, refer to each system information in "Driving your vehicle" on page 5-6.

Master warning mode

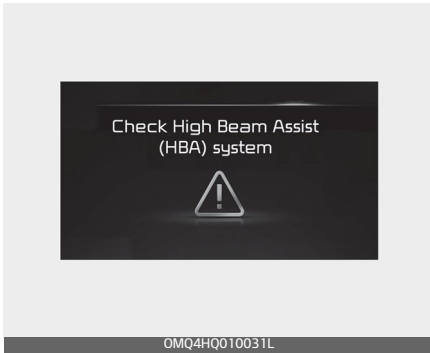

This warning light informs the driver the following situations.

- LED headlamp malfunction
- Lamp malfunction
- High Beam Assist malfunction

At this time, a Master Warning icon (⚠) will appear beside the User Settings icon (⚙), on the LCD display. If the warning situation is solved, the master warning light will be turned off and the Master Warning icon will disappear.

User settings mode



In this mode, you can change the settings of the instrument cluster, doors, lamps, etc.

1. Driver Assistance
2. Cluster
3. Lights
4. Door
5. Convenience
6. Units
7. Language
8. Reset

The information provided may differ depending on which functions are applicable to your vehicle.

1. Driver Assistance

Items	Explanation
Driving Convenience	To adjust Highway Driving Assist. <ul style="list-style-type: none"> • Highway Driving Assist • Highway Auto Speed Change To select the functions. * For more details, refer to "Highway Driving Assist (HDA) (if equipped)" on page 5-155.
Speed Limit	To adjust Speed Limit. <ul style="list-style-type: none"> • Speed Limit Offset • Auto Speed Change • Speed Limit Assist • Speed Limit Warning • Off To select the functions. * For more details, refer to "Intelligent Speed Limit Assist (ISLA) (if equipped)" on page 5-108.
Warning Timing	<ul style="list-style-type: none"> • Normal/Late To select the Warning time.
Warning Volume	<ul style="list-style-type: none"> • High/Medium/Low To select the Warning volume.
Driver Attention Warning	<ul style="list-style-type: none"> • Leading Vehicle Departure Alert • Inattentive Driving Warning To select the function. * For more details, refer to "Driver Attention Warning (DAW)" on page 5-113.
Forward Safety	To adjust Forward Collision-Avoidance Assist. <ul style="list-style-type: none"> • Active Assist / Warning Only / Off To select the functions.
Lane Safety	To adjust Lane Keeping Assist. <ul style="list-style-type: none"> • Lane Keeping Assist / Warning Only / Off To select the functions.

Items	Explanation
Blind-Spot Safety	To activate or deactivate Blind-Spot View Monitor. <ul style="list-style-type: none"> • Blind-Spot View To activate or deactivate Safe Exit Assist or Safe Exit Warning. <ul style="list-style-type: none"> • Safe Exit Assist (SEA) • Safe Exit Warning (SEW) For more details, refer to "Safe Exit Assist (SEA) (if equipped)" on page 5-102. To Activate or deactivate Blind-Spot Collision-Avoidance Assist. <ul style="list-style-type: none"> • Active Assist / Warning Only / Off For more details, refer to "Blind-Spot Collision-Avoidance Assist (BCA) (if equipped)" on page 5-84.
Parking Safety	<ul style="list-style-type: none"> • Surround View Monitor Auto On • Parking Distance Warning Auto On • Rear Cross-Traffic Safety To Activate or deactivate Rear Cross-Traffic Collision-Avoidance Assist. <ul style="list-style-type: none"> • Rear Active Assist / Rear Warning Only / Off For more details, refer to "Rear Cross-Traffic Collision-Avoidance Assist (RCCA) (if equipped)" on page 5-161.

* The information provided may differ depending on which systems are applicable to your vehicle.

2. Cluster

Items	Explanation
Average Fuel Economy (if equipped)	At vehicle start / After refueling / Manually: The average fuel economy will reset automatically at vehicle start / after refueling / manually.
Wiper/Lights Display	If this item is checked, the wiper/lights display will be activated.
Traffic Signs	If this item is checked, the traffic signs display will be activated.
Icy Road Warning	If this item is checked, the icy road warning will be activated.
Welcome Sound	If this item is checked, the welcome sound function will be activated.

Items	Explanation
Theme Selection	<ul style="list-style-type: none"> Link to Drive Mode / Classic A / Classic B / Classic C / Dynamic If this item is checked, the cluster theme will change accordingly.

* The information provided may differ depending on which systems are applicable to your vehicle.

3. Lights

Items	Explanation
Illumination	To adjust the instrument cluster illumination. <ul style="list-style-type: none"> 1~20 level
One Touch Turn Signal	<ul style="list-style-type: none"> Off: The one touch turn signal function will be deactivated. 3, 5, 7 flashes: The turn signal indicator will blink 3, 5, or 7 times when the turn signal lever is moved slightly. * For more details, refer to "Lighting" on page 4-152.
Headlight Delay	If this item is checked, the head lamp delay function will be activated.
High Beam Assist	If this item is checked, High Beam Assist will be activated.

* The information provided may differ depending on which functions are applicable to your vehicle.

4. Door

Items	Explanation
Automatically Lock	<ul style="list-style-type: none"> Enable on shift (for Automatic transmission): All doors will be automatically locked if the vehicle is shifted from the P (Park) position to the R (Reverse), N (Neutral), or D (Drive) position. (With the Engine ON, it is activated.) Enable on speed (for Automatic transmission): All doors will be automatically locked when the vehicle speed exceeds 9.3 mph (15 km/h) Off: The auto door unlock operation will be canceled. * If the setting is changed while the vehicle is in motion, the changed setting may not immediately operate.

Items	Explanation
Automatically Unlock	<ul style="list-style-type: none"> On shift to P (for Automatic transmission): All doors will be automatically unlocked if the gear is shifted to the P (Park) position. (With the Engine ON, it is activated.) Vehicle Off / On key out (if equipped): All doors will be automatically unlocked when the ignition key is removed from the ignition switch or the ENGINE START/STOP button is set to the OFF position. Off: The auto door unlock operation will be canceled.
2 Press Unlock	<p>If this item is checked, the two press unlock will be activated. Press the door unlock button once to unlock the driver's door, and press the button once more within 4 seconds to unlock the rest of the doors.</p>
Power Liftgate Opening Speed	<ul style="list-style-type: none"> Fast: The power liftgate will be closed faster than normal speed. Normal: The power liftgate will be closed in normal speed.
Power Liftgate Opening Height	<ul style="list-style-type: none"> Full Open/Level 3/Level 2/Level 1/User Height Setting <p>The power liftgate will be opened in a certain angle.</p>
Liftgate Auto Close	<p>To activate or deactivate Liftgate Auto Close. For more details, refer to "Liftgate Auto Close (if equipped)" on page 4-55.</p>
Smart Liftgate	<p>To activate or deactivate the Smart Liftgate with Auto Open. For more details, refer to "Smart Liftgate with Auto Open (if equipped)" on page 4-57.</p>
Smart Sliding Door	<p>To activate or deactivate the Smart Sliding Door with Auto Open. For more details, refer to "Smart Sliding Door with Auto Open (if equipped)" on page 4-43.</p>
Remote Power Doors & Liftgate	<p>To adjust Remote Power Doors & Liftgate</p> <ul style="list-style-type: none"> Off: The Remote Power Doors & Liftgate function is turned off. Open Sliding Doors: The sliding doors & liftgate open simultaneously. Open Liftgate & Sliding Doors: The sliding doors & liftgate opens simultaneously. <p>* For more details, refer to "Simultaneous Power Door (if equipped)" on page 4-41.</p>

* The information provided may differ depending on which systems are applicable to your vehicle.

5. Convenience

Items	Explanation
Seat Easy Access	<ul style="list-style-type: none"> • Off/Normal/Extended To select the seat movement.
Rear Occupant Alert	If this item is checked, the Rear Occupant Alert (ROA) display will be activated.
Welcome Mirror/Light	<ul style="list-style-type: none"> • On door unlock/On driver approach To select the welcome mirror/light function.
Wireless Charging System	If this item is checked, the wireless charging function will be activated.
Auto Rear Wiper (in R)	If this item is checked, the auto rear wiper will be activated.
Service Interval	<ul style="list-style-type: none"> • Enable Service Interval If this item is checked, the Service Interval function will be activated. <ul style="list-style-type: none"> • Adjust Interval If the service interval menu is activated, you may adjust the time and distance. <ul style="list-style-type: none"> • Reset To reset the service interval function.

4

* NOTICE

To use the service interval menu, consult an authorized Kia dealer.

* The information provided may differ depending on which functions are applicable to your vehicle.

If the service interval is activated and the time and distance is adjusted, messages are displayed in the following situations each time the vehicle is turned on.

- Service in: Displayed to inform the driver the remaining mileage and days to service.
- Service required: Displayed when the mileage and days to service has been reached or passed.

If any of the following conditions occur, the mileage and number of days to service may be incorrect.

- The battery cable is disconnected.
- The battery is discharged.

6. Units

Items	Explanation
Speedometer Unit	<ul style="list-style-type: none"> • km/h / mph To select the Speedometer unit.
Fuel Economy Unit	<ul style="list-style-type: none"> • Km/L, L/100Km, mpg To select the Fuel economy unit. For more details, refer to "Trip information (trip computer)" on page 4-117.
Temperature Unit	<ul style="list-style-type: none"> • °C/°F To select the Temperature unit.
Tire Pressure Unit	<ul style="list-style-type: none"> • psi, kPa, bar To select the Tire Pressure Unit

* The information provided may differ depending on which functions are applicable to your vehicle.

7. Language

Items	Explanation
Language	To select language.

8. Reset

Items	Explanation
Reset	You can reset the menus in the User Settings mode. All menus in the User Settings mode are reset to factory settings, except language and service interval.

LCD displays

LCD displays show the following information to drivers.

- Trip information
- LCD modes
- Warning messages

Trip information (trip computer)

The trip computer is a microcomputer- controlled driver information system that displays information related to driving.

* NOTICE

Some driving information stored in the trip computer resets if the battery is disconnected.

Trip modes

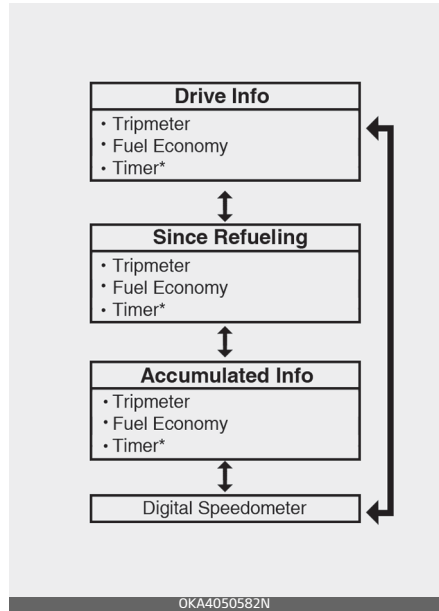

4

*: Timer is displayed for Full LCD Cluster

To change the trip mode, toggle the switch (∧/∨) on the steering wheel.

Fuel economy (if equipped)

This information is always displayed at the bottom center of the Full LCD cluster.

Average Fuel Economy (1)

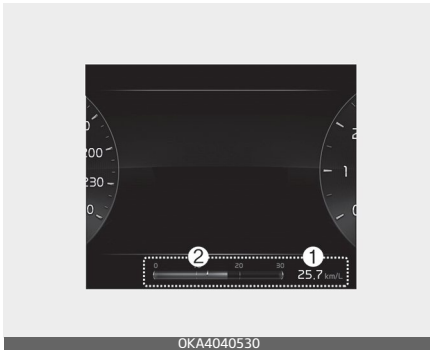

- The average fuel economy is calculated by the total driving distance and fuel consumption since the last average fuel economy resets.
 - Fuel economy range: 0 ~ 99.9 km/L, L/100 km or mpg

To make the average fuel economy be reset automatically whenever refueling, select the "Reset fuel economy" mode in User Setting menu of the LCD Windows (Refer to "User settings mode" on page 4-110).

- At vehicle on - The information will automatically reset when the driver's door is opened after the ignition is turned off, or approximately 3 minutes have passed after the ignition is turned off.

- After refueling - After refueling more than 6 liters (1.6 gallons) and driving over 1 km/h (1 mph), the vehicle will reset to default automatically.

*** NOTICE**

The average fuel economy is not displayed for more accurate calculation if the vehicle does not drive more than 10 seconds or 50 m (0.03 mi) since the ignition switch or ENGINE START/STOP button is turned to ON.

Instant Fuel Economy (2)

- This mode displays the instant fuel economy during the last few seconds when the vehicle speed is more than 10 km/h (6.2 mph).
 - Fuel economy range: 0.0 ~ 30 km/L, L/100 km or 0.0 ~ 50.0 mpg

Accumulated driving information mode

This display shows the accumulated trip distance, the average fuel efficiency, and the instant fuel efficiency (or the total driving time).



OKA4040527L

- Accumulated information is calculated after the vehicle has run for more than 300 m (0.19 miles).
- If you press "OK" button for more than 1 second after the Cumulative Information is displayed, the information will be reset.
- If the engine is running, even when the vehicle is not in motion, the information will be accumulated.

Drive Info display

This display shows the trip distance, the average fuel efficiency, and the instant fuel efficiency (or the total driving time) once per one ignition cycle.



OKA4040587L

- Fuel efficiency is calculated after the vehicle has run for more than 300 m (0.19 miles).
- The information will automatically reset when the driver's door is opened after the ignition is turned off, or approximately 3 minutes have passed after the ignition is turned off.
- If the engine is running, even when the vehicle is not in motion, the information will be accumulated.

* NOTICE

The vehicle must be driven for a minimum of 300 m (0.19 miles) since the last ignition cycle before the average accumulated driving information is recalculated.

Information since refueling

This display shows the trip distance, the average fuel efficiency, and the instant fuel efficiency (or the total driving time) since refueling.



- Information since refueling is calculated after the vehicle has run for more than 300 m (0.19 miles).
- If you press "OK" button for more than 1 second after the information since refueling is displayed, the information will be reset.
- If the engine is running, even when the vehicle is not in motion, the information will be accumulated.

Digital speedometer

This digital speedometer display shows the speed of the vehicle.



Service mode

This mode reminds you of scheduled maintenance information.

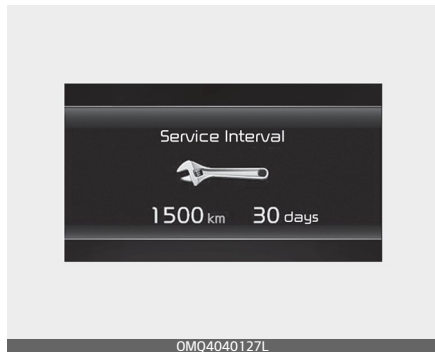

Service Interval

It calculates and displays when you need a scheduled maintenance service (mileage or days).

If the remaining mileage or time reaches 1,500 km (900 miles) or 30 days, "Service interval" message is displayed for several seconds each time you set the ignition switch or ENGINE START/STOP Button to the ON position.

Service required

If you do not have your vehicle serviced according to the already inputted service interval, "Service required" message is displayed for several seconds each time you set the ignition switch or ENGINE START/STOP Button to the ON position.

To reset the service interval to the mileage and days you inputted before:

- Press the OK button (Reset) for more than 1 second.

* NOTICE

If any of the following conditions occurs, the mileage and days may be incorrect.

- The battery cable is disconnected.
- The battery is discharged.

Driving info display

At the end of each driving cycle, the Driving Info message is displayed.



This display shows the trip distance, the average fuel efficiency, and the instant fuel efficiency (or the total driving time).

This information is displayed for a few seconds when you turn off the vehicle, and then goes off automatically. The information is calculated for each time the vehicle is turned on.

* NOTICE

- If sunroof open warning is displayed in the cluster, the Driving Information message may not be displayed.

LCD display messages

Door, hood, liftgate, sunroof open



- This warning is displayed indicating which door, the hood, the liftgate or the sunroof is open.

Low tire pressure warning display



This warning message is displayed if the tire pressure is low. The corresponding tire on the vehicle will be illuminated.

* For more details, refer to "Tire Pressure Monitoring System (TPMS)" on page 6–10.

Lights mode



This indicator displays which exterior light is selected using the lighting control.

You can activate or deactivate Wiper/Lights Display function from the User Settings mode in the cluster LCD display.

Wiper mode

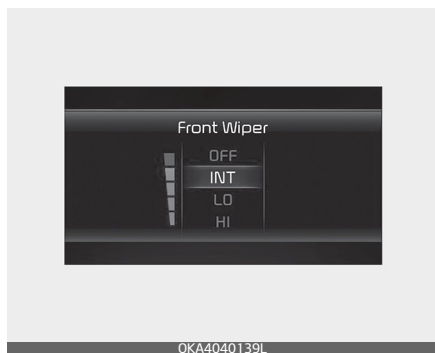

This indicator displays which wiper speed is selected using the wiper control.

You can activate or deactivate Wiper/Lights Display function from

the User Settings mode in the cluster LCD display.

Low washer fluid

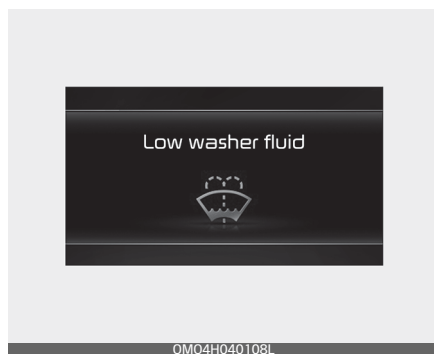

This warning message is displayed if the washer fluid level in the reservoir is nearly empty.

Have the washer fluid reservoir refilled.

Icy road warning

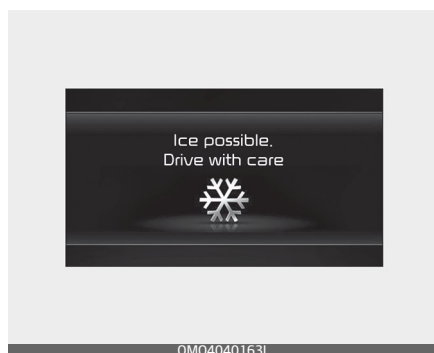

This warning is to warn the driver the road may be icy.

When the following conditions occur, the warning light (including outside

temperature gauge) blinks 5 times and then illuminates, and also warning chime sounds once.

- The temperature on the outside temperature gauge is below approximately 4 °C (40 °F).

*** NOTICE**

If the icy road warning appears while driving, you should drive more attentively and safely refraining from over-speeding, rapid acceleration, sudden braking or sharp turning, etc.

Engine has overheated

- This warning message illuminates when the engine coolant temperature is above 120 °C (248 °F). This mean that the engine is overheated and may be damaged.
- * If your vehicle is overheated, refer to "If the engine overheats" on page 6–8.

Low key battery (for smart key system)

- This warning message illuminates if the battery of the smart key is discharged when the ENGINE START/STOP Button changes to the OFF position.

Press START button while turning wheel (for smart key system)

- This warning message illuminates if the steering wheel does not unlock normally when the ENGINE START/STOP Button is pressed.
- It means that you should press the ENGINE START/STOP Button while turning the steering wheel right and left.

Steering wheel unlocked (for smart key system)

- This warning message illuminates if the steering wheel does not lock when the ENGINE START/STOP Button changes to the OFF position.

Check steering wheel lock system (for smart key system)

- This warning message illuminates if the steering wheel does not lock normally when the ENGINE START/STOP Button changes to the OFF position.

Key not in vehicle (for smart key system)

- This warning message illuminates if the smart key is not in the vehicle when you press the ENGINE START/STOP Button.
- It means that you should always have the smart key with you.

Key not detected (for smart key system)

- This warning message illuminates if the smart key is not detected when you press the ENGINE START/STOP Button.

Shift to P or N to start engine (for smart key system)

- This warning message illuminates if you try to start the engine with the gear not in the P (Park) or N (Neutral) position.

Press brake pedal to start engine (for smart key system)

- This warning message illuminates if the ENGINE START/STOP Button changes to the ACC position twice by pressing the button repeatedly without depressing the brake pedal.
- It means that you should depress the brake pedal to start the engine.

Battery discharging due to external electrical devices

The vehicle can detect self-discharge of the battery due to over-current that is generated by unauthorized electrical devices such as dashboard camera (dash cam) mounting during parking.

If the warning continues even after external electrical devices are removed, have your vehicle inspected by an authorized Kia dealer.

Press start button again (for smart key system)

- This warning message illuminates if you can not operate the ENGINE START/STOP Button when there is a problem with the ENGINE START/STOP Button system.
- It means that you could start the engine by pressing the ENGINE START/STOP button once more.
- If the warning illuminates each time you press the ENGINE START/STOP Button, have the vehicle inspected by an authorized Kia dealer.

Press start button with key (for smart key system)

- This warning message illuminates if you press the ENGINE START/STOP Button while the warning message "Key not detected" is illuminating.
- At this time, the immobilizer indicator light blinks.

Warning lights and indicators

The warning light and indicator light indicate a situation where the driver should be careful and whether the various functions are activated.

Warning lights

The warning light indicates situations that require the driver to pay attention.

*** NOTICE**

Warning lights

Make sure that all warning lights are OFF after starting the engine. If any light is still ON, this indicates a situation that needs attention.

Air bag warning light

This warning light illuminates:

- Once you set the ignition switch or ENGINE START/STOP Button to the ON position.
 - It illuminates for approximately 3 ~ 6 seconds and then goes off.
- When there is a malfunction with the SRS. In this case, have the vehicle inspected by an authorized Kia dealer.

Seat belt warning light

This warning light informs the driver that the seat belt is not fastened.

* For more details, refer to "Seat belts" on page 3-33.

Parking brake & brake fluid warning light

This warning light illuminates:

- Once you set the ignition switch or ENGINE START/STOP Button to the ON position.
 - It illuminates for approximately 3 seconds
 - It remains on if the parking brake is applied.
- When the parking brake is applied.
- When the brake fluid level in the reservoir is low.
 - If the warning light illuminates with the parking brake released, it indicates the brake fluid level in reservoir is low.

If the brake fluid level in the reservoir is low:

1. Drive carefully to the nearest safe location and stop your vehicle.
2. With the engine stopped, check the brake fluid level immediately and add fluid as required (For more details, refer to "Brake fluid" on page 7-17). Then check all brake components for fluid leaks. If any leak on the brake system is

still found, the warning light remains on, or the brakes do not operate properly, do not drive the vehicle.

In this case, have your vehicle towed to an authorized Kia dealer and inspected.

Dual-diagonal braking system

Your vehicle is equipped with dual-diagonal braking systems. This means you still have braking on two wheels even if one of the dual systems should fail.

With only one of the dual systems working, more than normal pedal travel and greater pedal pressure are required to stop the vehicle.

Also, the vehicle will not stop in as short a distance with only a portion of the brake system working.

If the brakes fail while you are driving, shift to a lower gear for additional engine braking and stop the vehicle as soon as it is safe to do so.

*** NOTICE**

Parking brake & brake fluid warning light

Driving the vehicle with a warning light ON is dangerous. If the parking brake & brake fluid warning light illuminates with the parking brake released, it indicates that the brake fluid level is low.

In this case, have your vehicle inspected by an authorized Kia dealer.

Anti-lock brake system (ABS) warning light

This warning light illuminates:

- Once you set the ignition switch or ENGINE START/STOP button to the ON position.
 - It illuminates for approximately 3 seconds and then goes off.
- When there is a malfunction with the ABS (The normal braking system will still be operational without the assistance of the anti-lock brake system).

In this case, have the vehicle inspected by an authorized Kia dealer.

Electronic Brake Force Distribution (EBD) system warning light



These two warning lights illuminate at the same time while driving:

- When the ABS and regular brake system are not working, have your vehicle inspected by an authorized Kia dealer.

WARNING

Electronic Brake Force Distribution (EBD) system warning light

When both ABS and parking brake & brake fluid warning lights are on, the brake system will not work normally and you may experience an unex-

pected and dangerous situation during sudden braking.

In this case, avoid high speed driving and abrupt braking.

Have your vehicle inspected by an authorized Kia dealer as soon as possible.

Electronic Parking Brake (EPB) warning light

This warning light illuminates:

- Once you set the ignition switch or ENGINE START/STOP button to the ON position.
 - It illuminates for approximately 3 seconds and then goes off.
- When there is a malfunction with the EPB.

In this case, have the vehicle inspected by an authorized Kia dealer.

*** NOTICE**

Electronic Parking Brake (EPB) warning light

The Electronic Parking Brake (EPB) warning light may illuminate when the Electronic Stability Control (ESC) indicator light comes on to indicate that the ESC is not working properly (This does not indicate malfunction of the EPB).

Electric Power Steering (EPS) warning light

This warning light illuminates:

- Once you set the ignition switch or ENGINE START/STOP Button to the ON position.
 - This indicator light comes on after the ignition switch or ENGINE START/STOP button is in the ON position and then goes out after approximately 3 seconds.
- When there is a malfunction with the EPS.
In this case, have the vehicle inspected by an authorized Kia dealer.

Charging system warning light

This warning light illuminates:

- Once you set the ignition switch or ENGINE START/STOP button to the ON position.
- When there is a malfunction with either the alternator or electrical charging system.

If there is a malfunction with either the alternator or electrical charging system:

1. Drive carefully to the nearest safe location and stop your vehicle.
2. Turn the engine off and check the alternator drive belt for looseness or breakage.

In this case, have the vehicle inspected by an authorized Kia dealer.

Malfunction Indicator Lamp (MIL)



This warning light illuminates:

- When you set the ignition switch or the ENGINE START/STOP button to the ON position.
 - The malfunction indicator light illuminates for about 3 seconds and then goes off.
- Whenever there is a malfunction with either the emission control system or the engine or the vehicle powertrain.
If this occurs, have the vehicle inspected by an authorized Kia dealer.

⚠ CAUTION

Malfunction Indicator Lamp (MIL)

- Driving with the Malfunction Indicator Lamp (MIL) on may cause damage to the emission control systems which could effect drivability and/or fuel economy.
- If the enhanced engine protection system becomes activated due to lack of engine oil, engine power will be limited. If such condition continues repeatedly, the Malfunction Indicator Lamp will illuminate.

⚠ CAUTION

If the oil pressure lowers due to insufficient engine oil, etc., the engine oil pressure warning light turns on and an enhanced engine protection system that limits the engine's power is activated. After that, engine warning light turns on if driving repeatedly and continuously.

⚠ CAUTION

If the Malfunction Indicator Lamp (MIL) illuminates, potential catalytic converter damage is possible which could result in loss of engine power. In this case, have the vehicle inspected by an authorized Kia dealer.

Engine oil pressure warning light**This warning light illuminates:**

- Once you set the ignition switch or ENGINE START/STOP Button to the ON position.
 - It remains on until the engine is started.
- When the engine oil pressure is low.

If the engine oil pressure is low:

- Drive carefully to the nearest safe location and stop your vehicle.

- Turn the engine off and check the engine oil level (For more details, refer to "Engine oil and filter" on page 7-15). If the level is low, add oil as required.
- If the warning light remains on after adding oil or if oil is not available, have the vehicle inspected by an authorized Kia dealer. Continued driving with the warning light on may cause engine failure.

*** NOTICE**

- When engine oil pressure decreases due to insufficient engine oil, etc., the Engine Oil Pressure warning light will illuminate.
- The enhanced engine protection system which limits engine power will be activated. If the engine oil pressure is restored, the Engine Oil Pressure warning light and the enhanced engine protection system will turn off.

Low fuel level warning light **This warning light illuminates:**

When the fuel tank is nearly empty.

If the fuel tank is nearly empty:

Add fuel as soon as possible.

⚠ CAUTION

Low fuel level

Driving with the Low Fuel Level warning light on or with the fuel level below "E" can cause the engine to misfire and damage the catalytic converter.

Master warning light

This indicator light illuminates:

- This warning light informs the driver the following situations
 - LED headlamp malfunction (if equipped)
 - Lamp malfunction
 - High Beam Assist malfunction (if equipped)

To identify the details of the warning look at the LCD display.

If the warning situation is solved, the master warning light will turn off.

Low tire pressure warning light (if equipped)

This warning light illuminates:

- Once you set the ignition switch or ENGINE START/STOP button to the ON position.
 - It illuminates for approximately 3 seconds and then goes off.
- When one or more of your tires are significantly under inflated. (The location of the underinflated

tires are displayed on the LCD display).

- * For more details, refer to "Tire Pressure Monitoring System (TPMS)" on page 6-10.

This warning light remains on after blinking for approximately 60 seconds or repeats blinking on and off at the intervals of approximately 3 seconds:

- When there is a malfunction with the TPMS.
 - In this case, have the vehicle inspected by an authorized Kia dealer.
- * For more details, refer to "Tire Pressure Monitoring System (TPMS)" on page 6-10.

⚠ WARNING

Low tire pressure

- Significantly low tire pressure makes the vehicle unstable and can contribute to loss of vehicle control and increased braking distances.
- Continued driving on low pressure tires will cause the tires to over-heat and fail.

⚠ WARNING

Safe stopping

- The TPMS cannot alert you to severe and sudden tire damage caused by external factors.

- If you notice any vehicle instability, immediately take your foot off the accelerator pedal, apply the brakes gradually with light force, and slowly move to a safe position off the road.

LED headlamp warning light

This warning light illuminates:

- Once you set the ENGINE START/STOP button to the ON position.
 - It illuminates for approximately 3 seconds and then goes off.
- When there is a malfunction with the LED headlamp.

In this case, have the vehicle inspected by an authorized Kia dealer.

This warning light blinks:

- When there is a malfunction with a LED headlamp related part.

In this case, have the vehicle inspected by an authorized Kia dealer.

CAUTION

LED headlamp warning light

Continuous driving with the LED Headlamp Warning Light on or blinking can reduce LED headlamp (low beam) life.

Forward Safety warning light (if equipped)

This indicator light illuminates:

- When there is a malfunction with Forward Collision-Avoidance Assist.

In this case, have the vehicle inspected by an authorized Kia dealer.

Indicator lights

Electronic stability control (ESC) indicator light

This indicator light illuminates:

- Once you set the ignition switch or ENGINE START/STOP Button to the ON position.
 - It illuminates for approximately 3 seconds and then goes off.
- When there is a malfunction with the ESC system.

In this case, have the vehicle inspected by an authorized Kia dealer.

This indicator light blinks:

While the ESC is operating.

* For more details, refer to "Electronic Stability Control (ESC) system" on page 5-35.

Electronic stability control (ESC)**OFF indicator light** **This indicator light illuminates:**

- Once you set the ignition switch or ENGINE START/STOP Button to the ON position.
 - It illuminates for approximately 3 seconds and then goes off.
- When you deactivate the ESC system by pressing the ESC OFF button.

* For more details, refer to "Electronic Stability Control (ESC) system" on page 5-35.

AUTO HOLD indicator light (AUTO HOLD)**This indicator light illuminates:**

- **White** When you activate the auto hold system by pressing the AUTO HOLD button.
- **Green** When you stop the vehicle completely by depressing the brake pedal with the auto hold system activated.
- **Yellow** When there is a malfunction with the auto hold system. In this case, have the vehicle inspected by an authorized Kia dealer.

* For more details, refer to "AUTO HOLD" on page 5-31.

Immobilizer indicator light (without smart key)  (if equipped)**This indicator light illuminates:**

- When the vehicle detects the immobilizer in your key properly while the ignition switch is ON.
 - At this time, you can start the engine.
 - The indicator light goes off after starting the engine.

This indicator light blinks:

- When there is a malfunction with the immobilizer system. In this case, have the vehicle inspected by an authorized Kia dealer.

Immobilizer indicator light (with smart key) **This indicator light illuminates for up to 30 seconds:**

- When the vehicle detects the smart key in the vehicle properly while the ENGINE START/STOP button is ACC or ON.
 - At this time, you can start the engine.
 - The indicator light goes off after starting the engine.

This indicator light blinks for a few seconds:

- When the smart key is not in the vehicle.
 - At this time, you can not start the engine.

This indicator light illuminates for 2 seconds and goes off:

- When the vehicle can not detect the smart key which is in the vehicle while the ENGINE START/STOP Button is ON.

In this case, have the vehicle inspected by an authorized Kia dealer.

This indicator light blinks:

- When the battery of the smart key is weak.
 - At this time, you can not start the engine. However, you can start the engine if you press the ENGINE START/STOP Button with the smart key. (For more details, refer to "Immobilizer system" on page 4-17).
- When there is a malfunction with the immobilizer system. In this case, have the vehicle inspected by an authorized Kia dealer.

Turn signal indicator light **This indicator light blinks:**

- When you turn the turn signal light on.

If any of the following occurs, there may a malfunction with the turn signal system. In this case, have the vehicle inspected by an authorized Kia dealer.

- The indicator light does not blink but illuminates.

- The indicator light blinks more rapidly.
- The indicator light does not illuminate at all.

Low beam indicator light **This indicator light illuminates:**

- When the headlamps are on.

High beam indicator light **This indicator light illuminates:**

- When the headlamps are on and in the high beam position.
- When the turn signal lever is pulled into the Flash-to-Pass position.

High Beam Assist indicator light**This indicator light illuminates:**

- When the high beam is on with the light switch in the AUTO light position.
 - If your vehicle detects oncoming or preceding vehicles, High Beam Assist will switch the high beam to low beam automatically.
- * For more details, refer to "High Beam Assist (HBA)" on page 4-157.

Light ON indicator light **This indicator light illuminates:**

- When the taillamps or headlamps are on.

Front fog indicator light  **(if equipped)****This indicator light illuminates:**

- When the front fog lights are on.

Lane Safety indicator light 

Lane Safety indicator light will illuminate when you turn Lane Keeping Assist on by pressing Lane Safety button.

If there is a problem with the system, the yellow Lane Safety indicator light will illuminate.

- * For more details, refer to "Lane Keeping Assist (LKA)" on page 5-77.

Cruise Control indicator light** CRUISE (if equipped)****This indicator light illuminates:**

- When the cruise control system is enabled.

- * For more details, refer to "Cruise Control (CC) (if equipped)" on page 5-123.

SPORT Mode indicator light**This indicator light illuminates :**

- When you select "SPORT" mode as drive mode.

For more details, refer to "Drive mode integrated control system" on page 5-44.

ECO Mode indicator light **This indicator light illuminates:**

- When you select "ECO" mode as drive mode.

For more details, refer to "Drive mode integrated control system" on page 5-44.

Rear View Monitor (RVM) (if equipped)

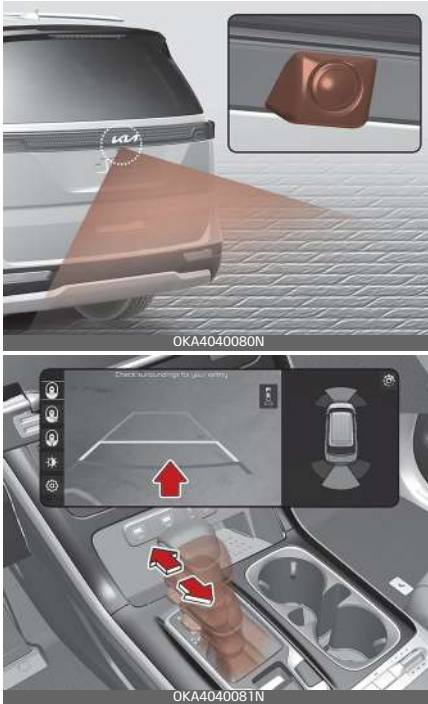

Rear View Monitor is a parking safe function that shows the area behind the vehicle with the monitor inside the car to assist you for easy and safe parking or backing up.

Detecting sensor

Rear view camera



Refer to the picture above for the detailed location of the detecting sensor.

Function settings

Camera settings



- You can change Rear View Monitor 'Display Contents' or 'Display Settings' by touching the setup icon (⚙️) on the screen while Rear View Monitor is operating, or selecting 'Driver Assistance → Parking Safety → Camera Set-

4

tings' from the Settings menu while the engine is on.

- In the Display Contents, you can change settings for 'Rear View Parking Guidance', and in the Display Settings, you can change the screen's 'Brightness' and 'Contrast'.
- Deselect 'Camera Settings → Keep Rear Camera' from the Settings menu of the Infotainment system to turn off the function.
- If you maintain the setting, the function will turn on.

Function operation

Operating button

Parking/View button

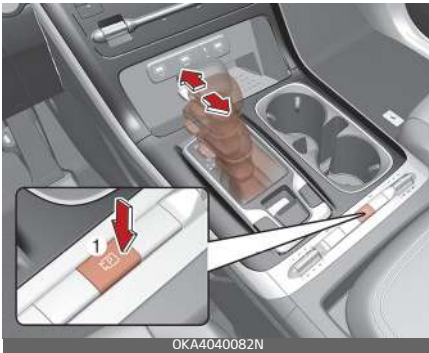

Press the Parking/View button (1) to turn on Rear View Monitor.

Press the button again to turn off the function.

Rear view

Operating conditions

- Shift the gear to R (Reverse), the image will appear on the screen.
- Press the Parking/View button (1) while the gear is in P (Park), the image will appear on the screen.

Off conditions

- The rear view cannot be turned off when the gear is in R (Reverse).
- Press the Parking/View button (1) again while the gear is in P (Park) with the rear view on the screen, the rear view will turn off.
- Shift the gear from R (Reverse) to P (Park), the rear view will turn off.

Extended rear view function

The rear view will maintain showing on the screen to help you when parking.

Operating conditions

Shift the gear from R (Reverse) to N (Neutral) or D (Drive), the rear view will appear on the screen.

Off conditions

- When vehicle speed is above 10 km/h (6 mph), the rear view will turn off.

- Shift the gear to P (Park), the rear view will turn off.
- If the view is being displayed in P (Park), press Parking/View button (1) to turn the view off.

Rear top view



When you touch the icon (1), the top view is displayed on the screen and shows the distance from the vehicle in the back of your vehicle while parking.

Malfunction and limitations

Malfunction

When Rear View Monitor is not working properly, or the screen flickers, or the camera image does not display normally, have the function be inspected by an authorized Kia dealer.

Limitations

When the vehicle is stopped for a long time in winter or when the vehicle is parked in an indoor parking lot, the exhaust fumes may temporarily blur the image.

⚠ WARNING

- The rear view camera does not cover the complete area behind the vehicle. The driver should always check the rear area directly through the inside and outside rearview mirror before parking or backing up.
- The camera used for the rear monitor is a wide-angle lens. Since the distorted image is corrected and used, there may be a difference with the distance of the actual object.
- If the camera lens is covered with foreign material, Rear View Monitor may not operate normally. Always keep the camera lens clean. However, do not use chemical solvents such as strong detergents containing high alkaline or volatile organic solvents (gasoline, acetone etc.). This may damage the camera lens.

Surround View Monitor (SVM) (if equipped)

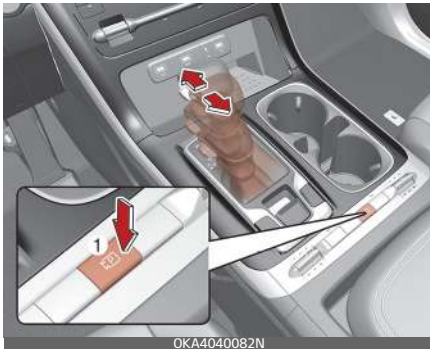

Surround View Monitor will assist in parking using the cameras installed on the vehicle and displays images around the vehicle through the infotainment system screen.

- Parking Assist View function helps the driver to see the surroundings of the vehicle in a parking situation in various view modes.

Detecting sensor

(1) SVM-front view camera, (2, 3) SVM-side view camera (under the outside rearview mirror)



(4) SVM-rear view camera



Refer to the picture above for the detailed location of the detecting sensors.

Function settings

Camera settings



- You can change Surround View Monitor 'Display Contents' or 'Display Settings' by touching the setup icon (⚙️) on the screen while Surround View Monitor is operating, or selecting 'Driver Assistance → Parking Safety → Camera Settings' from the Settings menu while the engine is on.
- In the Display Contents, you can change settings for 'Top View Parking Guidance', 'Rear View Parking Guidance' and 'Parking Distance Warning'.
- In the Display Settings, you can change the screen's 'Brightness' and 'Contrast'.

Top View Parking Guidance

Front top view



Rear top view



- When the 'Top View Parking Guidance' is selected, parking guidance is displayed on the right side of the Surround View Monitor screen.
- You may see the front top view or the rear top view when using front top view and Top View Parking Guidance.

Rear View Parking Guidance



- When the 'Rear View Parking Guidance' is selected, parking guidance is displayed in the rear view.
- The horizontal guideline of the Rear View Parking Guidance shows the distance of 0.5 m (1.6 ft.), 1 m (3.3 ft.) and 2.3 m (7.6 ft.) from the vehicle.

Parking Distance Warning



- When the 'Parking Distance Warning' is selected, parking distance warning is displayed on the right

side of the Surround View Monitor screen.

- The image will be displayed only when Parking Distance Warning is warning the driver.

Surround View Monitor Auto On

With the engine on, select 'Driver Assistance → Parking Safety → Surround View Monitor Auto On' from the cluster or infotainment system Settings menu to use the function.

To use this function, refer to "Function operation" on page 4-140.

Function operation

Operating button

Parking/View button

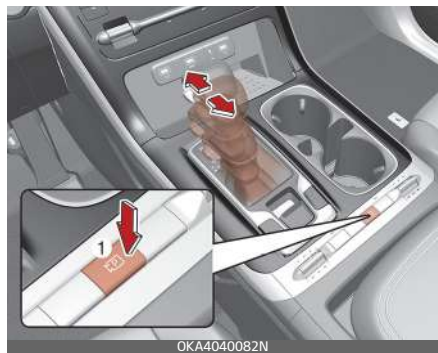



- Press the Parking/View button (1) to turn on Surround View Monitor. Press the button again to turn off the function.
 - Other view modes can be selected by touching the view icons (2) on the Surround View Monitor screen.
 - When one of the infotainment system button (3) is pressed without the gear in R (Reverse), Surround View Monitor will turn off.
- (Reverse) to N (Neutral) or D (Drive).
- Front view function will operate when the following conditions are satisfied:
 - While the infotainment system screen is being displayed, press the Parking/View button (1) briefly when the gear is in D (Drive) or N (Neutral) and vehicle speed is below 10 km/h (6 mph).
 - Surround View Monitor Auto On function will operate when the following conditions are satisfied:
 - If 'Driver Assistance → Parking Safety → Surround View Monitor Auto On' is selected in the Settings menu and Parking Distance Warning warns the driver when the gear is in P (Parking), the front view screen is displayed.

Front view

The front image is displayed on the screen when the gear is in N (Neutral) or D (Drive) to assist in parking. The front view has a top view/front view/side view.

Operating conditions

- The front view will change to the view mode that was last used when the gear is changed from R

Off conditions

- Press the Parking/View button (1) again, the image will turn off.
- When vehicle speed is above 10 km/h (6 mph) with the gear in D (Drive), Surround View Monitor will turn off and the screen will change back to the previous infotainment system screen. Although you drive below 10 km/h (6 mph) again, Surround View Monitor will not turn on.

- Press one of the infotainment system button (3), the screen will change to the infotainment system screen.
- Shift the gear to P (Park), the image will turn off.

Rear view

The rear image is displayed on the screen when the gear is in R (Reverse) or P (Park) to assist in parking. The rear view has a top view/rear view/side view.

Operating conditions

- Shift the gear to R (Reverse), the image will appear on the screen.
- Press the Parking/View button (1) while the gear is in P (Park), the image will appear on the screen.

Off conditions

- The image cannot be turned off when the gear is in R (Reverse).
- Shift the gear from R (Reverse) to P (Park), the image will turn off.
- Press the Parking/View button (1) again while the gear is in P (Park) with the image on the screen.

Malfunction and limitations

Malfunction

When Surround View Monitor is not working properly, or the screen flickers, or the camera image does not display normally, have the function be inspected by an authorized Kia dealer.

Limitations

When the vehicle is stopped for a long time in winter or when the vehicle is parked in an indoor parking lot, the exhaust fumes may temporarily blur the image.

- The screen may be displayed abnormally, and an icon will appear at the top left side of the screen under the following circumstances:
 - The liftgate is opened
 - The driver or front passenger door is opened
 - The outside rearview mirror is folded

⚠ WARNING

- ALWAYS look around your vehicle to make sure there are no objects or obstacles before moving the vehicle. What you see on the screen may differ from the actual vehicle's location.
- The camera used for the rear monitor is a wide-angle lens.

Since the distorted image is corrected and used, there may be a difference with the distance of the actual object.

- Surround View Monitor is designed to be used on a flat surface. Therefore, if used on roads with different heights such as curbs and speed bumps, the image in the screen may not look correct.
- If the camera lens is covered with foreign material, Surround View Monitor may not operate normally.

Always keep the camera lens clean. However, do not use chemical solvents such as strong detergents containing high alkaline or volatile organic solvents (gasoline, acetone etc.). This may damage the camera lens.

* NOTICE

- If the rear view is on while driving, the function is maintained regardless of the vehicle speed.
- If you reverse when the rear view is on while driving, it will change to the rear view screen.

Reverse Parking Distance Warning (PDW) (if equipped)

Reverse Parking Distance Warning is a parking safe function that will warn the driver by detecting the distance between an obstacle or people, animal(s) within a certain distance with front/rear ultrasonic sensors when the vehicle is moving forward or backward.

Detecting sensor

Rear ultrasonic sensors



Refer to the picture above for the detailed location of the detecting sensors.

Function settings

Warning volume

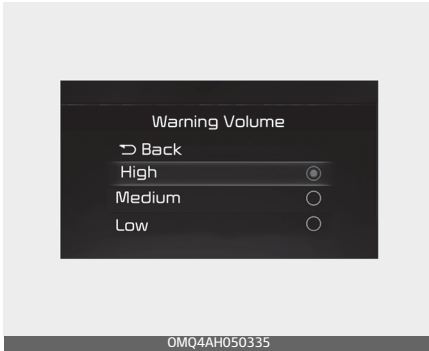

Select 'Driver Assistance → Warning Volume' from the cluster or infotainment system Settings menu to change the Warning Volume to 'High', 'Medium', or 'Low' for Reverse Parking Distance Warning.

Function operation

Operating button

Parking Distance Warning Off button



- Press the Parking Distance Warning Off (P_{OFF}) button to turn off Reverse Parking Distance Warning. Press the button again to turn on the function.
- When Reverse Parking Distance Warning is off (button indicator light on), if you shift the gear to R (Reverse), the function will automatically turn on.
- Warning function activates when the gear is R (Reverse) position for safe parking.

Reverse Parking Distance Warning

- Reverse Parking Distance Warning will operate when the gear is in R (Reverse).
- Reverse Parking Distance Warning detects a person, animal or object in the rear when the vehicle's rearward speed is below 10 km/h (6 mph).

Distance from object	Warning indicator	Warning sound
	Driving backward	
60 ~ 120 cm (24 ~ 48 in.)		Buzzer beeps intermittently
30 ~ 60 cm (12 ~ 24 in.)		Beeps more frequently
Within 30 cm (12 in.)		Beeps continuously

- The corresponding indicator will illuminate whenever each ultrasonic sensor detects a person, animal or object in its sensing range. Also an audible warning will sound.
- When more than two objects are detected at the same time, the closest one will be warned with an audible warning.
- The shape of the indicator in the illustration may differ from the actual vehicle.

Malfunction and limitations

Malfunction

After starting the engine, a beep will sound when the gear is shifted to R (Reverse) to indicate the function is operating normally.

However, if one or more of the following occurs, first check whether the ultrasonic sensor is damaged or blocked with foreign material. If it still does not work properly, have the function be inspected by an authorized Kia dealer.

- The audible warning does not sound.
- The buzzer sounds intermittently.
- The 'Parking sensor error or blockage' warning message on the cluster



⚠ WARNING

- Even vehicles equipped with Parking Distance Warning, drive carefully and always look around your vehicle to make sure there are no objects or obstacles behind. The operation of the function can be affected by environmental conditions. It is the responsibility of the driver to always check the rear view before and while parking.
- Your new vehicle warranty does not cover any accidents or damage to the vehicle due to the malfunction of Reverse Parking Distance Warning.
- Pay close attention when driving near objects, pedestrians, and especially children. Some objects may not be detected by the ultrasonic sensors, due to the objects distance, size or material, all of which can limit the effectiveness of the sensor.

Limitations

- Reverse Parking Distance Warning may not operate normally when:
 - Moisture is frozen to the sensor
 - Sensor is covered with foreign material, such as snow or water (The function will operate normally when such foreign material are removed.)
 - The weather is extremely hot or cold
 - The sensor or sensor assembly is disassembled
 - The surface of the sensor is pressed hard or an impact is applied with a hard object
 - The surface of the sensor is scratched with a sharp object
 - The sensors or its surrounding area is directly sprayed with high pressure washer
- Reverse Parking Distance Warning may malfunction when:
 - Heavy rain or water spray is present
 - Water flows on the surface of the sensor
 - Affected by another vehicle's sensors
 - The sensor is covered with snow
 - Driving on uneven road, gravel roads or bushes
 - Objects that generates ultrasonic waves are near the sensor
 - Installing the license plate differently from the original location
- The vehicle bumper height or ultrasonic sensor installation has been modified
- Attaching equipments or accessories around the ultrasonic sensors
- The following objects may not be detected:
 - Narrow objects, such as corners of square pillar.
 - Objects, which tend to absorb sensor frequency, such as clothes, spongy material or snow.
 - Objects smaller than 40 in. (100 cm) in length and narrower than 6 in. (14 cm) in diameter.
 - Pedestrians, animals or objects that are very close to the ultrasonic sensors
- Parking Distance Warning Indicators may be displayed differently from the actual detected location when the obstacle is located between the sensors.
- Parking Distance Warning may not occur sequentially depending on vehicle speed or obstacle shape.
- If Reverse Parking Distance Warning needs repair, have the function be inspected by an authorized Kia dealer.

Forward/Reverse Parking Distance Warning (PDW) (if equipped)

Forward/Reverse Parking Distance Warning will help warn the driver if an obstacle is detected within a certain distance when the vehicle is moving forward or in reverse at low speeds.

Detecting sensor

Front ultrasonic sensors



Rear ultrasonic sensors



Refer to the picture above for the detailed location of the detecting sensor.

Function settings

Warning volume

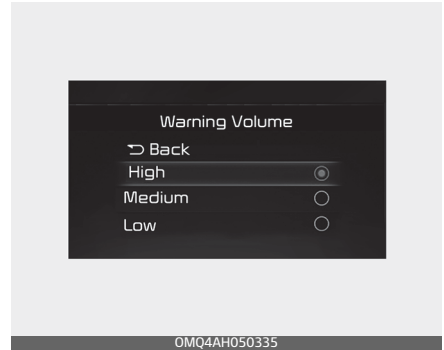

4

Select 'Driver Assistance → Warning Volume' from the cluster or infotainment system Settings menu to change the Warning Volume to 'High', 'Medium', or 'Low' for Forward/Reverse Parking Distance Warning.

Parking Distance Warning Auto On

Forward Parking Distance Warning can use 'Auto ON' function. To use Parking Distance Warning Auto On function, select 'Driver Assistance → Parking Safety → Parking Distance Warning Auto On' from the cluster or infotainment system Settings menu.

Function operation

Operating button

Parking Safety button

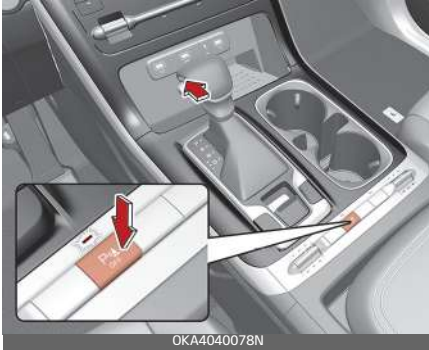



- Press the Parking Safety (P_{OFF}) button to turn on Forward/Reverse Parking Distance Warning. Press the button again to turn off the function.
- When Forward/Reverse Parking Distance Warning is off (button indicator light off), if you shift the gear to R (Reverse), the function will automatically turn on.
- When Forward/Reverse Parking Distance Warning turns on, the button indicator light will turn on. If vehicle speed is above 20 km/h (12 mph), Forward/Reverse Parking Distance Warning will turn off (button indicator light off).
- Warning function activates when the gear is R (Reverse) position for safe parking.

Forward Parking Distance Warning

- Forward Parking Distance Warning works in 3 ways following:
 - The gear is shifted from R (Reverse) to D (Drive) with Reverse Parking Distance Warning on
 - The gear is in D (Drive) and the Parking Safety button indicator light is on
 - 'Parking Distance Warning Auto On' is selected from the Settings menu and the gear is in D (Drive)
- Forward Parking Distance Warning detects a person, animal or object in front when the vehicle's forward speed is below 10 km/h (6 mph).
- Forward Parking Distance Warning does not operate when the vehicle's forward speed is above 10 km/h (6 mph) even when the Parking Safety button indicator is on. Forward Parking Distance Warning will operate again when the vehicle's forward speed decreases below 10 km/h (6 mph) while the Parking Safety button indicator is on.
- When 'Parking Distance Warning Auto On' is selected, the Parking Safety button indicator light stays on.
- When 'Parking Distance Warning Auto On' is deselected, and the vehicle's forward speed is above 20 km/h (12 mph), the Parking

Safety button indicator will turn off. Although you drive below 10 km/h (6 mph), the function will not turn on.

Distance from object	Warning indicator	Warning sound
	Driving forward	
60 ~ 120 cm (24 ~ 48 in.)		Buzzer beeps intermittently
30 ~ 60 cm (12 ~ 24 in.)		Beeps more frequently
Within 30 cm (12 in.)		Beeps continuously



- The corresponding indicator will illuminate whenever each ultrasonic sensor detects a person, animal or object in its sensing range. Also an audible warning will sound.
- When more than two objects are detected at the same time, the closest one will be warned with an audible warning.
- The shape of the indicator in the illustration may differ from the actual vehicle.

Reverse Parking Distance Warning

- Reverse Parking Distance Warning will operate when the gear is in R (Reverse).
- Reverse Parking Distance Warning detects a person, animal or object in the rear when the vehicle's

rearward speed is below 10 km/h (6 mph).

- When the vehicle's rearward speed is below 10 km/h (6 mph), both the front and rear ultrasonic sensors will detect objects. However, the front ultrasonic sensors can detect a person, animal or object when it is within 60 cm (24 in.) from the sensors.

Distance from object	Warning indicator	Warning sound
	Driving backward	
60 ~ 120 cm (24 ~ 48 in.)		Buzzer beeps intermittently
30 ~ 60 cm (12 ~ 24 in.)		Beeps more frequently
Within 30 cm (12 in.)		Beeps continuously

- The corresponding indicator will illuminate whenever each ultrasonic sensor detects a person, animal or object in its sensing range. Also an audible warning will sound.
- When more than two objects are detected at the same time, the closest one will be warned with an audible warning.
- The shape of the indicator in the illustration may differ from the actual vehicle.

Malfunction and limitations

Malfunction

After starting the engine, a beep will sound when the gear is shifted to R (Reverse) to indicate the function is operating normally.

However, if one or more of the following occurs, first check whether the ultrasonic sensor is damaged or blocked with foreign material. If it still does not work properly, have the function be inspected by an authorized Kia dealer.

- The audible warning does not sound.
- The buzzer sounds intermittently.
- The 'Parking sensor error or blockage' warning message on the cluster.



⚠ WARNING

- Even vehicles equipped with Parking Distance Warning, drive carefully and always look around your vehicle to make sure there are no

objects or obstacles behind. The operation of the function can be affected by environmental conditions. It is the responsibility of the driver to always check the front and rear views before and while parking.

- Your new vehicle warranty does not cover any accidents or damage to the vehicle due to the malfunction of Forward/Reverse Parking Distance Warning.
- Pay close attention when driving near objects, pedestrians, and especially children. Some objects may not be detected by the ultrasonic sensors, due to the objects distance, size or material, all of which can limit the effectiveness of the sensor.

Limitations

- Forward/Reverse Parking Distance Warning may not operate normally when:
 - Moisture is frozen to the sensor
 - Sensor is covered with foreign material, such as snow or water (The function will operate normally when such foreign material are removed.)
 - The weather is extremely hot or cold
 - The sensor or sensor assembly is disassembled

Features of your vehicle

- The surface of the sensor is pressed hard or an impact is applied with a hard object
- The surface of the sensor is scratched with a sharp object
- The sensors or its surrounding area is directly sprayed with high pressure washer
- Forward/Reverse Parking Distance Warning may malfunction when:
 - Heavy rain or water spray is present
 - Water flows on the surface of the sensor
 - Affected by another vehicle's sensors
 - The sensor is covered with snow
 - Driving on uneven road, gravel roads or bushes
 - Objects that generates ultrasonic waves are near the sensor
 - Installing the license plate differently from the original location
 - The vehicle bumper height or ultrasonic sensor installation has been modified
 - Attaching equipments or accessories around the ultrasonic sensors
- The following objects may not be detected:
 - Narrow objects, such as corners of square pillar.
 - Objects, which tend to absorb sensor frequency, such as

Forward/Reverse Parking Distance Warning (PDW)

- clothes, spongy material or snow.
- Objects smaller than 100 cm (40 in.) in length and narrower than 14 cm (6 in.) in diameter.
- Pedestrians, animals or objects that are very close to the ultrasonic sensors
- Parking Distance Warning Indicators may be displayed differently from the actual detected location when the obstacle is located between the sensors.
- Parking Distance Warning may not occur sequentially depending on vehicle speed or obstacle shape.
- If Forward/Reverse Parking Distance Warning needs repair, have the function be inspected by an authorized Kia dealer.

Lighting

This vehicle is equipped with a variety of lights to illuminate the interior and exterior of the vehicle.

CAUTION

To prevent the battery from being discharged, do not leave the headlamp and interior light on for a prolonged time while the engine is not running.

Battery saver function

The purpose of this feature is to prevent the battery from being discharged if the lights are left in the ON position. The system automatically shuts off the parking lights after the engine is off and the driver's door is opened.

However, the position lamps stay ON even when the driver-side door is opened if the light switch is operated after the engine is turned off.

If necessary, to keep the lamps on turn the position lamps OFF and ON again using the headlamp switch on the steering column after the engine is turned off.

Headlamp delay function

If you place the ignition switch or ENGINE START/STOP button in the ACC or OFF position with the headlamps ON, the headlamps (and/or parking lights) remain on for about 5

minutes. However, with the engine off if the driver's door is opened and closed, the headlamps (and/or parking lights) are turned off after 15 seconds.

The headlamps (and/or parking lights) can be turned off by pressing the lock button on the remote key or smart key twice or turning the light switch to the OFF or AUTO position. However, if you turn the light switch to the AUTO position when it is dark outside, the headlamps will not be turned off.

You can activate or deactivate the Headlamp Delay function from the User Settings Mode in the LCD display. For more details, refer to "User settings mode" on page 4-110. If your vehicle is equipped with additional navigation, please refer to the infotainment system manual separately supplied.

*** NOTICE**

If the driver exits the vehicle through another door besides the driver door, the battery saver function does not operate and the headlamp delay function does not turn OFF automatically.

This may cause the battery to discharge. To avoid battery discharge, turn OFF the headlamps manually from the headlamp switch before exiting the vehicle.

Daytime Running Light (DRL)

The Daytime Running Light (DRL) can make it easier for others to see the front of your vehicle during the day.

The DRL can be helpful in many different driving conditions, and it is especially helpful after dawn and before sunset.

The DRL will turn the dedicated lamp OFF when:

- The headlamps are on.
- The vehicle is off.
- The front fog light is on. (if equipped)
- Engaging the parking brake.

Lighting control

The light switch has a headlamp and a position lamp position.

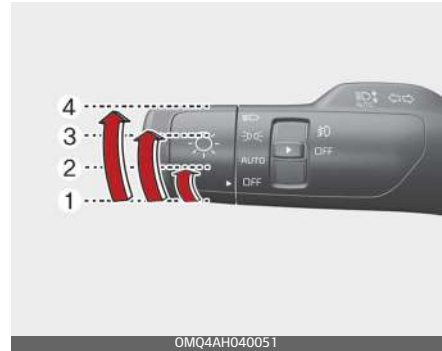

To operate the lights, turn the knob at the end of the control lever to one of the following positions:

1. OFF position
2. Auto light position
3. Position & Taillamp
4. Headlamp position

Auto head lamp (OFF position)



The lights turn on or off depending on the amount of daylight detected from the sensor when the parking

brake is not activated or vehicle speed is above 5 km/h (3 mph).

Activating the parking brake when the vehicle speed is less than 5 km/h (3 mph) turns the headlamps off automatically by the amount of daylight detected from the sensor.

AUTO headlamp position



The parking lamp and headlamp will be turned ON or OFF automatically depending on the amount of daylight as measured by the ambient light sensor on the center dashboard.

*** NOTICE**

Even with the AUTO headlamp feature in operation, it is recommended to manually turn ON the headlamps when driving at night or in a fog, driving in the rain, or when you enter dark areas, such as tunnels and parking facilities.

- Do not cover or spill anything on the sensor located in front of the instrument panel.
- Do not clean the sensor using a window cleaner, the cleanser may leave a light film which could interfere with sensor operation.
- If your vehicle has window tint or other types of metallic coating on the front windshield, the AUTO headlamp system may not work properly.

Position & Taillamp



When the light switch is in the position lamp position, the front position lamp, taillamp, and the license plate lamp will turn ON.

Headlamp (Low Beam)



When the light switch is in the headlamp position, headlamp (low beam), tail, license light will turn ON.

* NOTICE

The ignition switch or ENGINE START/STOP button must be in the ON position to turn on the headlamps.

Auto light (if equipped)

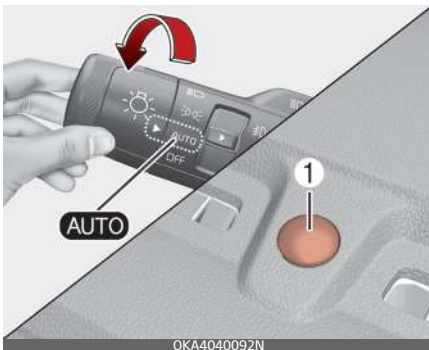

When the light switch is in the AUTO light position, the taillamps and headlamps will turn ON or OFF auto-

matically depending on the amount of light outside the vehicle.

⚠ CAUTION

- Never place anything over the sensor (1) located on the instrument panel as this will ensure better auto-light system control.
- Don't clean the sensor using a window cleaner, the cleaner may leave a light film which could interfere with sensor operation.
- If your vehicle has window tint or other types of metallic coating on the front windshield, the Auto light system may not work properly.

Operating high beam



To turn on the high beam headlamp:

- Push the lever away from you. The lever will return to its original position. The high beam indicator will light when the headlamp high beams are switched on.

⚠ WARNING

High beams

Do not use high beam when there are other vehicles in front of or approaching your vehicle. Using high beam could obstruct the other driver's vision.

To flash the headlamps:

- Pull the lever towards you.

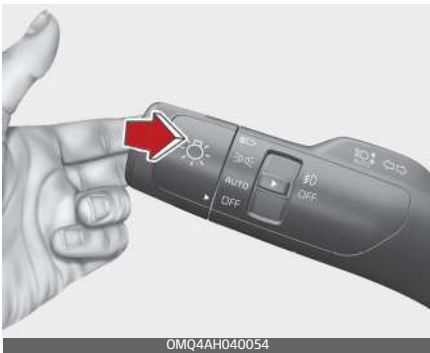

It will return to the normal (low beam) position when released. The headlamp switch does not need to be on to use this flashing feature.

Operating turn signals and lane change signals

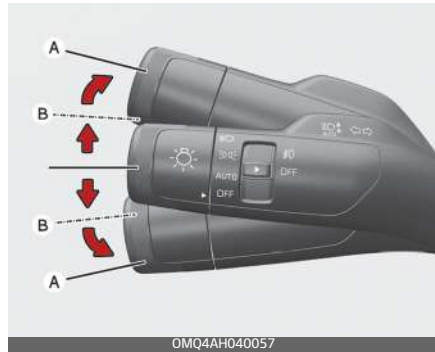

The ENGINE START/STOP button must be on for the turn signals to function.

To turn on the turn signals:

- Move the lever up or down (A).
The green arrow indicators on the instrument panel indicate which turn signal is operating. They will self-cancel after a turn is completed. If the indicator continues to flash after a turn, manually return the lever to the OFF position.

To signal a lane change:

- Move the turn signal lever slightly and hold it in position (B).
The lever will return to the OFF position when released.

If an indicator stays on and does not flash or if it flashes abnormally, one of the turn signal bulbs may be burned out and will require replacement.

One-touch lane change function

To activate a one-touch lane change function, move the turn signal lever slightly and then release it. The lane change signals will blink 3, 5 or 7 times.

You can activate or deactivate the One Touch Turn Signal function or choose the number of blinking (3, 5, or 7) by selecting "User Settings → Lights → One Touch Turn Signal".

* NOTICE

If an indicator flash is abnormally quick or slow, a bulb may be burned out or have a poor electrical connection in the circuit. The bulb may require replacement.

Operating front fog light \neq (if equipped)

Fog lights are designed to provide improved visibility when visibility is poor due to fog, rain or snow, etc.



The fog lights will turn on when the fog light switch (1) is turned to the on position after the headlamp is turned on.

To turn off the fog lights:

- Turn the fog light switch (1) to the ON position.

⚠ CAUTION

When in operation, the fog lights consume large amounts of vehicle electrical power. Only use the fog lights when visibility is poor.

4

High Beam Assist (HBA)



High Beam Assist will automatically adjust the headlamp range (switches between high beam and low beam) depending on the brightness of detected vehicles and certain road conditions.

Detecting sensor

Front view camera



The front view camera is used as a detecting sensor to detect ambient light and brightness while driving.

Refer to the picture above for the detailed location of the detecting sensor.

* NOTICE

- Always keep the front view camera in good condition to maintain optimal performance of High Beam Assist.
- For more details on the precautions of the front view camera, refer to "Forward Collision-Avoidance Assist (FCA) (Sensor fusion) (if equipped)" on page 5-61.

Function settings

With the engine on, select 'Lights → High Beam Assist (or HBA (High Beam Assist))' from the Settings menu to turn on High Beam Assist and deselect to turn off the function.

⚠ WARNING

For your safety, change the Settings after parking the vehicle at a safe location.

Function operation

Display and control

- After selecting 'High Beam Assist' in the Settings menu, High Beam Assist will operate by following the procedure below.
 - Place the headlamp switch in the AUTO position and push the headlamp lever towards the instrument cluster. The High Beam Assist (HBA) indicator light will illuminate on the cluster and the function will be enabled.
 - When the function is enabled, high beam will turn on when vehicle speed is above 40 km/h (25 mph). When vehicle speed is below 25 km/h (15 mph), high beam will not turn on.

- The High Beam (AUTO) indicator light will illuminate on the cluster when high beam is on.
- When High Beam Assist is operating, if the headlamp lever or switch is used, the function operates as follow:
 - If the headlamp lever is pulled towards you when the high beam is off, the high beam will turn on without High Beam Assist canceled. When you let go of the headlamp lever, the lever will move to the middle and the high beam will turn off.
 - If the headlamp lever is pulled towards you when the high beam is on by High Beam Assist, low beam will be on and the function will turn off.
 - If the headlamp switch is placed from AUTO to another position (headlamp/position/off), High Beam Assist will turn off and the corresponding lamp will turn on.
- When High Beam Assist is operating, high beam switches to low beam if any of the following conditions occur:
 - When the headlamp of an oncoming vehicle is detected.
 - When the tail lamp of a vehicle in front is detected.
 - When the headlamp or tail lamp of a motorcycle or a bicycle is detected.
- When the surrounding ambient light is bright enough that high beams are not required.
- When streetlights or other lights are detected.

Malfunction and limitations

Malfunction

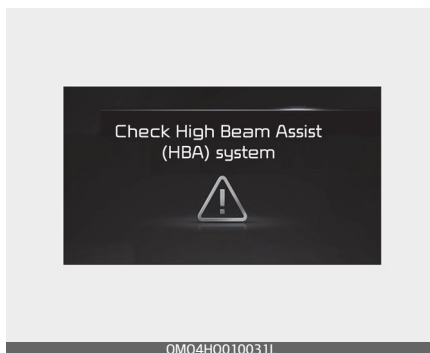

When High Beam Assist is not working properly, the 'Check High Beam Assist (HBA) system' or 'Check HBA (High Beam Assist system)' warning message will appear and warning light (⚠) will illuminate on the cluster. Have the function be inspected by an authorized Kia dealer.

Limitations

High Beam Assist may not work properly in the following situations:

- Light from a vehicle is not detected because of lamp damage, or because it is hidden from sight, etc.

- Headlamp of a vehicle is covered with dust, snow or water.
- A vehicle's headlamps are off but the fog lamps are on and etc.
- There is a lamp that has a similar shape as a vehicle's lamp.
- Headlamps have been damaged or not repaired properly.
- Headlamps are not aimed properly.
- Driving on a narrow curved road, rough road, uphill or downhill.
- Vehicle in front is partially visible on a crossroad or curved road.
- There is a traffic light, reflecting sign, flashing sign or mirror ahead.
- There is a temporary reflector or flashahead (construction area).
- The road conditions are bad such as being wet, iced or covered with snow.
- A vehicle suddenly appears from a curve.
- The vehicle is tilted from a flat tire or is being towed.
- Light from a vehicle is not detected because of exhaust fume, smoke, fog, snow, etc.

For more details on the limitations of the front view camera, refer to "Forward Collision-Avoidance Assist (FCA) (Sensor fusion) (if equipped)" on page 5-61.

WARNING

- At times, High Beam Assist may not work properly. It is the responsibility of the driver for safe driving practices and always check the road conditions for your safety.
- When High Beam Assist does not operate normally, change the headlamp position manually between high beam and low beam.

Wipers and washers

The wipers and washers remove foreign substances from the windshield and rear window, helping to maintain visibility.

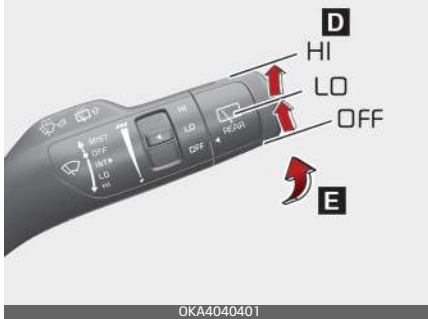
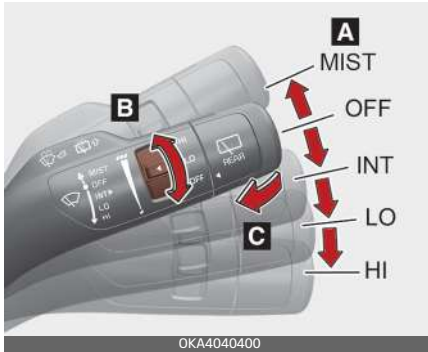

A: Wiper speed control

- MIST – Single wipe
- OFF – Off
- INT – Intermittent wipe
- LO – Low wiper speed
- HI – High wiper speed

B: Intermittent control wipe time adjustment

C: Wash with brief wipes (Pull lever towards you)

D: Rear wiper/washer control

- HI – Continuous wipe
- LO – Intermittent wipe
- OFF – Off

E: Wash with brief wipes (Rear/Push lever away from you)

Windshield wipers

Operate as follows when the ignition switch or ENGINE START/STOP button is ON.

- MIST: For a single wiping cycle, move the lever to this position and release it. The wipers will operate continuously if the lever is held in this position.
- OFF: Wiper is not in operation
- INT: Wiper operates intermittently at the same wiping intervals. Use this mode in light rain or mist. To vary the speed setting, turn the speed control knob.
- LO: Normal wiper speed
- HI: Fast wiper speed

* NOTICE

If there is heavy accumulation of snow or ice on the windshield, defrost the windshield for about 10 minutes, or until the snow and/or ice is removed before using the windshield wipers to ensure proper operation. If you do not remove the snow and/or ice before using the wiper and washer, it may damage the wiper and washer system.

⚠ WARNING

Do not use the washer in freezing temperatures without first warming the windshield with the defrosters; the washer solution could freeze on the windshield and obscure your vision.

Operating windshield washers

1. Move the wiper speed control switch to the OFF position.
2. Pull the lever gently toward you to spray washer fluid on the windshield and to run the wipers 1 ~ 3 cycles. Use this function when the windshield is dirty. The spray and wiper operation will continue until you release the lever.

If the washer does not work, check the washer fluid level. If the fluid level is not sufficient, you will need to add appropriate non-abrasive windshield washer fluid to the washer reservoir.

The reservoir filler neck is located in the front of the engine compartment on the passenger side.

⚠ CAUTION

To prevent possible damage to the washer pump, do not operate the washer when the fluid reservoir is empty.

⚠ WARNING

Do not use the washer in freezing temperatures without first warming the windshield with the defrosters; the washer solution could freeze on the windshield and obscure your vision.

⚠ CAUTION

- To prevent possible damage to the wipers or windshield, do not operate the wipers when the windshield is dry.
- To prevent damage to the wiper blades, do not use gasoline, kerosene, paint thinner, or other solvents on or near them.
- To prevent damage to the wiper arms and other components, do not attempt to move the wipers manually.
- To prevent possible damage to the wipers and washer system, use anti-freezing washer fluids in

the winter season or cold weather.

Operating rear window wiper and washer switch

The rear window wiper and washer switch is located at the end of the wiper and washer switch lever.

- Turn the switch to the desired position to operate the rear wiper and washer.



- HI - Normal wiper operation
- LO - Intermittent wiper operation
- OFF - Wiper is not in operation
- Push the lever away from you to spray rear washer fluid and to run the rear wipers several times.



The spray and wiper operation will continue until you release the lever.

When the front wiper is activated and the gear is switched to R (Reverse) position, the rear wiper will be activated once to provide better visibility.

Heated washer nozzle (if equipped)

The heated washer nozzle function defreeze the washer nozzles in freezing weather.

The heated washer nozzle will turn on and off automatically when the ignition switch or ENGINE START/STOP button is in ON position or when the engine is running in following conditions:

- Turns ON when the outside temperature is below 5 °C, and OFF when it is over 10 °C.
- The washer fluid defreezing speed may be slower when the ignition switch or ENGINE START/STOP button is in ON position, than compared to when the engine is running.
- When the ignition switch or ENGINE START/STOP button is in ON position, after approximately 20 minutes of operation, the system will turn off automatically to prevent possible battery discharge.

- After the engine is running, the washer fluid will defrost approximately after 5 ~ 10 minutes.
- If the engine has been started within the operating temperature, the heated nozzle remains ON even approximately after 20 minutes.

* NOTICE

The heated washer nozzle may not function properly under following conditions:

- The washer fluid in the washer reservoir is frozen.
- Outside temperature sensor is malfunctioning.

Welcome system (if equipped)

The welcome system is a function that illuminates the surroundings or the interior when the driver approaches or exits the vehicle.

Door handle lamp (if equipped)



When all the doors (and liftgate) are closed and locked, the door handle lamp will come on for about 15 seconds if any of the below is performed.

- When the door unlock button is pressed on the smart key.
- When the button of the outside door handle is pressed.
- When the vehicle is approached with the smart key in possession.

Headlamp (headlamp) escort function

The headlamps (and/or taillamps) remain on for approximately 5 minutes after the ignition key is removed or turned to the ACC or LOCK position. However, if the

driver's door is opened and closed, the headlamps are turned off after 15 seconds.

The headlamps can be turned off by pressing the lock button on the transmitter or smart key twice or turning off the light switch from the headlamp or Auto light position.

Interior light

When the interior light switch is in the DOOR position and all doors (and liftgate) are locked and closed, the room lamp will come on for 30 seconds if any of the following occurs:

- With the smart key system
 - When the door unlock button is pressed on the smart key.
 - When the button of the outside door handle is pressed.

At this time, if you press the door lock button, the lamps will turn off immediately.

Interior lights

This vehicle is equipped with lights throughout the vehicle to illuminate the interior.

CAUTION

Do not use the interior lights for extended periods when the engine is not running.

It may cause battery discharge.

WARNING

Do not use the interior lights when driving in the dark. Accidents could happen because the view may be obscured by interior lights.

Automatic turn off function

The interior lights automatically turn off approximately 20 minutes after the ENGINE START/STOP button is turned off, if the lights are in the ON position.

If your vehicle is equipped with the theft alarm system, the interior lights automatically turn off approximately 5 seconds after the system is armed.

Map lamp

Type A



Type B



- (1): Turn on and off the interior lights independently.
- (2): DOOR mode
 - The map lamp and room lamp come on when a door is opened. The lamps go out after approximately 30 seconds.
 - The map lamp and room lamp come on for approximately 30 seconds when doors are unlocked with a smart key as long as the doors are not opened.

- The map lamp and room lamp will stay on for approximately 10 minutes if a door is opened with the ENGINE START/STOP button in the ACC or OFF position.
- The map lamp and room lamp will stay on continuously if the door is opened with the ENGINE START/STOP button in the ON position.
- The map lamp and room lamp will go out immediately if the ENGINE START/STOP button is changed to the ON position or all doors are locked.
- To turn off the DOOR mode, press the DOOR button (2) once again (not pressed).
- (3): Press this switch to turn the front and rear room lamps on and off.

For Telematics function:

- (4): Roadside assist button
- (5): SOS button

* NOTICE

The DOOR mode and ROOM mode can not be selected at a time.

Room lamp

Type A

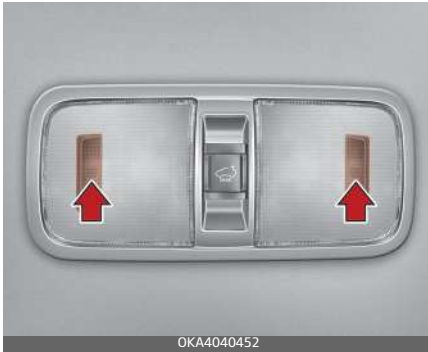

Type B

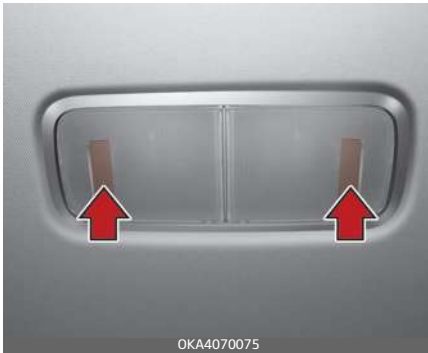

Personal lamp (if equipped)



- When the 1st row DOOR mode button (🚗) is pressed, press the rear room lamp switch to turn the rear room lamp on. Press the switch again to turn the room lamp off.
- The rear room lamp cannot be operated separately if the 1st row DOOR mode button (🚗) is not pressed.
- When the 1st row button (🚗) is pressed, the rear room lamps turn on simultaneously. In this case, room lamp cannot be turned off separately.

Luggage room lamp

- 🚗 : The lamp will always turn on when the liftgate is opened/ closed.
- 🚗 : The lamp is on when the liftgate is opened, and off when the liftgate is closed.
- 🚗 : The lamp will always turn off when the liftgate is opened/ closed.

Type A



Type B

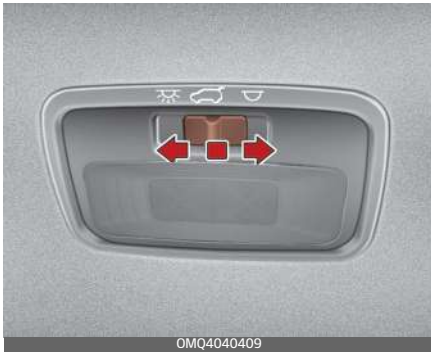

The luggage room lamp comes on when the liftgate is opened.

CAUTION

The luggage room lamp comes on as long as the liftgate opens. To prevent unnecessary charging system drain, close the liftgate securely after using the luggage room.

Vanity mirror lamp (if equipped)



Push the switch to turn the light on or off.

- : The lamp will turn on if this button is pressed.
- : The lamp will turn off if this button is pressed.

CAUTION

Vanity mirror lamp

Always close the lid of the vanity mirror in the off position when the vanity mirror lamp is not in use. If the sun visor is closed without the lamp off, it may discharge the battery or damage the sun visor.

Glove box lamp (if equipped)

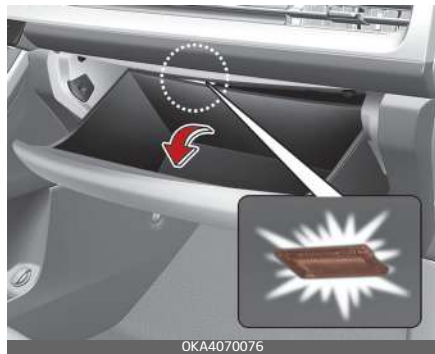

The glove box lamp comes on when the glove box is opened.

NOTICE

To prevent unnecessary charging system drain, close the glove box securely after using the glove box.

Climate control system



The climate control system uses cooling and heating to help maintain a pleasant environment inside the vehicle.

System operation

Ventilation

1. Set the mode to the  position.
2. Set the air intake control to the outside (fresh) air position.
3. Set the temperature control to the desired position.
4. Set the fan speed control to the desired speed.

Heating

1. Set the mode to the  position.
2. Set the air intake control to the outside (fresh) air position.
3. Set the temperature control to the desired position.
4. Set the fan speed control to the desired speed.
5. If dehumidified heating is desired, turn the air conditioning system on.
 - If the windshield fogs up, set the mode to the  or  position.

Operation tips

- To keep dust or unpleasant fumes from entering the vehicle through the ventilation system, tempo-

rally set the air intake control to the recirculated air position. Be sure to return the control to the fresh air position when the irritation has passed to keep fresh air in the vehicle. This will help keep the driver alert and comfortable.

- Air for the heating/cooling system is drawn in through the grilles just at the base of the windshield. Care should be taken that these are not blocked by leaves, snow, ice or other obstructions.
- To prevent fog from forming on the inside of the windshield:
 - Set the air intake control to the fresh air position and the fan speed to the desired position.
 - Turn on the air conditioning system, and adjust the temperature control to desired temperature.

Air conditioning (A/C)

All Kia air conditioning systems are filled with R-1234yf refrigerant.

1. Start the vehicle. Press the A/C button.
2. Set the mode to the  position.
3. Set the air intake control to the outside-air or recirculated air position.
4. Adjust the fan speed control and temperature control to maintain maximum comfort.

⚠ CAUTION

- The refrigerant system should only be serviced by trained and certified technicians to insure proper and safe operation.
- The refrigerant system should be serviced in a well-ventilated place.
- The air conditioning evaporator (cooling coil) shall never be repaired or replaced with one removed from a used or salvaged vehicle and new replacement MAC evaporators shall be certified (and labeled) as meeting SAE Standard J2842.

⚠ CAUTION**Excessive air conditioning use**

When using the air conditioning system, monitor the temperature gauge closely while driving up hills or in heavy traffic when outside temperatures are high. Air conditioning system operation may cause vehicle overheating. Continue to use the blower fan but turn the air conditioning system off if the temperature gauge indicates vehicle overheating.

⚠ CAUTION

The air conditioning system should only be used with the windows and sunroof closed to prevent conden-

sation inside the vehicle that may cause damage to electrical components.

Air conditioning system operation tips

- If the vehicle has been parked in direct sunlight during hot weather, open the windows for a short time to let the hot air inside the vehicle escape.
- To help reduce moisture inside of the windows on rainy or humid days, decrease the humidity inside the vehicle by operating the air conditioning system.
- During air conditioning system operation, you may occasionally notice a slight change in vehicle speed as the air conditioning compressor cycles. This is a normal characteristic of system operation.
- To ensure maximum system performance, the air conditioning system should be run for a few minutes each month.
- When using the air conditioning system, you may notice clear water dripping (or even puddling) on the ground under the passenger side of the vehicle. This is a normal characteristic of system operation.
- Operating the air conditioning system in the recirculated air position provides maximum cool-

ing; however, continual operation in this mode may cause the air inside the vehicle to become stale.

- During cooling operation, you may occasionally notice a misty air flow because of rapid cooling and humid air intake. This is a normal characteristic of system operation.

Climate control air filter

The climate control air filter installed behind the glove box filters the dust or other pollutants that come into the vehicle from the outside through the heating and air conditioning system.

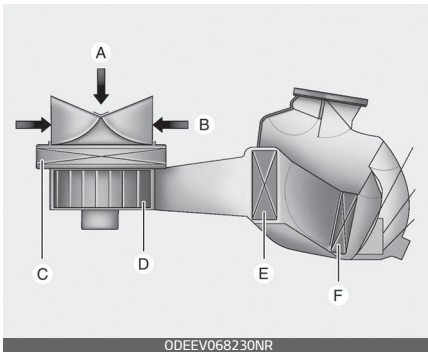

- A: Outside air
- B: Recirculated air
- C: Climate control air filter
- D: Blower
- E: Evaporator core
- F: Heater core

If dust or other pollutants accumulate in the filter over a period of time, the air flow from the air vents may decrease. This leads to moisture accumulating on the inside of the windshield even when the outside (fresh) air position is selected. If this happens, have the climate control air filter replaced by an authorized Kia dealer.

* NOTICE

- Replace the filter according to the Maintenance Schedule. If the vehicle is being driven in severe conditions such as dusty or rough roads, more frequent air conditioner filter inspections and changes are required.
- When the air flow rate suddenly decreases, have the system checked by an authorized Kia dealer.

Rear climate control air filter

The rear climate control air filter installed in the luggage filters the dust or other pollutants from the vehicle cabin area.

If dust or other pollutants accumulate in the filter over a period of time, the air flow from the air vents may decrease. This leads to moisture accumulating on the inside of the windshield even when the out-

side (fresh) air position is selected. If this happens, have the climate control air filter replaced by a professional workshop. Contact and visit an authorized Kia dealer.

* NOTICE

- Replace the filter according to the Maintenance Schedule. If the vehicle is being driven in severe conditions such as dusty or rough roads, more frequent air conditioner filter inspections and changes are required.
- When the air flow rate suddenly decreases, have the system checked by a professional workshop. Contact and visit an authorized Kia dealer.

Checking the amount of air conditioner refrigerant and compressor lubricant

When the amount of refrigerant is low, the performance of the air conditioning is reduced. Overfilling also has a negative impact on the air conditioning system.

Therefore, if abnormal operation is found, have the system inspected by an authorized Kia dealer.

⚠ WARNING

The oil and refrigerant in your vehicle's air conditioning system is

under very high pressure. If proper service procedures are not followed, an explosion may result. To reduce the risk of serious injury or death, the air conditioning system in your vehicle should only be serviced by trained and certified technicians.

⚠ CAUTION

It is important that the correct type and amount of oil and refrigerant is used, otherwise damage to the vehicle may occur. To prevent damage, the air conditioning system in your vehicle should only be serviced by trained and certified technicians.

⚠ WARNING

Vehicles equipped with R-1234yf*



Since the refrigerant is mildly flammable and operated at high pressure, the air conditioning system should only be serviced by trained and certified technicians.

It is important that the correct type and amount of oil and refrigerant are used. All refrigerants should be reclaimed with proper equipment. Venting refrigerants directly to the atmosphere is harmful to individuals and environment. Failure to heed

these warnings can lead to serious injuries.

Manual climate control system (if equipped)

The manual climate control system uses cooling and heating to help maintain a pleasant environment inside the vehicle.

Front seat - type A



Front seat - type B



Rear seat



OKA4040344

Front seat

1. Fan speed control knob
2. Air intake control button
3. Mode selection knob
4. Rear window defroster button
5. Front windshield defroster button
6. Temperature control knob
7. Air conditioning (A/C) button
8. Rear climate control ON button
9. Rear climate control LOCK button
10. Rear seat temperature control switch
11. Rear seat fan speed control switch
12. Front glass heater (if equipped)

Rear seat

1. Rear climate control OFF button
2. Rear fan speed control button
3. Rear mode selection button
4. Rear temperature control button

⚠ CAUTION

Operating the blower when the ignition switch or ENGINE START/STOP button is in the ON position could cause the battery to discharge. Operate the blower when the engine is running.

Heating and air conditioning



1. Start the engine.
2. Set the mode to the desired position.
For improving the effectiveness of heating and cooling;
 - Heating:
 - Cooling:
3. Set the temperature control to the desired position.
4. Set the air intake control to the outside (fresh) air position.
5. Set the fan speed control to the desired speed.
If air conditioning is desired, turn the air conditioning system on.

Mode selection

The mode selection buttons control the direction of the air flow through the ventilation system.



OKA4040306

Air can be directed to the floor, dashboard outlets, or windshield. Five symbols are used to represent Face, Bi-Level, Floor, Floor-Defrost and Defrost air position.

Face-Level (B, D)

Air flow is directed toward the upper body and face. Additionally, each outlet can be controlled to direct the air discharged from the outlet.

Bi-Level (B, C, D, E)

Air flow is directed towards the face and the floor.

Floor-Level (A, C, D, E)

Most of the air flow is directed to the floor, with a small amount of the air being directed to the wind-

shield, side window defrosters and side air vents.

Floor/Defrost-Level (A, C, D, E)

Most of the air flow is directed to the floor and the windshield with a small amount directed to the side window defrosters and side air vents.

Defrost-Level (A, D)

Most of the air flow is directed to the windshield with a small amount of air directed to the side window defrosters and side air vents.

Instrument panel vents

Front

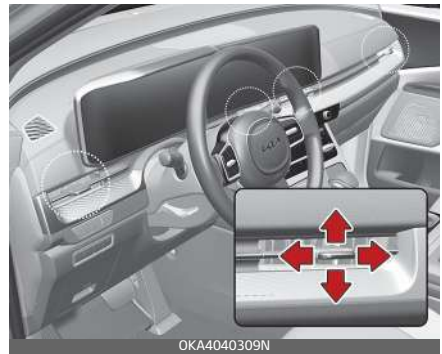

OKA4040309N

Rear

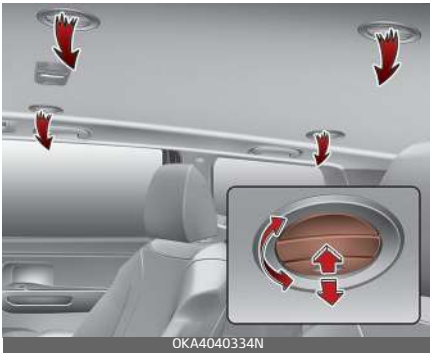

You can adjust the direction of air delivered from these vents using the vent control lever as shown.

Temperature control

The temperature control knob allows you to control the temperature of the air flowing from the ventilation system.



To change the air temperature in the passenger compartment, turn the knob to the right for warm and hot air or to the left for cooler air.

* NOTICE

When starting the vehicle in cold weather using manual temperature control, operate the system in the following method to improve heating:

- Turn off or lower the blower, right after starting the engine.
- Allow the engine to warm up during this time since the air flow from the heater is still cold.
- After a few minutes of engine warm up, turn on or set the fan to a higher level and adjust the temperature setting to hot.

Max A/C selection

To operate the MAX A/C, turn the temperature knob all the way to the left. Air flow is directed toward the upper body and face.



In this mode, the air conditioning and the recirculated air position will be selected automatically.

Controlling air intake

The air intake control is used to select the outside (fresh) air position or recirculated air position.

Type A



Type B



To change the air intake control position.

- Push the desired control button

Recirculated air position



The indicator light on the button illuminates when the recirculated air position is selected.

With the recirculated air position selected, air from the passenger

compartment will be drawn through the heating system and heated or cooled according to the function selected.

Outside (fresh) air position

Type A



Type B



The indicator light on the button will turn off when the outside (fresh) air position is selected.

With the outside (fresh) air position selected, air enters the vehicle from outside and is heated or cooled according to the function selected.

* NOTICE

Prolonged operation of the heater in the recirculated air position (without air conditioning selected) may cause fogging of the windshield and side windows and make the air in the passenger compartment stale.

In addition, prolonged use of the air conditioning with the re-circulated air position selected will result in excessively dry air in the passenger compartment.

⚠ WARNING

- Continuously using the climate control system in the recirculated air position may allow humidity to increase inside the vehicle which may fog the glass and obscure visibility.
- Do not sleep in a vehicle with the air conditioning or heating system on. It may cause serious harm or death due to a drop in the oxygen level and/or body temperature.
- Continuously using the climate control system in the recirculated air position can cause drowsiness or sleepiness, and loss of vehicle control. Set the air intake control to the outside (fresh) air position as much as possible while driving.

Controlling fan speed

The fan speed control knob allows you to control the fan speed of the air flowing from the ventilation system.

The ENGINE START/STOP button must be in the ON position for fan operation.

- To change the fan speed:
- Turn the knob to the right for higher speed or left for lower speed.



To turn off the blowers:

- Turn the fan speed control knob to the "0" position.

Air conditioning (A/C)

Type A



Type B



- Press the A/C button to turn the air conditioning system on (indicator light will illuminate).
- Press the button again to turn the air conditioning system off.

Rear climate control

From the front seat

1. Set the rear climate control selection (REAR ON) button in the front climate control panel to the ON position.
2. Set the rear fan speed control knob in the front climate control panel to the desired position.
3. Set the rear temperature control knob in the front climate control panel to the desired position.



From the rear seat

1. Set the rear climate control selection (REAR ON) button in the front climate control panel to the ON position.
2. Set the rear climate control selection (REAR LOCK) button in the front climate control panel to the OFF position.
3. Set the rear fan speed control button on the rear climate control panel to the desired position.
4. Set the rear temperature control button on the rear climate control panel to the desired position.
5. Select the desired rear mode button on the rear climate control panel.
6. To turn off the rear air conditioning system, press the off button in the rear climate control panel.

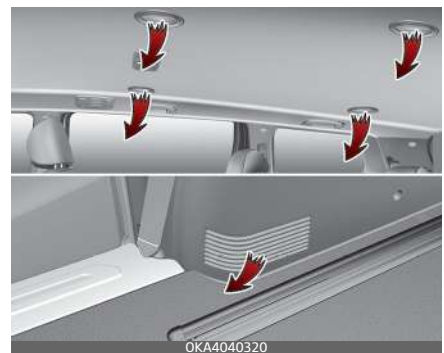

Rear mode selection



- Front climate control is MAX A/C, : Rear air blows from the upper vents on the rear ceiling.

- Front climate control is :
Rear air blows from the upper vents on the rear ceiling and the lower vents on the right rear trim together.
- Front climate control is ,
: Rear air blows from the lower vents on the right rear trim.

When the rear climate control selection (REAR ON) button in the front climate control panel is in the ON position and set the rear climate control selection (REAR LOCK) button in the front climate control panel to the OFF position and the rear mode is selected by pushing the rear mode selection button on the rear control panel as follows:

- : Rear air blows from the upper vents on the rear ceiling.
- : Rear air blows from the upper vents on the rear ceiling and the lower vents on the right rear trim together.
- : Rear air blows from the lower vents on the right rear trim.

Rear temperature control

From the front seat



Set the rear climate control selection (REAR ON) button to the ON position and turn the rear temperature control (REAR TEMP) knob in the front climate control panel to the desired position. To change the rear air temperature, press the switch to the upper position for warm and hot air or lower position for cooler air.

From the rear seat



Set the rear climate control selection (REAR ON) button in the front climate control panel to the ON

position and set the rear climate control selection (REAR LOCK) button in the front climate control panel to the OFF position. To change the rear air temperature, press the button (∧) for warmer air or press the button (∨) for cooler air.

Rear fan speed control

From the front seat



OKA4040315

Set the rear climate control selection (REAR ON) button to the ON position and turn the rear fan speed control (REAR) switch in the front climate control panel to the desired position.

To change the rear fan speed, press the switch to the upper position for higher speed or lower position for lower speed.

The rear climate control fan speed will not decrease below 1 if the fan speed is controlled on the front climate control panel.

To turn the rear air conditioning system off, press the rear climate control selection (REAR ON) button on the climate control panel.

From the rear seat

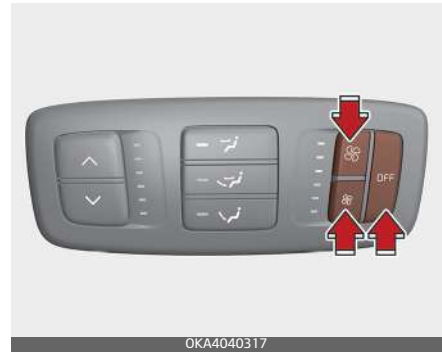

OKA4040317

Set the rear climate control selection (REAR ON) button in the front climate control panel to the ON position and set the rear climate control selection (REAR LOCK) button in the front climate control panel to the OFF position and press the rear fan speed control button on the rear control panel to the desired position.

To turn off the rear air conditioning system press the off button in the rear climate control panel.

Automatic climate control system (if equipped)

The automatic climate control system uses cooling and heating to help maintain a pleasant environment inside the vehicle.

Front seat - type A



Front seat - type B



Rear seat



OKA4040330

Front seat

1. Driver's temperature control button
2. Passenger's temperature control button
3. AUTO (automatic control) button
4. Climate control OFF button
5. Fan speed control button
6. Mode selection button
7. Front windshield defroster button
8. Rear window defroster button
9. SYNC button
10. Air intake control button
11. Air conditioning (A/C) button
12. Front glass heater (if equipped)
13. Climate control display
14. Rear climate control button

Rear seat

1. Rear temperature control button
2. Rear AUTO (automatic control) button
3. Rear mode selection button
4. Rear climate control OFF button
5. Rear fan speed control button

* NOTICE

Operating the blower when the ignition switch or ENGINE START/STOP button is in the ON position could cause the battery to discharge. Operate the blower when the engine is running.

Heating and air conditioning automatically

1. Press the AUTO button.
The modes, fan speeds, air intake and air-conditioning will be controlled automatically by setting the temperature.

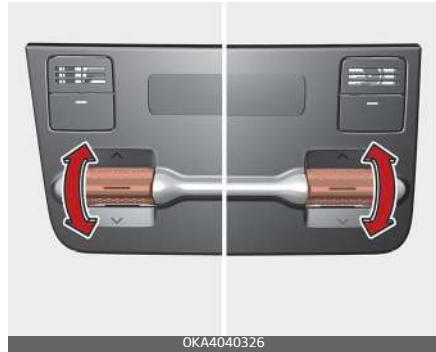

* NOTICE

- To turn the automatic operation off, select any button or switch of the following:
 - Mode selection button
 - Air conditioning button
 - Front windshield defroster button (Press the button one more time to deselect the front windshield defroster function. The AUTO sign will illuminate on the information display once again.)
 - Fan speed control button
 The selected function will be controlled manually while other functions operate automatically.
- For your convenience and to improve the effectiveness of the climate control, use the AUTO button and set the temperature to 22 °C/71 °F.

Level	Indicator	LCD Display	Air flow
High			1 ~ 8
Medium			1 ~ 6
Low			1 ~ 4

2. Press the temperature control button to the desired temperature.

*** NOTICE**

Never place anything over the sensor located on the instrument panel to ensure better control of the heating and cooling system.

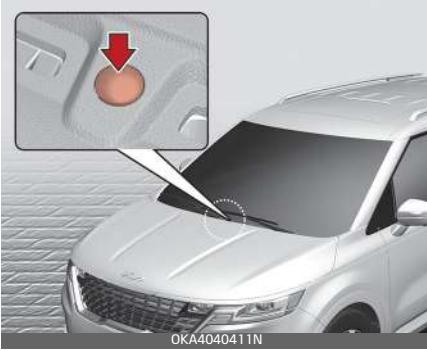

Heating and air conditioning manually

The heating and cooling system can be controlled manually by pressing buttons other than the AUTO button.

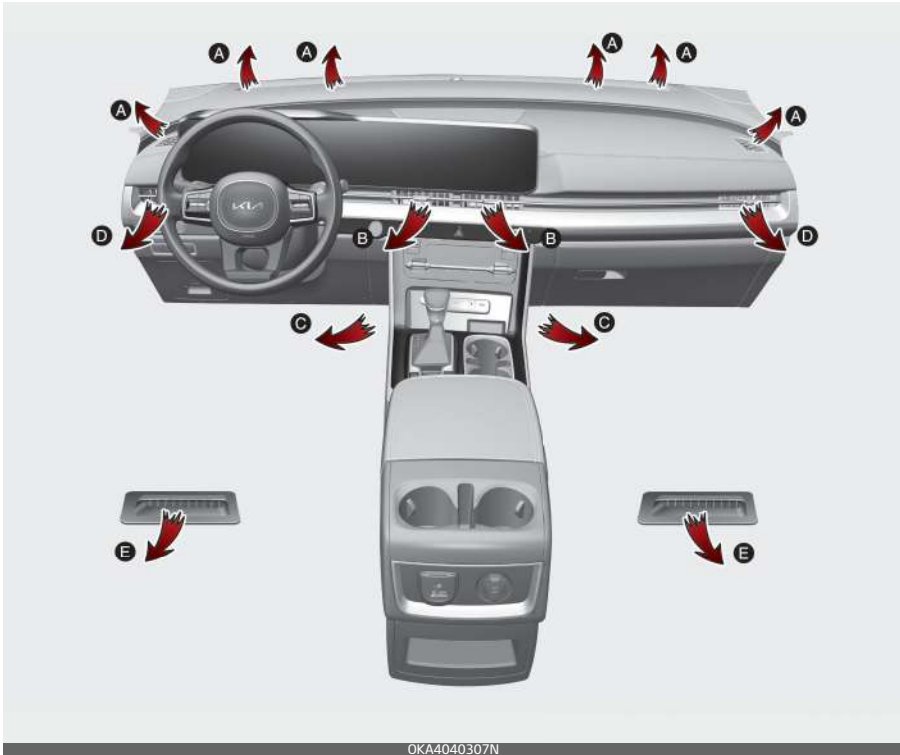

OKA4040307N

In this case, the system works sequentially according to the order of buttons selected.

1. Start the vehicle.
2. Set the mode to the desired position.
 - For improving the effectiveness of heating and cooling;
 - Heating:
 - Cooling:
3. Set the temperature control to the desired position.
4. Set the air intake control to the outside (fresh) air position.
5. Set the fan speed control to the desired speed.
 - If air conditioning is desired, turn the air conditioning system on.

Mode selection

The mode selection button controls the direction of the air flow through the ventilation system.

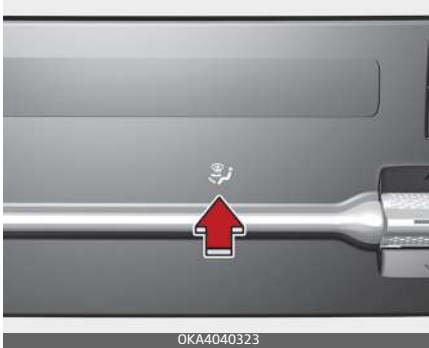

The air flow outlet ports are switched in the following sequence:



Face-Level (B, D)

Air flow is directed toward the upper body and face. Additionally, each outlet can be controlled to direct the air discharged from the outlet.

Bi-Level (B, C, D, E)

Air flow is directed towards the face and the floor.

Floor-Level (A, C, D, E)

Most of the air flow is directed to the floor, with a small amount of the air being directed to the windshield, side window defrosters and side air vents.

Floor/Defrost-Level (A, C, D, E)

Most of the air flow is directed to the floor and the windshield with a small amount directed to the side window defrosters and side air vents.

Defrost-Level (A, D)

Most of the air flow is directed to the windshield with a small amount of air directed to the side window defrosters and side air vents.

Instrument panel vents

Front

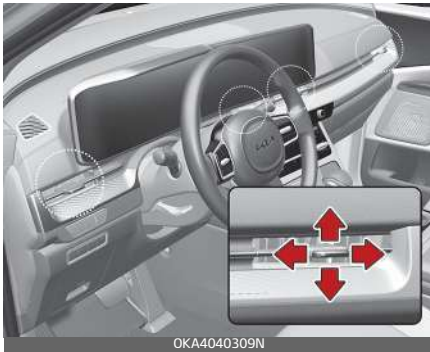

OKA4040309N

Rear

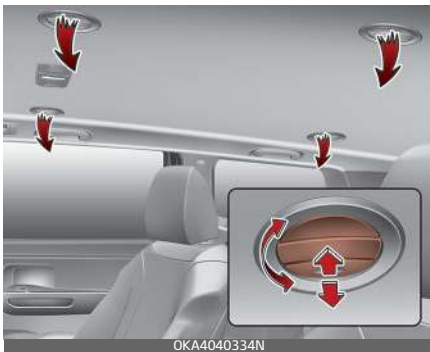

OKA4040334N

You can adjust the direction of air delivered from these vents using the vent control lever as shown.

Temperature control



OKA4040326

The temperature will increase to the maximum (HI) by moving the switch upwards.

The temperature will decrease to the minimum (Lo) by moving the switch downwards.

When moving the switch, the temperature will increase or decrease by 0.5 °C. When set to the lowest temperature setting, the air conditioning will operate continuously.

* NOTICE

When starting the vehicle in cold weather using manual temperature control, operate the system in the following method to improve heating:

- Turn off or lower the blower, right after starting the engine.
- Allow the engine to warm up during this time since the air flow from the heater is still cold.

- After a few minutes of engine warm up, turn on or set the fan to a higher level and adjust the temperature setting to hot.

Adjusting the driver and passenger side temperature equally



1. Press the "SYNC" button to adjust the driver and passenger side temperature equally. The passenger side temperature will be set to the same temperature as the driver side temperature.
2. Move the driver side temperature control switch. The driver and passenger side temperature will be adjusted equally.
3. If you move the passenger's temperature control switch, the SYNC button is off and the passenger side temperature can be operated individually.

Adjusting the driver and passenger side temperature individually

Press the "SYNC" button again to adjust the driver and passenger side temperature individually. The button indicator will turn off.

Changing temperature scale

You can switch the temperature mode from Centigrade to Fahrenheit as follows:

- While pressing the OFF button, press the AUTO button for 3 seconds or more.

The display will change from Centigrade to Fahrenheit, or from Fahrenheit to Centigrade. If the battery has been discharged or disconnected, the temperature mode display will reset to Centigrade.

Controlling air intake

This is used to select the outside (fresh) air position or recirculated air position.

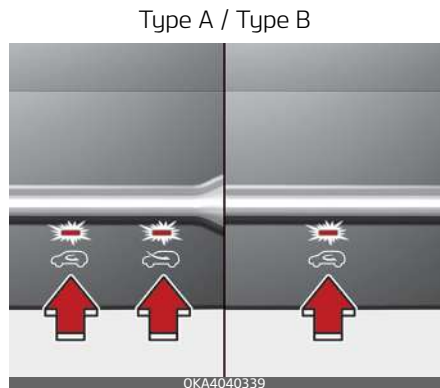

To change the air intake control position:

- Push the desired control button.

Recirculated air position



With the recirculated air position selected, air from the passenger compartment will be drawn

through the heating system and heated or cooled according to the function selected.

Outside (fresh) air position

Type A



Type B



With the outside (fresh) air position selected, air enters the vehicle from outside and is heated or cooled according to the function selected.

*** NOTICE**

Prolonged operation of the heater in the recirculated air position (without air conditioning selected) may cause fogging of the windshield and side windows and the air within the passenger compartment may become stale.

In addition, prolonged use of the air conditioning with the recirculated air position selected will result in excessively dry air in the passenger compartment.

⚠ WARNING

- Continued climate control system operation in the recirculated air position may allow humidity to increase inside the vehicle which may fog the glass and obscure visibility.
- Do not sleep in a vehicle with the air conditioning or heating system on. It may cause serious harm or death due to a drop in the oxygen level and/or body temperature.
- Continued climate control system operation in the recirculated air position can cause drowsiness or sleepiness, and loss of vehicle control. Set the air intake control to the outside (fresh) air position as much as possible while driving.

Controlling fan speed

The fan speed can be set to the desired speed by operating the fan speed control button.

To change the fan speed:

- Press right button for higher speed, or press left button for lower speed.

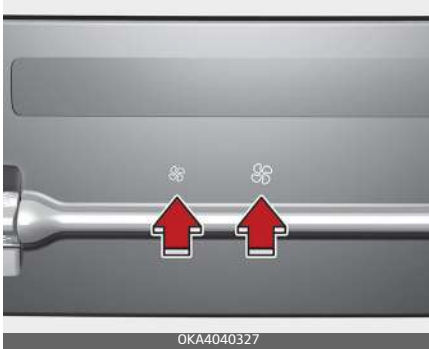

To turn the fan speed control off:

- Press the OFF button.

Air conditioning (A/C)

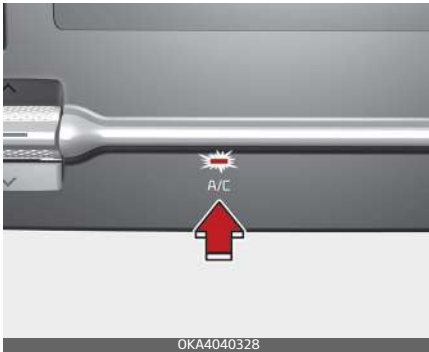

- Press the A/C button to turn the air conditioning system on (indicator light will illuminate).
- Press the button again to turn the air conditioning system off.

Turning off the front air climate control

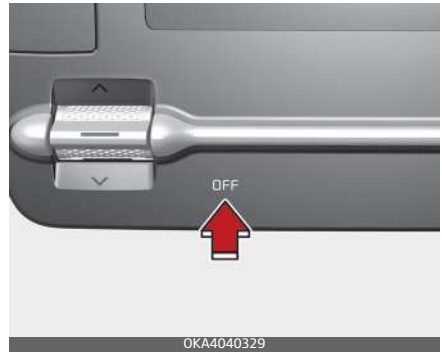

- Press the OFF button to turn off the air climate control system. However, you can still operate the mode and air intake buttons as long as the ENGINE START/STOP button is in the ON position.

Rear climate control

From the front seat





1. Press the rear climate control selection (REAR CLIMATE) button.
2. Set the rear fan speed control knob in the front climate control panel to the desired position.
3. Set the rear temperature control knob in the front climate control panel to the desired position.

From the rear seat

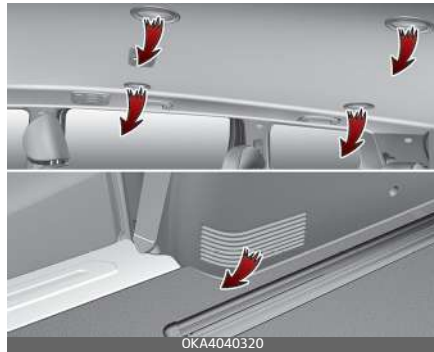

1. Press the rear climate control selection (REAR CLIMATE) button.
2. Deselect 'Lock Rear Climate Controls', if it is selected.
3. Set the rear fan speed control button on the rear climate control panel to the desired position.
4. Set the rear temperature control button on the rear climate control panel to the desired position.
5. Select the desired rear mode button on the rear climate control panel.
6. To turn off the rear air conditioning system, press the off button in the rear climate control panel.

Rear mode selection



- Front climate control is MAX A/C, : Rear air blows from the upper vents on the rear ceiling.
- Front climate control is : Rear air blows from the upper vents on the rear ceiling and the lower vents on the right rear trim together.
- Front climate control is , : Rear air blows from the lower vents on the right rear trim.

Press the rear climate control selection (REAR CLIMATE) button. Deselect 'Lock Rear Climate Controls', if it is selected. The rear mode is selected by pushing the rear mode selection button on the rear control panel as follows:

- : Rear air blows from the upper vents on the rear ceiling.
- : Rear air blows from the upper vents on the rear ceiling and the lower vents on the right rear trim together.

- 
 Rear air blows from the lower vents on the right rear trim.

Rear temperature control

From the front seat

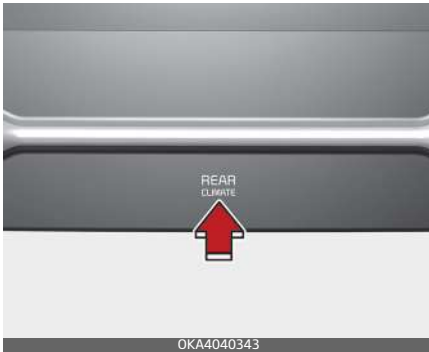

Press the rear climate control selection (REAR CLIMATE) button and press the temperature control switch on the infotainment system screen to the desired position. To change the rear air temperature, press the switch to the upper position for warm and hot air or lower position for cooler air.

From the rear seat



To change the rear air temperature, press the button (∧) for warmer air or press the button (∨) for cooler air.

Rear fan speed control

From the front seat

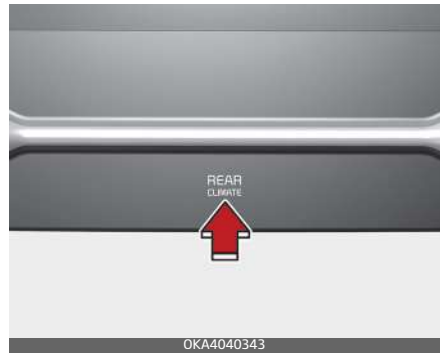

Press the rear climate control selection (REAR CLIMATE) button and press the fan speed control button on the infotainment system screen to the desired position.

To change the rear fan speed, press the left fan speed button for lower

speed or right fan speed button for higher speed. Press the OFF button to turn the rear fan speed control off.

From the rear seat



Press the rear fan speed control button on the rear control panel to the desired position. To turn off the rear air conditioning system press the off button in the rear climate control panel.

Windshield defrosting and defogging

Remove frost and moisture if the windshield becomes blurry due to frost or moisture.

⚠ WARNING

Windshield heating

Do not use the or position during cooling operation in extremely humid weather. The difference between the temperature of the outside air and the windshield could cause the outer surface of the windshield to fog up, causing loss of visibility. In this case, set the mode selection to the position and fan speed control to the lower speed.

- For maximum defrosting, set the temperature control to the extreme right/hot position and the fan speed control to the highest speed.
- If warm air to the floor is desired while defrosting or defogging, set the mode to the floor-defrost position.
- Before driving, clear all snow and ice from the windshield, rear window, outside rear view mirrors, and all side windows.
- Clear all snow and ice from the hood and air inlet in the cowl grill to improve heater and defroster

efficiency and to reduce the probability of fogging up the inside of the windshield.

Defogging inside windshield with manual climate control system



1. Select any fan speed except "0" position.
2. Select desired temperature.
3. Select the or position.
4. The outside (fresh) air and air conditioning will be selected automatically.

If the air conditioning and outside (fresh) air position are not selected automatically, press the corresponding button manually.

Defrosting outside windshield with manual climate control system

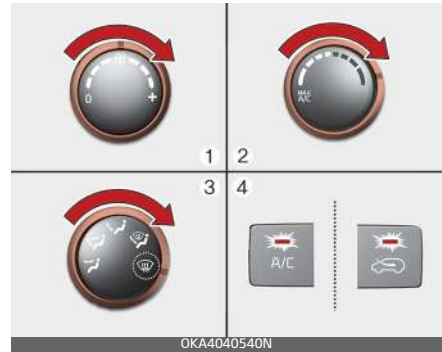

1. Set the fan speed to the highest (extreme right) position.
2. Set the temperature to the extreme hot position.
3. Select the position.
4. The outside (fresh) air and air conditioning will be selected automatically.

Defogging inside windshield with automatic climate control

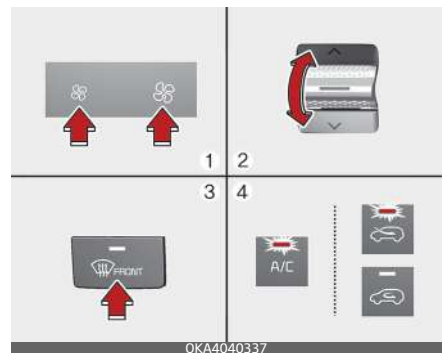



1. Set the fan speed to the desired position.
2. Select desired temperature.
3. Press the defroster button ().

4. The outside (fresh) air position will be selected automatically and the air conditioning will turn on according to the detected ambient temperature.

If the air conditioning and outside (fresh) air position are not selected automatically, adjust the corresponding button manually. If the  position is selected, lower fan speed is adjusted to a higher fan speed.

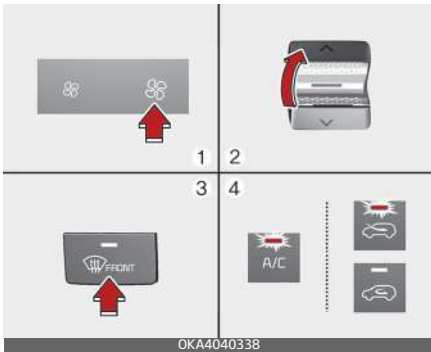
Defrosting outside windshield with automatic climate control



1. Set the fan speed to the highest position.
2. Set the temperature to the extreme hot (HI) position.
3. Press the defroster button (.
4. The outside (fresh) air position will be selected automatically and the air conditioning will turn on according to the detected ambient temperature.

Auto defogging system (only for automatic climate control system) (if equipped)

Auto defogging helps reduce the possibility of fogging up the inside of the windshield by automatically sensing the moisture on inside the windshield.



 The auto defogging system **AUTO** operates when the heater or air conditioning is on.

When the Auto Defogging System operates, the indicator will illuminate.

If a high amount of humidity is detected in the vehicle, the Auto Defogging System will be enabled.

The following steps will be performed automatically:

1. The A/C button will turn ON.
2. The air intake control will change to Fresh mode under low outside temperature.
3. The mode will be changed to defrost to direct airflow to the windshield.

4. The fan speed will be increased.

To cancel or reset the Auto Defogging System

Press the front windshield defroster button for 3 seconds when the ignition switch or ENGINE START/STOP button is in the ON position.

When the Auto Defogging System is canceled, defrost button indicator will blink 3 times.

When the Auto Defogging System is reset, defrost button indicator will blink 6 times without a signal.

* NOTICE

- When the air conditioning is turned on by Auto defogging system, if you try to turn off the air conditioning, the indicator will blink 3 times and the air conditioning will not be turned off.
- To maintain the effectiveness and efficiency of the Auto Defogging System, do not select Recirculation mode while the system is operating.
- When the Auto Defogging System is operating, the fan speed adjustment knob, the temperature adjustment knob, and the air intake control button are all disabled.

* NOTICE

Do not remove the sensor cover located on the upper end of the driver side windshield glass.

Damage to system parts could occur and may not be covered by your vehicle warranty.

Defroster

The vehicle is equipped with a defroster for removing frost or fog from the rear window.

⚠ CAUTION

Conductors

To prevent damage to the conductors bonded to the inside surface of the rear window, never use sharp instruments or window cleaners containing abrasives to clean the window.

If you want to defrost and defog the front windshield, refer to "Windshield defrosting and defogging" on page 4-196.

Operating rear window defroster

The defroster heats the window to remove frost, fog and thin ice from the rear window, while the engine is on.

If there is heavy accumulation of snow on the rear window, brush it

off before operating the rear defroster.



To activate the rear window defroster:

- Press the rear window defroster button located in the heater control panel. The indicator on the rear window defroster button illuminates when the defroster is ON. The rear window defroster automatically turns off after approximately 20 minutes or when the ENGINE START/STOP button is turned off.

To turn off the defroster:

- Press the rear window defroster button again.

Outside mirror defroster (if equipped)

If your vehicle is equipped with the outside mirror defrosters, they will operate at the same time you turn on the rear window defroster.

Front glass heater (if equipped)

The front glass heater heats the window to remove frost, fog and thin ice from the interior and exterior of the front window, while the engine is running.

Type A



Type B

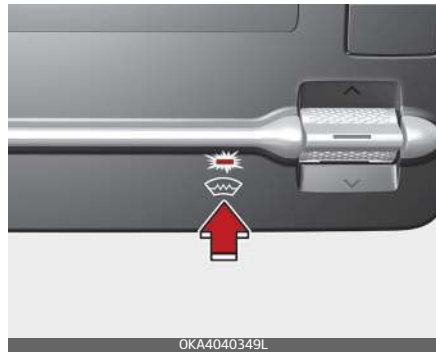

If there is heavy accumulation of snow on the front window, brush it off before operating the front glass heater.



To activate the front glass heater:

- Press the front glass heater button. The indicator on the front glass heater button illuminates when the front glass heater is ON.

The front glass heater automatically turns off after approximately 15 minutes or when the ignition switch or ENGINE START/STOP button is turned off. However, if you press the button again after the heater is turned off automatically after 15 minutes, the heater will stay on only for approximately 5 minutes. To turn off the front glass heater while it is operating, press the front glass heater button again.

Defogging logic

To reduce the possibility of fogging up the inside of the windshield, the air intake or air conditioning is controlled automatically according to certain conditions such as  or

 position.

To cancel automatic defogging logic or return to the automatic defogging logic, do the following.

Canceling/returning automatic defogging logic on manual climate control system

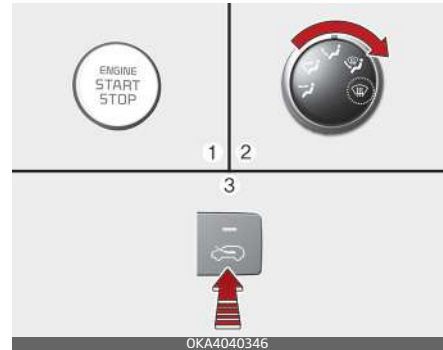

1. Turn the ENGINE START/STOP to the ON position.
2. Select the  position.
3. Within 10 seconds after setting DEFOG mode, press the intake button for at least 5 times within 3 seconds.

The indicator light in the air intake control button will blink 3 times. It indicates that the defogging logic is canceled or returned to the programmed status.

If the battery has been discharged or disconnected, it resets to the defog logic status.

Canceling/returning automatic defogging logic on automatic climate control system

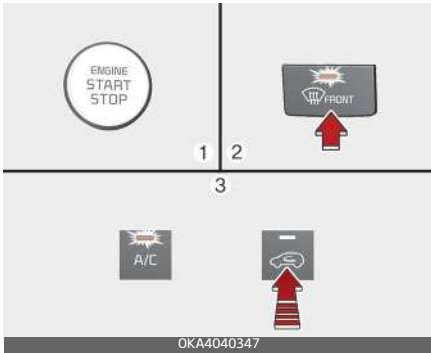

1. Turn the ENGINE START/STOP button to the ON position.
2. Press the defroster button (windshield with wipers icon).
3. While pressing the air conditioning (A/C) button, press the air intake control button at least 5 times within 3 seconds.

The recirculation indicator blinks 3 times in 0.5 second of intervals. It indicates that the defogging logic is canceled or returned to the programmed status.

If the battery has been discharged or disconnected, it resets to the defog logic status.

Activate upon Washer Fluid Use (if equipped)

To prevent the odor from entering to inside the vehicle, the ventilation system changes to Recirculated Air Mode for a while when the windshield washer fluid sprayed.

However, at low outside temperature, to prevent from windshield fogging, the system continues to outside air mode.

System setting

1. ENGINE START/STOP button is ON.
2. Select Floor-Level (windshield with wipers icon) air flow direction by pressing Mode Selection button.
3. With pressing Air Conditioning button, press the Recirculated Air button more than 4 times within 2 seconds.
4. If the system is set up, the indicator on Recirculated Air button will blinks 6 times.

System cancellation

1. ENGINE START/STOP button is ON.
2. Select Floor-Level (windshield with wipers icon) air flow direction by pressing Mode Selection button.
3. With pressing Air Conditioning button, press the Recirculated Air button more than 4 times within 2 seconds.
4. If the system is cancelled, the indicator on Recirculated Air button will blinks 3 times.

Activation on washer fluid is activated when you select 'Settings → Vehicle → Climate → Recirculate Air → Activate upon Washer Fluid Use' from the Settings menu in the clus-

ter LCD display or the Settings in the Infotainment System screen.

For more details, please scan the QR code in a separately supplied Car Infotainment System Quick Reference Guide.

Scheduled Ventilation (if equipped)

Scheduled ventilation is a convenient feature to help reduce the heat inside before getting into the vehicle.



To use the Scheduled ventilation function, select 'Climate → Automatic Ventilation → Scheduled Ventilation Control' on the infotainment system screen.

The vehicle will be automatically ventilated at the selected time and date.

Storage compartment

These compartments can be used to store small items required by the driver or passengers.

- To avoid possible theft, do not leave valuables in the storage compartment.
- Always keep the storage compartment covers closed while driving. Do not attempt to place so many items in the storage compartment that the storage compartment cover cannot close securely.

Passenger's side open tray

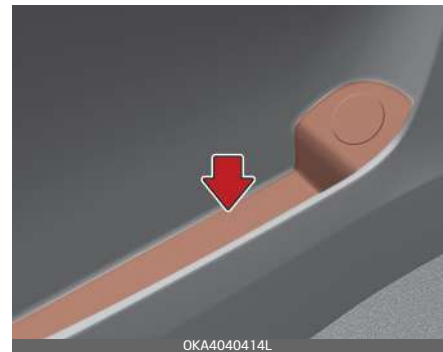

Console box storage compartment (if equipped)



Rotary storage box (if equipped)



- Pull the lever (1) to open the cover. (Used when storing small items, etc.)
 - The objects with fluid inside are fixed with a band (2).

⚠ CAUTION

- When using the rotary storage box, adjust the 3rd row seatback in an appropriate angle after positioning.



- Do not put oversized items or objects with excessive weight in the rotary storage box. The door will not close properly, and potentially deform, causing injury in a collision.

⚠ WARNING

Flammable materials

Do not store, propane cylinders or other flammable/explosive materials in the vehicle. These items may catch fire and/or explode if the vehicle is exposed to hot temperatures for extended periods.

Center console storage



To open the center console storage:

- Pull up the lever.

Glove box



To open the glove box:

- Pull the handle and the glove box will automatically open.

Close the glove box after use.

⚠ WARNING

Glove box

To reduce the risk of injury in an accident or sudden stop, always keep the glove box door closed while driving.

⚠ CAUTION

Do not keep food in the glove box for a long time.

* NOTICE

If the temperature control switch is in the warm or hot position, warm or hot air will flow into the glove box.

Interior features

There are various features inside the vehicle for the convenience of the occupants.

Ambient light (if equipped)

The ambient lights are applied to the and front door and sliding door.



When the headlamp light is on, the ambient light is on at the same time could be set in the infotainment menu.

Refer to the infotainment manual for details.

Cup holder

Front seats

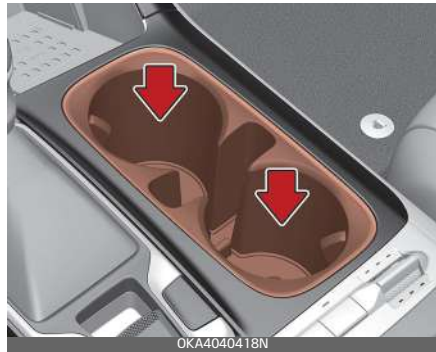

2nd row seats



Door trim

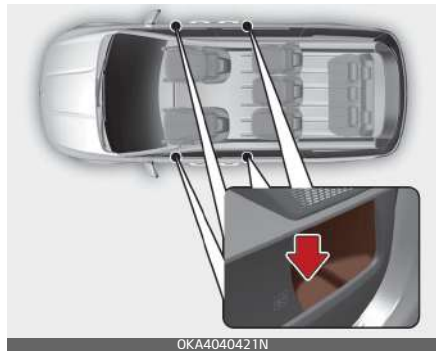

3rd row seats



Cups or small beverage cans may be placed in the cup holders.

⚠ WARNING

Hot liquids

- Do not place uncovered cups with hot liquid in the cup holder while the vehicle is in motion. If the hot liquid spills, you burn yourself. Such a burn to the driver could lead to loss of control of the vehicle.
- To reduce the risk of personal injury in the event of sudden stop or collision, do not place uncovered or unsecured bottles, glasses, cans, etc., in the cup holder while the vehicle is in motion.

⚠ WARNING

Keep cans or bottles out of direct sun light and do not put them in a vehicle that is heated up. It may explode.

*** NOTICE**

- Keep your drinks sealed while driving to prevent spilling your drink. If liquid spills, it may get into the vehicle's electrical/electronic system and damage electrical/ electronic parts.
- When cleaning spilled liquids, do not dry the cup holder at high temperature. This may damage the cup holder.

Seat warmer (if equipped)

The seat warmer is provided to warm the front seats during cold weather.

Front seat (Type A)

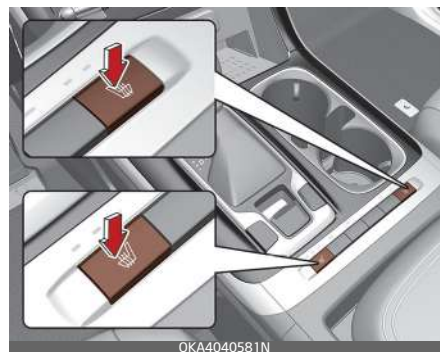

Front seat (Type B)

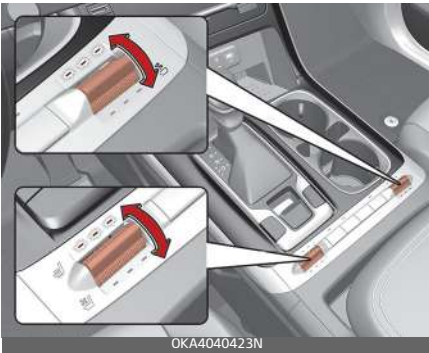

Rear seat



With the ignition switch or ENGINE START/STOP button in the ON position:

- Push either of the levers/switch to warm the driver's seat or the front passenger's seat.

During mild weather or under conditions where the operation of the seat warmer is not needed, keep the levers/switch in the "OFF" position.

The seat warmer defaults to the OFF position whenever the ignition

switch or ENGINE START/STOP button is turned on.

Temperature control (Manual)

- Each time you press the levers/switch, the temperature setting of the seat will change as follows:
 - Front seat (Type A)

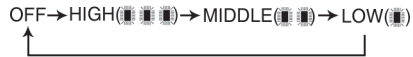

- Front seat (Type B)
 - If you push the lever up when the lever is in the "OFF" position, the seat warmer is set to "HIGH". If you push the lever up or down, you can change the seat temperature.

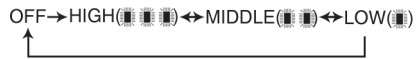

- Rear seat

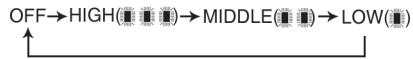

Temperature control (Automatic)

The seat warmer starts to automatically control the seat temperature in order to prevent low-temperature burns after being manually turned ON.



You may manually press the button to increase the seat temperature. However, it soon returns to the automatic mode again.

- When pressing the levers/switch for more than 1.5 seconds with the seat warmer operating, the seat warmer will turn OFF.

* NOTICE

With the seat warmer levers/switch in the ON position, the heating system in the seat turns off or on automatically depending on the seat temperature.

⚠ CAUTION

- When cleaning the seats, do not use an organic solvent such as paint thinner, benzene, alcohol and gasoline. Doing so may damage the surface of the heater or seats.
- To prevent overheating the seat warmer, do not place anything on the seats that insulates against heat, such as blankets, cushions or seat covers while the seat warmer is in operation.
- Do not place heavy or sharp objects on seats equipped with seat warmers. Damage to the seat warming components could occur.

- Do not change the seat cover. It may damage the seat warmer or air ventilation system.

⚠ WARNING

Seat warmer burns

Passengers should use extreme caution when using seat warmers due to the possibility of excess heating or burns. The seat warmer may cause burns even at low temperatures, especially if used for long periods of time. In particular, the driver must exercise extreme care for the following types of passengers:

1. Infants, children, elderly or handicapped persons, or hospital out-patients
2. Persons with sensitive skin or those that burn easily
3. Fatigued individuals
4. Intoxicated individuals
5. Individuals taking medication that can cause drowsiness or sleepiness (sleeping pills, cold tablets, etc.)

Air ventilation seat (if equipped)

Front seat

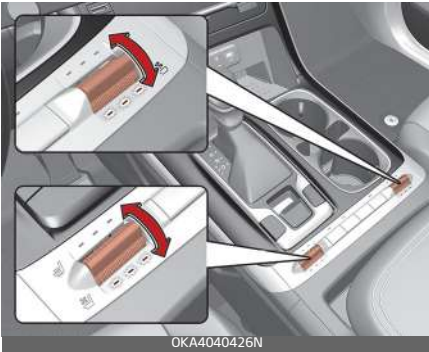

OKA4040426N

Rear seat



OKA4040425

The temperature setting of the seat changes according to the levers position.

- To ventilate your seat cushion, push the levers. Each time you push the levers, the airflow will change as follows:
 - Front seat
 - If you push the lever down when the lever is in the "OFF" position, the air ventilation is set to "HIGH".
 - If you push the lever up or down, you can change the seat temperature.

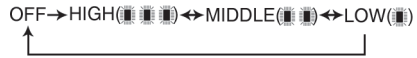

- Rear seat

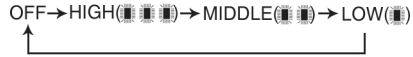

The seat warmer (with air ventilation) defaults to the OFF position whenever the ENGINE START/STOP button is turned on.

* NOTICE

This function is designed to automatically change the temperature setting of the seat (High -> Low) to maintain maximum comfort inside.

⚠ CAUTION

Seat damage

- When cleaning the seats, do not use an organic solvent such as paint thinner, benzene, alcohol and gasoline. Doing so may damage the air ventilation seat.
- Do not place heavy or sharp objects on the seat. Those things may damage the air ventilation seat.
- Be careful not to spill liquid such as water or beverages on the seat. If you spill some liquid, wipe the seat with a dry towel. Before

using the air ventilation seat, dry the seat completely.

Sun visor

Use the sun visor to shield direct light through the front or side windows.

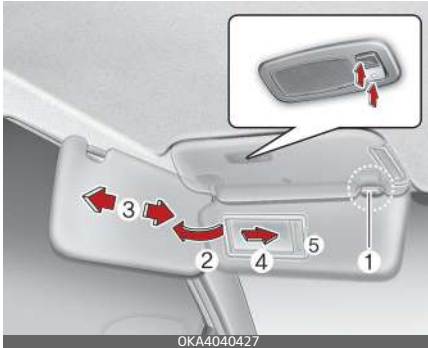

- To use the sun visor, pull it downward.
- To use the sun visor for the side window, pull it downward, unsnap it from the bracket (1) and swing it to the side (2). You can slide the sun visor if necessary (3) (if equipped).
- To use the vanity mirror, pull down the visor and slide the mirror cover (4).

Press the ON button (☀️) to turn on the lamp inside the sun visor when using a mirror. Before returning the sun visor to the original position, be sure to press the OFF button (○) to turn it off. The ticket holder (5) is provided for holding a tollgate ticket.

⚠️ WARNING

For your safety, do not block your view when using the sun visor.

* NOTICE

Do not put several tickets in the ticket holder at one time. This could cause damage to the ticket holder.

USB charger (if equipped)

The USB car charger allows drivers to charge their digital devices like smart phone, and PC tablets.

Front



Front seat

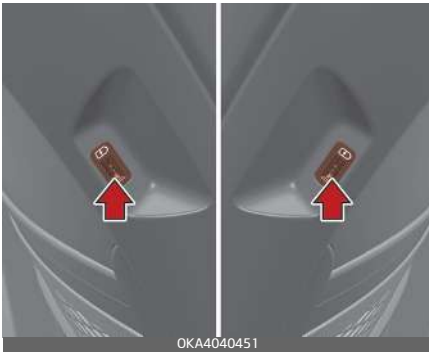

3rd row (if equipped)



Plug the cable into the USB port, and charging will begin.

The USB car charger is available with either the ACC state on or the ignition on. We recommend you connect the USB port and digital devices with the engine running.

See the display screen of the device to check its charging process completion. Your smartphone or table PC could get heated up while charging. This is no reason to worry, as it doesn't impact life or functions of the device. For the safety reason,

charging can be stopped if the battery gets heated up to a certain point of temperature that the devices can be negatively affected. Charging some digital devices is not available or requires special dedicated adapters if their charging methods don't fit the way the USB car charger works. Quick Charge 2.0 is available on the smart phone or the table PC equipped with fast charging capabilities. The applicable is as follows: (<https://www.qualcomm.com/documents/quick-charge-device-list>)

The smart phone or PC tablet without fast charging is charged at a regular speed.

Rated output:

- Digital devices with fast charging:
 - 9.0 V, 1.67 A
- Digital devices with normal charging:
 - 5.0 V, 2.1 A

⚠ CAUTION

- Use the USB car charger with the ignition on. Otherwise, Vehicle battery can be discharged.
- Use the official USB cable of the manufacturer of the digital device to be charged.
- Make sure that any foreign object, drinks, and water do not come into contact with the USB car

charger. Water or foreign object can damage the USB charger.

- Do not use the device those current consumption exceeds 2.1 A.
- If the charger is connected incorrectly, it can cause serious damage on the devices. Please note that damages due to incorrect usage are not covered by warranty service.

Power outlet

The power outlet is designed to provide power for mobile telephones or other devices designed to operate with vehicle electrical systems.

2nd row



3rd row

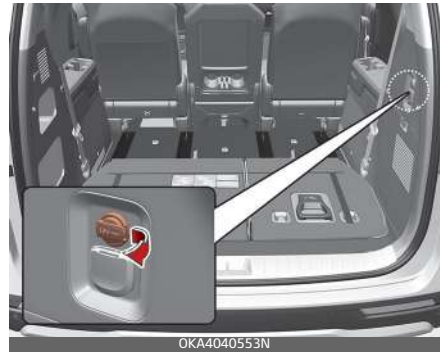

The devices should draw less than 15 amps with the vehicle on.

⚠ CAUTION

- Use the power outlet only when the vehicle is on and remove the accessory plug after use. Using the accessory plug for prolonged periods of time with the vehicle off could cause the battery to discharge.
- Only use 12 V electric accessories which are less than 15 A in electric capacity.
- Adjust the air-conditioner or heater to the lowest operating level when using the power outlet.
- Close the cover when not in use.
- Some electronic devices can cause electronic interference when plugged into a vehicle's power outlet. These devices may cause excessive audio static and malfunctions in other electronic systems or devices used in your vehicle.

- Push the plug in as far as it will go. If good contact is not made, the plug may overheat and the fuse may open.
- Plug in battery equipped electronic devices with reverse current protection. The current from the battery may flow into the vehicle's electrical/electronic system and cause system malfunction.

3rd row



- Rated Voltage: AC 115V
- Maximum electric power: 100W
- In order to avoid an electrical system failure, electric shock, etc., be sure to read owner's manual before use.
- Be sure to close the cover except the time of use.

⚠ WARNING

Electric shock

Do not put a finger or a foreign object (pen, etc.) into a power outlet and do not touch with a wet hand. You may get an electric shock.

AC Inverter (if equipped)

The AC inverter supplies 115V/ 100W electric power to operate electric accessories or equipments.

2nd row



⚠ WARNING

To reduce a risk of serious or fatal injuries:

- Do not use a heated electric device such as a coffee pot, toaster, heater, iron, etc.
- Do not insert foreign objects into the outlet and do not touch the outlet as you may get shocked.
- Do not let children touch the AC inverter.

* NOTICE

- To prevent the battery from being discharged, do not use the AC inverter while the engine is not running.
- When not using the AC inverter, make sure to close the AC inverter cover.
- After using an electric accessory or equipment, pull the plug out. Leaving the accessory or equipment plugged in for a long time may cause battery discharge.
- Do not use an electric accessory or equipment the power consumption of which is greater than 100W (115V).
- Some electric accessories or equipments can cause electronic interference. It may cause excessive audio noise and malfunctions in other electric systems or devices in the vehicle.
- Do not use broken electric accessories or equipments, which may damage the AC inverter and electrical systems of the vehicle.
- Do not use two or more electric accessories or equipments at the same time. It may cause damage to the electrical systems of the vehicle.
- When the input voltage is lower, outlet LED will blink and the AC inverter will turn off automatically. If the input voltage goes up

to normal, the AC inverter will turn on again.

Wireless smart phone charging system (if equipped)

A wireless smart phone charging system is located in front of the center console.



[A]: Charging pad

Firmly close all doors, and the ignition switch or ENGINE START/STOP button is ON. To start wireless charging, place the smart phone equipped with wireless charging function on the wireless charging pad.

For best wireless charging results, place the smart phone on the center of the charging pad.

The wireless charging system is designed for one smart phone equipped with Qi only. Please refer to the smart phone accessory cover or the smart phone manufacturer

homepage to check whether your smart phone supports Qi function.

⚠ WARNING

If any metallic object such as coins is located between the wireless charging system and the smart phone, the charging may be disrupted. Also, the metallic object may heat up.

Wireless smart phone charging

1. Remove any object on the smart phone charging pad including the smart key. If there is any foreign object on the pad other than a smart phone, the wireless charging function may not operate properly.
2. Place the smart phone on the center of the wireless charging pad.
3. The indicator light will change to orange once the wireless charging begins. After the charging is complete, the orange light will change to green.
4. You can choose to turn the wireless charging function to either ON or OFF by selecting the USM on the instrument cluster. (Please refer to "Instrument cluster" on page 4-99 for details).

If the wireless charging does not work, gently move your smart phone around the pad until the charging indicator light turns yellow.

Depending on the smart phone, the charging indicator light may not turn green even after the charging is complete.

If the wireless charging is not functioning properly, the orange light will blink and flash for ten seconds then turn off. In such cases, remove the smart phone from the pad and replace it on the pad again, or double check the charging status.

If you leave the smart phone on the charging pad when the vehicle ignition is in OFF, the vehicle will alert you through warning messages and sound (applicable for vehicles with voice guidance function) after the 'Good bye' function on the instrument cluster ends.

For some manufacturers' smart phones, the system may not warn you even though the smart phone is left on the wireless charging unit. This is due to the particular characteristic of the smart phone and not a malfunction of the wireless charging.

⚠ WARNING

Distracted driving

Driving while distracted can result in a loss of vehicle control that may lead to an accident, severe bodily injury, or death. The driver's primary responsibility is in the safe

and legal operation of a vehicle. Any use of handheld devices, other equipment, or vehicle systems that take the driver's eyes, attention, and focus away from the safe operation of a vehicle are not permissible by law. These should never be used during the operation of the vehicle.

⚠ CAUTION

Liquid in wireless charging system

To prevent liquid from damaging the wireless smart phone charging system in your vehicle, be sure not to spill liquid over the charging system.

⚠ CAUTION

Metal in wireless charging system

If any metallic object such as a coin is located between the wireless charging system and the smart phone, the charging may be disrupted. Also, the metallic object may heat up and potentially damage the charging system. If there is any metallic object between the smart phone and the charging pad, immediately remove the smart phone. Remove the metallic object after it has cooled down.

⚠ CAUTION

- When the interior temperature of the wireless charging system rises above a set temperature, the wireless charging will cease to function. After the interior temperature drops below the threshold, the wireless charging function will resume.
- The wireless charging may not function properly when there is a heavy accessory cover on the smart phone.
- The wireless charging will stop when using the wireless smart key search function to prevent radio wave disruption.
- The wireless charging will stop when the smart key is moved out of the vehicle with the vehicle in ON.
- The wireless charging will stop when any of the doors are opened (applicable for vehicles equipped with smart keys).
- The wireless charging will stop when the vehicle is turned OFF.
- The wireless charging will stop when the smart phone is not in complete contact with the wireless charging pad.
- Items equipped with magnetic components such as credit card, telephone card, bankbook or any transportation ticket may become damaged during wireless charging.

- Place the smart phone on the center of the charge pad for best results. The smart phone may not charge when placed near the rim of the charging pad. When the smart phone does get charged, it may heat up excessively.
- For smart phones without built-in wireless charging system, an appropriate accessory has to be equipped in order to use the vehicle's wireless charging system.
- Certain smart phones may display messages on a weak current. This is due to the particular characteristics of that smart phone, and does not imply a malfunction of the wireless charging function.
- The indicator light of some manufacturers' smart phones may still be orange after the smart phone is fully charged. This is due to the particular characteristic of the smart phone and not a malfunction of the wireless charging.
- When any smart phone without a wireless charging function or a metallic object is placed on the charging pad, a small noise may sound. This small noise is due to the vehicle discerning compatibility of the object placed on the charging pad. It does not affect your vehicle or the smart phone in any way.
- The wireless cellular phone charging system may not support certain cellular phones, which are

not verified for the Qi specification ().

- When placing your smart phone on the charging pad, position the phone in the middle of the pad for maximum efficiency. If your smart phone is off to the side, the charging speed may slow down, and in some cases, your phone may experience higher heat conduction.
- When charging some smart phones with a self-protection feature, the wireless charging speed may decrease, and the charging may stop.
- A smart phone that supports the wireless charging can only be charged wireless.
- The wireless charging pad has an internal cooling system which can create noise to keep your phone cool while it charges.

This device complies with Industry Canada licence-exempt RSS standard(s).

Operation is subject to the following two conditions:

1. This device may not cause interference, and
2. This device must accept any interference, including interference that may cause undesired operation of the device.

Coat hook

A Coat hook is next to the rear grab handle.



* This actual feature may differ from the illustration.

⚠ CAUTION

Hanging clothing

Do not hang heavy clothes, since they may damage the hook.

⚠ WARNING

Do not hang other objects such as hangers or hard objects except clothes. Also, do not put heavy, sharp or breakable objects in the clothing's pockets. In an accident or when the curtain air bag is inflated, it may cause vehicle damage or body injury.



Side curtain (if equipped)



To use the side curtain:

1. Lift the curtain by the knob (1).
2. Hang the curtain on both sides of the knob.

*** NOTICE**

- Always hang both sides of the curtain on the hook. This could cause damage to the side curtain if only one side of the curtains is hooked.
- Do not let any foreign materials get in between the door trim and side curtain. The side curtain may not be lifted up.

Floor mat anchors (if equipped)

Front

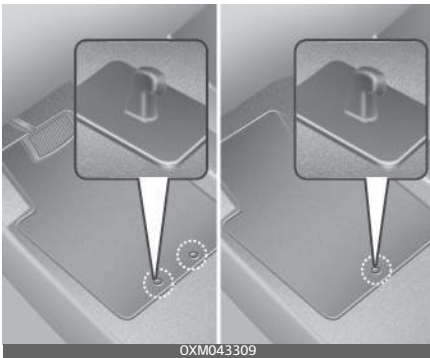

Rear

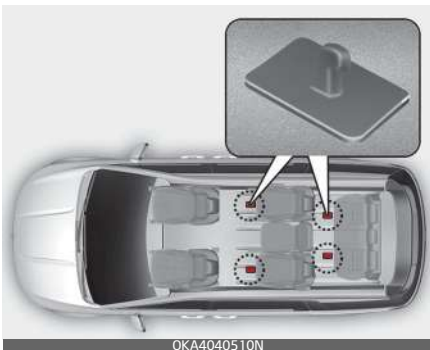

When using a floor mat on the front floor carpet, make sure it attaches to the floor mat anchors in your vehicle. This keeps the floor mat from sliding forward.

⚠ WARNING

Aftermarket floor mat

Do not install aftermarket floor mats that are not capable of being securely attached to the vehicle's floor mat anchors.

Unsecured floor mats can interfere with pedal operation.

The following must be observed when installing ANY floor mat to the vehicle.

- Ensure that the floor mats are securely attached to the vehicle's floor mat anchor(s) before driving the vehicle.
- Do not use ANY floor mat that cannot be firmly attached to the vehicle's floor mat anchors.
- Do not stack floor mats on top of one another (e.g., all-weather rubber mat on top of a carpeted floor mat). Only a single floor mat should be installed in each position.

Luggage net holder

To keep items from shifting in the cargo area, you can use the 4 holders located in the cargo area to attach the luggage net (if equipped), or you can fold the luggage net into half and attach it upwards by using the additional 2 holders located on each side.



If necessary, contact an authorized Kia dealer.

CAUTION

To prevent damage to the goods or the vehicle, be careful when carrying fragile or bulky objects in the luggage compartment.

WARNING

DO NOT over-stretch the luggage net and ALWAYS keep your face and body out of the luggage net's recoil path. Failure to comply with these instructions may result in severe facial injuries. DO NOT use the lug-

gage net when the strap has visible signs of wear or damage.

Passenger view (if equipped)

Passenger view is a convenient feature to help the front passenger talk with rear passengers without turning the head or body backward.

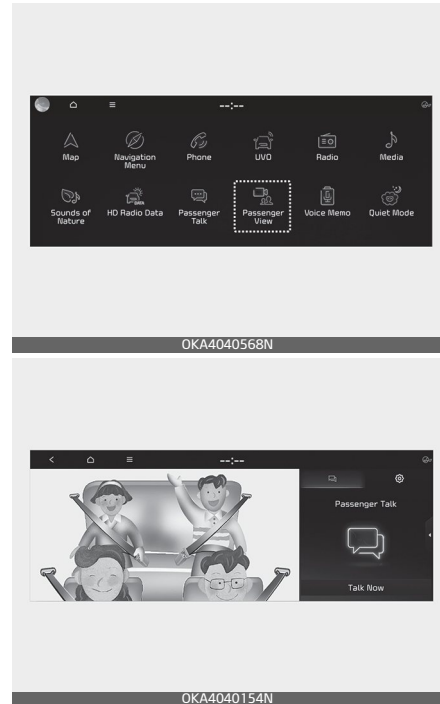

To use the passenger view function, press 'Passenger View' on the infotainment system screen.



OKA4040577N

Press the button located on the roof to use the passenger talk function.

Exterior features

Roof rack (if equipped)

If the vehicle has a roof rack, you can load cargo on top of your vehicle.



OKA4040441N

* The actual shape may differ from the illustration.

Crossbars and fixing components needed to install the roof rack on your vehicle may be obtained from an authorized Kia dealer or other qualified shop.

* NOTICE

- The crossbars (if equipped) should be placed in the proper load carrying positions prior to placing items onto the roof rack.
- If the vehicle is equipped with a sunroof, be sure not to position cargo onto the roof rack in such a way that it could interfere with sunroof operation.

- When the roof rack is not being used to carry cargo, the crossbars may need to be repositioned if wind noise is detected.

⚠ CAUTION

- When carrying cargo on the roof rack, take the necessary precautions to make sure the cargo does not damage the roof of the vehicle.
- When carrying large objects on the roof rack, make sure they do not exceed the overall roof length or width.
- When you are carrying cargo on the roof rack, do not operate the sunroof. (if equipped)

⚠ WARNING

- The following specification is the maximum weight that can be loaded onto the roof rack. Distribute the load as evenly as possible across the crossbars (if equipped) and roof rack and secure the load firmly.

ROOF RACK	100 kg (220 lbs.) EVENLY DISTRIBUTED
-----------	---

Loading cargo or luggage in excess of the specified weight limit on the roof rack may damage your vehicle.

- The vehicle center of gravity will be higher when items are loaded

onto the roof rack. Avoid sudden starts, braking, sharp turns, abrupt maneuvers or high speeds that may result in loss of vehicle control or rollover resulting in an accident.

- Always drive slowly and turn corners carefully when carrying items on the roof rack. Severe wind updrafts, caused by passing vehicles or natural causes, can cause sudden upward pressure on items loaded on the roof rack. This is especially true when carrying large, flat items such as wood panels or mattresses. This could cause the items to fall off the roof rack and cause damage to your vehicle or others around you.
- To prevent damage or loss of cargo while driving, check frequently before or while driving to make sure the items on the roof rack are securely fastened.



Infotainment system

Audio system

* NOTICE

If you install an aftermarket HID headlamp, your vehicle's audio and electronic device may malfunction.

* If your vehicle is equipped with infotainment system, refer to a separately supplied manual for detailed information.

Shark-fin Antenna



The shark fin antenna receives data transmitted from base stations and satellites (e.g. AM/FM, GPS, Sirius XM, LTE) and also transmits to base stations (e.g. LTE).

* NOTICE

- Avoid adding metallic coatings such as Ni, Cd, etc. These can degrade the receiving AM and FM broadcast signals.

USB port

You can use the USB port to plug in an USB.



⚠ CAUTION

Depending on the size, length, or shape of the USB stick, if you forcibly close the tray cover, the USB device may be damaged or deformed or the cover may not reopen as the device is stuck.

When the stick is stuck, forcibly opening the cover can also cause damage to the device.

If the USB stick does not fit into the space, do not close the cover and try another USB stick with different specifications.

How vehicle radio works

FM reception

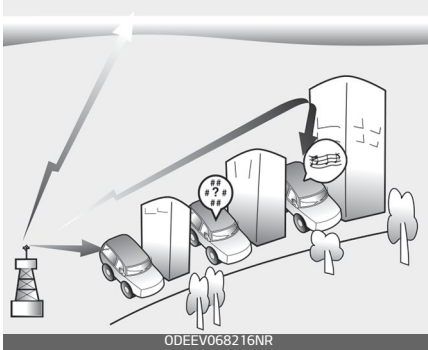

AM and FM radio signals are broadcast from transmitter towers located around your city. They are intercepted by the radio antenna on your vehicle. This signal is then processed by the radio and sent to your vehicle speakers.

However, in some cases the signal coming to your vehicle may not be strong and clear.

This can be due to factors, such as the distance from the radio station, closeness of other strong radio stations or the presence of buildings, bridges or other large obstructions in the area.

AM reception

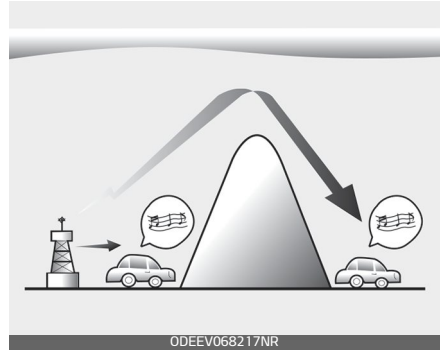

AM broadcasts can be received at greater distances than FM broadcasts. This is because AM radio waves are transmitted at low frequencies. These long distance, low frequency radio waves can follow the curvature of the earth rather than traveling straight. In addition, they curve around obstructions resulting in better signal coverage.

FM radio station

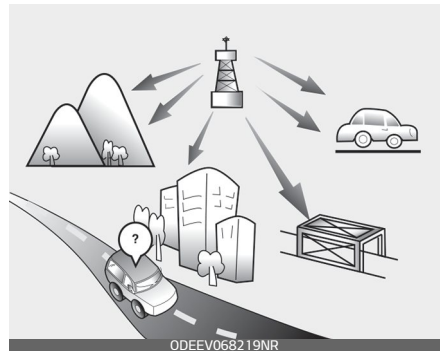

FM broadcasts are transmitted at high frequencies and do not bend to follow the earth's surface. Because

of this, FM broadcasts generally begin to fade within short distances from the station. Also, FM signals are easily affected by buildings, mountains, and obstructions. This can lead to undesirable or unpleasant listening conditions which might lead you to believe a problem exists with your radio.

The following conditions are normal and do not indicate radio trouble:

- Fading – As your vehicle moves away from the radio station, the signal will weaken and sound will begin to fade. When this occurs, we suggest that you select another station with a stronger signal.

- Station Swapping – As an FM signal weakens, another more powerful signal near the same frequency may begin to play. This is because your radio is designed to lock onto the clearest signal. If this occurs, select another station with a stronger signal.

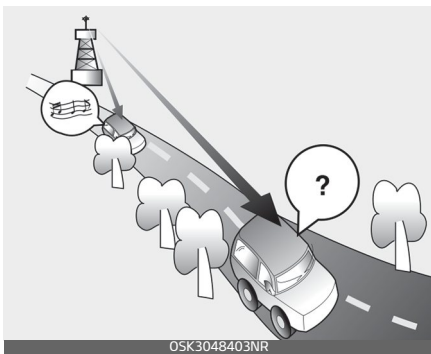
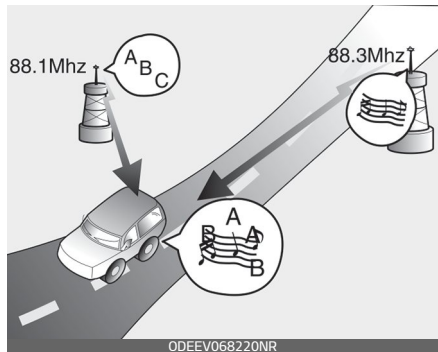

- Flutter/Static – Weak FM signals or large obstructions between the transmitter and your radio can disturb the signal causing static or fluttering noises to occur. Reducing the treble level may lessen this effect until the disturbance clears.

- Multi-Path Cancellation – Radio signals being received from several directions can cause distortion or fluttering. This can be caused by a direct and reflected signal from the same station, or by signals from two stations with close frequencies. If this occurs, select another station until the condition has passed.

Using a cellular phone or a two-way radio

When a cellular phone is used inside the vehicle, noise may be produced from the audio system. This does not mean that something is wrong with the audio equipment. In such a case, try to operate mobile devices

as far from the audio equipment as possible.

When using a communication system such as a cellular phone or a radio set inside the vehicle, a separate external antenna must be fitted. When a cellular phone or a radio set is used with only the internal antenna, it may interfere with the vehicle's electrical system and adversely affect the safe operation of the vehicle.

WARNING

Cell phone use

Do not use a cellular phone while driving. Stop at a safe location to use a cellular phone.

WARNING

Distracted driving

Driving while distracted can result in a loss of vehicle control that may lead to an accident, severe bodily injury, or death. The driver's primary responsibility is in the safe and legal operation of a vehicle. Any use of handheld devices, other equipment, or vehicle systems that take the driver's eyes, attention, and focus away from the safe operation of a vehicle are not permissible by law. These should never be used during the operation of the vehicle.

Declaration of Conformity

IC

This device complies with Industry Canada's licence-exempt RSSs. Operation is subject to the following two conditions:

1. This device may not cause interference; and
2. This device must accept any interference, including interference that may cause undesired operation of the device.

Le présent appareil est conforme aux CNR d'Industrie Canada applicables aux appareils radio exempts de licence. L'exploitation est autorisée aux deux conditions suivantes:

1. l'appareil ne doit pas produire de brouillage, et
2. l'utilisateur de l'appareil doit accepter tout brouillage radioélectrique subi, même si le brouillage est susceptible d'en compromettre le fonctionnement.

CAUTION

Any changes or modifications to this device that is not explicitly approved by the manufacturer could void your authority to operate this equipment.

This equipment complies with IC radiation exposure limits set forth for an uncontrolled environment.

This equipment should be installed and operated with minimum 20 cm (8 in) between the radiator and your body. This transmitter must not be collocated or operating in conjunction with any other antenna or transmitter unless authorized to do so by the IC.

Be sure the exhaust system does not leak.	5-6
Before driving	5-7
Key positions	5-9
• Illuminated ignition switch	5-9
• Ignition switch position.....	5-9
• Starting the engine	5-10
ENGINE START/STOP button	5-11
• Illuminated ENGINE START/STOP button	5-11
• ENGINE START/STOP button position.....	5-11
• Starting the engine	5-13
Automatic transmission (Shift Lever)	5-16
• Automatic transmission operation	5-16
• Paddle shifter	5-19
• Shift lock system.....	5-20
• Good driving practices	5-21
Brake system	5-23
• Power brakes	5-23
• Electronic Parking Brake (EPB)	5-25
• AUTO HOLD.....	5-31
• Anti-lock Brake System (ABS)	5-34
• Electronic Stability Control (ESC) system	5-35
• Hill-start Assist Control (HAC)	5-38
• Vehicle Stability Management (VSM) system	5-39
• Trailer Stability Assist (TSA) system	5-40
• Brake Assist System (BAS).....	5-41
• Good braking practices.....	5-41
Vehicle Auto Shut-off system	5-43
• Operating conditions.....	5-43

5 Driving your vehicle

• Timer reset conditions	5-43
• Off conditions.....	5-43
Drive mode integrated control system.....	5-44
• Drive mode.....	5-44
Forward Collision-Avoidance Assist (FCA) (Front view camera only)	5-48
• Function settings.....	5-49
• Function operation	5-51
Forward Collision-Avoidance Assist (FCA) (Sensor fusion)	5-61
• Function settings.....	5-63
• Function operation	5-64
• Malfunction and limitations	5-69
Lane Keeping Assist (LKA).....	5-77
• Function settings.....	5-78
• Function operation	5-79
• Malfunction and limitations	5-81
Blind-Spot Collision-Avoidance Assist (BCA).....	5-84
• Function settings.....	5-86
• Function operation	5-88
• Malfunction and limitations	5-92
Safe Exit Warning (SEW)	5-96
• Function settings.....	5-97
• Function operation	5-99
• Malfunction and limitations	5-100
Safe Exit Assist (SEA).....	5-102
• Function settings.....	5-103
• Function operation	5-104
• Malfunction and limitations	5-106

Intelligent Speed Limit Assist (ISLA)	5-108
• Function settings.....	5-108
• Function operation.....	5-109
• Malfunction and limitations.....	5-111
Driver Attention Warning (DAW)	5-113
• Function settings.....	5-114
• Function operation.....	5-115
• Malfunction and limitations.....	5-118
Blind-Spot View Monitor (BVM)	5-121
• Function settings.....	5-121
• Function operation.....	5-122
• Malfunction.....	5-122
Cruise Control (CC)	5-123
• Function operation.....	5-123
Smart Cruise Control (SCC)	5-126
• Function settings.....	5-127
• Function operation.....	5-131
• Function display and control.....	5-132
• Malfunction and limitations.....	5-137
Navigation-based Smart Cruise Control (NSCC)	5-143
• Function settings.....	5-144
• Function operation.....	5-145
• Limitations.....	5-147
• This device complies with Industry Canada licence-exempt RSS standard(s).....	5-150
Lane Following Assist (LFA)	5-151
• Function settings.....	5-151
• Function operation.....	5-152
• Malfunction and limitations.....	5-154

5 Driving your vehicle

Highway Driving Assist (HDA)	5-155
• Function settings	5-156
• Function operation	5-157
• Malfunction and limitations	5-159
Rear Cross-Traffic Collision-Avoidance Assist (RCCA)	5-161
• Function settings	5-162
• Function operation	5-164
• Malfunction and limitations	5-168
Reverse Parking Collision-Avoidance Assist (PCA)	5-173
• Function settings	5-173
• Function operation	5-174
• Malfunction and limitations	5-176
Economical operation	5-181
Declaration of conformity	5-182
Special driving conditions	5-184
Winter driving	5-189
Trailer towing	5-192
• Hitches.....	5-194
• Safety chains.....	5-195
• Trailer brakes	5-195
• Driving with a trailer	5-195
• Maintenance when trailer towing.....	5-198
• If you do decide to pull a trailer	5-199
Vehicle load limit	5-201
• Steps For Determining Correct Load Limit -.....	5-202
• Certification label.....	5-204
Vehicle weight	5-205
• Base curb weight.....	5-205

- Vehicle curb weight5-205
- Cargo weight5-205
- GAW (Gross axle weight).....5-205
- GAWR (Gross axle weight rating)5-205
- GVW (Gross vehicle weight)5-205
- GVWR (Gross vehicle weight rating)5-205
- Overloading.....5-206

Driving your vehicle

Be sure the exhaust system does not leak.

The exhaust system should be checked whenever the vehicle is raised to change the oil or for any other purpose.

If you hear a change in the sound of the exhaust or if you drive over something that strikes the underneath side of the vehicle, have the exhaust system checked as soon as possible by an authorized Kia dealer.

WARNING

Engine exhaust

Do not inhale exhaust fumes or leave your engine running in an enclosed area for a prolonged time. Exhaust fumes contain carbon monoxide, a colorless and odorless gas that can cause unconsciousness and death by asphyxiation.

WARNING

Open liftgate

Do not drive with the liftgate open. Poisonous exhaust gases can enter the passenger compartment. If you must drive with the liftgate open proceed as follows:

1. Close all windows.
 2. Open side vents.
 3. Set the air intake control at "Fresh", the air flow control at "Floor" or "Face", and the fan at the highest speed.
-

Before driving

Before getting into the vehicle, you should examine the vehicle and its surroundings. After getting into the vehicle, you should check a number of things before driving.

Before entering vehicle

- Be sure that all windows, outside mirror(s), and outside lights are clean.
- Check the condition of the tires.
- Check under the vehicle for any sign of leaks.
- Be sure there are no obstacles behind you if you intend to back up.

Necessary inspections

Fluid levels, such as engine oil, engine coolant, brake fluid, and washer fluid should be checked on a regular basis, at the exact interval depending on the fluid. Further details are provided in "Maintenance" on page 7-5.

WARNING

Distracted driving

Focus on the road while driving. The driver's primary responsibility is in the safe and legal operation of the vehicle. Use of any hand-held devices, other equipment or vehicle systems that distract the driver should not be used during vehicle operation.

Before starting

- Close and lock all doors.
- Position the seat so that all controls are easily reached.
- Buckle your seat belt.
- Adjust the inside and outside rear view mirrors.
- Be sure that all lights work.
- Check all gauges.
- Check the operation of warning lights when the ENGINE START/STOP button is turned to the ON position.
- Release the parking brake and make sure the brake warning light is not on.

For safe operation, be sure you are familiar with your vehicle and its equipment.

⚠ WARNING

When you intend to park or stop the vehicle with the engine on, be careful not to depress the accelerator pedal for a long period of time. It may overheat the engine or exhaust system and cause fire.

⚠ WARNING**Check surroundings**

Always check the surrounding areas near your vehicle for people, especially children, before putting a vehicle into D (Drive) or R (Reverse).

⚠ WARNING**Loose objects**

Securely store items in your vehicle. When you make a sudden stop or turn the steering wheel rapidly, loose objects may drop on the floor and it could interfere with the operation of the foot pedals, possibly causing an accident.

⚠ WARNING**Driving under the influence**

Do not drive while under the influence of alcohol, drugs, or other impairing substances. Drinking and driving is dangerous. Even a small amount of alcohol will affect your reflexes, perceptions and judgment. Driving while under the influence of drugs or other impairing substances is as dangerous as or more dangerous than driving drunk.

⚠ WARNING**Proper footwear**

Always wear appropriate shoes when operating your vehicle. Unsuitable shoes (high heels, ski boots, sandals, etc.) may interfere with your ability to use the brake and accelerator pedals.

Key positions (if equipped)

Your vehicle is equipped with four different ignition positions.

Illuminated ignition switch

Whenever a front door is opened, the ignition switch will illuminate for your convenience, provided the ignition switch is not in the ON position.



The light will go off immediately when the ignition switch is turned on. It will also go off after about 30 seconds when the door is closed.

Ignition switch position

Your vehicle is equipped with four different ignition positions.



LOCK (1)

The ignition key can be removed only in the LOCK position.

ACC (Accessory) (2)

The electrical accessories are operative. If difficulty is experienced turning the ignition switch to the ACC position, turn the key while turning the steering wheel right and left to release the tension.

ON (3)

The warning lights can be checked before the engine is started. This is the normal running position after the engine is started.

Do not leave the ignition switch ON if the engine is not running to prevent battery discharge.

START (4)

Turn the ignition switch to the START position to start the engine. The engine will crank until you release the key; then it returns to the ON position. The brake warning light can be checked in this position.

⚠ WARNING**Ignition switch**

Never turn the ignition switch to LOCK or ACC while the vehicle is moving. This would result in loss of directional control and braking function, which could cause an accident.

*** NOTICE**

If you leave the ignition switch to the ACC or ON position for a long time, the battery may discharge.

⚠ WARNING**Key holder**

Do not attach small purses, multiple keys, or any other heavy accessories to the driver's key chain used to start the vehicle. This may cause the driver to accidentally make the key inserted in the vehicle to change the ignition position to the ACC position while the vehicle is moving thereby increasing the risk of an accident and causing the deactivation of several safety features.

⚠ WARNING**Leaving the vehicle**

To avoid unexpected or sudden vehicle movement, never leave your vehicle if the gear is not locked in the P (Park) position and the parking brake is fully engaged. Before leaving the driver's seat, always make sure the gear is shifted to P (Park) position, set the parking brake fully and shut the engine off.

Starting the engine

1. Make sure the parking brake is applied.
2. Make sure the gear is shifted to P (Park) position. Depress the brake pedal fully.
3. Turn the ignition switch to START and hold it there until the engine starts (a maximum of 10 seconds), then release the key. It should be started **without depressing the accelerator pedal**.
4. Do not wait for the engine to warm up while the vehicle remains stationary. Start driving at moderate engine speeds. (Steep accelerating and decelerating should be avoided.)

⚠ WARNING**Steering wheel**

Never reach for any controls through the steering wheel while the vehicle is in motion. The presence of your hand or arm in this area could cause a loss of vehicle control.

If the engine stalls while you are in motion, do not attempt to move the shift lever to the P (Park) position. If traffic and road conditions permit, you may put the shift lever in the N (Neutral) position while the vehicle is still moving and turn the ignition switch to the START position in an attempt to restart the engine.

⚠ CAUTION**Starter**

Do not engage the starter for more than 10 seconds. If the engine stalls or fails to start, wait 5 to 10 seconds before reengaging the starter. Improper use of the starter may damage it.

ENGINE START/STOP button (if equipped)**Illuminated ENGINE START/STOP button**

The light will go off after about 30 seconds when the door is closed. It will also go off immediately when the theft-alarm system is armed.

ENGINE START/STOP button position

Your vehicle is equipped with four different ignition positions.

OFF

To turn off the engine (START/RUN position) or vehicle power (ON position), press the ENGINE START/STOP button with the gear in the P (Park) position. When you press the ENGINE START/STOP button without the gear in the P (Park) position, the ENGINE START/STOP button will not change to the OFF position but to the ACC position.

Anti-theft steering column lock (if equipped)

The steering wheel locks when the ENGINE START/STOP button is in the OFF position to protect you against theft.

It locks when the door is opened. If the steering wheel is not locked properly when you open the driver's door, the warning chime will sound. Try locking the steering wheel again. If the problem is not solved, have the system checked by an authorized Kia dealer.

In addition, if the ENGINE START/STOP button is in the OFF position after the driver's door is opened, the steering wheel will not lock and the warning chime will sound. In such a situation, close the door. Then the steering wheel will lock and the warning chime will stop.

*** NOTICE**

If the steering wheel doesn't unlock properly, the ENGINE START/STOP button will not work. Press the ENGINE START/STOP button while turning the steering wheel right and left to release the tension.

*** NOTICE**

You are able to turn off the engine (START/RUN) or vehicle power (ON), only when the vehicle is not in motion.

⚠ CAUTION

In an emergency situation while the vehicle is in motion, you are able to turn the engine off and to the ACC position by pressing the ENGINE START/STOP button for more than 2 seconds or 3 times repeatedly within 3 seconds.

If the vehicle is still moving, to restart the vehicle:

- Press the ENGINE START/STOP button when vehicle speed is 3 mph (5 km/h) or over.

ACC (Accessory)

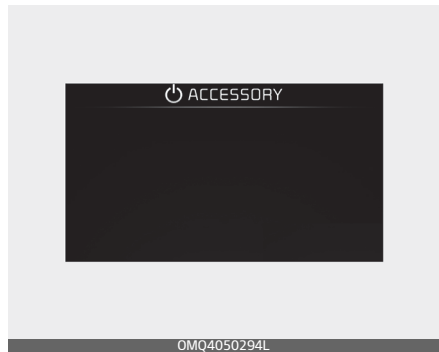

Press the ENGINE START/STOP button while it is in the OFF position without depressing the brake pedal.

The steering wheel unlocks and electrical accessories are operational.

If the ENGINE START/STOP button is in the ACC position for more than 1 hour, the button is turned off auto-

matically to prevent battery discharge.

ON

Press the ENGINE START/STOP button while it is in the ACC position without depressing the brake pedal.

The warning lights can be checked before the engine is started. Do not leave the ENGINE START/STOP button in the ON position for a long time. The battery may discharge, because the engine is not running.

*** NOTICE**

If you leave the ENGINE START/STOP button in the ACC or ON position for a long time, the battery will discharge.

START/RUN

To start the engine, depress the brake pedal and press the ENGINE START/STOP button with the gear in the P (Park) or the N (Neutral) position. For your safety, start the engine with the gear in the P (Park) position.

*** NOTICE**

If you press the ENGINE START/STOP button without pressing the brake pedal, the engine will not start and the ENGINE START/STOP button changes as follow:

OFF → ACC → ON → OFF or ACC

⚠ WARNING

- Never press the ENGINE START/STOP button while the vehicle is in motion. This would result in loss of directional control and braking function, which could cause an accident.
- Before leaving the driver's seat, always make sure the gear is shifted to P (Park) position, set the parking brake fully and shut the engine off. Unexpected and sudden vehicle movement may occur if these precautions are not taken.
- Never reach for the ENGINE START/STOP button or any other controls through the steering wheel while the vehicle is in motion. The presence of your hand or arm in the area could cause loss of vehicle control, an accident and serious bodily injury or death.
- Do not place any movable objects around the driver's seat as they may move while driving, interfere with the driver and lead to an accident.

Starting the engine

⚠ WARNING

- Do not start the vehicle with the accelerator pedal engaged. The

vehicle can move and lead to an accident.

- Wait until the engine rpm is normal. The vehicle may suddenly move if the brake pedal is released when the rpm is high.

Starting the engine with smart key

At the time that the vehicle doors are opened or when the ENGINE START/STOP button is pressed the vehicle will check for the smart key.

If the smart key is not in the vehicle, the (🔑) indicator and a message "Key is not in the vehicle" will appear on the instrument cluster and LCD window. And if all doors are closed, the chime will sound for 5 seconds. The indicator or warning will turn off while the vehicle is moving. Always have the smart key with you.

⚠️ WARNING

The engine will start, only when the smart key is in the vehicle. Never allow children or any person who is unfamiliar with the vehicle touch the ENGINE START/STOP button or related parts. Pushing the ENGINE START/STOP button while the smart key is in the vehicle may result in unintended engine activation and/or unintended vehicle movement.

⚠️ CAUTION

If the engine stalls while the vehicle is in motion, do not attempt to move the gear to the P (Park) position. If the traffic and road conditions permit, you may put the gear in the N (Neutral) position while the vehicle is still moving and press the ENGINE START/STOP button in an attempt to restart the engine.

*** NOTICE**

- If the battery is weak or the smart key does not work correctly, you can start the engine by pressing the ENGINE START/STOP button with the smart key. When you press the ENGINE START/STOP button directly with the smart key, the smart key should contact the button at a right angle.



- When the stop lamp fuse is blown, you cannot start the engine normally.

Replace the fuse with a new one. If it is not possible, you can start the engine by pressing the ENGINE START/STOP button for 10 seconds while it is in the ACC position. The engine can start without pressing the brake pedal. But for your safety always press the brake pedal before starting the engine.

CAUTION

- Do not press the ENGINE START/STOP button for more than 10 seconds except when the stop lamp fuse is blown.

Starting the engine

1. Carry the smart key or leave it inside the vehicle.
2. Make sure the parking brake is firmly applied.
3. Make sure the gear is shifted to P (Park) position. Depress the brake pedal fully.
4. Press the ENGINE START/STOP button.
5. Do not wait for the engine to warm up while the vehicle remains stationary. Start driving at moderate engine speeds. (Steep accelerating and decelerating should be avoided.)

CAUTION

Do not turn the engine off immediately after it has been subjected to a heavy load. Doing so may cause severe damage to the engine.

Automatic transmission (Shift Lever)

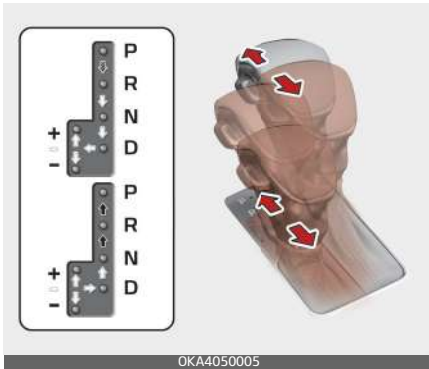

 Depress the brake pedal and the lock release button when shifting.

 Press the unlock button when shifting.

 The shift lever can be shifted freely.

Automatic transmission operation

The automatic transmission has 8 forward speeds and one reverse speed. The individual speeds are selected automatically, depending on the balance between the fuel economy and the power.

* NOTICE

The first few shifts on a new vehicle, if the battery has been disconnected, may be somewhat abrupt. This is a normal condition, and the shifting sequence will adjust after shifts are cycled a few times by the TCM (Transmission Control Module) or PCM (Powertrain Control Module).

For smooth operation, depress the brake pedal when shifting from N (Neutral) to a forward or reverse gear.

⚠ WARNING

Automatic transmission

- Always check the surrounding areas near your vehicle for people, especially children, before shifting a vehicle into D (Drive) or R (Reverse).
- Before leaving the driver's seat, always make sure the shift lever is in the P (Park) position; then set the parking brake fully and shut the engine off. Unexpected and sudden vehicle movement can occur if these precautions are not followed in the order identified.
- Do not use the engine brake (shifting from a high gear to lower gear) rapidly on slippery roads.
The vehicle may slip causing an accident.

⚠ CAUTION

- To avoid damage to your transmission, do not accelerate the engine in R (Reverse) or any forward gear position with the brakes on.
- When stopped on an incline, do not hold the vehicle stationary with engine power. Use the service brake or the parking brake.
- Do not shift from N (Neutral) or P (Park) into D (Drive), or R (Reverse) when the engine is above idle speed.

Transmission ranges

The indicator in the instrument cluster displays the shift lever position when the ignition switch or ENGINE START/STOP button is in the ON position.

P (Park)

Always come to a complete stop before shifting into P (Park). This position locks the transmission and prevents the front wheels from rotating.

⚠ WARNING

- Shifting into P (Park) while the vehicle is in motion will cause the drive wheels to lock which will cause you to lose control of the vehicle.

- Do not use the P (Park) position in place of the parking brake. Always make sure the shift lever is latched in the P (Park) position and set the parking brake fully.
- Never leave a child unattended in a vehicle.

⚠ CAUTION

The transmission may be damaged if you shift into P (Park) while the vehicle is in motion.

R (Reverse)

Use this position to drive the vehicle backward.

⚠ CAUTION

Always come to a complete stop before shifting into or out of R (Reverse); you may damage the transmission if you shift into R while the vehicle is in motion, except as explained in "Rocking the vehicle" on page 5-186.

N (Neutral)

The wheels and transmission are not engaged. The vehicle will roll freely even on the slightest incline unless the parking brake or service brakes are applied.

⚠ WARNING

Do not drive with the shift lever in N (Neutral).

The engine brake will not work and lead to an accident.

⚠ CAUTION

- Always park the vehicle in "P" (Park) for safety and engage the parking brake. If left in "N" (Neutral), the vehicle may move and cause serious damage and injury.
- After the ignition switch or ENGINE START/STOP button has been turned off, the electronic parking brake cannot be disengaged.
- For EPB (Electronic Parking Brake) equipped vehicles with AUTO HOLD function used while driving, if the ignition button has been turned "OFF", the electronic parking brake will be engaged automatically. Therefore, AUTO HOLD function should be turned off before the ignition button is turned off.

D (Drive)

This is the normal forward driving position. The transmission will automatically shift through 8 gear sequence, providing the best fuel economy and power.

For extra power when passing another vehicle or climbing grades, depress the accelerator fully, at which time the transmission will automatically downshift to the next lower gear.

*** NOTICE**

Always come to a complete stop before shifting into D (Drive).

Manual mode

Whether the vehicle is stationary or in motion, manual mode is selected by pushing the shift lever from the D (Drive) position into the manual gate. To return to D (Drive) range operation, push the shift lever back into the main gate.

In manual mode, moving the shift lever backwards and forwards will allow you to make gearshifts rapidly. In contrast to a manual transmission, manual mode allows

gearshifts with the accelerator pedal depressed.

- Up (+): Push the lever forward once to shift up one gear.
- Down (-): Pull the lever backwards once to shift down one gear.

* NOTICE

- The driver must execute upshifts in accordance with road conditions, taking care to keep the engine speed below the red zone.
- Only the 8 forward gears can be selected. To reverse or park the vehicle, move the shift lever to the R (Reverse) or P (Park) position as required.
- Downshifts are made automatically when the vehicle slows down. When the vehicle stops, 1st gear is automatically selected.
- When the engine rpm approaches the red zone shift points are varied to upshift automatically.
- To maintain the required levels of vehicle performance and safety, the system may not execute certain gearshifts when the shift lever is operated.
- When driving on a slippery road, push the shift lever forward into the +(up) position. This causes the transmission to shift into the 2nd gear which is better for smooth driving on a slippery road. Push

the shift lever to the -(down) side to shift back to the 1st gear.

Paddle shifter (if equipped)

The paddle shift function is available when the shift lever is in the D (Drive) position or the manual mode.



With the shift lever in the D position

Pull the [+] or [-] paddle shifter once to shift up or down one gear and the system changes from automatic mode to manual mode.

To change back to automatic shift mode from manual shift mode, do one of the followings:

- Pull the [+] paddle shifter for more than one second
- Move the shift lever from D (Drive) to manual gate and return it to D position again

The manual shift mode also changes back to automatic shift mode in one of following situations

- When the accelerator pedal is gently depressed for more than 6 seconds while driving (not available in sport mode)
- When the vehicle speed decreases below 7 km/h (4 mph)

With the shift lever in the manual mode

Pull the [+] or [-] paddle shifter once to shift up or down one gear.

*** NOTICE**

If you pull the [+] and [-] paddle shifters at the same time, you cannot shift the gear.

Shift lock system

For your safety, the automatic transmission has a shift lock system which prevents shifting the transmission from P (Park) into R (Reverse) unless the brake pedal is depressed.

To shift the transmission from P (Park) into R (Reverse):

1. Depress and hold the brake pedal.
2. Start the engine or turn the ignition switch or ENGINE START/STOP button to the ON position.
3. Move the shift lever.

If the brake pedal is repeatedly depressed and released with the shift lever in the P (Park) position, a chattering noise near the shift lever

may be heard. This is a normal condition.

⚠ WARNING

Always fully depress the brake pedal before and while shifting out of the P (Park) position into another position to avoid inadvertent motion of the vehicle which could injure persons in or around the vehicle.

Shift-lock override



If the shift lever cannot be moved from the P (Park) position into R (Reverse) position with the brake pedal depressed, continue depressing the brake, then do the following:

1. Place the ignition switch or ENGINE START/STOP button in the LOCK/OFF position.
2. Apply the parking brake.
3. Carefully remove the knob boots covering the shift-lock release access hole (1).

4. Insert a tool (e.g., flathead screwdriver) into the access hole and press down on the tool.
5. Move the shift lever.
6. Remove the tool from the shift-lock override access hole then install the knob boots.

If the shift lever does not move even after performing this procedure, have the system inspected by an authorized Kia dealer.

Good driving practices

- Never move the shift lever from P (Park) or N (Neutral) to any other position with the accelerator pedal depressed.
- Never move the shift lever into P (Park) when the vehicle is in motion.
- Be sure the vehicle is completely stopped before you attempt to shift into R (Reverse) or D (Drive).
- Never take the vehicle out of gear and coast down a hill. This may be extremely hazardous. Always leave the vehicle in gear when moving.
- Do not "ride" the brakes. This can cause them to overheat and malfunction. Instead, when you are driving down a long hill, slow down and shift to a lower gear. When you do this, engine braking will help slow down the vehicle.
- Slow down before shifting to a lower gear. Otherwise, the lower gear may not be engaged.
- Always use the parking brake. Do not depend on placing the transmission in P (Park) to keep the vehicle from moving.
- Exercise extreme caution when driving on a slippery surface. Be especially careful when braking, accelerating or shifting gears. On a slippery surface, an abrupt change in vehicle speed can cause the drive wheels to lose traction and the vehicle to go out of control.
- Optimum vehicle performance and economy is obtained by smoothly depressing and releasing the accelerator pedal.

WARNING

- When driving uphill or downhill, always shift to D (Drive) for driving forward or shift to R (Reverse) for driving backwards, and check the gear position indicated on the cluster before driving. Driving in the opposite direction of the selected gear can lead to a dangerous situation by shutting off the engine and affecting the braking performance.
- Always buckle-up! In a collision, an unbelted occupant is significantly more likely to be seriously injured

or killed than a properly belted occupant.

- Avoid high speeds when cornering or turning.
- Do not make quick steering wheel movements, such as sharp lane changes or fast, sharp turns.
- The risk of a rollover is greatly increased if you lose control of your vehicle at highway speeds.
- Losing control often occurs if two or more wheels drop off the roadway and the driver oversteers to reenter the roadway.
- In the event your vehicle leaves the roadway, do not steer sharply. Instead, slow down before pulling back into the travel lanes.
- Never exceed posted speed limits.

Moving up a steep grade from a standing start

To move up a steep grade from a standing start:

- Depress the brake pedal, shift the shift lever to D (Drive). Select the appropriate gear depending on load weight and steepness of the grade, and release the parking brake. Depress the accelerator gradually after releasing the service brakes.

⚠ WARNING

If your vehicle becomes stuck in snow, mud, sand, etc., then you may attempt to rock the vehicle free by moving it forward and backward. Do not attempt this procedure if people or objects are anywhere near the vehicle. During the rocking operation the vehicle may suddenly move forward or backward as it becomes unstuck, causing injury or damage to nearby people or objects.

Brake system

Your vehicle has power-assisted brakes, parking brake, and various braking systems for safe driving.

Power brakes

Your vehicle has power-assisted brakes that adjust automatically through normal usage.

In the event that the power-assisted brakes lose power because of a stalled engine or some other reason, you can still stop your vehicle by applying greater force to the brake pedal than you normally would. The stopping distance, however, will be longer.

When the engine is not running, the reserve brake power is partially depleted each time the brake pedal is applied. Do not pump the brake pedal when the power assist has been interrupted.

Pump the brake pedal only when necessary to maintain steering control on slippery surfaces.

* NOTICE

- When stepping on the brake pedal under a certain driving or weather condition, you may witness your car make a sound of squealing or some other noises. This is not a brake malfunction but a normal phenomenon.

- When driving on the road to which deicing chemicals are applied, the vehicle may witness noises from the brake or abnormal abrasion of tires because of such deicing chemicals. You should operate brake additionally so that you would be able to remove the deicing chemicals on the brake disk and pad under a safe traffic condition.

⚠ CAUTION

Brake pedal

Do not drive with your foot resting on the brake pedal. This will create abnormally high brake temperatures which can cause excessive brake lining and pad wear.

⚠ WARNING

Steep hill braking

Avoid continuous application of the brakes when descending a long or steep hill by shifting to a lower gear. Continuous brake application will cause the brakes to overheat and could result in a temporary loss of braking performance.

Wet brakes may impair the vehicle's ability to safely slow down; the vehicle may also pull to one side when the brakes are applied. Applying the brakes lightly will indicate

whether they have been affected in this way. Always test your brakes in this fashion after driving through deep water. To dry the brakes, apply them lightly while maintaining a safe forward speed until brake performance returns to normal.

In the event of brake failure

If service brakes fail to operate while the vehicle is in motion, you can make an emergency stop with the parking brake. The stopping distance, however, will be much greater than normal.

⚠ WARNING

Parking brake

Avoid applying the parking brake to stop the vehicle while it is moving except in an emergency situation. Applying the parking brake while the vehicle is moving at normal speeds can cause a sudden loss of control of the vehicle. If you must use the parking brake to stop the vehicle, use great caution in applying the brake.

Brake Over Accelerator

In the event the accelerator pedal becomes stuck or entrapped, apply steady and firm pressure to the brake pedal to slow the vehicle and reduce engine power.

If you experience this condition, take the following steps:

1. Apply the brakes and bring your vehicle to a safe stop.
2. Move the transmission to P (Park), switch the engine off and apply the parking brake.
3. Inspect the accelerator pedal for any interference.

If none are found and the condition persists, have your vehicle towed to an authorized Kia dealer.

Disc brakes wear indicator

When your brake pads are worn and new pads are required, you will hear a high-pitched warning sound from your front brakes or rear brakes. You may hear this sound come and go or it may occur whenever you press the brake pedal.

Please remember that some driving conditions or climates may cause a brake squeal when you first apply (or lightly apply) the brakes. This is normal and does not indicate a problem with your brakes.

Always replace the front or rear brake pads as pairs.

⚠ CAUTION

Replace brake pads

Do not continue to drive with worn brake pads. Continuing to drive with worn brake pads can damage the

braking system and result in costly brake repairs.

⚠ WARNING

Brake wear

Do not ignore high pitched wear sounds from your brakes. If you ignore this audible warning, you will eventually lose braking performance, which could lead to a serious accident.

* NOTICE

Brake dust may accumulate on the wheels, even under normal driving conditions. Some dust is inevitable as the brakes wear and contribute to brake noise.

Characteristics of outer vent brake disc

Outer vent brake disc

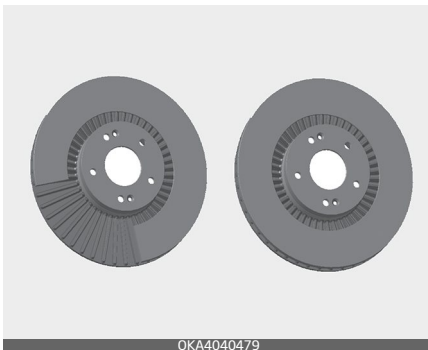

The vent area of the outer vent-type brake disc is exposed to the

outside to improve the cooling performance of the brake when driving. The exposed vent area may become rusty but it will not affect the braking performance, and such corrosion is not covered by warranty.

Electronic Parking Brake (EPB)

After parking the vehicle, apply the Electronic Parking Brake (EPB) to prevent the vehicle from being moved by the external force.

Applying the parking brake with EPB switch



1. Depress the brake pedal.
2. Pull up the EPB switch.

Make sure the warning light comes on.

Also, the EPB is applied automatically if the Auto Hold button is on when the vehicle is turned off. In addition, if you pull up the EPB switch after the vehicle is turned off, the EPB will be applied.

⚠ WARNING

Never leave children and animals unattended in the vehicle. If you leave children unaccompanied in the vehicle, they may be able to set the vehicle in motion, for example by:

- Releasing the parking brake.
- Shifting the transmission out of P (Park) position.
- Starting the engine.

In addition, they may operate vehicle equipment.

*** NOTICE**

On a steep incline or when pulling a trailer, if the vehicle does not remain at a standstill, do as follows:

1. Apply the EPB.
2. Pull up the EPB switch for more than 3 seconds.

Do not operate the EPB while the vehicle is moving except in an emergency situation.

*** NOTICE**

A click or electric brake motor whine sound may be heard while operating or releasing the EPB.

These conditions are normal and indicate that the EPB is functioning properly.

Releasing the parking brake with EPB switch

Releasing the parking brake with EPB switch,

1. Have the ENGINE START/STOP button in the ON position.
2. Press the brake pedal.
3. Press the EPB switch.
4. Make sure the brake warning light goes off.

Automatic release of EPB

The EPB is released automatically under following conditions.

- Gear in P (Park)
With the engine running engage the brake pedal and shift out of P (Park) to R (Reverse) or D (Drive).
- Gear in N (Neutral)
With the engine running, engage the brake pedal and shift out of N (Neutral) to R (Reverse) or D (Drive).

1. Start the engine.
2. Fasten the driver's seat belt.
3. Close the driver's door, hood and liftgate.

4. Press the accelerator pedal while the gear is in R (Reverse), D (Drive) or manual mode.

Make sure the brake warning light goes off.

* NOTICE

- For your safety, you can engage the EPB even though the ENGINE START/STOP button is in the OFF position, but you cannot release it.
- For your safety, press the brake pedal and release the parking brake manually with the EPB switch when you drive downhill or when backing up the vehicle.

Do not follow the above procedure when driving on a flat level ground. The vehicle may suddenly move forward.

* NOTICE

If the parking brake warning light is still on even though the EPB has been released, have the system checked by an authorized Kia dealer.

⚠ CAUTION

Do not drive your vehicle with the EPB applied. It may cause excessive brake pad and brake rotor wear.

Automatic application of EPB

The EPB is applied automatically under following conditions.

- Shift to P (Park) on a slope
- Engine OFF while AUTO HOLD is enabled
- When the vehicle moves a bit in P (Park) position
- Conditions below while AUTO HOLD is activated
 - Driver's door is opened
 - Hood is opened
 - Liftgate is opened
 - Vehicle stops for more than approximately 10 minutes on a steep slope
- Requested by other systems

* NOTICE

For Electronic Parking Brake (EPB) equipped vehicles with AUTO HOLD function used while driving, if the ENGINE START/STOP button has been turned OFF, the EPB will be engaged automatically. Therefore, AUTO HOLD function should be turned off before the ENGINE START/STOP button is turned off.

EPB warning

The EPB will display a warning message with sound under certain conditions.

- If you try to drive off while engaging the accelerator pedal with the EPB applied, but the EPB doesn't release automatically, a warning will sound and a message will appear.
- If the driver's seat belt is not fastened and the vehicle hood, driver's door or liftgate is opened, a warning will sound and a message will appear.

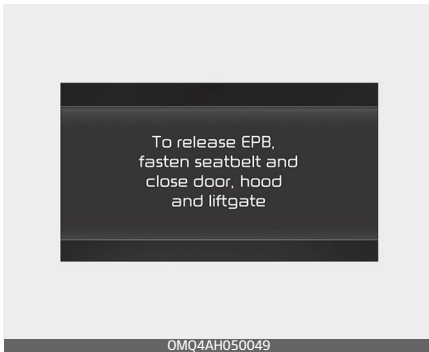

- If there is a problem with the vehicle, a warning may sound and a message may appear.

If the above situation occurs, press the brake pedal and release EPB by pressing the EPB switch.

⚠ WARNING

Parking Brake Use

- Never allow a passenger to touch the parking brake. If the parking brake is released unintentionally, serious injury may occur.
 - All vehicles should always have the parking brake fully engaged when parked to avoid inadvertent movement of the vehicles which can injure occupants or pedestrians.
-
- A click or electric brake motor whine sound may be heard while operating or releasing the EPB. These conditions are normal and indicate that the EPB is functioning properly.
 - When leaving your keys with a parking lot attendant or valet, make sure to inform him/her how to operate the EPB.
 - The EPB may malfunction if you drive with the EPB applied.
 - When you automatically release EPB by pressing the accelerator pedal, press it slowly.

When the conversion from Auto Hold to EPB is not working properly a warning will sound and a message will appear.



* NOTICE

Engage the brake pedal when the above message appears for the Auto Hold and EPB may not activate.

If the EPB is applied while Auto Hold is activated because of an Electronic Stability Control (ESC) signal, a warning will sound and a message will appear.

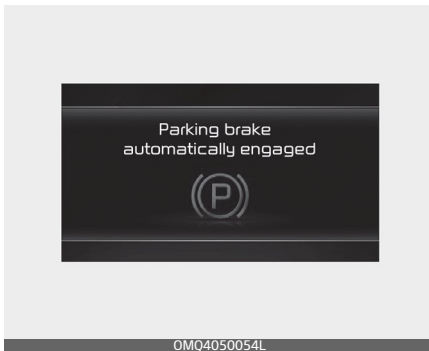

EPB malfunction indicator

This warning light illuminates if the ENGINE START/STOP button is changed to the ON position and goes off in approximately 3 seconds if the system is operating normally.



If the EPB malfunction indicator remains on, comes on while driving, or does not come on when the ENGINE START/STOP button is changed to the ON position, this indicates that the EPB may have malfunctioned.

If this occurs, have your vehicle checked by an authorized Kia dealer.

The EPB malfunction indicator may illuminate when the ESC indicator comes on to indicate that the ESC is not working properly, but it does not indicate a malfunction of the EPB.

*** NOTICE**

The EPB warning light may illuminate if the EPB switch operates abnormally. Shut the engine off and turn it on again after a few minutes. The warning light will go off and the EPB switch will operate normally. However, if the EPB warning light is still on, have the system checked by an authorized Kia dealer.

If the parking brake warning light does not illuminate or blinks even though the EPB switch was pulled up, the EPB is not applied.

If the parking brake warning light blinks when the EPB warning light is on, press the EPB switch, then pull it up. Once more press it back to its original position and pull it back up. If the EPB warning does not go off, have the system checked by an authorized Kia dealer.

Emergency braking with the EPB switch

If there is a problem with the brake pedal while driving, emergency braking is possible by pulling up and holding the EPB switch.

Braking is possible only while you are holding the EPB switch.

⚠ WARNING

Do not operate the Electronic Parking Brake (EPB) while the vehicle is moving except in an emergency situation. Applying the EPB while the vehicle is moving at normal speeds can cause a sudden loss of control of the vehicle. If you must use the EPB to stop the vehicle, use great caution in applying the brake.

*** NOTICE**

During emergency braking by the EPB, the parking brake warning light will illuminate to indicate that the system is operating.

If you notice a continuous noise or burning smell when the EPB is used for emergency braking, have your vehicle checked by an authorized Kia dealer.

When the EPB is not released

If the EPB does not release normally, take your vehicle to an authorized Kia dealer by loading the vehicle on a flatbed tow truck and have the system checked.

AUTO HOLD

The Auto Hold is designed to maintain the vehicle in a standstill even though the brake pedal is not pressed after the driver brings the vehicle to a complete stop by pressing the brake pedal.

Applying Auto Hold function

1. Press the brake pedal and start the vehicle.
2. Press the Auto Hold button. The white AUTO HOLD indicator will come on indicating the system is in standby.



Before the Auto Hold will engage, the driver's door, liftgate and engine hood must be closed.



When coming to a complete stop by pressing the brake pedal, the AUTO HOLD indicator changes from white to green indicating the AUTO HOLD is engaged. The vehicle will remain at a standstill even if you release the brake pedal.

If EPB is applied, Auto Hold will be released.

If you press the accelerator pedal with the gear in D (Drive), R (Reverse) or Manual mode, the Auto Hold will be released automatically and the vehicle will start to move. The indicator changes from green to white indicating the Auto Hold is in standby and the EPB is released.

When driving off from Auto Hold by pressing the accelerator pedal, always check the surrounding area near your vehicle.

Slowly press the accelerator pedal for a smooth launch.

Canceling Auto Hold function



- To cancel the Auto Hold operation, press the Auto Hold switch. The AUTO HOLD indicator will go out.
- To cancel the Auto Hold operation when the vehicle is at a standstill, press the Auto Hold switch while pressing the brake pedal.

* NOTICE

- The following are conditions when the Auto Hold will not engage (Auto Hold light will not turn green and the Auto Hold system remains in stand by):
 - The driver's door is opened
 - The engine hood is opened
 - The liftgate is opened
 - The gear is in P (Park)
 - The EPB is applied
- For your safety, the Auto Hold automatically switches to EPB under any of the following conditions (Auto Hold light remains white and the EPB automatically applies):
 - The driver's door is opened.

- The engine hood is opened.
- The liftgate is opened
- The vehicle is in a standstill for more than 10 minutes.
- The vehicle is standing on a steep slope.
- The vehicle moved for a few seconds.

In these cases, the brake warning light comes on, the AUTO HOLD indicator changes from green to white, and a warning sounds and a message will appear to inform you that EPB has been automatically engaged. Before driving off again, press foot brake pedal, check the surrounding area near your vehicle and release parking brake manually with the EPB switch.

- If the AUTO HOLD indicator lights up yellow, the Auto Hold is not working properly. Take your vehicle and have the system checked by an authorized Kia dealer.

⚠ WARNING

To reduce the risk of an accident, do not activate Auto Hold while driving downhill, backing up or parking your vehicle.

If there is a malfunction with the driver's door, liftgate or engine hood

open detection system, the Auto Hold may not work properly.

Take your vehicle and have the system checked by an authorized Kia dealer.

*** NOTICE**

A click or electric brake motor whine sound may be heard while operating or releasing the EPB, but these conditions are normal and indicate that the EPB is functioning properly.

Warning messages

The Auto Hold function will display a warning message with sound under certain conditions.

When the EPB is applied from Auto Hold, a warning will sound and a message will appear.

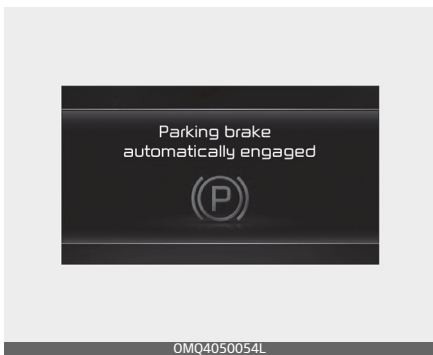

When the conversion from Auto Hold to EPB is not working properly a warning will sound and a message will appear.

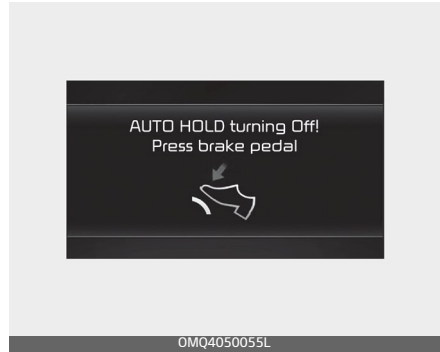

*** NOTICE**

When this message is displayed, the Auto Hold and EPB may not operate. For your safety, press the brake pedal.

If you do not apply the brake pedal when you release the Auto Hold by pressing the [AUTO HOLD] switch, a warning will sound and a message will appear.

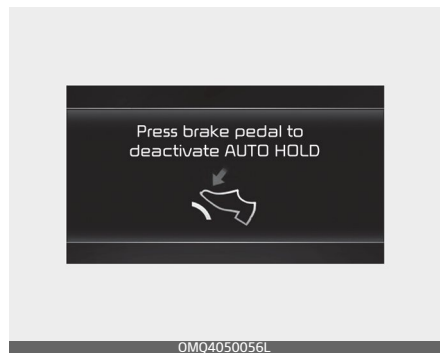

When you press the [AUTO HOLD] switch, if the driver's door, liftgate and engine hood are not closed, a

warning will sound and a message will appear on the LCD display.

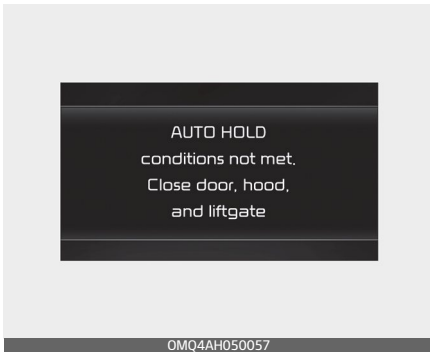

At this moment, press the [AUTO HOLD] button after closing the driver's door and engine hood.

Anti-lock Brake System (ABS)

The Anti-lock Brake System (ABS) prevents the wheels from locking. So the vehicle remains stable and can still be steered.

ABS (or ESC) will not prevent accidents due to improper or dangerous driving maneuvers. Even though vehicle control is improved during emergency braking, always maintain a safe distance between you and objects ahead. Vehicle speeds should always be reduced during extreme road conditions. The vehicle should be driven at reduced speeds in the following circumstances:

- When driving on rough, gravel or snow-covered roads

- When driving on roads where the road surface is pitted or has different surface heights.

Driving in these conditions increases the stopping distance for your vehicle.

The ABS continuously senses the speed of the wheels. If the wheels are going to lock, the ABS repeatedly modulates the hydraulic brake pressure to the wheels.

When you apply your brakes under conditions which may lock the wheels, you may hear a "tik-tik" sound from the brakes, or feel a corresponding sensation in the brake pedal. This is normal and it means your ABS is active.

In order to obtain the maximum benefit from your ABS in an emergency situation, do not attempt to modulate your brake pressure and do not try to pump your brakes. Press your brake pedal as hard as possible to allow the ABS to control the force being delivered to the brakes.

* NOTICE

A click sound may be heard in the vehicle compartment when the vehicle begins to move after the vehicle is started. These conditions are normal and indicate that the Anti-lock Brake System is functioning properly.

Even with the Anti-lock Brake System, your vehicle still requires sufficient stopping distance. Always maintain a safe distance from the vehicle in front of you.

Always slow down when cornering. The Anti-lock Brake System cannot prevent accidents resulting from excessive speeds.

On loose or uneven road surfaces, operation of the Anti-lock Brake System may result in a longer stopping distance than for vehicles equipped with a conventional brake system.

The ABS warning light will stay on for approximately 3 seconds after the ENGINE START/STOP button is ON.



During that time, the ABS will go through self-diagnosis and the light will go off if everything is normal. If the light stays on, you may have a

problem with your ABS. Contact and visit an authorized Kia dealer.

When you drive on a road having poor traction, such as an icy road, and have operated your brakes continuously, the ABS will be active continuously and the ABS warning light may illuminate. Pull your vehicle over to a safe place and stop the vehicle.

Restart the vehicle. If the ABS warning light goes off, then your ABS is normal. Otherwise, you may have a problem with the ABS. Contact and visit an authorized Kia dealer.

* NOTICE

When you jump start your vehicle because of a drained battery, the vehicle may not run as smoothly and the ABS warning light may turn on at the same time. This happens because of low battery voltage. It does not mean your ABS has malfunctioned.

- Do not pump your brakes!
- Have the battery recharged before driving the vehicle.

Electronic Stability Control (ESC) system

The Electronic Stability Control (ESC) is designed to stabilize the vehicle during cornering maneuvers.



OKA4050017N

ESC applies the brakes on individual wheels and intervenes with the vehicle management system to stabilize the vehicle.

ESC will not prevent accidents. Excessive speed in turns, abrupt maneuvers and hydroplaning on wet surfaces can still result in serious accidents.

Only a safe and attentive driver can prevent accidents by avoiding maneuvers that cause the vehicle to lose traction. Even with ESC installed, always follow all the normal precautions for driving - including driving at safe speeds for the conditions.

⚠ WARNING

For maximum protection, always wear your seat belt. No system, no matter how advanced, can compensate for all driver error and/or driving conditions. Always drive responsibly.

The ESC system is an electronic system designed to help the driver maintain vehicle control under adverse conditions. It is not a substitute for safe driving practices. Factors including speed, road conditions and driver steering input can all affect whether ESC will be effective in preventing a loss of control. It is still your responsibility to drive and corner at reasonable speeds and to leave a sufficient margin of safety.

When you apply your brakes under conditions which may lock the wheels, you may hear a "tik-tik" sound from the brakes, or feel a corresponding sensation in the brake pedal. This is normal and it means your ESC is active.

*** NOTICE**

A click sound may be heard in the vehicle compartment when the vehicle begins to move after the vehicle is started. These conditions are normal and indicate that the Electronic Stability Control system is functioning properly.

ESC operation

ESC ON condition

- When the ENGINE START/STOP button is turned ON, ESC and ESC OFF indicator lights illuminate for

approximately 3 seconds, then ESC is turned on.

- Press the ESC OFF button for at least half a second after turning the vehicle ON to turn ESC off. (ESC OFF indicator will illuminate). To turn the ESC on, press the ESC OFF button (ESC OFF indicator light will go off).
- When starting the vehicle, you may hear a slight ticking sound. This is the ESC performing an automatic system self-check and does not indicate a problem.

When operating



When the ESC is in operation, the ESC indicator light blinks. When the Electronic Stability Control is operating properly, you can feel a slight pulsation in the vehicle. This is only the effect of brake control and indicates nothing unusual.

When moving out of the mud or driving on a slippery road, pressing the accelerator pedal may not cause the vehicle rpm (revolutions per minute) to increase.



ESC operation off

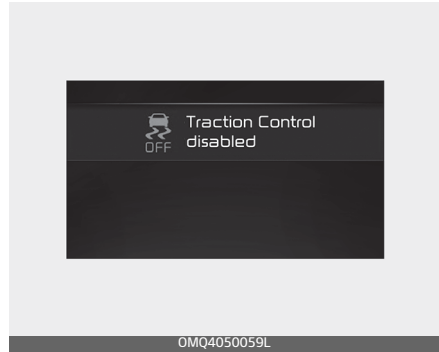

This vehicle has 2 kinds of ESC off states. If the vehicle stops when ESC is off, ESC remains off. Upon restarting the vehicle, the ESC will automatically turn on again.



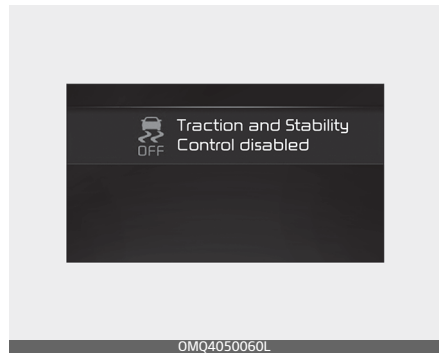

ESC off state 1

To turn off the traction control function and only operate the brake control function of the ESC, press the ESC OFF button (ESC OFF ) for less than 3 seconds and the ESC OFF indicator light (ESC OFF ) will illuminate.



ESC off state 2

To turn off the traction control function and the brake control function of the ESC, press the ESC OFF button (ESC OFF ) for more than 3 seconds. ESC OFF indicator light

(ESC OFF ) will illuminate and ESC OFF warning chime will sound. At this state, the vehicle stability control function does not operate any more.

Indicator light

ESC indicator light



ESC OFF indicator light



When ENGINE START/STOP button is turned to ON, the indicator light illuminates, then goes off if the ESC system is operating normally.

The ESC indicator light blinks whenever ESC is operating or illuminates when ESC fails to operate.

The ESC OFF indicator light comes on when the ESC is turned off with the button.

WARNING

Electronic Stability Control

Drive carefully even though your vehicle has Electronic Stability Control. It can only assist you in maintaining control under certain circumstances.

ESC OFF usage

When driving

- ESC should be turned on for daily driving whenever possible.
- To turn ESC off while driving, press the ESC OFF button while driving on a flat road surface.

WARNING

Operating ESC

Never press the ESC OFF button while ESC is operating (ESC indicator light blinks).

If ESC is turned off while ESC is operating, the vehicle may slip out of control.

* NOTICE

- When operating the vehicle on a dynamometer, ensure that the ESC is turned off (ESC OFF light illuminated). If the ESC is left on, it may prevent the vehicle speed from increasing, and result in false diagnosis.
- Turning the ESC off does not affect ABS or brake system operation.

Hill-start Assist Control (HAC)

A vehicle has the tendency to roll back on a steep hill when it starts to go after stopping. The Hill-start Assist Control (HAC) prevents the

vehicle from rolling back by applying the brakes automatically for about 2 seconds.

The brakes are released when the accelerator pedal is engaged or after about 2 seconds.

The HAC is activated only for about 2 seconds, so when the vehicle is starting off always engaged the accelerator pedal.

⚠ WARNING

Maintaining brake pressure on incline

HAC does not replace the need to apply brakes while stopped on an incline. While stopped, make sure you maintain brake pressure sufficient to prevent your vehicle from rolling backward and causing an accident. Don't release the brake pedal until you are ready to accelerate forward.

Vehicle Stability Management (VSM) system

The Vehicle Stability Management (VSM) provides further enhancements to vehicle stability and steering responses under the following condition:

- when driving on a slippery road or
- when a change in the coefficient of friction between left and right wheels is detected.

⚠ WARNING

Tire/wheel size

When replacing tires and wheels, make sure they are the same size as the original tires and wheels installed. Driving with varying tire or wheel sizes may diminish any supplemental safety benefits of the VSM system.

VSM operation

When the VSM is operating properly, you can feel a slight pulsation in the vehicle and/or abnormal steering responses (Electric Power Steering (EPS)). This is only the effect of brake and EPS control and indicates nothing unusual.

The VSM does not operate when:

- Driving on a sloping road such as a gradient or incline
- Driving in reverse
- ESC OFF indicator light  remains on the instrument cluster
- EPS indicator light remains on the instrument cluster

VSM operation off

If you press the ESC OFF button to turn off the ESC, the VSM will also cancel and the ESC OFF indicator light () illuminates.

To turn on the VSM, press the button again. The ESC OFF indicator light goes out.

⚠ WARNING

Vehicle Stability Management

Drive carefully even though your vehicle has Vehicle Stability Management. It can only assist you in maintaining control of the vehicle under certain circumstances.

Malfunction indicator

The VSM can be deactivated even if you don't cancel the VSM operation by pressing the ESC OFF button. It indicates that a malfunction has been detected somewhere in the Electric Power Steering system or VSM system. If the ESC indicator light () or EPS warning light remains on, take your vehicle and have the system checked by an authorized Kia dealer.

The VSM is not a substitute for safe driving practices but a supplementary function only. It is the responsibility of the driver to always check

the speed and the distance to the vehicle ahead. Always hold the steering wheel firmly while driving.

Your vehicle is designed to activate according to the driver's intention, even with installed VSM. Always follow all the normal precautions for driving at safe speeds for the conditions – including driving in clement weather and on a slippery road.

⚠ WARNING

For maximum protection, always wear your seat belt. No system, no matter how advanced, can compensate for all driver error and/or driving conditions. Always drive responsibly.

Trailer Stability Assist (TSA) system

The Trailer Stability Assist (TSA) is operated as a vehicle stability control system. The TSA is designed to stabilize the vehicle and trailer when the trailer sways or oscillates. There are various factors that make the vehicle sway or oscillate.

Such incidents mostly happen at high speed, but, there is also a risk of swaying when the trailer is affected by crosswinds, buffeting or improper overloading.

Factors of swaying such as:

- High speed
- Strong crosswinds
- Improper overloading
- Sudden controlling of steering wheel
- Uneven road

The TSA continuously analyzes the vehicle and trailer instability. When the TSA detects some sway, the brakes are applied automatically to stabilize the vehicle. When the vehicle becomes stable, the TSA does not operate.

Brake Assist System (BAS)

The BAS system is to reduce or to avoid accident risk. It recognizes the distance from the vehicle ahead or the pedestrian through the sensors (i.e. radar and camera), and, if necessary, warns the driver of accident risk with the warning message or the warning alarms.

WARNING

Brake Assist System (BAS) limitations

The BAS system is a supplemental system and is not a substitute for safe driving practices. It is the responsibility of the driver to always check the speed and distance to the vehicle ahead to ensure it is safe to use.

* NOTICE

Take the following precautions when using the Brake Assist System (BAS):

This system is only a supplemental system and it is not intended to, nor does it replace the need for extreme care and attention of the driver. The sensing range and objects detectable by the sensors are limited. Pay attention to the road conditions at all times.

NEVER drive too fast in accordance with the road conditions or while cornering.

Always drive cautiously to prevent unexpected and sudden situations from occurring. BAS does not stop the vehicle completely and does not avoid collisions.

Good braking practices

Good braking practices help keep occupants safe and extend brake life.

- Check to be sure the parking brake is not engaged and the parking brake indicator light is out before driving away.
- Driving through water may get the brakes wet. They can also get wet when the vehicle is washed. Wet brakes can be dangerous! Your vehicle will not stop as quickly if the brakes are wet. Wet

brakes may cause the vehicle to pull to one side.

To dry the brakes, apply the brakes lightly until the braking action returns to normal, taking care to keep the vehicle under control at all times. If the braking action does not return to normal, stop as soon as it is safe to do so and visit an authorized Kia dealer.

- Don't coast down hills with the vehicle out of gear. This is extremely hazardous. Keep the vehicle in gear at all times, use the brakes to slow down, then shift to a lower gear so that vehicle braking will help you maintain a safe speed.
- Don't "ride" the brake pedal. Resting your foot on the brake pedal while driving can be dangerous because the brakes might overheat and lose their effectiveness. It also increases the wear of the brake components.
- If a tire goes flat while you are driving, apply the brakes gently and keep the vehicle pointed straight ahead while you slow down. When you are moving slowly enough for it to be safe to do so, pull off the road and stop in a safe place.
- Be cautious when parking on a hill. Firmly engage the parking brake and place the shift lever in P. If your vehicle is facing downhill, turn the front wheels into the

curb to help keep the vehicle from rolling.

If your vehicle is facing uphill, turn the front wheels away from the curb to help keep the vehicle from rolling. If there is no curb or if it is required by other conditions to keep the vehicle from rolling, block the wheels.

- Under some conditions your parking brake can freeze in the engaged position. This is most likely to happen when there is an accumulation of snow or ice around or near the rear brakes or if the brakes are wet. If there is a risk that the parking brake may freeze, apply it only temporarily while you put the shift lever in P (Parking) and block the rear wheels so the vehicle cannot roll. Then release the parking brake.
- Do not hold the vehicle on an incline with the accelerator pedal. This can cause the transmission to overheat. Always use the brake pedal or parking brake.

Vehicle Auto Shut-off system (if equipped)

To prevent carbon dioxide poisoning, the Vehicle Auto Shut-off system is designed to automatically turn the engine off approximately 60 minutes later to reduce fuel and energy consumption of the vehicle. The timer appears on the LCD display approximately 30 minutes before it turns off automatically.

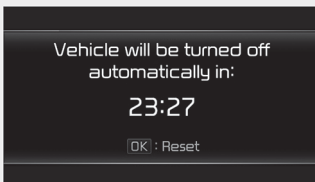

0MQ4A050356

Operating conditions

- The driver has not fastened a seat belt
- A passenger is not in the passenger's seat
- The vehicle speed is under 3 km/h (2 mph) and the shift lever is in P (Park) position
- The brake or accelerator pedal is not operated
- The infotainment system update is being performed

Timer reset conditions

- The accelerator or brake pedal is released after the operation
- OK button on the steering wheel is pressed while the timer appears on the LCD display

Off conditions

- The driver has fastened the seat belt
- A passenger is in the passenger's seat
- Driving over 3 km/h (2 mph)
- Shifting the gear in R (Reverse), N (Neutral) or D (Drive)

CAUTION

Please do not leave a passenger or a pet in the vehicle since the air conditioning system stops when the engine is off.

Drive mode integrated control system

Drive mode

The drive mode may be selected according to the driver's preference or road condition.



* NOTICE

If there is a problem with the instrument cluster, the drive mode will be in NORMAL mode and may not change to ECO mode or SPORT mode.

The mode changes when you toggle the DRIVE MODE button.

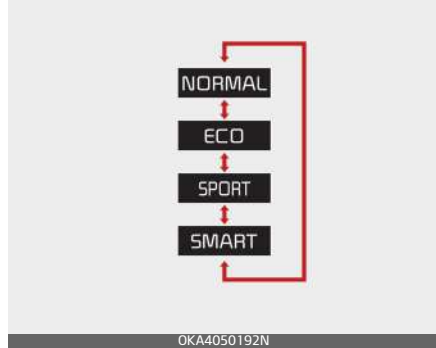

When NORMAL mode is selected, it is not displayed on the instrument cluster.

- ECO mode :
ECO mode helps improve fuel efficiency for eco-friendly driving.
- NORMAL mode :
NORMAL mode provides smooth driving and comfortable riding.
- SPORT mode :
SPORT mode provides sporty but firm riding.

The drive mode will change to NORMAL mode when the engine is restarted. However, except when it is in ECO mode and SMART mode. ECO mode and SMART mode will be maintained, as selected when the engine is restarted.

When changing the drive mode setting, the responsiveness of Smart Cruise Control (SCC) changes. (If equipped)

Drive Mode	SCC Responsiveness
NORMAL	Normal
ECO	Slow
SPORT	Fast
SMART	Normal

ECO mode

ECO When the Drive Mode is set to ECO mode, the engine and transmission control logic are changed to maximize fuel efficiency.

- When the ECO mode is selected by using the DRIVE MODE button, the ECO indicator will illuminate.
- Whenever the engine is restarted, the drive mode remains in ECO mode.

*** NOTICE**

Fuel efficiency depends on the driver's driving habit and road condition.

When ECO mode is activated:

- The acceleration response may be slightly reduced as the accelerator pedal is depressed moderately.
- The air conditioner performance may be limited.
- The shift pattern of the automatic transmission may change.
- The engine noise may get louder.

The above situations are normal conditions when ECO mode is activated to improve fuel efficiency.

Limitation of ECO mode operation:

If the following conditions occur while ECO mode is operating, the system operation is limited even though there is no change in ECO indicator.

- When the coolant temperature is low:
The system will be limited until engine performance becomes normal.
- When driving up a hill:
The system will be limited to gain power when driving uphill because engine torque is restricted.
- When the accelerator pedal is deeply depressed for a few seconds:
The system will be limited, judging that the driver wants to speed up.

SPORT mode

SPORT SPORT mode manages the driving dynamics by automatically adjusting the steering effort, the engine and transmission control logic for enhanced driver performance.

- When SPORT mode is selected by using the DRIVE MODE button, the SPORT indicator will illuminate.
- Whenever the engine is restarted, the Drive Mode will revert back to

NORMAL mode. If SPORT mode is desired, re-select SPORT mode from the DRIVE MODE button.

- When SPORT mode is activated:
 - The engine rpm will tend to remain raised over a certain length of time even after releasing the accelerator
 - Upshifts are delayed when accelerating

* NOTICE

In SPORT mode, the fuel efficiency may decrease.

SMART mode

SMART SMART mode selects the proper driving mode among ECO, NORMAL, and SPORT by judging the driver's driving habits (i.e. Economic or Aggressive (Sportive)) from the brake pedal depression or the steering wheel operation.

- Toggle the DRIVE MODE button to select SMART mode. When SMART mode is selected, the indicator illuminates on the instrument cluster.
- SMART mode automatically controls the vehicle driving, such as gear shifting patterns and engine torque, in accordance with the driver's driving habits.

* NOTICE

- When you mildly drive the vehicle in SMART mode, the driving mode changes to ECO mode to improve fuel efficiency. However, the actual fuel efficiency may differ in accordance with your driving situations (i.e. upward/downward slope, vehicle deceleration/acceleration).
- When you dynamically drive the vehicle in SMART mode by abruptly decelerating or sharply turning the driving mode changes to SPORT mode. However, it may adversely affect fuel economy.

Various driving situations, which you may encounter in SMART mode

- The driving mode automatically changes to ECO mode after a certain period of time, when you gently depress the accelerator pedal. (Your driving is categorized to be economic.)
- The driving mode automatically changes from SMART ECO mode to SMART COMFORT mode after a certain period of time, when you sharply or repetitively depress the accelerator pedal.
- The driving mode automatically changes to SMART COMFORT mode with the same driving patterns, when the vehicle starts to drive on an upward slope of a certain angle. The driving mode

automatically returns to SMART ECO mode, when the vehicle enters a leveled road.

- The driving mode automatically changes to SMART SPORT, when you abruptly accelerate the vehicle or repetitively operate the steering wheel. (Your driving is categorized to be sporty.) In this mode, your vehicle drives in a lower gear for abrupt accelerating/decelerating and increases the engine brake performance.
- You may still sense the engine braking performance, even when you release the accelerator pedal in SMART SPORT mode. It is because your vehicle remains in lower gear over a certain period of time for next acceleration. Thus, it is a normal driving situation, not indicating any malfunction.
- The driving mode automatically changes to SMART SPORT mode only in harsh driving situations. In most of the normal driving situations, the driving mode sets to be either in SMART ECO mode or in SMART COMFORT mode.

Limitation of SMART mode

The SMART mode may be limited in following situations. (The OFF indicator illuminates in those situations.)

- Cruise Control is activated:
Cruise Control system may deactivate the SMART mode when the vehicle is controlled by the set speed of Smart Cruise Control system. (SMART mode is not deactivated just by activating Cruise Control system.)
- The transmission oil temperature is either extremely low or extremely high:
The SMART mode can be active in most of the normal driving situations. However, an extremely high/ low transmission oil temperature may temporarily deactivate the SMART mode, because the transmission condition is out of normal operation condition.

Forward Collision-Avoidance Assist (FCA) (Front view camera only) (if equipped)

Basic function



Forward Collision-Avoidance Assist is designed to help detect and monitor the vehicle ahead or help detect a pedestrian in the roadway and warn the driver that a collision is imminent with a warning message and an audible warning, and if necessary, apply emergency braking.

Detecting sensor

Front view camera



⚠ CAUTION

Take the following precautions to maintain optimal performance of the detecting sensor:

- Never disassemble the detecting sensor or sensor assembly, or apply any impact on it.
- Never install any accessories or stickers on the front windshield, or tint the front windshield.
- If the detecting sensors have been replaced or repaired, have the vehicle be inspected by an authorized Kia dealer.
- Pay extreme caution to keep the front view camera dry.
- Never place any reflective objects (i.e. white paper, mirror) over the dashboard. Any light reflection may prevent the function from functioning properly.

Function settings

Setting

Forward Safety

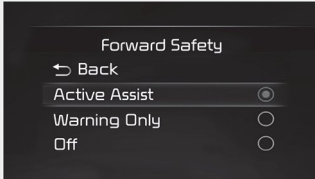

OMQ4AH050344

With the ENGINE START/STOP button in the ON position, select or deselect 'Driver Assistance → Forward Safety' from the Settings menu to set whether or not to use each function.

- If 'Active Assist' is selected, the function will warn the driver with a warning message, an audible warning and steering wheel vibration depending on the collision risk levels. Braking assist will be applied depending on the collision risk.
- If 'Warning Only' is selected, the function will warn the driver with a warning message, an audible warning and steering wheel vibration depending on the collision risk levels. Braking will not be assisted.

- If 'Off' is selected, the function will be turned off. The  warning light will illuminate on the cluster.

The driver can monitor Forward Collision-Avoidance Assist ON/OFF status from the Settings menu. If the  warning light remains ON when the function is ON, have the function be inspected by an authorized Kia dealer.

WARNING

When the engine is restarted, Forward Collision-Avoidance Assist will always turn on. However, if 'Off' is selected after the engine is restarted, the driver should always be aware of the surroundings and drive safely.

CAUTION

If 'Warning Only' is selected, braking is not assisted.

NOTICE

Forward Collision-Avoidance Assist will turn off when ESC is turned off by pressing and holding the ESC OFF button. The  warning light will illuminate on the cluster.

Warning timing



With the ENGINE START/STOP button in the ON position, select 'Driver Assistance → Warning Timing' from the Settings menu to change the initial warning activation time for Forward Collision-Avoidance Assist.

When the vehicle is first delivered, Warning Timing is set to 'Normal'. If you change the Warning Timing, the warning time of other Driver Assistance systems may change.

Warning volume

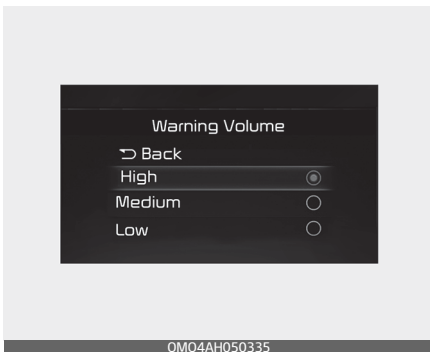

With the ENGINE START/STOP button in the ON position, select 'Driver

Assistance → Warning Volume' from the Settings menu to change the Warning Volume to 'High', 'Medium', 'Low' or 'Off' for Forward Collision-Avoidance Assist.

However, even if 'Off' is selected, the function's Warning Volume will not turn off but the volume will sound as 'Low'.

If you change the warning volume, the Warning Volume of other Driver Assistance systems may change.

⚠ CAUTION

- The setting of the Warning Timing and Warning Volume applies to all functions of Forward Collision-Avoidance Assist.
- Even though 'Normal' is selected for Warning Timing, if the front vehicle suddenly stops, the initial warning activation time may seem late.
- Select 'Late' for Warning Timing when traffic is light and when driving speed is slow.

* NOTICE

If the engine is restarted, Warning Timing and Warning Volume will maintain the last setting.

Function operation

Basic function

Function warning and control

The basic function for Forward Collision-Avoidance Assist is to warn and control the vehicle depending on the collision level: 'Collision Warning', 'Emergency Braking' and 'Stopping vehicle and ending brake control'.

Collision warning



OKA4050134L

- To warn the driver of a collision, the 'Collision Warning' warning message will appear on the cluster, an audible warning will sound and the steering wheel will vibrate.
- If a vehicle is detected in front, the function will operate when your vehicle speed is between approximately 10 ~ 180 km/h (6 ~ 112 mph).
- If a pedestrian is detected in front, the function will operate

when your vehicle speed is between approximately 10 ~ 60 km/h (6 ~ 37 mph).

- If 'Active Assist' is selected, braking may be assisted.

Emergency braking

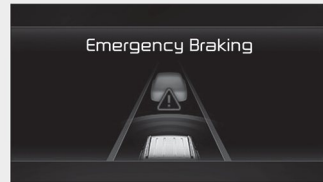

OKA4050135L

- To warn the driver that emergency braking will be assisted, the 'Emergency Braking' warning message will appear on the cluster, an audible warning will sound and the steering wheel will vibrate.
- If a vehicle is detected in front, the function will operate when your vehicle speed is between approximately 10 ~ 60 km/h (6 ~ 37 mph).
- If a pedestrian is detected in front, the function will operate when your vehicle speed is between approximately 10 ~ 60 km/h (6 ~ 37 mph).
- In emergency braking situation, braking is assisted with strong braking power by the function to

help prevent collision with the vehicle or pedestrian.

Stopping vehicle and ending brake control



- When the vehicle is stopped due to emergency braking, the 'Drive carefully' warning message will appear on the cluster.
- For your safety, the driver should depress the brake pedal immediately and check the surroundings.
- Brake control will end after the vehicle is stopped by emergency braking for approximately 2 seconds.

⚠ WARNING

- For your safety, change the Settings after parking the vehicle at a safe location.
- With 'Active Assist' or 'Warning Only' selected, when ESC is turned off by pressing and holding the ESC OFF button, Forward Collision-Avoidance Assist will turn off

automatically. In this case, the function cannot be set from the Settings menu and the warning light will illuminate on the cluster which is normal. If ESC is turned on by pressing the ESC OFF button, Forward Collision-Avoidance Assist will maintain the last setting.

- Forward Collision-Avoidance Assist does not operate in all situations or cannot avoid all collisions.
- The driver should hold the responsibility to control the vehicle. Do not solely depend on Forward Collision-Avoidance Assist. Rather, maintain a safe braking distance, and if necessary, depress the brake pedal to reduce driving speed or to stop the vehicle.
- Never deliberately operate Forward Collision-Avoidance Assist on people, animal, objects, etc. It may cause serious injury or death.
- Forward Collision-Avoidance Assist may not operate if the driver depresses the brake pedal to avoid collision.
- Depending on the road and driving conditions, Forward Collision-Avoidance Assist may warn the driver late or may not warn the driver.
- During Forward Collision-Avoidance Assist operation, the vehicle may stop suddenly injuring pas-

sengers and shifting loose objects. Always have the seat belt on and keep loose objects secured.

- If any other function's warning message is displayed or audible warning is generated, Forward Collision-Avoidance Assist warning message may not be displayed and audible warning may not be generated.
- You may not hear the warning sound of Forward Collision-Avoidance Assist if the surrounding is noisy.
- Forward Collision-Avoidance Assist may turn off or may not operate properly or may operate unnecessarily depending on the road conditions and the surroundings.

* NOTICE

- Even if there is a problem with Forward Collision-Avoidance Assist, the vehicle's basic braking performance will operate normally.
- During emergency braking, braking control by the function will automatically cancel when the driver excessively depresses the accelerator pedal or sharply steers the vehicle.

⚠ CAUTION

Depending on the condition of the vehicle, pedestrian in front and the surroundings, the speed range to operate Forward Collision-Avoidance Assist may reduce. The function may only warn the driver, or the function may not operate.

* NOTICE

In a situation collision is imminent, braking may be assisted by Forward Collision-Avoidance Assist when braking is insufficient by the driver.

Malfunction and limitations

Malfunction

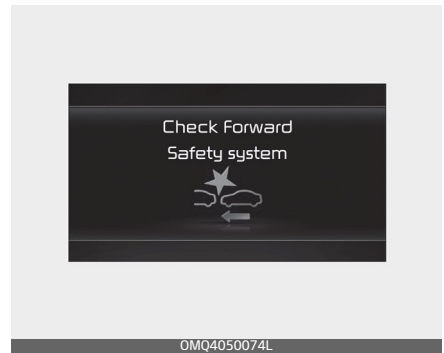

When Forward Collision-Avoidance Assist is not working properly, the 'Check Forward Safety system' warning message will appear, and the (⚠) and (🚗💥) warning lights will illuminate on the cluster. Have

the function be inspected by an authorized Kia dealer.

Function disabled



When the front windshield where the front view camera is located, is covered with foreign material, such as snow or rain, it can reduce the detecting performance and temporarily limit or disable Forward Collision-Avoidance Assist.

If this occurs, the 'Forward Safety Function disabled. Camera obscured' warning message, and the (⚠) and (🚗💧) warning lights will illuminate on the cluster.

The function will operate normally when snow, rain or foreign matter is removed. Always keep it clean.

If the function does not operate normally after obstruction (snow, rain, or foreign material) is removed, have the function be inspected by an authorized Kia dealer.

*** NOTICE**

- Even though the warning message or warning light does not appear on the cluster, Forward Collision-Avoidance Assist may not properly operate.
- Forward Collision-Avoidance Assist may not properly operate in an area (e.g. open terrain), where any substance are not detected after turning ON the engine.

Limitations

Forward Collision-Avoidance Assist may not operate normally, or the function may operate unexpectedly under the following circumstances:

- The detecting sensor or the surroundings are contaminated or damaged
- The temperature around the front view camera is high or low
- The camera lens is contaminated due to tinted, filmed or coated windshield, damaged glass, or stuck of foreign material (sticker, bug, etc.) on the glass
- Moisture is not removed or frozen on the windshield
- Washer fluid is continuously sprayed, or the wiper is on
- Driving in heavy rain or snow, or thick fog
- The field of view of the front view camera is obstructed by sun glare

Driving your vehicle

- Street light or light from an oncoming vehicle is reflected on the wet road surface, such as a puddle on the road
- An object is placed on the dashboard
- Your vehicle is being towed
- The surrounding is very bright
- The surrounding is very dark, such as in a tunnel, etc.
- The brightness changes suddenly, for example when entering or exiting a tunnel
- The brightness outside is low, and the headlamps are not on or are not bright
- Driving through steam, smoke or shadow
- Only part of the vehicle, pedestrian is detected
- The vehicle in front is a bus, heavy truck, truck with a unusually shaped luggage, trailer, etc.
- The vehicle in front has no taillamps, taillamps are located unusually, etc.
- The brightness outside is low, and the taillamps are not on or are not bright
- The rear of the front vehicle is small or the vehicle does not look normal, such as when the vehicle is tilted, overturned, or the side of the vehicle is visible, etc.
- The front vehicle's ground clearance is low or high
- A vehicle or pedestrian suddenly cuts in front

Forward Collision-Avoidance Assist (FCA) (Front view camera only)

- The vehicle in front is detected late
- The vehicle in front is suddenly blocked by an obstacle
- The vehicle in front suddenly changes lane or suddenly reduces speed
- The vehicle in front is bent out of shape
- The front vehicle's speed is fast or slow
- The vehicle in front steers in the opposite direction of your vehicle to avoid a collision
- With a vehicle in front, your vehicle changes lane at low speed
- The vehicle in front is covered with snow
- You are departing or returning to the lane
- Unstable driving
- You are on a roundabout and the vehicle in front is not detected
- You are continuously driving in a circle
- The vehicle in front has an unusual shape
- The vehicle in front is driving uphill or downhill.
- The pedestrian is not fully detected, for example, if the pedestrian is leaning over or is not fully walking upright
- The pedestrian is wearing clothing or equipment that makes it difficult to detect as a pedestrian

Following image shows the image the sensor recognizes as vehicle and pedestrian.



- The pedestrian in front is moving very quickly
- The pedestrian in front is short or is posing a low posture
- The pedestrian in front has impaired mobility
- The pedestrian in front is moving intersected with the driving direction
- There is a group of pedestrians or a large crowd in front
- The pedestrian is wearing clothing that easily blends into the background, making it difficult to detect
- The pedestrian is difficult to distinguish from the similar shaped structure in the surroundings
- You are driving by a pedestrian, traffic signs, structures, etc. near the intersection
- You are driving by a pedestrian, traffic signs, structures, etc. near the intersection
- Driving in a parking lot

- Driving through a tollgate, construction area, unpaved road, partial paved road, uneven road, speed bumps, etc.
- Driving on an incline road, curved road, etc.
- Driving through a roadside with trees or streetlights
- The adverse road conditions cause excessive vehicle vibrations while driving
- Your vehicle height is low or high due to heavy loads, abnormal tire pressure, etc.
- Driving through a narrow road where trees or grass or overgrown
- There is interference by electromagnetic waves, such as driving in an area with strong radio waves or electrical noise

⚠ WARNING

- Driving on a curve

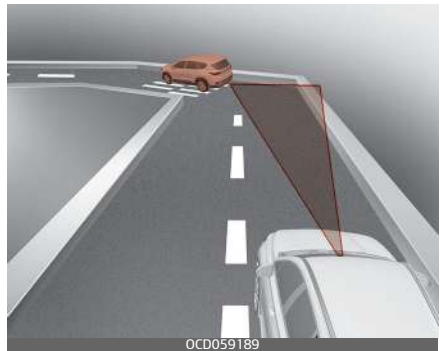

Driving your vehicle

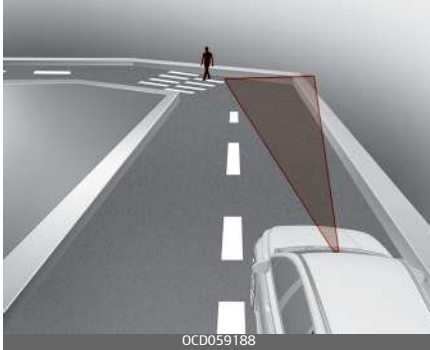

Forward Collision-Avoidance Assist may not detect other vehicles, pedestrians in front of you on curved roads adversely affecting the performance of the sensors. This may result in no warning, braking assist or steering assist when necessary. When driving on a curve, you must maintain a safe braking distance, and if necessary, steer the vehicle and depress the brake pedal to reduce your driving speed in order to maintain a safe distance.

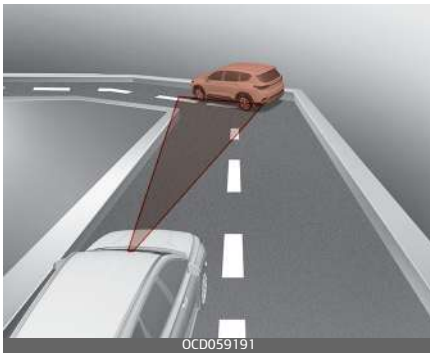

Forward Collision-Avoidance Assist (FCA) (Front view camera only)

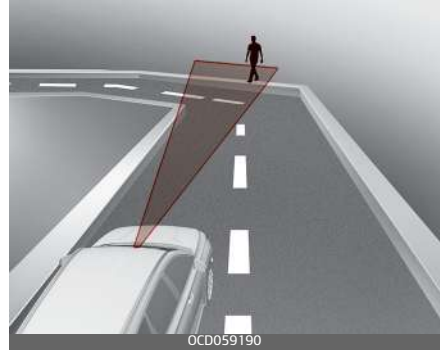

Forward Collision-Avoidance Assist may detect a vehicle, pedestrian in the next lane or outside the lane when driving on a curved road.

If this occurs, the function may unnecessarily warn the driver and control the brake or steering wheel. Always check the traffic conditions around the vehicle.

- Driving on a slope





Forward Collision-Avoidance Assist may not detect other vehicles, pedestrians in front of you while driving uphill or downhill adversely affecting the performance of the sensors.

This may result in unnecessary warning, braking assist or steering assist or no warning, braking assist or steering assist when necessary.

Also, vehicle speed may rapidly decrease when a vehicle or pedestrian ahead is suddenly detected. Always have your eyes on the road while driving uphill or downhill and if necessary, steer your vehicle and depress the brake pedal to reduce your driving speed in order to maintain a safe distance.

- Changing lanes

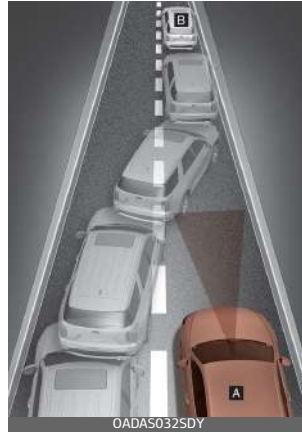

[A]: Your vehicle

[B]: Lane changing vehicle

When a vehicle [B] moves into your lane from an adjacent lane, it cannot be detected by the sensor until it is in the sensor's detection range. Forward Collision-Avoidance Assist may not immediately detect the vehicle when the vehicle changes lanes abruptly. In this case, you must maintain a safe braking distance, and if necessary, steer your vehicle and depress the brake pedal to reduce your driving speed in order to maintain a safe distance.

Driving your vehicle



[A]: Your vehicle

[B]: Lane changing vehicle,

[C]: Same lane vehicle

When a vehicle [B] in front of you merges out of the lane, Forward Collision-Avoidance Assist may not immediately detect the vehicle [C] that is now in front of you. In this case, you must maintain a safe braking distance, and if necessary, steer your vehicle and depress the brake pedal to reduce your driving speed in order to maintain a safe distance.

Forward Collision-Avoidance Assist (FCA) (Front view camera only)

- Detecting vehicle

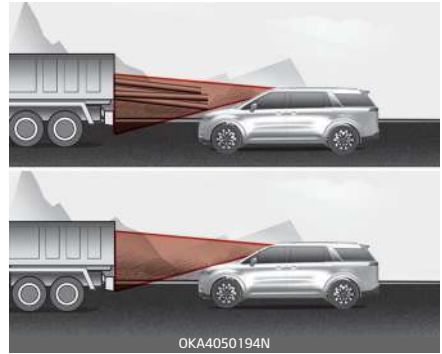

If the vehicle in front of you has cargo that extends rearward from the cab, or when the vehicle in front of you has higher ground clearance, additional special attention is required. Forward Collision-Avoidance Assist may not be able to detect the cargo extending from the vehicle. In these instances, you must maintain a safe braking distance from the rearmost object, and if necessary, steer your vehicle and depress the brake pedal to reduce your driving speed in order to maintain distance.

⚠ WARNING

- When you are towing a trailer or another vehicle, we recommend that Forward Collision-Avoidance Assist is turned off due to safety reasons.
 - Forward Collision-Avoidance Assist may operate if objects that are similar in shape or characteristics to vehicles and pedestrians are detected.
 - Forward Collision-Avoidance Assist does not operate on motorcycles, or smaller wheeled objects, such as luggage bags, shopping carts, or strollers that are dragged by a pedestrian.
 - Forward Collision-Avoidance Assist may not operate normally if interfered by strong electromagnetic waves.
 - Forward Collision-Avoidance Assist may not operate for approximately 15 seconds after the vehicle is started, or the front view camera is initialized.
-

This device complies with Industry Canada licence-exempt RSS standard(s).

Operation is subject to the following conditions:

1. This device may not cause interference, and
2. This device must accept any interference, including interference that may cause undesired operation of the device.
3. Changes or modifications not expressly approved by the party responsible for compliance could void the user's authority to operate the device.

Forward Collision-Avoidance Assist (FCA) (Sensor fusion) (if equipped)

Basic function

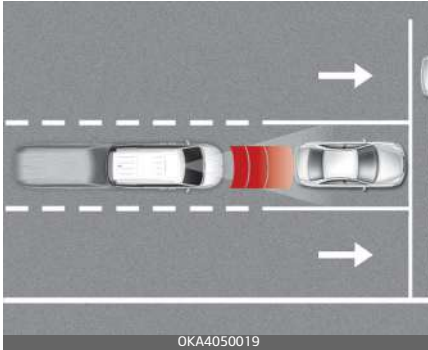

Forward Collision-Avoidance Assist is designed to help detect and monitor the vehicle ahead or help detect a pedestrian or cyclist in the roadway and warn the driver that a collision is imminent with a warning message and an audible warning, and if necessary, apply emergency braking.

Junction Turning function (if equipped)

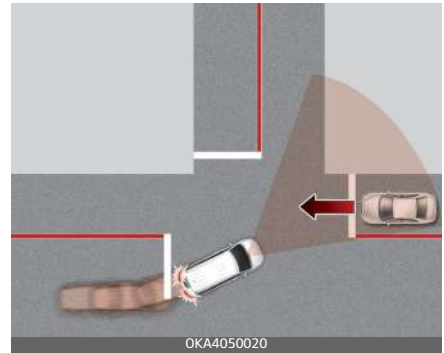

Junction Turning function will help avoid a collision with an oncoming vehicle in an adjacent lane when turning left at a crossroad with the turn signal on by applying emergency braking.

Detecting sensor

Front view camera



Front radar



Refer to the picture above for the detailed location of the detecting sensors.

⚠ CAUTION

Take the following precautions to maintain optimal performance of the detecting sensor:

- Never disassemble the detecting sensor or sensor assembly, or apply any impact on it.
- If the detecting sensors have been replaced or repaired, have the vehicle be inspected by an authorized Kia dealer.
- Never install any accessories or stickers on the front windshield, or tint the front windshield.
- Pay extreme caution to keep the front view camera dry.
- Never place any reflective objects (i.e. white paper, mirror) over the dashboard. Any light reflection may prevent the function from functioning properly.

- Do not apply license plate frame or objects, such as a bumper sticker, film or a bumper guard, near the front radar cover.
 - Always keep the front radar and cover clean and free of dirt and debris. Use only a soft cloth to wash the vehicle. Do not spray pressurized water directly on the sensor or sensor cover.
 - If unnecessary force has been applied to the radar or around the radar, Forward Collision-Avoidance Assist may not properly operate even though a warning message does not appear on the cluster. Have the vehicle be inspected by an authorized Kia dealer.
 - Use only genuine parts to repair or replace a damaged front radar cover. Do not apply paint to the front radar cover.
-

Function settings

Setting

Forward Safety

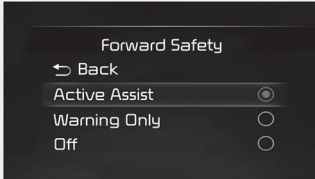

OMQ4AH050344

With the engine on, select or deselect 'Driver Assistance → Forward Safety' from the Settings menu to set whether or not to use each function.

- If 'Active Assist' is selected, the function will warn the driver with a warning message and an audible warning depending on the collision risk levels. Braking assist will be applied depending on the collision risk.
- If 'Warning Only' is selected, the function will warn the driver with a warning message and an audible warning depending on the collision risk levels. Braking will not be assisted.
- If 'Off' is selected, the function will turn off. The  warning light will illuminate on the cluster.

The driver can monitor Forward Collision-Avoidance Assist ON/OFF status from the Settings menu. If the  warning light remains ON when the function is ON, have the function be inspected by an authorized Kia dealer.

⚠ WARNING

When the engine is restarted, Forward Collision-Avoidance Assist will always turn on. However, if 'Off' is selected after the engine is restarted, the driver should always be aware of the surroundings and drive safely.

⚠ CAUTION

- If 'Warning Only' is selected, braking is not assisted.
- The settings for Forward Safety include 'Basic function' and 'Junction Turning' (if equipped).

* NOTICE

Forward Collision-Avoidance Assist will turn off when ESC is turned off by pressing and holding the ESC OFF button for more than 3 seconds.

The  warning light will illuminate on the cluster.

Warning timing



With the engine on, select 'Driver Assistance → Warning Timing' from the Settings menu to change the initial warning activation time for Forward Collision-Avoidance Assist.

When the vehicle is first delivered, Warning Timing is set to 'Normal'.

If you change the Warning Timing, the warning time of other Driver Assistance systems may change.

Warning volume

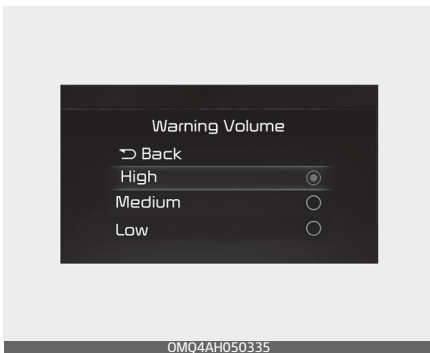

With the engine on, select 'Driver Assistance → Warning Volume' from the Settings menu to change the

Warning Volume to 'High', 'Medium', or 'Low' for Forward Collision-Avoidance Assist.

If you change the warning volume, the Warning Volume of other Driver Assistance systems may change.

⚠ CAUTION

- The setting of the Warning Timing and Warning Volume applies to all functions of Forward Collision-Avoidance Assist.
- Even though 'Normal' is selected for Warning Timing, if the front vehicle suddenly stops, the initial warning activation time may not seem late.
- Select 'Late' for Warning Timing when traffic is light and when driving speed is slow.

* NOTICE

If the engine is restarted, Warning Timing and Warning Volume will maintain the last setting.

Function operation

Basic function

Function warning and control

The basic function for Forward Collision-Avoidance Assist is to warn and control the vehicle depending on the

collision level: 'Collision Warning', 'Emergency Braking' and 'Stopping vehicle and ending brake control'.

Collision warning



OKA4050134L

- To warn the driver of a collision, the 'Collision Warning' warning message will appear on the cluster and an audible warning will sound.
- If a vehicle is detected in front, the function will operate when your vehicle speed is between approximately 10 ~ 180 km/h (6 ~ 112 mph).
- If a pedestrian or cyclist is detected in front, the function will operate when your vehicle speed is between approximately 10 ~ 85 km/h (6 ~ 53 mph).
- If 'Active Assist' is selected, braking may be assisted.

Emergency braking



OKA4050135L

- To warn the driver that emergency braking will be assisted, the 'Emergency Braking' warning message will appear on the cluster and an audible warning will sound.
- If a vehicle is detected in front, the function will operate when your vehicle speed is between approximately 10 ~ 75 km/h (6 ~ 47 mph).
- If a pedestrian or cyclist is detected in front, the function will operate when your vehicle speed is between approximately 10 ~ 65 km/h (6 ~ 40 mph).
- In emergency braking situation, braking is assisted with strong braking power by the function to help prevent collision with the vehicle, pedestrian or cyclist ahead.

Stopping vehicle and ending brake control



- When the vehicle is stopped due to emergency braking, the 'Drive carefully' warning message will appear on the cluster. For your safety, the driver should depress the brake pedal immediately and check the surroundings.
- Brake control will end after the vehicle is stopped by emergency braking for approximately 2 seconds.

Junction Turning function (if equipped)

Function warning and control

Junction Turning function will help warn and control the vehicle depending on the collision level: 'Collision Warning', 'Emergency Braking' and 'Stopping vehicle and ending brake control'.

Collision warning



- To warn the driver of a collision, the 'Collision Warning' warning message will appear on the cluster and an audible warning will sound.
- The function will operate when your vehicle speed is between approximately 10 ~ 30 km/h (6 ~ 19 mph) and the oncoming vehicle speed is between approximately 30 ~ 70 km/h (19 ~ 44 mph).
- If 'Active Assist' is selected, braking may be assisted.

Emergency braking



- To warn the driver that emergency braking will be assisted, the 'Emergency Braking' warning message will appear on the cluster, an audible warning will sound and the steering wheel will vibrate.
- The function will operate when your vehicle speed is between approximately 10 ~ 30 km/h (6 ~ 19 mph) and the oncoming vehicle speed is between approximately 30 ~ 70 km/h (19 ~ 44 mph).
- In emergency braking situation, braking is assisted with strong braking power by the function to help prevent collision with the oncoming vehicle.

* NOTICE

If the driver's seat is on the left side, Junction Turning function will operate only when the driver turns left. If the driver's seat position is on right side, the function will operate only when you turn right.

Stopping vehicle and ending brake control



- When the vehicle is stopped due to emergency braking, the 'Drive carefully' warning message will appear on the cluster. For your safety, the driver should depress the brake pedal immediately and check the surroundings.
- Brake control will end after the vehicle is stopped by emergency braking for approximately 2 seconds.

⚠ WARNING

Take the following precautions when using Forward Collision-Avoidance Assist:

- For your safety, change the Settings after parking the vehicle at a safe location.
- With 'Active Assist' or 'Warning Only' selected, when ESC is turned off by pressing and holding the ESC OFF button for more than 3 seconds, Forward Collision-Avoid-

ance Assist will turn off automatically. In this case, the function cannot be set from the Settings menu and the  warning light will illuminate on the cluster which is normal. If ESC is turned on by pressing the ESC OFF button, Forward Collision-Avoidance Assist will maintain the last setting.

- Forward Collision-Avoidance Assist does not operate in all situations or cannot avoid all collisions.
- The driver should hold the responsibility to control the vehicle. Do not solely depend on Forward Collision-Avoidance Assist. Rather, maintain a safe braking distance, and if necessary, depress the brake pedal to reduce driving speed or to stop the vehicle.
- Never deliberately operate Forward Collision-Avoidance Assist on people, animal, objects, etc. It may cause serious injury or death.
- Forward Collision-Avoidance Assist may not operate if the driver depresses the brake pedal to avoid collision.
- Depending on the road and driving conditions, Forward Collision-Avoidance Assist may warn the driver late or may not warn the driver.

- During Forward Collision-Avoidance Assist operation, the vehicle may stop suddenly injuring passengers and shifting loose objects. Always have the seat belt on and keep loose objects secured.
- If any other function's warning message is displayed or audible warning is generated, Forward Collision-Avoidance Assist warning message may not be displayed and audible warning may not be generated.
- You may not hear the warning sound of Forward Collision-Avoidance Assist if the surrounding is noisy.
- Forward Collision-Avoidance Assist may turn off or may not operate properly or may operate unnecessarily depending on the road conditions and the surroundings.

 **WARNING**

- Even if there is a problem with Forward Collision-Avoidance Assist, the vehicle's basic braking performance will operate normally.
- During emergency braking, braking control by the function will automatically cancel when the driver excessively depresses the

accelerator pedal or sharply steers the vehicle.

⚠ CAUTION

- Forward Collision-Avoidance Assist operating speed range may reduce due to the conditions of the vehicle or pedestrian in front or surroundings. Depending on the speed, the function may only warn the driver, or the function may not operate.
- Forward Collision-Avoidance Assist will operate under certain conditions by judging the risk level based on the condition of the oncoming vehicle, driving direction, speed and surroundings.

*** NOTICE**

In a situation collision is imminent, braking may be assisted by Forward Collision-Avoidance Assist when braking is insufficient by the driver.

Malfunction and limitations

Malfunction

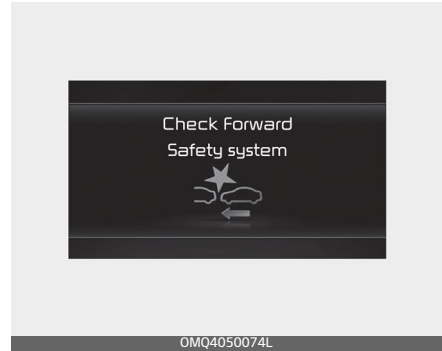

When Forward Collision-Avoidance Assist is not working properly, the 'Check Forward Safety system(s)' warning message will appear, and the (🚗) and (⚠) warning lights will illuminate on the cluster. Have the function be inspected by an authorized Kia dealer.

Function disabled

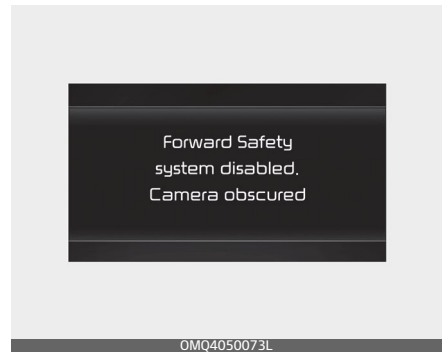

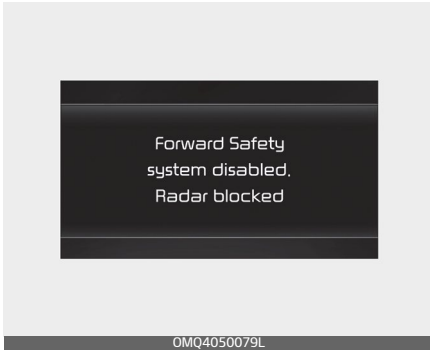

When the front windshield where the front view camera is located, front radar cover or sensor is covered with foreign material, such as snow or rain, it can reduce the detecting performance and temporarily limit or disable Forward Collision-Avoidance Assist.

If this occurs the 'Forward Safety system(s) disabled. Camera obscured' or the 'Forward Safety system(s) disabled. Radar blocked' warning message, and the (⚠) and (🚗) warning lights will illuminate on the cluster.

The function will operate normally when such snow, rain or foreign material is removed.

If the function does not operate normally after obstruction (snow, rain, or foreign material) is removed, have the function be inspected by an authorized Kia dealer.

⚠ WARNING

- Even though the warning message or warning light does not appear on the cluster, Forward Collision-Avoidance Assist may not properly operate.
- Forward Collision-Avoidance Assist may not properly operate in an area (e.g. open terrain), where any substance are not detected after turning ON the engine.

Limitations

Forward Collision-Avoidance Assist may not operate normally, or the function may operate unexpectedly under the following circumstances:

- The detecting sensor or the surroundings are contaminated or damaged
- The temperature around the front view camera is high or low
- The camera lens is contaminated due to tinted, filmed or coated windshield, damaged glass, or stuck of foreign material (sticker, bug, etc.) on the glass
- Moisture is not removed or frozen on the windshield
- Washer fluid is continuously sprayed, or the wiper is on
- Driving in heavy rain or snow, or thick fog
- The field of view of the front view camera is obstructed by sun glare

- Street light or light from an oncoming vehicle is reflected on the wet road surface, such as a puddle on the road
- An object is placed on the dashboard
- Your vehicle is being towed
- The surrounding is very bright
- The surrounding is very dark, such as in a tunnel, etc.
- The brightness changes suddenly, for example when entering or exiting a tunnel
- The brightness outside is low, and the headlamps are not on or are not bright
- Driving through steam, smoke or shadow
- Only part of the vehicle, pedestrian or cyclist is detected
- The vehicle in front is a bus, heavy truck, truck with a unusually shaped luggage, trailer, etc.
- The vehicle in front has no tail lights, tail lights are located unusually, etc.
- The brightness outside is low, and the tail lamps are not on or are not bright
- The rear of the front vehicle is small or the vehicle does not look normal, such as when the vehicle is tilted, overturned, or the side of the vehicle is visible, etc.
- The front vehicle's ground clearance is low or high
- A vehicle, pedestrian or cyclist suddenly cuts in front
- The bumper around the front radar is impacted, damaged or the front radar is out of position
- The temperature around the front radar is high or low
- Driving through a tunnel or iron bridge
- Driving in large areas where there are few vehicles or structures (i.e. desert, meadow, suburb, etc.)
- Driving near areas containing metal substances, such as a construction zone, railroad, etc.
- A material is near that reflects very well on the front radar, such as a guardrail, nearby vehicle, etc.
- The cyclist in front is on a bicycle made of material that does not reflect on the front radar
- The vehicle in front is detected late
- The vehicle in front is suddenly blocked by an obstacle
- The vehicle in front suddenly changes lane or suddenly reduces speed
- The vehicle in front is bent out of shape
- The front vehicle's speed is fast or slow
- The vehicle in front steers in the opposite direction of your vehicle to avoid a collision
- With a vehicle in front, your vehicle changes lane at low speed
- The vehicle in front is covered with snow

Driving your vehicle

- You are departing or returning to the lane
- Unstable driving
- You are on a roundabout and the vehicle in front is not detected
- You are continuously driving in a circle
- The vehicle in front has an unusual shape
- The vehicle in front is driving uphill or downhill
- The pedestrian or cyclist is not fully detected, for example, if the pedestrian is leaning over or is not fully walking upright
- The pedestrian or cyclist is wearing clothing or equipment that makes it difficult to detect as a pedestrian or cyclist

The illustration above shows the image the front view camera will detect as a vehicle, pedestrian and cyclist.



- The pedestrian or cyclist in front is moving very quickly
- The pedestrian or cyclist in front is short or is posing a low posture
- The pedestrian or cyclist in front has impaired mobility

Forward Collision-Avoidance Assist (FCA) (Sensor fusion)

- The pedestrian or cyclist in front is moving intersected with the driving direction
- There is a group of pedestrians, cyclists or a large crowd in front
- The pedestrian or cyclist is wearing clothing that easily blends into the background, making it difficult to detect
- The pedestrian or cyclist is difficult to distinguish from the similar shaped structure in the surroundings
- You are driving by a pedestrian, cyclist, traffic signs, structures, etc. near the intersection
- Driving in a parking lot
- Driving through a tollgate, construction area, unpaved road, partial paved road, uneven road, speed bumps, etc.
- Driving on an incline road, curved road, etc.
- Driving through a roadside with trees or streetlights
- The adverse road conditions cause excessive vehicle vibrations while driving
- Your vehicle height is low or high due to heavy loads, abnormal tire pressure, etc.
- Driving through a narrow road where trees or grass or overgrown
- There is interference by electromagnetic waves, such as driving in an area with strong radio waves or electrical noise

⚠ WARNING

- Driving on a curve

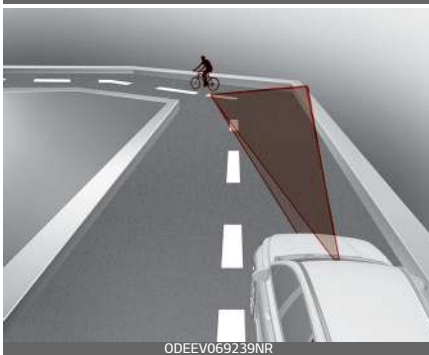
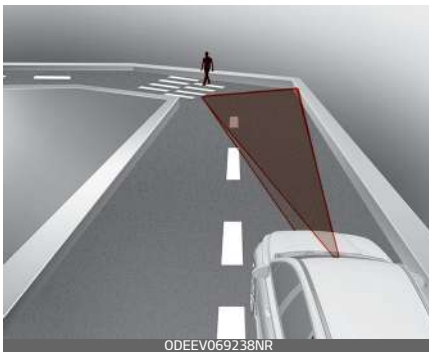
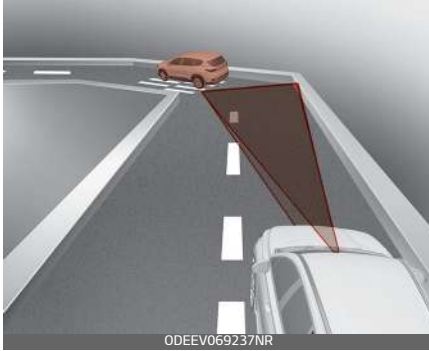

Forward Collision-Avoidance Assist may not detect other vehicles, pedestrians or cyclists in front of you on curved roads

adversely affecting the performance of the sensors. This may result in no warning or braking assist when necessary.

When driving on a curve, you must maintain a safe braking distance, and if necessary, steer the vehicle and depress the brake pedal to reduce your driving speed in order to maintain a safe distance.

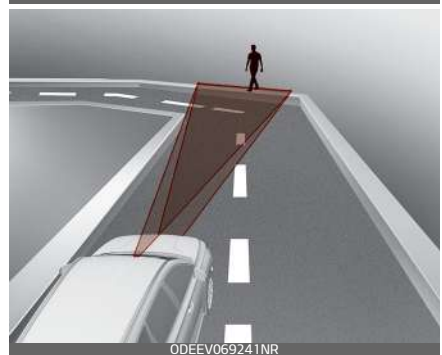
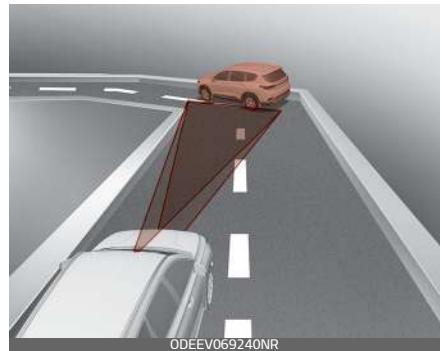

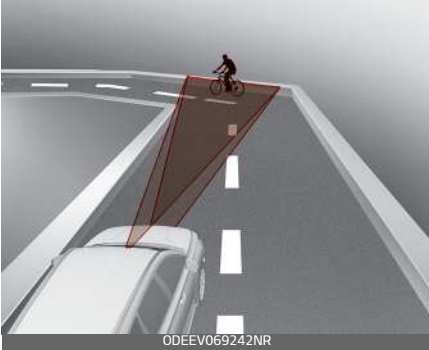

Forward Collision-Avoidance Assist may detect a vehicle, pedestrian or cyclist in the next lane or outside the lane when driving on a curved road. If this occurs, the function may unnecessarily warn the driver and control the brake. Always check the traffic conditions around the vehicle.

- Driving on a slope



Forward Collision-Avoidance Assist may not detect other vehicles, pedestrians or cyclists in front of you while driving uphill or downhill adversely affecting the performance of the sensors. This may result in unnecessary warning or braking assist, or no warning or braking assist when necessary. Also, vehicle speed may rapidly decrease when a vehicle, pedestrian or cyclist ahead is suddenly detected. Always have your eyes on the road while driving uphill or downhill and if necessary, steer your

vehicle and depress the brake pedal to reduce your driving speed in order to maintain a safe distance.

- Changing lanes

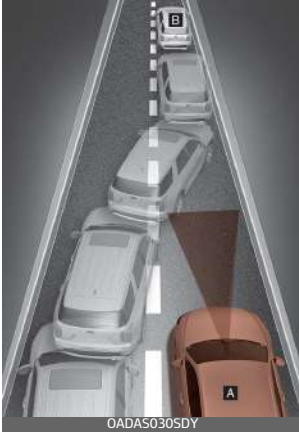

[A]: Your vehicle,
[B]: Lane changing vehicle
When a vehicle moves into your lane from an adjacent lane, it cannot be detected by the sensor until it is in the sensor's detection range. Forward Collision-Avoidance Assist may not immediately detect the vehicle when the vehicle changes lanes abruptly. In this case, you must maintain a safe braking distance, and if necessary, steer your vehicle and depress the brake pedal to reduce your driving speed in order to maintain a safe distance.

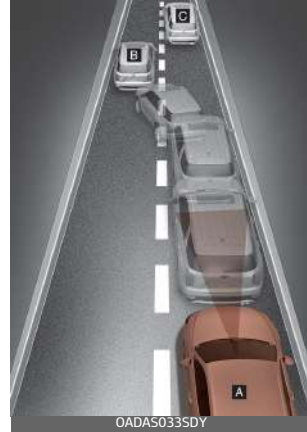

[A]: Your vehicle,
[B]: Lane changing vehicle,
[C]: Same lane vehicle
When a vehicle in front of you merges out of the lane, Forward Collision-Avoidance Assist may not immediately detect the vehicle that is now in front of you. In this case, you must maintain a safe braking distance, and if necessary, steer your vehicle and depress the brake pedal to reduce your driving speed in order to maintain a safe distance.

- Detecting vehicle

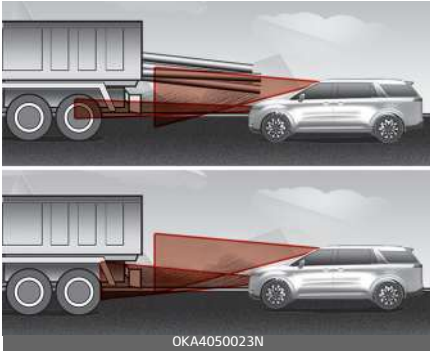

If the vehicle in front of you has cargo that extends rearward from the cab, or when the vehicle in front of you has higher ground clearance, additional special attention is required. Forward Collision-Avoidance Assist may not be able to detect the cargo extending from the vehicle. In these instances, you must maintain a safe braking distance from the rearmost object, and if necessary, steer your vehicle and depress the brake pedal to reduce your driving speed in order to maintain distance.

⚠ WARNING

- When you are towing a trailer or another vehicle, we recommend that Forward Collision-Avoidance Assist is turned off due to safety reasons.
 - Forward Collision-Avoidance Assist may operate if objects that are similar in shape or characteristics to vehicles, pedestrians and cyclists are detected.
 - Forward Collision-Avoidance Assist does not operate on bicycles, motorcycles, or smaller wheeled objects, such as luggage bags, shopping carts, or strollers.
 - Forward Collision-Avoidance Assist may not operate normally if interfered by strong electromagnetic waves.
 - Forward Collision-Avoidance Assist may not operate for 15 seconds after the vehicle is started, or the front view camera is initialized.
-

This device complies with Industry Canada licence-exempt RSS standard(s).

Operation is subject to the following conditions:

1. This device may not cause interference, and
2. This device must accept any interference, including interference that may cause undesired operation of the device.
3. Changes or modifications not expressly approved by the party responsible for compliance could void the user's authority to operate the device.

Lane Keeping Assist (LKA)

Lane Keeping Assist is designed to help detect lane markings (or road edges) while driving over a certain speed. The function will warn the driver if the vehicle leaves the lane without using the turn signal, or will automatically assist the driver's steering to help prevent the vehicle from departing the lane.

Detecting sensor

Front view camera



The front view camera is used as a detecting sensor to detect lane markings (or road edges).

Refer to the picture above for the detailed location of the detecting sensor.

⚠ CAUTION

For more details on the precautions of the front view camera, refer to "Forward Collision-Avoidance Assist (FCA) (Sensor fusion) (if equipped)" on page 5-61.

Function settings

Setting

Lane Safety

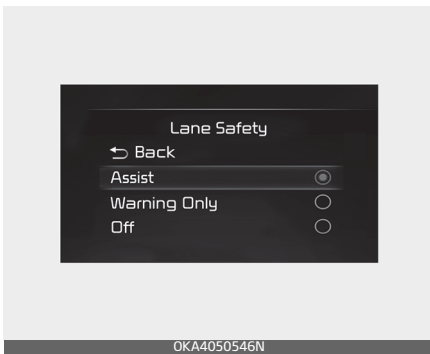

With the engine on, select or deselect 'Driver Assistance → Lane Safety' from the Settings menu to set whether or not to use each function.

- If 'Assist' is selected, the function will automatically assist the driver's steering when lane departure is detected to help prevent the vehicle from moving out of its lane.
- If 'Warning Only' is selected, the function will warn the driver with

an audible warning when lane departure is detected. The driver must steer the vehicle.

- If 'Off' is selected, the function will turn off. The (🚗) indicator light will turn off on the cluster.

⚠ WARNING

- If 'Lane Departure Warning' is selected, steering is not assisted.
- Lane Keeping Assist does not control the steering wheel when the vehicle is driven in the middle of the lane.
- The driver should always be aware of the surroundings and steer the vehicle if 'Off' is selected.

Turning On/Off (Lane Safety button)

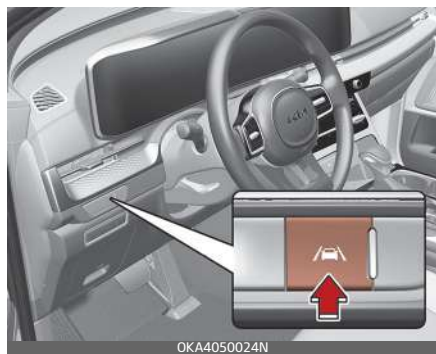

With the engine on, press and hold the Lane Safety button located on the instrument panel to turn on Lane Keeping Assist. The white

() indicator light will illuminate on the cluster.

Press and hold the button again to turn off the function.

If the engine is restarted, Lane Keeping Assist will maintain the last setting.

*** NOTICE**

When Lane Keeping Assist is turned off with the Lane Safety button, Lane Safety settings will turn off.

Warning volume

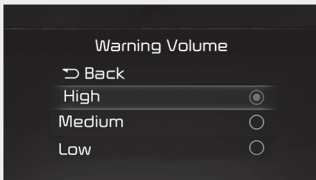

OMQ4AH050335

With the engine on, select 'Driver Assistance → Warning Volume' from the Settings menu to change the Warning Volume to 'High', 'Medium', or 'Low' for Lane Keeping Assist.

If you change the Warning Volume, the Warning Volume of other Driver Assistance functions may be changed.

Function operation

Function warning and control

Lane Keeping Assist will warn and control the vehicle with Lane Departure Warning and Lane Keeping Assist.

Lane Departure Warning

Left

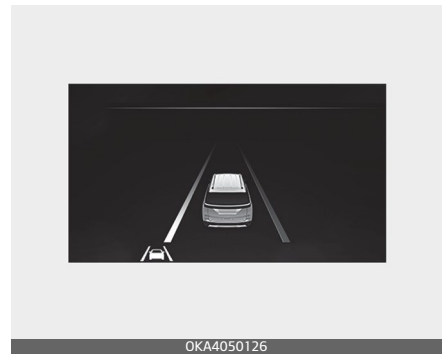

OKA4050126

Right

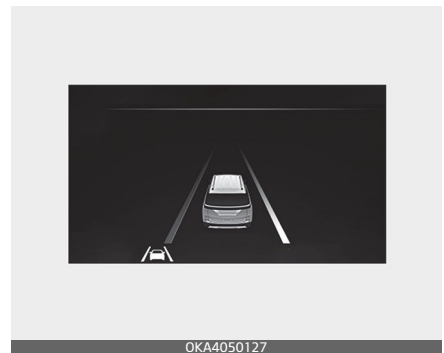

OKA4050127

- To warn the driver that the vehicle is departing from the projected lane in front, the green () indicator light will blink on the cluster, the lane line will blink

on the cluster depending on which direction the vehicle is veering, and an audible warning will sound.

- The function will operate when your vehicle speed is between approximately 60 ~ 200 km/h (40 ~ 120 mph).

Lane Keeping Assist

- To warn the driver that the vehicle is departing from the projected lane in front, the green () indicator light will blink on the cluster, and the steering wheel will make adjustments to keep vehicle inside the lane.
- The function will operate when your vehicle speed is between approximately 60 ~ 200 km/h (40 ~ 120 mph).

Hands-off warning

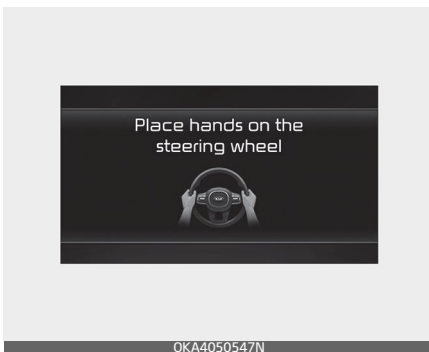

If the driver takes their hands off the steering wheel for several seconds, the 'Place hands on the steering wheel' (or 'Keep hands on the steering wheel') warning message

will appear on the cluster, and an audible warning will sound in stages.

⚠ WARNING

- The steering wheel may not be assisted if the steering wheel is held very tight or the steering wheel is steered over a certain degree.
- Lane Keeping Assist does not operate at all times. It is the responsibility of the driver to safely steer the vehicle and to maintain the vehicle in its lane.
- The hands-off warning message may appear late depending on road conditions. Always have your hands on the steering wheel while driving.
- If the steering wheel is held very lightly, the hands-off warning message may appear because the function may not recognize that the driver has their hands on the steering wheel.
- If you attach objects to the steering wheel, the hands-off warning may not work properly.

*** NOTICE**

- You may change settings from the instrument cluster (User Settings) or infotainment system (Vehicle Settings), whichever option that is provided with your vehicle. For more details, see

- "User settings mode" on page 4-110, or "Vehicle Settings" section in supplied Infotainment Manual.
- When lane markings (or road edges) are detected, the lane lines on the cluster will change from grey to white and the green () indicator light will illuminate.

Lane undetected

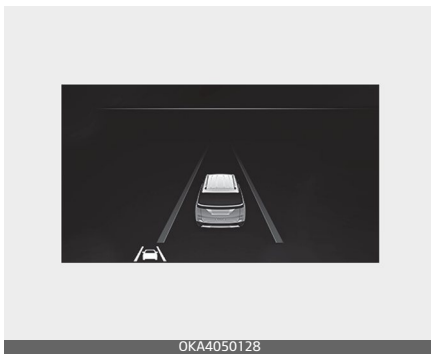

Lane detected

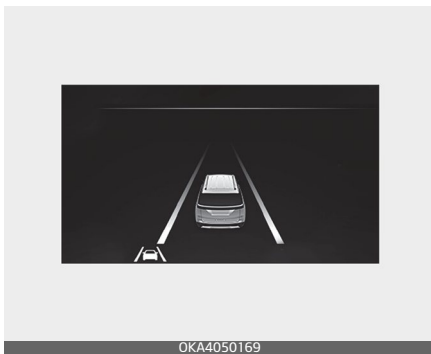

- The steering wheel may feel heavier or lighter when the steering wheel is assisted by Lane Keeping Assist than when it is not.

Malfunction and limitations

Malfunction

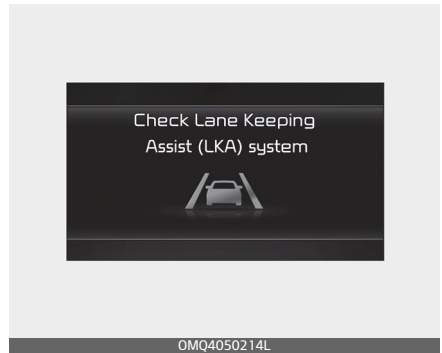

When Lane Keeping Assist is not working properly, the 'Check Lane Keeping Assist (LKA) system' (or 'Check LKA (Lane Keeping Assist) system') warning message will appear and the yellow () indicator light will illuminate on the cluster. If this occurs, have the function be inspected by an authorized Kia dealer.

- Even though the steering is assisted by Lane Keeping Assist, the driver may control the steering wheel.

Limitations

Lane Keeping Assist may not operate normally or may operate unexpectedly under the following circumstances:

- The lane is contaminated or difficult to distinguish because,
 - The lane markings (or road edge) is covered with rain, snow, dirt, oil, etc.
 - The color of the lane marking (or road edge) is not distinguishable from the road
 - There are markings (or road edges) on the road near the lane or the markings (or road edges) on the road looks similar to the lane markings (or road edges)
 - The lane marking (or road edge) is indistinct or damaged
 - The shadow is on the lane marking (or road edge) by a median strip, trees, guardrail, noise barriers, etc.
- There are more than two lane markings (or road edges) on the road
- The lane number increases or decreases, or the lane markings are crossing
- The lane markings (or road edges) are complicated or a structure substitutes for the lines, such as a construction area
- There are road markings, such as zigzag lanes, crosswalk markings and road signs
- The lane suddenly disappears, such as at the intersection
- The lane (or road width) is very wide or narrow
- There is a road edge without a lane
- There is a boundary structure in the roadway, such as a tollgate, sidewalk, curb, etc.
- The distance to the front vehicle is extremely short or the vehicle in front is covering the lane marking (or road edge)
- The vehicle is driving to the bus lane, or driving at the left or right side of the bus lane

For more details on the limitations of the front view camera, refer to "Forward Collision-Avoidance Assist (FCA) (Sensor fusion) (if equipped)" on page 5-61.

* NOTICE

Take the following precautions when using Lane Keeping Assist:

- The driver should hold the responsibility to safely drive and control the vehicle. Do not solely rely on the function and drive dangerously.
 - The operation of Lane Keeping Assist can be canceled or not work properly depending on road conditions and surroundings. Always be cautious while driving.
 - Refer to "Limitations" if the lane is not detected properly.
 - When you are towing a trailer or another vehicle, we recommend that Lane Keeping Assist is turned off due to safety reasons.
 - If the vehicle is driven at high speed, the steering wheel will not be controlled. The driver must always follow the speed limit when using the function.
 - If any other function's warning message is displayed or audible warning is generated, Lane Keeping Assist warning message may not be displayed and audible warning may not be generated.
 - You may not hear the warning sound of Lane Keeping Assist if the surrounding is noisy.
 - If you attach objects to the steering wheel, steering may not be assisted properly.
- Lane Keeping Assist may not operate for 15 seconds after the vehicle is started, or the Front view camera is initialized.
 - Lane Keeping Assist will not operate when:
 - The turn signal or hazard warning flasher is turned on
 - The vehicle is not driven in the center of the lane when the function is turned on or right after changing a lane
 - ESC (Electronic Stability Control) or VSM (Vehicle Stability Management) is activated
 - The vehicle is driven on a sharp curve
 - Vehicle speed is below 55 km/h (35 mph) or above 210 km/h (130 mph)
 - The vehicle makes sharp lane changes
 - The vehicle brakes suddenly

Blind-Spot Collision-Avoidance Assist (BCA) (if equipped)

Blind-Spot Collision-Avoidance Assist is designed to help detect and monitor approaching vehicles in the driver's blind spot area and warn the driver of a possible collision with a warning message and audible warning.

In addition, if there is a risk of collision when changing lanes or driving forward out of a parking space, the function will help avoid collision by applying the differential braking.

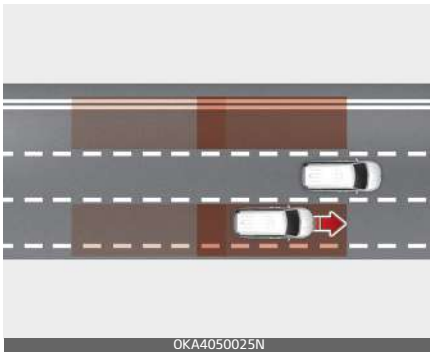

Blind-Spot Collision-Avoidance Assist helps detect and inform the driver that a vehicle is in the blind spot.

⚠ CAUTION

The detecting range may vary depending on the speed of your vehicle. However, even if there is a vehicle in the blind spot area, the function may not warn you when you pass by at high speeds.

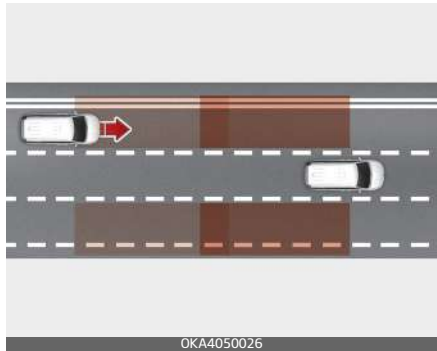

Blind-Spot Collision Assist helps detect and informs the driver that a vehicle is approaching at high speed from the blind spot area.

⚠ CAUTION

Warning timing may vary depending on the speed of the vehicle approaching at high speed.

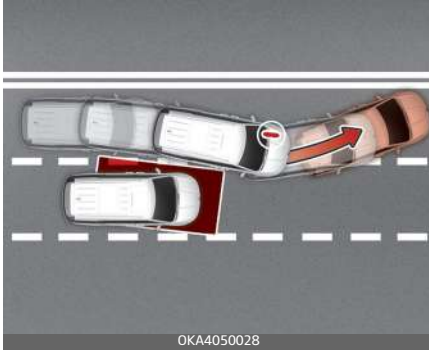

When changing lanes by detecting the lane ahead, if the function judges that there is a collision risk with an approaching vehicle in the blind spot, the function will help avoid a collision by applying the brake.

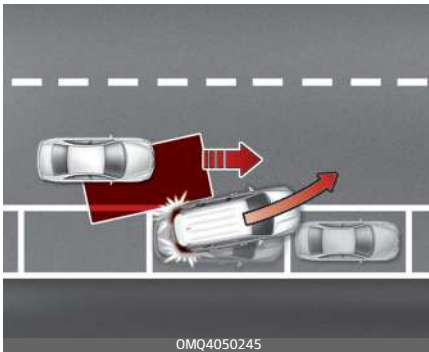

When you are driving forward out of a parking space, if the function judges that there is a collision risk with an approaching vehicle in the blind spot, the function will help avoid collision by applying the brake.

* NOTICE

- In the following text, Blind-Spot Collision-Avoidance Assist will be referred as Blind-Spot Safety system.

Detecting sensor

Front view camera



Rear corner radar



Refer to the picture above for the detailed location of the detecting sensors.

⚠ CAUTION

Take the following precautions to maintain optimal performance of the detecting sensor:

- Never disassemble the rear corner radar or radar assembly, or apply any impact on it.
- If there is impact on the rear corner radar or near the radar, even though the warning message does not appear on the cluster, Blind-Spot Safety system may not operate properly. Have the function be inspected by an authorized Kia dealer.
- If the rear corner radars have been replaced or repaired, Have the vehicle be inspected by an authorized Kia dealer.
- Use only genuine parts to repair the rear bumper where the rear corner radar is located.
- Do not apply license plate frame or objects, such as a bumper sticker, film or a bumper guard near the rear corner radar.
- The function may not work properly if the bumper has been replaced, or the surroundings of the rear corner radar has been damaged or paint has been applied.
- If a trailer, carrier, etc. is installed, it may adversely affect the performance of the rear corner radar or the function may not operate.

For more details on the precautions of the front view camera, refer to "Forward Collision-Avoidance Assist (FCA) (Sensor fusion) (if equipped)" on page 5-61.

Function settings

Setting

Blind-Spot Safety



With the engine on, select or deselect 'Driver Assistance → Blind-Spot Safety' from the Settings menu to set whether or not to use each function.

- If 'Active Assist' is selected, the function will warn the driver with a warning message, an audible warning and braking assist will be applied depending on the collision risk levels.
- If 'Warning Only' is selected, the function will warn the driver with a warning message and an audible warning depending on the collision

risk levels. Braking will not be assisted.

- If 'Off' is selected, the function will turn off.



When the engine is restarted with the function off, the 'Blind-Spot Safety System is Off' message will appear on the cluster.

If you change the setting from 'Off' to 'Active Assist' or 'Warning Only', the warning light on the outside rearview mirror will blink for 3 seconds.

In addition, if the engine is turned on, when the function is set to 'Active Assist' or 'Warning Only', the warning light on the outside rearview mirror will blink for 3 seconds.

⚠ WARNING

- If 'Warning Only' is selected, braking is not assisted.
- If 'Off' is selected, the driver should always be aware of the surroundings and drive safely.

* NOTICE

If the engine is restarted, Blind-Spot Safety system will maintain the last setting.

Warning timing



With the engine on, select 'Driver Assistance → Warning Timing' from the Settings menu to change the initial warning activation time for Blind-Spot Safety system.

When the vehicle is first delivered, Warning Timing is set to 'Normal'. If you change the Warning Timing, the warning time of other Driver Assistance systems may change.

Warning volume

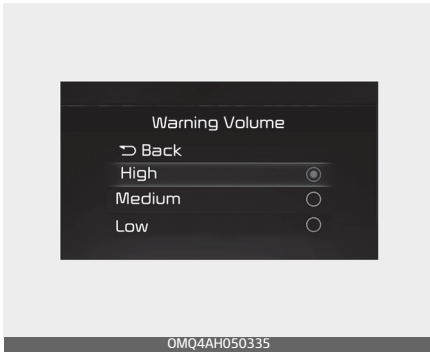

With the engine on, select 'Driver Assistance → Warning Volume' from the Settings menu to change the Warning Volume to 'High', 'Medium', or 'Low' for Blind-Spot Safety system.

If you change the Warning Volume, the warning volume of other Driver Assistance systems may change.

⚠ CAUTION

- The setting of the Warning Timing and Warning Volume applies to all functions of the Blind-Spot Safety system.
- Even though 'Normal' is selected for Warning Timing, if the vehicles approaches at high speed, the initial warning activation time may seem late.
- Select 'Late' for Warning Timing when traffic is light and when driving speed is slow.

Function operation

Function warning and control

Vehicle detection



- To warn the driver a vehicle is detected, the warning light on the outside rearview mirror will illuminate.
- The function will operate when your vehicle speed is above 20 km/h (12 mph) and the speed of the vehicle in the blind spot area is above 10 km/h (7 mph).

Collision warning

- Collision warning will operate when the turn signal is turned on in the direction of the detected vehicle.
- If 'Warning Only' is selected from the Settings menu, the collision warning will operate when your vehicle approaches the lane the blind spot vehicle is detected.
- To warn the driver of a collision, the warning light on the outside

rearview mirror will blink. At the same time, an audible warning will sound.

- When the turn signal is turned off or you move away from the lane, the collision warning will be canceled and the function will return to vehicle detection state.

⚠ WARNING

- The detecting range of the rear corner radar is determined by a standard road width, therefore, on a narrow road, the function may detect other vehicles in the next next lane and warn you. In contrast, on a wide road, the function may not be able to detect a vehicle driving in the next lane and may not warn you.
- When the hazard warning flasher is on, the collision warning by the turn signal will not operate.

* NOTICE

If the driver's seat is on the left side, the collision warning may occur when you turn left. Maintain a proper distance with the vehicles in the left lane. If the driver's seat is on the right side, the collision warning may occur when you turn right. Maintain a proper distance with the vehicles in the right lane.

Collision-Avoidance Assist (while driving)

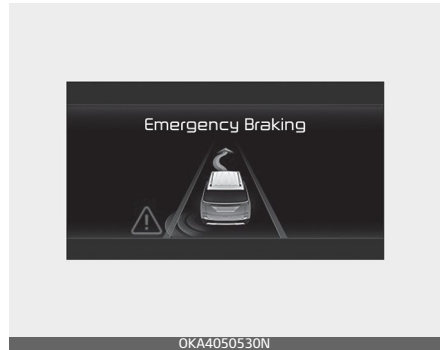

- To warn the driver of a collision, the warning light on the outside rearview mirror will blink and a warning message will appear on the cluster. At the same time, an audible warning will sound.
- The function will operate when your vehicle speed is between 60 ~ 200 km/h (40 ~ 120 mph) and both lane markings of the driving lane are detected.
- Emergency braking will be assisted to help prevent collision with the vehicle in the blind spot area.

⚠ WARNING

- Collision-Avoidance Assist will be canceled under the following circumstances:
 - Your vehicle enters the next lane by a certain distance
 - Your vehicle is away from the collision risk
 - The steering wheel is sharply steered
 - The brake pedal is depressed
 - Forward Collision-Avoidance Assist is operating
- After Function Operation or changing lane, you must drive to the center of the lane. The function will not operate if the vehicle is not driven in the center of the lane.

- the cluster. At the same time, an audible warning will sound.
- The function will operate when your vehicle speed is below 3 km/h (2 mph) and the speed of the vehicle in the blind spot area is above 5 km/h (3 mph).
 - Emergency braking will be assisted to help prevent collision with the vehicle in the blind spot area.

Stopping vehicle and ending brake control



Collision-Avoidance Assist (while departing)

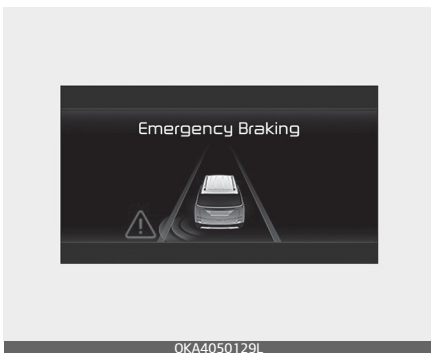

- When the vehicle is stopped due to emergency braking, the 'Drive carefully' warning message will appear on the cluster.
- For your safety, the driver should depress the brake pedal immediately and check the surroundings.
- Brake control will end after the vehicle is stopped by emergency braking for approximately 2 seconds.

- To warn the driver of a collision, the warning light on the outside rearview mirror will blink and a warning message will appear on

⚠ WARNING

Take the following precautions when using Blind-Spot Safety System:

- For your safety, change the Settings after parking the vehicle at a safe location.
- If any other function's warning message is displayed or audible warning is generated, Blind-Spot Safety system's warning message may not be displayed and audible warning may not be generated.
- You may not hear the warning sound of Blind-Spot Safety system if the surrounding is noisy.
- Blind-Spot Safety system may not operate if the driver applies the brake pedal to avoid collision.
- When Blind-Spot Safety system is operating, braking control by the system will automatically cancel when the driver excessively depresses the accelerator pedal or sharply steers the vehicle.
- During Blind-Spot Safety system operation, the vehicle may stop suddenly injuring passengers and shifting loose objects. Always have the seat belt on and keep loose objects secured.
- Even if there is a problem with Blind-Spot Safety system, the vehicle's basic braking performance will operate normally.

- Blind-Spot Safety system does not operate in all situations or cannot avoid all collisions.
- Blind-Spot Safety system may warn the driver late or may not warn the driver depending on the road and driving conditions.
- Driver should maintain control of the vehicle at all times. Do not depend on Blind-Spot Safety system. Maintain a safe braking distance, and if necessary, depress the brake pedal to reduce driving speed or to stop the vehicle.
- Never operate Blind-Spot Safety system on people, animal, objects, etc. It may cause serious injury or death.

⚠ WARNING

- The brake control may not operate properly depending on the status of ESC (Electronic Stability Control).
- There will only be a warning when:
 - The ESC (Electronic Stability Control) warning light is on
 - ESC (Electronic Stability Control) is engaged in a different function

Malfunction and limitations

Malfunction



When Blind-Spot Safety system is not working properly, the 'Check Blind-Spot Safety system(s)' warning message will appear on the cluster, and the function will turn off automatically or the function will be limited. Have the function be inspected by an authorized Kia dealer.

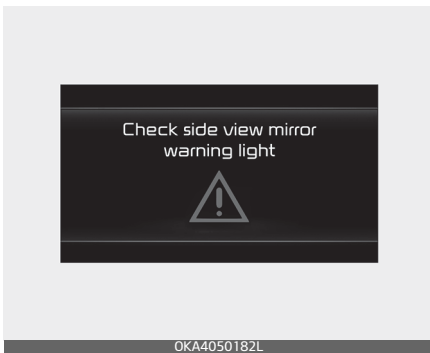

When the outside rearview mirror warning light is not working properly, the 'Check side view mirror warning light' (or 'Check outside

mirror warning icon') warning message will appear on the cluster. Have the function be inspected by an authorized Kia dealer.

Function disabled

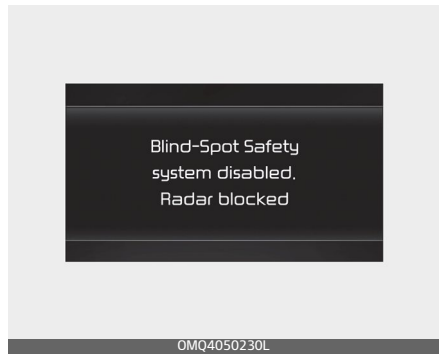

When the rear bumper around the rear corner radar or sensor is covered with foreign material, such as snow or rain, or installing a trailer or carrier, it can reduce the detecting performance and temporarily limit or disable Blind-Spot Safety system.

If this occurs, the 'Blind-Spot Safety Function disabled. Radar blocked' warning message will appear on the cluster.

The function will operate normally when such foreign material or trailer, etc. is removed, and then the engine is restarted.

If the function does not operate normally after it is removed, have the function be inspected by an authorized Kia dealer.

⚠ WARNING

- Even though the warning message does not appear on the cluster, Blind-Spot Safety system may not properly operate.
- Blind-Spot Safety system may not properly operate in an area (e.g. open terrain) where any substance are not detected right after the engine is turned on, or when the detecting sensor is blocked with foreign material right after the engine is turned on.

⚠ CAUTION

Turn off Blind-Spot Safety system to install a trailer, carrier, etc., or remove the trailer, carrier, etc. to use Blind-Spot Safety system.

Limitations

Blind-Spot Safety system may not operate normally, or the function may operate unexpectedly under the following circumstances:

- There is inclement weather, such as heavy snow, heavy rain, etc.
- The rear corner radar is covered with snow, rain, dirt, etc.
- The temperature around the rear corner radar is high or low
- Driving on a highway (or motorway) ramp
- The road pavement (or the peripheral ground) abnormally contains metallic components (i.e. possibly due to subway construction).
- There is a fixed object near the vehicle, such as sound barriers, guardrails, central dividers, entry barriers, street lamps, signs, tunnels, walls, etc. (including double structures)
- Driving in large areas where there are few vehicles or structures (i.e. desert, meadow, suburb, etc.)
- Driving through a narrow road where trees or grass are overgrown
- Driving on a wet road surface, such as a puddle on the road
- The other vehicle drives very close behind your vehicle, or the other vehicle passes by your vehicle in close proximity
- The speed of the other vehicle is very fast that it passes by your vehicle in a short time
- Your vehicle passes by the other vehicle
- Your vehicle changes lane
- Your vehicle has started at the same time as the vehicle next to you and has accelerated

- The vehicle in the next lane moves two lanes away from you, or when the vehicle two lanes away moves to the next lane from you
- A trailer or carrier is installed around the rear corner radar
- The bumper around the rear corner radar is covered with objects, such as a bumper sticker, bumper guard, bike rack, etc.
- The bumper around the rear corner radar is impacted, damaged or the radar is out of position
- Your vehicle height is low or high due to heavy loads, abnormal tire pressure, etc.

Blind-Spot Safety system may not operate normally, or the function may operate unexpectedly when the following objects are detected:

- A motorcycle or bicycle is detected
- A vehicle such as a flat trailer is detected
- A big vehicle such as a bus or truck is detected
- A moving obstacle such as a pedestrian, animal, shopping cart or a baby stroller is detected
- A vehicle with low height such as a sports car is detected

Braking control may not work, driver's attention is required in the following circumstances:

- The vehicle severely vibrates while driving over a bumpy road, uneven road or concrete patch

- Driving on a slippery surface due to snow, water puddle, ice, etc.
- The tire pressure is low or a tire is damaged
- The brake is reworked
- The vehicle makes abrupt lane changes

CAUTION

For more details on the limitations of the front view camera, refer to "Forward Collision-Avoidance Assist (FCA) (Sensor fusion) (if equipped)" on page 5-61 and "Lane Keeping Assist (LKA)" on page 5-77.

WARNING

- Driving on a curve

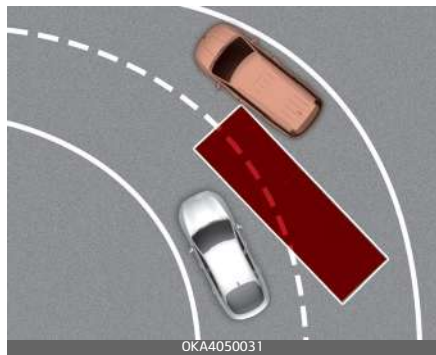

Blind-Spot Safety system may not operate properly when driving on a curved road. The function may not detect the vehicle in the next lane.

Always pay attention to road and driving conditions while driving.



Blind-Spot Safety system may not operate properly when driving on a curved road. The function may recognize a vehicle in the same lane.

Always pay attention to road and driving conditions while driving.

- Driving where the road is merging/dividing

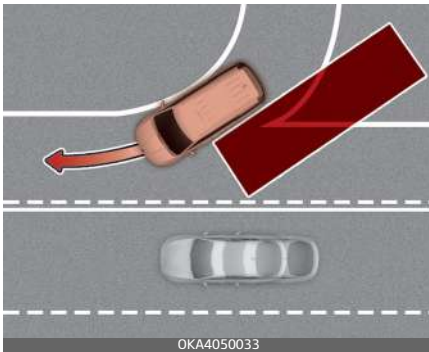

Blind-Spot Safety system may not operate properly when driving where the road merges or divides. The function may not detect the vehicle in the next lane.

Always pay attention to road and driving conditions while driving.

- Driving on a slope

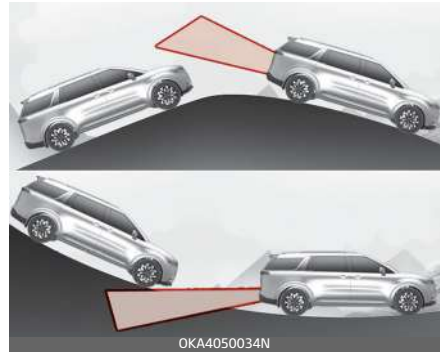

Blind-Spot Safety system may not operate properly when driving on a slope. The function may not detect the vehicle in the next lane or may incorrectly detect the ground or structure.

Always pay attention to road and driving conditions while driving.

- Driving where the heights of the lanes are different



Blind-Spot Safety system may not operate properly when driving where the heights of the lanes are different. The function may not detect the vehicle on a road

with different lane heights (underpass joining section, grade separated intersections, etc.). Always pay attention to road and driving conditions while driving.

⚠ WARNING

- When you are towing a trailer or another vehicle, make sure that you turn off Blind-Spot Safety system.
- Blind-Spot Safety system may not operate normally if interfered by strong electromagnetic waves.
- Blind-Spot Safety system may not operate for approximately 15 seconds after the vehicle is started, or the front view camera or rear corner radars are initialized.

This device complies with Industry Canada licence-exempt RSS standard(s).

Operation is subject to the following two conditions:

1. This device may not cause interference, and
2. This device must accept any interference, including interference that may cause undesired operation of the device.

Safe Exit Warning (SEW) (if equipped)

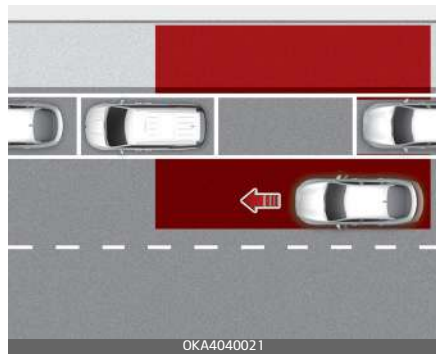

After the vehicle stops, when an approaching vehicle from the rear area is detected as soon as a passenger opens a door, Safe Exit Warning will warn the driver with a warning message and an audible warning to help prevent a collision.

⚠ CAUTION

Warning timing may vary depending on the speed of the approaching vehicle.

Detecting sensor

Rear corner radar



The rear corner radars are sensors located inside the rear bumper to detect the side and rear areas.

Always keep the rear bumper clean for proper operation of Safe Exit Warning.

* NOTICE

For more details on the precautions of the rear corner radars, refer to "Blind-Spot Collision-Avoidance Assist (BCA) (if equipped)" on page 5-84.

Function settings

Setting

Safe Exit Warning



With the engine on, select 'Driver Assistance → Blind-Spot Safety → Safe Exit Warning (SEW) (or SEW (Safe Exit Warning))' from the Settings menu to turn on Safe Exit Warning and deselect to turn off the function.

⚠ WARNING

The driver should always be aware of unexpected and sudden situations from occurring. If 'Safe Exit Assist' is deselected, the function cannot assist you.

* NOTICE

If the engine is restarted, Safe Exit Warning will maintain the last setting.

Warning timing



With the engine on, select 'Driver Assistance → Warning Timing' from the Settings menu to change the initial warning activation time for Blind-Spot Safety system.

When the vehicle is first delivered, warning timing is set to 'Normal'. If you change the warning timing, the warning time of other Driver Assistance systems may change.

Warning volume

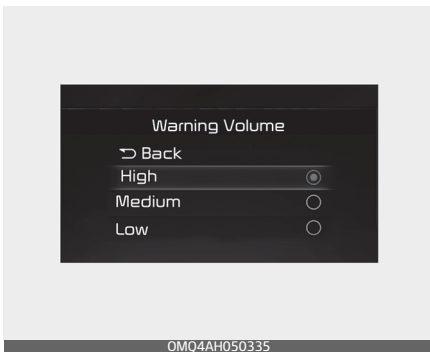

With the engine on, select 'Driver Assistance → Warning Volume' from the Settings menu to change the

warning volume to 'High', 'Medium', or 'Low' for Blind-Spot Safety system.

If you change the warning volume, the warning volume of other Driver Assistance systems may change.

⚠ CAUTION

- The setting of the Warning Timing and Warning Volume applies to all functions of the Safe Exit Warning.
- Even though 'Normal' is selected for warning timing, if the vehicles approaches at high speed from the rear, the initial warning activation time may seem late.
- Select 'Late' for warning timing when traffic is light.

* NOTICE

If the engine is restarted, Warning timing and Warning volume will maintain the last setting.

Function operation

Warning

Collision warning when exiting vehicle

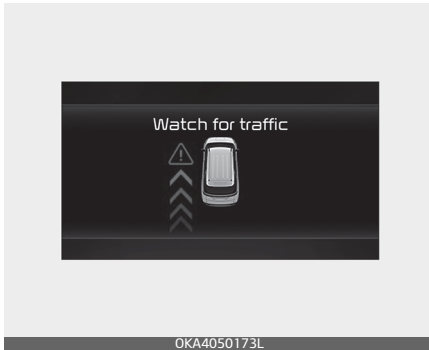

- When an approaching vehicle from the rear is detected, the 'Watch (out) for traffic' warning message will appear on the cluster, and an audible warning will sound.
- Safe Exit Warning will warn the driver when your vehicle speed is below 3 km/h (2 mph), and the speed of the approaching vehicle from the rear is above 5 km/h (3 mph).

* NOTICE

Take the following precautions when using Safe Exit Warning :

- For your safety, change the Settings after parking the vehicle at a safe location.
- If any other function's warning message is displayed or audible warning is generated, Safe Exit Warning warning message may not be displayed and audible warning may not be generated.
- You may not hear the warning sound of Safe Exit Warning if the surrounding is noisy.
- Safe Exit Warning does not operate in all situations or cannot prevent all collisions.
- Safe Exit Warning may warn the driver late or may not warn the driver depending on the road and driving conditions. Always check vehicle surroundings.
- The driver and passengers are responsible for accidents that occurs while exiting the vehicle. Always check the surroundings before you exit the vehicle.
- Never deliberately operate Safe Exit Warning. Doing so may lead to serious injury or death.
- Safe Exit Warning does not operate if there is a problem with Blind-Spot Safety system. There may be a problem with Blind Spot Safety system when:
 - Blind Spot Safety system warning light appears
 - Blind-Spot Safety system sensor or the sensor surrounding is polluted or covered

- Blind-Spot Safety system fails to warn passengers or falsely warn passengers

*** NOTICE**

After the engine is turned off, Safe Exit Warning system operates for 3 minutes, but turns off immediately if the doors are locked.

Malfunction and limitations

Malfunction

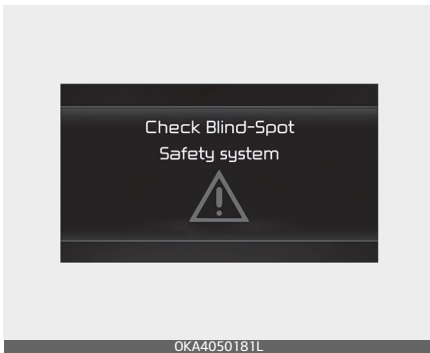

When Safe Exit Warning is not working properly, the 'Check Blind-Spot Safety system(s)' warning message will appear on the cluster, and the function will turn off automatically or the function will be limited. Have the function be inspected by an authorized Kia dealer.

Function disabled

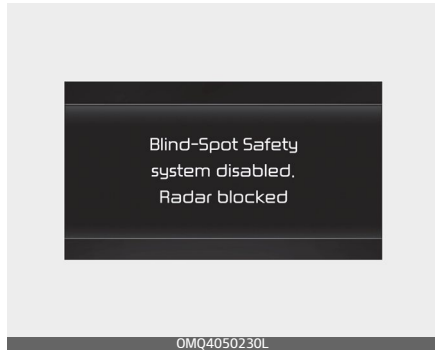

When the rear bumper around the rear corner radar or sensor is covered with foreign material, such as snow or rain, or installing a trailer or carrier, it can reduce the detecting performance and temporarily limit or disable Safe Exit Warning.

If this occurs, the 'Blind-Spot Safety system(s) disabled. Radar blocked' warning message will appear on the cluster.

The function will operate normally when such foreign material or trailer, etc. is removed, and then the engine is restarted.

If the function does not operate normally after it is removed, have your vehicle inspected by an authorized Kia dealer.

⚠ WARNING

- Even though the warning message does not appear on the cluster, Safe Exit Warning may not properly operate.
- Safe Exit Warning may not properly operate in an area (e.g., open terrain), where any substance are not detected right after the engine is turned on, or when the detecting sensor is blocked with foreign material right after the engine is turned on.

⚠ CAUTION

Turn off Safe Exit Warning to install a trailer, carrier, etc., or remove the trailer, carrier, etc. to use Safe Exit Assist.

Limitations

Safe Exit Warning may not operate normally, or the function may operate unexpectedly under the following circumstances:

- Getting out of the vehicle where trees or grass are overgrown
- Getting out of the vehicle where the road is wet
- The approaching vehicle is very fast or very slow

For more details on the precautions of the rear corner radars, refer to "Blind-Spot Collision-Avoidance Assist (BCA) (if equipped)" on page 5-84.

⚠ WARNING

- Safe Exit Warning may not operate normally if interfered by strong electromagnetic waves.
- Safe Exit Warning may not operate for 3 seconds after the vehicle is started, or the rear corner radars are initialized.

Safe Exit Assist (SEA) (if equipped)

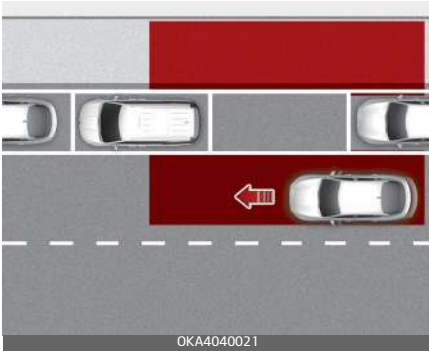

After the vehicle stops, when an approaching vehicle from the rear area is detected as soon as a driver or a passenger in 2nd row seat press the power sliding door button. Safe Exit Assist will warn the driver and passenger with an audible warning to prevent a collision.



1. Driver's side power sliding door button
2. passenger's side power sliding door button

CAUTION

Warning timing may vary depending on the speed of the approaching vehicle.

WARNING

Safe Exit Assist is not a substitute for Child-protector rear door lock, if you need to protect a passenger in the rear seat, be sure to use a Child Restraint System. For more details, refer to "Child-protector rear door lock" on page 4-27.

Detecting sensor

Rear corner radar



The rear corner radars are sensors located inside the rear bumper to detect the side and rear areas.

Always keep the rear bumper clean for proper operation of Safe Exit Assist.

* NOTICE

For more details on the precautions of the rear corner radars, refer to "Blind-Spot Collision-Avoidance Assist (BCA) (if equipped)" on page 5-84.

Function settings

Setting

Safe Exit Assist



With the engine on, select 'Driver Assistance → Blind-Spot Safety → Safe Exit Assist (SEA) (or SEA (Safe Exit Assist))' from the Settings menu to turn on Safe Exit Assist and deselect to turn off the function.

⚠ WARNING

The driver should always be aware of unexpected and sudden situations from occurring. If 'Safe Exit Assist' is deselected, the function cannot assist you.

* NOTICE

If the engine is restarted, Safe Exit Assist will maintain the last setting.

Warning timing



With the engine on, select 'Driver Assistance → Warning Timing' from the Settings menu to change the initial warning activation time for Blind-Spot Safety system.

When the vehicle is first delivered, Warning Timing is set to 'Normal'. If you change the Warning Timing, the warning time of other Driver Assistance systems may change.

Warning volume

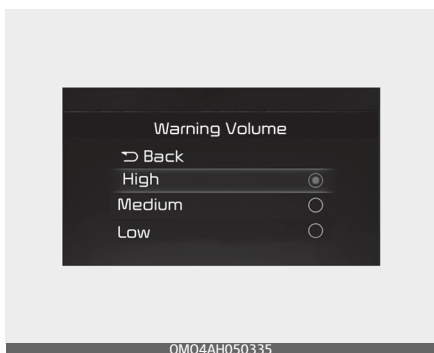

With the engine on, select 'Driver Assistance → Warning Volume' from the Settings menu to change the

warning volume to 'High', 'Medium', or 'Low' for Blind-Spot Safety system.

If you change the Warning Volume, the Warning Volume of other Driver Assistance systems may change.

⚠ CAUTION

- The setting of the Warning Timing and Warning Volume applies to all functions of the Safe Exit Assist.
- Even though 'Normal' is selected for Warning Timing, if the vehicles approaches at high speed from the rear, the initial warning activation time may seem late.
- Select 'Late' for Warning Timing when traffic is light.

Function operation

Warning and control

Collision warning when exiting vehicle

- When an approaching vehicle from the rear is detected, an audible warning will sound.
- Safe Exit Assist will warn the driver when your vehicle speed is below 3 km/h (2 mph), and the speed of the approaching vehicle from the rear is above 5 km/h (3 mph).

Function linked with Power Sliding Door

- When the power sliding door button is pressed, the open function will not operate, and a warning sound occurs once.
- Safe Exit Assist will warn the driver when vehicle speed is below 3 km/h (2 mph) and the speed of the approaching vehicle from the rear is above 5 km/h (3 mph).
- For more details on the power sliding door button, refer to "Power sliding door (if equipped)" on page 4-35

⚠ WARNING

If the driver presses Power sliding door button again within 10 seconds, it is determined that the driver checked the around the vehicle and opened the door and the door will open regardless of vehicles approaching. Always make sure there are no people or objects around the door before opening the rear door with Power sliding door button.

*** NOTICE**

If you manually open the sliding door by pulling the inside or outside door handles, the door will open regardless of the Safe Exit Assist.

⚠ WARNING

Take the following precautions when using Safe Exit Assist:

- For your safety, change the Settings after parking the vehicle at a safe location.
- You may not hear the warning sound of Safe Exit Assist if the surrounding is noisy.
- Safe Exit Assist does not operate in all situations or cannot prevent all collisions.
- Safe Exit Assist may warn the driver late or may not warn the driver depending on the road and driving conditions. Always check vehicle surroundings.
- The driver and passengers are responsible for accidents that occurs while exiting the vehicle. Always check the surroundings before you exit the vehicle.
- Never deliberately operate Safe Exit Assist. Doing so may lead to serious injury or death.
- Safe Exit Assist does not operate if there is a problem with Blind-Spot Safety system There may be a problem with Blind Spot Safety system when:
 - Blind Spot Safety system warning light appears
 - Blind-Spot Safety system sensor or the sensor surrounding is polluted or covered

- Blind-Spot Safety system fails to warn passengers or falsely warn passengers

*** NOTICE**

After the engine is turned off, Safe Exit Assist operates for 3 minutes, but turns off immediately if the doors are locked.

Malfunction and limitations

Malfunction

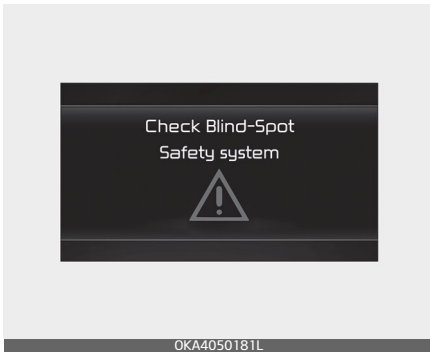

When Safe Exit Assist is not working properly, the 'Check Blind-Spot Safety system(s)' warning message will appear on the cluster, and the function will turn off automatically or the function will be limited. Have the function be inspected by an authorized Kia dealer.

Function disabled

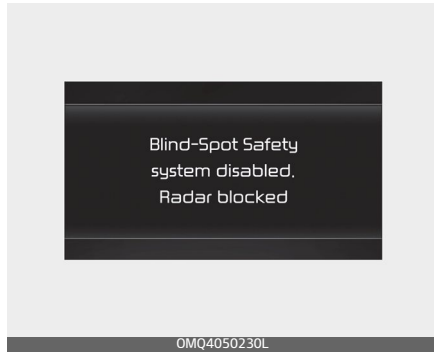

When the rear bumper around the rear corner radar or sensor is covered with foreign material, such as snow or rain, or installing a trailer or carrier, it can reduce the detecting performance and temporarily limit or disable Safe Exit Assist.

If this occurs, the 'Blind-Spot Safety system(s) disabled. Radar blocked' warning message will appear on the cluster.

The function will operate normally when such foreign material or trailer, etc. is removed, and then the engine is restarted.

If the function does not operate normally after it is removed, have your vehicle inspected by an authorized Kia dealer.

⚠ WARNING

- Even though the warning message does not appear on the cluster, Safe Exit Assist may not properly operate.
- Safe Exit Assist may not properly operate in an area (e.g., open terrain), where any substance are not detected right after the engine is turned on, or when the detecting sensor is blocked with foreign material right after the engine is turned on.

⚠ CAUTION

Turn off Safe Exit Assist to install a trailer, carrier, etc., or remove the trailer, carrier, etc. to use Safe Exit Assist.

Limitations

Safe Exit Assist may not operate normally, or the function may operate unexpectedly under the following circumstances:

- Getting out of the vehicle where trees or grass are overgrown
- Getting out of the vehicle where the road is wet
- The approaching vehicle is very fast or very slow

For more details on the precautions of the rear corner radars, refer to "Blind-Spot Collision-Avoidance Assist (BCA) (if equipped)" on page 5-84.

⚠ WARNING

- Safe Exit Assist may not operate normally if interfered by strong electromagnetic waves.
- Safe Exit Assist may not operate for 3 seconds after the vehicle is started, or the rear corner radars are initialized.

Intelligent Speed Limit Assist (ISLA) (if equipped)

Intelligent Speed Limit Assist uses information from the detected road sign and navigation system to inform the driver of the speed limit of the current road. Also, the function helps the driver to maintain within the speed limit of the road.

* NOTICE

Intelligent Speed Limit Assist may not operate properly if the function is used in other countries.

Detecting sensor

Front view camera



Refer to the picture above for the detailed location of the detecting sensor.

⚠ CAUTION

For more details on the precautions of the front view camera, refer to "Forward Collision-Avoidance Assist (FCA) (Sensor fusion) (if equipped)" on page 5-61.

* NOTICE

If the navigation system is available, the information from the navigation system is used along with the road sign information detected by the front view camera.

Function settings

Setting

Speed limit

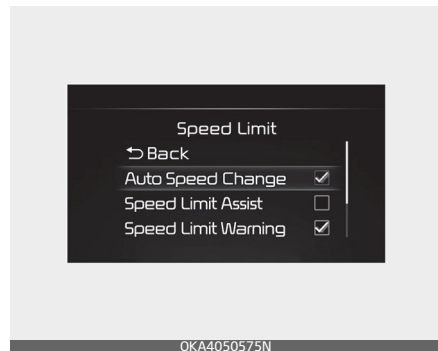

With the engine on, select or deselect 'Driver Assistance → Speed Limit' from the Settings menu to set whether or not to use each function.

- If 'Speed Limit Assist' is selected, the function will inform the driver of speed limit. In addition, the function will inform the driver to change set speed of Manual Speed Limit Assist and/or Smart Cruise Control to help the driver stay within the speed limit.
- If 'Speed Limit Warning' is selected, the function will inform the driver of speed limit. In addition, the function will warn the driver when the vehicle is driven faster than the speed limit.
- If 'Off' is selected, the function will turn off.

⚠ CAUTION

- If 'Speed Limit Warning' is selected, the function will not inform the driver to adjust set speed.

Speed limit offset

With the engine on, when 'Driver Assistance → Speed Limit → Speed Limit Offset' is selected, the Speed Limit Offset can be changed. Speed Limit Warning and Speed Limit Assist will operate by applying the Speed Limit Offset setting to the detected speed limit.

⚠ WARNING

- For your safety, change the Settings after parking the vehicle at a safe location.
- Speed Limit Assist function operates based on the Offset setting added to the speed limit. If you want to change the set speed according to the speed limit, set the offset to '0'.
- Speed Limit Warning function warns the driver when driving speed exceeds the speed at which the set Offset is added to speed limit. If you want Speed Limit Warning to warn you immediately when the driving speed exceeds the speed limit, set the offset to '0'.

Function operation

Function warning and control

Intelligent Speed Limit Assist will warn and control the vehicle by 'Displaying speed limit' and 'Changing set speed'.

* NOTICE

- Function warning and control are described based on the Offset set to '0'. For details on Offset setting, refer to "Function settings" on page 5-108.

Displaying speed limit



Speed limit information is displayed on the instrument cluster.

* NOTICE

- Intelligent Speed Limit Assist provides additional road sign information in addition to speed limit. The additional road sign information provided may vary according to country.
- Additional information displayed under the speed limit or overtaking restriction sign means the conditions under which the signs must be followed. If additional information is not recognized, it will be displayed as blank.

Changing set speed



If the speed limit of the road changes during the operation of Manual Speed Limit Assist or Smart Cruise Control, an arrow in the direction of up or down is displayed to inform the driver that the set speed needs to be changed. At this time, the driver can change the set speed according to the speed limit by using the + or – switch on the steering wheel.

⚠ WARNING

- If the Offset is set over '0', the set speed will change to a higher speed than the speed limit of the road. If you want to drive below the speed limit, set the Offset under '0' or use the – switch on the steering wheel to lower the set speed.
- Even after changing the set speed according to the speed limit of the road, the vehicle can still be driven over the speed limit. If necessary, depress the brake pedal to reduce your driving speed.
- If the speed limit of the road is under 20 mph (30 km/h), the set speed change function will not work.
- Intelligent Speed Limit Assist operates using the speed unit in the instrument cluster set by the driver. If the speed unit is set to a unit other than the speed unit used in your country, Intelligent Speed Limit Assist may not operate properly.

*** NOTICE**

For more details on operation of Smart Cruise Control, refer to "Smart Cruise Control (SCC) (if equipped)" on page 5-126.

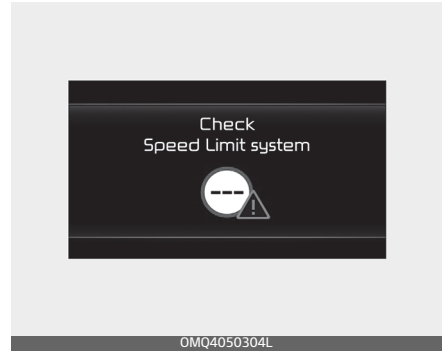
Malfunction and limitations**Malfunction**

When Intelligent Speed Limit Assist is not working properly, the 'Check speed limit system' warning message will appear on the cluster. If this occurs, have the function checked by an authorized Kia dealer.

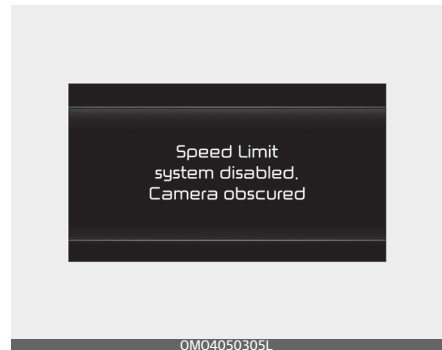
Function disabled

When the front windshield where the front view camera is located is covered with foreign material, such as snow or rain, it can reduce the detecting performance and tempo-

rarily limit or disable Intelligent Speed Limit Assist.

If this occurs the 'Speed limit system disabled. Camera obscured' warning message will appear on the cluster. The function will operate normally when snow, rain or foreign material is removed.

If the function does not operate normally after it is removed, have the function checked by an authorized Kia dealer.

* NOTICE

- Even though the warning message or warning light does not appear on the cluster, Intelligent Speed Limit Assist may not operate properly.
 - If the detecting sensor is contaminated immediately after starting the engine, the function may not operate properly.
-

Limitations

Intelligent Speed Limit Assist may not operate normally, or the function may operate unexpectedly under the following circumstances :

- The road sign is contaminated or indistinguishable
 - The road sign is difficult to see due to bad weather, such as rain, snow, fog, etc.
 - The road sign is not clear or damaged
 - The road sign is partially obscured by surrounding objects or shadow
- The road signs do not conform to the standard
 - The text or picture on the road sign is different from the standard
 - The road sign is installed between the main line and the exit road or between diverging roads
 - A conditional road sign is not installed with a sign located on the road to enter or exit
 - A sign is attached to another vehicle
- The brightness changes suddenly, for example when entering or exiting a tunnel or passing under a bridge
- Headlamps are not used or the brightness of the headlamps are weak at night or in the tunnel

- Road signs are difficult to recognize due to the reflection of sunlight, street lights, or oncoming vehicles
- The field of view of the Front view camera is obstructed by sun glare
- Driving on a road that is sharply curved or continuously curved
- Driving through speed bumps, or driving up and down or left to right on steep inclines
- The vehicle is shaking heavily

⚠ WARNING

- Intelligent Speed Limit Assist is a supplemental function that helps the driver to comply with the speed limit on the road, and may not display the correct speed limit or control the driving speed properly.
- Always set the vehicle speed to the speed limit in your country.

⚠ CAUTION

For more details on the limitations of the front view camera, refer to "Forward Collision-Avoidance Assist (FCA) (Sensor fusion) (if equipped)" on page 5-61.

Driver Attention Warning (DAW)

Basic function

Driver Attention Warning will help determine the driver's attention level by analyzing driving pattern, driving time, etc. while vehicle is being driven. The function will recommend a break when the driver's attention level falls below a certain level.

Leading vehicle departure alert function

Leading Vehicle Departure Alert function will inform the driver when the front vehicle departs from a stop.

Detecting sensor

Front view camera



The front view camera is used to detect driving patterns and front vehicle departure while vehicle is being driven.

Refer to the picture above for the detailed location of the detecting sensor.

CAUTION

Always keep the front view camera in good condition to maintain optimal performance of Driver Attention Warning.

For more details on the precautions of the front view camera, refer to "Forward Collision-Avoidance Assist (FCA) (Sensor fusion) (if equipped)" on page 5-61.

Function settings

Setting

Driver Attention Warning

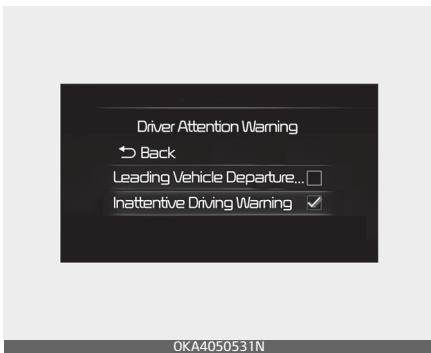

With the engine on, select or deselect 'Driver Assistance → Driver Attention Warning (or DAW (Driver Attention Warning))' from the Set-

tings menu to set whether or not to use each function.

- If 'Inattentive Driving Warning' (or 'Swaying Warning') is selected, the function will inform the driver the driver's attention level and will recommend taking a break when the level falls below a certain level.

Leading Vehicle Departure Alert

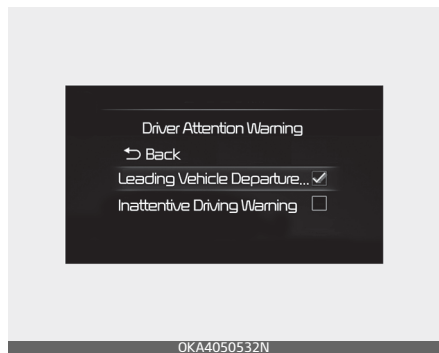

- If 'Leading Vehicle Departure Alert' is selected, the function will inform the driver when the front vehicle departs from a stop.

Warning timing

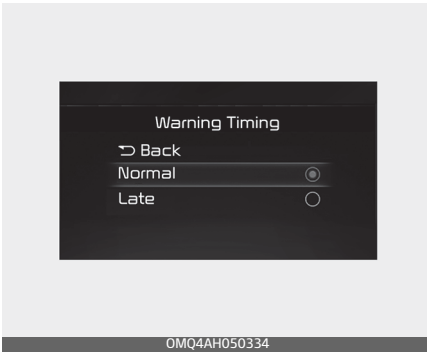

With the engine on, select 'Driver Assistance → Warning Timing' from the Settings menu to change the initial warning activation time for Driver Attention Warning.

When the vehicle is first delivered, Warning Timing is set to 'Normal'. If you change the Warning Timing, the warning time of other Driver Assistance systems may change.

* NOTICE

If the engine is restarted, Driver Warning Time will maintain the last setting.

Function operation

Basic function

Function display and warning

The basic function of Driver Attention Warning is to inform the driver the 'Attention Level' and to warn the driver to 'Consider taking a break'.

Attention level

Function off

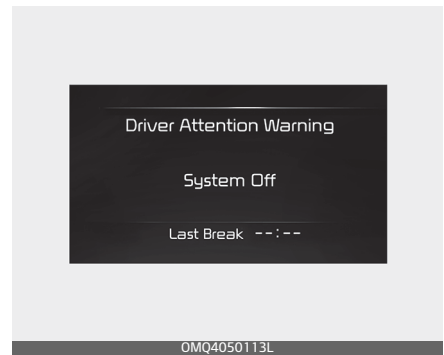

5

Standby/Disabled

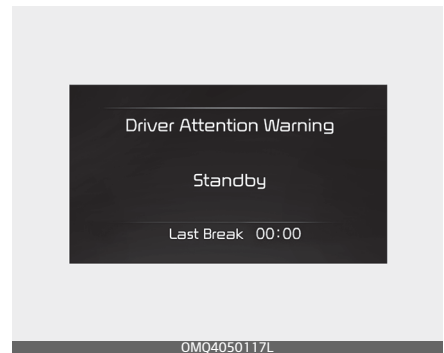

Attentive driving



Inattentive driving

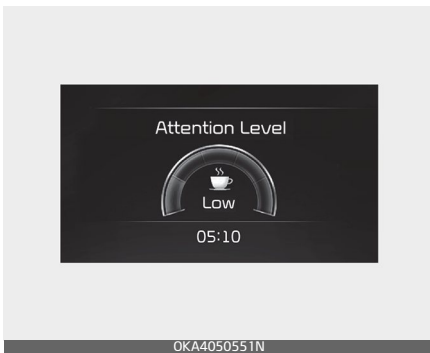

- The driver can monitor his/her driving conditions on the cluster.
 - When the 'Inattentive Driving Warning' is deselected from the Settings menu, 'System Off' is displayed.
 - The function will operate when vehicle speed is between 0 ~ 210 km/h (0 ~ 140 mph).
 - When vehicle speed is not within the operating speed, the message 'Standby' (or 'Disabled') will be displayed.

- The driver's attention level is displayed on the scale of 1 to 5. The lower the level is, the more inattentive the driver is.
- The level decreases when the driver does not take a break for a certain period of time.

Taking a break

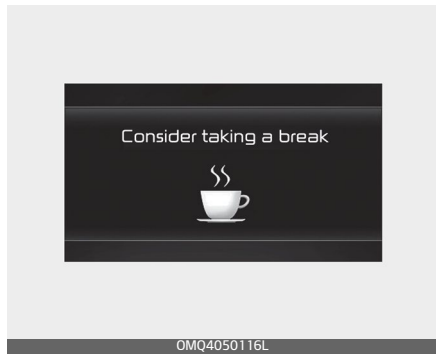

- The 'Consider taking a break' message will appear on the cluster and an audible warning will sound to suggest that the driver take a break, when the driver's attention level is below 1.
- Driver Attention Warning will not suggest a break when the total driving time is shorter than 10 minutes or 10 minutes has not passed after the last break was suggested.

⚠ WARNING

For your safety, change the Settings after parking the vehicle at a safe location.

⚠ CAUTION

- Driver Attention Warning may suggest a break depending on the driver's driving pattern or habits, even if the driver doesn't feel fatigued.
- Driver Attention Warning is a supplemental function and may not be able to determine whether the driver is inattentive.
- The driver who feels fatigued should take a break at a safe location, even though there is no break suggestion by Driver Attention Warning.

⚠ CAUTION

- You may change settings from the instrument cluster (User Settings) or infotainment system (Vehicle Settings), whichever option that is provided with your vehicle. For more details, see "User settings mode" on page 4-110, or "Vehicle Settings" section in supplied Infotainment Manual.
- Driver Attention Warning will reset the last break time to 00:00 in the following situations:
 - The engine is turned off

- The driver unfastens the seat belt and opens the driver's door.
- The vehicle is stopped for more than 10 minutes.
- When the driver resets Driver Attention Warning, the last break time is set to 00:00 and the driver's attention level is set to High.

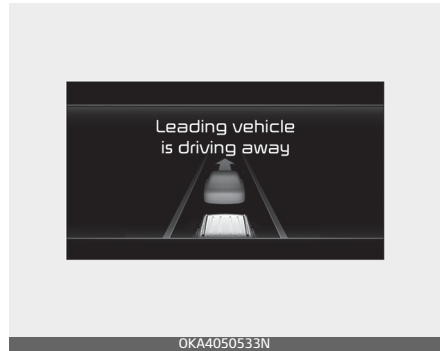
Leading vehicle departure alert function

When the front vehicle departs from a stop, Leading Vehicle Departure Alert will inform the driver by displaying the 'Leading vehicle is driving away' (or 'Leading vehicle is driving on') message on the cluster and an audible warning will sound.

⚠ WARNING

- If any other function's warning message is displayed or audible warning is generated, Leading Vehicle Departure Alert warning message may not be displayed and audible warning may not be generated.
 - The driver should hold the responsibility to safely drive and control the vehicle.
-

⚠ CAUTION

- Leading Vehicle Departure Alert is a supplemental function and may not alert the driver whenever the front vehicle departs from a stop.
 - Always check the front of the vehicle and road conditions before departure.
-

Malfunction and limitations

Malfunction



When Driver Attention Warning is not working properly, the 'Check Driver Attention Warning (DAW) system' warning message will appear on the cluster. If this occurs, have the function be inspected by an authorized Kia dealer.

Limitations

Driver Attention Warning may not work properly in the following situations:

- The vehicle is driven violently
- The vehicle intentionally crosses over lanes frequently
- The vehicle is controlled by Driver Assistance system, such as Lane Keeping Assist

Leading vehicle departure alert feature

- When the vehicle cuts in

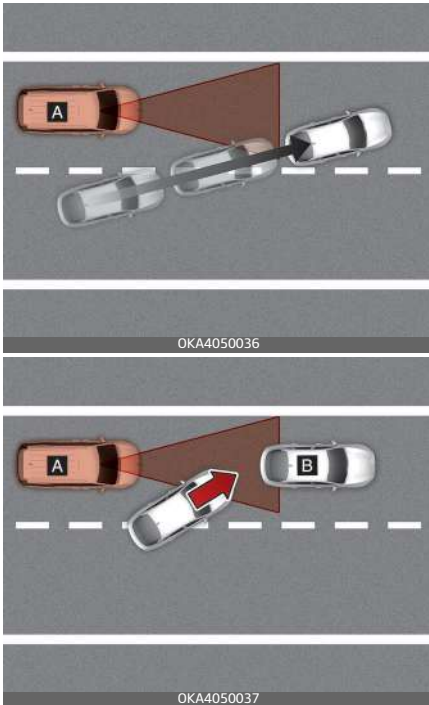

[A]: Your vehicle, [B]: Front vehicle

If a vehicle cuts in front of your vehicle, Leading Departure Alert may not operate properly.

- When the vehicle ahead sharply steers



[A]: Your vehicle, [B]: Front vehicle
If the vehicle in front makes a sharp turn, such as to turn left or right or make a U- turn, etc., Leading Vehicle Departure Alert may not operate properly.

- When the vehicle ahead abruptly departs

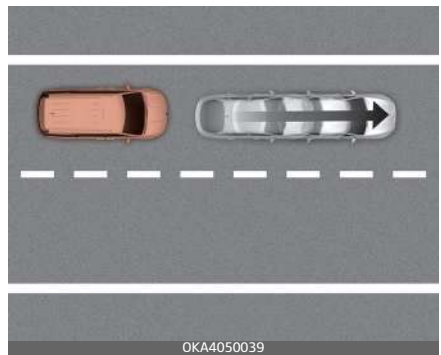

If the vehicle in front abruptly departs, Leading Vehicle Departure Alert may not operate properly.

- When a pedestrian or bicycle is between you and the vehicle ahead



If there is a pedestrian(s) or bicycle(s) in between you and the vehicle in front, Leading Vehicle Departure Alert may not operate properly.

- When in a parking lot

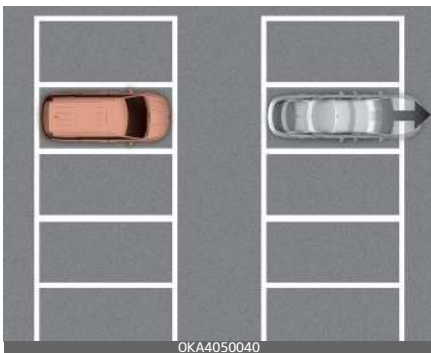

If a vehicle parked in front drives away from you, Leading Vehicle Departure Alert may alert you

that the parked vehicle is driving away.

- When driving at a tollgate or intersection, etc.

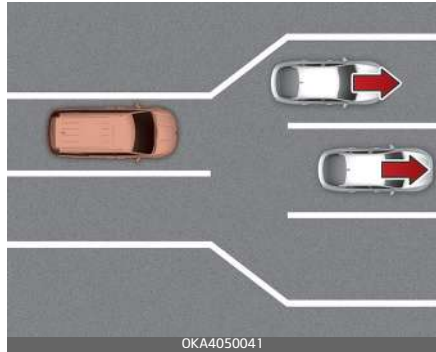

If you pass a tollgate or intersection with lots of vehicles or you drive where lanes are merged or divided frequently, Leading Vehicle Departure Alert may not operate properly.

CAUTION

For more details on the precautions of the front view camera, refer to "Forward Collision-Avoidance Assist (FCA) (Sensor fusion) (if equipped)" on page 5-61.

Blind-Spot View Monitor (BVM) (if equipped)

Left side

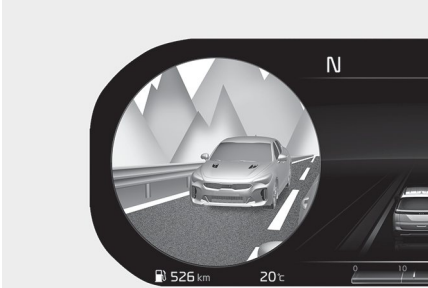

OKA4050577N

Right side

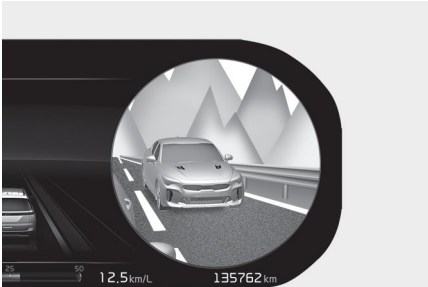

OKA4050578N

Blind-Spot View Monitor is a function that helps the driver safe driving by using the camera installed in the vehicle and displaying the rear blind spot area of the vehicle in the cluster when the turn signal is turned on.

Detecting sensor

SVM-side view camera



(camera located at bottom of the mirror)

Refer to the picture above for the detailed location of the detecting sensors.

Function settings

Blind-Spot View



- With the engine on, select 'Driver Assistance → Blind-Spot Safety → Blind Spot View' from the Settings menu to turn on Blind-Spot

View Monitor and deselect to turn off the function.

Setting

Blind-Spot View

With the engine on, select 'Driver Assistance → Blind-Spot Safety → Blind-Spot View' from the Settings menu to turn on Blind-Spot View Monitor and deselect to turn off the function.

Function operation

Operating switch

Turn signal switch

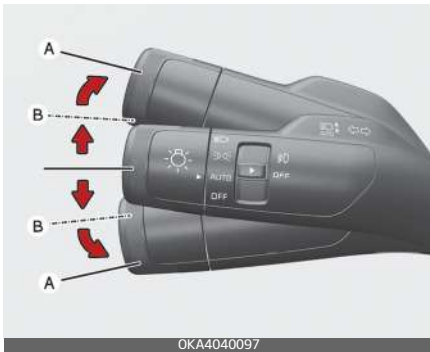

Blind-Spot View Monitor will turn on and off when the turn signal is turned on and off.

Blind-Spot View Monitor

Operating conditions

When the left or right side turn signal turns on, the image in that direction is displayed on the instrument cluster.

Off conditions

- When the turn signal turns off, the image on the instrument cluster will turn off.
- When the hazard warning flasher is on, Blind-Spot View Monitor will turn off, regardless of the turn signal status.
- When other important warning is displayed on the instrument cluster, Blind-Spot View Monitor may turn off.

Malfunction

When Blind-Spot View Monitor is not working properly, or the cluster display flickers, or the camera image does not display normally, have the function be inspected by an authorized Kia dealer.

If the camera lens is covered with foreign material, Blind-Spot View Monitor may not operate normally. Always keep the camera lens clean. However, do not use chemical solvents such as strong detergents containing high alkaline or volatile organic solvents (gasoline, acetone etc.). This may damage the camera lens.

Cruise Control (CC) (if equipped)



(1) Cruise indicator

(2) Set speed

Cruise Control will allow you to drive at speeds above 30 km/h (20 mph) without depressing the accelerator pedal.

Function operation

To set speed

1. Accelerate to the desired speed, which must be more than 30 km/h (20 mph).



2. Press the Driving Assist button at the desired speed. The set speed and Cruise (CC) indicator will illuminate on the cluster.
3. Release the accelerator pedal. Vehicle speed will maintain the set speed even when the accelerator pedal is not depressed.

* NOTICE

On a steep slope, the vehicle may slightly slow down or speed up while driving uphill or downhill.

To increase speed



- Push the + switch up and release it immediately. The cruising speed will increase by 1 km/h (1 mph) each time the switch is operated in this manner.
- Push the + switch up and hold it while monitoring the set speed on the cluster. The cruising speed will increase to the nearest multiple of ten (multiple of five in mph) at first, and then increase by 10 km/

h (5 mph) each time the switch is operated in this manner. Release the switch when the desired speed is shown and the vehicle will accelerate to that speed.

To decrease speed



OKA4040557N

- Push the - switch down and release it immediately. The cruising speed will decrease by 1 km/h (1 mph) each time the switch is operated in this manner.
- Push the - switch down and hold it while monitoring the set speed on the cluster. The cruising speed will decrease to the nearest multiple of ten (multiple of five in mph) at first, and then decrease by 10 km/h (5 mph) each time the switch is operated in this manner. Release the switch at the speed you want to maintain.

To temporarily accelerate

If you want to speed up temporarily when Cruise Control is on, depress the accelerator pedal.

To return to the set speed, take your foot off the accelerator pedal.

If you push the + switch up or - switch down at increased speed, the cruising speed will be set to the current increased speed.

To temporarily pause the function

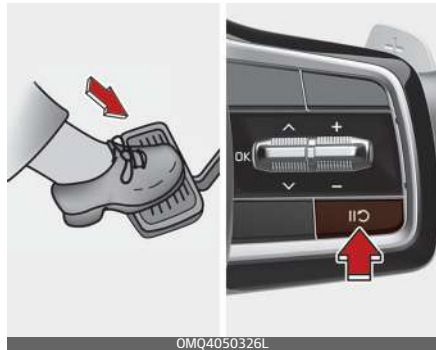

OMQ4050326L

Cruise Control will be paused when:

- Depressing the brake pedal.
- Pressing the (|| ⤵) button.
- Shifting the gear to N (Neutral).
- Decreasing vehicle speed to less than approximately 30 km/h (20 mph).
- ESC (Electronic Stability Control) is operating.
- Downshifting to 2nd gear when in Manual Shift mode.

The set speed will turn off but the Cruise (Ⓢ CRUISE) indicator will stay on.

* NOTICE

If Cruise Control pauses during a situation that is not mentioned, have the vehicle be inspected by an authorized Kia dealer.

To resume the function



Push the +, - switch or (||Ⓢ) button.

If you push the + switch up or - switch down, vehicle speed will be set to the current speed on the cluster.

If you press the (||Ⓢ) button, vehicle speed will resume to the preset speed.

Vehicle speed must be above 30 km/h (20 mph) for the function to resume.

⚠ WARNING

Check the driving condition before using the (||Ⓢ) button. Driving speed may sharply increase or decrease when you press the (||Ⓢ) button.

To turn off the function



Press the Driving Assist button to turn Cruise Control off. The Cruise (Ⓢ CRUISE) indicator will go off.

Always press the Driving Assist button to turn Cruise Control off when not in use.

⚠ WARNING

Take the following precautions when using Cruise Control:

- Always set the vehicle speed under the speed limit in your country.

- Keep Cruise Control off when the function is not in use, to avoid inadvertently setting a speed. Check that the Cruise (🚗 CRUISE) indicator is off.
- Cruise Control does not substitute for proper and safe driving. It is the responsibility of the driver to always drive safely and should always be aware of unexpected and sudden situations from occurring.
- Always drive cautiously to prevent unexpected and sudden situations from occurring. Pay attention to the road conditions at all times.
- Do not use Cruise Control when it may be unsafe to keep the vehicle at a constant speed:
 - When driving in heavy traffic, or when traffic conditions make it difficult to drive at a constant speed
 - When driving on rainy, icy, or snow-covered roads
 - When driving on hilly or windy roads
 - When driving in windy areas
 - When driving with limited view (possibly due to bad weather, such as fog, snow, rain and sandstorm)
- Do not use Cruise Control when towing a trailer.

Smart Cruise Control (SCC) (if equipped)

Smart Cruise Control is designed to detect the vehicle ahead and help maintain the desired speed and minimum distance with the vehicle ahead.

Overtaking Acceleration Assist

While Smart Cruise Control is operating, if the function judges that the driver is determined to overtake the vehicle in front, acceleration will be assisted.

Detecting sensor

Front view camera



Front radar



The front view camera and front radar are used as a detecting sensor to detect the vehicles in front.

Refer to the picture above for the detailed location of the detecting sensor.

⚠ CAUTION

Always keep the front view camera and front radar in good condition to maintain optimal performance of Smart Cruise Control. For more details on the precautions of the front view camera and front radar, refer to "Forward Collision-Avoidance Assist (FCA) (Sensor fusion) (if equipped)" on page 5-61.

Function settings

Setting

To turn on the function



- Press the Driving Assist button to turn on the function. The speed will be set to the current speed on the cluster.
- If there is no vehicle in front of you, the set speed will be maintained, but if there is a vehicle in front of you, the speed may decrease to maintain the distance to the vehicle ahead. If the vehicle ahead accelerates, your vehicle will travel at a steady cruising speed after accelerating to the set speed.

* NOTICE

- If your vehicle speed is between 0 ~ 30 km/h (0 ~ 20 mph) when you press the Driving Assist button, the Smart Cruise Control speed will be set to 30 km/h (20 mph).

- The Driving Assist button symbol may vary depending on your vehicle option.

To set vehicle distance



Each time the button is pressed, the vehicle distance changes as follows:

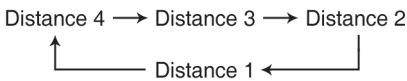

*** NOTICE**

- If you drive at 90 km/h (56 mph), the distance is maintained as follows:
 - Distance 4 - approximately 53 m (172 ft.)
 - Distance 3 - approximately 40 m (130 ft.)
 - Distance 2 - approximately 30 m (106 ft.)
 - Distance 1 - approximately 25 m (82 ft.)
- The distance is set to the last set distance when the engine is

restarted, or when the function was temporarily canceled.

To increase speed



- Push the + switch up and release it immediately. The cruising speed will increase by 1 km/h (1 mph) each time the switch is operated in this manner.
- Push the + switch up and hold it while monitoring the set speed on the cluster. The cruising speed will increase by 10 km/h (5 mph) each time the switch is operated in this manner. Release the switch when the desired speed is shown, and the vehicle will accelerate to that speed. You can set the speed to 180 km/h (110 mph).

⚠ WARNING

Check the driving condition before using the + switch. Driving speed may sharply increase when you push up and hold the + switch.

To decrease speed



- Push the - switch down and release it immediately. The cruising speed will decrease by 1 km/h (1 mph) each time the switch is operated in this manner.
- Push the - switch down and hold it while monitoring the set speed on the cluster. The cruising speed will decrease by 10 km/h (5 mph) each time the switch is operated in this manner.

Release the switch at the speed you want to maintain. You can set the speed to 30 km/h (20 mph).

To temporarily cancel the function

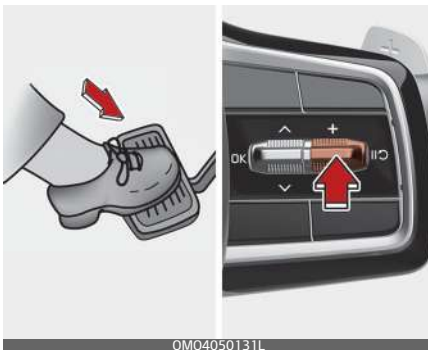

Press the (|| C) switch or depress the brake pedal to temporarily cancel Smart Cruise Control.

To resume the function



To resume Smart Cruise Control after the function was canceled, push the +, - or (|| C) switch.

If you push the + switch up or - switch down, vehicle speed will be set to the current speed on the cluster.

If you push the (|| C) switch, vehicle speed will resume to the preset speed.

⚠ WARNING

Check the driving condition before using the (|| C) switch. Driving speed may sharply increase or decrease when you press the (|| C) switch.

To turn off the function



OKA4040555N

Press the Driving Assist button to turn Smart Cruise Control off.

*** NOTICE**

If your vehicle is equipped with Manual Speed Limit Assist, press and hold the Driving Assist button to turn off Smart Cruise Control. However Manual Speed Limit Assist will turn on.

Based on Drive Mode

Smart Cruise Control will change acceleration based on the drive mode selected from Drive Mode Integrated Control function. Refer to the following chart.

Drive Mode	Smart Cruise Control
NORMAL	Normal
ECO	Slow
SPORT	Fast
SMART	Normal

*** NOTICE**

For more details on Drive Mode, refer to "Drive mode integrated control system" on page 5-44.

Warning volume

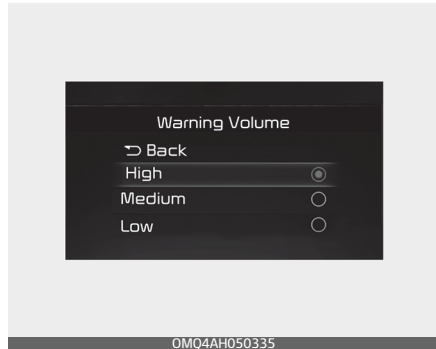

OMQ4AH050335

With the engine on, select 'Driver Assistance → Warning Volume' from the Settings menu to change the Warning Volume 'High', 'Medium', or 'Low' for Smart Cruise Control.

If you change the Warning Volume, the Warning Volume of other Driver Assistance systems may change.

*** NOTICE**

If the engine is restarted, Warning Volume will maintain the last setting.

Function operation

Operating conditions

Smart Cruise Control will operate when the following conditions are satisfied.

Basic function

- The gear is in D (Drive)
- The driver's door is closed
- EPB (Electronic Parking Brake) is not applied
- Your vehicle speed is within the operating speed range
 - 10 ~ 180 km/h (5 ~ 110 mph):
when there is no vehicle in front
 - 0 ~ 180 km/h (0 ~ 110 mph):
when there is a vehicle in front
- ESC (Electronic Stability Control), TCS (Traction Control System) or ABS is on
- ESC (Electronic Stability Control), TCS (Traction Control System) or ABS is on, but not controlling the vehicle
- Engine RPM is not in the red zone
- Forward Collision-Avoidance Assist brake control is not operating

*** NOTICE**

At a stop, if there is no vehicle in front of your vehicle, the function will turn on when the brake pedal is depressed.

Overtaking Acceleration Assist

Overtaking Acceleration Assist will operate when the turn signal indicator is turned on to the left (left-hand drive) or turned on to the right (right-hand drive) while Smart Cruise Control is operating, and the following conditions are satisfied:

- Your vehicle speed is above 60 km/h (40 mph)
- The hazard warning flasher is off
- A vehicle is detected in front of your vehicle
- Deceleration is not needed to maintain distance with the vehicle in front

⚠ WARNING

- When the left turn signal indicator is turned on to the left (left-hand drive) or turned on to the right (right-hand drive) while there is a vehicle ahead, the vehicle may accelerate temporarily. Pay attention to the road conditions at all times.
- Regardless of your countries driving direction, Overtaking Acceleration Assist will operate when the conditions are satisfied. When using the function in countries with different driving direction, always check the road conditions at all times.

Function display and control

Basic function

You can see the status of the Smart Cruise Control operation in the Driving Assist mode on the cluster. Refer to "Driving Assist mode" on page 4-109.

Smart Cruise Control will be displayed as below depending on the status of the function.

- When operating



1. Whether there is a vehicle ahead and the selected distance level are displayed.
2. Set speed is displayed.
3. Whether there is a vehicle ahead and the selected target distance are displayed.

- When temporarily canceled



1. (⊗) CRUISE indicator is displayed.
2. The previous set speed is shaded.

* NOTICE

- The distance of the front vehicle on the cluster is displayed according to the actual distance between your vehicle and the vehicle ahead.
- The target distance may vary according to the vehicle speed and the set distance level. If vehicle speed is low, even though the vehicle distance have changed, the change of the target vehicle distance may be small.

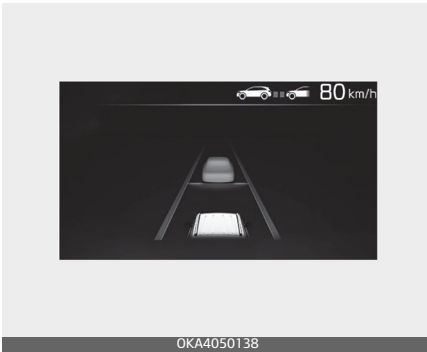
To temporarily accelerate

If you want to speed up temporarily when Smart Cruise Control is on, depress the accelerator pedal. While the speed is increasing, the set speed, distance level and target distance will blink on the cluster.

⚠ WARNING

Be careful when accelerating temporarily, because the speed and distance is not controlled automatically even if there is a vehicle in front of you.

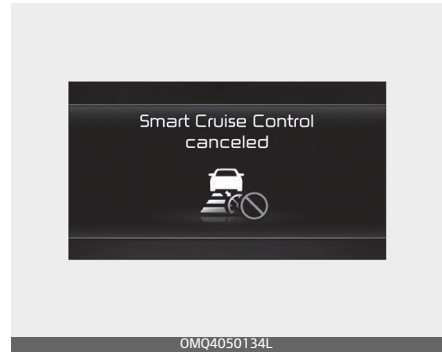
Function temporarily canceled

Smart Cruise Control will be temporarily canceled automatically when:

- The vehicle speed is above 190 km/h (120 mph)
- The vehicle is stopped for a certain period of time
- The accelerator pedal is continuously depressed for a certain period of time
- The conditions for the Smart Cruise Control to operate is not satisfied

If the function is temporarily canceled automatically, the 'Smart Cruise Control canceled' (or 'SCC (Smart Cruise Control) cancelled') warning message will appear on the cluster, and an audible warning will sound to warn the driver.

If the Smart Cruise Control is temporarily canceled while the vehicle is at a standstill with the function operating, EPB (Electronic Parking Brake) maybe applied.

⚠ WARNING

When the function is temporarily canceled, distance with the front vehicle will not be maintained. Always have your eyes on the road while driving, and if necessary, depress the brake pedal to reduce your driving speed in order to maintain a safe distance.

Function conditions not satisfied



If the Driving Assist button, + switch, - switch or (|) (⌚) switch is pushed when the function's operating conditions are not satisfied, the 'Smart Cruise Control conditions not met' (or SCC (Smart Cruise Ctrl. conditions not met')) will appear on the cluster, and an audible warning will sound.

In traffic situation

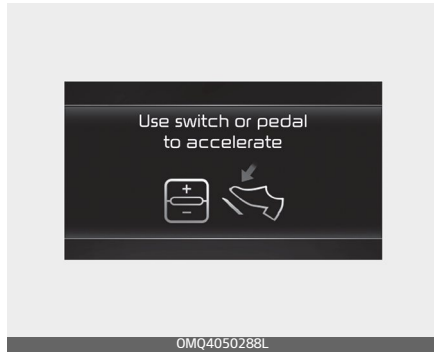

In traffic, your vehicle will stop if the vehicle ahead of you stops. Also, if the vehicle ahead of you starts moving, your vehicle will start as well.

In addition, after the vehicle has stopped and a certain time have passed, the 'Use switch or pedal to accelerate' message will appear on the cluster. Depress the accelerator pedal or push the + switch, - switch or (|) (⌚) switch to start driving.

⚠ WARNING

While the message is displayed on the cluster, if there is no vehicle in front or the vehicle is far away from you, and the + switch, - switch or (|) (⌚) switch is pushed, Smart Cruise Control will automatically cancel and the EPB will be applied. However, if the accelerator pedal is depressed, EPB will not be applied even though the function is canceled. Always pay

attention to the road condition ahead.

Warning road conditions ahead



OKA4050139L

In the following situation, the 'Watch for surrounding vehicles' warning message will appear on the cluster, and an audible warning will sound to warn the driver of road conditions ahead.

- The vehicle in front disappears when Smart Cruise Control is maintaining the distance with the vehicle ahead while driving below a certain speed.
- While the 'Use switch or pedal to accelerate' message is displayed on the cluster, if there is no vehicle in front or the vehicle is far away from you, and the + switch, – switch or (|| ☺) switch is pushed.

⚠ WARNING

Always pay attention to vehicles or objects that may suddenly appear in front of you, and if necessary, depress the brake pedal to reduce your driving speed in order to maintain a safe distance.

Collision warning



OKA4050134L

While Smart Cruise Control is operating, when the collision risk with the vehicle ahead is high, the 'Collision Warning' warning message will appear on the cluster, and an audible warning will sound to warn the driver. Always have your eyes on the road while driving, and if necessary, depress the brake pedal to reduce your driving speed in order to maintain a safe distance.

⚠ WARNING

In the following situations, Smart Cruise Control may not warn the driver of a collision.

- The distance from the front vehicle is near, or the vehicle speed of the front vehicle is faster or similar with your vehicle
- The speed of the front vehicle is very slow or is at a standstill
- The accelerator pedal is depressed right after Smart Cruise Control is turned on

⚠ WARNING

Take the following precautions when using Smart Cruise Control:

- Smart Cruise Control does not substitute for proper and safe driving. It is the responsibility of the driver to always check the speed and distance to the vehicle ahead.
- Smart Cruise Control may not recognize unexpected and sudden situations or complex driving situations, so always pay attention to driving conditions and control your vehicle speed.
- Keep Smart Cruise Control off when the function is not in use to avoid inadvertently setting a speed.
- Do not open the door or leave the vehicle when Smart Cruise Control

is operating, even if the vehicle is stopped.

- Always be aware of the selected speed and vehicle to vehicle distance.
- Keep a safe distance according to road conditions and vehicle speed. If the vehicle to vehicle distance is too close during high-speed driving, a serious collision may result.
- When maintaining distance with the vehicle ahead, if the front vehicle disappears, the function may suddenly accelerate to the set speed. Always be aware of unexpected and sudden situations from occurring.
- Vehicle speed may decrease on an upward slope and increase on a downward slope.
- Always be aware of situations such as when a vehicle cuts in suddenly.
- When you are towing a trailer or another vehicle, we recommend that Smart Cruise Control is turned off due to safety reasons.
- Turn off Smart Cruise Control when your vehicle is being towed.
- Smart Cruise Control may not operate normally if interfered by strong electromagnetic waves.
- Smart Cruise Control may not detect an obstacle in front and lead to a collision. Always look ahead cautiously to prevent unexpected and sudden situations from occurring.

- Vehicles moving in front of you with a frequent lane change may cause a delay in the function's reaction or may cause the function to react to a vehicle actually in an adjacent lane. Always drive cautiously to prevent unexpected and sudden situations from occurring.
- Always be aware of the surroundings and drive safely, even though a warning message does not appear or an audible warning does not sound.
- If any other function's warning message is displayed or warning sound is generated, Smart Cruise Control warning message may not be displayed and warning sound may not be generated.
- You may not hear the warning sound of Smart Cruise Control if the surrounding is noisy.
- The vehicle manufacturer is not responsible for any traffic violation or accidents caused by the driver.
- Always set the vehicle speed under the speed limit in your country.

* NOTICE

- Smart Cruise Control may not operate for 15 seconds after the vehicle is started or the front view camera or front radar is initialized.
- You may hear a sound when the brake is controlled by Smart Cruise Control.

Malfunction and limitations

Malfunction

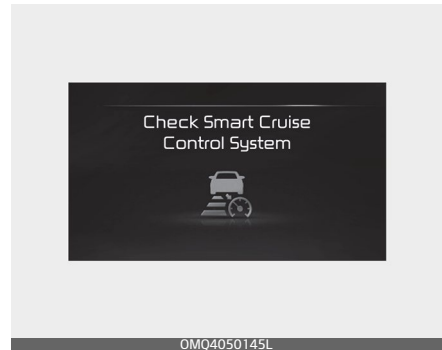

When Smart Cruise Control is not working properly, the 'Check Smart Cruise Control system' (or 'Check SCC (Smart Cruise Control) system') warning message will appear, and the (⚠) warning light will illuminate on the cluster. Have the function be inspected by an authorized Kia dealer.

Function disabled

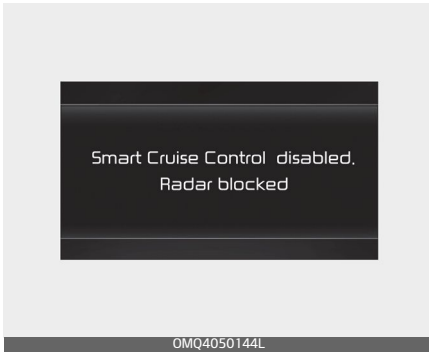

When the front radar cover or sensor is covered with snow, rain, or foreign material, it can reduce the detecting performance and temporarily limit or disable Smart Cruise Control.

If this occurs, the 'Smart Cruise Control disabled. Radar blocked' (or 'SCC (Smart Cruise Control) disabled. Radar blocked') warning message will appear for a certain period of time on the cluster.

The function will operate normally when snow, rain or foreign material is removed.

⚠ WARNING

- Even though the warning message does not appear on the cluster, Smart Cruise Control may not properly operate.
- Smart Cruise Control may not properly operate in an area (e.g. open terrain), where there is

nothing to detect after turning ON the engine.

Limitations

Smart Cruise Control may not operate normally, or the function may operate unexpectedly under the following circumstances:

- The detecting sensor or the surroundings are contaminated or damaged
- Washer fluid is continuously sprayed, or the wiper is on
- The camera lens is contaminated due to tinted, filmed or coated windshield, damaged glass, or stuck of foreign material (sticker, bug, etc.) on the glass
- Moisture is not removed or frozen on the windshield
- The field of view of the front view camera is obstructed by sun glare
- Street light or light from an oncoming vehicle is reflected on the wet road surface, such as a puddle on the road
- The temperature around the front view camera is high or low
- An object is placed on the dashboard
- The surrounding is very bright
- The surrounding is very dark, such as in a tunnel, etc.
- The brightness changes suddenly, for example when entering or exiting a tunnel

- The brightness outside is low, and the headlamps are not on or are not bright
- Driving in heavy rain or snow, or thick fog
- Driving through steam, smoke or shadow
- Only part of the vehicle is detected
- The vehicle in front has no tail lights, tail lights are located unusually, etc.
- The brightness outside is low, and the tail lamps are not on or are not bright
- The rear of the front vehicle is small or does not look normal (i.e. tilted, overturned, etc.)
- The front vehicle's ground clearance is low or high
- A vehicle suddenly cuts in front
- Your vehicle is being towed
- Driving through a tunnel or iron bridge
- Driving near areas containing metal substances, such as a construction zone, railroad, etc.
- A material is near that reflects very well on the front radar, such as a guardrail, nearby vehicle, etc.
- The bumper around the front radar is impacted, damaged or the front radar is out of position
- The temperature around the front radar is high or low
- Driving in large areas where there are few vehicles or structures (i.e. desert, meadow, suburb, etc.)
- The vehicle in front is made of material that does not reflect on the front radar
- Driving near a highway (or motorway) interchange or tollgate
- Driving on a slippery surface due to snow, water puddle, ice, etc.
- Driving on a curved road
- The vehicle in front is detected late
- The vehicle in front is suddenly blocked by an obstacle
- The vehicle in front suddenly changes lane or suddenly reduces speed
- The vehicle in front is bent out of shape
- The front vehicle's speed is fast or slow
- With a vehicle in front, your vehicle changes lane at low speed
- The vehicle in front is covered with snow
- Unstable driving
- You are on a roundabout and the vehicle in front is not detected
- You are continuously driving in a circle
- Driving in a parking lot
- Driving through a construction area, unpaved road, partial paved road, uneven road, speed bumps, etc.
- Driving on an incline road, curved road, etc.
- Driving through a roadside with trees or streetlights
- Your vehicle is moving unstable

- The adverse road conditions cause excessive vehicle vibrations while driving
- Your vehicle height is low or high due to heavy loads, abnormal tire pressure, etc.
- Driving through a narrow road where trees or grass are over-grown
- There is interference by electromagnetic waves, such as driving in an area with strong radio waves or electrical noise
- Driving on a curve



On curves, Smart Cruise Control may not detect a vehicle in the same lane, and may accelerate to the set speed. Also, vehicle speed may rapidly decrease when the vehicle ahead is detected suddenly. Select the appropriate set speed on curves and apply the brake pedal or accelerator pedal according to the road and driving conditions ahead.

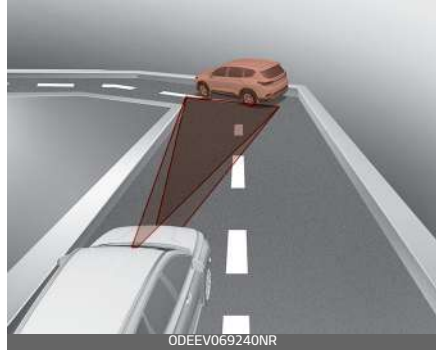

Your vehicle speed can be reduced due to a vehicle in the adjacent lane. Apply the accelerator pedal and select the appropriate set speed. Check to be sure that the road conditions permit safe operation of the Smart Cruise Control.

- Driving on a slope



During uphill or downhill driving, the Smart Cruise Control may not detect a moving vehicle in your lane, and cause your vehicle to accelerate to the set speed. Also, vehicle speed will rapidly decrease

when the vehicle ahead is detected suddenly. Select the appropriate set speed on inclines and apply the brake pedal or accelerator pedal according to the road and driving conditions ahead.

- Changing lanes

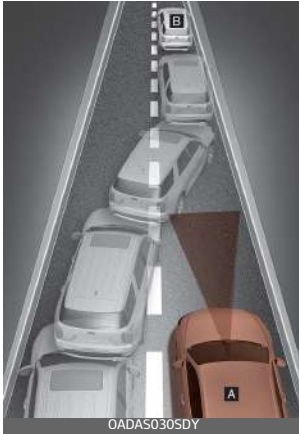

[A]: Your vehicle

[B]: Lane changing vehicle

When a vehicle moves into your lane from an adjacent lane, it cannot be detected by the sensor until it is in the sensor's detection range. Smart Cruise Control may not immediately detect the vehicle when the vehicle changes lanes abruptly. In this case, you must maintain a safe braking distance, and if necessary, depress the brake pedal to reduce your driving speed in order to maintain a safe distance.

- Detecting vehicle



In the following cases, some vehicles in your lane cannot be detected by the sensor:

- Vehicles offset to one side
- Slow-moving vehicles or sudden-decelerating vehicles
- Oncoming vehicles
- Stopped vehicles
- Vehicles with small rear profile, such as trailers
- Narrow vehicles, such as motorcycles or bicycles
- Special vehicles
- Animals and pedestrians

Adjust your vehicle speed by depressing the brake pedal according to the road and driving conditions ahead.



In the following cases, the vehicle in front cannot be detected by the sensor:

- Vehicles with higher ground clearance or vehicles carrying loads that stick out of the back of the vehicle
- Vehicles that has the front lifted due to heavy loads
- You are steering your vehicle
- Driving on narrow or sharply curved roads

Adjust your vehicle speed by depressing the brake pedal according to the road and driving conditions ahead.



- When a vehicle ahead disappears at an intersection, your vehicle may accelerate. Always pay attention to road and driving conditions while driving.

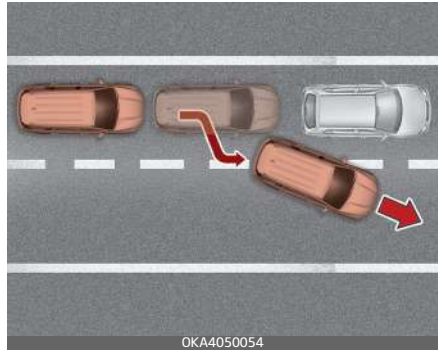

- When a vehicle in front of you merges out of the lane, Smart Cruise Control may not immediately detect the new vehicle that is now in front of you. Always pay attention to road and driving conditions while driving.

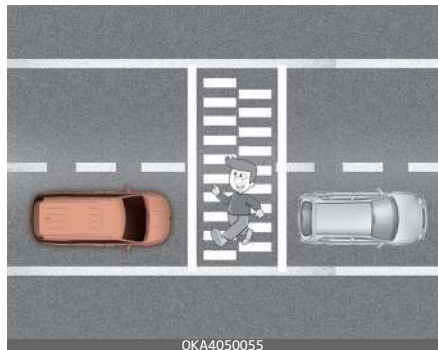

- Always look out for pedestrians when your vehicle is maintaining a distance with the vehicle ahead.

This device complies with Industry Canada licence-exempt RSS standard(s).

Operation is subject to the following conditions:

1. This device may not cause interference, and
2. This device must accept any interference, including interference that may cause undesired operation of the device.
3. Changes or modifications not expressly approved by the party responsible for compliance could void the user's authority to operate the device.

Navigation-based Smart Cruise Control (NSCC) (if equipped)

Navigation-based Smart Cruise Control will help automatically adjust vehicle speed when driving on highways (or motorways) by using road information from the navigation function while Smart Cruise Control is operating.

* NOTICE

- The Navigation-based Smart Cruise Control is available only on controlled access road of certain highways.
- * Controlled access road indicates roads with limited entrances and exits that allow uninterrupted high speed traffic flow. Only passenger cars and motorcycles are allowed on controlled access roads.

Available highway (Controlled access road)

USA	Select Interstate Highway and U.S. (Federal) and State Highways
Canada	Select Provincial and Territorial Highways

- Additional highways may be expanded by future navigation updates.

* NOTICE

Navigation-based Smart Cruise Control operates on main roads of highways (or motorways), and does not operate on interchanges or junctions.

Navigation-based Smart Cruise Control (NSCC) is a supplemental system and is not a substitute for safe driving. It is the responsibility of the driver to always check the speed and distance to the vehicle ahead. Always drive safely and use caution.

Highway Curve Zone Auto Slowdown

If vehicle speed is high, Highway Curve Zone Auto Slowdown function will temporarily decelerate your vehicle or limit acceleration to help you drive safely on a curve based on the curve information from the navigation.

Highway Set Speed Auto Change

Highway Set Speed Auto Change function automatically changes Smart Cruise Control set speed based on the speed limit information from the navigation.

Function settings

Setting

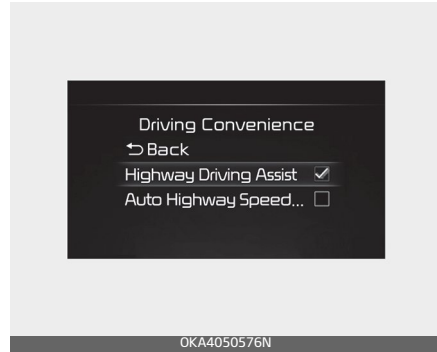

With the engine on, select 'Driver Assistance → Driving Convenience → Highway Auto Speed Change' from the Settings menu to turn on Navigation-based Smart Cruise Control and deselect to turn off the function.

* NOTICE

When there is a problem with Navigation-based Smart Cruise Control, the function cannot be set from the Settings menu.

Function operation

Operating conditions

Navigation-based Smart Cruise Control is ready to operate if all of the following conditions are satisfied:

- Smart Cruise Control is operating
- Driving on main roads of highways (or motorways)

* NOTICE

For more details on how to operate Smart Cruise Control, refer to "Smart Cruise Control (SCC) (if equipped)" on page 5-126.

Function display and control

When Navigation-based Smart Cruise Control operates, it will be displayed on the cluster as follows:

Function standby

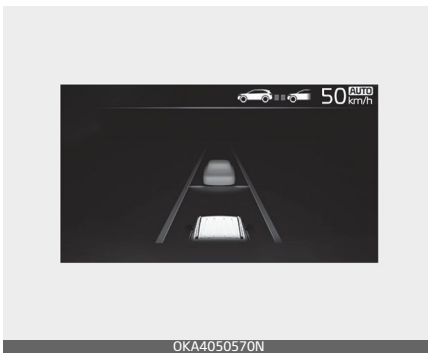

If the operating conditions are satisfied, the white (AUTO) symbol will illuminate.

Function operating



If temporary deceleration is required in the standby state and Navigation-based Smart Cruise Control is operating, the green (AUTO) symbol will illuminate on the cluster.

If the Highway Set Speed Auto Change function operates, the green (AUTO) symbol and set speed will illuminate on the cluster, and an audible warning will sound.

⚠ WARNING

'Drive carefully' warning message will appear in the following circumstances:



- Navigation-based Smart Cruise Control is not able to slow down your vehicle to a safe speed

*** NOTICE**

Highway Curve Zone Auto Slowdown and Set Speed Auto Change function uses the same (AUTO) symbol.

Highway Curve Zone Auto Slowdown

- Depending on the curve ahead on the highway (or motorway), the vehicle will decelerate, and after passing the curve, the vehicle will accelerate to Smart Cruise Control set speed.
- Vehicle deceleration time may differ depending on the vehicle speed and the degree of the curve

on the road. The higher the driving speed, deceleration will start faster.

Highway Set Speed Auto Change

- Highway Set Speed Auto Change function will operate when Smart Cruise Control set speed and the highway (or motorway) speed limit is matched.
- While Highway Set Speed Auto Change function is operating, when the highway (or motorway), speed limit changes, Smart Cruise Control set speed automatically changes to the changed speed limit.
- If Smart Cruise Control set speed is adjusted different from the speed limit, Highway Set Speed Auto Change function will be in the standby state.
- If Highway Set Speed Auto Change function has changed to the standby state by driving on a road other than the highway (or motorway) main road, Highway Set Speed Auto Change function will operate again when you drive on the main road again without setting the set speed.
- If Highway Set Speed Auto Change function has changed to the standby state by depressing the brake pedal or pressing the (||⊙) switch on the steering

wheel, press the (|| ↻) switch to restart the function.

- Highway Set Speed Auto Change function does not operate on highway interchanges or junctions.

* NOTICE

- Highway Set Speed Auto Change function only operates based on the speed limits of the highway (or motorway), it does not work with the speed cameras.
- When Highway Set Speed Auto Change function is operating, the vehicle automatically accelerates or decelerates when the highway (or motorway) speed limit changes.
- The maximum set speed for Highway Set Speed Auto Change function is 140 km/h (86 mph).
- If the speed limit of a new road is not updated in the navigation, Highway Set Speed Auto Change function may not operate properly.
- If the speed unit is set to a unit other than the speed unit used in your country, Highway Set Speed Auto Change function may not operate properly.

Limitations

Navigation-based Smart Cruise Control may not operate normally under the following circumstances:

- The navigation is not working properly
- Speed limit and road information in the navigation is not updated
- The map information and the actual road is different because of real-time GPS data or map information error
- The navigation searches for a route while driving
- GPS signals are blocked in areas such as a tunnel
- The navigation is being updated while driving
- Map information is not transmitted due to infotainment system's abnormal operation
- A road that divides into two or more roads and joins again
- The driver goes off course the route set in the navigation
- The route to the destination is changed or canceled by resetting the navigation
- The vehicle enters a service station or rest area
- The speed limit of some sections changes according to the road situations
- Android Auto or Car Play is operating
- The navigation cannot detect the current vehicle position (ex: ele-

vated roads including overpass adjacent to general roads or nearby roads exist in a parallel way)

- The navigation is being updated while driving
- The navigation is being restarted while driving
- There is bad weather, such as heavy rain, heavy snow, etc.
- Driving on a road under construction
- Driving on a road that is controlled
- Driving on a road that is sharply curved
- Driving on roads with intersections, roundabouts, straight entrances and exits, etc.

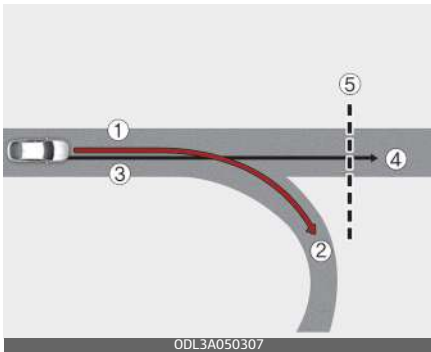

[1]: Set route, [2]: Branch line, [3]: Driving route, [4]: Main road, [5]: Curved road section

- When there is a difference between the navigation set route (branch line) and the driving route (main road), Highway Curve Zone Auto Slowdown function may not

operate until the driving route is recognized as the main road.

- When the vehicle's driving route is recognized as the main road by maintaining the main road instead of the navigation set route, Highway Curve Zone Auto Slowdown function will operate. Depending on the distance to the curve and the current vehicle speed, vehicle deceleration may not be sufficient or may decelerate rapidly.

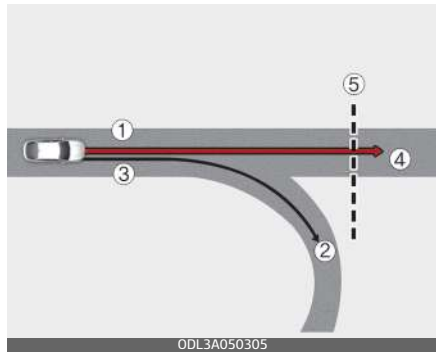

[1]: Set route, [2]: Branch line, [3]: Driving route, [4]: Main road, [5]: Curved road section

- When there is a difference between the navigation route (main road) and the driving route (branch line), Highway Curve Zone Auto Slowdown function will operate based on the curve information on the main road.
- When it is judged that you are driving out of the route by entering the highway interchange or junction, Highway Curve Zone

Auto Slowdown function will not operate.

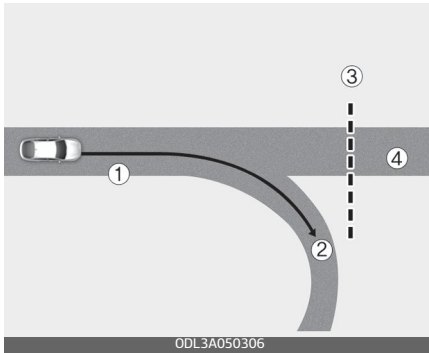

[1]: Driving route, [2]: Branch line, [3]: Curved road section, [4]: Main road

- If there is no destination set on the navigation, Highway Curve Zone Auto Slowdown function will operate based on the curve information on the main road.
- Even if you depart from the main road, Highway Curve Zone Auto Slowdown function may temporarily operate due to navigation information of the highway curve section.

⚠ WARNING

- Navigation-based Smart Cruise Control is not a substitute for safe driving practices, but a convenience function. Always have your eyes on the road, and it is the responsibility of the driver to avoid violating traffic laws.
- The navigation's speed limit information may differ from the

actual speed limit information on the road. It is the driver's responsibility to check the speed limit on the actual driving road or lane.

- Navigation-based Smart Cruise Control will automatically be canceled when you leave the highway (or motorway) main road. Always pay attention to road and driving conditions while driving.
- Navigation-based Smart Cruise Control may not operate due to the existence of leading vehicles and the driving conditions of the vehicle. Always pay attention to road and driving conditions while driving.
- When you are towing a trailer or another vehicle, we recommend that Navigation-based Smart Cruise Control is turned off due to safety reasons.
- After you pass through a tollgate on a highway (or motorway), Navigation-based Smart Cruise Control will operate based on the first lane. If you enter one of the other lanes, the function might not operate properly.
- The vehicle will accelerate if the driver depresses the accelerator pedal while Navigation-based Smart Cruise Control is operating, and the function will not decelerate the vehicle.

- If the driver accelerates and releases the accelerator pedal while Navigation-based Smart Cruise Control is operating, the vehicle may not decelerate sufficiently or may rapidly decelerate to a safe speed.
 - If the curve is too large or too small, Navigation-based Smart Cruise Control may not operate.
-

*** NOTICE**

- The time gap could occur between the navigation's guidance and when Navigation-based Smart Cruise Control operation starts and ends.
 - The speed information on the cluster and navigation may differ.
 - Even if you are driving at a speed lower than Smart Cruise Control set speed, acceleration may be limited by the curve sections ahead.
 - If Navigation-based Smart Cruise Control is operating while leaving the main road to enter an interchange, junction, rest area, etc., the function may operate for a certain period of time.
 - Deceleration by Navigation-based Smart Cruise Control may feel it is not sufficient due to road conditions such as uneven road surfaces, narrow lanes, etc.
-

This device complies with Industry Canada licence-exempt RSS standard(s).

Operation is subject to the following conditions:

1. This device may not cause interference, and
2. This device must accept any interference, including interference that may cause undesired operation of the device.
3. Changes or modifications not expressly approved by the party responsible for compliance could void the user's authority to operate the device.

Lane Following Assist (LFA)

Lane Following Assist is designed to help detect lane markings and/or vehicles on the road, and assists the driver's steering to help keep the vehicle in the lane.

Detecting sensor

Front view camera



The front view camera is used as a detecting sensor to detect lane markings and vehicles in front.

Refer to the picture above for the detailed location of the detecting sensor.

CAUTION

For more details on the precautions of the front view camera, refer to "Forward Collision-Avoidance Assist (FCA) (Sensor fusion) (if equipped)" on page 5-61.

Function settings

Setting

Turning On/Off



With the engine on, shortly press the Lane Driving Assist button located on the steering wheel to turn on Lane Following Assist. The white or green (🚗) indicator light will illuminate on the cluster.

Press the button again to turn off the function.

Warning volume

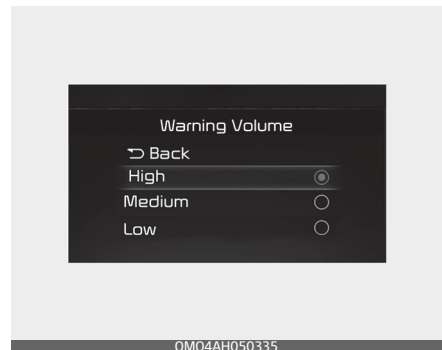

With the engine on, select 'Driver Assistance → Warning Volume' from the Settings menu to change the Warning Volume to 'High', 'Medium', or 'Low' for Hands-off warning.

If you change the Warning Volume, the Warning Volume of other Driver Assistance systems may change.

Function operation

Warning and control

Lane Following Assist



If the vehicle ahead and/or both lane markings are detected and your vehicle speed is below 200 km/h (120 mph), the green (🚘) indicator light will illuminate on the cluster, and the function will help center the vehicle in the lane by assisting the steering wheel.

⚠ CAUTION

When the steering wheel is not assisted, the green (🚘) indicator light will blink and change to white.

Hands-off warning

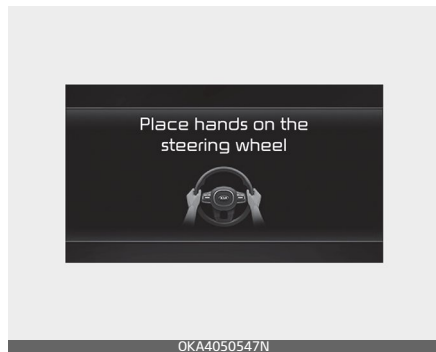

If the driver takes their hands off the steering wheel for several seconds, the 'Place hands on the steering wheel' (or 'Keep hands on the steering wheel') warning message will appear and an audible warning will sound in stages.

First stage: Warning message

Second stage: Warning message (red steering wheel) and audible warning



0MQ4040509L

If the driver still does not have their hands on the steering wheel after the hands-off warning, the 'Lane Following Assist (LFA) canceled' (or 'LFA (Lane Following Assist) cancelled') warning message will appear and Lane Following Assist will be automatically canceled.

⚠ WARNING

- Lane Following Assist does not operate at all times. It is the responsibility of the driver to safely steer the vehicle and to maintain the vehicle in its lane.
- The hands-off warning message may appear late depending on road conditions. Always have your hands on the steering wheel while driving.
- If the steering wheel is held very lightly the hands-off warning message may appear because the function may not recognize that the driver has their hands on the steering wheel.

- If you attach objects to the steering wheel, the hands-off warning may not work properly.

*** NOTICE**

- You may change settings from the instrument cluster (User Settings) or infotainment system (Vehicle Settings), whichever option that is provided with your vehicle. For more details, see "User settings mode" on page 4-110, or "Vehicle Settings" section in supplied Infotainment Manual.
- When both lane markings are detected, the lane lines on the cluster will change from grey to white.

Lane undetected



OKA4050128

Lane detected



- If lane markings are not detected, steering wheel control by Lane Following Assist can be limited depending on whether a vehicle is in front or the driving conditions of the vehicle.
- Even though the steering is assisted by Lane Following Assist, the driver may control the steering wheel.
- The steering wheel may feel heavier or lighter when the steering wheel is assisted by Lane Following Assist than when it is not.

Malfunction and limitations

Malfunction

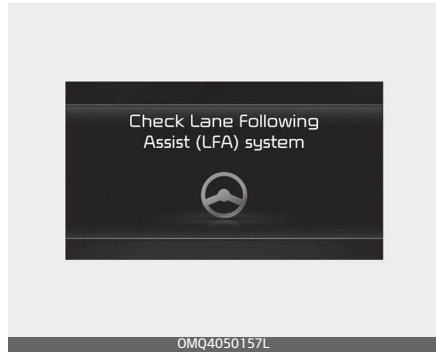

When Lane Following Assist is not working properly, the 'Check Lane Following Assist (LFA) system' (or 'Check LFA (Lane Following Assist) system') warning message warning message will appear on the cluster. If this occurs, have the function be inspected by an authorized Kia dealer.

Limitations

For more details on function limitations, refer to "Lane Keeping Assist (LKA)" on page 5-77.

Highway Driving Assist (HDA) (if equipped)

Basic function



Highway Driving Assist is designed to help detect vehicles and lanes ahead, and help maintain distance from the vehicle ahead, maintain the set speed, and help center the vehicle in the lane while driving on the highway (or motorway).

* NOTICE

- Highway Driving Assist is available only on controlled access road of certain highways.
- * Controlled access road indicates roads with limited entrances and exits that allow uninterrupted high speed traffic flow. Only passenger cars and motorcycles are allowed on controlled access roads.

Available highway (Controlled access road)

USA	Select Interstate Highway and U.S. (Federal) and State Highways
Canada	Select Provincial and Territorial Highways

- Additional highways may be expanded by future navigation updates.

Detecting sensor

Front view camera



Front radar



Refer to the picture above for the detailed location of the detecting sensors.

⚠ CAUTION

For more details on the precautions of the detecting sensors, refer to "Forward Collision-Avoidance Assist (FCA) (Sensor fusion) (if equipped)" on page 5-61.

Function settings

Setting

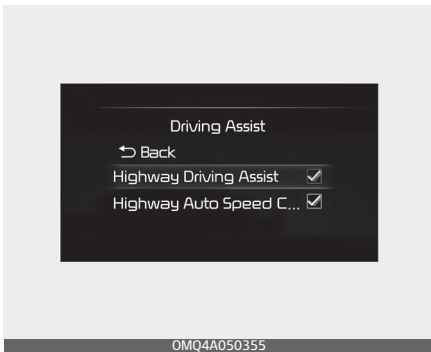

With the engine on, select or deselect 'Driver Assistance → Driving Assist' from the Settings menu to set whether or not to use each function(s).

- If 'Highway Driving Assist' (or 'HDA (Motorway Driving Assist)') is selected, it helps maintain distance from the vehicle ahead, maintain the set speed, and helps center the vehicle in the lane.

*** NOTICE**

- If there is a problem with the function(s), the settings cannot be changed. Have the function be inspected by an authorized Kia dealer.
- If the engine is restarted, the function(s) will maintain the last setting.

⚠ WARNING

For your safety, change the Settings after parking the vehicle at a safe location.

Warning volume

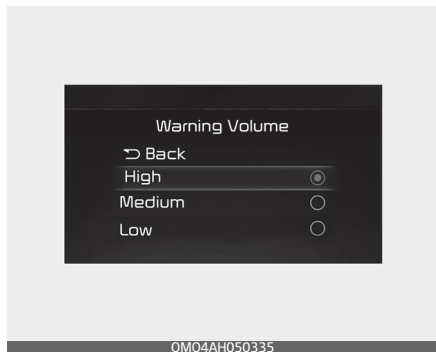

With the engine on, select 'Driver Assistance → Warning Volume' from the Settings menu to change the Warning Volume to 'High', 'Medium', or 'Low' for Highway Driving Assist.

If you change the Warning Volume, the Warning Volume of other Driver Assistance systems may change.

Function operation

Function display and control

You can see the status of the Highway Driving Assist operation in the Driving Assist mode on the cluster. Refer to "Driving Assist mode" on page 4-109.

Highway Driving Assist will be displayed as below depending on the status of the function.

Operating State

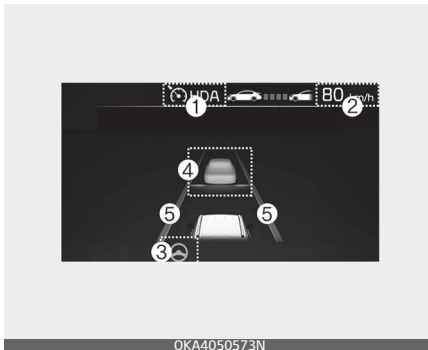

Standby State



1. Highway Driving Assist indicator, whether there is a vehicle ahead

and the selected distance level are displayed.

- Highway Driving Assist indicator
 - Green (HDA): Operating state
 - White (HDA): Standby state
2. Set speed is displayed.
 3. Lane Following Assist indicator displayed.
 4. Whether there is a vehicle ahead and the selected vehicle to vehicle distance are displayed.
 5. Whether the lane is detected or not is displayed.

* For more details and limitations of Lane Following Assist, refer to "Lane Following Assist (LFA)" on page 5-151.

* For more details and limitations of Smart Cruise Control, refer to "Smart Cruise Control (SCC) (if equipped)" on page 5-126.

Function operating

Highway Driving Assist will operate when entering or driving on the main road of highways (or motorways), and satisfying all the following conditions:

- Lane Following Assist is operating
- Smart Cruise Control is operating

*** NOTICE**

- While driving on the highway (or motorway), if Smart Cruise Control starts operating, Highway Driving Assist will operate.
- When entering the main roads of highways (or motorways), Highway Driving Assist will not turn on if the Lane Following Assist is turned off even when Smart Cruise Control is operating.

Restarting after stopping

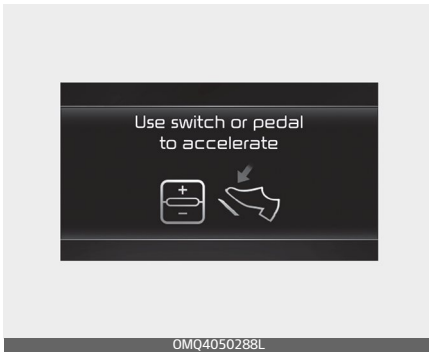

When Highway Driving Assist is operating, your vehicle will stop if the vehicle ahead of you stops. Also, if the vehicle ahead of you starts moving within 30 seconds after the stop, your vehicle will start as well. In addition, after the vehicle has stopped and approximately 30 seconds have passed, the 'Use switch or pedal to accelerate' message will appear on the cluster. Depress the accelerator pedal or push the +

switch, - switch or (|| ⊞) switch to start driving.

Hands-off warning

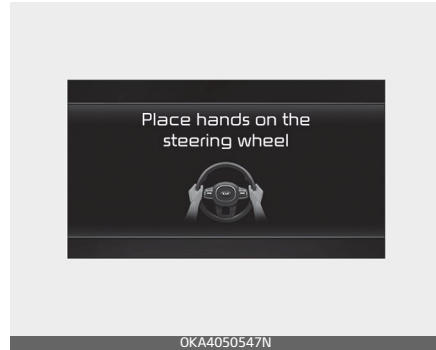

If the driver takes their hands off the steering wheel for several seconds, the 'Place hands on the steering wheel' (or 'Keep hands on the steering wheel') warning message will appear and an audible warning will sound in stages.

- First stage: Warning message
- Second stage: Warning message (red steering wheel) and audible warning

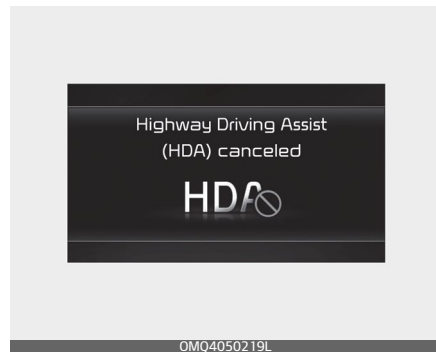

If the driver still does not have their hands on the steering wheel after the hands-off warning, the 'Highway Driving Assist (HDA) canceled' (or 'HDA (Highway Driving Assist) cancelled') warning message will appear and Highway Driving Assist and Lane Change Assist will be automatically canceled.

Function standby

When the Smart Cruise Control is temporarily canceled while Highway Driving Assist is operating, Highway Driving Assist will be in the standby state. At this time, Lane Following Assist will operate normally.

Malfunction and limitations

Malfunction

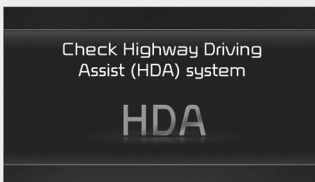

OMQ4050220L

When Highway Driving Assist or Highway Lane Change function is not working properly, the 'Check Highway Driving Assist (HDA) system' (or 'Check HDA (Motorway

Driving Assist) system') warning message will appear, and the (⚠️) warning light will illuminate on the cluster. Have the function be inspected by an authorized Kia dealer.

⚠️ WARNING

- The driver is responsible for controlling the vehicle for safe driving.
- Always have your hands on the steering wheel while driving.
- Highway Driving Assist is a supplemental function that assists the driver in driving the vehicle and is not a complete autonomous driving system. Always check road conditions, and if necessary, take appropriate actions to drive safely.
- Always have your eyes on the road, and it is the responsibility of the driver to avoid violating traffic laws. The vehicle manufacturer is not responsible for any traffic violation or accidents caused by the driver.
- Highway Driving Assist may not be able to recognize all traffic situations. The function may not detect possible collisions due to Limitations. Always be aware of the Limitations. Obstacles such as vehicles, motorcycles, bicycles, pedestrians, unspecified objects/structures such as guardrail and

tollgate, etc. that may collide with the vehicle may not be detected.

- Highway Driving Assist will turn off automatically under the following situations:
 - Driving on roads that the function does not operate, such as a rest area, intersection, junction, etc.
 - The navigation does not operate properly such as when the navigation is being updated or restarted
- Highway Driving Assist may inadvertently operate or turn off depending on road conditions (navigation information) and surroundings.
- Lane Following Assist function may be temporarily disabled when the front view camera cannot detect lanes properly or the hands-off warning is on.
- You may not hear the warning sound of Highway Driving Assist if the surrounding is noisy.
- If the vehicle is driven at high speed above a certain speed at a curve, your vehicle may drive to one side or may depart from the driving lane.
- When you are towing a trailer or another vehicle, we recommend that Highway Driving Assist is turned off due to safety reasons.
- The hands-off warning message may appear early or late depending on how the steering wheel is

held or road conditions. Always have your hands on the steering wheel while driving.

- For your safety, please read the owner's manual before using the Highway Driving Assist.
 - Highway Driving Assist will not operate when the engine is started, or when the detecting sensors or navigation is being initialized.
-

Limitations

Highway Driving Assist and Highway Lane Change function may not operate normally, or may not operate under the following circumstances:

- The map information and the actual road is different because the navigation is not updated
- The map information and the actual road is different because of real-time GPS data or map information error
- The infotainment system is overloaded by simultaneously performing functions such as route search, video playback, voice recognition, etc.
- GPS signals are blocked in areas such as a tunnel
- The driver goes off course or the route to the destination is changed or canceled by resetting the navigation

- The vehicle enters a service station or rest area
- Android Auto or Car Play is operating
- The navigation cannot detect the current vehicle position (ex: elevated roads including overpass adjacent to general roads or nearby roads exist in a parallel way)

CAUTION

For more details on the limitations of the front view camera and front radar, refer to "Forward Collision-Avoidance Assist (FCA) (Sensor fusion) (if equipped)" on page 5-61.

This device complies with Industry Canada licence-exempt RSS standard(s).

Operation is subject to the following conditions:

1. This device may not cause interference, and
2. This device must accept any interference, including interference that may cause undesired operation of the device.
3. Changes or modifications not expressly approved by the party responsible for compliance could void the user's authority to operate the device.

Rear Cross-Traffic Collision-Avoidance Assist (RCCA) (if equipped)

Rear Cross-Traffic Collision-Avoidance Assist is designed to help detect vehicles approaching from the left and right side while your vehicle is reversing, and warn the driver that a collision is imminent with a warning message and an audible warning. Also, braking is assisted to help prevent collision.

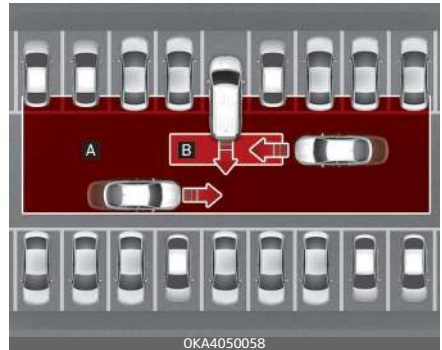

[A]: Rear Cross-Traffic Collision Warning operating range

[B]: Rear Cross-Traffic Collision-Avoidance Assist operating range

CAUTION

The time of warning may vary depending on vehicle speed of the approaching vehicle.

*** NOTICE**

In the following text, Rear Cross-Traffic Collision Assist will be referred as Rear Cross-Traffic Safety system.

Detecting sensor

Rear corner radar



Refer to the picture above for the detailed location of the detecting sensor.

⚠ CAUTION

For more details on the precautions of the rear corner radar, refer to "Blind-Spot Collision-Avoidance Assist (BCA) (if equipped)" on page 5-84.

Function settings

Setting

Rear Cross-Traffic Safety



With the engine on, select 'Driver Assistance → Parking Safety → Rear Cross-Traffic Safety' from the Settings menu to turn on Rear Cross-Traffic Safety system and deselect to turn off the system.

⚠ WARNING

When the engine is restarted, Rear Cross-Traffic Safety system will always turn on. However, if 'Off' is selected after the engine is restarted, the driver should always be aware of the surroundings and drive safely.

*** NOTICE**

Settings for Rear Cross-Traffic Safety system include Rear Cross-Traffic Collision Warning and Rear Cross-Traffic Collision-Avoidance Assist.

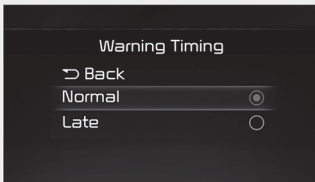
Warning timing

OMQ4AH050334

With the engine on, select 'Driver Assistance → Warning Timing' from the Settings menu to change the initial warning activation time for Rear Cross-Traffic Safety system.

When the vehicle is first delivered, Warning Timing is set to 'Normal'. If you change the Warning Timing, the warning time of other Driver Assistance systems may change.

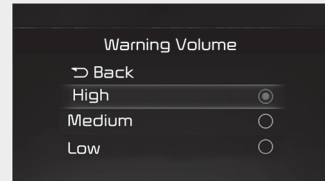
Warning volume

OMQ4AH050335

With the engine on, select 'Driver Assistance → Warning Volume' from the Settings menu to change the Warning Volume to 'High', 'Medium', or 'Low' for Rear Cross-Traffic Safety system.

If you change the Warning Volume, the Warning Volume of other Driver Assistance systems may change.

⚠ CAUTION

- The setting of the Warning Timing and Warning Volume applies to all functions of the Rear Collision-Avoidance Assist.
- Even though 'Normal' is selected for Warning Timing, if the vehicles from the left and right side approaches at high speed, the initial warning activation time may seem late.
- Select 'Late' for Warning Timing when traffic is light and when driving speed is slow.

*** NOTICE**

If the engine is restarted, Warning Timing and Warning Volume will maintain the last setting.

Function operation

Function warning and control

Rear Cross-Traffic Safety system will warn and control the vehicle depending on collision level: 'Collision Warning', 'Emergency Braking' and 'Stopping vehicle and ending brake control'.

Collision warning

Left



Right



[A]: audible warning

- To warn the driver of an approaching vehicle from the rear left/right side of your vehicle, the warning light on the outside rear-

view mirror will blink and a warning will appear on the cluster. At the same time, an audible warning will sound. If the Rear View Monitor is operating, a warning will also appear on the infotainment system screen.

- The function will operate when all the following conditions are satisfied:
 - The gear is shifted to R (Reverse)
 - Vehicle speed is below 8 km/h (5 mph)
 - The approaching vehicle is within approximately 25 m (82 ft.) from the left and right side of your vehicle
 - The speed of the vehicle approaching from the left and right is above 5 km/h (3 mph)

* NOTICE

If the operating conditions are satisfied, there will be a warning whenever the vehicle approaches from the left or right side even though your vehicle speed is 0 km/h (0 mph).

Emergency braking



- To warn the driver of an approaching vehicle from the rear left/right side of your vehicle, the warning light on the outside rear-view mirror will blink and a warning message will appear on the cluster. At the same time, an audible warning will sound. If the Rear View Monitor is operating, a warning will also appear on the infotainment system screen.
- The function will operate when all the following conditions are satisfied:
 - The gear is shifted to R (Reverse)
 - Vehicle speed is below 8 km/h (5 mph)
 - The approaching vehicle is within approximately 1.5 m (5 ft.) from the left and right side of your vehicle
 - The speed of the vehicle approaching from the left and right is above 5 km/h (3 mph)

- Emergency braking will be assisted to help prevent collision with approaching vehicles from the left and right.

*** NOTICE**

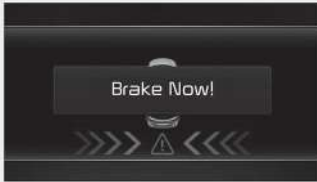

OKA4050132L

Brake control will end when:

- The approaching vehicle is out of the detecting range
- The approaching vehicle passes behind your vehicle
- The approaching vehicle does not drive toward your vehicle
- The approaching vehicle speed slows down
- The driver depresses the brake pedal with sufficient power

Stopping vehicle and ending brake control



OKA4050123L

- When the vehicle is stopped due to emergency braking, the 'Drive carefully' warning message will appear on the cluster.
- For your safety, the driver should depress the brake pedal immediately and check the surroundings.
- Brake control will end after the vehicle is stopped by emergency braking for approximately 2 seconds.
- During emergency braking, braking control by the function will automatically cancel when the driver excessively depresses the brake pedal.

⚠ WARNING

Take the following precautions when using Rear Cross-Traffic Safety system:

- For your safety, change the Settings after parking the vehicle at a safe location.

- If any other function's warning message is displayed or audible warning is generated, Rear Cross-Traffic Safety function's warning message may not be displayed and audible warning may not be generated.
- You may not hear the warning sound of Rear Cross-Traffic Safety system if the surrounding is noisy.
- Rear Cross-Traffic Safety system may not operate if the driver applies the brake pedal to avoid collision.
- During Rear Cross-Traffic Safety Function Operation, the vehicle may stop suddenly injuring passengers and shifting loose objects. Always have the seat belt on and keep loose objects secured.
- Even if there is a problem with Rear Cross-Traffic Safety system, the vehicle's basic braking performance will operate normally.
- Rear Cross-Traffic Safety system does not operate in all situations or cannot avoid all collisions.
- During emergency braking, braking control by the function will automatically cancel when the driver excessively depresses the accelerator pedal.
- The driver should hold the responsibility to control the vehicle. Do not solely depend on Rear

Cross-Traffic Safety system. Rather, maintain a safe braking distance, and if necessary, depress the brake pedal to reduce driving speed or to stop the vehicle.

- Never deliberately operate Rear Cross-Traffic Safety system on people, animal, objects, etc. It may cause serious injury or death.

⚠ CAUTION

The brake control may not operate properly depending on the status of ESC (Electronic Stability Control).

There will only be a warning when:

- The ESC (Electronic Stability Control) warning light is on
- ESC (Electronic Stability Control) is engaged in a different function

*** NOTICE**

- If the function assists you with braking, the driver needs to pay attention as the brake assist will end within 2 seconds. The driver must immediately depress the brake pedal and check vehicle surroundings.
- Brake control will end when the driver depresses the brake pedal with sufficient power.
- After shifting the gear to R (Reverse), braking control will

operate once for left and right vehicle approach.

Malfunction and limitations

Malfunction

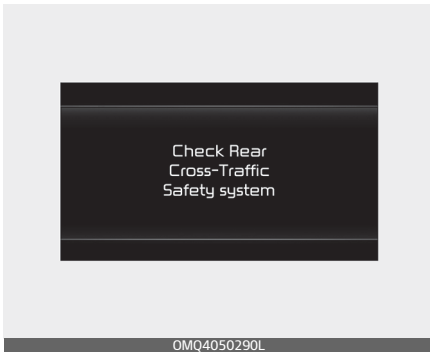

When Rear Cross-Traffic Safety system is not working properly, the 'Check Rear Cross-Traffic Safety system(s)' warning message will appear on the cluster, and the function will turn off automatically or the function will be limited. Have the function be inspected by an authorized Kia dealer.

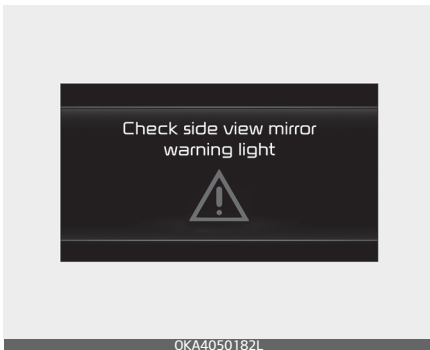

When the outside rearview mirror warning light is not working properly, the 'Check side view mirror warning light' (or 'Check outside mirror warning icon') warning message will appear on the cluster. Have the function be inspected by an authorized Kia dealer.

Function disabled

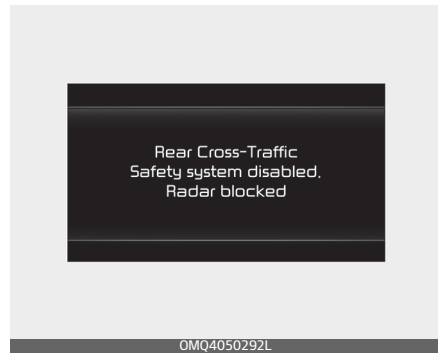

When the rear bumper around the rear corner radar or rear sensor is covered with foreign material, such as snow or rain, or installing a trailer or carrier, it can reduce the detecting performance and temporarily limit or disable Rear Cross-Traffic Safety system.

If this occurs, the 'Rear Cross-Traffic Safety system disabled. Radar blocked' (or 'Rear cross-traffic safety functions disabled. Radar blocked') warning message will appear on the cluster.

The function will operate normally when such foreign material or trailer, etc. is removed.

If the function does not operate normally after it is removed, have the function be inspected by an authorized Kia dealer.

* NOTICE

- Even though the warning message does not appear on the cluster, Rear Cross-Traffic Safety system may not operate properly.
- Rear Cross-Traffic Safety system may not operate properly in an area (for example: open terrain), where any substance are not detected after turning ON the engine.

⚠ CAUTION

Turn off Rear Cross-Traffic Safety system to install a trailer, carrier, etc., or remove the trailer, carrier, etc. to use Rear Cross-Traffic Safety system.

Limitations

Rear Cross-Traffic Safety system may not operate normally, or the function may operate unexpectedly under the following circumstances:

- Departing from where trees or grass are overgrown
- Departing from where roads are wet
- Speed of the approaching vehicle is fast or slow

Braking control may not work, driver's attention is required in the following circumstances:

- The vehicle severely vibrates while driving over a bumpy road, uneven road or concrete patch
- Driving on a slippery surface due to snow, water puddle, ice, etc.
- The tire pressure is low or a tire is damaged
- The brake is reworked

⚠ CAUTION

For more details on the limitations of the rear corner radar, refer to "Blind-Spot Collision-Avoidance Assist (BCA) (if equipped)" on page 5-84.

⚠ WARNING

- Driving near a vehicle or structure

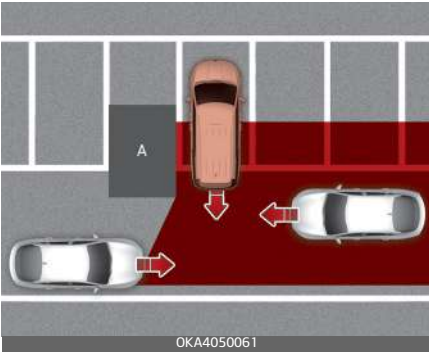

[A]: Structure

Rear Cross-Traffic Safety system may be limited when driving near a vehicle or structure, and may not detect the vehicle approaching from the left or right. If this occurs, the function may not warn the driver or control the brakes when necessary. Always check your surroundings while backing up.

- When the vehicle is in a complex parking environment

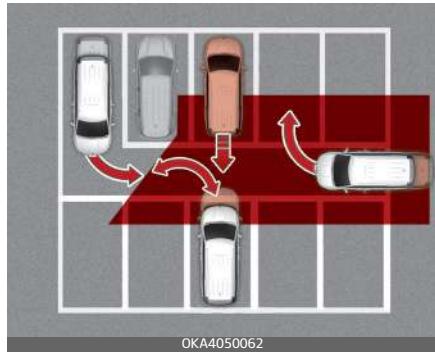

Rear Cross-Traffic Safety system may detect vehicles which are parking or pulling out near your vehicle (for example: a vehicle leaving beside your vehicle, a vehicle parking or pulling out in the rear area, a vehicle approaching your vehicle making a turn, etc.). If this occurs, the function may unnecessarily warn the driver and control the brake. Always check your surroundings while backing up.

Driving your vehicle

- When the vehicle is parked diagonally



[A]: Vehicle

Rear Cross-Traffic Safety system may be limited when backing up diagonally, and may not detect the vehicle approaching from the left or right. If this occurs, the function may not warn the driver or control the brakes when necessary.

Always check your surroundings while backing up.

- When the vehicle is on or near a slope

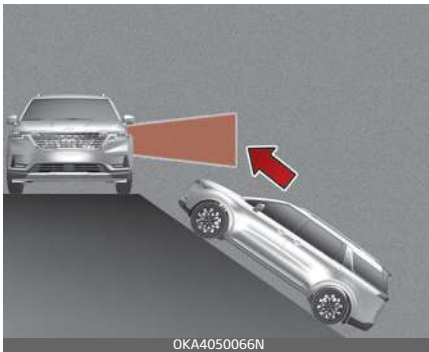

Rear Cross-Traffic Collision-Avoidance Assist (RCCA)

Rear Cross-Traffic Safety system may be limited when the vehicle is on a uphill or downhill slope, or near it, and may not detect the vehicle approaching from the left or right. If this occurs, the function may not warn the driver or control the brakes when necessary. Always check your surroundings while backing up.

⚠ WARNING

- Pulling into the parking space where there is a structure

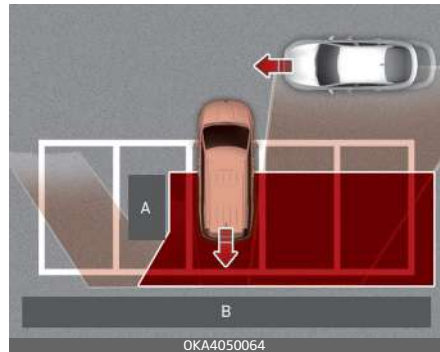

[A]: Structure, [B]: Wall

Rear Cross-Traffic Safety system may detect vehicles passing by in front of you when parking backwards into a parking space with a wall or structure in the rear or side area. If this occurs, the function may unnecessarily warn the driver and control the brake. Always check your surroundings while backing up.

- When the vehicle is parked rearward

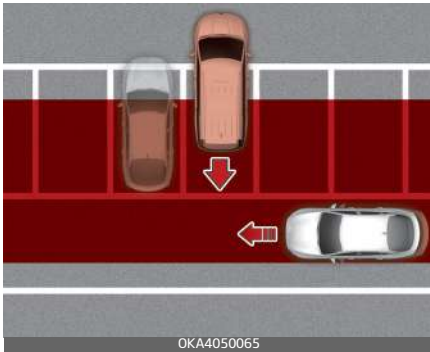

Rear Cross-Traffic Safety system may detect vehicles passing by behind you when parking backwards into a parking space. If this occurs, the function may unnecessarily warn the driver and control the brake. Always check your surroundings while backing up.

⚠ WARNING

- When you are towing a trailer or another vehicle, we recommend that Rear Cross-Traffic Safety system is turned off due to safety reasons.
- Rear Cross-Traffic Safety system may not operate normally if interfered by strong electromagnetic waves.
- Rear Cross-Traffic Safety system may not operate for 3 seconds after the vehicle is started, or the rear corner radars are initialized.

This device complies with Industry Canada licence-exempt RSS standard(s).

Operation is subject to the following two conditions:

1. This device may not cause interference, and
2. This device must accept any interference, including interference that may cause undesired operation of the device.

Reverse Parking Collision-Avoidance Assist (PCA) (if equipped)

Reverse Parking Collision-Avoidance Assist may warn the driver or may assist with braking to help reduce the possibility of collision with a pedestrian or an object when backing up.

Detecting sensor

Rear view camera



Rear ultrasonic sensors



Refer to the picture above for the detailed location of the detecting sensors.

Function settings

Setting

Parking Safety

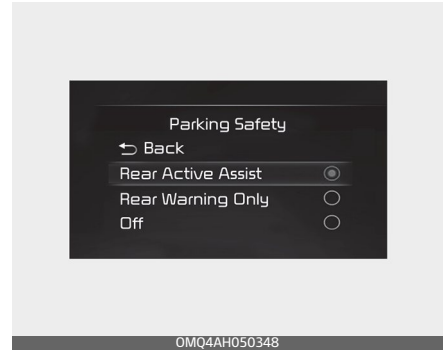

With the engine on, select or deselect 'Driver Assistance → Parking Safety' from the Settings menu to set whether or not to use each function.

- If 'Rear Active Assist' is selected, the function will be in the ready status. The function will warn the driver and assist with braking when a collision with a pedestrian or an object is imminent.
- If 'Rear Warning Only' (or 'Rear warning only') is selected, the function will warn the driver when a collision with a pedestrian or an object is imminent. Braking will not be assisted.
- If 'Off' is selected, the function will turn off.
- Press Park Safety (**P** _{OFF}) button for 2 seconds and more to set

whether or not to use 'Rear Active Assist' or 'Rear Warning Only'.

Warning timing

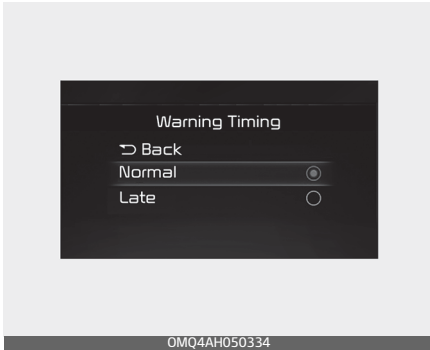

With the engine on, select 'Driver Assistance → Warning Timing' from the Settings menu to change the initial warning activation time for Forward Collision-Avoidance Assist.

If 'Normal' is selected, the Warning Timing is set to Normal. If 'Normal' feels sensitive, change the settings to 'Late'.

If you change the Warning Timing, the warning time of other Driver Assistance systems may change.

Warning volume

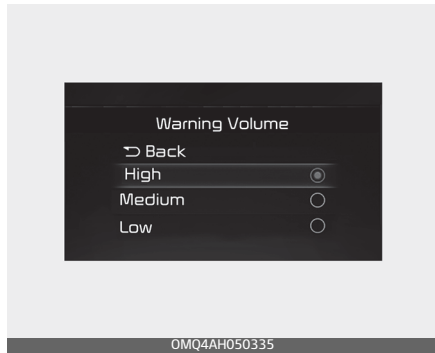

With the engine on, select 'Driver Assistance → Warning Volume' from the Settings menu to change the Warning Volume to 'High', 'Medium', or 'Low' for Forward Collision-Avoidance Assist.

If you change the warning volume, the Warning Volume of other Driver Assistance systems may change.

Function operation

Operating conditions

If 'Rear Active Assist' or 'Rear Warning Only' is set from the Settings menu, Reverse Parking Collision-Avoidance Assist will be in the ready status when the following conditions are satisfied:

- The liftgate is closed
- The gear is shifted to R (Reverse)
- Vehicle speed is below 10 km/h (6 mph)
- Function components such as the rear view camera and the rear

ultrasonic sensors are in normal conditions

When Reverse Parking Collision-Avoidance Assist activates, a line appears behind the vehicle image in the instrument cluster.

Reverse Parking Collision-Avoidance Assist operates only once after the gear is shifted to R (Reverse). To reactivate Reverse Parking Collision-Avoidance Assist, shift the gear from another gear to R (Reverse).



OKA4050535N

Rear Active Assist

- If the function detects a risk of collision with a pedestrian or an object, the function will warn the driver with an audible warning and warning message on the cluster. When Rear View Monitor is operating, a warning will appear on the infotainment system screen.
- If the function detects imminent collision with a pedestrian or an object behind the vehicle, the function will assist you with braking. The driver needs to pay

attention as the brake assist will end within 2 seconds. The driver must immediately depress the brake pedal and check vehicle surroundings.

- Brake control will end when:
 - The gear is shifted to P (Park) or D (Drive).
 - The driver depresses the brake pedal with sufficient power
 - Braking assist last for approximately 2 seconds
 - If brake assist has last for approximately 5 minutes, EPB (Electronic Parking Brake) is engaged and at the same time braking assist will be released.
- The warning will turn off when:
 - The driver changes the gear to P (Park), N (Neutral), or D (Drive)
- The brake control may not operate properly depending on the status of ESC (Electronic Stability Control).
- There will only be a warning when:
 - The ESC (Electronic Stability Control) warning light is on
 - ESC (Electronic Stability Control) is engaged in a different function

Rear Warning Only

- If the function detects a risk of collision with a pedestrian or an object, the function will warn the driver with an audible warning and warning message on the cluster. When Rear View Monitor is operating, a warning will appear on the infotainment system screen.
- If 'Rear Warning Only' is selected, braking will not be assisted.
- The warning will turn off when the gear is shifted to P (Park), N (Neutral) or D (Drive).

Malfunction and limitations

Malfunction

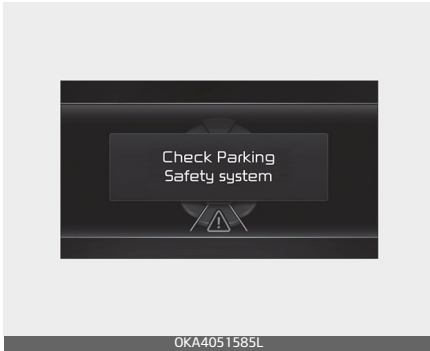

When Reverse Parking Collision-Avoidance Assist or other related systems are not working properly, the 'Check Parking Safety system' warning message will appear on the cluster, and the function will turn off automatically. Have your vehicle inspected by an authorized Kia dealer.

Function disabled



The rear view camera is used as a detecting sensor to detect pedestrians. If the camera lens is covered with foreign material, such as snow or rain, it may adversely affect camera performance and Reverse Parking Collision-Avoidance Assist may not operate normally. Always keep the camera lens clean.



The rear ultrasonic sensors are located inside the rear bumper to detect objects in the rear area. If the sensors are covered with foreign material, such as snow or rain, it may adversely affect sensor per-

formance and Reverse Parking Collision–Avoidance Assist may not operate normally. Always keep the rear bumper clean.

Rear view camera

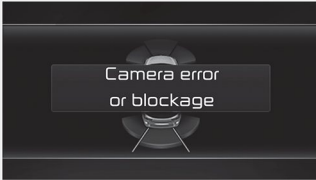

OKA4050545N

Rear ultrasonic sensor

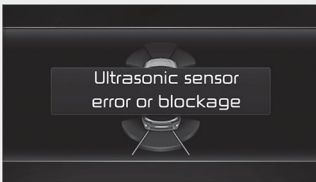

OKA4050548N

The 'Camera error or blockage' or 'Ultrasonic sensor error or blockage' warning message will appear on the cluster if the following situations occur:

- The rear view camera or ultrasonic sensors are covered with foreign material, such as snow or rain, etc.

- There is inclement weather, such as heavy snow, heavy rain, etc.

If this occurs, Reverse Parking Collision–Avoidance Assist may turn off or may not operate properly. Check whether the rear view camera and rear ultrasonic sensors are clean.

Limitations

Reverse Parking Collision–Avoidance Assist may not assist braking or warn the driver even if there are pedestrians or objects under the following circumstances:

- Any non-factory equipment or accessory is installed
- Your vehicle is unstable due to an accident or other causes
- Bumper height or rear ultrasonic sensor installation has been modified
- Rear view camera or rear ultrasonic sensor(s) is damaged
- Rear view camera or the rear ultrasonic sensor(s) is stained with foreign matter, such as snow, dirt, etc.
- Rear view camera is obscured by a light source or by inclement weather, such as heavy rain, fog, snow, etc.
- The surrounding is very bright or very dark
- Outside temperature is very high or very low

- The wind is either strong (above 12 mph (20 km/h)) or blowing perpendicular to the rear bumper
- Objects generating excessive noise, such as vehicle horns, loud motorcycle engines or truck air brakes, are near your vehicle
- An ultrasonic sensor with similar frequency is near your vehicle
- There is ground height difference between the vehicle and the pedestrian
- The image of the pedestrian in the rear view camera is indistinguishable from the background
- The pedestrian is near the rear edge of the vehicle
- The pedestrian is not standing upright
- The pedestrian is either very short or very tall for the function to detect
- The pedestrian or cyclist is wearing clothing that easily blends into the background, making it difficult to detect
- The pedestrian is wearing clothing that does not reflect ultrasonic waves well
- Size, thickness, height, or shape of the object does not reflect ultrasonic waves well (e.g., pole, bush, curbs, carts, edge of a wall, etc.)
- The pedestrian or the object is moving fast

- The pedestrian or the object is very close to the rear of the vehicle
- A wall is behind the pedestrian or the object
- The object is not located at the rear center of your vehicle
- The object is not parallel to the rear bumper
- The road is slippery or inclined
- The driver backs up the vehicle immediately after shifting to R (Reverse)
- The driver accelerates or circles the vehicle

Reverse Parking Collision–Avoidance Assist may unnecessarily warn the driver or assist with braking even if there are no pedestrians or objects under the following circumstances:

- Any non–factory equipment or accessory is installed
- Your vehicle is unstable due to an accident or other causes
- Bumper height or rear ultrasonic sensor installation has been modified
- Your vehicle height is low or high due to heavy loads, abnormal tire pressure, etc.
- Rear view camera or the rear ultrasonic sensor(s) is stained with foreign matter, such as snow, dirt, etc.
- The pattern on the road is mistaken for a pedestrian

- There is shadow or light reflecting on the ground
- Pedestrians or objects are around the path of the vehicle
- Objects generating excessive noise, such as vehicle horns, loud motorcycle engines or truck air brakes, are near your vehicle
- Your vehicle is backing towards a narrow passage or parking space
- Your vehicle is backing towards an uneven road surface, such as an unpaved road, gravel, bump, gradient, etc.
- A trailer or carrier is installed on the rear of your vehicle
- An ultrasonic sensor with similar frequency is near your vehicle

WARNING

Take the following precautions when using Reverse Parking Collision-Avoidance Assist:

- Always pay extreme caution while driving. The driver is responsible for controlling the brake for safe driving.
- Always pay attention to road and traffic conditions while driving, whether or not there is a warning.
- Always look around your vehicle to make sure there are no pedestrians or objects before moving the vehicle.
- The performance of Reverse Parking Collision-Avoidance Assist may vary under certain condi-

- tions. If vehicle speed is above 4 km/h (2 mph), the function will provide collision avoidance assist only when pedestrians are detected. Always look around and pay attention when backing up your vehicle.
- Some objects may not be detected by the rear ultrasonic sensors due to the objects distance, size or material, all of which can limit the effectiveness of the sensor.
- Reverse Parking Collision-Avoidance Assist may not operate properly or may operate unnecessarily depending on the road conditions and the surroundings.
- Do not solely rely on the function. Doing so may lead to vehicle damage or injuries.

CAUTION

- Noise may be heard when sudden braking occurs to avoid a collision.
- If any other warning sound such as the seat belt warning chime is already generated, Reverse Parking Collision-Avoidance Assist warning may not sound.
- The function may not work properly if the bumper has been damaged, replaced or repaired.
- Reverse Parking Collision-Avoidance Assist may not operate normally if interfered by strong electromagnetic waves.

- Playing the vehicle audio system at high volume may prevent passengers from hearing Reverse Parking Collision-Avoidance Assist warning sounds.
 - Turn off Reverse Parking Collision-Avoidance Assist when towing a trailer. If towing and moving in reverse, Reverse Parking Collision-Avoidance Assist will activate as it detects the trailer.
-

⚠ CAUTION

Take the following precautions to maintain optimal performance of the detecting sensors:

- Always keep the rear view camera and rear ultrasonic sensors clean.
- Do not use any cleanser containing acid or alkaline detergents when cleaning the rear view camera lens. Use only a mild soap or neutral detergent, and rinse thoroughly with water.
- Do not spray the rear view camera or the rear ultrasonic sensors or their surrounding area directly with a high pressure washer. It may cause the rear view camera or the rear ultrasonic sensors to malfunction.
- Do not apply objects, such as a bumper sticker or a bumper guard, near the rear view camera or rear ultrasonic sensors or apply paint to the bumper. Doing so

may adversely affect the performance of the function.

- Never disassemble or apply impact on the rear view camera or the rear ultrasonic sensors components.
 - Do not apply unnecessary force on the rear view camera or the rear ultrasonic sensors. The function may not operate properly if the rear view camera or the rear ultrasonic sensor(s) is forcibly moved out of proper alignment. Have the vehicle be inspected by an authorized Kia dealer.
 - The brake control may not work properly depending on the status of ESC (Electronic Stability Control). There will only be a warning when:
 - The ESC (Electronic Stability Control) warning light is on
 - ESC (Electronic Stability Control) is engaged in a different function
-

*** NOTICE**

Reverse Parking Collision-Avoidance Assist can detect a pedestrian or an object when:

- A pedestrian is standing behind the vehicle
 - A large obstacle, such as a vehicle, is parked in the rear center of your vehicle
-

Economical operation

Your vehicle's fuel economy depends mainly on your style of driving, where you drive and when you drive.

Each of these factors affects how many kilometers (miles) you can get from a liter (gallon) of fuel. To operate your vehicle as economically as possible, use the following driving suggestions to help save money in both fuel and repairs:

- Drive smoothly. Accelerate at a moderate rate. Don't make "jack-rabbit" starts or full-throttle shifts and maintain a steady cruising speed. Don't race between stoplights. Try to adjust your speed to the traffic so you don't have to change speeds unnecessarily. Avoid heavy traffic whenever possible.

Always maintain a safe distance from other vehicles so you can avoid unnecessary braking. This also reduces brake wear.

- Drive at a moderate speed. The faster you drive, the more fuel your vehicle uses. Driving at a moderate speed, especially on the highway, is one of the most effective ways to reduce fuel consumption.
- Take care of your tires. Keep them inflated to the recommended pressure. Incorrect inflation, either too much or too little, results in unnecessary tire wear.

Check the tire pressures at least once a month.

- Be sure that the wheels are aligned correctly. Improper alignment can result from hitting curbs or driving too fast over irregular surfaces. Poor alignment causes faster tire wear and may also result in other problems as well as greater fuel consumption.
- Keep your vehicle in good condition. For better fuel economy and reduced maintenance costs, maintain your vehicle in accordance with the maintenance schedule in "Scheduled maintenance service" on page 7-9. If you drive your vehicle in severe conditions, more frequent maintenance is required (Refer to "Maintenance under severe usage conditions" on page 7-14).
- Travel lightly. Don't carry unnecessary weight in your vehicle. Weight reduces fuel economy.
- Don't let the engine idle longer than necessary. If you are waiting (and not in traffic), turn off your engine and restart only when you're ready to go.
- Don't "lug" or "over-rev" the engine. Lugging is driving too slowly in too high a gear resulting in the engine bucking. If this happens, shift to a lower gear. Over-revving is racing the engine beyond its safe limit. This can be

avoided by shifting at the recommended speeds.

- Open windows at high speeds can reduce fuel economy.
- Fuel economy is less in crosswinds and headwinds. To help offset some of this loss, slow down when driving in these conditions.

Keeping a vehicle in good operating condition is important both for economy and safety.

Therefore, have the function checked by an authorized Kia dealer.

⚠ WARNING

Engine off during motion

Never turn the engine off to coast down hills or anytime the vehicle is in motion. The power steering and power brakes will not function properly without the engine running. In addition, turning off the ignition while driving could engage the steering wheel lock resulting in loss of vehicle steering. Keep the engine on and downshift to an appropriate gear for engine braking effect.

Declaration of conformity (if equipped)

The radio frequency components (Front Radar) complies:

For United States and United States territories



OANATEL002

FCC ID

: 2ACDX-MRR-20

This device complies with Part 15 of the FCC Rules. Operation is subject to the following two conditions:

- (1) this device may not cause harmful interference, and
- (2) this device must accept any interference received, including interference that may cause undesired operation.

CAUTION TO USERS

Changes or modifications not expressly approved by the party responsible for compliance could void the user's authority to operate the equipment.

OKA405054L

For Canada

Model: MRR-20
 IC: 11988A-MRR20

This device complies with Industry Canada licence-exempt RSS standard(s). Operation is subject to the following two conditions:

- (1) this device may not cause interference, and
- (2) this device must accept any interference, including interference that may cause undesired operation of the device.

Le présent appareil est conforme aux CNR d'Industrie Canada applicables aux appareils radio exempts de licence. L'exploitation est autorisée

- aux deux conditions suivantes:
- (1) l'appareil ne doit pas produire de brouillage,
 - et
 - (2) l'utilisateur de l'appareil doit accepter tout brouillage radioélectrique subi, même si le brouillage est susceptible d'en compromettre le fonctionnement.

OKA405056L

For Mexico

IFETEL : RCPMAMR18-1560

"La operación de este equipo está sujeta a las siguientes dos condiciones:

- (1) es posible que este equipo o dispositivo no cause interferencia perjudicial y
- (2) este equipo o dispositivo debe aceptar cualquier interferencia, incluyendo la que pueda causar su operación no deseada."

and RCPMAMR18-1560

OKA405056L

The radio frequency components (Rear Corner Radar) complies:

For United States and United States territories



OANATEL002

This device complies with Part 15 of the FCC Rules. Operation is subject to the following two conditions:

- (1) this device may not cause harmful interference, and
- (2) this device must accept any interference received, including interference that may cause undesired operation.

CAUTION TO USERS

Changes or modifications not expressly approved by the party responsible for compliance could void the user's authority to operate the equipment.

OYB060041L

For Canada

This Category II radiocommunication device complies with Industry Canada Standard RSS-310.

Ce dispositif de radiocommunication de catégorie II respecte la norme CNR-310 d'Industrie Canada .

This device complies with Industry Canada licence-exempt RSS standard(s). Operation is subject to the following two conditions:

(1) this device may not cause interference, and (2) this device must accept any interference, including interference that may cause undesired operation of the device.

Le présent appareil est conforme aux CNR d'Industrie Canada applicables aux appareils radio exempts de licence. L'exploitation est autorisée aux deux conditions suivantes :

(1) l'appareil ne doit pas produire de brouillage, et (2) l'utilisateur de l'appareil doit accepter tout brouillage radioélectrique subi, même si le brouillage est susceptible d'en compromettre le fonctionnement.

OCK060074L

For Mexico

IFETEL: RLVVAMB15-2026

"La operación de este equipo está sujeta a las siguientes dos condiciones:

(1) es posible que este equipo o dispositivo no cause interferencia perjudicial y (2) este equipo o dispositivo debe aceptar cualquier interferencia, incluyendo la que pueda causar su operación no deseada."

OCK060080L

Special driving conditions

If driving conditions deteriorate due to poor weather or road conditions, you should pay even more attention than usual to your driving.

Hazardous driving conditions

When hazardous driving conditions are encountered such as water, snow, ice, mud, sand, or similar hazards, follow these suggestions:

- Drive cautiously and allow extra distance for braking.
- Avoid sudden braking or steering.
- Do not pump the brake pedal on a vehicle equipped with ABS.
- If stalled in snow, mud, or sand, use the second gear. Accelerate slowly to avoid spinning the drive wheels.
- Use sand, rock salt, or other non-slip material under the drive wheels to provide traction when stalled in ice, snow, or mud.

Reducing the risk of a rollover

This multi-purpose passenger vehicle is defined as a Sports Utility Vehicle (SUV). Utility vehicles have a significantly higher rollover rate than other types of vehicles. SUVs have higher ground clearance and a narrower track to make them capable of performing in a wide variety of offroad applications.

Specific design characteristics give them a higher center of gravity than ordinary vehicles. An advantage of the higher ground clearance is a better view of the road, which allows you to anticipate problems.

They are not designed for cornering at the same speeds as conventional passenger vehicles, any more than low-slung sports vehicles are designed to perform satisfactorily in off-road conditions. Due to this risk, driver and passengers are strongly recommended to buckle their seat belts.

In a rollover crash, an unbelted person is significantly more likely to die than a person wearing a seat belt. There are steps that a driver can make to reduce the risk of a rollover.

If at all possible, avoid sharp turns or abrupt maneuvers, do not load your roof rack with heavy cargo, and never modify your vehicle in any way.

WARNING

Rollover

As with other Sports Utility Vehicle (SUV), failure to operate this vehicle correctly may result in loss of control, an accident or vehicle rollover.

- Utility vehicles have a significantly higher rollover rate than other types of vehicles.

- Specific design characteristics (higher ground clearance, narrower track, etc.) give this vehicle a higher center of gravity than ordinary vehicles.
- A SUV is not designed for cornering at the same speeds as conventional vehicles.
- Avoid sharp turns or abrupt maneuvers.
- In a rollover crash, an unbelted person is significantly more likely to die than a person wearing a seat belt. Make sure everyone in the vehicle is properly buckled up.

WARNING

Your vehicle is equipped with tires designed to provide safe ride and handling capability. Do not use tires and wheels that are different in size and type from the originally installed ones. It can affect the safety and performance of your vehicle, which could lead to steering failure or rollover and serious injury. When replacing the tires, be sure to equip all four tires with the tire and wheel of the same size, type, tread, brand and load-carrying capacity.

Rocking the vehicle

If it is necessary to rock the vehicle to free it from snow, sand, or mud, first turn the steering wheel right and left to clear the area around your front wheels. Then, shift back and forth between R (Reverse) and any forward gear.

Do not race the engine, and spin the wheels as little as possible. If you are still stuck after a few tries, have the vehicle pulled out by a tow vehicle to avoid engine overheating and possible damage to the transmission.

⚠️ WARNING

Sudden vehicle movement

Do not attempt to rock the vehicle if people or objects are nearby. The vehicle may suddenly move forward or backwards as it becomes unstuck.

⚠️ CAUTION

Vehicle rocking

Prolonged rocking may cause vehicle overheating, transmission damage or failure, and tire damage.

⚠️ CAUTION

Spinning tires

Do not spin the wheels, especially at speeds more than 56 km/h (35 mph). Spinning the wheels at high speeds when the vehicle is stationary could overheat and damage tires, and the rotating wheels may fly away and injure bystanders.

* NOTICE

The Electronic Stability Control (ESC) should be turned OFF prior to rocking the vehicle.

Smooth cornering



Avoid braking or gear changing in corners, especially when roads are wet. Ideally, corners should always be taken under gentle acceleration. If you follow these suggestions, tire wear will be held to a minimum.

Driving at night



OKA4050176N

Because night driving presents more hazards than driving in the daylight, here are some important tips to remember:

- Slow down and keep more distance between you and other vehicles, as it may be more difficult to see at night, especially in areas where there may not be any street lights.
- Adjust your mirrors to reduce the glare from other driver's headlamps.
- Keep your headlamps clean and properly aimed. (On vehicles not equipped with the automatic headlamp aiming feature.) Dirty or improperly aimed headlamps will make it much more difficult to see at night.
- Avoid staring directly at the headlamps of oncoming vehicles. You could be temporarily blinded, and it will take several seconds for your eyes to readjust to the darkness.

Driving in the rain



OKA4050174N

Rain and wet roads can make driving dangerous, especially if you're not prepared for the slick pavement.

Here are a few things to consider when driving in the rain:

- A heavy rainfall will make it harder to see and will increase the distance needed to stop your vehicle, so slow down.
- Keep your windshield wiping equipment in good shape. Replace your windshield wiper blades when they show signs of streaking or missing areas on the windshield.
- If your tires are not in good condition, making a quick stop on wet pavement can cause a skid and possibly lead to an accident. Be sure your tires are in good shape.
- Turn on your headlamps to make it easier for others to see you.
- Driving too fast through large puddles can affect your brakes. If you must go through puddles, try to drive through them slowly.

- If you believe you may have gotten your brakes wet, apply them lightly while driving until normal braking operation returns.

Hydroplaning

If the road is wet enough and you are going fast enough, your vehicle may have little or no contact with the road surface and actually ride on the water. The best advice is SLOW DOWN when the road is wet.

The risk of hydroplaning increases as the depth of tire tread decreases, refer to "Tires and wheels" on page 8-5.

Driving in flooded areas

Avoid driving through flooded areas unless you are sure the water is no higher than the bottom of the wheel hub. Drive through any water slowly. Allow adequate stopping distance because brake performance may be affected.

After driving through water, dry the brakes by gently applying them several times while the vehicle is moving slowly.

Highway driving

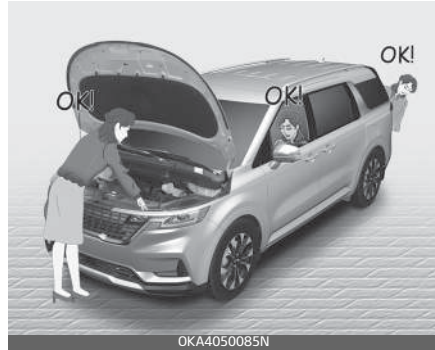

Tires

Adjust the tire inflation pressures to specification. Low tire inflation pressures will result in overheating and possible failure of the tires.

Avoid using worn or damaged tires which may result in reduced traction or tire failure.

Never exceed the maximum tire inflation pressure shown on the tires.

⚠ WARNING

Under/over inflated tires

Always check the tires for proper inflation before driving. Underinflated or overinflated tires can cause poor handling, loss of vehicle control, and sudden tire failure, leading to accidents, injuries, and even death. For proper tire pressures, refer to "Tires and wheels" on page 8-5.

⚠ WARNING**Tire tread**

Always check the tire tread before driving your vehicle. Worn-out tires can result in loss of vehicle control. Worn-out tires should be replaced as soon as possible. For further information and tread limits, refer to "Tires and wheels" on page 8-5.

Fuel, engine coolant and engine oil

High speed travel consumes more fuel than urban motoring. Do not forget to check both the engine coolant and engine oil.

Drive belt

A loose or damaged drive belt may result in overheating of the engine.

Winter driving

Severe weather conditions in the winter result in greater wear and other problems.

To minimize the problems of winter driving, you should follow these suggestions:

Snowy or icy conditions

To drive your vehicle in deep snow, it may be necessary to use snow tires on your tires.

If snow tires are needed, it is necessary to select tires equivalent in size and type of the original equipment tires. Failure to do so may adversely affect the safety and handling of your vehicle. Furthermore, speeding, rapid acceleration, sudden brake applications, and sharp turns are potentially very hazardous practices.

During deceleration, use vehicle braking to the fullest extent. Sudden brake applications on snowy or icy roads may cause skids to occur. You need to keep sufficient distance between the vehicle in operation in front of your vehicle. Also, apply the brake gently. It should be noted that installing tire chains on the tire will provide a greater driving force, but will not prevent side skids.

Snow tires

If you mount snow tires on your vehicle, make sure they are radial tires of the same size and load range as the original tires. Mount snow tires on all four wheels to balance your vehicle's handling in all weather conditions. Keep in mind that the traction provided by snow tires on dry roads may not be as high as your vehicle's original equipment tires. You should drive cautiously even when the roads are clear. Check with the tire dealer for maximum speed recommendations.

Do not install studded tires without first checking local, state and municipal regulations for possible restrictions against their use.

WARNING

Snow tire size

Snow tires should be equivalent in size and type to the vehicle's standard tires. Otherwise, the safety and handling of your vehicle may be adversely affected.

Use high quality ethylene glycol coolant

Your vehicle is delivered with high quality ethylene glycol coolant in the cooling system. It is the only type of coolant that should be used because it helps prevent corrosion in the

cooling system, lubricates the water pump and prevents freezing. Be sure to replace or replenish your coolant in accordance with the maintenance schedule in section 8.

Before winter, have your coolant tested to assure that its freezing point is sufficient for the temperatures anticipated during the winter.

Check battery and cables

Winter puts additional burdens on the battery system. Visually inspect the battery and cables as described in section 8. Have the level of charge in your battery checked by an authorized Kia dealer.

Change to "winter weight" oil if necessary

In some climates it is recommended that a lower viscosity "winter weight" oil be used during cold weather. See "Recommended lubricants and capacities" on page 8-6. If you aren't sure what weight oil you should use, consult an authorized Kia dealer.

Check spark plugs and ignition system

Inspect your spark plugs as described in "Scheduled maintenance service" on page 7-9 and replace them if necessary. Also check all ignition wiring and compo-

nents to be sure they are not cracked, worn or damaged in any way.

To keep locks from freezing

To keep the locks from freezing, squirt an approved de-icer fluid or glycerine into the key opening. If a lock is covered with ice, squirt it with an approved de-icing fluid to remove the ice. If the lock is frozen internally, you may be able to thaw it out by using a heated key. Handle the heated key with care to avoid injury.

Use approved window washer anti-freeze in system

To keep the water in the window washer system from freezing, add an approved window washer anti-freeze solution in accordance with instructions on the container. Window washer anti-freeze is available from an authorized Kia dealer and most auto parts outlets. Do not use engine coolant or other types of anti-freeze as these may damage the paint finish.

Don't let your parking brake freeze

Under some conditions your parking brake can freeze in the engaged position. This is most likely to happen when there is an accumulation of snow or ice around or near the rear brakes or if the brakes are wet.

If there is a risk the parking brake may freeze, temporarily apply it with the gear in P (Park). Also, block the rear wheels in advance, so the vehicle may not roll. Then release the parking brake.

Don't let ice and snow accumulate underneath

Under some conditions, snow and ice can build up under the fenders and interfere with the steering. When driving in severe winter conditions where this may happen, you should periodically check underneath the vehicle to be sure the movement of the front wheels and the steering components is not obstructed.

Carry emergency equipment

Depending on the severity of the weather, you should carry appropriate emergency equipment. Some of the items you may want to carry include tire chains, tow straps or chains, flashlight, emergency flares, sand, shovel, jumper cables, window scraper, gloves, ground cloth, coveralls, blanket, etc.

Do not place objects or materials in the engine compartment

Putting objects or materials in the engine compartment may cause an engine failure or combustion,

because they may block the engine cooling. Such damage will not be covered by the manufacturer's warranty.

Trailer towing

If you are considering towing with your vehicle, you should first check with your country's Department of Motor Vehicles to determine their legal requirements.

Since laws vary the requirements for towing trailers, cars, or other types of vehicles or apparatus may differ. Kia recommends to ask an authorized Kia dealer.

WARNING

Towing a trailer

If you don't use the correct equipment and drive improperly, you can lose control when you pull a trailer. For example, if the trailer is too heavy, the brakes may not work well – or even at all. You and your passengers could be seriously or fatally injured. Pull a trailer only if you have followed all the steps in this section.

WARNING

Weight limits

Before towing, make sure the total trailer weight, gross combination weight, gross vehicle weight, gross axle weight and trailer tongue load are all within the limits.

⚠ CAUTION

Any part of the rear number plate or lighting devices of the vehicle must not be obscured by the mechanical coupling device. If the rear number plate and/or lighting devices can be obscured partially by any part of the mechanical coupling device, mechanical coupling devices that can not be easily removed or repositioned without use of any tool, except an easily operated (i.e. an effort not exceeding 20 N·m) release key which is supplied by the manufacturer of the coupling device, are not permitted for use. Please note that the mechanical coupling device that is fitted and not in use should always be removed or repositioned if the rear number plate and/or rear lighting devices are obscured by any part of the mechanical coupling device.

*** NOTICE**

- The technically permissible maximum load on the rear axle(s) may be exceeded by not more than 15 % and the technically permissible maximum laden mass of the vehicle may be exceeded by not more than 10 % or 100 kg (220.4 lbs), whichever value is lower. In this case, do not exceed 100 km/h (60 mph) for vehicle of category M1

or 80 km/h (50 mph) for vehicle of category N1.

- When towing a trailer, the additional load imposed at the trailer coupling device may cause the rear tire maximum load ratings to be exceeded, but not by more than 15%. In such a case, do not exceed 100km/h (60 miles), and the rear tire pressure should be at least 20 kPa (2.9 psi) above the tire pressure(s) as recommended for normal use (i.e. without a trailer attached).

⚠ CAUTION

Pulling a trailer improperly can damage your vehicle and result in costly repairs not covered by your warranty. To pull a trailer correctly, follow the advice in this section.

Your vehicle can tow a trailer. To identify what the vehicle trailering capacity is for your vehicle, refer to "Weight of the trailer" on page 5-200 that appears later in this section.

Remember that trailering is different than just driving your vehicle by itself. Trailering means changes in handling, durability, and fuel economy. Successful, safe trailering requires correct equipment, and it has to be used properly.

This section contains many timetested, important trailering tips and safety rules. Many of these are important for your safety and that of your passengers. Please read this section carefully before you pull a trailer.

Load-pulling components such as the engine, transmission, wheel assemblies, and tires are forced to work harder against the load of the added weight. The engine is required to operate at relatively higher speeds and under greater loads. This additional burden generates extra heat. The trailer also considerably adds wind resistance, increasing pulling requirements.

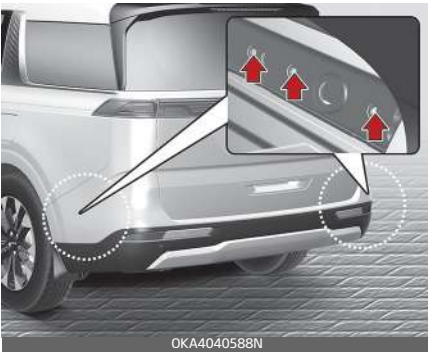

* NOTICE

Location of trailer mounting

The mounting hole for hitches are located on both sides of the underbody behind the rear tires.

Hitches

It's important to have the correct hitch equipment. Crosswinds, large trucks going by, and rough roads are a few reasons why you'll need the right hitch. Here are some rules to follow:

- Do you have to make any holes in the body of your vehicle when you install a trailer hitch? If you do, then be sure to seal the holes later when you remove the hitch. If you don't seal them, deadly carbon monoxide (CO) from your exhaust can get into your vehicle, as well as dirt and water.
- The bumpers on your vehicle are not intended for hitches. Do not attach rental hitches or other bumper-type hitches. Use only a frame-mounted hitch that does not attach to the bumper.
- Kia trailer hitch accessory is available at an authorized Kia dealer.

Safety chains

You should always attach chains between your vehicle and your trailer. Cross the safety chains under the tongue of the trailer so that the tongue will not drop to the road if it becomes separated from the hitch.

Instructions about safety chains may be provided by the hitch manufacturer or by the trailer manufacturer. Follow the manufacturer's recommendation for attaching safety chains. Always leave just enough slack so you can turn with your trailer. And, never allow safety chains drag on the ground.

Trailer brakes

If your trailer is equipped with a braking system, make sure it conforms to your country's regulations and that it is properly installed and operating correctly.

If your trailer weighs more than the maximum trailer weight without trailer brakes loaded, then it needs its own brakes and they must be adequate. Be sure to read and follow the instructions for the trailer brakes so you'll be able to install, adjust and maintain them properly.

- Don't tap into your vehicle's brake system.

WARNING

Trailer brakes

Do not use a trailer with its own brakes unless you are absolutely certain that you have properly set up the brake system. This is not a task for amateurs. Use an experienced, competent trailer shop for this work.

Driving with a trailer

Towing a trailer requires a certain amount of experience. Before setting out for the open road, you must get to know your trailer. Acquaint yourself with the feel of handling and braking with the added weight of the trailer. And always keep in mind that the vehicle you are driving is now a good deal longer and not nearly so responsive as your vehicle is by itself.

Before you start, check the trailer hitch and platform, safety chains, electrical connector(s), lights, tires and mirror adjustment. If the trailer has electric brakes, start your vehicle and trailer moving and then apply the trailer brake controller by hand to be sure the brakes are working. This lets you check your electrical connection at the same time.

During your trip, check occasionally to be sure that the load is secure, and that the lights and trailer brakes are still working.

Following distance

Stay at least twice as far behind the vehicle ahead as you would when driving your vehicle without a trailer. This can help you avoid situations that require heavy braking and sudden turns.

Passing

You'll need more passing distance up ahead when you're towing a trailer. And, because of the increased vehicle length, you'll need to go much farther beyond the passed vehicle before you can return to your lane.

Backing up

Hold the bottom of the steering wheel with one hand. Then, to move the trailer to the left, just move your hand to the left. To move the trailer to the right, move your hand to the right. Always back up slowly and, if possible, have someone guide you.

Making turns

When you're turning with a trailer, make wider turns than normal. Do this so your trailer won't strike soft

shoulders, curbs, road signs, trees, or other objects. Avoid jerky or sudden maneuvers. Signal well in advance.

Turn signals when towing a trailer

When you tow a trailer, your vehicle has to have a different turn signal flasher and extra wiring. The green arrows on your instrument panel will flash whenever you signal a turn or lane change. Properly connected, the trailer lights will also flash to alert other drivers you're about to turn, change lanes, or stop.

When towing a trailer, the green arrows on your instrument panel will flash for turns even if the bulbs on the trailer are burned out. Thus, you may think drivers behind you are seeing your signals when, in fact, they are not. It's important to check occasionally to be sure the trailer bulbs are still working. You must also check the lights every time you disconnect and then reconnect the wires.

Do not connect a trailer lighting system directly to your vehicle's lighting system. Use only an approved trailer wiring harness.

Have yourself assisted by a professional workshop in installing the wiring harness.

Kia recommends to visit an authorized Kia dealer.

⚠ WARNING

Failure to use an approved trailer wiring harness could result in damage to the vehicle electrical system and/or personal injury.

Driving on grades

Reduce the speed and shift to a lower gear before you start down a long or steep downgrade. If you don't shift down, you might have to use your brakes so much that they would get hot and no longer operate efficiently.

On a long uphill grade, shift down and reduce your speed to around 70 km/h (45 mph) to reduce the possibility of engine and transmission overheating.

⚠ CAUTION

- When towing a trailer on steep grades (in excess of 6 %) pay close attention to the engine coolant temperature gauge to ensure the engine does not overheat. If the needle of the coolant temperature gauge moves across the dial towards "H (HOT) (or 130 °C/260 °F)", pull over and stop as soon as it is safe to do so, and allow the engine to idle until it

cools down. You may proceed once the engine has cooled sufficiently.

- You must decide the driving speed depending on trailer weight and uphill grade to reduce the possibility of engine and transmission overheating.

Parking on hills

Generally, if you have a trailer attached to your vehicle, you should not park your vehicle on a hill. People can be seriously or fatally injured, and both your vehicle and the trailer can be damaged if unexpectedly roll down hill.

⚠ WARNING

Parking on a hill

Parking your vehicle on a hill with a trailer attached could cause serious injury or death, should the trailer break loose.

However, if you ever have to park your trailer on a hill, here's how to do it:

1. Pull the vehicle into the parking space. Turn the steering wheel in the direction of the curb (right if headed down hill, left if headed up hill).
2. Set the parking brake and shut off the vehicle.

3. Place chocks under the trailer wheels on the down hill side of the wheels.
4. Start the vehicle, hold the brakes, shift to neutral, release the parking brake and slowly release the brakes until the trailer chocks absorb the load.
5. Reapply the brakes, reapply the parking brake.
6. Shut off the vehicle and release the vehicle brakes but leave the parking brake set.

⚠ WARNING

Parking brake

It can be dangerous to get out of your vehicle if the parking brake is not firmly set.

If you have left the engine running, the vehicle can move suddenly. You or others could be seriously or fatally injured.

When you are ready to leave after parking on a hill

1. Apply your brakes and hold the brake pedal down while you:
 - Start your engine;
 - Shift into gear; and
 - Release the parking brake.
2. Slowly remove your foot from the brake pedal.
3. Drive slowly until the trailer is clear of the chocks.
4. Stop and have someone pick up and store the chocks.

Maintenance when trailer towing

Your vehicle will need service more often when you regularly pull a trailer. Important items to pay particular attention to include engine oil, axle lubricant and cooling system fluid. Brake condition is another important item to frequently check. Each item is covered in this manual, and the Index will help you find them quickly. If you're trailering, it's a good idea to review these sections before you start your trip.

Don't forget to also maintain your trailer and hitch. Follow the maintenance schedule that accompanied your trailer and check it periodically. Preferably, conduct the check at the start of each day's driving. Most importantly, all hitch nuts and bolts should be tight.

⚠ CAUTION

- Due to higher load during trailer usage, overheating might occur in hot days or during uphill driving. If the coolant gauge indicates overheating, switch off the A/C and stop the vehicle in a safe area to cool down the engine.
- When towing, check the transmission fluid more frequently.

- If your vehicle is not equipped with an air conditioner, you should install a condenser fan to improve engine performance when towing a trailer.
-

If you do decide to pull a trailer

Here are some important points if you decide to pull a trailer:

- Consider using a sway control. You can ask a hitch dealer about sway control.
- Do not do any towing with your vehicle during its first 2,000 km (1,200 miles) in order to allow the engine to properly break in. Failure to heed this caution may result in serious engine or transmission damage.
- When towing a trailer, consult an authorized Kia dealer on additional requirements such as a towing kit, etc.
- Always drive your vehicle at a moderate speed (less than 100 km/h (60 mph)).
- On a long uphill grade, do not exceed 70 km/h (45 mph) or the posted towing speed limit, whichever is lower.
- The chart contains important considerations that have to do with weight:

Item		Smartstream G3.5 GDi
Maximum trailer weight	With brake system	1,588 kg (3,500 lbs.)
	Without brake system	454 kg (1,001 lbs.)
Maximum permissible static vertical load on the coupling device		159 kg (250 lbs.)
Recommended distance from rear wheel center to coupling point		1,205 mm (47.4 inches)

Weight of the trailer

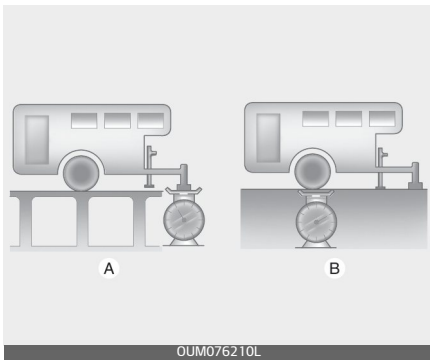

A: Tongue Load

B: Total Trailer Weight

What is the maximum safe weight of a trailer? It should never weigh more than the maximum trailer weight with trailer brakes. But even that can be too heavy.

It depends on how you plan to use your trailer. For example, speed, altitude, road grades, outside temperature and how often your vehicle is used to pull a trailer are all important. The ideal trailer weight can also depend on any special equipment that you have on your vehicle.

Weight of the trailer tongue

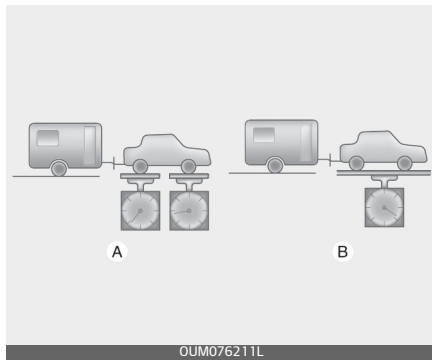

A: Gross Axle Weight

B: Gross Vehicle Weight

The tongue load of any trailer is an important weight to measure because it affects the total gross vehicle weight (GVW) of your vehicle. This weight includes the curb weight of the vehicle, any cargo you may carry in it, and the people who will be riding in the vehicle. And if you tow a trailer, you must add the tongue load to the GVW because your vehicle will also be carrying that weight.

The trailer tongue should weigh a maximum of 10 % of the total loaded trailer weight, within the limits of the maximum trailer tongue load permissible.

After you've loaded your trailer, weigh the trailer and then the tongue, separately, to see if the weights are proper. If they aren't, you may be able to correct them simply by moving some items around in the trailer.

⚠ WARNING

Trailer

- Never load a trailer with more weight in the rear than in the front. The front should be loaded with approximately 60% of the total trailer load; the rear should be loaded with approximately 40% of the total trailer load.
- Never exceed the maximum weight limits of the trailer or trailer towing equipment. Improper loading can result in damage to your vehicle and/or personal injury. Check weights and loading at a commercial scale or highway patrol office equipped with scales.
- An improperly loaded trailer can cause loss of vehicle control.

Vehicle load limit

The vehicle load limit is displayed on the tire and loading information label on the driver's door.

Tire and loading information label

The label located on the driver's door sill gives the original tire size, cold tire pressures recommended for your vehicle, the number of people that can be in your vehicle and vehicle capacity weight.

Example for spare tire

TIRE AND LOADING INFORMATION
RENSEIGNEMENTS SUR LES PNEUS ET LE CHARGEMENT

SEATING CAPACITY NOMBRE DE PLACES		TOTAL 8	FRONT 2	REAR 6 ARRIÈRE
--------------------------------------	--	---------	---------	-------------------

The combined weight of occupants and cargo should never exceed 600 kg or 1323 lbs.
Le poids total des occupants et du chargement ne doit jamais dépasser 600 kg ou 1323 lbs.

TIRE PNEU	SIZE DIMENSIONS	COLD TIRE PRESSURE PRESSION DES PNEUS À FROID	SEE OWNER'S MANUAL FOR ADDITIONAL INFORMATION VOIR LE MANUEL DE L'USAGER POUR PLUS DE RENSEIGNEMENTS
FRONT AVANT	235/55R19	250kPa, 36psi	
REAR ARRIÈRE	235/55R19	250kPa, 36psi	
SPARE DE SECOURS	T135/90D17	420kPa, 60psi	

OKA4050526N

Vehicle capacity weight:

- 7 seats: 525 kg (1,157 lbs.)
- 8 seats: 600 kg (1,323 lbs.)

Vehicle capacity weight is the maximum combined weight of occupants and cargo. If your vehicle is equipped with a trailer, the combined weight includes the tongue load.

Seating capacity:

Total: 7/8 persons (Front seat: 2 persons, Rear seat: 5/6 persons)

Seating capacity is the maximum number of occupants including a driver, your vehicle may carry.

However, the seating capacity may be reduced based upon the weight of all of the occupants, and the weight of the cargo being carried or towed.

Do not overload the vehicle as there is a limit to the total weight, or load limit including occupants and cargo, the vehicle can carry.

Towing capacity:

We do not recommend using this vehicle for trailer towing.

Cargo capacity:

The cargo capacity of your vehicle will increase or decrease depending on the weight and the number of occupants.

Steps For Determining Correct Load Limit -

1. Locate the statement "The combined weight of occupants and cargo should never exceed XXX kg or XXX lbs." on your vehicle's placard.
2. Determine the combined weight of the driver and passengers that will be riding in your vehicle.
3. Subtract the combined weight of the driver and passengers from XXX kg or XXX lbs.
4. The resulting figure equals the available amount of cargo and luggage load capacity. For example, if the "XXX" amount equals 635 kg (1400 lbs.) and there will be five 68 kg (150 lbs.) passengers in your vehicle, the amount of available cargo and luggage load capacity is 295 kg (650 lbs.).
 $(635 - 340 (5 \times 68) = 295 \text{ kg or } 1400 - 750 (5 \times 150) = 650 \text{ lbs.})$
5. Determine the combined weight of luggage and cargo being loaded on the vehicle. That weight may not safely exceed the available cargo and luggage load capacity calculated in Step 4.
6. If your vehicle will be towing a trailer, load from your trailer will be transferred to your vehicle. Consult this manual to determine how this reduces the available cargo and luggage load capacity of your vehicle.

⚠ WARNING**Loose cargo**

Do not travel with unsecured blunt objects in the passenger compartment of your vehicle (e.g., suit cases or unsecured child seats). These items may strike an occupant during a sudden stop or crash.

Example 1

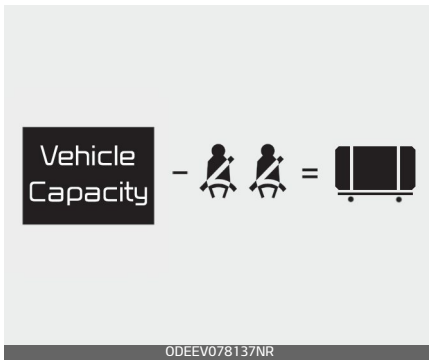

Item	Description	Total
A	Vehicle Capacity Weight	849 lbs. (385 kg)
B	Subtract Occupant Weight 150 lbs. (68 kg)×2	300 lbs. (136 kg)
C	Available Cargo and Luggage weight	549 lbs. (249 kg)

Example 2

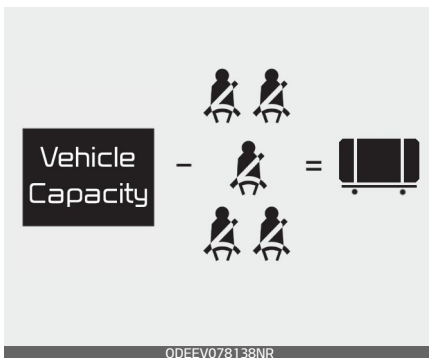

Item	Description	Total
A	Vehicle Capacity Weight	849 lbs. (385 kg)
B	Subtract Occupant Weight 150 lbs. (68 kg)×5	750 lbs. (340 kg)
C	Available Cargo and Luggage weight	99 lbs. (45 kg)

Example 3

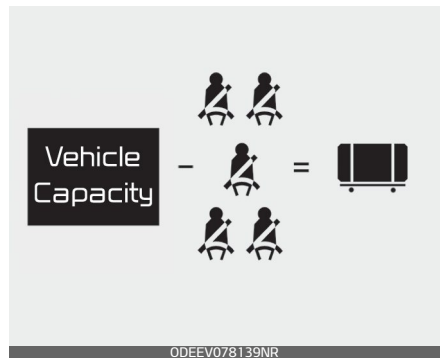

Item	Description	Total
A	Vehicle Capacity Weight	849 lbs. (385 kg)
B	Subtract Occupant Weight 161 lbs. (73 kg)×5	805 lbs. (365 kg)
C	Available Cargo and Luggage weight	44 lbs. (20 kg)

Refer to your vehicle's tire and load-
ing information label for specific
information about your vehicle's
capacity weight and seating posi-
tions. The combined weight of the
driver, passengers and cargo should

never exceed your vehicle's capacity weight.

Certification label

The certification label is located on the driver's door sill at the center pillar.

This label shows the maximum allowable weight of the fully loaded vehicle. This is called the GVWR (Gross Vehicle Weight Rating). The GVWR includes the weight of the vehicle, all occupants and cargo.

This label also tells you the maximum weight that can be supported by the front and rear axles, called Gross Axle Weight Rating (GAWR).

To find out the actual loads on your front and rear axles, you need to go to a weigh station and weigh your vehicle. Your dealer can help you with this. Be sure to spread out your load equally on both sides of the centerline.

WARNING

Over loading

Never exceed the GVWR for your vehicle, the GAWR for either the front or rear axle and vehicle capacity weight. Exceeding these ratings can affect your vehicle's handling and braking ability.

The label will help you decide how much cargo and installed equipment your vehicle can carry.

If you carry items inside your vehicle – like suitcases, tools, packages, or anything else – they are moving as fast as the vehicle. If you have to stop or turn quickly, or if there is a crash, the items will keep going and can cause an injury if they strike the driver or a passenger.

WARNING

Over loading

Do not overload your vehicle. Overloading your vehicle can cause heat buildup in your vehicle's tires and possible tire failure, increased stopping distances and poor vehicle handling—all of which may result in a crash.

NOTICE

Overloading your vehicle may cause damage. Repairs would not be covered by your warranty. Do not overload your vehicle.

Vehicle weight

This section will guide you in the proper loading of your vehicle, to keep your loaded vehicle weight within its design rating capability. Properly loading your vehicle will provide maximum return of the vehicle design performance. Before loading your vehicle, familiarize yourself with the following terms for determining your vehicle's weight ratings, from the vehicle's specifications and the certification label:

Base curb weight

This is the weight of the vehicle including a full tank of fuel and all standard equipment. It does not include passengers, cargo, or optional equipment.

Vehicle curb weight

This is the weight of your new vehicle when you picked it up from your dealer plus any aftermarket equipment.

Cargo weight

This figure includes all weight added to the Base Curb Weight, including cargo and optional equipment.

GAW (Gross axle weight)

This is the total weight placed on each axle (front and rear) - including vehicle curb weight and all payload.

GAWR (Gross axle weight rating)

This is the maximum allowable weight that can be carried by a single axle (front or rear). These numbers are shown on the certification label.

The total load on each axle must never exceed its GAWR.

GVW (Gross vehicle weight)

This is the Base Curb Weight plus actual Cargo Weight plus passengers.

GVWR (Gross vehicle weight rating)

This is the maximum allowable weight of the fully loaded vehicle (including all options, equipment, passengers and cargo). The GVWR is shown on the certification label located on the driver's (or front passenger's) door sill.

Overloading

WARNING

Vehicle weight

The gross axle weight rating (GAWR) and the gross vehicle weight rating (GVWR) for your vehicle are on the certification label attached to the driver's (or front passenger's) door. Exceeding these ratings can cause an accident or vehicle damage. You can calculate the weight of your load by weighing the items (and people) before putting them in the vehicle. Be careful not to overload your vehicle.

Road warning	6-3
• Hazard warning flasher	6-3
In case of an emergency while driving	6-4
• If the vehicle stalls while driving.....	6-4
• If the engine stalls at a crossroad or crossing	6-4
• If you have a flat tire while driving.....	6-4
If the engine will not start	6-5
• If engine doesn't turn over or turns over slowly	6-5
• If engine turns over normally but does not start.....	6-5
Emergency starting	6-6
• Jump-starting	6-6
• Push-starting.....	6-8
If the engine overheats	6-8
Tire Pressure Monitoring System (TPMS)	6-10
• Effective use of TPMS	6-11
• Low tire pressure telltale	6-12
• Tire Pressure Monitoring System (TPMS) malfunction indicator	6-13
• Tire replacement with TPMS.....	6-14
• This device complies with Industry Canada licence-exempt RSS standard(s)	6-15
If you have a flat tire (with spare tire)	6-16
• Jack and tools.....	6-16
• Removing and storing the spare tire	6-18
• Changing tires	6-20
• Important - use of compact spare tire	6-24
• Jack label	6-27
Towing	6-28

6 What to do in an emergency

- Towing service.....6-28
- Towing without wheel dollies when using a
towing service6-29
- Removable towing hook6-30
- Emergency towing6-30

What to do in an emergency

Road warning

When in an emergency situation occurs while driving or when you park by the edge of the roadway, you must alert approaching or passing vehicles to be careful as they pass. For this, you should use the hazard warning flasher.

Hazard warning flasher

The hazard warning flasher serves as a warning to other drivers to exercise extreme caution when approaching, overtaking, or passing your vehicle.

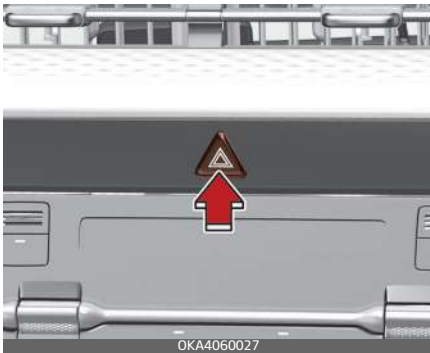

It should be used whenever emergency repairs are being made or when the vehicle is stopped near the edge of a roadway.

Depress the flasher switch with the ENGINE START/STOP button in any position. The flasher switch is located in the center fascia panel. All

turn signal lights will flash simultaneously.

- The hazard warning flasher operates whether your vehicle is running or not.
- The turn signals do not work when the hazard flasher is on.
- Care must be taken when using the hazard warning flasher while the vehicle is being towed.

In case of an emergency while driving

If an emergency situation occurs while driving, stay calm and take the following steps.

If the vehicle stalls while driving

1. Reduce your speed gradually, keeping a straight line.
2. Move cautiously off the road to a safe place.
3. Turn on your hazard warning flasher.
4. Try to start the vehicle again. If your vehicle will not start, contact an authorized Kia dealer or seek other qualified assistance.

If the engine stalls at a crossroad or crossing

- If the engine stalls at a crossroad or crossing, set the shift lever in the N (Neutral) position and then push the vehicle to a safe place.

If you have a flat tire while driving

1. Take your foot off the accelerator pedal and let the vehicle slow down while driving straight ahead. Do not apply the brakes immediately or attempt to pull off the road as this may cause a loss of control.
2. When the vehicle has slowed to such a speed that it is safe to do so, brake carefully and pull off the road.

3. Drive off the road as far as possible and park on firm level ground. If you are on a divided highway, do not park in the median area between the two traffic lanes.
4. When the vehicle is stopped, turn on your emergency hazard flashers, set the parking brake and put the transmission in P.
5. Have all passengers get out of the vehicle. Be sure they all get out on the side of the vehicle that is away from traffic.
6. When changing a flat tire, follow the instruction provided later in this section.

If the engine will not start

When the engine doesn't start, first check to see how much fuel there is and whether the battery is discharged.

If engine doesn't turn over or turns over slowly

1. Be sure the shift lever is in N (Neutral) or P (Park) and the emergency brake is set.
2. Check the battery connections to be sure they are clean and tight.
3. Turn on the interior light. If the light dims or goes out when you operate the starter, the battery is discharged.
4. Check the starter connections to be sure they are securely tightened.

WARNING

Do not push or pull the vehicle to start it. This could cause damage to your vehicle. Refer to "Jump-starting" on page 6-6.

If engine turns over normally but does not start

1. Check the fuel level and add fuel if necessary.
2. With the ENGINE START/STOP button in the OFF position, check all connectors at the ignition coils and spark plugs. Reconnect any that may be disconnected or loose.

3. Check the fuel line in the engine compartment.
4. If the engine still does not start, call an authorized Kia dealer or seek other qualified assistance.

Emergency starting

When the vehicle will not start because of low battery power, you may need to jump start the vehicle.

Jump-starting

Connect cables in numerical order and disconnect in reverse order.

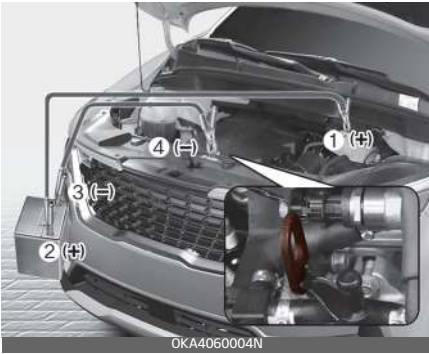

Jump-starting can be dangerous if done incorrectly. Therefore, to avoid harm to yourself or damage to your vehicle or battery, follow these jump-starting procedures. If in doubt, we strongly recommend that you have a competent technician or towing service jump-start your vehicle.

CAUTION

Use only a 12-volt jumper system. You can damage a 12-volt starting motor, ignition system, and other electrical parts beyond repair by use of a 24-volt power supply (either two 12-volt batteries in series or a 24-volt motor generator set).

WARNING

Frozen batteries

Do not attempt to jump start the vehicle if the discharged battery is frozen, as the battery may rupture or explode.

WARNING

Battery

- Never attempt to check the electrolyte level of the battery, as this may cause the battery to rupture or explode.
- Keep all flames or sparks away from the battery. The battery produces hydrogen gas which may explode if exposed to flame or sparks.

If these instructions are not followed exactly, serious personal injury and damage to the vehicle may occur! If you are not sure how to follow this procedure, seek qualified assistance. Automobile batteries contain sulfuric acid. This is poisonous and highly corrosive. When jump starting, wear protective glasses and be careful not to get acid on yourself, your clothing or on the vehicle.

- Do not attempt to jump start the vehicle if the discharged battery is frozen or if the electrolyte level is low; the battery may rupture or explode.

- Do not allow the (+) and (-) jumper cables to touch. It may cause sparks.
- The battery may rupture or explode when you jump start with a low or frozen battery.

WARNING

Battery cables

Do not connect the jumper cable from the negative terminal of the booster battery to the negative terminal of the discharged battery, directly. This can cause the discharged battery to overheat and crack or degrade. Make sure to connect one end of the jumper cable to the negative terminal of the booster battery, and the other end to a metallic point, far away from the battery.

WARNING

Sulfuric acid risk

Automobile batteries contain sulfuric acid. When jump starting your vehicle, be careful not to get sulfuric acid on yourself, your clothing, or on the vehicle. This acid is poisonous and highly corrosive.

Jump-starting

1. Make sure the booster battery is 12-volt and that its negative terminal is grounded.
If the booster battery is in another vehicle, do not allow the vehicles to come in contact.
2. Turn off all unnecessary electrical loads.
3. Connect the jumper cables in the exact sequence shown in the illustration.
 - 1) Connect one end of a jumper cable to the positive terminal of the discharged battery (1).
 - 2) Connect the other end to the positive terminal of the booster battery (2).
 - 3) Proceed to connect one end of the other jumper cable to the negative terminal of the booster battery (3), then the other end to a solid, stationary, metallic point away from the battery (4).
Do not allow the jumper cables to contact anything except the correct battery terminals or the correct ground. Do not lean over the battery when making connections.
4. If connected with the other vehicle, start the vehicle with the booster battery first and let it run at 2,000 rpm for several minutes.
5. Start the vehicle with the discharged battery.
6. If the engine starts, disconnect one end of the negative terminal of the booster battery (3), then other end of the positive terminal

of the booster battery (2) and the discharged battery (1).

If the cause of your battery discharging is not apparent, have your vehicle checked by an authorized Kia dealer.

Push-starting

Vehicles equipped with automatic transmission cannot be push-started, and only jump starting can be applied. Follow the directions in this section for "Jump-starting" on page 6-6.

WARNING

Tow starting vehicle

Never tow a vehicle to start it.

When the engine starts, the vehicle can suddenly surge forward and could cause a collision with the tow vehicle.

If the engine overheats

If your temperature gauge indicates overheating, you experience a loss of power, or hear a loud pinging or knocking, the engine will probably be too hot.

If this happens, you should:

1. Pull off the road and stop as soon as it is safe to do so.
2. Shift the gear to P (Park) and set the parking brake.
3. If the air conditioning is on, turn it off.
4. If engine coolant is running out under the vehicle or steam is coming out from underneath the hood, stop the engine. Do not open the hood until the coolant has stopped running or the steaming has stopped.
5. If there is no visible loss of engine coolant and no steam, leave the engine running and check to be sure the engine cooling fan is operating.
 - 1) If the fan is not running, turn the engine off.
6. Check to see if the water pump drive belt is missing.
 - 1) If it is not missing, check to see that it is tight.
 - 2) If the drive belt seems to be satisfactory, check for coolant leaking from the radiator, hoses or under the vehicle. (If the air conditioning had been in use, it is normal for cold water to be draining from it when you stop).

⚠ WARNING**Under the hood**

While the engine is running, keep hair, hands and clothing away from moving parts, such as the fan and drive belts, to prevent injury.

7. If the water pump drive belt is broken or engine coolant is leaking out, stop the engine immediately and call the nearest a professional workshop for assistance. Kia recommends to call an authorized Kia dealer.
8. If you cannot find the cause of the overheating, wait until the engine temperature has returned to normal. If coolant has been lost, carefully add coolant to the reservoir to bring the fluid level in the reservoir up to the halfway mark.
9. Proceed with caution, keeping alert for further signs of overheating. If overheating happens again, call a professional workshop for assistance. Kia recommends to call an authorized Kia dealer.

⚠ WARNING**Coolant reservoir cap**

Do not remove the engine coolant reservoir cap when the engine is hot. This may result in coolant being blown out of the opening and cause serious burns.

⚠ CAUTION

- Serious loss of coolant indicates there is a leak in the cooling system and this should be checked as soon as possible. Have your vehicle checked by an authorized Kia dealer.
- When the engine overheats from low engine coolant, suddenly adding engine coolant may cause cracks in the engine. To prevent damage, add engine coolant slowly in small quantities.

Tire Pressure Monitoring System (TPMS)

The Tire Pressure Monitoring System (TPMS) detects the pressure of vehicle's tires and displays it on the LCD display.



1. Low tire pressure telltale/TPMS malfunction indicator
2. Low tire pressure position telltale (Shown on the LCD display)

Tire Pressure Indicator

- You can check the tire pressure in the assist mode on the cluster.
 - Refer to "Driving Assist mode" on page 4-109.
- Tire pressure is displayed 1 ~ 2 minutes later after driving.
- If tire pressure is not displayed when the vehicle is stopped, "Drive to display" message displays. After driving, check the tire pressure.
- You can change the tire pressure unit in the user settings mode on the cluster.
 - psi, kPa, bar (Refer to "User settings mode" on page 4-110).

* NOTICE

- The tire pressure may change due to factors such as parking condition, driving style, and altitude above sea level.
- The tire pressure shown on the dashboard may differ from the tire pressure measured by tire pressure gauge.
- Low tire pressure warning may sound when a tire's pressure unit is equal or lower than nearby tires. This is a normal occurrence, which is due to the change in tire pressure along with tire temperature.

Effective use of TPMS

WARNING

Over-inflation or under-inflation can reduce tire life, adversely affect vehicle handling, and lead to sudden tire failure that may cause loss of vehicle control resulting in an accident

Each tire, including the spare (if provided), should be checked monthly when cold and inflated to the inflation pressure recommended by the vehicle manufacturer on the vehicle placard or tire inflation pressure label.

(If your vehicle has tires of a different size than the size indicated on the vehicle placard or tire inflation pressure label, you should determine the proper tire inflation pressure for those tires.)

As an added safety feature, your vehicle has been equipped with a tire pressure monitoring system (TPMS) that illuminates a low tire pressure telltale when one or more of your tires is significantly under-inflated. Accordingly, when the low tire pressure telltale illuminates, you should stop and check your tires as soon as possible, and inflate them to the proper pressure. Driving on a significantly under-inflated tire causes the tire to overheat and can

lead to tire failure. Under-inflation also reduces fuel efficiency and tire tread life, and may affect the vehicle's handling and stopping ability.

Please note that the TPMS is not a substitute for proper tire maintenance, and it is the driver's responsibility to maintain correct tire pressure, even if under-inflation has not reached the level to trigger illumination of the TPMS low tire pressure telltale.

Your vehicle has also been equipped with a TPMS malfunction indicator to indicate when the system is not operating properly. The TPMS malfunction indicator is combined with the low tire pressure telltale. When the system detects a malfunction, the telltale will flash for approximately one minute and then remain continuously illuminated. This sequence will continue upon subsequent vehicle start-ups as long as the malfunction exists. When the malfunction indicator is illuminated, the system may not be able to detect or signal low tire pressure as intended. TPMS malfunctions may occur for a variety of reasons, including the installation of replacement or alternate tires or wheels on the vehicle that prevent the TPMS from functioning properly.

Always check the TPMS malfunction telltale after replacing one or more

tires or wheels on your vehicle to ensure that the replacement or alternate tires and wheels allow the TPMS to continue to function properly.

*** NOTICE**

If any of the below happens, have the system checked by an authorized Kia dealer.

1. The low tire pressure telltale/TPMS malfunction indicator does not illuminate for 3 seconds when the ENGINE START/STOP button is turned to the ON position or engine is running.
2. The TPMS malfunction indicator remains illuminated after blinking for approximately 1 minute.
3. The Low tire pressure position telltale remains illuminated.

Low tire pressure telltale (!)

Low tire pressure position telltale

When the TPMS warning indicators are illuminated, one or more of your tires is significantly under-inflated.



If the telltale illuminates, immediately reduce your speed, avoid hard cornering and anticipate increased stopping distances. You should stop and check your tires as soon as possible.

Inflate the tires to the proper pressure as indicated on the vehicle's placard or tire inflation pressure label located on the driver's side center pillar outer panel. If you cannot reach a service station or if the tire cannot hold the newly added air, replace the low pressure tire with the spare tire.

Then the TPMS malfunction indicator and the Low Tire Pressure telltale may turn on and illuminate after restarting and about 20 min-

utes of continuous driving before you have the low pressure tire repaired and replaced on the vehicle.

In winter or cold weather, the low tire pressure telltale may be illuminated if the tire pressure was adjusted to the recommended tire inflation pressure in warm weather. It does not mean your TPMS is malfunctioning because the decreased temperature leads to a proportional lowering of tire pressure.

You should check the tire inflation pressure and adjust the tires to the recommended tire inflation pressure when driving your vehicle in the following conditions.

- from a warm area to a cold area
- from a cold area to a warm area
- the outside temperature is extremely high or low

When filling tires with more air, conditions to turn off the low tire pressure telltale may not be met. This is because a tire inflator has a margin of error in performance. The low tire pressure telltale will be turned off if the tire pressure is above the recommended tire inflation pressure.

WARNING

Low pressure damage

Do not drive on low pressure tires. Significantly low tire pressure can cause the tires to overheat and fail, making the vehicle unstable, resulting in increased braking distances and a loss of vehicle control.

Tire Pressure Monitoring System (TPMS) malfunction indicator

The low tire pressure telltale will illuminate after it blinks for approximately one minute when there is a problem with the TPMS.

If the system is able to correctly detect an underinflation warning at the same time as system failure, it will illuminate both the TPMS malfunction and the low tire pressure position telltales. For example, if the Front Left sensor fails, the TPMS malfunction indicator illuminates, but if the Front Right, Rear Left, or Rear Right tire is underinflated, the low tire pressure position telltales may illuminate together with the TPMS malfunction indicator.

Have the system checked by an authorized Kia dealer as soon as possible to determine the cause of the problem.

- The TPMS malfunction indicator may be illuminated if the vehicle is

moving around electric power supply cables or radios transmitters such as at police stations, government and public offices, broadcasting stations, military installations, airports, or transmitting towers, etc. This can interfere with normal operation of the TPMS.

- The TPMS malfunction indicator may illuminate if the vehicle is equipped with snow chains or some personal electronic devices (such as a laptop computer, mobile charger, remote starter or navigation) are being used in the vehicle. This can interfere with normal operation of the TPMS.

Tire replacement with TPMS

If you have a flat tire, the Low Tire Pressure telltale will come on. Have the flat tire repaired by an authorized Kia dealer as soon as possible or replace the flat tire with the spare tire.

CAUTION

Repair Agents

Never use a puncture-repairing agent not approved by Kia to repair and/or inflate a low pressure tire. Sealant that is not approved by Kia may damage the tire pressure sensor.

Each wheel is equipped with a tire pressure sensor mounted inside the tire behind the valve stem. You must use TPMS specific wheels. Have always your tires serviced by an authorized Kia dealer.

Even if you replace the low pressure tire with the spare tire, the Low Tire Pressure telltale will remain on until the low pressure tire is repaired and placed on the vehicle.

After you replace the low pressure tire with the spare tire, the TPMS malfunction indicator may illuminate after a few minutes. This is because the TPMS sensor mounted on the spare wheel is not yet activated.

Once the low pressure tire is inflated again to the recommended pressure and installed on the vehicle or the TPMS sensor mounted on the replaced spare wheel is initiated by a professional workshop, the TPMS malfunction indicator and the low tire pressure telltale will turn off within a few minutes of driving.

If the indicator has not disappeared after a few minutes of driving, please visit an authorized Kia dealer.

If an original mounted tire is replaced with the spare tire, the TPMS sensor on the replaced spare wheel should be initiated and the TPMS sensor on the original

mounted wheel should be deactivated. If the TPMS sensor on the original mounted wheel located in the spare tire carrier still activates, the Tire Pressure Monitoring System may not operate properly. Have the tire with TPMS serviced or replaced by an authorized Kia dealer.

You may not be able to identify a low tire by simply looking at it. Always use a good quality tire pressure gauge to measure the tire's inflation pressure. Please note that a tire that is hot (from being driven) will have a higher pressure measurement than a tire that is cold (from sitting stationary for at least 3 hours and driven less than 1.6 km (1 mile) during that 3 hour period).

Allow the tire to cool before measuring the inflation pressure. Always be sure the tire is cold before inflating to the recommended pressure.

A cold tire means the vehicle has been sitting for 3 hours and driven for less than 1.6 km (1 mile) in that 3 hour period.

Never use tire sealant if your vehicle is equipped with a TPMS. The liquid sealant can damage the tire pressure sensors.

- The TPMS cannot alert you to severe and sudden tire damage caused by external factors such as nails or road debris.

- If you feel any vehicle instability, immediately take your foot off the accelerator, apply the brakes gradually and with light force, and slowly move to a safe position off the road.

* NOTICE

Protecting TPMS

Tampering with, modifying, or disabling the Tire Pressure Monitoring System (TPMS) components may interfere with the system's ability to warn the driver of low tire pressure conditions and/or TPMS malfunctions. Tampering with, modifying, or disabling the Tire Pressure Monitoring System (TPMS) components may void the warranty for that portion of the vehicle.

This device complies with Industry Canada licence-exempt RSS standard(s).

Operation is subject to the following conditions:

1. This device may not cause interference, and
2. This device must accept any interference, including interference that may cause undesired operation of the device.
3. Changes or modifications not expressly approved by the party responsible for compliance could void the user's authority to operate the device.

If you have a flat tire (with spare tire)

If you have a flat tire, you can change the flat tire to a spare tire using tools.

⚠ WARNING

Driving on a flat tire will cause permanent damage to the tire. Re-inflating a tire after it has been driven on while severely underinflated or flat may cause a blowout and a serious crash. Never attempt to re-inflate a tire that has been driven on while severely underinflated or flat. In this case, repair or replace the flat tire as soon as possible.

⚠ WARNING

Changing a tire can be dangerous. Follow the instructions in this section when changing a tire to reduce the risk of serious injury or death.

⚠ CAUTION

Be careful as you use the jack handle to stay clear of the flat end. The flat end has sharp edges that could cause cuts.

Jack and tools



The jack and wheel lug nut wrench are stored in the luggage compartment.

Pull up the luggage box cover to reach this equipment.

1. Jack
2. Wheel lug nut wrench

Jacking instructions

The jack is provided for emergency tire changing only.

- To prevent the jack from "rattling" while the vehicle is in motion, store it properly.
- Follow jacking instructions to reduce the possibility of personal injury.

⚠ WARNING**Changing tires**

- Never attempt vehicle repairs in the traffic lanes of a public road or highway.
 - Always move the vehicle completely off the road and onto the shoulder before trying to change a tire. The jack should be used on firm level ground. If you cannot find a firm level place off the road, call a towing service company for assistance.
 - Be sure to use the correct front and rear jacking positions on the vehicle; never use the bumpers or any other part of the vehicle for jacking support.
 - The vehicle can roll off the jack causing serious injury or death.
 - Do not go under a vehicle that is supported by a jack.
 - Do not start or run the engine while the vehicle is on the jack.
 - Do not allow anyone to remain in the vehicle while it is on the jack.
 - Make sure any children present are in a secure place, away from the road and from the vehicle to be raised with the jack.
-

⚠ WARNING**Tire jack**

Do not place any portion of your body under a vehicle that is only supported by a jack since the vehicle can easily roll off the jack. Use vehicle support stands.

⚠ WARNING**Changing tires**

Never attempt vehicle repairs in the traffic lanes of a public road or highway.

⚠ WARNING**Running vehicle on jack**

Do not start or run the engine of the vehicle while the vehicle is on the jack as this may cause the vehicle to fall off the jack.

To prevent the jack from "rattling" while the vehicle IS in motion, store it properly.

*** NOTICE****Retreaded tires**

Possibly substantial variations in the design and age of the tire casing structures can limit service life and have a negative impact on road safety.

Removing and storing the spare tire

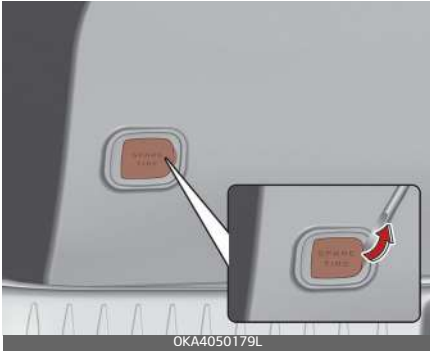

Your spare tire is stored underneath your vehicle, directly below the 2nd row seat area.

Removing the spare tire

1. Open the right side sliding door.
2. Find the spare tire fixing bolt cover and remove the cover. If necessary, separate the tool case only after removing the clamp.

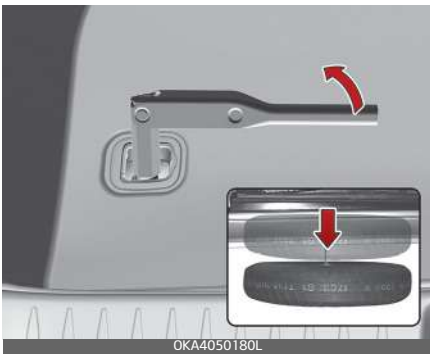

3. Connect the socket and wheel lug nut wrench.

4. Use the wheel lug nut wrench to loosen the bolt enough to lower the spare tire. Turn the wrench counterclockwise until the spare tire reaches the ground.



5. After the spare tire reaches the ground, continue to turn the wrench counterclockwise, and draw the spare tire outside. Never rotate the wrench excessively, otherwise the spare tire carrier may be damaged.
6. Remove the retainer (1) from the center of the spare tire.
7. Remove the cover from the center of the spare tire.

Storing the spare tire

1. Lay the tire on the ground with the valve stem facing down.

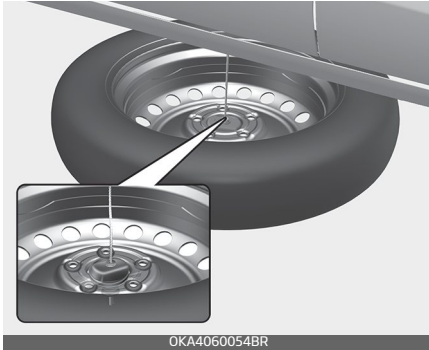

2. Place the wheel under the vehicle and install the retainer (1) through the wheel center.
3. Turn the wrench clockwise until it clicks.

⚠ WARNING

Ensure the spare tire retainer is properly aligned with the center of the spare tire to prevent the spare tire from "rattling".

Otherwise, it may cause the spare tire to fall off the carrier and lead to an accident.

Flat tire indoor storage

In the 3rd row seats unfolded upright

1. With the flat tires in the center of the 3rd row seats, place the outer part of the wheel facing the lift-gate.



2. Pass the fixing belt through the inside of the wheel.
3. Connect the fixing belt to the striker (A) located at the bottom left/right side of the back of the 3rd row seats.



4. Tighten the fixing belt securely.

In the 3rd row seats folded flat

1. Place the flat tire with its outer part facing upwards in the middle of the 3rd row seats.



2. Pass the fixing belt through the inside of the wheel.
3. Connect the fixing belt to the striker (A) located at the bottom left/right side of the back of the 3rd row seats.

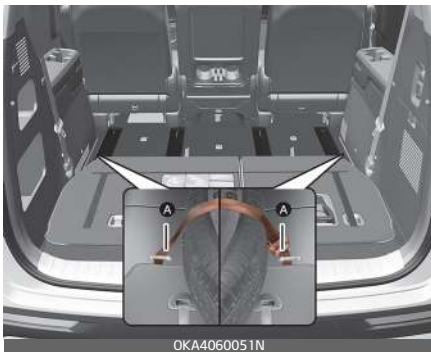

4. Tighten the fixing belt securely.

*** NOTICE**



If the flat tire is contaminated, cover the tire with anti-pollution cover (B) before keeping it indoors. This is to prevent indoor contamination.

⚠ WARNING

To prevent personal injury and damage to the vehicle, always use proper method to tether flat tire.

Changing tires

⚠ WARNING

A vehicle can slip or roll off of a jack causing serious injury or death to you or those nearby. Take the following safety precautions:

- Never place any portion of your body under a vehicle that is supported by a jack.
- NEVER attempt to change a tire in the lane of traffic. ALWAYS move the vehicle completely off the

road on level, firm ground away from traffic before trying to change a tire. If you cannot find a level, firm place off the road, call a towing service for assistance.

- Be sure to use the jack provided with the vehicle.
- ALWAYS place the jack on the designated jacking positions on the vehicle and NEVER on the bumpers or any other part of the vehicle for jacking support.
- Do not start or run the engine while the vehicle is on the jack.
- Do not allow anyone to remain in the vehicle while it is on the jack.
- Keep children away from the road and the vehicle.

1. Park on a level surface and apply the parking brake firmly.



2. Shift the gear to P (Park), apply the parking brake, and turn the engine OFF.
3. Activate the hazard warning flasher.

4. Remove the wheel lug nut wrench, jack, and spare tire from the vehicle.
5. Block both the front and rear of wheel that is diagonally opposite the jack position.



⚠ WARNING

Jack location

To reduce the possibility of injury, be sure to only use the jack provided with the vehicle in the correct jack position; never use any other part of the vehicle for jack support.

⚠ WARNING

Changing a tire

- To prevent vehicle movement while changing a tire, always set the parking brake fully, and always block the wheel diagonally, opposite the wheel being changed.
- We recommend that the wheels of the vehicle be blocked, and that

What to do in an emergency

If you have a flat tire (with spare tire)

no person remain in a vehicle that is being jacked.

6. Loosen the wheel lug nuts counterclockwise one turn each, but do not remove any nut until the tire has been raised off the ground.



7. Place the jack at the front (1) or rear (2) jacking position closest to the tire you are changing. Place the jack at the designated locations under the frame. The jacking positions are plates welded to the frame with two tabs and a raised dot to index with the jack.

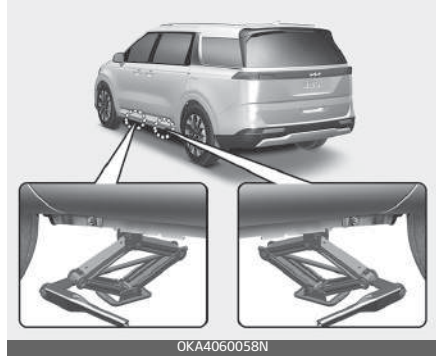
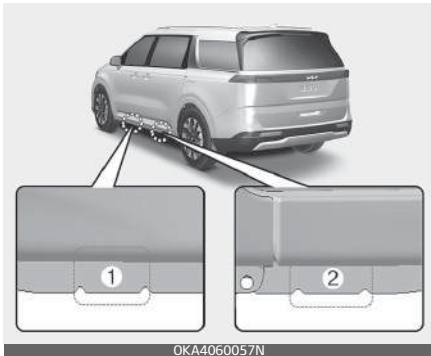

8. Insert the wheel lug nut wrench into the jack and turn it clockwise, raising the vehicle until the tire just clears the ground. This measurement is approximately 30 mm (1.2 inches). Before removing the wheel lug nuts, make sure the vehicle is stable and that there is no chance for movement or slippage.



9. Loosen the wheel nuts and remove them with your fingers. Slide the wheel off the studs and lay it flat so it cannot roll away. To put the wheel on the hub, pick up the spare tire, line up the holes

with the studs and slide the wheel onto them.

If this is difficult, tip the wheel slightly and get the top hole in the wheel lined up with the top stud. Then jiggle the wheel back and forth until the wheel can be slid over the other studs.

10. To reinstall the wheel, hold it on the studs, put the wheel nuts on the studs and tighten them finger tight. Jiggle the tire to be sure it is completely seated, then tighten the nuts as much as possible with your fingers again.
11. Lower the vehicle to the ground by turning the wheel nut wrench counterclockwise.



Then position the wrench as shown in the drawing and tighten the wheel nuts. Be sure the socket is seated completely over the nut. Do not stand on the wrench handle or use an extension pipe over the wrench handle. Go around the wheel tightening every other nut until they are all tight. Then double-check each nut for tightness. After changing

wheels, have the system checked by a professional workshop. Contact and visit an authorized Kia dealer.

⚠ WARNING

Installing a wheel

- When you install a wheel, always remove any corrosion, dirt or foreign materials present on the mounting surfaces of the wheel or the surface of the wheel hub, brake drum or brake disc that contacts the wheel. Make sure to secure any fasteners that attach the rotor to the hub so they do not interfere with the mounting surfaces of the wheel. Installing wheels without correct metal-to-metal contact at the wheel mounting surfaces can cause the wheel nuts to loosen and the wheel to come off while your vehicle is in motion, resulting in loss of vehicle control, personal injury or death.
- Make sure the wheel makes good contact with the hub when installed. If the contact of the mounting surface between the wheel and hub is not good, the wheel nuts could come loose and cause the loss of a wheel. Loss of a wheel may result in loss of control of the vehicle.

Wheel nut tightening torque:

Steel wheel & aluminum alloy wheel:

11 ~ 13 kgf·m (79 ~ 94 lbf·ft)

If you have a tire gauge, remove the valve cap and check the air pressure. If the pressure is lower than recommended, drive slowly to the nearest service station and inflate to the correct pressure. If it is too high, adjust it until it is correct. Always reinstall the valve cap after checking or adjusting tire pressure. If the cap is not replaced, air may leak from the tire. If you lose a valve cap, buy another and install it as soon as possible.

After you have changed wheels, always secure the flat tire in its place and return the jack and tools to their proper storage locations.

CAUTION

Reusing lug nuts

Make certain during wheel removal that the same nuts that were removed are reinstalled – or, if replaced, that nuts with metric threads and the same chamfer configuration are used. Your vehicle has metric threads on the wheel studs and nuts. Installation of a non-metric thread nut on a metric stud will not secure the wheel to the hub properly and will damage the stud so that it must be replaced.

Note that most lug nuts do not have metric threads. Be sure to use extreme care in checking for thread style before installing aftermarket lug nuts or wheels. If in doubt, consult an authorized Kia dealer.

WARNING

Wheel studs

If the studs are damaged, they may lose their ability to retain the wheel. This could lead to the loss of the wheel and a collision resulting in serious injuries.

WARNING

Never use oil or grease on bolts or nuts because the nuts might come loose. The vehicle's wheel could fall off, causing a crash.

Important – use of compact spare tire (if equipped)

Your vehicle is equipped with a compact spare tire. This compact spare tire takes up less space than a regular-size tire. This tire is smaller than a conventional tire and is designed for temporary use only.

- You should drive carefully when the compact spare is in use. The compact spare should be replaced by the proper conventional tire and rim at the first opportunity.

- The operation of this vehicle is not recommended with more than one compact spare tire in use at the same time.

⚠ WARNING

Spare tire

The compact spare tire is for emergency use only. Do not operate your vehicle on this compact spare at speeds over 80 km/h (50 mph). The original tire should be repaired or replaced as soon as possible to avoid failure of the spare, possibly leading to bodily injury or death.

The compact spare should be inflated to 60 psi (420 kPa).

*** NOTICE**

Check the inflation pressure after installing the spare tire. Adjust it to the specified pressure, as necessary.

When using a compact spare tire, observe the following precautions:

- Under no circumstances should you exceed 80 km/h (50 mph); a higher speed could damage the tire.
- Ensure that you drive slowly enough for the road conditions to avoid all hazards. Any road hazard, such as a pothole or debris,

could seriously damage the compact spare.

- Any continuous road use of this tire could result in tire failure, loss of vehicle control, and possible personal injury.
- Do not exceed the vehicle's maximum load rating or the load-carrying capacity shown on the sidewall of the compact spare tire.
- Avoid driving over obstacles. The compact spare tire diameter is smaller than the diameter of a conventional tire and reduces the ground clearance approximately 25 mm (1 inch), which could result in damage to the vehicle.
- Do not take this vehicle through an automatic vehicle wash while the compact spare tire is installed.
- Do not use the compact spare tire on any other vehicle because this tire has been designed especially for your vehicle.
- The compact spare tire's tread life is shorter than a regular tire. Inspect your compact spare tire regularly and replace worn compact spare tires with the same size and design, mounted on the same wheel.
- The compact spare tire should not be used on any other wheels, nor should standard tires, snow tires, wheel covers or trim rings be used with the compact spare wheel. If such use is attempted, damage to

these items or other vehicle components may occur.

- Do not use more than one compact spare tire at a time.
- Do not tow a trailer while the compact spare tire is installed.

Jack label

Type A

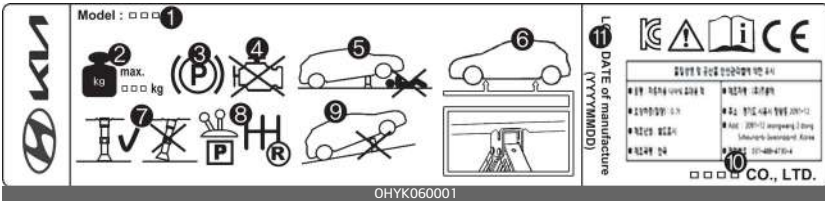

Type B

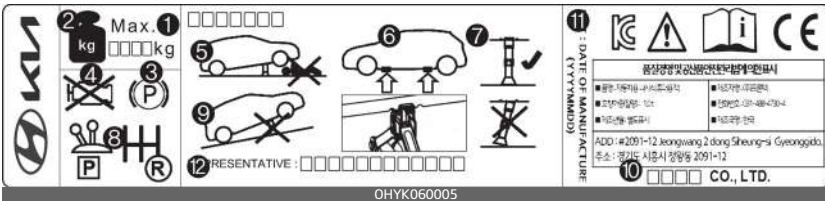

Type C



* The actual Jack label in the vehicle may differ from the illustration. For more detailed specifications, refer to the label attached to the jack.

1. Model Name
2. Maximum allowable load
3. When using the jack, set your parking brake.
4. When using the jack, stop the engine.
5. Do not get under a vehicle that is supported by a jack.
6. The designated locations under the frame
7. When supporting the vehicle, the base plate of jack must be vertical under the lifting point.
8. Move the shift position to the P (Park) position on vehicles.
9. The jack should be used on firm level ground.
10. Jack manufacturer
11. Production date
12. Representative company and address

Towing

If emergency towing is necessary, have it done by authorized Kia dealer or a commercial tow-truck service.

Towing service

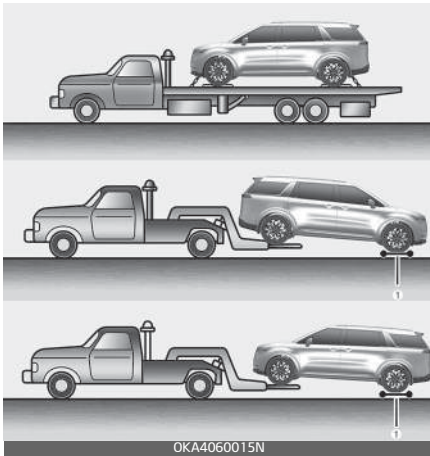

1. dollies

Proper lifting and towing procedures are necessary to prevent damage to the vehicle. The use of wheel dollies (1) or flatbed is recommended.

It is acceptable to tow the vehicle with the rear wheel on the ground (without dollies) and the front wheels off the ground. If any of the loaded wheels or suspension components are damaged or the vehicle is being towed with the front wheels on the ground, use a towing dolly under the front wheels. When

being towed by a commercial tow truck and wheel dollies are not used, the front of the vehicle should always be lifted, not the rear.

On FWD vehicles, it is acceptable to tow the vehicle with the rear wheels on the ground (without dollies) and the front wheels off the ground.

⚠ WARNING

Side and curtain air bag

If your vehicle is equipped with side and curtain air bag, set the ENGINE START/STOP button to ACC position when the vehicle is being towed.

The side and curtain air bag may deploy when the ENGINE START/STOP button to ON position and the rollover sensor detects the situation as a rollover.

* NOTICE

If the EPB does not release normally, take your vehicle to an authorized Kia dealer by loading the vehicle on a flatbed tow truck and have the system checked.

⚠ CAUTION

Towing



- Do not tow the vehicle backwards with the front wheels on the ground, as this may cause damage to the transmission.
- Do not tow with sling-type equipment. Use wheel lift or flatbed equipment.
- Do not tow the vehicle with four wheels in contact with the ground if it is the vehicle equipped with AT. Otherwise, the transmission will be seriously damaged. Also, make sure not to tow the vehicle connecting it with other vehicles including camper vans.

⚠ WARNING

- If you tow the vehicle while the front wheels are touching the ground, the vehicle motor may generate electricity and the

motor components may be damaged or a fire may occur.

- When a vehicle fire occurs due to the battery, there is a risk of a second fire. Contact the fire department when towing the vehicle.

Towing without wheel dollies when using a towing service

When towing your vehicle in an emergency without wheel dollies:

1. Set the ignition switch or ENGINE START/STOP button to ACC position.
2. Place the shift lever in N (Neutral).
3. Release the parking brake.

⚠ CAUTION

Towing gear position

Failure to shift to N (Neutral) may cause internal damage to the vehicle.

⚠ CAUTION

Automatic transmission

- If the car is being towed with all four wheels on the ground, it can be towed only from the front. Be sure that the transmission is in neutral. Be sure the steering is unlocked by placing the ignition switch or ENGINE START/STOP button in the ACC position. A driver must be in the towed vehi-

cle to operate the steering and brakes.

- To avoid serious damage to the transmission, limit the vehicle speed to 15 km/h (10 mph) and drive less than 1.5 km (1 mile) when towing.
- Before towing, check the transmission for fluid leaks under your vehicle. If the transmission fluid is leaking, flatbed equipment or a towing dolly must be used.

Removable towing hook (if equipped)

1. Open the liftgate, and remove the towing hook from the tool case.

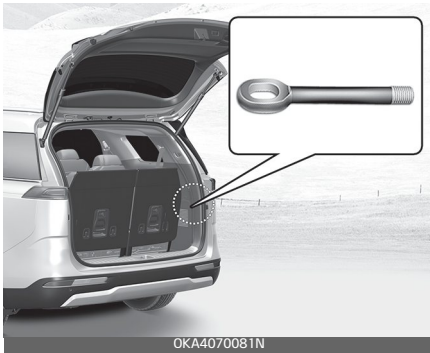

2. Remove the hole cover pressing the upper part of the cover on the front bumper.

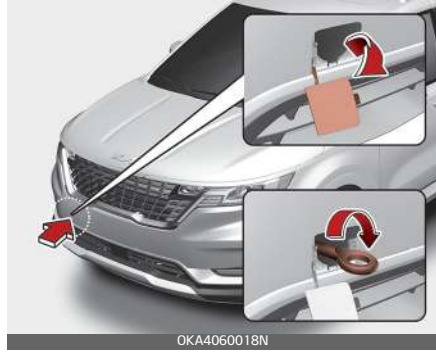

3. Install the towing hook by turning it clockwise into the hole until it is fully secured.
4. Remove the towing hook and install the cover after use.

Emergency towing

Front



Rear



If towing is necessary, have it done by an authorized Kia dealer or a commercial tow truck service.

If towing service is not available in an emergency, your vehicle may be temporarily towed using a cable or chain secured to the emergency towing hook under the front (or rear) of the vehicle. Use extreme caution when towing the vehicle. A driver must be in the vehicle to steer it and operate the brakes.

Towing in this manner may be done only on hard-surfaced roads for a short distance and at low speed. Also, the wheels, axles, power train, steering and brakes must all be in good condition.

- Do not use the tow hooks to pull a vehicle out of mud, sand or other conditions from which the vehicle cannot be driven out under its own power.
- Avoid towing a vehicle heavier than the vehicle doing the towing.

⚠ CAUTION

- The drivers of both vehicles should communicate with each other frequently.
- Attach a towing strap to the tow hook.
- Using a portion of the vehicle other than the tow hooks for towing may damage the body of your vehicle.
- Use only a cable or chain specifically intended for use in towing vehicles. Securely fasten the cable or chain to the towing hook provided.
- Accelerate or decelerate the vehicle in a slow and gradual manner while maintaining tension on the tow rope or chain to start or drive the vehicle, otherwise tow hooks and the vehicle may be damaged.
- Before emergency towing, check if the hook is not broken or damaged.
- Fasten the towing cable or chain securely to the hook.
- Do not jerk the hook. Apply it steadily and with even force.
- To avoid damaging the hook, do not pull from the side or at a vertical angle. Always pull straight ahead.

⚠ WARNING

Use extreme caution when towing the vehicle.

- Avoid sudden starts or erratic driving maneuvers which would place excessive stress on the emergency towing hook and towing cable or chain. The hook and towing cable or chain may break and cause serious injury or damage.
- If the disabled vehicle is unable to be moved, do not forcibly continue the towing. We recommend that you contact an authorized Kia dealer or a commercial tow truck service for assistance.
- Tow the vehicle as straight ahead as possible.
- Keep away from the vehicle during towing.

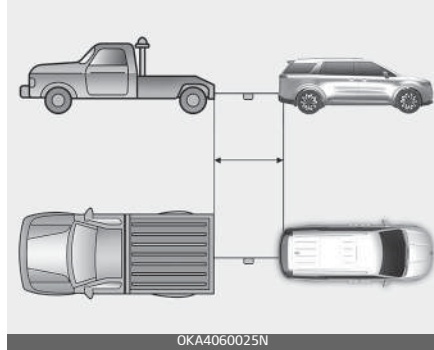

- Use a towing strap less than 5 m (16 feet) long. Attach a white or red cloth (about 30 cm (12 inches) wide) in the middle of the strap for easy visibility.
- Drive carefully so that the towing strap is not loosened during towing.
- The driver must be in the vehicle for steering and braking operations when the vehicle is towed and passengers other than the driver must not be allowed to be on board.

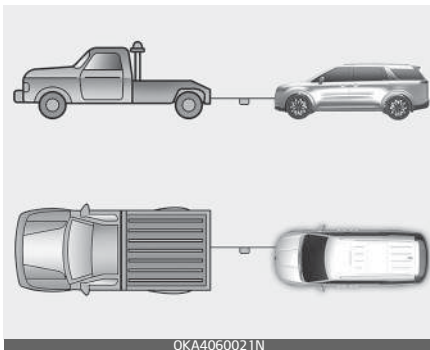

Emergency towing precautions

- Turn the ignition switch or the ENGINE START/STOP button to the ACC position so the steering wheel is not locked.
- Shift the gear to N (Neutral).
- Release the parking brake.
- Press the brake pedal with more force than normal since you will have reduced brake performance.

- More steering effort will be required because the power steering system will be disabled.
- If you are driving down a long hill, the brakes may overheat and brake performance will be reduced. Stop often and let the brakes cool off.
- To avoid serious damage to the automatic transmission, limit the vehicle speed to 15 km/h (10 mph) and drive less than 1.5 km (1 mile) when towing. (for Automatic transmission vehicle.)

⚠ CAUTION**Transmission**

- If the car is being towed with all four wheels on the ground, it can be towed only from the front. Be sure that the transmission is in neutral. Be sure the steering is unlocked by placing the ignition switch or ENGINE START/STOP button in the ACC position. A driver must be in the towed vehicle to operate the steering and brakes.
- Before towing, check the transmission for fluid leaks under your vehicle. If the automatic transmission fluid is leaking, flatbed equipment or a towing dolly must be used.

Engine compartment	7-5
Maintenance services	7-6
Owner maintenance	7-7
• Owner maintenance schedule	7-7
Scheduled maintenance service	7-9
• Scheduled maintenance service precaution	7-9
Explanation of scheduled maintenance items	7-15
• Engine oil and filter	7-15
• Drive belts	7-15
• Fuel filter	7-15
• Fuel lines, fuel hoses and connections.....	7-15
• Vapor hose and fuel filler cap.....	7-15
• Vacuum crankcase ventilation hoses	7-15
• Air cleaner filter	7-16
• Spark plugs	7-16
• Cooling system.....	7-16
• Coolant	7-16
• Automatic transmission fluid	7-16
• Brake hoses and lines	7-17
• Brake fluid	7-17
• Brake discs, pads and calipers.....	7-17
• Suspension mounting bolts	7-17
• Steering gear box, linkage & boots/ lower arm ball joint	7-17
• Drive shafts and boots	7-17
• Air conditioning refrigerant	7-17
• Checking fluid levels	7-17
Engine oil	7-18
• Checking the engine oil level.....	7-18

7 Maintenance

• Changing the engine oil and filter	7-19
Engine coolant	7-20
• Checking the coolant level	7-20
• Changing the coolant	7-22
Brake fluid	7-23
• Checking the brake fluid level	7-23
Washer fluid	7-24
• Checking the washer fluid level	7-24
Air cleaner	7-25
• Filter replacement	7-25
Climate control air filter	7-26
• Filter inspection	7-26
• Rear climate control air filter	7-27
Wiper blades	7-29
• Blade inspection	7-29
• Blade replacement	7-29
Battery	7-33
• For best battery service	7-33
• Battery recharging	7-35
• Reset items	7-36
Tires and wheels	7-37
• Checking tire inflation pressure	7-38
• Tire rotation	7-39
• Wheel alignment and tire balance	7-40
• Tire replacement	7-40
• Wheel replacement	7-41
• Tire traction	7-41
• Tire maintenance	7-41

• Tire sidewall labeling.....	7-41
• Tire terminology and definitions	7-44
• All season tires.....	7-47
• Summer tires	7-47
• Snow tires.....	7-47
• Radial-ply tires	7-48
Fuses.....	7-49
• Inner panel fuse replacement	7-51
• Engine compartment fuse replacement	7-52
• Fuse/relay panel description	7-53
Light bulbs.....	7-61
• Bulb replacement precaution	7-61
• Light bulb position (Front)	7-63
• Light bulb position (Rear).....	7-64
• Light bulb position (Side).....	7-65
• Replacing headlamp (Low beam/High beam), position lamp/daytime running lamp, turn signal lamp and front side marker (LED type)	7-65
• Replacing front turn signal lamp (Bulb type)	7-66
• Replacing front fog lamp (LED type)	7-66
• Replacing side repeater lamp (LED type).....	7-66
• Replacing side marker, stop and taillamp (Bulb type) ...	7-67
• Replacing rear turn signal lamp, reversing lamp (Bulb type).....	7-68
• Replacing rear side marker, stop and tail lamp (LED type).....	7-69
• Replacing high mounted stop lamp (LED type).....	7-69
• Replacing license plate lamp (Bulb type).....	7-70
• Replacing map lamp (Bulb type).....	7-70
• Replacing map lamp (LED type).....	7-71

7 Maintenance

- Replacing room lamp (Bulb type)7-71
- Replacing room lamp (LED type)7-72
- Replacing personal lamp (LED type).....7-72
- Replacing vanity mirror lamp (Bulb type)7-73
- Replacing glove box lamp (Bulb type)7-73
- Replacing luggage lamp (Bulb type)7-74
- Replacing luggage lamp (LED type)7-74
- Appearance care7-75**
 - Exterior care7-75
 - Interior care7-80
- Emission control system7-83**

Maintenance

Engine compartment

Smartstream G3.5 GDi (Gasoline)

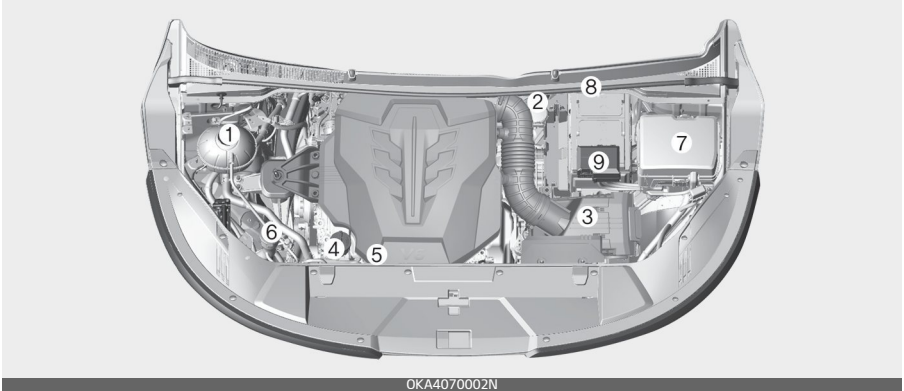

* The actual engine room in the vehicle may differ from the illustration.

1. Engine coolant reservoir
2. Brake fluid reservoir
3. Air cleaner
4. Engine oil filler cap
5. Engine oil dipstick
6. Windshield washer fluid reservoir
7. Fuse box
8. Negative battery terminal
9. Positive battery terminal

Maintenance services

You should exercise the utmost care to prevent damage to your vehicle and injury to yourself whenever performing any maintenance or inspection procedures.

Should you have any doubts concerning the inspection or servicing of your vehicle, have an authorized Kia dealer perform this work.

An authorized Kia dealer has factory-trained technicians and genuine Kia parts to service your vehicle properly. For expert advice and quality service, see an authorized Kia dealer.

Inadequate, incomplete or insufficient servicing may result in operational problems with your vehicle that could lead to vehicle damage, an accident, or personal injury.

Owner's responsibility

* NOTICE

Maintenance Service and Record Retention are the owner's responsibility.

You should retain documents that show proper maintenance has been performed on your vehicle in accordance with the scheduled maintenance service charts shown on the following pages. You need this information to establish your com-

pliance with the servicing and maintenance requirements of your vehicle warranties.

Detailed warranty information is provided in your Warranty & Consumer Information manual.

Repairs and adjustments required as a result of improper maintenance or a lack of required maintenance are not covered.

Have your vehicle maintained and repaired by an authorized Kia dealer. Authorized Kia dealers meet Kia's high service quality standards and receive technical support from Kia in order to provide you with a high level of service satisfaction.

Owner maintenance precautions

Improper or incomplete service may result in problems. This section gives instructions only for the maintenance items that are easy to perform.

As explained earlier in this section, several procedures can be done only by an authorized Kia dealer with special tools.

* NOTICE

Improper owner maintenance during the warranty period may affect warranty coverage. For details, read the separate Warranty & Consumer

Information manual provided with the vehicle. If you're unsure about any servicing or maintenance procedure, have it done by an authorized Kia dealer.

WARNING

Maintenance work

Do not wear jewelry or loose clothing while working under the hood of your vehicle with the engine running. These items can become entangled in moving parts, if you must run the engine while working under the hood, make certain that you remove all jewelry (especially rings, bracelets, watches, and necklaces) and all neckties, scarves, and similar loose clothing before getting near cooling fans.

WARNING

Touching metal parts

Do not touch metal parts (including strut bars) while the vehicle is operating or hot. Doing so could result in serious bodily injury. Turn the vehicle off and wait until the metal parts cool down to perform maintenance work on the vehicle.

Owner maintenance

The following lists are vehicle checks and inspections that should be performed by the owner or an authorized Kia dealer at the frequencies indicated to help ensure safe, dependable operation of your vehicle.

Any adverse conditions should be brought to the attention of your dealer as soon as possible.

These owner maintenance checks are generally not covered by warranties and you may be charged for labor, parts and lubricants used.

Owner maintenance schedule

When you stop for fuel:

- Check the coolant level in coolant reservoir.
- Check the windshield washer fluid level.
- Look for low or under-inflated tires.
- Check if the front of the radiator and condenser are clean and not blocked with leaves, dirt or insects etc. If any of the above parts are extremely dirty or you are not sure of their condition, take your vehicle to an authorized Kia dealer.

WARNING

Hot coolant



Be careful when checking your engine coolant level when the engine is hot.

Scalding hot coolant and steam may blow out under pressure.

While operating your vehicle:

- Note any changes in the sound of the exhaust or any smell of exhaust fumes in the vehicle.
- Check for vibrations in the steering wheel. Notice any increased steering effort or looseness in the steering wheel, or change in its straight-ahead position.
- Notice if your vehicle constantly turns slightly or "pulls" to one side when traveling on smooth, level road.
- When stopping, listen and check for unusual sounds, pulling to one side, increased brake pedal travel or "hard-to-push" brake pedal.
- If any slipping or changes in the operation of your transmission occurs, take your vehicle to an authorized Kia dealer.
- Check the transmission P (Park) function.
- Check the parking brake.
- Check for fluid leaks under your vehicle (water dripping from the air conditioning system during or after use is normal).

At least monthly:

- Check the coolant level in the coolant reservoir.
- Check the operation of all exterior lights, including the stoplights, turn signals and hazard warning flashers.
- Check the inflation pressures of all tires including the spare for tires that are worn, show uneven wear, or are damaged.
- Check for loose wheel lug nuts.

At least once every 6 months:

- Check the radiator, heater and air conditioning hoses for leaks or damage.
- Check the windshield washer spray and wiper operation. Clean the wiper blades with clean cloth dampened with washer fluid.
- Check the headlamp alignment.
- Check the muffler, exhaust pipes, shields and clamps.
- Check the lap/shoulder belts for wear and function.

At least once a year:

- Clean the body and door drain holes.
- Lubricate the door hinges and check the hood hinges.
- Lubricate the door and hood locks and latches.
- Lubricate the door rubber weatherstrips.
- Check the air conditioning system.

- Inspect and lubricate transmission linkage and controls.
- Clean the battery and terminals.
- Check the brake fluid level.
- Visually inspect steering, suspension, and chassis components for damaged, loose, or missing parts or signs of wear.

Scheduled maintenance service

Scheduled maintenance service precaution

Follow the Normal Maintenance Schedule if the vehicle is usually operated where none of the following conditions apply. If any of the following conditions apply, follow the Maintenance Under Severe Usage Conditions.

- Repeated driving short distance of less than 8 km (5 miles) in normal temperature or less than 16 km (10 miles) in freezing temperature
- Extensive engine idling or low speed driving for long distances
- Driving on rough, dusty, muddy, unpaved, graveled or salt-spread roads
- Driving in areas using salt or other corrosive materials or in very cold weather
- Driving in heavy dust condition
- Driving in heavy traffic area
- Driving on uphill, downhill, or mountain road repeatedly
- Using for towing or camping and driving with loading on the roof
- Driving as a patrol car, taxi, other commercial use of vehicle towing
- Frequently driving under high speed or rapid acceleration/deceleration
- Frequently driving in stop-and-go condition

If your vehicle is operated in any of the prior listed conditions, you should inspect, replace or refill more frequently, using the severe usage maintenance schedule instead of the normal usage maintenance schedule.

Normal maintenance schedule

The following maintenance services must be performed to ensure good emission control and performance. Keep receipts for all vehicle services to protect your warranty. Where both mileage and date are shown, the frequency of service is determined by whichever occurs first.

I: Inspect and if necessary, adjust, correct, clean or replace.

R: Replace or change.

Number of months or driving distance, whichever comes first													
Months	12	24	36	48	60	72	84	96	108	120	132	144	156
Miles×1,000	8	16	24	32	40	48	56	64	72	80	88	96	104
Km×1,000	13	26	39	52	65	78	91	104	117	130	143	156	169
Tire rotation	Rotate every 13,000 km (8,000 miles)												
Fuel additives *1	Add every 13,000 km (8,000 miles) or 12 months												
Engine oil and engine oil filter *2	Smartstream G3.5 GDI	R	R	R	R	R	R	R	R	R	R	R	R
Climate control air filter (For front seats and rear seats)	I	R	I	R	I	R	I	R	I	R	I	R	I
Air cleaner filter (Engine)	I	I	R	I	I	R	I	I	R	I	I	R	I
Brake fluid	Inspect every 13,000 km (8,000 miles) or 12 months, Replace every 78,000 km (48,000 miles) or 48 months												
Spark plugs	Smartstream G3.5 GDI	Replace every 156,000 km (96,000 miles)											
Coolant (Engine) *3	At first, replace at 195,000 km (120,000 miles) or 120 months After that, replace every 39,000 km (24,000 miles) or 24 months												
Air conditioner refrigerant													
Air conditioner compressor													
Battery condition													
Vacuum hoses													
Brake discs and pads													
Brake lines, hoses and connections (including booster)	I	I	I	I	I	I	I	I	I	I	I	I	I
Suspension ball joints													
Steering gear rack, linkage and boots													
Exhaust system													
Parking brake													

Number of months or driving distance, whichever comes first													
Months	12	24	36	48	60	72	84	96	108	120	132	144	156
Miles×1,000	8	16	24	32	40	48	56	64	72	80	88	96	104
Km×1,000	13	26	39	52	65	78	91	104	117	130	143	156	169
Drive shaft and boots													
Vapor hose, fuel filler cap and canister													
Fuel tank air filter	-		-		-		-		-		-		-
Fuel tank and fuel cap													
Fuel lines, hoses and connections													
Cooling system	-	-	-		-		-		-		-		-
Drive belts (Engine) *4	-	-	-	-	-								
Automatic transmission fluid	Smartstream G3.5 GDi		No service required										

***1. Fuel additives**

Kia recommends that you use Tier 1 unleaded gasoline which has an octane rating of RON (Research Octane Number) 95/AKI (Anti Knock Index) 91 or higher.

For customers who do not use good quality gasolines including fuel additives regularly, and have problems starting or the engine does not run smoothly, one bottle of additives should be added to the fuel tank at every 13,000 km (8,000 miles).

Additives are available from an authorized Kia dealer. Do not mix with other additives.

***2. Engine oil and engine oil filter**

As it is normal for engine oil to be consumed during driving, the engine oil level should be checked on regular basis.

The engine oil change interval for normal operating conditions is based on the use of the recommended engine specification. If the recommended engine oil specification is not used, then replace the engine oil according to the maintenance schedule under severe operating conditions.

***3. Coolant (Engine)**

When adding coolant, use only deionized water or soft water for your vehicle and never mix hard water in the coolant filled at the factory. An improper coolant mixture can result in serious malfunction or engine damage.

***4. Drive belts (Engine)**

Inspect alternator, water pump and air conditioner drive belt and if necessary, repair or replace. Inspect drive belt tensioner, idler and alternator pulley and if necessary correct or replace.

Fuel filter (Gasoline engine)

The fuel filter is considered to be maintenance free but periodic inspection is recommended for this maintenance schedule depends on fuel quality.

- If there are some important safety matters like fuel flow restriction, surging, loss of power, hard starting problem etc, replace the fuel filter immediately regardless of maintenance schedule and consult an authorized Kia dealer for details.

Maintenance under severe usage conditions

I: Inspect and if necessary, adjust, correct, clean or replace.

R: Replace or change.

Maintenance item		Maintenance operation	Maintenance intervals	Driving condition
Engine oil and engine oil filter	Smartstream G3.5 GDi	R	Every 8,000 km (5,000 miles) or 6 months	A, B, C, D, E, F, G, H, I, J, K
Spark plugs	Smartstream G3.5 GDi	R	More frequently	A, B, F, G, H, I, K
Air cleaner filter		R	More frequently	C, E
Climate control air filter		R	More frequently	C, E, G
Automatic transmission fluid	Smartstream G3.5 GDi	R	Every 91,000 km (56,000 miles)	A, C, E, F, G, H, I, K
Steering gear rack, linkage and boots		I	More frequently	C, D, E, F, G, H, I
Suspension ball joints		I	More frequently	C, D, E, F, G, H, I
Brake discs, pads and calipers		I	More frequently	C, D, E, G, H, I, J, K
Drive shaft and boots		I	More frequently	C, D, E, F, G, H, I, J

Severe driving conditions

A: Repeatedly driving short distance of less than 8 km (5 miles) in normal temperature or less than 16 km (10 miles) in freezing temperature.

B: Extensive engine idling or low speed driving for long distances.

C: Driving on rough, dusty, muddy, unpaved, graveled or saltspread roads.

D: Driving in areas using salt or other corrosive materials or in very cold weather

E: Driving in heavy dust condition.

F: Driving in heavy traffic area.

G: Driving on uphill, downhill, or mountain roads repeatedly.

H: Using for towing or camping and driving with loading on the roof.

I: Driving for patrol car, taxi, other commercial use of vehicle towing.

J: Frequently driving under high speed or rapid acceleration/deceleration.

K: Frequently driving in stop-and-go conditions.

Explanation of scheduled maintenance items

Engine oil and filter

The engine oil and filter should be changed at the intervals specified in the maintenance schedule. If the vehicle is being driven in severe conditions, more frequent oil and filter changes are required.

Drive belts

Inspect all drive belts for evidence of cuts, cracks, excessive wear or oil saturation and replace if necessary. Drive belts should be checked periodically for proper tension and adjusted as necessary.

CAUTION

When you are inspecting the belt, place the ignition switch or ENGINE START/STOP button in the LOCK/OFF or ACC position.

Fuel filter

The fuel filter is considered to be maintenance free but periodic inspection is recommended for this maintenance schedule depends on fuel quality.

If there are some important safety matters like fuel flow restriction, surging, loss of power, hard starting

problem etc, replace the fuel filter immediately regardless of maintenance schedule and consult an authorized Kia dealer for details.

Fuel lines, fuel hoses and connections

Check the fuel lines, fuel hoses and connections for leakage and damage. Have the fuel lines, fuel hoses and connections replaced by an authorized Kia dealer.

Vapor hose and fuel filler cap

The vapor hose and fuel filler cap should be inspected at those intervals specified in the maintenance schedule. Make sure that a new vapor hose or fuel filler cap is correctly replaced.

Vacuum crankcase ventilation hoses

Inspect the surface of hoses for evidence of heat and/or mechanical damage. Hard and brittle rubber, cracking, tears, cuts, abrasions, and excessive swelling indicate deterioration. Particular attention should be paid to examine those hose surfaces nearest to high heat sources, such as the exhaust manifold.

Inspect the hose routing to assure that the hoses do not come in contact with any heat source, sharp edges or moving component which

might cause heat damage or mechanical wear. Inspect all hose connections, such as clamps and couplings, to make sure they are secure, and that no leaks are present. Hoses should be replaced immediately if there is any evidence of deterioration or damage.

Air cleaner filter

Have the air cleaner filter replaced by an authorized Kia dealer.

Spark plugs

Make sure to install new spark plugs of the correct heat range.

When assembling parts, be sure to wipe the inside and outside of the boot bottom of the ignition coil and the insulator of the spark plug with a soft cloth to prevent contamination of the spark plug insulator.

⚠ WARNING

Do not disconnect and inspect spark plugs when the engine is hot. You may burn yourself.

Cooling system

Check the cooling system components, such as the radiator, coolant reservoir, hoses and connections for leakage and damage. Replace any damaged parts.

Coolant

The coolant should be changed at the intervals specified in the maintenance schedule.

Automatic transmission fluid

Automatic transmission fluid should not be checked under normal usage conditions. Have the automatic transmission fluid changed by an authorized Kia dealer.

*** NOTICE**

Automatic transmission fluid color is basically red.

As the vehicle is driven, the automatic transmission fluid will begin to look darker. It is normal condition and you should not judge the need to replace the fluid based upon the changed color.

⚠ CAUTION

The use of a non-specified fluid could result in transmission malfunction and failure.

Use only specified automatic transmission fluid. (Refer to "Recommended lubricants and capacities" on page 8-6.)

Brake hoses and lines

Visually check for proper installation, chafing, cracks, deterioration and any leakage. Replace any deteriorated or damaged parts immediately.

Brake fluid

Check the brake fluid level in the brake fluid reservoir. The level should be between "MIN" and "MAX" marks on the side of the reservoir. Use only hydraulic brake fluid conforming to DOT 4 specification.

Brake discs, pads and calipers

Check the pads for excessive wear, discs for run out and wear, and calipers for fluid leakage.

Suspension mounting bolts

Check the suspension connections for looseness or damage. Retighten to the specified torque.

**Steering gear box, linkage & boots/
lower arm ball joint**

With the vehicle stopped and engine off, check for excessive free-play in the steering wheel.

Check the linkage for bends or damage. Check the dust boots and ball joints for deterioration, cracks, or damage. Replace any damaged parts.

Drive shafts and boots

Check the drive shafts, boots and clamps for cracks, deterioration, or damage. Replace any damaged parts and, if necessary, repack the grease.

Air conditioning refrigerant

Check the air conditioning lines and connections for leakage and damage.

Checking fluid levels

When checking engine oil, engine coolant, brake fluid, and washer fluid, always be sure to clean the area around any filler plug, drain plug, or dipstick before checking or draining any lubricant or fluid. This is especially important in dusty or sandy areas and when the vehicle is used on unpaved roads. Cleaning the plug and dipstick areas will prevent dirt and grit from entering the engine and other mechanisms that could be damaged.

Engine oil

Checking the engine oil level

Engine oil is used for lubricating, cooling, and operating various hydraulic components in the engine. Engine oil consumption while driving is normal, and it is necessary to check and refill the engine oil regularly. Also, check and refill the oil level within the recommended maintenance schedule to prevent deterioration of oil performance.

Check the engine oil following the below procedure.

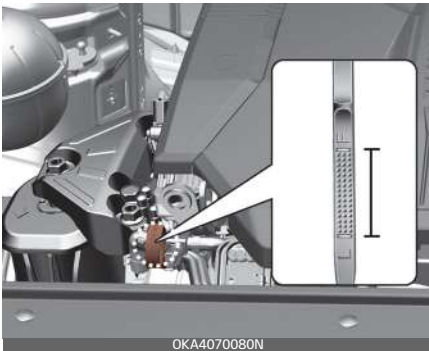

OKA4070080N

1. Be sure the vehicle is on level ground.
2. Start the engine and allow it to reach normal operating temperature.
3. Turn the engine off, remove the oil filler cap and pull the dipstick out. Wait for 15 minutes for the oil to return to the oil pan.
4. Wipe the dipstick clean and reinsert it fully.

5. Pull the dipstick out again and check the level. Check if the oil level is between the F-L line, and if it is below the L line, add enough oil to bring the level to F line.

⚠ WARNING

Radiator hose

Be very careful not to touch the radiator hose when checking or adding the engine oil as it may be hot enough to burn you.

⚠ CAUTION

When you wipe the oil level gauge, you should wipe it with a clean cloth. When mixed with debris, it can cause engine damage.



OKA4071084N

Use a funnel to help prevent oil from being spilled on engine components.

Use only the specified engine oil. (Refer to "Recommended lubricants and capacities" on page 8-6.)

- Do not spill engine oil when adding or changing engine oil. Wipe off spilled oil immediately.
- The engine oil consumption may increase while you break in a new vehicle and it will be stabilized after driving 6,000 km (4,000 miles).
- The engine oil consumption can be affected by driving habits, climate conditions, traffic conditions, oil quality, etc. Therefore, it is recommended that you inspect the engine oil level regularly and refill it if necessary.

Changing the engine oil and filter

Have the engine oil and filter replaced by an authorized Kia dealer.

- If the maintenance schedule to replace engine oil is exceeded, the engine oil performance may deteriorate, and the engine condition may be affected. Therefore, replace the engine oil according to the maintenance schedule.
- To keep the engine in optimal condition, use the recommended engine oil and filter. If the recommended engine oil and filter are not used replace it according to the maintenance schedule under severe usage conditions.
- The purpose of the maintenance schedule for engine oil replacement is to prevent oil deterioration and it is irrelevant to oil

consumption. Check and refill engine oil regularly.

WARNING

Used engine oil may cause skin irritation or cancer if left in contact with the skin for prolonged periods of time. Always protect your skin by washing your hands thoroughly with soap and warm water as soon as possible after handling used oil. Do not leave used engine oil within the reach of children.

NOTICE

When the oil pressure is low due to insufficient engine oil, the Engine Oil Pressure () warning light will illuminate.

In addition, the enhanced engine protection system, which limits the engine's power is activated and the Malfunction Indicator Lamp () will illuminate when the vehicle is driven in this state continuously.

When oil pressure is restored, the Engine Oil Pressure warning light will turn off and the engine power will no longer be limited.

CAUTION

The engine oil is very hot immediately after the vehicle has been driven and can cause burns during replacement. Replace the engine oil after the engine oil has cooled down.

Engine coolant

The high-pressure cooling system has a reservoir filled with year round antifreeze coolant. The reservoir is filled at the factory.

Check the antifreeze protection and coolant level at least once a year, at the beginning of the winter season, and before traveling to a colder climate.

⚠ CAUTION

- When the engine overheats from low engine coolant, suddenly adding engine coolant may cause cracks in the engine. To prevent damage, add engine coolant slowly in small quantities.
- Do not drive with no engine coolant. It may cause water pump failure and engine seizure, etc.

Checking the coolant level

⚠ CAUTION



Removing engine coolant reservoir cap

Never attempt to remove the engine coolant reservoir cap while the engine is operating or hot. Doing so might lead to cooling system and engine damage. Also, hot coolant or

steam could cause serious personal injury.

Turn the engine off and wait until it cools down. Use extreme care when removing the engine coolant reservoir cap. Wrap a thick towel around it, and turn it counterclockwise slowly to the first stop. Step back while the pressure is released from the cooling system.

When you are sure all the pressure has been released, press down on the cap, using a thick towel, and continue turning counterclockwise to remove it.

Even if the engine is not operating, do not remove the engine coolant reservoir cap or the drain plug while the engine and radiator are hot. Hot coolant and steam may still blow out under pressure, causing serious injury.

⚠ WARNING



The electric motor (cooling fan) is controlled by engine coolant temperature, refrigerant pressure and vehicle speed. It may sometimes operate even when the engine is not running. Use extreme caution when working near the blades of the cooling fan so that you are not injured by a rotating fan blades. As the engine coolant tem-

perature decreases, the electric motor will automatically shut off. This is a normal condition.

The electric motor (cooling fan) may operate until you disconnect the negative battery cable.

Check the condition and connections of all cooling system hoses and heater hoses. Replace any swollen or deteriorated hoses.

The coolant level should be filled between MAX and MIN (F and L) marks on the side of the coolant reservoir when the engine is cool.

If the coolant level is low, add enough distilled (deionized) or soft water. Bring the level to MAX (F), but do not overfill.

If frequent additions are required, have the system inspected by an authorized Kia dealer.

* NOTICE

Make sure the coolant cap is properly closed after refill of coolant. Otherwise the engine could be overheated while driving.

1. Check if the engine coolant reservoir cap label is straight in front.



2. Make sure that the tiny protrusions inside the coolant cap are securely interlocked.



Recommended engine coolant

- When adding coolant, use only deionized water or soft water for your vehicle and never mix hard water in the coolant filled at the factory. An improper coolant mixture can result in serious malfunction or engine damage.

- The engine in your vehicle has aluminum engine parts and must be protected by an ethylene-glycol with phosphate based coolant to prevent corrosion and freezing.
- DO NOT USE alcohol or methanol coolant or mix them with the specified coolant.
- Do not use a solution that contains more than 60% antifreeze or less than 35% antifreeze, which would reduce the effectiveness of the solution.

For mixture percentage, refer to the following table.

Ambient Temperature	Mixture Percentage (volume)	
	Antifreeze	Water
-15°C (5°F)	35	65
-25°C (-13°F)	40	60
-35°C (-31°F)	50	50
-45°C (-49°F)	60	40

⚠ WARNING



Engine coolant reservoir cap

Do not remove the engine coolant reservoir cap when the engine and radiator are hot. Scalding hot coolant and steam may blow out under pressure causing serious injury.

Changing the coolant

Have the coolant replaced by an authorized Kia dealer.

⚠ CAUTION

Put a thick cloth around the radiator cap before refilling the coolant in order to prevent the coolant from overflowing into engine parts such as the alternator.

⚠ WARNING

Coolant

- Do not use engine coolant or anti-freeze in the washer fluid reservoir.
- Radiator coolant can severely obscure visibility when sprayed on the windshield and may cause loss of vehicle control or damage the paint and body trim.

Brake fluid

Checking the brake fluid level

Check the fluid level in the reservoir periodically. The fluid level should be between MAX and MIN marks on the side of the reservoir.

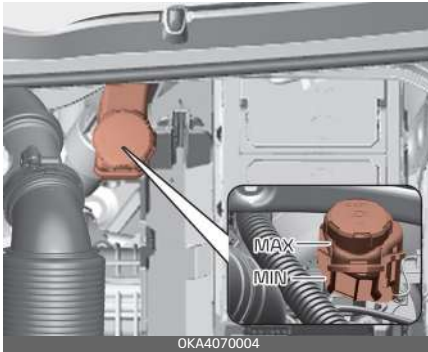

1. Before removing the reservoir cap and adding brake fluid, clean the area around the reservoir cap thoroughly to prevent brake fluid contamination.
2. Periodically check that the fluid level in the brake fluid reservoir is between MIN and MAX. The level will fall with accumulated mileage. This is a normal condition associated with the wear of the brake linings.
If the fluid level is excessively low, have the system checked by an authorized Kia dealer.

Use only the specified brake fluid.
(Refer to "Recommended lubricants and capacities" on page 8-6.)

Never mix different types of fluid.

⚠ WARNING

Loss of brake fluid

In the event the brake system requires frequent additions of fluid, have the system inspected by an authorized Kia dealer.

⚠ WARNING

Brake fluid

When changing and adding brake fluid, handle it carefully. Do not let it come in contact with your eyes. If brake fluid should come in contact with your eyes, immediately flush them with a large quantity of fresh tap water. Have your eyes examined by a doctor as soon as possible.

⚠ CAUTION

Do not allow brake fluid to contact the vehicle's body paint, as paint damage will result. Brake fluid, which has been exposed to open air for an extended time should never be used as its quality cannot be guaranteed. It should be properly disposed. Don't put in the wrong kind of fluid. A few drops of mineral-based oil, such as engine oil, in your brake system can damage brake system parts.

Washer fluid

Checking the washer fluid level

The reservoir is translucent so that you can check the level with a quick visual inspection.

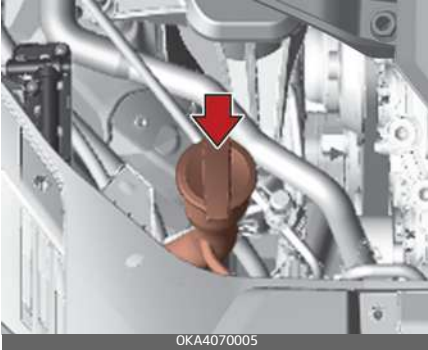

- Check the fluid level in the washer fluid reservoir and add fluid if necessary. Plain water may be used if washer fluid is not available. However, use washer solvent with antifreeze characteristics in cold climates to prevent freezing.

⚠ WARNING

Washer fluid

- Do not use radiator coolant or antifreeze in the washer fluid reservoir.
- Radiator coolant can severely obscure visibility when sprayed on the windshield and may cause loss of vehicle control or damage to paint and body trim.
- Windshield Washer fluid agents contain some amounts of alcohol and can be flammable under certain circumstances. Do not allow sparks or flame to contact the washer fluid or the washer fluid reservoir. Damage to the vehicle or occupants could occur.
- Windshield washer fluid is poisonous to humans and animals. Do not drink and avoid contacting windshield washer fluid. Serious injury or death could occur.

Air cleaner

Filter replacement

Air cleaner filter must be replaced when necessary, and should not be washed.

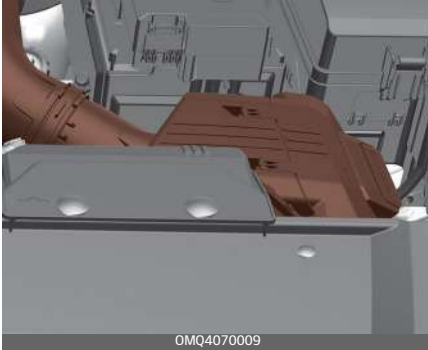

You can clean the filter when inspecting the air cleaner compartment. Clean the filter by using compressed air.

1. Pull up the lever (1) on the air cleaner cover and release the lock.

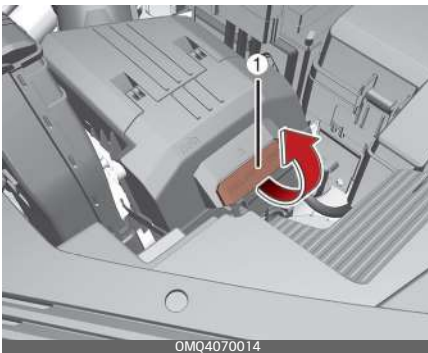

2. Pull up the air cleaner cover (2) and open.

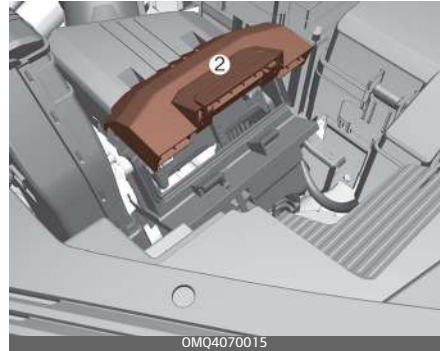

3. Rotate the fixed lever on the filter and loosen the lock.



4. Replace the air cleaner filter.
5. Assemble in reverse order.

Replace the filter according to the Maintenance Schedule.

If the vehicle is operated in extremely dusty or sandy areas, replace the element more often than the usual recommended intervals. (Refer to "Maintenance under severe usage conditions" on page 7-14.)

⚠ CAUTION

- Do not drive with the air cleaner removed; this will result in excessive engine wear.
- When removing the air cleaner filter, be careful that dust or dirt does not enter the air intake, or damage may result.
- Use parts for replacement from an authorized Kia dealer.

Climate control air filter

Filter inspection

The climate control air filter should be replaced according to the maintenance schedule. If the vehicle is operated in severely air-polluted cities or on dusty rough roads for a long period, it should be inspected more frequently and replaced earlier. When you replace the climate control air filter, replace it performing the following procedure, and be careful to avoid damaging other components.

1. Open the glove box and remove the stoppers (1) on the right side.

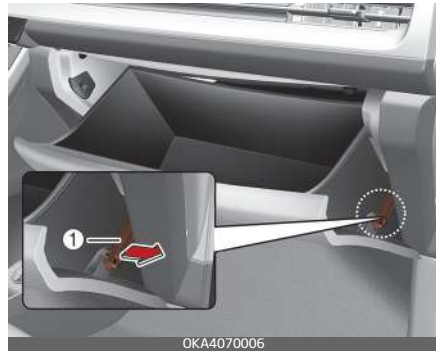

2. With the glove box open, pull the support strap.



3. Remove the climate control air filter cover by pulling out both sides of the cover.

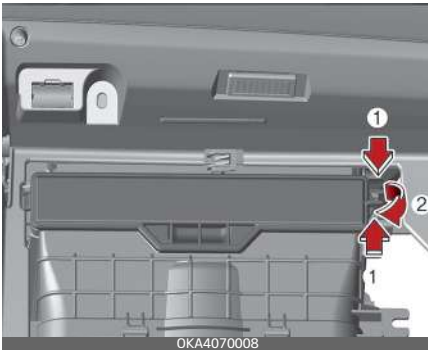

4. Replace the climate control air filter.



5. Reassemble in the reverse order of disassembly.

Rear climate control air filter

1. Open luggage and remove the storage cover (1) on the right side.

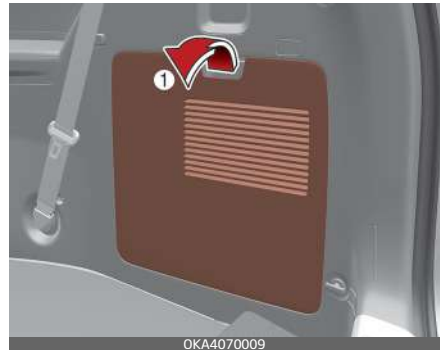

2. Push the upper hook of the rear air filter cover and open the cover (2).

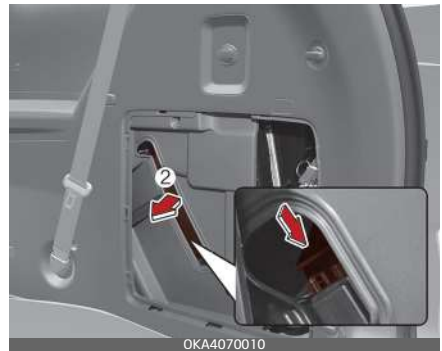

7

3. Remove the rear climate control air filter (3).

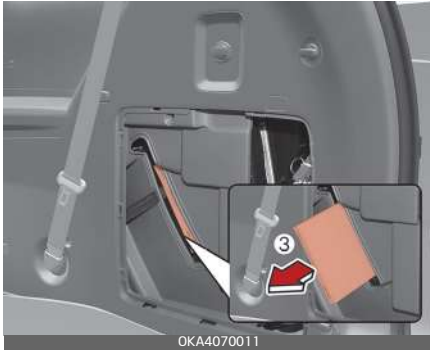

4. Replace the climate control air filter.



5. Reassemble in the reverse order of disassembly.

*** NOTICE**

When replacing the climate control air filter install it properly. Otherwise, the system may produce noise and the effectiveness of the filter may be reduced.



Wiper blades

When the wipers no longer clean adequately, the blades may be worn or cracked, and require replacement.

To prevent damage to the wiper arms or other components, do not attempt to move the wipers manually.

The use of a non-specified wiper blade could result in wiper malfunction and failure.

Blade inspection



* NOTICE

Commercial hot waxes applied by automatic car washes have been known to make the windshield difficult to clean.

Contamination of either the windshield or the wiper blades with foreign matter can reduce the effectiveness of the windshield wipers. Common sources of contamina-

tion are insects, tree sap, and hot wax treatments used by some commercial car washes. If the blades are not wiping properly, clean both the window and the blades with a good cleaner or mild detergent, and rinse thoroughly with clean water.

⚠ CAUTION

To prevent damage to the wiper blades, do not use gasoline, kerosene, paint thinner, or other solvents on or near them.

Blade replacement

When the wipers no longer clean adequately, the blades may be worn or cracked, and require replacement.

⚠ CAUTION

To prevent damage to the wiper arms or other components, do not attempt to move the wipers manually.

⚠ CAUTION

The use of a non-specified wiper blade could result in wiper malfunction and failure.

Front wiper blade replacement



For your convenience and to prevent hood paint damage, you must move the windshield wiper blades to the service position as follows.

After turning off the engine, move the wiper switch to the single wiping (MIST) position within 20 seconds and hold the switch more than 2 seconds until the wiper blade is in the fully up position.

⚠ CAUTION

Wiper arms

- Do not allow the wiper arm to fall against the windshield, since it may chip or crack the windshield.
- Do not pull the wiper arm forward, since arm could chip hood paint.

Type A

1. Raise the wiper arm and turn the wiper blade assembly to expose the plastic locking clip.



⚠ CAUTION

Wiper arms

Do not allow the wiper arm to fall against the windshield, since it may chip or crack the windshield.

2. Compress the clip and slide the blade assembly downward.

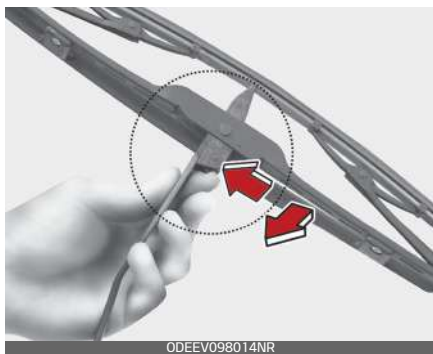

3. Lift it off the arm.

4. Install the blade assembly in the reverse order of removal.

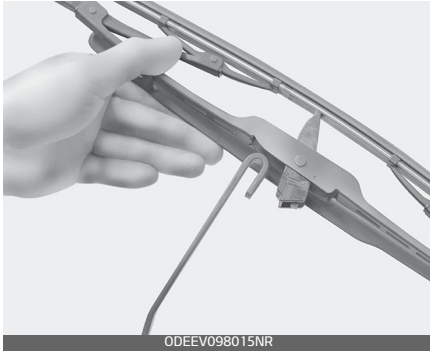

Type B

1. Raise the wiper arm.
2. Lift up the wiper blade clip (1). Then pull down the blade assembly (2) and remove it.

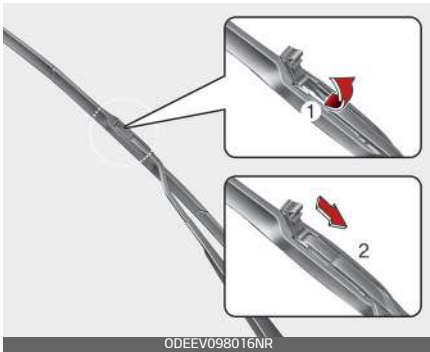

3. Install the new blade assembly.



4. Return the wiper arm on the windshield.
5. Turn the ignition switch or ENGINE START/STOP button to the ON position and wiper arms will return to the normal operating position.

Rear wiper blade replacement



1. Within 20 seconds after the vehicle ignition is OFF, move the wiper lever to MIST position for over 2 seconds until the wiper moves down to the bottom middle part.

2. Raise the wiper arm and pull out the wiper blade assembly.



3. Lift up the wiper blade, and pull the blade to remove it.



4. Install the new blade assembly by inserting the center part into the slot in the wiper arm until it clicks into place.



5. Make sure the blade assembly is installed firmly by trying to pull it slightly.

If the replacement is complete, put down the wiper arm to place it on the rear windshield, and turn the vehicle ignition to ON and operate the wipers to check the blade is installed correctly.

To prevent damage to the wiper arms or other components, have the wiper blade replaced by a professional workshop. Contact and visit an authorized Kia dealer.

⚠ CAUTION

If the wiper arm receives too much force while pulling the blade, the center part may be damaged.

⚠ CAUTION

- The wiper could not operate for approx. 10 seconds when the wiper is operated without washer fluid or the blades are frozen. This is not a malfunction, it is a wiper protection system activated by motor overload circuit within the wiper motor.
- The front windshield should be cleaned with water hose and wiped with clean towel with wiper blades raised up. Also, the wiper blades should be wiped clean when the grease or wax is applied to the blades.

Battery

For best battery service

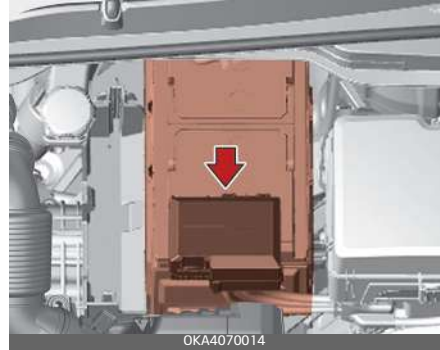

- Keep the battery securely mounted.
- Keep the battery top clean and dry.
- Keep the terminals and connections clean, tight, and coated with petroleum jelly or terminal grease.
- Rinse any spilled electrolyte from the battery immediately with a solution of water and baking soda.
- If the vehicle is not going to be used for an extended time, disconnect the battery cables.

* NOTICE

Your vehicle is equipped with maintenance free battery. If your vehicle is equipped with the battery marked with LOWER and UPPER on the side, you can check the electrolyte level. The electrolyte level should be between LOWER and UPPER. If the electrolyte level is low, it needs to

add distilled (demineralized) water (Never add sulfuric acid or other electrolyte). When refill, be careful not to splash the battery and adjacent components. And do not overfill the battery cells. It can cause corrosion on other parts. Make sure that the cell caps are tightened.

Contact an authorized Kia dealer.

⚠️ WARNING

Risk of explosion



Keep lit cigarettes and all other flames or sparks away from the battery.



The battery contains hydrogen -- a highly combustible gas which will explode if it comes in contact with a flame or spark.



Keep batteries out of the reach of children because batteries contain highly corrosive SULFURIC ACID and electrolytes. Do not allow battery acid to contact your skin, eyes, clothing or paint finish.



Wear eye protection when charging or working near a battery. Always provide ventilation when working in an enclosed space.



Always read the following instructions carefully when handling a battery.



If any electrolyte gets into your eyes, flush your eyes with clean water for at least 15 minutes and get immediate medical attention. If electrolyte gets on your skin, thoroughly wash the contacted area. If you feel pain or burning sensation, get medical attention immediately.



An inappropriately disposed battery can be harmful to the environment and human health. Dispose the battery according to your local law(s) or regulation.



The battery contains lead. Do not dispose of it after use. Please return the battery to an authorized Kia dealer to be recycled.

Never attempt to recharge the battery when the battery cables are connected.

⚠️ WARNING

Risk of electrocution

Never touch the electrical ignition system while the vehicle is running. This system works with high voltage, which can "zap" you.

* NOTICE

If you connect unauthorized electronic devices to the battery, the battery may be discharged. Never use unauthorized devices.

⚠ WARNING

Recharging battery

Never attempt to recharge the battery when the battery cables are connected.

⚠ WARNING

Battery lead compound

Battery posts, terminals, and related accessories contain lead and lead compounds. Wash hands after handling.

Battery recharging

Your vehicle has a maintenance-free, calcium-based battery.

- If the battery becomes discharged in a short time (because, for example, the headlamps or interior lights were left on while the vehicle was not in use), recharge it by slow charging (trickle) for 10 hours.
- If the battery gradually discharges because of high electric load while the vehicle is being used, recharge it at 20 ~ 30 A for two hours.

When recharging the battery, observe the following precautions:

- The battery must be removed from the vehicle and placed in an area with good ventilation.
- Do not allow cigarettes, sparks, or flame near the battery.
- Watch the battery during charging, and stop or reduce the charging rate in following cases:
 1. the battery cells begin gassing (boiling) violently
 2. the electrolyte temperature of any cell exceeds 49 °C (120 °F).
- Wear eye protection when checking the battery during charging.
- Before performing maintenance or recharging the battery, turn off all accessories and stop the vehicle.
- Disconnect the battery charger in the following order.
 1. Turn off the battery charger main switch.
 2. Unhook the negative clamp from the negative battery terminal.
 3. Unhook the positive clamp from the positive battery terminal.
- The negative battery cable must be removed first and installed last when the battery is disconnected.

⚠ CAUTION

AGM battery

- Absorbent Glass Mat (AGM) batteries are maintenance free and have the AGM battery serviced by an authorized Kia dealer.
For charging your AGM battery, use only fully automatic battery chargers that are specially developed for AGM batteries.
 - When replacing the AGM battery, use parts for replacement from an authorized Kia dealer.
 - Do not open or remove the cap on top of the battery. This may cause leaks of internal electrolyte that could result in severe injury.
-

- Driver's seat position (Refer to "Driver Position Memory System (if equipped)" on page 4-31)

Reset items

The following items should be reset after the battery has been discharged or the battery has been disconnected.

- Auto up/down window (Refer to "Window opening and closing" on page 4-63)
- Trip computer (Refer to "Trip information (trip computer)" on page 4-117)
- Climate control system (Refer to "Automatic climate control system (if equipped)" on page 4-184)
- Sunroof (Refer to "Sunroof (if equipped)" on page 4-73)

Tires and wheels

For proper maintenance, safety, and maximum fuel economy, you must always maintain the recommended tire inflation pressures and stay within the load limits and weight distribution recommended for your vehicle.

Recommended cold tire inflation pressures

All tire pressures should be checked when the tires are cold. "Cold Tires" means the vehicle has not been driven for at least three hours or driven less than 1 mile (1.6 km).

Recommended pressures must be maintained for the best ride, vehicle handling, and minimum tire wear.

For recommended inflation pressure, refer to "Tires and wheels" on page 7-37.

All specifications (sizes and pressures) can be found on a label attached to the driver's side center pillar.



⚠ WARNING

Tire underinflation

Inflate your tires consistent with the instructions provided in this manual. Regularly check the tire inflation pressure, and correct it as needed; at least twice a month and before any long trips on the road. If you fail to observe this precaution, you may be driving on underinflated tires, which may not only compromise your vehicle's driving stability, but may also lead to tire damage and the risk of an accident. This risk is much higher on hot days and when driving for long periods at high speeds.

Failure to maintain specified pressure may result in excessive wear, poor handling, reduced fuel economy, deformation of tire and/or wheel, harsh ride conditions, possibility for additional damage from road hazards, or result in tire failure.

Tire pressure

Always observe the following:

- Check tire pressure when the tires are cold. (After vehicle has been parked for at least three hours or hasn't been driven more than 1 mile (1.6 km) since startup.)
- Check the pressure of your spare tire each time you check the pressure of other tires. (if equipped)
- Never overload your vehicle. Be careful not to overload a vehicle luggage rack if your vehicle is equipped with one.
- Warm tires normally exceed recommended cold tire pressures by 28 ~ 41 kPa (4 ~ 6 psi). Do not release air from warm tires to adjust the pressure or the tires will be underinflated.

WARNING

Tire Inflation

Overinflation or underinflation can reduce tire life, adversely affect vehicle handling, and lead to sudden tire failure. This could result in loss of vehicle control and potential injury.

Checking tire inflation pressure

Check your tires once a month or more.

Use a good quality gauge to check tire pressure. You cannot tell if your

tires are properly inflated simply by looking at them. Radial tires may look properly inflated even when they're underinflated.

Check the tire's inflation pressure when the tires are cold. "Cold" means your vehicle has been sitting or at least three hours or driven no more than 1.6 km (1 mile).

1. Remove the valve cap from the tire valve stem.
2. Press the tire gauge firmly onto the valve to get a pressure measurement. If the cold tire inflation pressure matches the recommended pressure on the tire and loading information label, no further adjustment is necessary.
3. If the pressure is low, add air until you reach the recommended amount.
4. If you overfill the tire, release air by pushing on the metal stem in the center of the tire valve.
5. Recheck the tire pressure with the tire gauge.
6. Be sure to put the valve caps back on the valve stems. They help prevent leaks by keeping out dirt and moisture.

Inspect your tires frequently for proper inflation as well as wear and damage. Always use a tire pressure gauge.

Tires with too much or too little pressure wear unevenly. This could result in poor handling, loss of vehicle control, and sudden tire failure

leading to accidents, injuries, and even death. The recommended cold tire pressure for your vehicle can be found in this manual and on the tire label located on the driver's side center pillar.

Tire rotation

To equalize tread wear, it is recommended that the tires be rotated every 13,000 km (8,000 miles) or sooner if irregular wear develops.

During rotation, check the tires for correct balance.

When rotating tires, check for uneven wear and damage. Abnormal wear is usually caused by incorrect tire pressure, improper wheel alignment, out-of-balance wheels, severe braking or severe cornering. Look for bumps or bulges in the tread or side of tire. Replace the tire if you find either of these conditions. Replace the tire if fabric or cord is visible. After rotation, be sure to bring the front and rear tire pressures to specification and check lug nut tightness. (proper torque is 11 ~ 13 kgf·m [79 ~ 94 lbf·ft])

Refer to "Tires and wheels" on page 7-37.

Disc brake pads should be inspected for wear whenever tires are rotated.

With a full-size spare tire (if equipped)

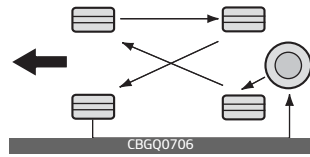

Without a spare tire

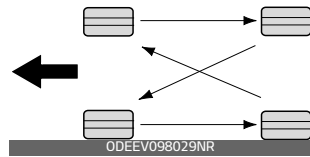

Directional tires (if equipped)

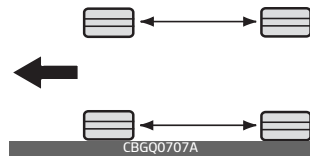

Rotate radial tires that have an asymmetric tread pattern only from front to rear and not from right to left.

⚠ WARNING

Mixing tires

Do not mix bias ply and radial ply tires under any circumstances. This may cause unusual handling characteristics.

Wheel alignment and tire balance

The wheels on your vehicle were aligned and balanced carefully at the factory to give you the longest tire life and best overall performance.

If you notice unusual tire wear or your vehicle pulling one way or the other, the alignment may need to be reset.

If you notice your vehicle vibrating when driving on a smooth road, your wheels may need to be rebalanced.

⚠ CAUTION

Wheel weight

Improper wheel weights can damage your vehicle's aluminum wheels. Use only approved wheel weights.

Tire replacement

If the tire is worn evenly, a tread wear indicator will appear as a solid band across the tread.



[A] : Tread wear indicator

This shows there is less than 1.6 mm (1/16 in) of tread left on the tire. Replace the tire when this happens.

Do not wait for the band to appear across the entire tread before replacing the tire.

The Anti-lock Brake System (ABS) works by comparing the speed of the wheels. The tire size affects wheel speed. When replacing tires, all 4 tires must use the same size originally supplied with the vehicle. Using tires of a different size can cause the ABS and Electronic Stability Control (ESC) to work irregularly.

It is best to replace all four tires at the same time. If that is not possible, or necessary, then replace the two front or two rear tires as a pair. Replacing just one tire can seriously affect your vehicle's handling.

* NOTICE

We recommend that when replacing tires, use the same originally supplied with the vehicles. If not, that affects driving performance.

Wheel replacement

When replacing the metal wheels for any reason, make sure the new wheels are equivalent to the original factory units in diameter, rim width and offset.

A wheel with an incorrect size may adversely affect many things: wheel and bearing life, braking and stopping abilities, handling characteristics, ground clearance, body-to-tire clearance, snow chain clearance, speedometer and odometer calibration, headlamp aiming and bumper height.

⚠ CAUTION

Wheels

Wheels that do not meet Kia specifications may fit poorly and result in damage to the vehicle or unusual handling and poor vehicle control.

Tire traction

Tire traction can be reduced if you drive on worn tires, tires that are improperly inflated or on slippery road surfaces.

Tires should be replaced when tread wear indicators appear. Slow down whenever there is rain, snow or ice on the road to reduce the possibility of losing control of the vehicle.

Tire maintenance

In addition to proper inflation, correct wheel alignment helps to decrease tire wear.

If you find a tire is worn unevenly, have your dealer check the wheel alignment.

Make sure the newly installed tires are balanced correctly to increase vehicle ride comfort and tire life. In addition, always rebalance the tire when the tire is removed from the wheel.

Tire sidewall labeling

This information identifies and describes the fundamental characteristics of the tire and also provides the Tire Identification Number (TIN) for safety standard certification.

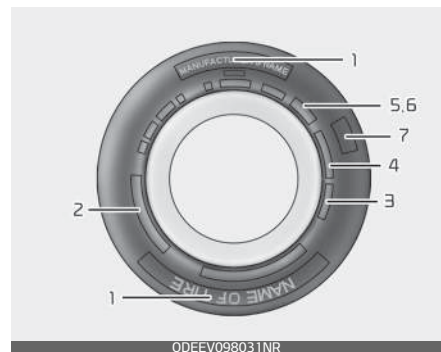

The TIN can be used to identify the tire in case of a recall.

1. *Manufacturer or brand name*

Manufacturer or Brand name is shown.

2. *Tire size designation*

A tire's sidewall is marked with a tire size designation. You will need this information when selecting replacement tires for your vehicle. The following explains what the letters and numbers in the tire size designation mean.

Example tire size designation:

(These numbers are provided as an example only; your tire size designator could vary depending on your vehicle.)

P235/55R19 108T

- P: Applicable vehicle type (tires marked with the prefix "P" are intended for use on passenger vehicles or light trucks; however, not all tires have this marking).
- 235: Tire width in millimeters.
- 55: Aspect ratio. The tire's section height as a percentage of its width.
- R: Tire construction code (Radial).
- 19: Rim diameter in inches.
- 108: Load Index, a numerical code associated with the maximum load the tire can carry.
- T: Speed Rating Symbol. See the speed rating chart in this section for additional information.

Wheel size designation

Wheels are also marked with important information that you need if you ever have to replace one. The following explains what the letters and numbers in the wheel size designation mean.

Example wheel size designation:

7.5JX19

- 7.5: Rim width in inches.
- J: Rim contour designation.
- 19: Rim diameter in inches.

Tire speed ratings

The chart below lists many of the different speed ratings currently being used for passenger vehicle tires. The speed rating is part of the tire size designation on the sidewall of the tire. This symbol corresponds to that tire's designed maximum safe operating speed.

Speed Rating Symbol	Maximum Speed
S	180 km/h (112 mph)
T	190 km/h (118 mph)
H	210 km/h (130 mph)
V	240 km/h (149 mph)
W	270 km/h (168 mph)
Y	300 km/h (186 mph)

3. *Checking tire life*

Any tires that are over 6 years old, based on the manufacturing date, should be replaced by new ones. You can find the manufacturing date on the tire sidewall (possibly on the inside of the wheel), displaying the

DOT code. The DOT code is a series of numbers on a tire consisting of numbers and English letters. The manufacturing date is designated by the last four digits (characters) of the DOT code.

DOT: XXXX XXXX 0000

The front part of the DOT means a plant code number, tire size and tread pattern and the last four numbers indicate week and year manufactured.

For example:

DOT XXXX XXXX 1621 represents that the tire was produced in the 16th week of 2021.

⚠ WARNING

Tire age

Replace tires within the recommended time frame. Failure to replace tires as recommended can result in sudden tire failure, which could lead to a loss of control and an accident.

4. Tire ply composition and material

The number of layers or plies of rubber-coated fabric in the tire. Tire manufacturers also must indicate the materials in the tire, which include steel, nylon, polyester, and others. The letter "R" means radial

ply construction; the letter "D" means diagonal or bias ply construction; and the letter "B" means belted-bias ply construction.

5. Maximum permissible inflation pressure

This number is the greatest amount of air pressure that should be put in the tire. Do not exceed the maximum permissible inflation pressure. Refer to "Certification label" on page 5-204 for recommended inflation pressure.

6. Maximum load rating

This number indicates the maximum load in kilograms and pounds that can be carried by the tire. When replacing the tires on the vehicle, always use a tire that has the same load rating as the factory installed tire.

7. Uniform Tire Quality Grading

Quality grades can be found where applicable on the tire sidewall between tread shoulder and maximum section width.

For example:

- Treadwear 200
- Traction AA
- Temperature A

Tires degrade over time, even when they are not being used. Regardless of the remaining tread, we recommend that tires be replaced after approximately six (6) years of normal service. Heat caused by hot climate or frequent high loading conditions can accelerate the aging process.

Tread wear

The tread wear grade is a comparative rating based on the wear rate of the tire when tested under controlled conditions on a specified government test course. For example, a tire graded 150 would wear one-and-a-half times (1½) as well on the government course as a tire graded 100.

The relative performance of tires depends upon the actual conditions of their use. Performance may depart significantly from the norm due to variations in driving habits, service practices and differences in road characteristics and climate. These grades are molded on the side-walls of passenger vehicle tires. The tires available as standard or optional equipment on your vehicle may vary with respect to grade.

Traction - AA, A, B & C

The traction grades, from highest to lowest, are AA, A, B and C. Those grades represent the tire's ability to stop on wet pavement as measured under controlled conditions on specified government test surfaces of

asphalt and concrete. A tire marked C may have poor traction performance.

The traction grade assigned to this tire is based on straight-ahead braking traction tests, and does not include acceleration, cornering, hydroplaning, or peak traction characteristics.

Temperature -A & B

Sustained high temperature can cause the material of the tire to degenerate and reduce tire life, and excessive temperature can lead to sudden tire failure. Grades B and A represent higher levels of performance on the laboratory test wheel than the minimum required by law.

Tire terminology and definitions

Refer to the following for detailed definitions of the terms that are found in the tire description.

Air Pressure The amount of air inside the tire pressing outward on the tire. Air pressure is expressed in pounds per square inch (psi) or kilopascal (kPa).

Accessory Weight The combined weight of optional accessories. Some examples of optional accessories are automatic transmission, power seats, and air conditioning.

Aspect Ratio The relationship of a tire's height to its width.

Belt A rubber coated layer of cords that is located between the plies and the tread. Cords may be made from steel or other reinforcing materials.

Bead The tire bead contains steel wires wrapped by steel cords that hold the tire onto the rim.

Bias Ply Tire A pneumatic tire in which the plies are laid at alternate angles less than 90 degrees to the centerline of the tread.

Cold Tire Pressure The amount of air pressure in a tire, measured in pounds per square inch (psi) or kilopascals (kPa) before a tire has built up heat from driving.

Curb Weight The weight of a motor vehicle with standard and optional equipment (including the maximum capacity of fuel, oil and coolant), but without passengers and cargo.

DOT Markings The DOT code includes the Tire Identification Number (TIN), an alphanumeric designator which can also identify the tire manufacturer, production plant, brand and date of production.

GVWR Gross Vehicle Weight Rating

GAWR FRT Gross Axle Weight Rating for the Front axle.

GAWR RR Gross Axle Weight Rating for the Rear axle.

Intended Outboard Sidewall The side of an asymmetrical tire that must always face outward when mounted on a vehicle.

Kilopascal (kPa) The metric unit for air pressure.

Light truck (LT) tire A tire designated by its manufacturer as primarily intended for use on lightweight trucks or multipurpose passenger vehicles.

Load ratings The maximum load that a tire is rated to carry for a given inflation pressure.

Load Index An assigned number ranging from 1 to 279 that corresponds to the load carrying capacity of a tire.

Maximum Inflation Pressure The maximum air pressure to which a cold tire may be inflated. The maximum air pressure is molded onto the sidewall.

Maximum Load Rating The load rating for a tire at the maximum permissible inflation pressure for that tire.

Maximum Loaded Vehicle Weight The sum of curb weight; accessory weight; vehicle capacity weight; and production options weight.

Normal Occupant Weight The number of occupants a vehicle is

designed to seat multiplied by 68 kg (150 lbs.).

Occupant Distribution Designated seating positions.

Outward Facing Sidewall The side of a asymmetrical tire that has a particular side that faces outward when mounted on a vehicle. The outward facing sidewall bears white lettering or bears manufacturer, brand, and/or model name molding that is higher or deeper than the same moldings on the inner facing sidewall.

Passenger (P-Metric) Tire A tire used on passenger cars and some light duty trucks and multipurpose vehicles.

Ply A layer of rubber-coated parallel cords.

Pneumatic tire A mechanical device made of rubber, chemicals, fabric and steel or other materials, that, when mounted on an automotive wheel, provides the traction and contains the gas or fluid that sustains the load.

Production options weight The combined weight of installed regular production options weighing over 2.3 kg (5 lbs.) in excess of the standard items which they replace, not previously considered in curb weight or accessory weight. Examples include heavy duty brakes, ride lev-

elers, roof rack, heavy duty battery, and special trim.

Recommended Inflation Pressure

Vehicle manufacturer's recommended tire inflation pressure and shown on the tire placard.

Radial Ply Tire A pneumatic tire in which the ply cords that extend to the beads are laid at 90 degrees to the centerline of the tread.

Rim A metal support for a tire and upon which the tire beads are seated.

Sidewall The portion of a tire between the tread and the bead.

Speed Rating An alphanumeric code assigned to a tire indicating the maximum speed at which a tire can operate.

Traction The friction between the tire and the road surface. The amount of grip provided.

Tread The portion of a tire that comes into contact with the road.

Treadwear Indicators Narrow bands, sometimes called "wear bars," that show across the tread of a tire when only 2/32 inch (1.6 mm) of tread remains.

UTQGS Uniform Tire Quality Grading Standards, a tire information system that provides consumers with ratings for a tire's traction, temperature and treadwear. Ratings are

determined by tire manufacturers using government testing procedures. The ratings are molded into the sidewall of the tire.

Vehicle Capacity Weight The weight of designated seating positions multiplied by 68 kg (150 lbs.) plus the rated cargo and luggage load.

Vehicle Maximum Load on the Tire Load on an individual tire due to curb and accessory weight plus maximum occupant and cargo weight.

Vehicle Normal Load on the Tire Load on an individual tire that is determined by distributing to each axle its share of the curb weight, accessory weight, and normal occupant weight and driving by 2.

Vehicle Placard A label permanently attached to a vehicle showing the original equipment tire size and recommended inflation pressure.

All season tires

Kia specifies all season tires on some models to provide good performance for use all year round, including snowy and icy road conditions.

All season tires are identified by ALL SEASON and/or M+S (Mud and Snow) on the tire sidewall. Snow tires have better snow traction than all season tires and may be more appropriate in some areas.

Summer tires

Kia specifies summer tires on some models to provide superior performance on dry roads.

Summer tire performance is substantially reduced in snow and ice. Summer tires do not have the tire traction rating M+S (Mud and Snow) on the tire side wall. If you plan to operate your vehicle in snowy or icy conditions, Kia recommends the use of snow tires or all season tires on all four wheels.

Snow tires

If you equip your vehicle with snow tires, they should be the same size and have the same load capacity as the original tires.

Snow tires should be installed on all four wheels; otherwise, poor handling may result.

Snow tires should carry 28 kPa (4 psi) more air pressure than the pressure recommended for the standard tires on the tire label on the driver's side of the center pillar, or up to the maximum pressure shown on the tire sidewall, whichever is less.

Do not drive faster than 120 km/h (75 mph) when your vehicle is equipped with snow tires.

⚠ WARNING

Do not use summer tires at temperatures below 7 °C (45 °F) or when driving on snow or ice. At temperatures below 7 °C (45 °F), summer tires can lose elasticity, and therefore traction and braking power as well. Change the tires on your vehicle to winter or all-weather tires of the same size as the standard tires of the vehicle. Both types of tires are identified by the M+S (Mud and Snow) marking. Using summer tires at very cold temperatures could cause cracks to form, thereby damaging the tires permanently.

Radial-ply tires

Radial-ply tires provide improved tread life, road hazard resistance and smoother high speed ride.

The radial-ply tires used on this vehicle are of belted construction, and are selected to complement the ride and handling characteristics of your vehicle. Radial-ply tires have the same load carrying capacity, as bias-ply or bias belted tires of the same size, and use the same recommended inflation pressure.

Mixing of radial-ply tires with bias-ply or bias belted tires is not recommended. Any combinations of radial-ply and bias-ply or bias

belted tires when used on the same vehicle will seriously deteriorate vehicle handling. The best rule to follow is: Identical radial-ply tires should always be used as a set of four.

Longer wearing tires can be more susceptible to irregular tread wear. It is very important to follow the tire rotation interval shown in this section to achieve the tread life potential of these tires. Cuts and punctures in radial-ply tires are repairable only in the tread area, because of sidewall flexing. Consult your tire dealer for radial-ply tire repairs.

Fuses

Blade type



Cartridge type



Multi fuse

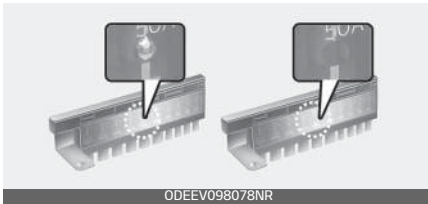

High voltage fuse

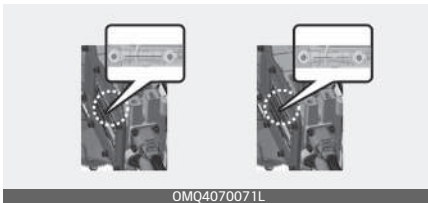

* Left side: Normal, Right side:
Blown

* The actual fuse/relay panel label
may differ from equipped items.

A vehicle's electrical system is protected from electrical overload damage by fuses.

This vehicle has 2 (or 3) fuse panels, one located in the driver's side panel bolster, the other in the engine compartment near the battery.

If any of your vehicle's lights, accessories, or controls do not work, check the appropriate circuit fuse. If a fuse has blown, the element inside the fuse will melt.

If the electrical system does not work, first check the driver's side fuse panel.

If the replacement fuse blows, this indicates an electrical problem. Avoid using the system involved and immediately consult an authorized Kia dealer.

Three kinds of fuses are used: blade type for lower amperage rating, cartridge type, and multi fuse for higher amperage ratings.

⚠ WARNING

Fuse replacement

- Never replace a fuse with anything but another fuse of the same rating.
- A higher capacity fuse could cause damage and possibly a fire.
- Never install a wire or aluminum foil instead of the proper fuse – even as a temporary repair. It

may cause extensive wiring damage and a possible fire.

- Do not arbitrarily modify or add-on electric wiring to the vehicle.

⚠ CAUTION

Do not use a screwdriver or any other metal object to remove fuses because it may cause a short circuit and damage the system.

* NOTICE

- When replacing a fuse, turn the ignition 'OFF' and turn off switches of all electrical devices then remove battery (-) terminal.
- The actual fuse/relay panel label may differ from equipped items.

⚠ WARNING

Electrical fire

Always ensure replacements fuses and relays are securely fastened when installed. Failure to do so can result in a vehicle fire.

Do not remove fuses, relays and terminals fastened with bolts or nuts. The fuses, relays and terminals may be fastened incompletely, and it may cause a possible fire. If fuses, relays and terminals fastened with bolts or nuts are blown, consult with an authorized Kia dealer.

⚠ CAUTION

When replacing a blown fuse or relay, make sure the new fuse or relay fits tightly into the clips. Failure to tightly install the fuse or relay may cause damage to the wiring and electric systems.

⚠ CAUTION

- Do not input any other objects except fuses or relays into fuse/relay terminals such as a screwdriver or wiring. It may cause contact failure and system malfunction.
- Do not plug in screwdrivers or aftermarket wiring into the terminal originally designed for fuse and relays only. The electrical system and wiring of the vehicle interior may be damaged or burned due to contact failure.
- If you directly connect the wire on the taillamp or replace the bulb which is over the regulated capacity to install trailers etc., the inner junction block can get burned.

⚠ WARNING

Electrical wiring repairs

All electrical repairs should be performed by authorized Kia dealerships using approved Kia parts. Using other wiring components,

especially when retrofitting multi-media or theft alarm system, car phone or radio may cause vehicle damage and increase the risk of a vehicle fire.

* NOTICE

Remodeling prohibited

Do not rewire your vehicle in any way as doing so may affect the performance of several safety features in your vehicle. Rewiring your vehicle may also void your warranty and cause you to be responsible for any subsequent vehicle damage which may result.

Inner panel fuse replacement

1. Turn the ignition switch or ENGINE START/STOP button and all other switches off.
2. Open the fuse panel cover.



3. Pull the suspected fuse straight out. Use the removal tool provided in the main fuse box in the engine compartment.

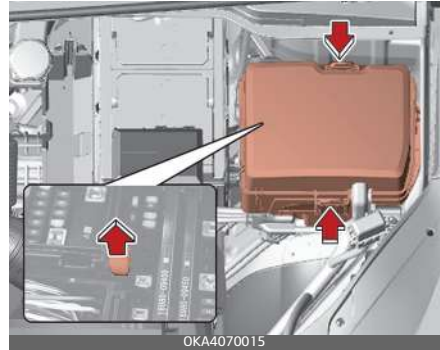

4. Check the removed fuse; replace it if it is blown. Spare fuses are provided in the instrument panel fuse panel (or in the engine compartment fuse panel).
5. Push in a new fuse of the same rating, and make sure it fits tightly in the clips.

If it fits loosely, consult an authorized Kia dealer.

If you do not have a spare, use a fuse of the same rating from a circuit you may not need for operating the vehicle, such as the cigarette lighter fuse.

If the headlamps or taillamps, stoplights, courtesy lamp, day time running lights (DRL) do not work and the fuses are OK, consult an authorized Kia dealer.

Engine compartment fuse replacement

1. Turn the ignition and all other switches off.
2. Remove the fuse panel cover by pressing the tab and pulling the cover up.

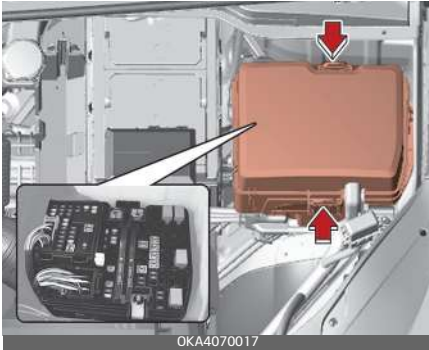

3. Check the removed fuse; replace it if it is blown. To remove or insert the fuse, use the fuse puller in the engine compartment fuse panel.
4. Push in a new fuse of the same rating, and make sure it fits tightly in the clips. If it fits loosely, consult an authorized Kia dealer.

⚠ CAUTION

After checking the fuse panel in the engine compartment, securely install the fuse panel cover through the audible clicking sound. If not, electrical failures may occur from water contact.

* NOTICE

If the multi fuse is blown, consult an authorized Kia dealer.

* NOTICE

The electronic system may not function correctly even when the engine room and internal fuse box's individual fuses are not disconnected. In such case the cause of the problem may be disconnection of the main fuse (BFT type), which is located inside the positive battery terminal (+) cap. Since the main fuse is designed more intricately than other parts, visit the nearest authorized Kia dealer.

Main fuse (Multi fuse)

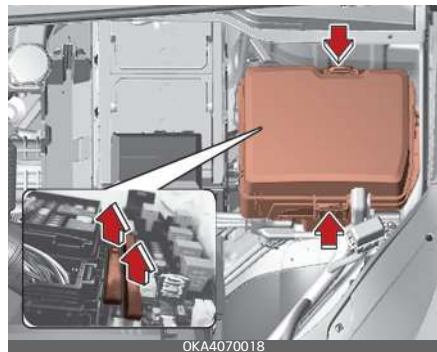

If the main fuse is blown, it must be removed as follows:

1. Turn off the engine.
2. Disconnect the negative battery cable.

3. Remove the nuts shown in the picture above.
4. Replace the fuse with a new one of the same rating.
5. Reinstall in the reverse order of removal.

CAUTION

Visually inspect the battery cap for secure closing. If the battery cap is not securely latched, the electrical system may be damaged to due influx of moisture into the system.

Fuse/relay panel description

Inside the fuse/relay panel covers, you can find the fuse/relay label describing fuse/relay name and capacity.

NOTICE

Not all fuse panel descriptions in this manual may be applicable to your vehicle. It is accurate at the time of printing. When you inspect the fuse panel in your vehicle, refer to the fuse panel label.

ICU Junction Block

Fuse Name	Fuse rating	Circuit Protected
SUNROOF1	25A	Front Sunroof Motor
AMP	30A	AMP (Amplifier) (BOSE)
S/HEATER (REAR LH)	20A	2nd Seat Left Handle side Air Ventilation Control Module, 2nd Seat Warmer Control Module
P/SEAT (DRV)	30A	Driver IMS (Integrated memory system) Control Module, Driver Power Seat Switch
P/WINDOW (LH)	25A	Driver Safety Power Window Module, Rear Power Window Switch Left Handle side, Rear Safety Power Window Module Left Handle side
P/SEAT (PASS)	30A	Passenger Walk-In Module, Passenger Power Seat Switch
S/HEATER (FRT)	20A	Front Air Ventilation Seat Control Module, Front Seat Warmer Control Module
SUNROOF2	25A	Rear Sunroof Motor
P/SEAT (REAR RH)	30A	2nd Seat Right Handle side Relax Module
P/WINDOW (RH)	25A	Passenger Power Window Switch, Passenger Safety Power Window Module, Rear Power Window Switch Right Handle side, Rear Safety Power Window Module Right Handle side
TAILGATE OPEN	15A	Tailgate Open Relay
P/SEAT (REAR LH)	30A	2nd Seat Left Handle side Relax Module
DOOR LOCK	20A	Door Lock Relay, Door Unlock Relay, FUEL FILLER OPENER
MULTIMEDIA1	25A	Audio, Audio/Video & Navigation Head Unit, Fuse - MULTIMEDIA2
S/HEAT (REAR RH)	20A	2nd Seat Warmer Control Module, 2nd Seat Right Handle side Air Ventilation Control Module
MEMORY	10A	Front/Rear Air Conditioner Control Module, Front Air Conditioner Control Panel, Instrument Cluster, Rear Seat Multimedia Monitor Left Handle side/Right Handle side, Driver/Passenger Power Outside Mirror, Driver IMS (Integrated memory system) Control Module, Power Tailgate Module, Rear Occupant Alert (ROA) Sensor #1/#2
START	10A	[W/O Smart Key] Ignition Switch
USB CHARGER	15A	Luggage USB Charger Left Handle side, Luggage USB Charger Unit, Driver Seat USB Jack, Passenger Seat USB Jack
MODULE3	7.5A	IBU (Integrated Body Control Unit), ADAS Unit, Lane Departure Warning (LDW) Camera, Crash Pad Switch, Electric Parking Brake Switch, Front Upper Console Switch, Auto Transmission Shift Lever Indicator, Rear Radar Left Handle side/Right Handle side
AIR BAG1	15A	SRS (Supplemental Restraint System) Control Module (IG1), Passenger Occupant Detection Sensor
WASHER	15A	Multifunction Switch (IG2)

Fuse Name	Fuse rating	Circuit Protected
MODULE1	10A	IBU (Integrated Body Control Unit), Audio, Audio/Video & Navigation Head Unit, Keyboard, ADAS Unit, Front Tray Power Outlet Left Handle side/Right Handle side, AMP (Amplifier) (BOSE), Rear Seat Multimedia Monitor Left Handle side/Right Handle side
MODULE9	10A	Data Link Connector, Hazard Switch, Crash Pad Switch, Auto Transmission Shift Lever, Crash Pad Switch (Lower), Driver Door Module, 2nd Seat Left Handle side/Right Handle side Relax Module, Driver/Passenger Door Outside Handle, Driver/Passenger Door Outside Handle Antenna
IBU1	7.5A	IBU (Integrated Body Control Unit) (IG1)
MODULE2	7.5A	Stop Lamp Switch
REAR A/C	10A	Rear Air Conditioner Control Module, E/R Junction Block (Blower RR Relay)
A/BAG IND.	7.5A	Instrument Cluster, AIR BAG(TELLTALE LAMP)
MODULE8	7.5A	AC Inverter Module, AC Inverter (Rear/Luggage), E/R Junction Block (W/S Heated Glass 1/2 Relay), Front Air Ventilation Seat Control Module, 2nd Seat Left Handle side/Right Handle side Air Ventilation Control Module, 2nd Seat Warmer Control Module, 2nd Seat Left Handle side/Right Handle side Relax Module
IBU2	15A	IBU (Integrated Body Control Unit) (B+)
E-SHIFTER	10A	[With SBW] Electronic Auto Transmission Shift Lever Switch
MODULE5	10A	Overhead Console Indicator
A/C	7.5A	Front Air Conditioner Control Module, Front Air Conditioner Control Panel
AIR BAG2	10A	SRS (Supplemental Restraint System) Control Module (B+)
CLUSTER	7.5A	Instrument Cluster (IG1)
MODULE4	10A	Data Link Connector, Audio, Audio/Video & Navigation Head Unit, Keyboard, Wireless Charger, Electro Chromic Mirror, Front/Rear Air Conditioner Control Module, Front Air Conditioner Control Panel, Rear Power Window Switch Left Handle side/Right Handle side, Right Handle side Overhead Console, Rear Safety Power Window Switch Left Handle side/Right Handle side, Driver IMS (Integrated memory system) Control Module, 2nd Seat Left Handle side/Right Handle side Relax Module, Front Seat Warmer Control Module, Front Air Ventilation Seat Control Module, 2nd Seat Warmer Control Module, 2nd Seat Left Handle side/Right Handle side Air Ventilation Control Module
MODULE7	7.5A	IBU (Integrated Body Control Unit) (IG2)
BRAKE SWITCH	7.5A	IBU (Integrated Body Control Unit), Stop Lamp Switch
MDPS	7.5A	MDPS Unit * MDPS (Motor Driven Power Steering) is the same as EPS (Electric Power Steering).
MULTIMEDIA2	10A	[W/O BOSE AMP] Audio/Video & Navigation Head Unit

Engine Room Junction Block

Fuse Name	Fuse rating	Circuit Protected
MULTI FUSE (TYPE A)		
COOLING FAN	80A	Cooling Fan Motor
W/S HEATED GLASS1	50A	W/S Heated Glass1 Relay
B+4	50A	ICU Junction Block (Fuse – SUNROOF1, AMP, P/WINDOW (RH), S/ HEATER (FRT), P/SEAT (REAR LH))
W/S HEATED GLASS2	50A	W/S Heated Glass2 Relay
B+5	50A	ICU Junction Block (Fuse – SUNROOF2, P/WINDOW (LH), S/HEATER (REAR LH), P/SEAT (DRV), P/SEAT (PASS), P/SEAT (REAR RH))
PSD2	40A	Power Sliding Door Module
ESC1	40A	ESC (Electronic Stability Control) Module
POWER TAILGATE	30A	Power Tailgate Module
MULTI FUSE (TYPE B)		
MDPS	100A	MDPS Unit * MDPS (Motor Driven Power Steering) is the same as EPS (Electric Power Steering).
B+6	60A	PCB Block (Engine Control Relay, Wiper On Relay, Fuse – IG1, IG2, HORN, B/ALARM HORN, ECU1, A/C2
ESC2	60A	ESC (Electronic Stability Control) Module
POWER OUTLET 1	40A	Power Outlet Relay
PSD1	40A	Power Sliding Door Module
E-SHIFTER1	30A	[With SBW] SCU (Shift by wire Control Unit)
FUSE		
REAR HEATED	40A	REAR HEATED Relay
BLOWER RR	40A	BLOWER RR Relay
B+3	50A	ICU Junction Block (IPS3/IPS4/IPS6/IPS7/IPS8)
BLOWER FRT	40A	BLOWER FRT Relay
B+2	50A	ICU Junction Block (IPS1/IPS2/IPS5/IPS9/IPS10)
B+1	40A	ICU Junction Block (Long Term Load Latch Relay, Fuse – AIR BAG2, START, MODULE9, TAILGATE OPEN, IBU2, BRAKE SWITCH, DOOR LOCK, S/HEATER (REAR RH))
INVERTER	40A	AC Inverter Module
TRAILER	30A	Trailer Connector
FUEL PUMP	20A	FUEL PUMP Relay
E-SHIFTER2	10A	[With SBW] SCU (Shift by wire Control Unit), Electronic Auto Transmission Shift Lever Switch
POWER OUTLET4	20A	Rear Power Outlet
POWER OUTLET3	20A	Front Power Outlet

Fuse Name	Fuse rating	Circuit Protected
TCU2	15A	TCM (Transmission Control Module)
DOOR LOCK RR LH	10A	PCB Block (Rear Door LH Lock/Unlock Relay)
AMS	10A	Battery Sensor
TCU1	15A	TCM (Transmission Control Module)
REAR A/C	10A	Rear Air Conditioner Control Module
W/S HEATED GLASS3	10A	Front Air Conditioner Control Module, Front Air Conditioner Control Panel
HEATED MIRROR	10A	Driver/Passenger Power Outside Mirror, Front Air Conditioner Control Module, Front Air Conditioner Control Panel
A/C1	10A	Front Air Conditioner Control Module

PCB Block

Fuse Name	Fuse rating	Circuit Protected
IG1	40A	IG1 Relay, ACC Relay
IG2	40A	IG2 Relay, E/R Junction Block (START1 Relay)
WIPER FRT2	7.5A	IBU (Integrated Body Control Unit), ECM (Engine Control Module)
SENSOR6	20A	ECM (Engine Control Module)
SENSOR1	20A	Ignition Coil #1/#2/#3/#4/#5/#6
SENSOR8	10A	Not Used
ECU2	10A	ECM (Engine Control Module)
SENSORS5	10A	E/R Junction Block (FUEL PUMP Relay)
MODULE	7.5A	Front Radar Unit
SENSOR9	20A	ECM (Engine Control Module)
SENSOR3	20A	ECM (Engine Control Module)
SENSOR2	15A	Oxygen Sensor #3
WIPER FRT1	30A	Front Wiper (Low) Relay, Front Wiper Motor
WIPER RR	15A	Rear Wiper Relay, Rear Wiper Motor
HORN	15A	Horn Relay
A/C2	10A	Air Conditioner Compressor Relay
B/ALARM HORN	15A	Burglar Alarm Horn Relay
E-SHIFTER3	7.5A	[With SBW] SCU (Shift by wire Control Unit)
TCU3	10A	TCM (Transmission Control Module)
SENSOR4	10A	Air Conditioner Compressor Relay, Cooling Fan Motor, Oxygen Sensor #1/#2/#4, Purge Control Solenoid Valve, Canister Closer Valve, Variable Oil Pump Solenoid, Variable Intake Solenoid Valve, Oil Control Valve #1/#2/#3/#4 (Intake/Exhaust)
SENSOR7	15A	Injector #1/#2/#3/#4/#5/#6 (MPI)

Fuse Name	Fuse rating	Circuit Protected
ECU1	15A	ECM (Engine Control Module)
ESC3	7.5A	ESC (Electronic Stability Control) Module
POWER OUTLET2	20A	Luggage Power Outlet

Relay

Relay No.	Relay Name	Type
E31	BLOWER FRT RELAY	MINI - 4P
E32	BLOWER RR RELAY	MINI - 4P
E33	START2 RELAY	MICRO - 5P
E34	FUEL PUMP RELAY	MICRO(H/C) - 4P
E35	START1 RELAY	MICRO(H/C) - 4P
E40	W/S HEATED GLASS1 RELAY	MICRO(H/C) - 4P
E41	W/S HEATED GLASS2 RELAY	MICRO(H/C) - 4P
E42	POWER OUTLET RELAY	MICRO(H/C) - 4P
E45	REAR HEATED RELAY	MICRO(H/C) - 4P

Engine compartment fuse panel (Battery terminal cover)

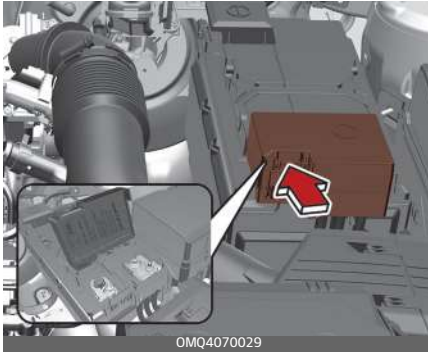

OMQ4070029



OKA4070082N

Light bulbs

Light bulbs are installed in various parts of the vehicle to provide lighting inside and outside the vehicle as well as to alert other vehicles.

Bulb replacement precaution

Please keep extra bulbs on hand with appropriate wattage ratings in case of emergencies.

Refer to "Bulb wattage" on page 8-4.

When changing lamps, first turn off the vehicle at a safe place, firmly apply the parking brake and detach the battery's negative (-) terminal.

⚠ WARNING

Working on the lights

Prior to working on the light, firmly apply the parking brake, ensure that turn the ignition switch or ENGINE START/STOP button and turn off the lights to avoid sudden movement of the vehicle and burning your fingers or receiving an electric shock.

Use only bulbs of the specified wattage.

⚠ CAUTION**Light replacement**

Be sure to replace the burned-out bulb with one of the same wattage rating. Otherwise, it may cause damage to the fuse or electric wiring system.

Fully install light bulbs and any parts used to secure them. Failure to do so may result in heat damage, fire, or water entering the headlamp unit. This may damage the headlamps or cause condensation to build up on the lens. To prevent damage or fire, make sure bulbs are fully seated and locked.

⚠ CAUTION**Headlamp lens**

To prevent damage, do not clean the headlamp lens with chemical solvents or strong detergents.

*** NOTICE**

- If the light bulb or lamp connector is removed while the lamp is still on, the fuse box's electronic system may log it as a malfunction. Therefore, a lamp malfunction incident may be recorded as a Diagnostic Trouble Code (DTC) in the fuse box.
- It is normal for an operating lamp to flicker momentarily. This is due

to a stabilization function of the vehicle's electronic control device. If the lamp lights up normally after momentarily blinking, then it is functioning as normal.

However, if the lamp continues to flicker several times or turns off completely, there may be an error in the vehicle's electronic control device. Please have the vehicle checked by an authorized Kia dealer immediately.

*** NOTICE**

Have the headlamp aiming adjusted by an authorized Kia dealer after an accident or after the headlamp assembly is reinstalled.

*** NOTICE**

You can find moisture inside the lens of lamps after a car wash or driving in the rain. It is a natural event caused by the temperature difference between the inside and the outside of the lamp and does not mean there is a problem with its functions. The moisture inside the lamp would disappear if you drive the vehicle with the headlamp turned on. However, the level at which the moisture is removed may differ depending on the size/location/condition of the lamp. If the moisture continues to stay inside

the lamp, have the vehicle checked by an authorized Kia dealer.

If you don't have the necessary tools, the correct bulbs and the expertise, consult an authorized Kia dealer. In many cases, it is difficult to replace vehicle light bulbs because other parts of the vehicle must be removed before you can get to the bulb. This is especially true if you have to remove the headlamp assembly to get to the bulb(s).

Removing/installing the headlamp assembly can result in damage to the vehicle. If non-genuine parts or substandard bulbs are used, it may lead to blowing a fuse or other wiring damages.

Do not install extra lamps or LEDs to the vehicle. If additional lights are installed, it may lead to lamp malfunctions and flickering. Additionally, the fuse box and other wiring may be damaged.

Light bulb position (Front)

Head lamp – Type A

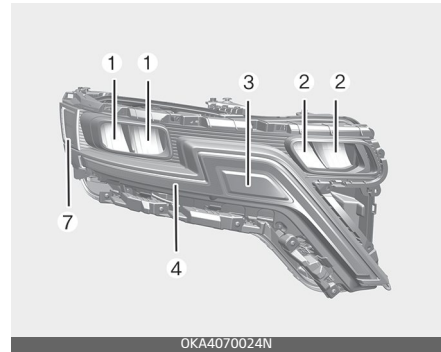

Head lamp – Type B

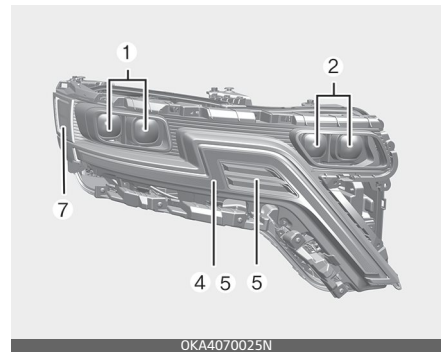

Fog lamp

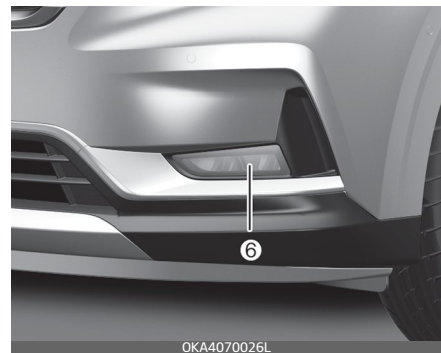

7

- 1. Headlamp (Low) (LED type)
- 2. Headlamp (High) (LED type)
- 3. Front turn signal lamp (Bulb type)
- 4. Day time running lamp (LED type)
- 5. Front turn signal lamp (LED type)
- 6. Front fog lamp (LED type)
- 7. Front side marker (LED type)

Light bulb position (Rear)

Rear combination lamp - Type A

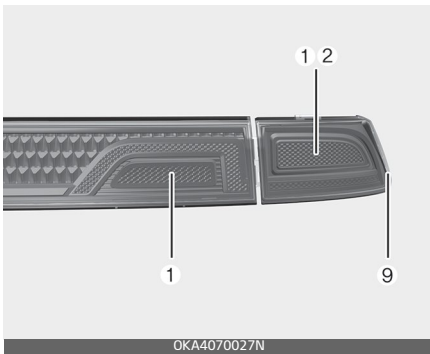

Rear combination lamp - Type B

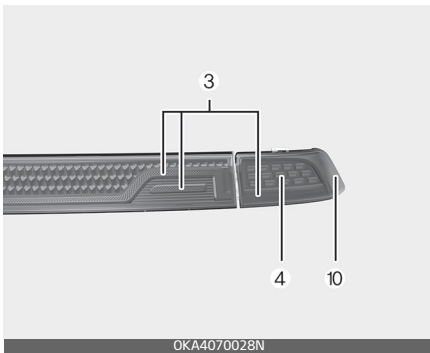

Reversing lamp / Turn signal lamp

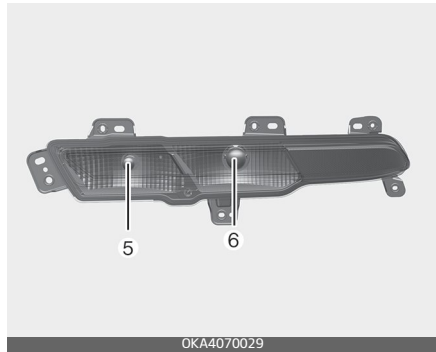

License plate lamp

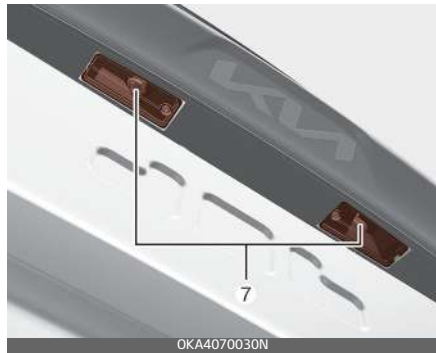

High mounted stop lamp



1. Tail lamp (Bulb type)
2. Stop lamp (Bulb type)
3. Tail lamp (LED type)
4. Stop lamp (LED type)
5. Reversing lamp (Bulb type)
6. Rear turn signal lamp (Bulb type)
7. License plate lamp (Bulb type)
8. High mounted stop lamp (LED type)
9. Rear side marker (Bulb type)
10. Rear side marker (LED type)

Light bulb position (Side)



1. Side repeater lamp (LED type)

Replacing headlamp (Low beam/ High beam), position lamp/daytime running lamp, turn signal lamp and front side marker (LED type)

Type A

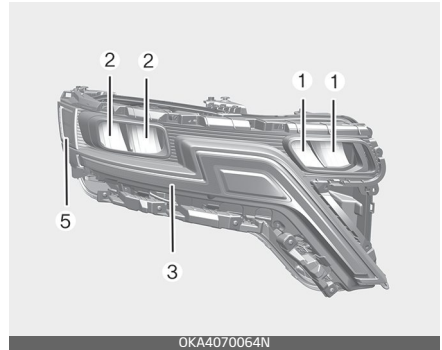

Type B

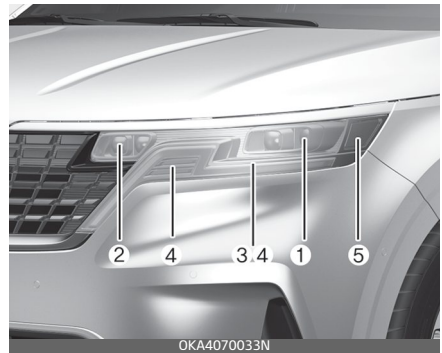

If the headlamp LED (1,2), daytime running lamp LED (3), turn signal lamp LED (4) and front side marker (5) does not operate, have your vehicle checked by a professional workshop. Contact and visit an authorized Kia dealer.

Replacing front turn signal lamp (Bulb type)

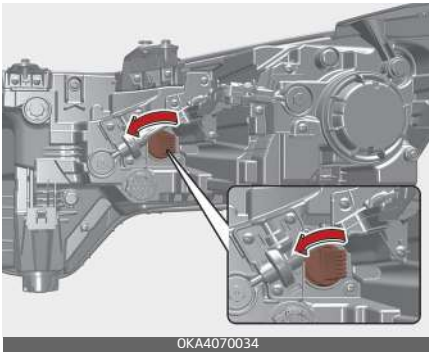

1. Turn off vehicle and disconnect the negative terminal from the battery.
2. Remove the socket from the assembly by turning the socket counterclockwise until the tabs on the socket align with the slots on the assembly.
3. Remove the bulb from the socket by pressing it in and rotating it counterclockwise until the tabs on the bulb align with the slots in the socket. Pull the bulb out of the socket.
4. Insert a new bulb by inserting it into the socket and rotating it until it locks into place.
5. Install the socket in the assembly by aligning the tabs on the socket with the slots in the assembly. Push the socket into the assembly and turn the socket clockwise.
6. Connect the negative terminal from the battery.

Replacing front fog lamp (LED type)

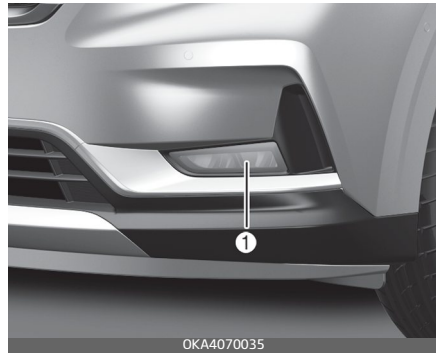

If the front fog lamp (1) does not operate, have your vehicle checked by a professional workshop. Contact and visit an authorized Kia dealer.

Replacing side repeater lamp (LED type)

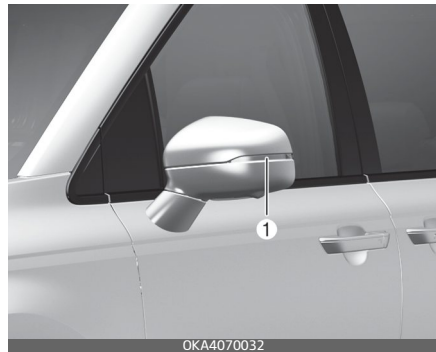

If the Side repeater lamp (LED) (1) does not operate, have your vehicle checked by a professional workshop. Contact and visit an authorized Kia dealer.

The LED lamp cannot be replaced as a single unit because it is an inte-

grated unit. The LED lamp has to be replaced with the unit.

A skilled technician should check or repair the Side repeater lamp (LED), for it may damage related parts of the vehicle.

Replacing side marker, stop and taillamp (Bulb type)

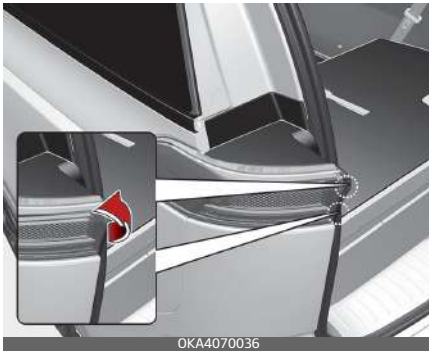

1. Turn off vehicle and disconnect the negative terminal from the battery.
2. Open the liftgate.
3. Open the service cover.
4. Loosen the light assembly retaining screws with a cross-tip screw driver.



5. Remove the rear combination lamp assembly from the body of the vehicle.
6. Disconnect the rear combination lamp connector.
7. Remove the socket from the assembly by turning the socket counterclockwise until the tabs on the socket align with the slots on the assembly.

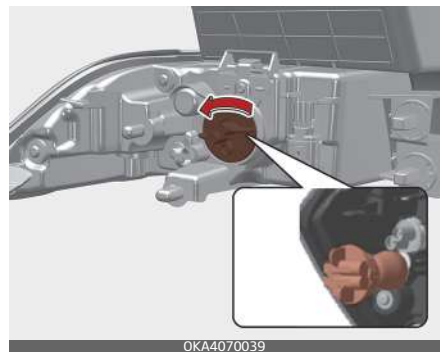

8. Remove the bulb from the socket by pressing it in and rotating it counterclockwise until the tabs on the bulb align with the slots in the socket.
Pull the bulb out of the socket.

9. Insert a new bulb by inserting it into the socket and rotating it until it locks into place.
10. Install the socket in the assembly by aligning the tabs on the socket with the slots in the assembly. Push the socket into the assembly and turn the socket clockwise.
11. Install the rear combination lamp assembly to the body of the vehicle.
12. Install the service cover.

Replacing rear turn signal lamp, reversing lamp (Bulb type)

1. Turn off vehicle and disconnect the negative terminal from the battery.
2. Remove the bumper.
3. Loosen the light assembly retaining screws with a cross-tip screw driver.
4. Disconnect the rear turn signal lamp/reversing lamp connector.
5. Remove the socket from the assembly by turning the socket counterclockwise until the tabs on the socket align with the slots on the assembly.

Rear turn signal lamp

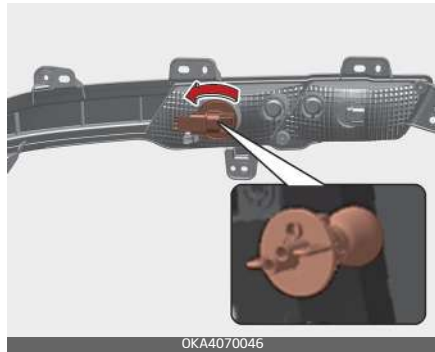

Reversing lamp

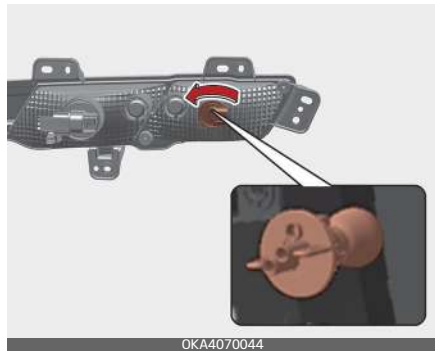

6. Insert a new bulb by inserting it into the socket and rotating it until it locks into place.
7. Install the light assembly in the reverse order of removal.

Replacing rear side marker, stop and tail lamp (LED type)



If the rear stop and tail lamp (1), and rear side marker (2) do not operate, have your vehicle checked by an authorized Kia dealer.

The LED lamp cannot be replaced as a single unit because it is an integrated unit. The LED lamp has to be replaced with the unit.

A skilled technician should check or repair the stop and tail lamp (LED), for it may damage related parts of the vehicle.

Replacing high mounted stop lamp (LED type)



If the high mounted stop lamp (LED) (1) does not operate, have your vehicle checked by an authorized Kia dealer.

The LED lamp cannot be replaced as a single unit because it is an integrated unit. The LED lamp has to be replaced with the unit.

A skilled technician should check or repair the high mounted stop lamp (LED), for it may damage related parts of the vehicle.

Replacing license plate lamp (Bulb type)

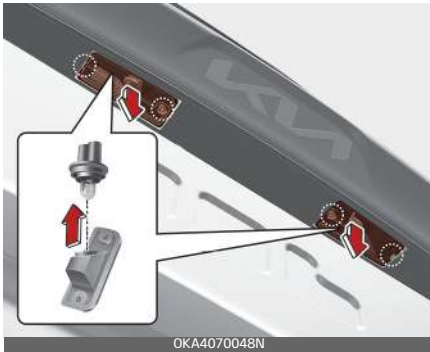

1. Turn off vehicle and disconnect the negative terminal from the battery.
2. Using a screwdriver, gently pry the lamp assembly.
3. Remove the bulb by pulling it straight out.
4. Install a new bulb in the socket.
5. Install the lamp assembly.

⚠ CAUTION

Be careful not to dirty or damage the lens, lens tab, and plastic housings.

Replacing map lamp (Bulb type)



⚠ WARNING

Interior lamps

Prior to working on the Interior lamps, ensure that the "OFF" button is depressed to avoid burning your fingers or receiving an electric shock.

1. Turn off vehicle and disconnect the negative terminal from the battery.
2. Using a flat-blade screwdriver, gently pry the lens cover from lamp housing.
3. Remove the bulb by pulling it straight out.
4. Install a new bulb in the socket.
5. Align the lens cover tabs with the lamp housing notches and snap the lens into place.

⚠ CAUTION

Be careful not to dirty or damage the lens, lens tab, and plastic housings.

Replacing map lamp (LED type)



If the map lamp (LED) (1) does not operate, have your vehicle checked by an authorized Kia dealer.

The LED lamp cannot be replaced as a single unit because it is an integrated unit. The LED lamp has to be replaced with the unit.

A skilled technician should check or repair the map lamp (LED), for it may damage related parts of the vehicle.

Replacing room lamp (Bulb type)

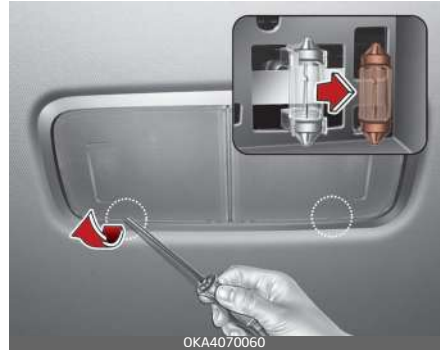

⚠ WARNING

Interior lamps

Prior to working on the Interior lamps, ensure that the "OFF" button is depressed to avoid burning your fingers or receiving an electric shock.

1. Turn off vehicle and disconnect the negative terminal from the battery.
2. Using a flat-blade screwdriver, gently pry the lens cover from lamp housing.
3. Remove the bulb by pulling it straight out.
4. Install a new bulb in the socket.
5. Align the lens cover tabs with the lamp housing notches and snap the lens into place.

⚠ CAUTION

Be careful not to dirty or damage the lens, lens tab, and plastic housings.

Replacing room lamp (LED type)



If the Side repeater lamp (LED) (1) does not operate, have your vehicle checked by an authorized Kia dealer.

The LED lamp cannot be replaced as a single unit because it is an integrated unit. The LED lamp has to be replaced with the unit.

A skilled technician should check or repair the room lamp (LED), for it may damage related parts of the vehicle.

Replacing personal lamp (LED type) (if equipped)

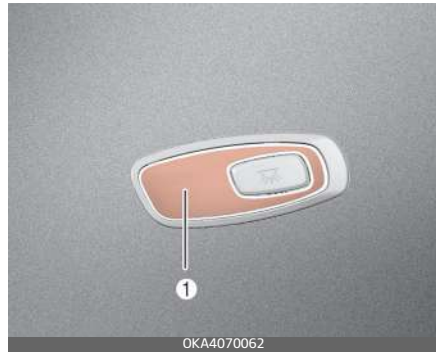

If the personal lamp (LED) (1) does not operate, have your vehicle checked by an authorized Kia dealer.

The LED lamp cannot be replaced as a single unit because it is an integrated unit. The LED lamp has to be replaced with the unit.

A skilled technician should check or repair the personal lamp (LED), for it may damage related parts of the vehicle.

Replacing vanity mirror lamp (Bulb type)



⚠ WARNING

Interior lamps

Prior to working on the Interior lamps, ensure that the "OFF" button is depressed to avoid burning your fingers or receiving an electric shock.

1. Turn off vehicle and disconnect the negative terminal from the battery.
2. Using a flat-blade screwdriver, gently pry the lamp assembly from interior.
3. Remove the bulb by pulling it straight out.
4. Install a new bulb in the socket.
5. Install the lamp assembly to interior.

⚠ CAUTION

Be careful not to dirty or damage the lens, lens tab, and plastic housings.

Replacing glove box lamp (Bulb type)



⚠ WARNING

Interior lamps

Prior to working on the Interior lamps, ensure that the "OFF" button is depressed to avoid burning your fingers or receiving an electric shock.

1. Turn off vehicle and disconnect the negative terminal from the battery.
2. Using a flat-blade screwdriver, gently pry the lamp assembly from interior.
3. Remove the cover from the lamp assembly.
4. Remove the bulb by pulling it straight out.
5. Install a new bulb in the socket.
6. Install the cover to the lamp assembly.
7. Install the lamp assembly to interior.

⚠ CAUTION

Be careful not to dirty or damage the lens, lens tab, and plastic housings.

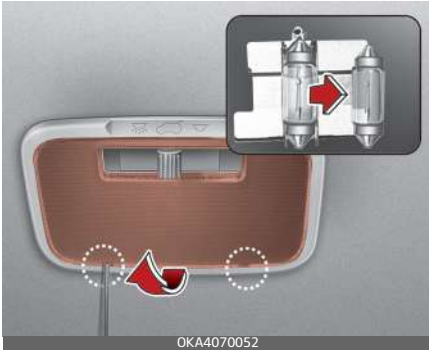
Replacing luggage lamp (Bulb type)**⚠ WARNING****Interior lamps**

Prior to working on the Interior lamps, ensure that the "OFF" button is depressed to avoid burning your fingers or receiving an electric shock.

1. Turn off vehicle and disconnect the negative terminal from the battery.
2. Using a flat-blade screwdriver, gently pry the lamp assembly from interior.
3. Remove the cover from the lamp assembly.
4. Remove the bulb by pulling it straight out.
5. Install a new bulb in the socket.

6. Install the cover to the lamp assembly.
7. Install the lamp assembly to interior.

⚠ CAUTION

Be careful not to dirty or damage the lens, lens tab, and plastic housings.

Replacing luggage lamp (LED type)

If the luggage lamp (LED) does not operate, have your vehicle checked by an authorized Kia dealer.

The LED lamp cannot be replaced as a single unit because it is an integrated unit. The LED lamp has to be replaced with the unit.

A skilled technician should check or repair the luggage lamp (LED), for it may damage related parts of the vehicle.

Appearance care

Use the information in the following sections to keep the exterior and interior of your vehicle clean.

Exterior care

Use the information in the following sections to maintain the exterior of your vehicle. Keeping the exterior clean is not only aesthetically pleasing, but it also helps to prolong the life of the vehicle.

* NOTICE

If you park the vehicle around a stainless signboard or windshield building etc., the plastic exterior trim (bumper, spoiler, garnish, lamp, outside mirror etc.) may be damaged by reflected sunlight from the external structure. To avoid damaging the plastic exterior trim, park the vehicle away from the areas where the reflected light may occur or use a vehicle cover. (Depending on the vehicle, the type of exterior trim applied such as spoiler may differ.)

Exterior general caution

It is very important to follow the label directions when using any chemical cleaner or polish. Read all warning and caution statements that appear on the label.

Finish maintenance

Washing

To help protect your vehicle's finish from rust and deterioration, wash it thoroughly and frequently at least once a month with lukewarm or cold water.

If you use your vehicle for off-road driving, you should wash it after each off-road trip. Pay special attention to the removal of any accumulation of salt, dirt, mud, and other foreign materials. Make sure the drain holes in the lower edges of the doors and rocker panels are kept clear and clean.

Insects, tar, tree sap, bird droppings, industrial pollution and similar deposits can damage your vehicle's finish if not removed immediately. Even prompt washing with plain water may not completely remove all these deposits. A mild soap, safe for use on painted surfaces, may be used.

After washing, rinse the vehicle thoroughly with lukewarm or cold water. Do not allow soap to dry on the finish.

After washing the vehicle, test the brakes while driving slowly to see if they have been affected by water. If braking performance is impaired, dry the brakes by applying them lightly while maintaining a slow forward speed.

⚠ CAUTION

- Do not use strong soap, chemical detergents or hot water, and do not wash the vehicle in direct sunlight or when the body of the vehicle is warm.
- Be careful when washing the side windows of your vehicle, especially with high-pressure water. Water may leak through the windows and wet the interior.
- To prevent damage to the plastic parts and lamps, do not clean with chemical solvents or strong detergents.

⚠ WARNING

After washing the vehicle, test the brakes while driving slowly to see if they have been affected by water. If braking performance is impaired, dry the brakes by applying them lightly while maintaining a slow forward speed.

High-pressure washing

When using high-pressure washers, make sure to maintain sufficient distance from the vehicle. Insufficient clearance or excessive pressure can lead to component damage or water penetration. Do not spray the camera, sensors or its surrounding area directly with a high pressure washer. Shock applied from high pressure water may

cause the device to not operate normally.

Do not bring the nozzle tip close to boots (rubber or plastic covers) or connectors as they may be damaged if they come into contact with high pressure water.

⚠ WARNING

After washing the vehicle, test the brakes while driving slowly to see if they have been affected by water. If braking performance is impaired, dry the brakes by applying them lightly while maintaining a slow forward speed.

⚠ CAUTION**Wetting engine compartment**

- Water washing in the engine compartment including high pressure water washing may cause the failure of electrical circuits located in the engine compartment.
- Never allow water or other liquids to come in contact with electrical/

electronic components and air duct inside the vehicle as this may damage them.

- After the vehicle has been washed, brake carefully while paying attention to the traffic conditions until the braking effect has been fully restored.

Waxing

Wax the vehicle when water will no longer bead on the paint.

Always wash and dry the vehicle before waxing. Use a good quality liquid or paste wax, and follow the manufacturer's instructions. Wax all metal trim to protect it and to maintain its luster.

Removing oil, tar, and similar materials with a spot remover will usually strip the wax from the finish. Be sure to re-wax these areas even if the rest of the vehicle does not yet need waxing.

Be careful not to touch the lens when waxing the lamps.

⚠ CAUTION

Drying vehicle

- Wiping dust or dirt off the body with a dry cloth will scratch the finish.
- Do not use steel wool, abrasive cleaners, acid detergents or strong detergents containing high alkaline or caustic agents on chrome-plated or anodized aluminum parts. This may result in

damage to the protective coating and cause discoloration or paint deterioration.

Finish damage repair

Deep scratches or stone chips in the painted surface must be repaired promptly. Exposed metal will quickly rust and may develop into a major repair expense.

* NOTICE

If your vehicle is damaged and requires any metal repair or replacement, be sure the body shop applies anti-corrosion materials to the parts repaired or replaced.

Bright-metal maintenance

To remove road tar and insects, use a tar remover, not a scraper or other sharp object.

To protect the surfaces of bright metal parts from corrosion, apply a coating of wax or chrome preservative and rub to a high luster.

During winter weather or in coastal areas, cover the bright metal parts with a heavier coating of wax or preservative. If necessary, coat the parts with non-corrosive petroleum jelly or other protective compound.

Underbody maintenance

Road salt and other corrosive chemicals are used in cold weather states to melt snow and prevent ice accumulation. If these chemicals are not regularly removed, they will corrode the vehicle underbody and, over time, damage many parts: the fuel lines, the fuel tank retention system, the vehicle's suspension, the exhaust system, and even the body frame.

Aluminum wheel maintenance

The aluminum wheels are coated with a clear protective finish.

- Do not use any abrasive cleaner, polishing compound, solvent, or wire brushes on aluminum wheels. They may scratch or damage the finish.
- Clean the wheel when it has cooled.
- Use only a mild soap or neutral detergent, and rinse thoroughly with water. Also, be sure to clean the wheels after driving on salted roads. This helps prevent corrosion.
- Avoid washing the wheels with high speed vehicle wash brushes.
- Do not use any alkaline or acid detergents. It may damage and corrode the aluminum wheels coated with a clear protective finish.

Corrosion protection

Protecting your vehicle from corrosion

By using the most advanced design and construction practices to combat corrosion, we produce vehicles of the highest quality. However, this is only part of the job. To achieve the long-term corrosion resistance your vehicle can deliver, the owner's cooperation and assistance is also required.

Common causes of corrosion

The most common causes of corrosion on your vehicle are:

- Road salt, dirt and moisture that is allowed to accumulate underneath the vehicle.
- Removal of paint or protective coatings by stones, gravel, abrasion or minor scrapes and dents which leave unprotected metal exposed to corrosion.

High-corrosion areas

If you live in an area where your vehicle is regularly exposed to corrosive materials, corrosion protection is particularly important. Some of the common causes of accelerated corrosion are road salts, dust control chemicals, ocean air and industrial pollution.

Moisture breeds corrosion

Moisture creates the conditions in which corrosion is most likely to occur. For example, corrosion is

accelerated by high humidity, particularly when temperatures are just above freezing. In such conditions, the corrosive material is kept in contact with the vehicle's surface by moisture that evaporates slowly. Mud is particularly corrosive because it dries slowly and holds moisture in contact with the vehicle. Although the mud appears to be dry, it can still retain the moisture and promote corrosion. High temperatures can also accelerate corrosion of parts that are not properly ventilated so the moisture can be dispersed. For all these reasons, it is particularly important to keep your vehicle clean and free of mud or accumulations of other materials. This applies not only to the visible surfaces but particularly to the underside of the vehicle.

To help prevent corrosion

You can help prevent corrosion from beginning by observing the following:

Keep your vehicle clean

The best way to prevent corrosion is to keep your vehicle clean and free of corrosive materials. Attention to the underside of the vehicle is particularly important.

If you live in a high-corrosion area where road salts are used, near the ocean, areas with industrial pollution, acid rain, etc.—, you should take extra care to prevent corrosion.

In winter, hose off the underside of your vehicle at least once a month and be sure to clean the underside thoroughly when winter is over.

When cleaning underneath the vehicle, give particular attention to the components under the fenders and other areas that are hidden from view. Do a thorough job; just dampening the accumulated mud rather than washing it away will accelerate corrosion rather than prevent it. Water under high pressure and steam are particularly effective in removing accumulated mud and corrosive materials.

When cleaning lower door panels, rocker panels and frame members, be sure that drain holes are kept open so that moisture can escape and not be trapped inside to accelerate corrosion.

Keep your garage dry

Don't park your vehicle in a damp, poorly ventilated garage. This creates a favorable environment for corrosion. This is particularly true if you wash your vehicle in the garage or drive it into the garage when it is still wet or covered with snow, ice or mud. Even a heated garage can contribute to corrosion unless it is well ventilated so moisture is dispersed.

Keep paint and trim in good condition

Scratches or chips in the finish should be covered with "touch-up" paint as soon as possible to reduce the possibility of corrosion. If bare metal is showing through, the attention of a qualified body and paint shop is recommended.

Bird droppings: Bird droppings are highly corrosive and may damage painted surfaces in just a few hours. Always remove bird droppings as soon as possible.

Don't neglect the interior

Moisture can collect under the floor mats and carpeting and cause corrosion. Check under the mats periodically to be sure the carpeting is dry. Use particular care if you carry fertilizers, cleaning materials or chemicals in the vehicle.

These should be carried only in proper containers and any spills or leaks should be cleaned up, flushed with clean water and thoroughly dried.

Interior care

Use the information in the following sections to maintain the interior of your vehicle.

Interior general precautions

Prevent chemicals such as perfume, cosmetic oil, sun cream, hand cleaner, and air freshener from contacting the interior parts because they may cause damage or discoloration. If they do contact the interior parts, wipe them off immediately. If necessary, use a vinyl cleaner, see product instructions for correct usage.

⚠ CAUTION

Electrical components

Never allow water or other liquids to come in contact with electrical/electronic components inside the vehicle as this may damage them.

⚠ CAUTION

Leather

When cleaning leather products (steering wheel, seats etc.), use neutral detergents or low alcohol content solutions. If you use high alcohol content solutions or acid/alkaline detergents, the color of the leather may fade or the surface may get stripped off.

Taking care of leather seats

- Vacuum the seat periodically to remove dust and sand on the seat. It will prevent abrasion or

- damage of the leather and maintain its quality.
- Wipe the leather seat cover often with dry or soft cloth.
- Sufficient use of a leather protective may prevent abrasion of the cover and helps maintain the color. Be sure to read the instructions and consult a specialist when using leather coating or protective agents.
- Leather with bright colors (beige, cream beige) is easily contaminated and clear in appearance. Clean the seats frequently.
- Avoid wiping with wet cloth. It may cause the surface to crack.

Cleaning the leather seats

Remove all contaminations instantly. Refer to instructions below for removal of each contaminant.

- Cosmetic products (sunscreen, foundation, etc.)
 - Apply cleansing cream on a cloth and wipe the contaminated point. Wipe off the cream with a wet cloth and remove water with a dry cloth.
- Beverages (coffee, soft drink, etc.)
 - Apply a small amount of neutral detergent and wipe until contaminations do not smear.
- Oil, blue jeans/clothes (Color transfer)

- Remove oil/stain instantly with absorbable cloth and wipe with stain remover for leather only.
- Chewing gum
 - Harden the gum with ice and remove gradually.

Fabric seat cover (if equipped)

Please clean the fabric seats regularly with a vacuum cleaner in consideration of fabric material characteristics. If they are heavily soiled with beverage stains, etc., use a suitable interior cleaner. To prevent damage to seat covers, wipe off the seat covers down to the seams with a large wiping motion and moderate pressure using a soft sponge or microfiber cloth.

Velcro closures on clothing or sharp objects may cause snagging or scratches on the surface of the seats.

Make sure not to rub such objects against the surface.

Cleaning the upholstery and interior trim

Vinyl

Remove dust and loose dirt from vinyl with a whisk broom or vacuum cleaner. Clean vinyl surfaces with a vinyl cleaner.

Fabric

Remove dust and loose dirt from fabric with a whisk broom or vacuum cleaner. Clean with a mild soap solution recommended for upholstery or carpets. Remove fresh spots immediately with a fabric spot cleaner. If fresh spots do not receive immediate attention, the fabric can be stained and its color can be affected. Also, its fire-resistant properties can be reduced if the material is not properly maintained. Using anything but recommended cleaners and procedures may affect the fabric's appearance and fire-resistant properties.

Cleaning the lap/shoulder belt webbing

Clean the belt webbing with any mild soap solution recommended for cleaning upholstery or carpet. Follow the instructions provided with the soap. Do not bleach or re-dye the webbing because this may weaken it.

Cleaning the interior window glass

If the interior glass surfaces of the vehicle become fogged (that is, covered with an oily, greasy or waxy film), they should be cleaned with a glass cleaner. Follow the directions on the glass cleaner container.

 **CAUTION****Rear window**

Do not scrape or scratch the inside of the rear window. This may result in damage of the rear window defroster grid.

Emission control system

The emission control system of your vehicle is covered by a written limited warranty. Please see the warranty information contained in the Warranty & Consumer Information manual in your vehicle.

Your vehicle is equipped with an emission control system to meet all applicable emission regulations. There are three emission control systems, as follows.

1. Crankcase emission control system
2. Evaporative emission control system
3. Exhaust emission control system

In order to assure the proper function of the emission control systems, it is recommended that you have your vehicle inspected and maintained by an authorized Kia dealer in accordance with the maintenance schedule in this manual.

Caution for the Inspection and Maintenance Test (With Electronic Stability Control (ESC) system)

- **To prevent the vehicle from mis-firing during dynamometer testing, turn the ESC off by pressing the ESC switch.**
- **After dynamometer testing is completed, turn the ESC back on by pressing the ESC switch again.**

1. Crankcase emission control system

The Positive Crankcase Ventilation system is employed to prevent air pollution caused by blow-by gases being emitted from the crankcase. This system supplies fresh filtered air to the crankcase through the air intake hose. Inside the crankcase, the fresh air mixes with blow-by gases, which then pass through the Positive Crankcase Ventilation (PCV) valve into the induction system.

2. Evaporative emission control (including Onboard Refueling Vapor Recovery (ORVR)) system

The evaporative emission control system is designed to prevent fuel vapors from escaping into the atmosphere. (The ORVR system is designed to allow the vapors from the fuel tank to be loaded into a canister while refueling at the gas station, preventing the escape of fuel vapors into the atmosphere.)

Canister

Fuel vapors generated inside the fuel tank are absorbed and stored in the onboard canister. When the engine is running, the fuel vapors absorbed in the canister are drawn into the surge tank through the Purge Control Solenoid Valve.

Purge Control Solenoid Valve (PCSV)

The Purge Control Solenoid Valve (PCSV) is controlled by the Engine Control Module (ECM); when the engine coolant temperature is low during idling, the PCSV closes so that evaporated fuel is not taken into the engine. After the engine warms up during ordinary driving, the PCSV opens to introduce evaporated fuel to the engine.

3. Exhaust emission control system

The exhaust emission control system is a highly effective system which controls exhaust emissions while maintaining good vehicle performance.

Vehicle modifications

This vehicle should not be modified. Modification of your vehicle could affect its performance, safety or durability and may even violate governmental safety and emissions regulations. In addition, damage or performance problems resulting from any modification may not be covered under warranty.

- If you use authorized electronic devices, it may cause the vehicle to operate abnormally, wire damage, battery discharge and fire. For your safety, do not use unauthorized electronic devices.

Engine exhaust gas precautions (carbon monoxide)

- Carbon monoxide can be present with other exhaust fumes. Therefore, if you smell exhaust fumes of any kind inside your vehicle, have it inspected and repaired immediately. If you ever suspect exhaust fumes are coming into your vehicle, drive it only with all the windows fully open. Have your vehicle checked and repaired immediately.

WARNING

Exhaust

Engine exhaust gases contain carbon monoxide (CO). Though colorless and odorless, it is dangerous and could be lethal if inhaled. Follow the instructions on this page to avoid CO poisoning.

- Do not operate the engine in confined or closed areas (such as garages) any more than what is necessary to move the vehicle in or out of the area.
- When the vehicle is stopped in an open area for more than a short time with the engine running, adjust the ventilation system (as needed) to draw outside air into the vehicle.
- Never sit in a parked or stopped vehicle for any extended time with the engine running.

- When the engine stalls or fails to start, excessive attempts to restart the engine may cause damage to the emission control system.

Operating precautions for catalytic converters

WARNING

Catalytic converter

Keep away from the catalytic converter and exhaust system while the vehicle is running or immediately thereafter. The exhaust and catalytic systems are very hot and may burn you.

WARNING

Fire

- Do not park, idle or drive the vehicle over or near flammable objects, such as grass, vegetation, paper, leaves, etc. A hot exhaust system can ignite flammable items under your vehicle.
- Also, do not remove the heat sink around the exhaust system, do not seal the bottom of the vehicle or do not coat the vehicle for corrosion control. It may present a fire risk under certain conditions.

Your vehicle is equipped with a catalytic converter emission control device.

Therefore, the following precautions must be observed:

- Use only UNLEADED FUEL for gasoline engines.
 - Do not operate the vehicle when there are signs of engine malfunction, such as misfire or a noticeable loss of performance.
 - Do not misuse or abuse the engine. Examples of misuse are coasting with the ignition off and descending steep grades in gear with the ignition off.
 - Do not operate the engine at high idle speed for extended periods (5 minutes or more).
 - Do not modify or tamper with any part of the engine or emission control system. All inspections and adjustments must be made by an authorized Kia dealer.
 - Avoid driving with an extremely low fuel level. Running out of fuel could cause the engine to misfire, damaging the catalytic converter.
- Failure to observe these precautions could result in damage to the catalytic converter and to your vehicle. Additionally, such actions could void your warranties.

Specifications & Consumer information

Dimensions	8-2
Engine	8-2
Gross vehicle weight	8-3
Luggage volume	8-3
Air conditioning system	8-3
Bulb wattage	8-4
Tires and wheels	8-5
Recommended lubricants and capacities	8-6
• Recommended SAE viscosity number	8-7
Vehicle Identification Number (VIN)	8-8
Vehicle certification label	8-9
Tire specification and pressure label	8-9
Engine number	8-10
Air conditioner compressor label	8-10
Reporting safety defects	8-11

Specifications & Consumer information

Dimensions

Item			7, 8 seats mm (in)
Overall length			5,155 (203)
Overall width (without side mirrors)			1,995 (78.5)
Overall width (with side mirrors)			2,265 (89.2)
Overall height	Without Roof rack		1,740 (68.5)
	With Roof rack		1,775 (69.9)
Tread	Front	235/65 R17	1,751 (68.9)
		235/55 R19	1,741 (68.5)
	Rear	235/65 R17	1,751 (68.9)
		235/55 R19	1,741 (68.5)
Wheelbase			3,090 (121.6)

Engine

Item	Smartstream G3.5 GDi
Displacement [cc (cu in)]	3,470 (211.7)
Bore x Stroke [mm (in)]	92.0 x 87.0 (3.6 x 3.4)
Firing order	1-2-3-4-5-6
No. of cylinders	6 (V Engine)

Gross vehicle weight

Item	7 seats	7 seats (with VIP Lounge Seat)	8 seats
Gross vehicle weight [kg (lbs.)]	2,590 (5,710)	2,740 (6,041)	2,740 (6,041)

Luggage volume

Item	7, 8 seats	
Luggage volume (SAE) [L (cu ft)]	MIN.	1,139 (40.2)
	MAX.	4,110 (145.1)

- Min (V213): Behind 3rd seat (seatback upright 23 degrees, cushion backwards) to upper edge of the seat back.
- Max (V214): Behind 1st seat (vertical plane tangent to seat back rear) to roof.

Air conditioning system

Item	Weight of volume (g)	Classification
Refrigerant	770 ± 25	R-1234yf
Compressor lubricant	180 ± 10	PAG 30

Please contact a professional workshop for more details.

Contact an authorized Kia dealer.

Bulb wattage

Light bulb		Bulb type	Wattage (Watt)	
Front	Type A *	High beam	LED	
		Low beam	LED	
		Position and daytime running lamps	LED	
		Turn signal lamps	PY21W LL	21
	Type B *	High beam	LED	
		Low beam	LED	
		Position and daytime running lamps	LED	
		Turn signal lamps	LED	
	Front fog lamps *		LED	LED
	Front side marker lamps		LED	LED
Rear	Type A *	Stop and tail lamps	P21/5W LL	21/5
		Rear side marker lamps (Bulb Type)	W5W LL	5
	Type B *	Stop and tail lamps	LED	LED
		Rear side marker lamps (LED Type)	LED	LED
	Turn signal lamps		PY21W LL	21
	Back up lamps		W16W	16
	High mounted stop lamps		LED	LED
	License plate lamps		W5W LL	5
Interior	Map lamps (Bulb Type)*		BULB	6
	Map lamps (LED Type)*		LED	LED
	Room lamps *		BULB	10
	Personal lamps *		LED	LED
	Glove box lamp *		W5W	5
	Vanity mirror lamps *		BULB	5
	Luggage lamp (Bulb Type)*		BULB	10
	Luggage lamp (LED Type)*		LED	LED

* : if equipped

Tires and wheels

Item	Tire size	Wheel size	Load capacity		Speed capacity		Inflation pressure [kPa (psi, bar)]				Wheel lug nut torque kgf·m (lbf·ft, N·m)
			L ¹	kg	SS ²	km/h	Normal load		Maximum load		
							Front	Rear	Front	Rear	
Full size tire	235/65R17	6.5JX17"	104	900	H	210	255 (37, 2.55)	255 (37, 2.55)	255 (37, 2.55)	255 (37, 2.55)	11 ~ 13 (79 ~ 94, 107 ~ 127)
	235/55R19	7.5JX19"	101	825	H	210	250 (36, 2.5)	250 (36, 2.5)	250 (36, 2.5)	250 (36, 2.5)	
Compact spare tire (steel wheel) ^{*3}	T135/90D17	4B X 17"	104	900	M	130	420 (60, 4.2)	420 (60, 4.2)	420 (60, 4.2)	420 (60, 4.2)	
Compact spare tire (alloy wheel)	Compact spare tire's size is based on the full size tire equipped on your vehicle.										

*1. Load Index

*2. Speed Symbol

*3. If equipped

⚠ CAUTION

When replacing tires, use the same size originally supplied with the vehicle.

Using tires of a different size can damage the related parts or make it work irregularly.

* NOTICE



- We recommend that when replacing tires, use the same originally supplied with the vehicles. If not, that affects driving performance.
- When driving in high altitude grades, it is natural for the atmospheric pressure to decrease. Therefore, please check the tire pressure and add more air when necessary. Additionally required tire air pressure per km above sea level: 1.5 psi/km

Recommended lubricants and capacities

To help achieve proper engine and powertrain performance and durability, use only lubricants of the proper quality.

The correct lubricants also help promote engine efficiency that results in improved fuel economy.

These lubricants and fluids are recommended for use in your vehicle.

Lubricant	Volume	Classification
Engine oil (drain and refill) Recommends  	6.1 L	Full synthetic SAE 0W-20, API SN PLUS/SP or ILSAC GF-6
Automatic transmission fluid* ¹	7.0 L	ATF SP4(MI)
Coolant* ²	8.6 L	Mixture of antifreeze and distilled water (Ethylene glycol base coolant for aluminum radiator)
Brake fluid	As required (Reservoir tank volume: 685 ± 20.0 cc)	DOT 4
Fuel	72 L	Gasoline

* 1. Use only specified genuine automatic transmission fluid. The use of non-specified (even marked as compatible with genuine) could result in shift quality deterioration and vibrations, eventually, the transmission failure. (Refer to "Explanation of scheduled maintenance items" on page 7-15.)

* 2. Different type of coolant or water may damage the electrical component.

Recommended SAE viscosity number

Temperature Range for SAE Viscosity Numbers										
Temperature	°C	-30	-20	-10	0	10	20	30	40	50
	°F	-10	0	20	40	60	80	100	120	
Gasoline Engine Oil	Smartstream G3.5 GDi	0W-20								



An engine oil displaying this API Certification Mark conforms to the international Lubricant Specification Advisory Committee (ILSAC). It is recommended to only use engine oils that uphold this API Certification Mark.

⚠ CAUTION

Always be sure to clean the area around any filler plug, drain plug, or dipstick before checking or draining any lubricant. This is especially important in dusty or sandy areas and when the vehicle is used on unpaved roads. Cleaning the plug and dipstick areas will prevent dirt and grit from entering the engine and other mechanisms that could be damaged.

Engine oil viscosity (thickness) has an effect on fuel economy and cold weather operating (engine start and engine oil flowability). Lower viscosity engine oils can provide better fuel economy and cold weather performance, however, higher viscosity engine oils are required for satisfactory lubrication in hot weather.

Using oils of any viscosity other than those recommended could result in engine damage.

When choosing an oil, consider the range of temperature your vehicle will be operated in before the next oil change. Proceed to select the recommended oil viscosity from the chart.

Vehicle Identification Number (VIN)

The Vehicle Identification Number (VIN) is the number used in registering your vehicle and in all legal matters pertaining to its ownership, etc.

VIN cover (if equipped)



The number is punched on the floor under the front right side seat. To check the number, open the cover.

The VIN is also on a plate attached to the top of the dashboard. The number on the plate can easily be seen through the windshield from outside.

VIN label (if equipped)



Vehicle certification label

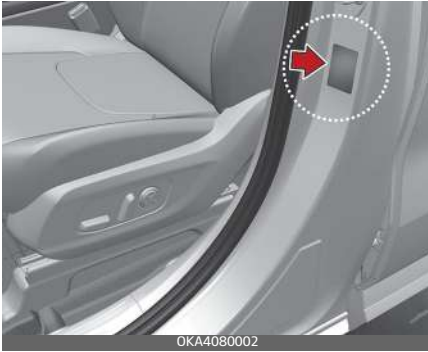

The vehicle certification label attached on the driver's (or front passenger's) side center pillar gives the vehicle identification number (VIN).

Tire specification and pressure label

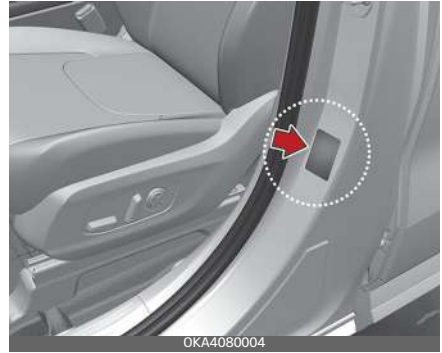

The tires supplied on your new vehicle are chosen to provide the best performance for normal driving.

The tire label located on the driver's side center pillar gives the tire pressures recommended for your vehicle.

Engine number

The engine number is stamped on the engine block as shown in the drawing.

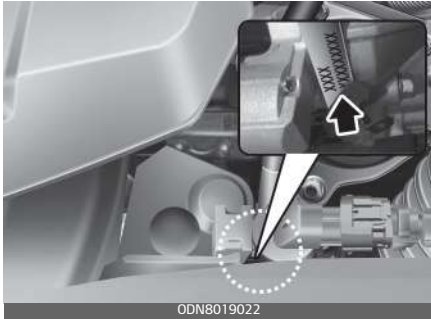

Air conditioner compressor label

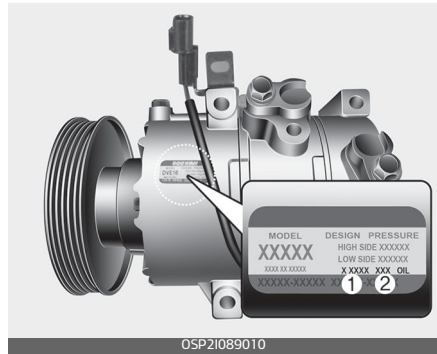

A compressor label informs you the type of compressor your vehicle is equipped with such as model, supplier part number, production number, refrigerant (1) and refrigerant oil (2).

Reporting safety defects

If you believe that your vehicle has a defect which could cause a crash or could cause injury or death, you should immediately inform Transport Canada (TC) in addition to notifying **Kia Canada Inc.**

Mailing Address:
Transport Canada – ASFAD
330 Sparks Street
Ottawa, ON
K1A 0N5

Telephone: 819-994-3328 (Ottawa-Gatineau area or internationally)
Toll free: 1-800-333-0510 (in Canada)

Online:
<http://www.tc.gc.ca/recalls>

If TC receives similar complaints, it may open an investigation, and if it finds that a safety defect exists in a group of vehicles, it may order a recall and remedy campaign. However, TC cannot become involved in individual problems between you, your dealer, or **Kia Canada Inc.**

Abbreviation **A**

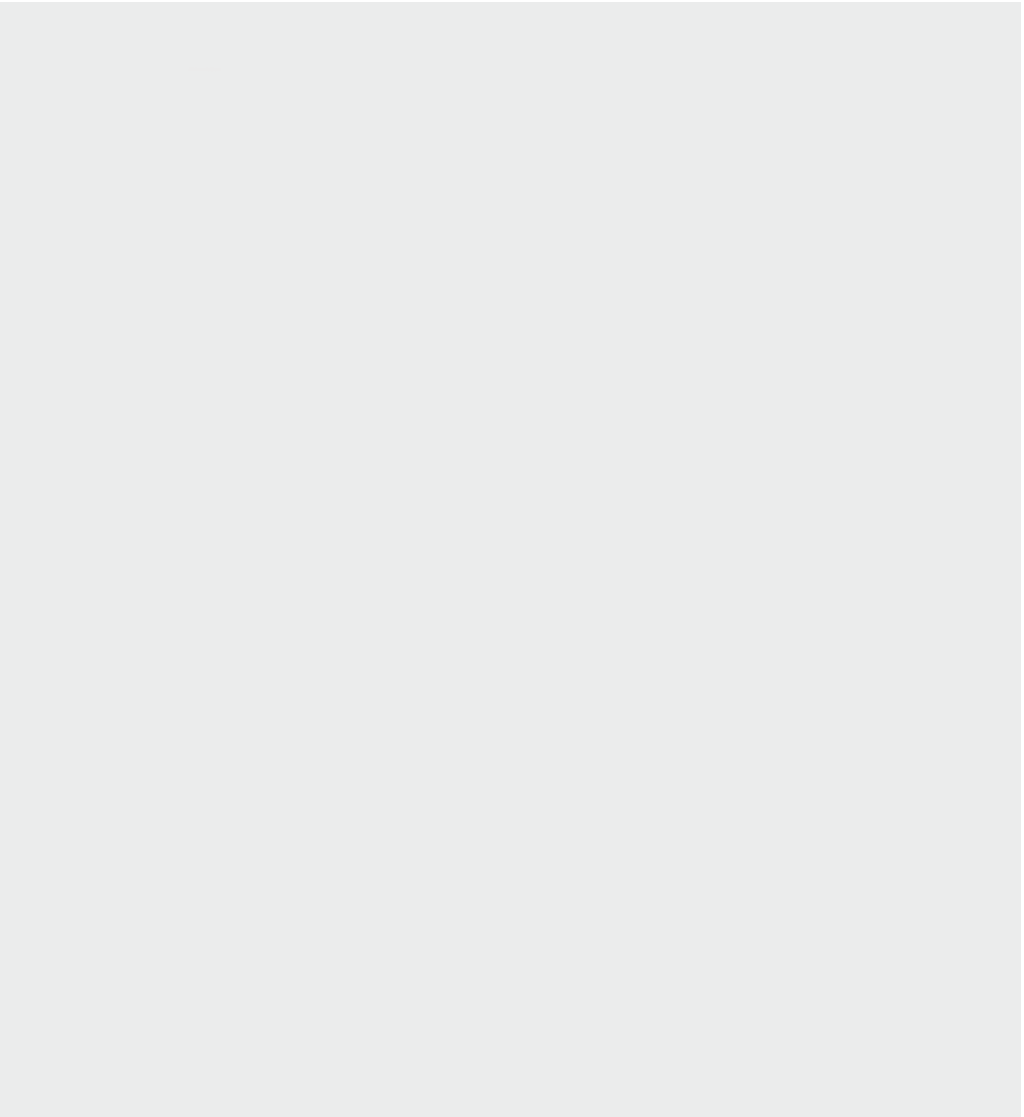

Abbreviation

Abbreviation

ABS

Anti-lock Brake System

BAS

Brake Assistant System

BCA

Blind-Spot Collision-Avoidance Assist

BVM

Blind-Spot View Monitor

CC

Cruise Control

CRS

Child Restraint System

DAW

Driver Attention Warning

DBC

Downhill Brake Control

DRL

Daytime Running Light

EBD

Electronic Brake force Distribution

ECM

Electric Chromic Mirror

EPS

Electric Power Steering

ESC

Electronic Stability Control

FCA

Forward Collision-Avoidance Assist

HAC

Hill-start Assist Control

HBA

High Beam Assist

HDA

Highway Driving Assist

HMSL

High Mounted Stop Lamp

ISLA

Intelligent Speed Limit Assist

LATCH

Lower Anchors and Tether for Children

LFA

Lane Following Assist

LKA

Lane Keeping Assist

MDPS

Motor Driven Power Steering

MIL

Malfunction Indicator Lamp

NSCC

Navigation-based Smart Cruise Control

ODS

Occupant Detection System

PCA

Reverse Parking Collision-Avoidance Assist

Abbreviation

PDW

Reverse Parking Distance Warning

RCCA

Rear Cross-Traffic Collision-Avoidance Assist

RCCW

Rear Cross-Traffic Collision Warning

RVM

Rear View Monitor

SCC

Smart Cruise Control

SEA

Safe Exit Assist

SEW

Safe Exit Warning

SRS

Supplemental Restraint System

SRSCM

SRS Control Module

SVM

Surround View Monitor

TBT

Turn By Turn

TCS

Traction Control System

TIN

Tire Identification Number

TPMS

Tire Pressure Monitoring System

VIN

Vehicle Identification Number

VSM

Vehicle Stability Management

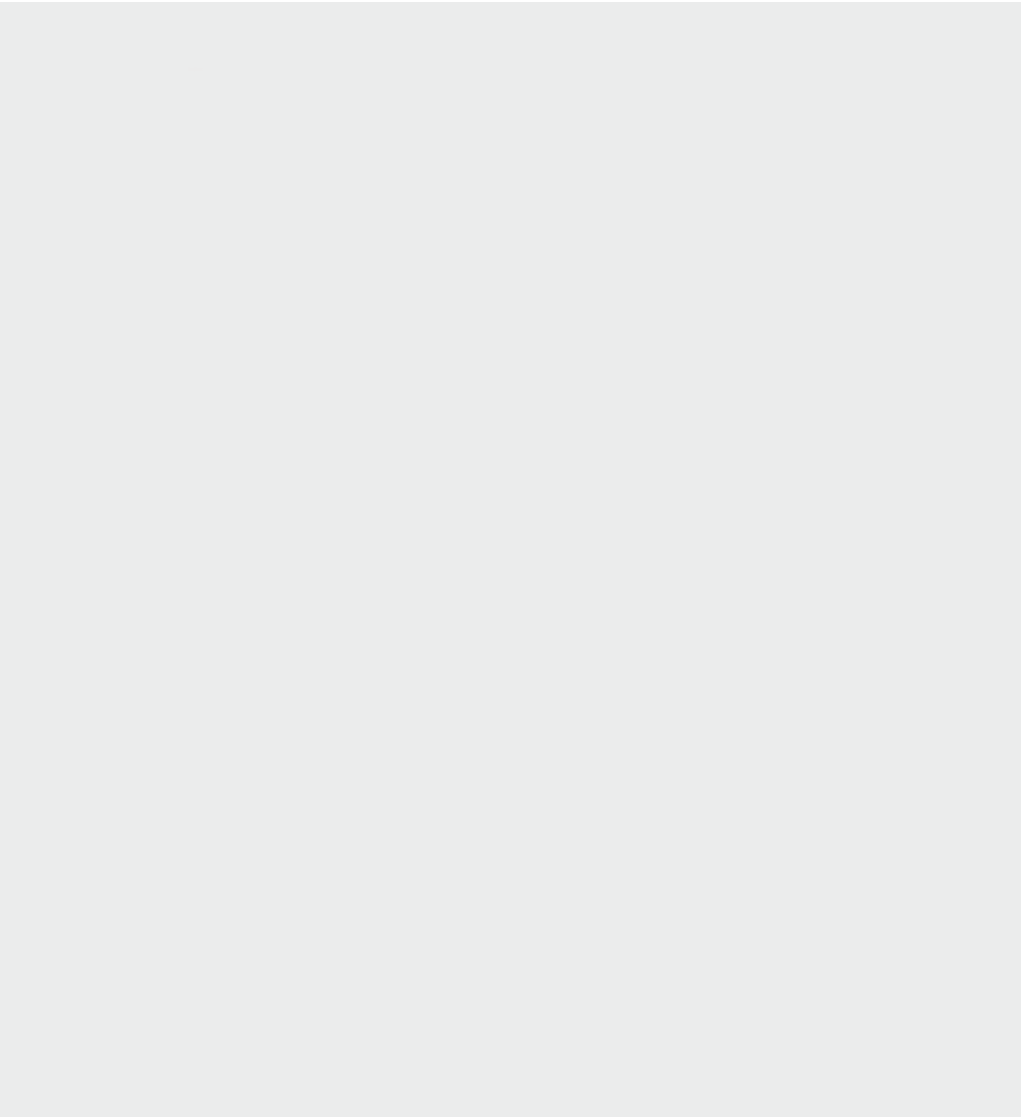

Index

A

AC inverter	4-214
air bag	3-57
adding equipment to or modifying your air bag- equipped vehicle	3-84
additional safety precautions	3-83
air bag collision sensors	3-77
air bag warning labels	3-84
curtain air bag	3-75
front air bag	3-71
inflation conditions	3-79
non-inflation conditions	3-80
occupant detection system (ODS)	3-64
side air bag	3-74
SRS components and functions	3-61
supplemental restraint system (SRS)	3-82
system operation	3-58
warning and indicator	3-60
air cleaner	7-25
air ventilation seat	4-210
ambient light	4-206
appearance care	7-75
exterior care	7-75
interior care	7-80
audio system	4-224
radio	4-225
USB port	4-224
automatic climate control system	4-184
air conditioning	4-193
controlling air intake	4-191
controlling fan speed	4-192
heating and air conditioning automatically	4-186
heating and air conditioning manually	4-188

mode selection	4-189
rear climate control	4-194
temperature control	4-190
turning off the front air climate control	4-193
automatic transmission	5-16
operation	5-20
shift lock system	5-20
automatic transmission shift indicator	4-106
automatic transmission (shift lever)	5-16

B

battery	7-33
battery saver function	4-152
before driving	5-7
blind-spot collision- avoidance assist (BCA)	5-84
blind-spot view monitor (BVM)	5-121
brake fluid	7-23
brake system	5-23
anti-lock brake system (ABS)	5-34
auto hold	5-31
brake assist system (BAS)	5-41
electronic parking brake (EPB)	5-25
electronic stability control (ESC) system	5-35
good braking practices	5-41
hill-start assist control (HAC)	5-38
power brakes	5-23
trailer stability assist (TSA)	5-40
vehicle stability management (VSM) system	5-39
bulb replacement	7-65
bulb replacement precaution	7-61

C

care of seat belts	3-45	from inside the vehicle	4-25
center console storage	4-205	in case of an emergency	4-28
child restraint system (CRS)	3-47	rear occupant alert (ROA) system	4-29
children always in the rear	3-47	with the mechanical key	4-23
installing a CRS	3-50	with the smart key	4-22
selecting a CRS	3-48	drive mode	5-44
types	3-49	drive mode integrated control system	5-44
climate control air filter	7-26	drive mode	5-44
climate control system	4-169	driver attention warning (DAW)	5-113
air conditioning	4-169	driver position memory system	4-31
checking the amount of air conditioner refrigerant	4-172	easy access function	4-33
checking the amount of compressor lubricant	4-172	recalling memory positions	4-32
climate control air filter	4-171	storing memory positions	4-32
heating	4-169	system reset	4-32
rear climate control air filter	4-171	driving info display	4-121
system operation	4-169		
ventilation	4-169		
closing the hood	4-67		
coat hook	4-219		
cruise control (CC)	5-123		
cup holder	4-206		

D

day/night rear view mirror	4-84		
daytime running light (DRL)	4-153		
defogging (windshield)	4-196		
auto defogging system	4-198		
automatic climate control	4-197		
manual climate control system	4-197		
defrosting (windshield)	4-196		
automatic climate control	4-198		
manual climate control system	4-197		
door locks	4-22		
child-protector rear door lock	4-27		
door lock/unlock features	4-27		
		economical operation	5-181
		electronic stability control (ESC) system	5-35
		emergency	6-3
		emergency starting	6-6
		emergency while driving	6-4
		engine doesn't turn over	6-5
		engine stalls at a crossroad or crossing	6-4
		engine will not start	6-5
		flat tire while driving	6-4
		flat tire (with spare tire)	6-16
		hazard warning flasher	6-3
		not start	6-5
		road warning	6-3
		turns over slowly	6-5
		vehicle stalls while driving	6-4
		emergency starting	
		jump-starting	6-6
		push-starting	6-8
		emergency towing	6-30

interior features	4-206	LCD display messages	4-122
AC inverter	4-214	LCD displays	4-117
air ventilation seat	4-210	driving info display	4-121
ambient light	4-206	LCD display messages	4-122
coat hook	4-219	service mode	4-120
cup holder	4-206	trip information	
floor mat anchor(s)	4-220	(trip computer)	4-117
passenger view	4-221	liftgate	4-46
power outlet	4-213	closing the liftgate	4-47
seat warmer	4-207	emergency liftgate	
side curtain	4-219	safety release	4-48
sun visor	4-211	opening the liftgate	4-46
USB charger	4-211	power liftgate	4-49
wireless smart phone		liftgate auto close	4-55
charging system	4-215	how to use	4-55
interior light	4-165	releasing	4-56
automatic turn off function	4-165	light bulbs	7-61
glove box lamp	4-168	bulb replacement	7-65
luggage room lamp	4-167	bulb replacement precaution	7-61
map lamp	4-166	light bulb position (front)	7-63
room lamp	4-167	light bulb position (rear)	7-64
vanity mirror lamp	4-168	light bulb position (side)	7-65
		replacing front fog lamp	
		(LED type)	7-66
		replacing front turn	
		signal lamp (bulb type)	7-66
		replacing glove box lamp	
		(Bulb type)	7-73
		replacing high mounted	
		stop lamp (LED type)	7-69
		replacing license plate	
		lamp (Bulb type)	7-70
		replacing luggage	
		lamp (Bulb type)	7-74
		replacing map lamp	
		(Bulb type)	7-70
		replacing map lamp	
		(LED type)	7-71
		replacing personal lamp	
		(LED type)	7-72
		replacing rear side marker,	
		stop and tail lamp (LED type)	7-69
		replacing rear turn signal lamp,	
		reversing lamp (bulb type)	7-68
interior features	4-206		
AC inverter	4-214		
air ventilation seat	4-210		
ambient light	4-206		
coat hook	4-219		
cup holder	4-206		
floor mat anchor(s)	4-220		
passenger view	4-221		
power outlet	4-213		
seat warmer	4-207		
side curtain	4-219		
sun visor	4-211		
USB charger	4-211		
wireless smart phone			
charging system	4-215		
interior light	4-165		
automatic turn off function	4-165		
glove box lamp	4-168		
luggage room lamp	4-167		
map lamp	4-166		
room lamp	4-167		
vanity mirror lamp	4-168		
<hr/>			
J			
jump-starting	6-6		
<hr/>			
K			
key positions	5-9		
ignition switch position	5-9		
illuminated ignition switch	5-9		
starting the engine	5-10		
keys	4-8		
battery replacement	4-15		
remote key	4-8		
smart key	4-10		
<hr/>			
L			
lane following assist (LFA)	5-151		
lane keeping assist (LKA)	5-77		
LCD display	4-107		
LCD display modes	4-108		

replacing room lamp (Bulb type)	7-71
replacing room lamp (LED type)	7-72
replacing side marker, stop and taillamp (Bulb type)	7-67
replacing side repeater lamp (LED type)	7-66
replacing vanity mirror lamp (Bulb type)	7-73
lighting	4-152
battery saver function	4-152
daytime running light (DRL)	4-153
front fog light	4-157
headlamp delay function	4-152
high beam assist (HBA)	4-157
lighting control	4-153
one-touch lane change	4-157
operating high beam	4-155
operating turn signals	4-156
lighting control	4-153
auto light	4-155
head light (low beam)	4-155
position and tail lamp	4-154
luggage net holder	4-221

M

maintenance	
air cleaner	7-25
battery	7-33
climate control air filter	7-26
engine coolant	7-20
fuses	7-49
lights bulbs	7-61
maintenance services	7-6
owner maintenance	7-7
washer fluid	7-24
wiper blades	7-29
manual climate control system	4-174
air conditioning	4-180
controlling air intake	4-179
controlling fan speed	4-180

heating and air conditioning	4-176
mode selection	4-177
rear climate control	4-181
temperature control	4-178
mirrors	4-83
inside rear view mirror	4-83
outside rear view mirror	4-95

N

navigation-based smart cruise control (NSCC)	5-143
---	-------

O

odometer	4-104
one-touch lane change	4-157
opening the hood	4-66
outside rear view mirror	4-95
adjusting the outside rear view mirror	4-96
folding the outside rear view mirror	4-96
reverse parking aid function	4-97

P

passenger view	4-221
power door ON/OFF button	4-40
power liftgate	4-49
closing the liftgate	4-52
how to reset	4-54
non-opening conditions	4-52
opening height setting	4-54
opening the liftgate	4-51
speed adjustment	4-54
power outlet	4-213
power sliding door	4-35
automatic stop and reversal	4-38
non-operating conditions	4-40
operation	4-35
power window lock button	4-64

pre-tensioner seat belt	3-42	fuel lines, fuel hoses and connections	7-15
push-starting	6-8	spark plugs	7-16
<hr/>			
R		steering gear box, linkage & boots/lower arm ball joint	7-17
rear cross-traffic collision-avoidance assist (RCCA)	5-161	suspension mounting bolts	7-17
rear seat adjustment (7, 8 seats)	3-17	vacuum crankcase	
rear seat adjustment (VIP Lounge Seat)	3-26	ventilation hoses	7-15
rear view monitor (RVM)	4-135	vapor hose and fuel filler cap	7-15
remote key	4-8	scheduled maintenance service	7-9
mechanical key	4-9	scheduled maintenance service precaution	7-9
operation	4-8	seat	3-5
transmitter precautions	4-10	feature of seat leather	3-10
removable towing hook	6-30	front seat adjustment for manual seat	3-10
resetting the sunroof	4-78	front seat adjustment for power seat	3-12
reverse parking collision-avoidance assist (PCA)	5-173	rear seat adjustment (7, 8 seats)	3-17
reverse parking distance warning (PDW)	4-143	rear seat adjustment (VIP Lounge Seat)	3-26
risk of burns when parking or stopping vehicle	1-6	seatback pocket	3-17
roof rack	4-222	seat belt restraint system	3-33
<hr/>			
S		driver's 3-point system with emergency locking retractor	3-35
safe exit assist (SEA)	5-102	pre-tensioner seat belt	3-42
safe exit warning (SEW)	5-96	seat belt warning	3-34
safety precautions	3-3	seat belts	3-33
scheduled maintenance items	7-15	care of seat belts	3-45
air cleaner filter	7-16	precautions	3-44
air conditioning refrigerant	7-17	seat belt restraint system	3-33
automatic transmission fluid	7-16	seat warmer	4-207
brake fluid	7-17	seatback pocket	3-17
brake hoses and lines	7-17	service mode	4-120
coolant	7-16	shift indicator pop-up	4-107
cooling system	7-16	side curtain	4-219
drive shafts and boots	7-17	simultaneous power door sliding door	4-41
fluid levels	7-17	smart cruise control (SCC)	5-126
		smart key	4-10

wheel replacement	7-41
towing	6-28
emergency towing	6-30
emergency towing precautions	6-32
removable towing hook	6-30
without wheel dollies	6-29
trailer towing	5-192
driving with a trailer	5-195
hitches	5-194
maintenance	5-198
pull a trailer	5-199
safety chains	5-195
trailer brakes	5-195
transmission shift indicator	4-106
automatic transmission	
shift indicator	4-106
shift Indicator pop-up	4-107
trip information (trip computer)	
accumulated driving	
information mode	4-118
digital speedometer	4-120
drive info display	4-119
fuel economy	4-118
trip modes	4-117

U

USB charger	4-211
--------------------	-------

V

vehicle auto shut-off system	5-43
vehicle break-in process	1-5
vehicle data collection and event data recorders	1-7
vehicle handling instructions	1-6
vehicle identification number (VIN)	8-8
vehicle load limit	5-201
vehicle modifications	1-5

vehicle weight	5-205
-----------------------	-------

W

warning lights	4-125
warning lights and indicators	4-125
indicator lights	4-131
warning lights	4-125
washer fluid	7-24
welcome system	4-164
window opening and closing	4-63
windows	4-61
power window lock button	4-64
window opening and closing	4-63
windshield defrosting and defogging	4-196
activate upon washer fluid use	4-202
defogging logic	4-201
defroster	4-199
front glass heater	4-200
winter driving	5-189
wiper blades	7-29
wipers and washers	4-161
heated washer nozzle	4-163
wireless smart phone charging system	4-215

