



2024

**IS500 / IS350 AWD / IS350 /
IS300 AWD / IS300**

OWNER'S MANUAL QUICK GUIDE

Contents

The Quick Guide is not intended as a substitute for your *OWNER'S MANUAL*. We strongly encourage you to review the *OWNER'S MANUAL* and supplementary manuals so you will have a better understanding of your vehicle's capabilities and limitations.

Pictorial Index	3
Floor Mat Installation	
Floor Mat Installation.....	11
Entering and Exiting	
Keys.....	12
Smart Access System with Push-button Start.....	14
When Driving	
Engine (Ignition) Switch.....	15
Automatic Transmission.....	18
Turn Signal Lever.....	21
Parking Brake.....	22
Brake Hold.....	24
Multi-information Display.....	25
Eco Driving Indicator.....	28
Headlights.....	29
AHB (Automatic High Beam).....	30
Windshield Wipers and Washer.....	32
Driving Mode Select Switch.....	38
ASC (Active Sound Control).....	41

Driving Comfort

Remote Touch.....42
Center Display 43
Fuel Consumption Information 46
Navigation System * 48
Hands-free System For Cellular Phone * 51
Audio System * 55
Automatic Air Conditioning System * 61
Voice Command System * 64
USB/AUX Ports 71
Lexus Enform Safety Connect.....72
Lexus Enform Remote74
Lexus Enform Service Connect.....75
SiriusXM Satellite Radio.....76

Opening and Closing

Door Locks 77
Power Windows 78
Moon Roof.....79
Fuel Tank Cap 80
Trunk.....81
Garage Door Opener 82

What to do if..

List of Warning/Indicator Lights..... 86
If the electronic key does not operate properly..... 90
If the engine doesn't start..... 92

*: This feature may be operated by Voice command (See P.64)

Pictorial Index

Instrument panel

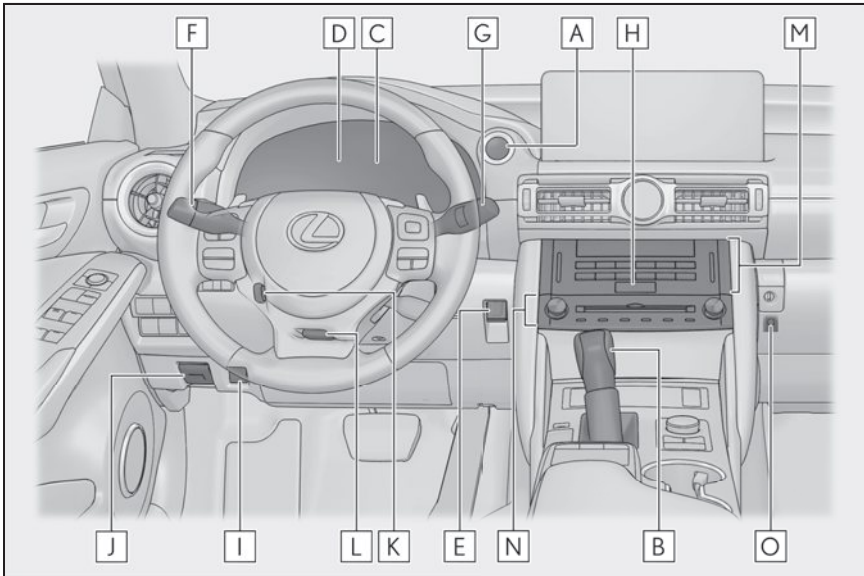

A	Engine switch	P.15
	Starting the engine/changing the modes.....	P.15
	Emergency stop of the engine.....	P.17
	When the engine will not start.....	P.92
	Warning messages ^{*1}	
B	Shift lever	P.18
	Changing the shift position.....	P.18
	Precautions for towing ^{*1}	
	When the shift lever does not move ^{*1}	
C	Meters ^{*1}	
	Reading the meters/adjusting the instrument panel light ^{*1}	
	Warning lights/indicator lights.....	P.86
	When a warning light comes on ^{*1}	
D	Multi-information display	P.25
	Display.....	P.25
	When a warning message is displayed ^{*1}	

E	Parking brake switch	P.22
	Applying/releasing.....	P.22
	Precautions for winter season ^{*1}	
	Warning buzzer/messages ^{*1}	
F	Turn signal lever	P.21
	Headlight switch	P.29
	Headlights/parking lights/tail lights/daytime running lights.....	P.29
G	Windshield wiper and washer switch	P.32
	Usage.....	P.32
	Adding washer fluid ^{*1}	
	Warning messages ^{*1}	
H	Emergency flasher switch ^{*1}	
I	Trunk opener	P.81
J	Hood lock release lever ^{*1}	
K	Tilt and telescopic steering control switch ^{*1,2}	
	Adjustment ^{*1}	
	Driving position memory ^{*1,2}	
L	Tilt and telescopic steering lock release lever ^{*1,2}	
	Adjustment ^{*1}	
M	Air conditioning system	P.61
	Usage.....	P.61
	Rear window defogger.....	P.61
N	Audio system	P.55
O	Trunk opener main switch	P.81

^{*1}: Refer to the "Owner's Manual".

^{*2}: If equipped

■ Switches

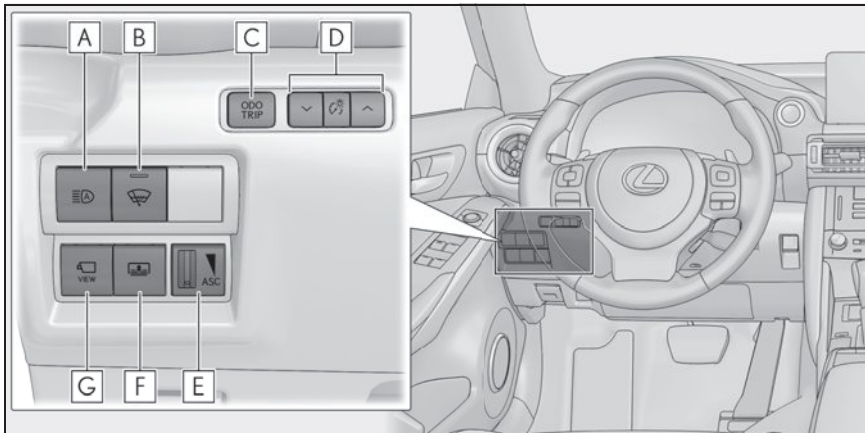

- A** Automatic High Beam switch P.30
- B** Windshield wiper de-icer switch *1,2
- C** Odometer/trip meter and trip meter reset button *2
- D** Instrument panel light control switches *2
- E** ASC (Active Sound Control) switch *1 P.41
- F** Rear sunshade switch *1,2
- G** Camera switch *1,3

*1: If equipped

*2: Refer to the "Owner's Manual".

*3: Refer to "NAVIGATION AND MULTIMEDIA SYSTEM OWNER'S MANUAL".

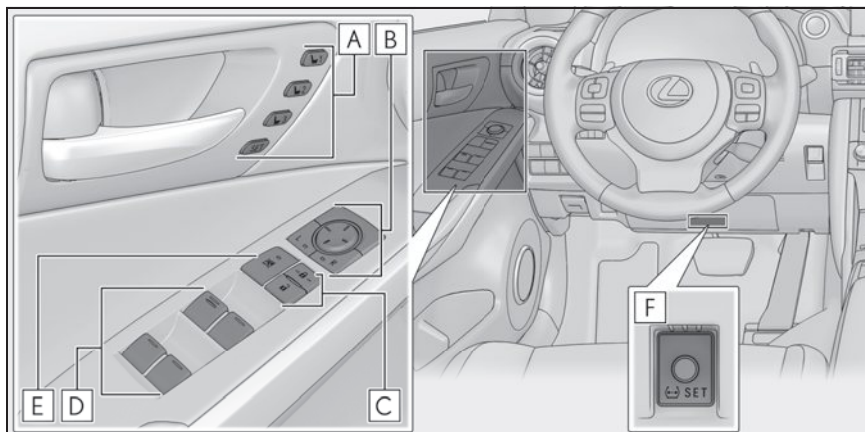

- A** Driving position memory switches *1,2
- B** Outside rear view mirror switches *2
- C** Door lock switches.....P.77
- D** Power window switches.....P.78
- E** Window lock switch.....P.78
- F** Tire pressure warning reset switch *2

*1: If equipped

*2: Refer to the "Owner's Manual".

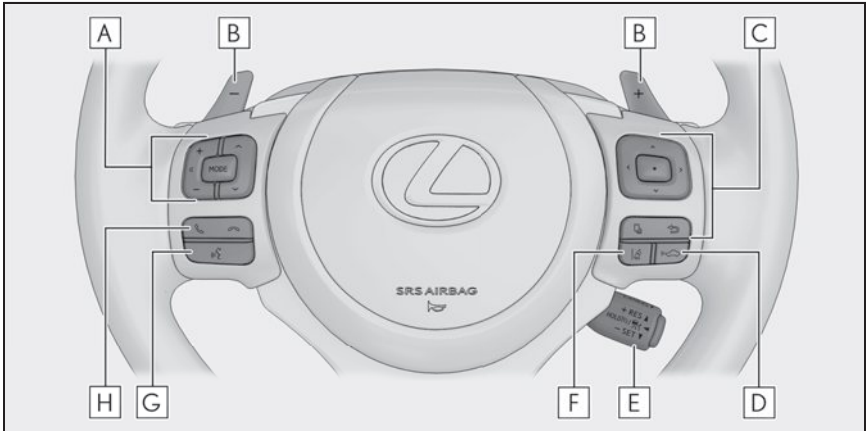

- A** Audio remote control switches..... P.56
- B** Paddle shift switches P.19, 20
- C** Meter control switches P.27
- D** Vehicle-to-vehicle distance switch *
- E** Cruise control switch
Dynamic radar cruise control with full-speed range *
- F** LTA (Lane Tracing Assist) switch *
- G** Talk switch P.56
- H** Phone switches..... P.56

*: Refer to the "Owner's Manual".

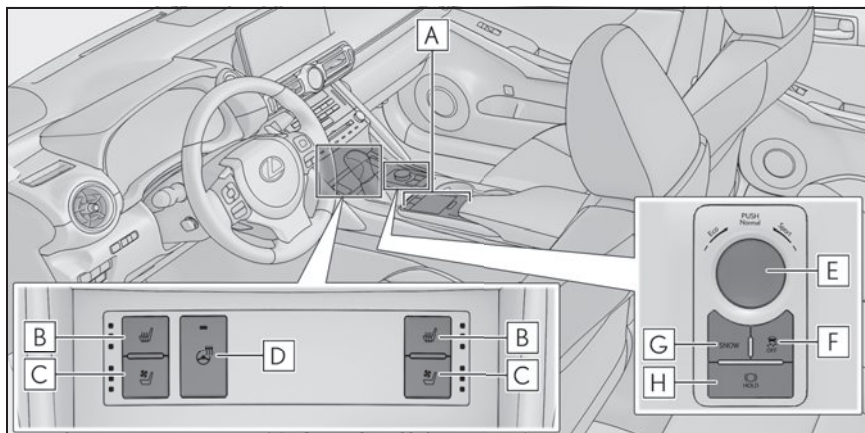

- A** Remote Touch P.42
- B** Seat heater switches *1,2
- C** Seat ventilator switches *1,2
- D** Heated steering wheel switch *1,2
- E** Driving mode select switch P.38
- F** VSC OFF switch *1
- G** Snow mode switch *1
- H** Brake hold switch P.24

*1: Refer to the "Owner's Manual".

*2: If equipped

■ Interior

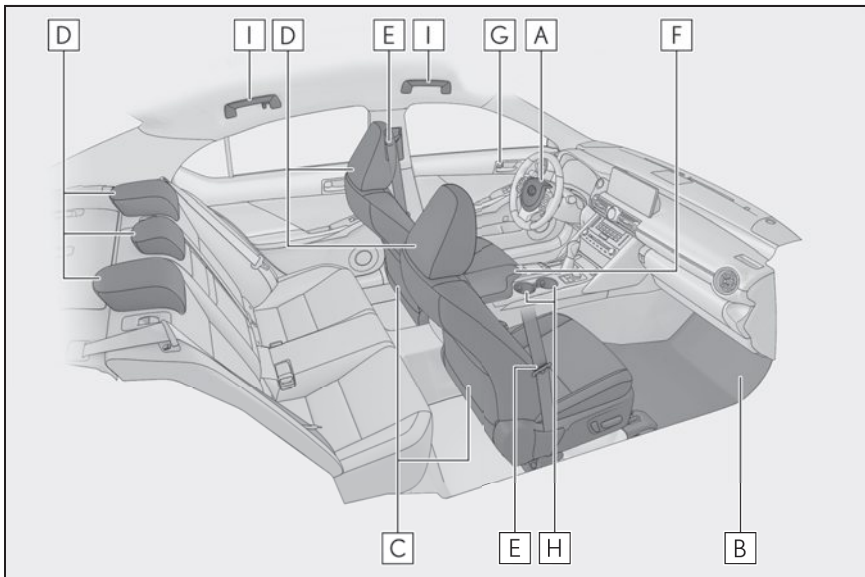

- A** SRS airbags*
- B** Floor matsP.11
- C** Front seats*
- D** Head restraints*
- E** Seat belts*
- F** Console box*
- G** Inside lock buttonsP.77
- H** Cup holders*
- I** Assist grips*

*: Refer to the "Owner's Manual".

■ Ceiling

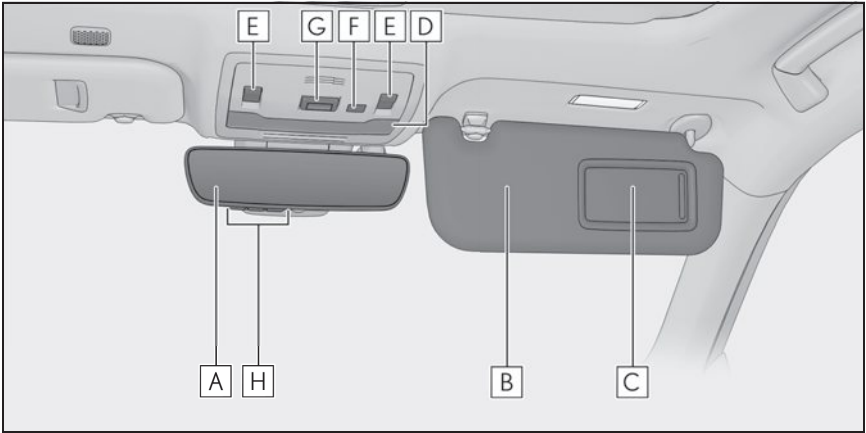

A Inside rear view mirror *1

B Sun visors *1

C Vanity mirrors *1

D Interior light *1
Personal lights *1

E Moon roof switches *2 P.79

F Door-linked interior light switch *1

G "SOS" button *1,2

H Garage door opener switches *2 P.82

*1: Refer to the "Owner's Manual".

*2: If equipped

Floor Mat Installation

Use only floor mats designed specifically for vehicles of the same model and model year as your vehicle. Fix them securely in place onto the carpet.

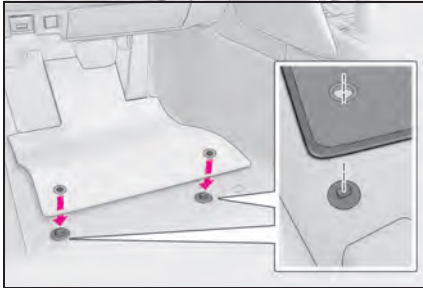

- 1 Insert the retaining hooks (clips) into the floor mat eyelets.

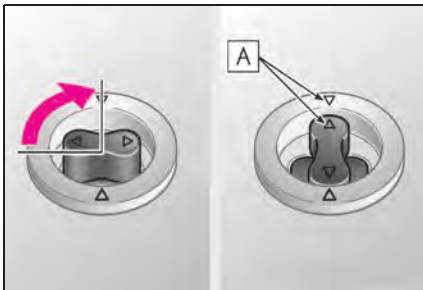

- 2 Turn the upper knob of each retaining hook (clip) to secure the floor mats in place.

Always align the \triangle marks **A**.

The shape of the retaining hooks (clips) may differ from that shown in the illustration.

Keys

The keys

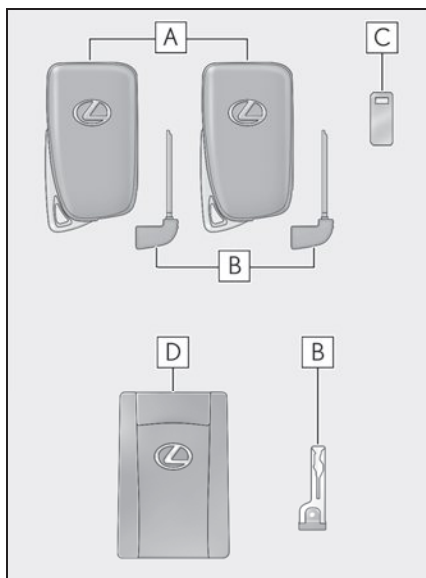

A Electronic keys

- Operating the smart access system with push-button start (→P.14)
- Operating the wireless remote control function

B Mechanical keys

C Key number plate

D Card key (electronic key) (if equipped)

Operating the smart access system with push-button start (→P.14)

Wireless remote control

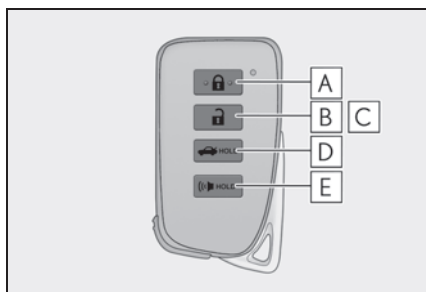

A Locks the doors

B Unlocks the doors

C Opens the windows^{*1} and moon roof^{*1,2}

D Opens the trunk

E Sounds the alarm

^{*1}: This setting must be customized at your Lexus dealer.

^{*2}: If equipped

Mechanical key

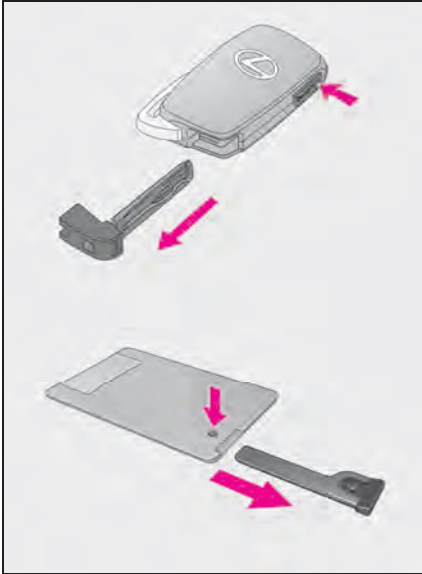

To take out the mechanical key, push the release button and take the key out.

The mechanical key can only be inserted in one direction, as the key only has grooves on one side. If the key cannot be inserted in a lock cylinder, turn it over and re-attempt to insert it.

After using the mechanical key, store it in the electronic key. Carry the mechanical key together with the electronic key. If the electronic key battery is depleted or the entry function does not operate properly, you will need the mechanical key.

Smart Access System with Push-button Start

The following operations can be performed simply by carrying the electronic key on your person, for example in your pocket. The driver should always carry the electronic key.

For details on starting the engine, see page 15.

Unlocking and locking the doors from the outside

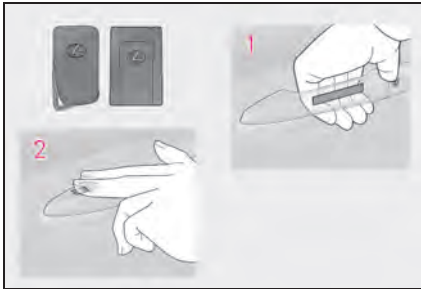

- 1** Grip the driver's door handle to unlock the door. Grip the passenger's front door handle to unlock all the doors.*

Make sure to touch the sensor on the back of the handle.

The doors cannot be unlocked for 3 seconds after the doors are locked.

- *: The door unlock settings can be changed.

- 2** Touch the lock sensor (indentation on the upper part of the front door handle) to lock all the doors.

Check that the door is securely locked.

Opening the trunk from outside the vehicle

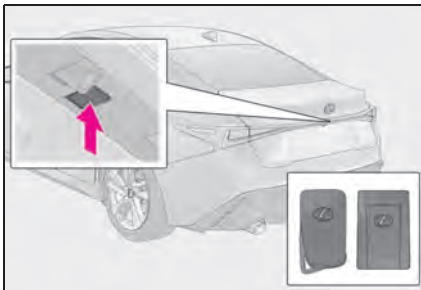

While carrying the electronic key, press the button on the trunk lid.

When all the doors are unlocked with the power door lock system, the trunk can be opened without carrying the electronic key.

For details on what to do when the electronic key does not operate properly, see page 90.

Engine (Ignition) Switch

Performing the following operations when carrying the electronic key on your person starts the engine or changes engine switch modes.

Starting the engine

- 1 Check that the parking brake is set.
- 2 Check that the shift lever is in P.
- 3 Firmly depress the brake pedal.



and a message will be displayed on the multi-information display.

If it is not displayed, the engine cannot be started.

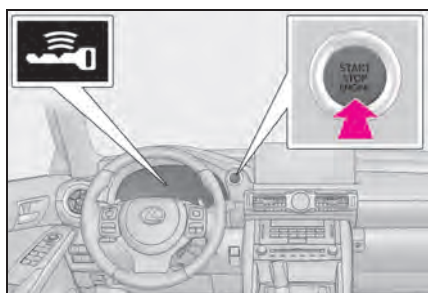

- 4 Press the engine switch shortly and firmly.

When operating the engine switch, one short, firm press is enough. It is not necessary to press and hold the switch.

The engine will crank until it starts or for up to 30 seconds, whichever is less.

Continue depressing the brake pedal until the engine is completely started.

The engine can be started from any engine switch mode.

Stopping the engine

- 1 Stop the vehicle.
- 2 Set the parking brake, and shift the shift lever to P.
- 3 Press the engine switch.
- 4 Release the brake pedal and check that the display on the meters is off.

Changing engine switch modes

Modes can be changed by pressing the engine switch with brake pedal released. (The mode changes each time the switch is pressed.)

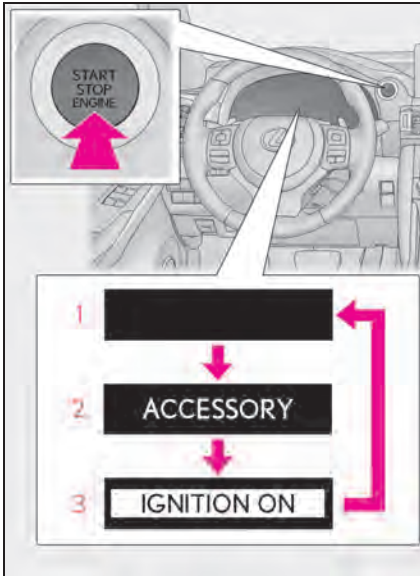

- 1** Off*
The emergency flashers can be used.
The multi-information display will not be displayed.
- 2** ACCESSORY mode
Some electrical components such as the audio system can be used.
“ACCESSORY” will be displayed on the meters.
- 3** IGNITION ON mode
All electrical components can be used.
“IGNITION ON” will be displayed on the meters.

*: If the shift lever is in a position other than P when turning off the engine, the engine switch will be turned to ACCESSORY mode, not to off.

If your vehicle has to be stopped in an emergency

Only in an emergency, such as if it becomes impossible to stop the vehicle in the normal way, stop the vehicle using the following procedure:

- 1** Steadily step on the brake pedal with both feet and firmly depress it.
Do not pump the brake pedal repeatedly as this will increase the effort required to slow the vehicle.
- 2** Shift the shift lever to N.
- ▶ **If the shift lever is shifted to N**
- 3** After slowing down, stop the vehicle in a safe place by the road.
- 4** Stop the engine.
- ▶ **If the shift lever cannot be shifted to N**
- 3** Keep depressing the brake pedal with both feet to reduce vehicle speed as much as possible.



- 4** To stop the engine, press and hold the engine switch for 2 consecutive seconds or more, or press it briefly 3 times or more in succession.

- 5** Stop the vehicle in a safe place by the road.

Automatic Transmission

Shifting the shift lever

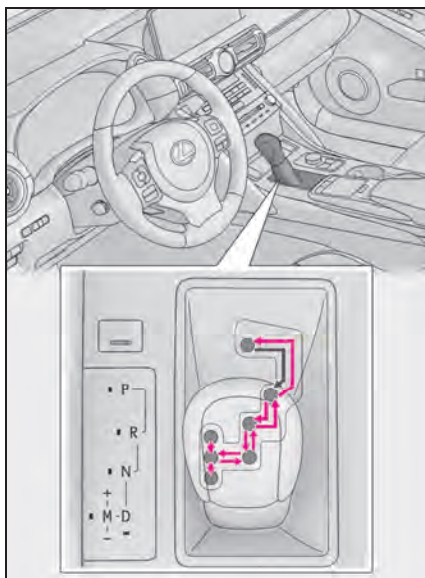

← While the engine switch is in IGNITION ON mode, move the shift lever with the brake pedal depressed.

When shifting the shift lever between P and D, make sure that the vehicle is completely stopped.

Shift position purpose and functions

Shift position	Objective or function
P	Parking the vehicle/starting the engine
R	Reversing
N	Neutral (Condition in which the power is not transmitted)
D	Normal driving ^{*1}
M	M mode driving ^{*2}

*1: To improve fuel efficiency and reduce noise, shift the shift lever to D for normal driving.

*2: Any gear range can be fixed when driving in M mode.

Selecting the driving mode

■ Driving mode

→P.38

Selecting shift ranges in the D position

To drive using temporary shift range selection, operate the “-” or “+” paddle shift switch.

When the “-” paddle shift switch is operated, the shift range will be downshifted to a range that enables engine braking force that is suitable to driving conditions.

When the “+” paddle shift switch is operated, the shift range will be one gear higher than the gear in use during normal D position driving.

Changing the shift range allows restriction of the highest gear, preventing unnecessary upshifting and enabling the level of engine braking force to be selected.

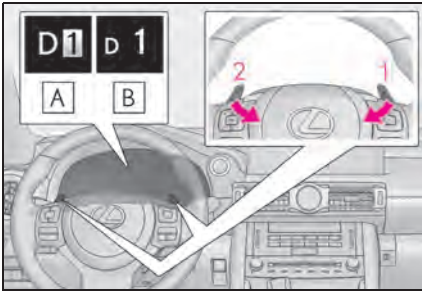

A Except F SPORT models

B F SPORT models

1 Upshifting

2 Downshifting

8-speed models: The selected shift range, from D1 to D8, will be displayed on the multi-information display.

6-speed models: The selected shift range, from D1 to D6, will be displayed on the multi-information display.

To return to normal D position driving, the “+” paddle shift switch must be held down for a period of time.

■ Shift ranges and their functions

Meter display	Function
D2 - D8 (8-speed models)	A gear in the range between 1 and the selected gear is automatically chosen depending on vehicle speed and driving conditions
D2 - D6 (6-speed models)	
D1	1st gear is set

A lower shift range will provide greater engine braking forces than a higher shift range.

Selecting gears in the M position

To enter M mode, shift the shift lever to M. Gears can then be selected by operating the shift lever or paddle shift switches, allowing you to drive in the gear of your choice.

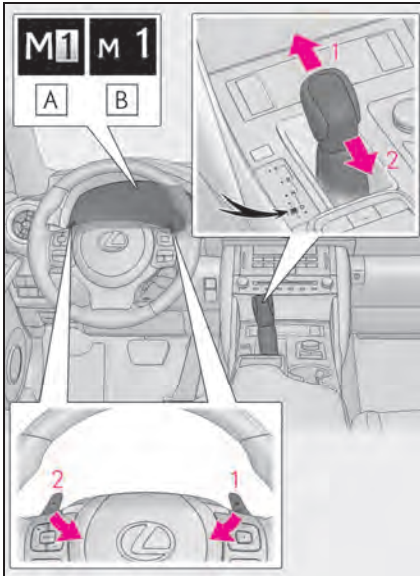

A Except F SPORT models

B F SPORT models

1 Upshifting

2 Downshifting

The gear changes once every time the shift lever or paddle shift switch is operated.

8-speed models: The selected gear, from M1 to M8, will be fixed and displayed on the multi-information display.

6-speed models: The selected gear, from M1 to M6, will be fixed and displayed on the multi-information display.

When in the M position, the gear will not change unless the shift lever or paddle shift switches are operated.

However, even when in the M position, the gears will be automatically changed in the following situation:

- When vehicle speed drops (downshift only).
- When the automatic transmission fluid or engine coolant temperature is low.
- When automatic transmission fluid temperature is high.
- When the needle of the tachometer is in the red zone (the range which exceeds the allowable revs of the engine).

In the following situations, the gear will not shift even if the shift lever or paddle shift switches are operated.

- "Slippery Road Cannot Shift to Lower Gear" is displayed on the multi-information display.
- The vehicle speed is low (upshift only).

Turn Signal Lever

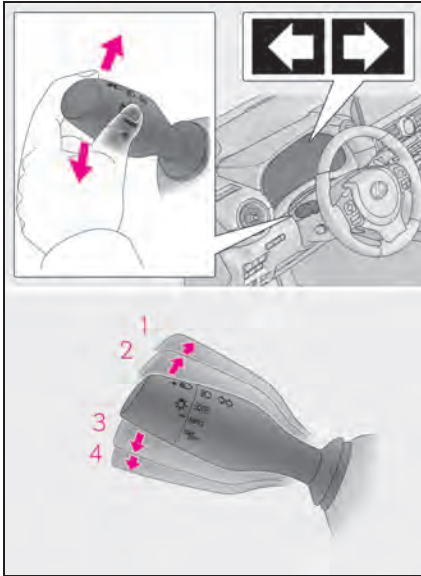

- 1 Right turn
- 2 Lane change to the right (move the lever partway and release it)
The right hand signals will flash 3 times.
- 3 Lane change to the left (move the lever partway and release it)
The left hand signals will flash 3 times.
- 4 Left turn

■ If the turn signals do not stop flashing after turning left or right, or if you want to stop them flashing

Operate the lever in the opposite direction to either position **2** or **3**.

If you move the lever to either position **1** or **4**, the selected turn signals will flash.

Parking Brake

The parking brake can be set or released automatically or manually.

Using the manual mode

The parking brake can be set and released manually.

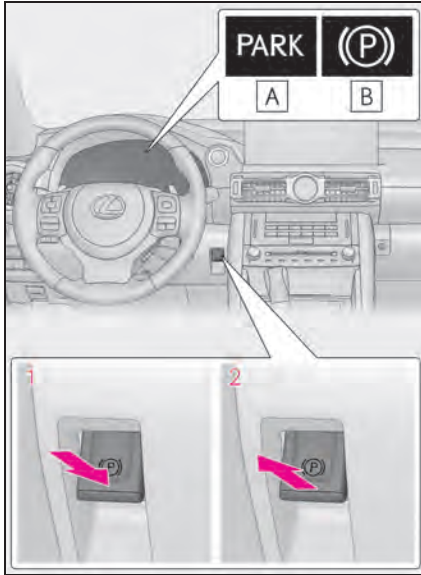

A U.S.A.

B Canada

- 1** Push the switch to set the parking brake

The parking brake indicator light will turn on.

Press and hold the parking brake switch if an emergency occurs and it is necessary to operate the parking brake while driving.

- 2** Pull the switch to release the parking brake

- Operate the parking brake switch while depressing the brake pedal.
- Using the parking brake automatic release function, the parking brake can be released by depressing the accelerator pedal. When using this function, slowly depress the accelerator pedal.

Make sure that the parking brake indicator light turn off.

If the parking brake indicator light flashes, operate the switch again.

Turns automatic mode on

In automatic mode, the parking brake can be set or released automatically according to the shift lever operation. Also, even in automatic mode, the parking brake can be set or released manually.

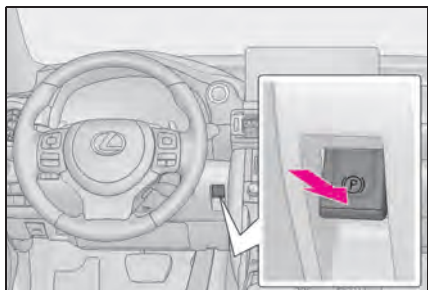

While the vehicle is stopped, press and hold the parking brake switch until “EPB Shift Interlock Function Activated” will be displayed on the multi-information display.

When the automatic mode is turned on, the parking brake operates as follows.

- When the shift lever is moved out of P, the parking brake will be released, and the parking brake indicator light will turn off.
- When the shift lever is moved into P, the parking brake will be set, and the parking brake indicator light will turn on.

Operate the shift lever with the vehicle stopped and the brake pedal depressed.

Turns automatic mode off

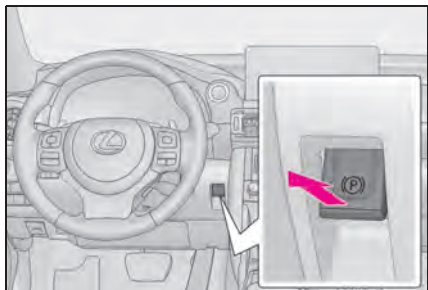

While the vehicle is stopped, pull and hold the parking brake switch until “EPB Shift Interlock Function Deactivated” will be displayed on the multi-information display.

Brake Hold

The brake hold system keeps the brake applied when the shift lever is in D, M or N with the system on and the brake pedal has been depressed to stop the vehicle. The system releases the brake when the accelerator pedal is depressed with the shift lever in D or M to allow smooth start off.

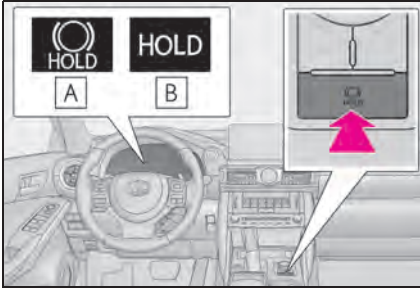

Turns the brake hold system on

The brake hold standby indicator (green)

A comes on. While the system is holding the brake, the brake hold operated indicator (yellow) **B** comes on.

Multi-information Display

Display and menu icons

■ Display (except F SPORT models)

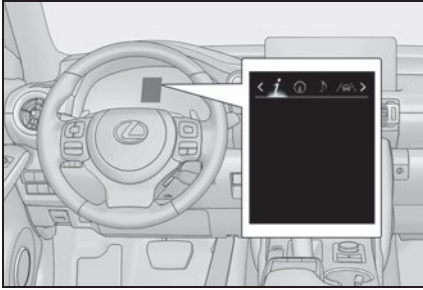

By selecting menu icons on the multi-information display, a variety of driving-related information can be displayed. The multi-information display can also be used to change display settings and other vehicle settings.

Warning or advice pop-up displays are also displayed in certain situations.

■ Display (F SPORT models)

▶ Main meter in center position

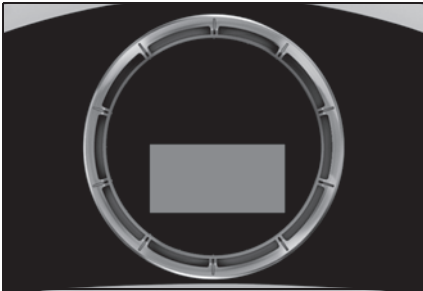

The multi-information display presents the driver with a variety of driving-related information.

Warning or advice pop-up displays are also displayed in certain situations.

▶ Main meter moved to the right



By selecting menu icons on the multi-information display, a variety of driving-related information can be displayed. The multi-information display can also be used to change display settings and other vehicle settings.

Warning or advice pop-up displays are also displayed in certain situations.

■ Menu icons



Driving information



Navigation system-linked display (if equipped)



Audio system-linked display



Driving support system information display



Warning message display



Settings display

If a problem is detected in any of the vehicle's systems, a warning message is shown on the multi-information display.

Changing the meter display

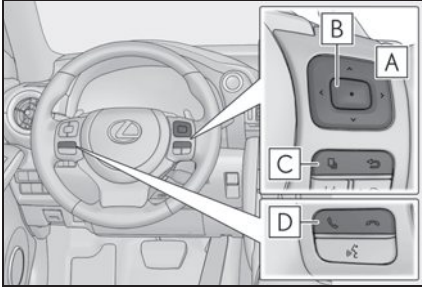

- A** < / > : Select menu icons
^ / v : Change displayed content, scroll up/down the screen and move the cursor up/down
- B** Press: Enter/Set
Press and hold: Reset

► Except F SPORT models

- C** Display the top screen and return to the previous screen

Press and hold  : Register current screen as the top screen

- D** Call sending/receiving and history display

Linked with the hands-free system, sending or receiving call is displayed. For details regarding the hands-free system, refer to the "NAVIGATION AND MULTIMEDIA SYSTEM OWNER'S MANUAL".

► F SPORT models

- C** Move the main meter and return to the previous screen

- D** Call sending/receiving and history display

Linked with the hands-free system, sending or receiving call is displayed. For details regarding the hands-free system, refer to the "NAVIGATION AND MULTIMEDIA SYSTEM OWNER'S MANUAL".

Eco Driving Indicator

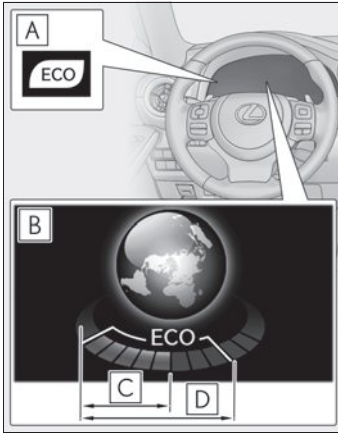

A Eco Driving Indicator Light

During Eco-friendly acceleration (Eco driving), the Eco Driving Indicator Light will turn on. When the acceleration exceeds the Zone of Eco driving, or when the vehicle is stopped, the light turns off.

B Eco Driving Indicator Zone Display

Suggests the Zone of Eco driving with current Eco driving ratio based on acceleration.

C Eco driving ratio based on acceleration

If the acceleration exceeds the Zone of Eco driving, the right side of the Eco Driving Indicator Zone Display will illuminate.

At this time, the Eco Driving Indicator Light will turn off.

D Zone of Eco driving

Eco Driving Indicator will not operate under the following conditions:

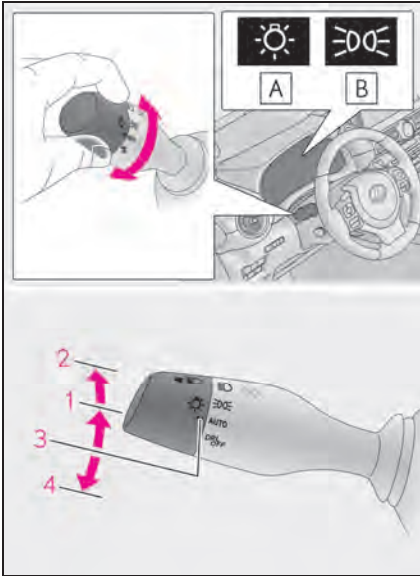

- The shift lever is in position other than D.
- A paddle shift switch is operated.
- Neither normal mode nor Eco drive mode is selected.
- The vehicle speed is approximately 80 mph (130 km/h) or higher.

Headlights



A U.S.A.

B Canada

- 1**  The side marker, parking, tail, license plate, instrument panel lights, and daytime running lights turn on.
- 2**  The headlights and all lights listed above (except daytime running lights) turn on.
- 3** **AUTO** The headlights, parking lights, daytime running lights and all the lights listed above turn on and off automatically. (When the engine switch is in IGNITION ON mode.)
- 4**  (U.S.A.) Off

Turning on the high beam headlights

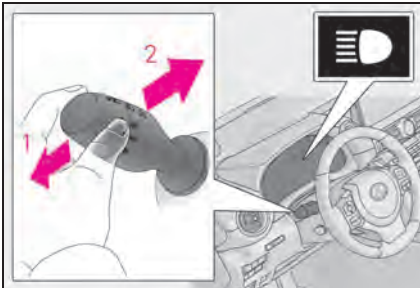

- 1** With the headlights on, push the lever away from you to turn on the high beams.
Pull the lever toward you to the center position to turn the high beams off.
- 2** Pull the lever toward you and release it to flash the high beams once.
You can flash the high beams with the headlights on or off.

AHB (Automatic High Beam)

The Automatic High Beam uses a camera sensor located behind the upper portion of the windshield to assess the brightness of the lights of vehicles ahead, streetlights, etc., and automatically turns the high beams on or off as necessary.

Activating the Automatic High Beam

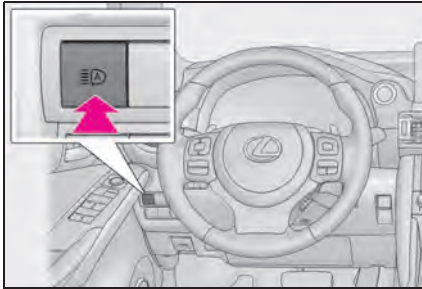

- 1 Press the Automatic High Beam switch.

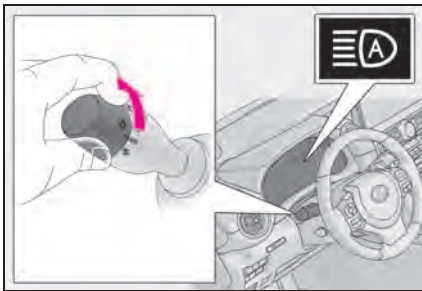

- 2 Turn the headlight switch to the  or AUTO position.

When the headlight switch lever is in the original position, the Automatic High Beam system will be enabled and the Automatic High Beam indicator will illuminate.

Turning the high beams on/off manually

■ Switching to the high beams

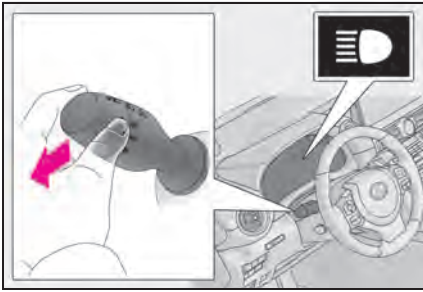

Push the lever away from you.

The Automatic High Beam indicator will turn off and the high beam indicator will turn on.

Pull the lever to its original position to activate the Automatic High Beam system again.

■ Switching to the low beams

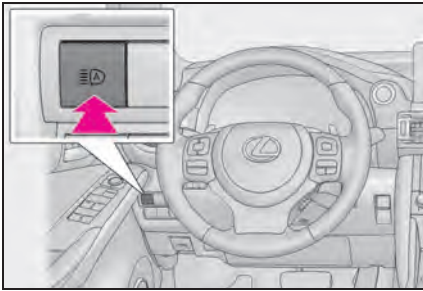

Press the Automatic High Beam switch.

The Automatic High Beam indicator will turn off.

Press the switch to activate the Automatic High Beam system again.

■ Temporarily switching to the low beams

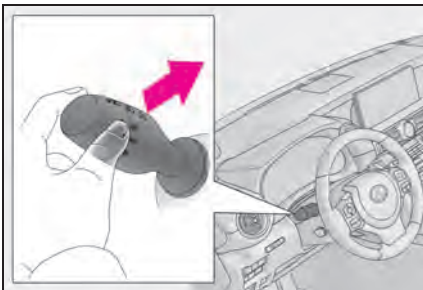

Pull the lever toward you and then return it to its original position.

The high beams are on while the lever is pulled toward you, however, after the lever is returned to its original position, the low beams remain on for a certain amount of time. Afterwards, the Automatic High Beam will be activated again.

Windshield Wipers and Washer

Operating the  lever operates the wipers or washer as follows. The lever will return to its original position after operation.



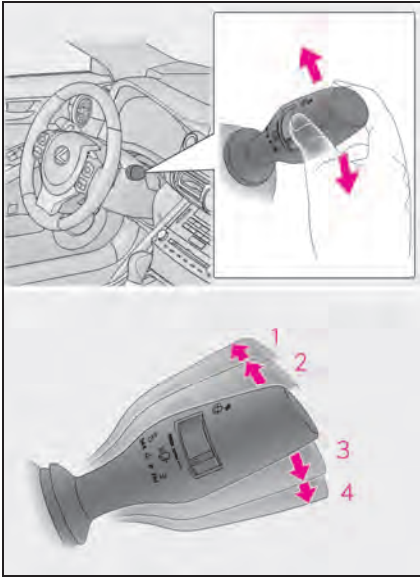



► Intermittent windshield wipers with interval adjuster



- 1**  **OFF** (U.S.A.) or  (Canada)
Move the lever up by 2 levels
- 2**  Move the lever up by 1 level
- 3**  (U.S.A.) or  (Canada)
Move the lever down by 1 level
- 4**  **HI** (U.S.A.) or  (Canada)
Move the lever down by 2 levels

Depending on the operating state of the wipers when the wiper lever is operated, the wipers will operate as follows.

• Current wiper operation: Off

Wiper lever operation	Wiper operation
 OFF or 	Temporary operation
	Temporary operation
 or 	Intermittent operation
 HI or 	High speed operation

• Current wiper operation: Intermittent operation

Wiper lever operation	Wiper operation
⚡ OFF or ○	Off
△	Off
▼ or ▽	Low speed operation
⚡ HI or ⚡	High speed operation

• Current wiper operation: Low speed operation

Wiper lever operation	Wiper operation
⚡ OFF or ○	Off
△	Intermittent operation
▼ or ▽	High speed operation
⚡ HI or ⚡	High speed operation

• Current wiper operation: High speed operation

Wiper lever operation	Wiper operation
⚡ OFF or ○	Off
△	Low speed operation
▼ or ▽	No change
⚡ HI or ⚡	No change

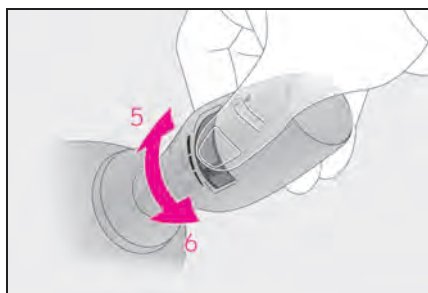

Wiper intervals can be adjusted when intermittent operation is selected.

- 5** Increases the intermittent windshield wiper frequency
- 6** Decreases the intermittent windshield wiper frequency

The intermittent windshield wiper operates more frequently as vehicle speed becomes higher.

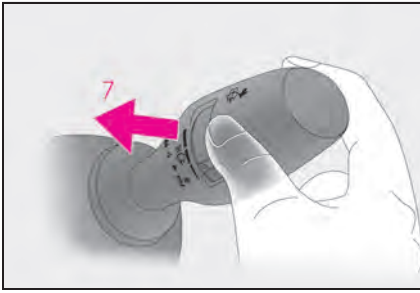

7  Washer/wiper dual operation

Pulling the lever operates the wipers and washer.

The wipers will automatically operate a couple of times after the washer squirts.

Vehicles with headlight cleaners:

When the engine switch is in IGNITION ON mode and the headlights are on, if the lever is pulled, the headlight cleaners will operate once. After this, the headlight cleaners will operate every 5th time the lever is pulled.

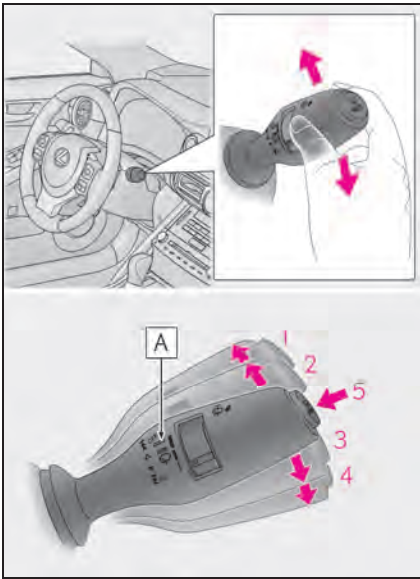

► Rain-sensing windshield wipers





1  OFF (U.S.A.) or  (Canada)

Move the lever up by 2 levels

2  Move the lever up by 1 level

3  (U.S.A.) or  (Canada)

Move the lever down by 1 level

4  HI (U.S.A.) or  (Canada)

Move the lever down by 2 levels





5  AUTO mode on/off switch

With AUTO mode selected, the wipers will operate automatically when the sensor detects falling rain. The system automatically adjusts wiper timing in accordance with rain volume and vehicle speed.



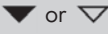

The AUTO mode indicator **A** will turn on when AUTO mode is selected.

Depending on the operating state of the wipers when the wiper lever is operated, the wipers will operate as follows.



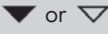

- Current wiper operation: Off

Wiper lever operation	Wiper operation
	Temporary operation
	Temporary operation
	Low speed operation
	High speed operation

- Current wiper operation: Low speed operation

Wiper lever operation	Wiper operation
	Off
	Off
	High speed operation
	High speed operation

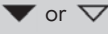
- Current wiper operation: High speed operation

Wiper lever operation	Wiper operation
	Off
	Low speed operation
	No change
	No change

- Current wiper operation: AUTO mode (Intermittent operation)

Wiper lever operation	Wiper operation
⚡ OFF or ○	Off
△	Temporary operation*
▼ or ▽	Low speed operation
⚡ HI or ⚡	High speed operation

*: After temporary operation, the mode will return to AUTO mode.

- Current wiper operation: AUTO mode (Continuously)

Wiper lever operation	Wiper operation
⚡ OFF or ○	Off
△	No change
▼ or ▽	Low speed operation
⚡ HI or ⚡	High speed operation

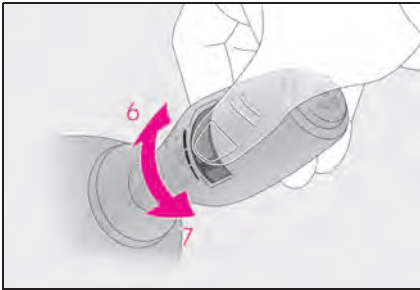

When AUTO mode is selected, the sensor sensitivity can be adjusted by turning the switch ring.

- 6** Increases the sensitivity
- 7** Decreases the sensitivity

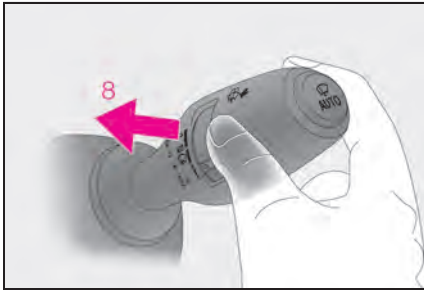

8  Washer/wiper dual operation

Pulling the lever operates the wipers and washer.

The wipers will automatically operate a couple of times after the washer squirts.

Vehicles with headlight cleaners:

When the engine switch is in IGNITION ON mode and the headlights are on, if the lever is pulled, the headlight cleaners will operate once. After this, the headlight cleaners will operate every 5th time the lever is pulled.

Driving Mode Select Switch

The driving modes can be selected to suit driving condition.

► Vehicles without Adaptive Variable Suspension System

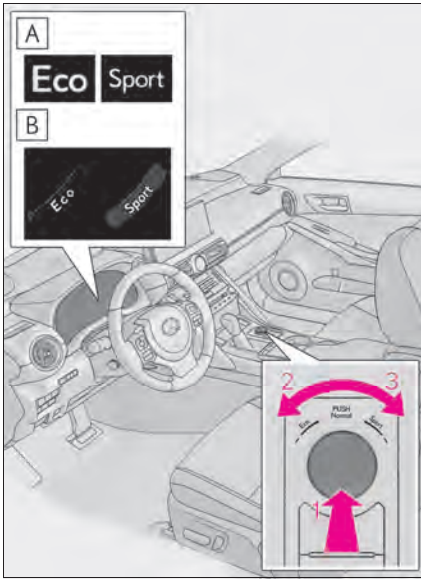

A Except F SPORT models

B F SPORT models

1 Normal mode

Provides an optimal balance of fuel economy, quietness, and dynamic performance. Suitable for city driving.

Press the switch to change the driving mode to normal mode when Eco drive mode or sport mode is selected.

2 Eco drive mode

Helps the driver accelerate in an eco-friendly manner and improve fuel economy through moderate throttle characteristics and by controlling the operation of the air conditioning system (heating/cooling).

When not in Eco drive mode, if the driving mode select switch is turned to the left, the Eco drive mode indicator will come on.

3 Sport mode

Controls the transmission and engine to provide quick, powerful acceleration. This mode also changes the steering feel, making it suitable for when agile driving response is desired, such as when driving on roads with many curves.

When not in sport mode, if the driving mode select switch is turned to the right, the "SPORT" indicator will come on.

► Vehicles with Adaptive Variable Suspension System

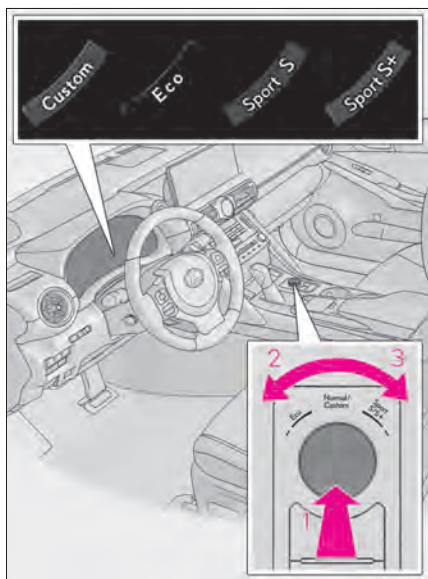

1 Normal mode/Customized mode

Normal mode and customized mode are selected by pressing the driving mode select switch. Each time the switch is pressed, the driving mode changes between normal mode and customized mode. When customized mode is selected, the “Customize” indicator will be illuminated.

When Eco drive mode or sport mode is selected, pressing the switch changes the driving mode to normal mode.

- Normal mode
Provides an optimal balance of fuel economy, quietness, and dynamic performance. Suitable for city driving.

- Customized mode

Allows you to drive with the following functions set to your preferred settings. Customized mode settings can only be changed on the drive mode customization display of the Center Display.

Function	Setting
Powertrain	Normal
	Power
	Eco
Chassis	Normal
	Sport
Air conditioning system	Normal
	Eco

2 Eco drive mode

Helps the driver accelerate in an eco-friendly manner and improve fuel economy through moderate throttle characteristics and by controlling the operation of the air conditioning system (heating/cooling).

When not in Eco drive mode, if the driving mode select switch is turned to the left, the Eco drive mode indicator will come on.

3 Sport mode

- SPORT S mode

Controls the transmission and engine to provide quick, powerful acceleration. This mode is suitable for when agile driving response is desired, such as when driving on roads with many curves.

When not in SPORT S mode, if the driving mode select switch is turned to the right, the "SPORT S" indicator will come on.

- Sport S+ mode

Helps to ensure steering performance and driving stability by simultaneously controlling the steering and suspension in addition to the transmission and engine. Suitable for sportier driving.

When in SPORT S mode, if the driving mode select switch is turned to the right, the "SPORT S+" indicator will come on.

ASC (Active Sound Control) (if equipped)

The ASC system is an electronic sound system that generates driving sound, conveying the kinetic situations of the vehicle's acceleration and deceleration to the driver through the speakers behind the instrument panel. The vehicle's response to the driver's acceleration behavior and shift operations are also conveyed in sound. When sport mode is selected, the sound conveyed to the driver will be louder.

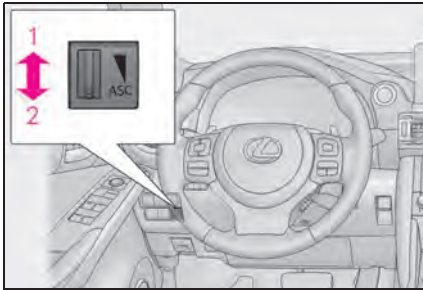

1 Louder

2 Lower

When the dial is turned to the lowest volume, driving sound will be turned off and the indicator will go off.

Remote Touch

The Remote Touch can be used to operate the Center Display.

Remote Touch is the name for the device that includes the “MAP” button/“HOME” button, “MENU” button, back button, touchpad and sub function button.

Names and operations of each part

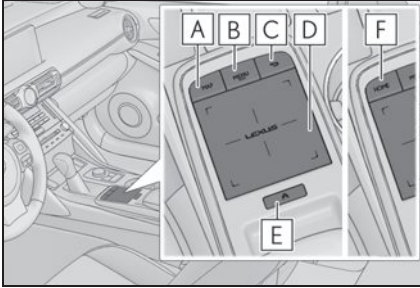

- A** Vehicles with a 10.3-inch display:
“MAP” button

Vehicles with navigation function:
Press this button to display the vehicle's current position.

Vehicles without navigation function:
Press this button to display the compass mode screen.

- B** “MENU” button

Press this button to display the menu screen.

- C** Back button

Press this button to display the previous screen.

- D** Touchpad

Slide your finger on the touchpad and move the pointer to select a function, letter and screen button.

Press the touchpad to enter the selected function, letter or screen button. Certain finger movements on the touchpad can perform functions, such as changing map scalings and scrolling list screens.

- E** Sub function button

When  is displayed on the screen, a function screen assigned to the screen can be displayed.

- F** Vehicles with a 8-inch display:
“HOME” button

Press this button to display the compass mode screen.

Center Display

Menu screen

Press the “MENU” button on the Remote Touch to display the menu screen.

▶ Vehicles with a 10.3-inch display

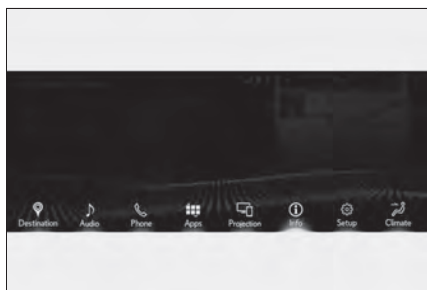

▶ Vehicles with a 8-inch display



Switch	Function
	Select to display the “Destination” screen.*1
	Select to display the audio control screen.*1
	Select to display the hands-free control screen.*1
	Select to display the “Apps” screen.*1,2
	When an Apple CarPlay/Android Auto connection is established and this button displays “Apple CarPlay”/“Android Auto”, select to display the home screen of Apple CarPlay/Android Auto.*1,2
	Select to display the information screen.*1 (→P.46)
	Select to display the setup screen.*1
	Select to display the air conditioning control screen. (→P.61)
	Select to adjust the contrast and brightness of the screens, turn the screen off, etc.*1,2

*1: Refer to “NAVIGATION AND MULTIMEDIA SYSTEM OWNER’S MANUAL”.

*2: This function is not available on some models.

Split-screen display (vehicles with a 10.3-inch display)

Different information can be displayed on the left and right sides of the screen. For example, air conditioning system screen can be displayed and operated while the fuel consumption information screen is being displayed. The large screen on the left of the display is called the main display, and the small screen to the right is called the side display.

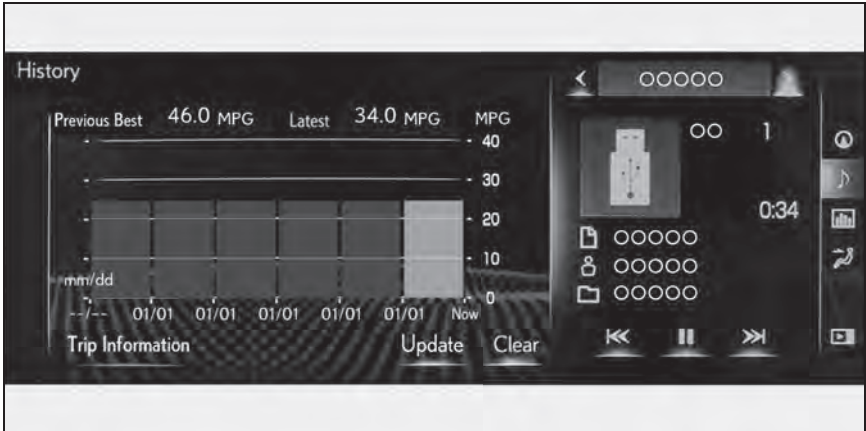

Side display (vehicles with a 10.3-inch display)

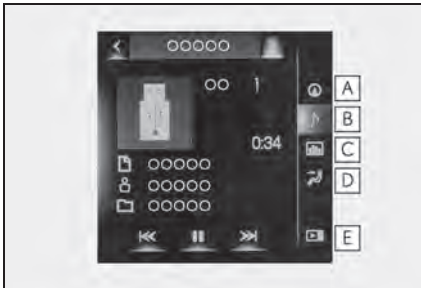

The following functions can be displayed and operated on the side display.

- A** Navigation system (→P.48)
- B** Audio (→P.57, 58, 59, 60)
- C** Vehicle information (→P.47)
- D** Air conditioning system (→P.63)
- E** Show/hide the side display*

*: Refer to “NAVIGATION AND MULTI-MEDIA SYSTEM OWNER’S MANUAL”.

Map scroll operation

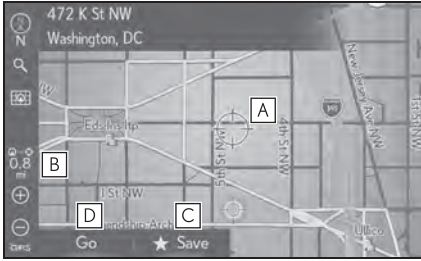

Select the desired point on the map screen.
Move the desired point on the center of the map screen.

- A** Cursor mark
- B** Distance from the current position to the cursor mark
- C** Select to register as a memory point
- D** Select to set as a destination

Press the “MAP” button on the Remote Touch to return to the current position.

Editing route

While route guidance is operating, you can change the route using the following method.

- 1 Select  on the map screen.

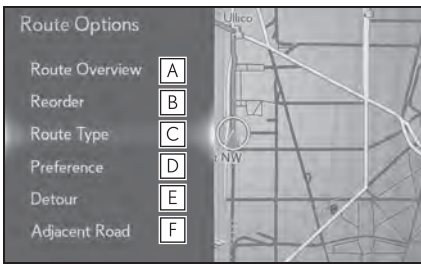

- 2 Select the desired item to be set.

- A** Select to display the overview of the entire route
- B** Select to reorder destinations
- C** Select to change route type
- D** Select to set route preferences
- E** Select to set detours
- F** Select to start from adjacent road

- 3 Check that the route overview is displayed.

Some functions are unavailable while the vehicle is in motion. Refer to “NAVIGATION AND MULTIMEDIA SYSTEM OWNER’S MANUAL”.

Fuel Consumption Information

Fuel consumption information can be displayed on the Center Display.

Vehicles with a navigation system (10.3-inch display): The fuel consumption information can be displayed and operated on the side display. For details, refer to the “OWNER’S MANUAL”.

Consumption

Press the “MENU” button on the Remote Touch, then select  on the menu screen.

Trip information

If a screen other than “Trip Information” is displayed, select “Trip Information”.

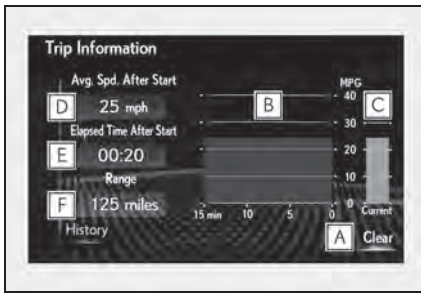

- A** Resetting the consumption data
- B** Fuel consumption in the past 15 minutes
- C** Current fuel consumption
- D** Average vehicle speed since the engine was started.
- E** Elapsed time since the engine was started.
- F** Cruising range

History

If a screen other than “History” is displayed, select “History”.

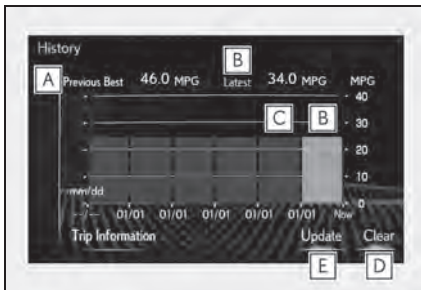

- A** Best recorded fuel consumption
- B** Latest fuel consumption
- C** Previous fuel consumption record
- D** Resetting the history data
- E** Updating the latest fuel consumption data

Side display (vehicles with a navigation system [10.3-inch display])

Vehicle information can be displayed on the side display, then select **<** or **>** to select the desired screen.

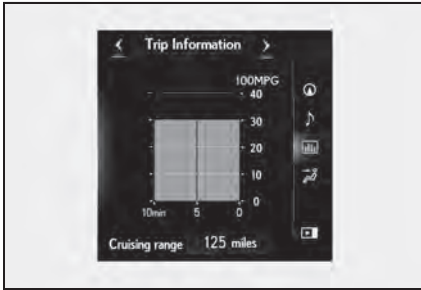

- Trip information (type A/type B)
- History

Navigation System (if equipped)

Registering home

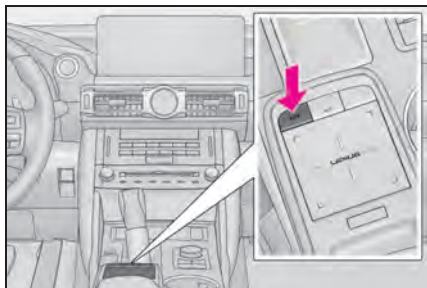

- 1 Press the "MAP" button on the Remote Touch.

Please refer to P.42 for the Remote Touch operation.

- 2 Select .
- 3 Select "Home".
- 4 Select "Yes".
- 5 Select "OK".

Registration of home is complete.

Destination search

■ Searching by address

- 1 Display the destination search screen by either operation:

- "MAP" button → 
- "MENU" button → "Destination"

- 2 Select "Address".

If a state (province) has not been selected yet, "State/Province" screen is displayed.

- 3 Enter a house number and select "Search".

"Change State/Province": Select to change the search area.

- 4 Enter a street name and select "Search".

- 5 Select the desired street name.

- 6 Enter a city name and select "Search".

- 7 Select the desired city name.

If multiple locations with the same address exist, the address list screen will be displayed. Select the desired address.

■ Searching by point of interest

There are 3 methods to search for a destination by Point of Interest.

1 Display the destination search screen by either operation:

- "MAP" button → 
 - "MENU" button → "Destination"
- 2 Select "Point of Interest".

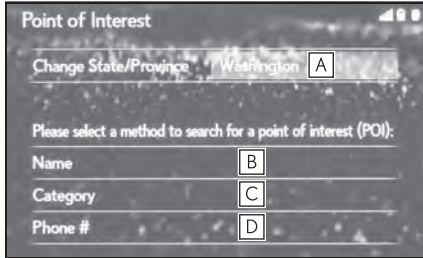

3 Select the desired search method.

- A** Select to change the search area.
- B** Select to search by name.
- C** Select to search by category.
- D** Select to search by phone number.

► Searching by name (**B**)

- 4 Select "Name".
- 5 Enter a POI name and select "Search".
- 6 Select the desired POI.

► **Searching by category (C)**

4 Select "Category".

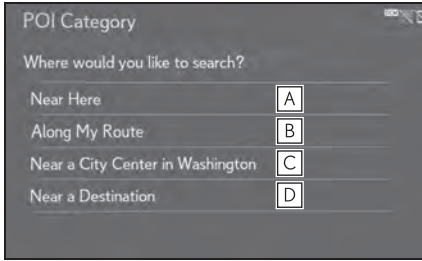

6 Select the desired POI category.

7 Select the desired POI.

► **Searching by phone number (D)**

4 Select "Phone #".

5 Enter a phone number and select "OK".

5 Select the desired search point.

A Select to search for POIs near your current position.

B Select to search for POIs along the set route.

C Select to search for POIs near a specific city center.

D Select to search for POIs near a destination. When more than 1 destination has been set, a list will be displayed on the screen. Select the desired destination.

Hands-free System For Cellular Phone

Registering/connecting a Bluetooth® device

To use the hands-free system, it is necessary to register a Bluetooth® phone with the system. Please refer to the cellular phone manufacturer's user guide for pairing procedures, or go to <http://www.lexus.com/MobileLink> to find approved Bluetooth® phones for this system.

- 1 Turn the Bluetooth® connection setting of your cellular phone on.
- 2 Press the "MENU" button on the Remote Touch.
Please refer to P.42 for the Remote Touch operation.
- 3 Select "Phone".
- 4 Select "Yes" to register a phone.

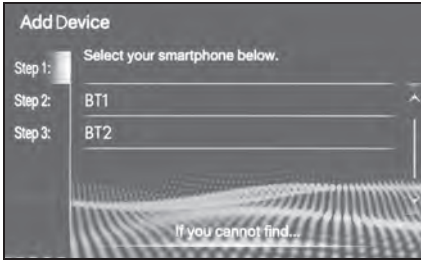

- 5 Select the desired Bluetooth® device.
- 6 Register the Bluetooth® device using your Bluetooth® device.
- 7 Check that the following screen is displayed, indicating pairing was successful.
- 8 Check that "Connected" is displayed and registration is complete.

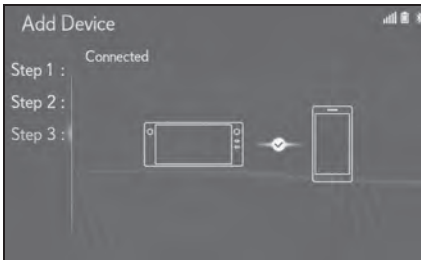

Contacts transfer

- 1 Press the "MENU" button on the Remote Touch.
Please refer to P.42 for the Remote Touch operation.
 - 2 Select "Setup".
 - 3 Select  "Phone" on the sub menu.
 - 4 Select "Contacts/Call History".
 - 5 Select "Transfer Contacts from Device".
 - 6 Select "From Phone (Bluetooth*)".
 - 7 Transfer the contact data to the system using a Bluetooth® phone.
 - 8 Check that a confirmation screen is displayed when the operation is complete.
- *: The Bluetooth® word mark and logos are registered trademarks owned by Bluetooth SIG, Inc.

Contacts transfer may not be possible depending on the type of phone.



Registering the contacts in the favorites list

- 1 Press the "MENU" button on the Remote Touch.
Please refer to P.42 for the Remote Touch operation.
- 2 Select "Setup".
- 3 Select  "Phone" on the sub menu.
- 4 Select "Contacts/Call History".
- 5 Select "Add Favorite".
- 6 Select the desired contact to add to the favorites list.
- 7 Check that a confirmation screen is displayed when the operation is complete.

Calling by favorites list

- 1 Press the "MENU" button on the Remote Touch.
Please refer to P.42 for the Remote Touch operation.
- 2 Select "Phone".
- 3 Select  "Favorites" on the sub menu and select the desired contact.
- 4 Select the desired number.
- 5 Check that the dialing screen is displayed.

Calling the message sender

- 1 Press the "MENU" button on the Remote Touch.
Please refer to P.42 for the Remote Touch operation.
- 2 Select "Phone".
- 3 Select  "Message" on the sub menu.
- 4 Select a desired account name that is displayed on the left side of screen.
- 5 Select the desired message from the list.
- 6 Select , or press the  switch on the steering wheel.
- 7 Check that the dialing screen is displayed.

Receiving a call

- 1 Select "Answer"/ or press the  switch on the steering wheel to talk on the phone.

► Main display

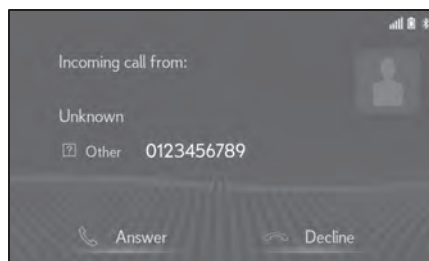

► Side display (vehicles with a 10.3-inch display)

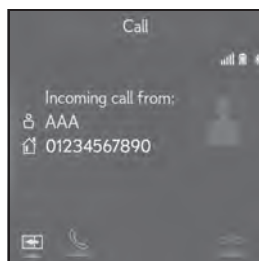

"Decline"/: Select to refuse to receive the call.

Steering switches

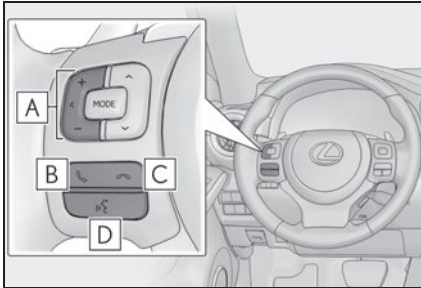

- A** Volume control switch
- Press the “+” side to increase the volume.
 - Press the “-” side to decrease the volume.
- B** Off hook switch
- Press to start talking.
 - Press to put a call on hold.
 - Depending on the system, if the switch is pressed when an Apple CarPlay connection is established, the Apple CarPlay phone application will be displayed on the system screen.*
- C** On hook switch
- Press to end talking/dialing.
 - Press to refuse to receive the call.
- D** Talk switch
- Press the talk switch to start the voice command system.
 - To cancel voice recognition, press and hold the talk switch.
- *: This function is not available in some countries or areas.

Audio System

Audio control screen

Follow the procedure below to display the audio control screen.

▶ **Using the audio control switch**

Press the "RADIO" or "MEDIA" button.

▶ **Using the Remote Touch**

Press the "MENU" button on the Remote Touch, then select "Audio".

Please refer to P.42 for the Remote Touch operation.

Selecting an audio source

▶ **Using the audio control switch**

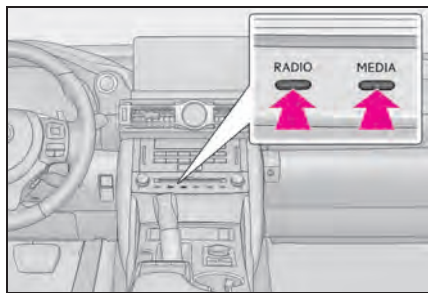

- 1 Press the "RADIO" or "MEDIA" button.

"RADIO" button: Press to change radio modes.

"MEDIA" button: Press to change media modes.

- Each time the "RADIO" or "MEDIA" button is pressed, the audio source changes.

▶ **From the audio source selection screen**

- 1 Display the audio control screen.
- 2 Select  "Source" on the sub menu.
- 3 Select the desired source.

Steering switch operation

Some parts of the audio/visual system can be adjusted using the switches on the steering wheel.

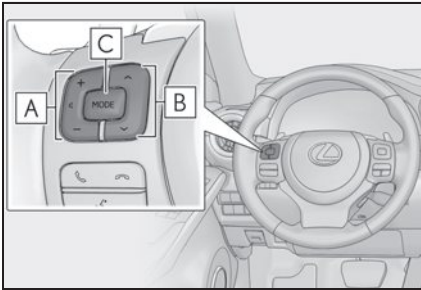

- A** Increases/decreases volume
- B** AM, FM mode: Selects a radio station
SXM mode: Selects a channel
Audio CD mode: Selects a track
MP3/WMA/AAC disc mode: Selects a file
DVD mode: Selects a chapter
USB mode: Selects a file/track
iPod/iPhone (Apple CarPlay)* mode: Selects a track
Android Auto mode: Selects a track
Bluetooth® audio mode: Selects a track
- C** Press: Change audio modes
Press and hold: Mute/unmute or pause/resume the current operation

*: This function is not available in some countries or areas.

Radio

Audio control switch

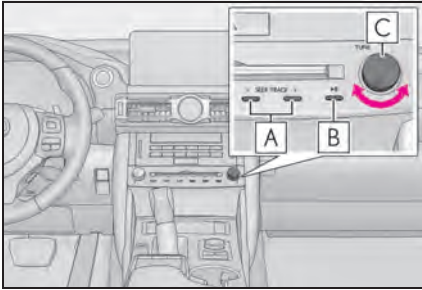

- A** Press to seek up/down.
Press and hold for continuous seek.
- B** Press to turn mute on/off.
Cache radio only: Press to play/pause.
- C** Turn to step up/down frequencies/
channels.

Control screen

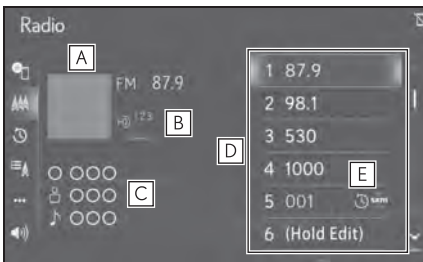

- A** Displays cover art
- B** Select to display HD) multicast channels available
- C** Displays the artist info and song title or album and genre
- D** Select to tune to preset stations/channels
- E** Display items on the channels registered to smart favorites

Presetting a station

- 1** Tune in the desired station.
- 2** Select and hold "(Hold Edit)".

■ Audio control switch

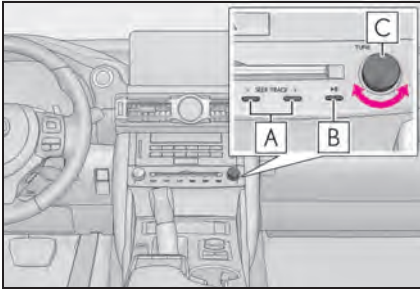

- A** Press to select a track/file.
Press and hold to fast forward/rewind.
- B** Press to pause/play.
- C** Turn to select a track/file.

■ Control screen

▶ Audio CD

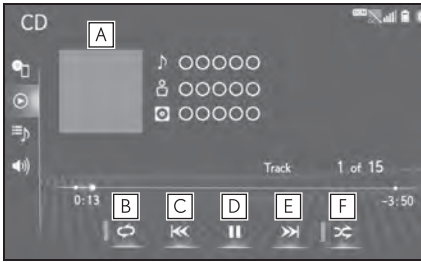

- A** Displays cover art
- B** Select to set repeat playback
- C** Select to change the track.
Select and hold to fast rewind.
- D** Select to play/pause.
- E** Select to change the track.
Select and hold to fast forward.
- F** Select to set random playback

▶ MP3/WMA/AAC disc

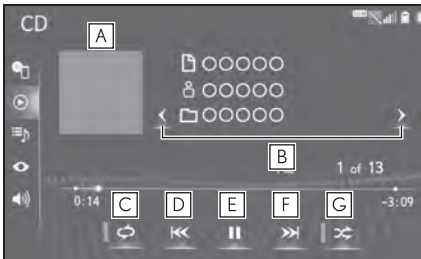

- A** Displays cover art
- B** Select to change the folder
- C** Select to set repeat playback
- D** Select to change the file.
Select and hold to fast rewind.
- E** Select to play/pause.
- F** Select to change the file.
Select and hold to fast forward.
- G** Select to set random playback

Audio control switch

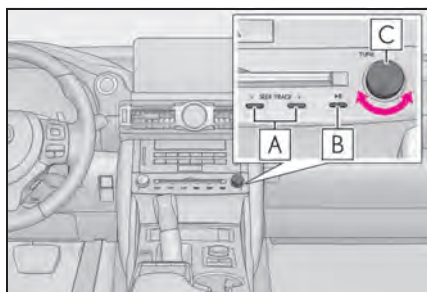

- A** Press to select a chapter.
Press and hold to fast forward/rewind.
- B** Press to pause/play.
- C** Turn to select a chapter.

Control screen

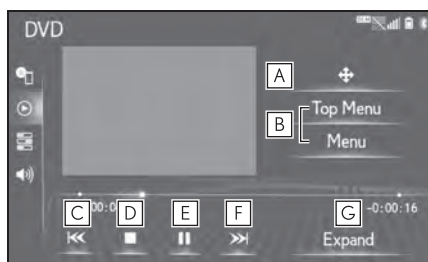

- A** Select to display the menu control key
- B** Select to display the menu screen
- C** Select to change the chapter.
Select and hold to fast rewind.
- D** Select to stop the video screen.
- E** Select to play/pause.
- F** Select to change the chapter.
 - During playback: Select and hold to fast forward.
 - During a pause: Select and hold to slow forward.
- G** Select to display expanded screen video

iPod/iPhone (Apple CarPlay)*

*: This function is not available in some countries or areas.

■ Audio control switch

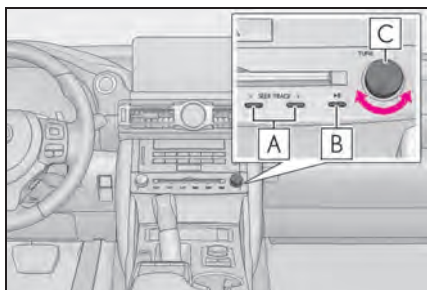

- A** Press to select a track.
Press and hold to fast forward/rewind.
- B** Press to pause/play.
- C** Turn to select a track.*

*: If equipped

■ Control screen

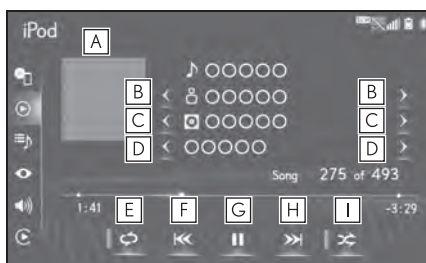

- A** Displays cover art
- B** Select to change the artist.*
- C** Select to change the album.*
- D** Select to change the playlist.*
- E** Select to set repeat playback.
- F** Select to change the track.
Select and hold to fast rewind.
- G** Select to play/pause.
- H** Select to change the track.
Select and hold to fast forward.
- I** Select to set random playback.

*: When an Apple CarPlay connection is established, this switch will not be displayed.

Automatic Air Conditioning System

Air outlets and fan speed are automatically adjusted according to the temperature setting.

Press the “MENU” button on the Remote Touch, then select  to display the air conditioning control screen. For information regarding Remote Touch, →P.42.

Vehicles with a 10.3-inch display: The air conditioning system can be displayed and operated on the side display.

Air conditioning controls

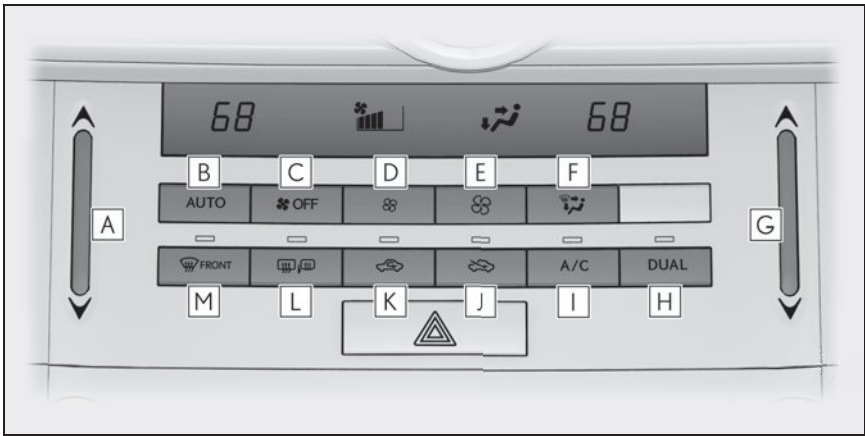

- A** Left-hand side temperature control switch
- B** Automatic mode switch
- C** OFF switch
- D** Fan speed decreases switch
- E** Fan speed increases switch
- F** Air flow mode switch
- G** Right-hand side temperature control switch
- H** DUAL switch
- I** A/C switch
- J** Outside air mode switch
- K** Recirculated air mode switch
- L** Rear window defogger and outside rear view mirror defoggers switch
- M** Windshield defogger switch

Air conditioning control screen

Main control screen

Using the touchpad of the Remote Touch, select the button on the screen.

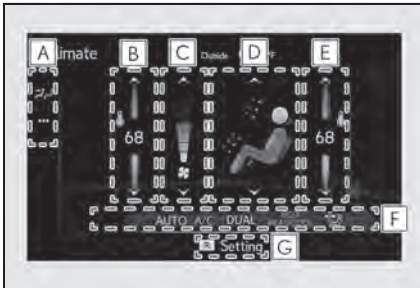

- A** Sub menu
- B** Adjust the left side seat temperature setting
- C** Adjust the fan speed setting
- D** Select the air flow mode
- E** Adjust the right side seat temperature setting
- F** Function on/off indicators
- G** Sub function menu

Option control screen

Select  on the sub menu to display the option control screen.

The functions can be switched on and off.

When the function is on, the indicator illuminates on the screen.

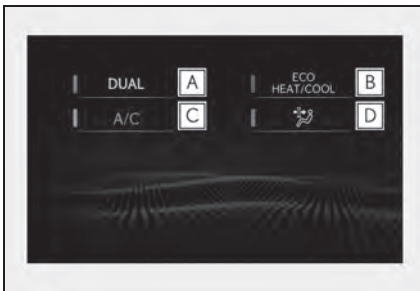

- A** Adjusting the temperature for driver and passenger seats separately ("DUAL" mode)
- B** Set eco air conditioning mode
- C** Cooling and dehumidification function
- D** Removing pollen from the air (Micro dust and pollen filter)

■ Side display (vehicles with a 10.3-inch display)

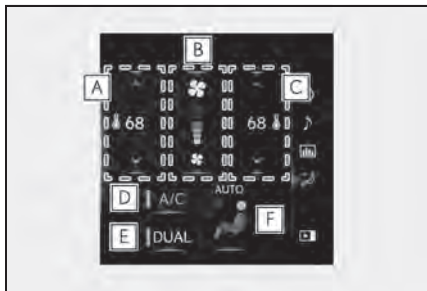

- A** Adjust the left side seat temperature setting
- B** Adjust the fan speed setting
- C** Adjust the right side seat temperature setting
- D** Set cooling and dehumidification function on/off
- E** Adjusting the temperature for driver and passenger seats separately ("DUAL" mode)
- F** Select the air flow mode

Using automatic mode

- 1** Press the automatic mode switch or select "AUTO" on the sub function menu.
- 2** Adjust the temperature setting.
- 3** To stop the operation, press the off switch or select "OFF" on the sub function menu.

Voice Command System

Basic operation

NOTE: Wait for the confirmation beep before speaking a command.

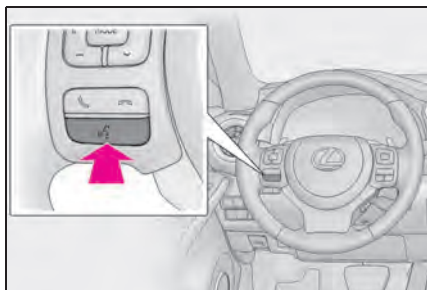

- 1** Press the talk switch on the steering wheel.

Voice guidance for the voice command system can be skipped by pressing the talk switch.

- 2** If “Getting Started with Voice” screen is displayed, select “OK” or press the talk switch.
- 3** After hearing a beep, say a supported command.
 - To display sample commands of the desired function, say the desired function or select the desired function button. To display more commands, select “More Commands”.
 - Selecting “Help” or saying “Help” prompts the voice command system to offer examples of commands and operation methods.

Continue on to pages 65-70 for a detailed list of Voice Commands for the following categories:

Common	P.65
Top menu	P.65
Navigation	P.66
Phone	P.67
Radio	P.68
Audio	P.68
Info	P.69
Apps	P.69
Climate	P.70

■ Important voice commands information and tips

- Voice commands can be used while driving.
- You must wait until after the beep to say a command.
- If you know what command to use, you can press the talk switch at any time to interrupt the voice guidance.

Command list

■ Common

Command	Action
"Help"	Displays examples of some of the available commands
"Go Back"	Returns to the previous screen
"Cancel"	Cancels the voice command system
"Start over"	Returns to top menu screen
"Pause"	Temporarily pauses a voice session until it is resumed by pressing the talk switch again.

■ Top menu

Command	Action
"Show command examples for <menu>"	Displays the command list of the selected menu
"More Commands"	Displays more commonly used commands
"Voice Settings"	Displays Voice Setting screen
"Train my voice"	Displays Train Voice Recognition screen *

*: Vehicle must be parked

■ Navigation*1

Command	Action
"Get directions to <house #, street, city, state>"*2	Enables setting a destination by saying the address*3,4
"Find a <POI category/POI name>"	Displays a list of <POI category*5/POI name*6> near the current position
"Find a <POI> near my destination"	Displays a list of <POI> near the destination
"Find a <POI category> in a city"*2	Displays a list of <POI> in a specified city and state*4
"Go Home"	Displays the route to home
"Go to Favorite <1-10>"	Sets the location registered to the corresponding favorite number as the destination
"Show Recent Destinations"	Displays recent destinations. Selecting a number from the list will start navigation to the selected recent destination.
"Cancel Route"	Cancels the route guidance
"Delete destinations"	Displays a list of destination to delete*7
"Show <POI category> icons"	Displays the specified point of interest category*5 icons on the map
"Destination Assist"	Connects the system to the Lexus response center

*1: With navigation function

*2: English and French only

*3: Best recognition results occur when saying the full address without the zipcode

*4: When the language is set to French, the supported area is only Quebec Province in Canada

*5: For example; "Gas stations", "Restaurants", etc.

*6: Major national brands are always supported. Local brands are also supported with a subscription to the Lexus Enform. Contact your Lexus dealer for details.

*7: Used when multiple destinations are set on a route

■ Phone

Command	Action
"Call <contact>"*	Places a call to the specified contact from the phone book
"Call <contact> <phonetype>"*	Places a call to the specified phone type of the contact from the phone book
"Dial <phone number>"	Places a call to the specified phone number
"Redial"	Places a call to the phone number of the latest outgoing call
"Call Back"	Places a call to the phone number of latest incoming call
"Show Recent Calls"	Displays the call history screen
"Send a message to <contacts>"	Sends a text message to specified contact from the phone book

*: If the system does not recognize the name of a contact, create a voice tag. The name of a contact can also be recognized by adding a voice tag.

■ While in a phone call

Command	Action
"Send <digits>"	Sends DTMF tones has specified
"Mute"	Mutes the microphone (far side cannot hear the conversation)
"Unmute"	Unmutes the microphone

■ While incoming message notification is displayed*

Command	Action
"Read Message"	Reads the incoming message over the vehicle speakers
"Ignore"	Ignores the incoming message notification
"Reply"	Initiates sending a reply to the incoming message
"Call"	Places a call to the phone number of incoming message

*: Full screen message notification must be turned on within the phone settings

■ Radio

Command	Action
"Tune to <frequency> AM"	Changes the radio to the specified AM frequency
"Tune to <frequency> FM"	Changes the radio to the specified FM frequency
"Play a <genre> station"	Changes the radio to an FM station of the specified genre ^{*1}
"Tune to preset <1-36>"	Changes the radio to the specified preset radio station
"Tune to a <genre> satellite station"	Changes the radio to a satellite radio channel of the specified genre ^{*2}
"Tune to <satellite channel name>"	Changes the radio to the satellite radio channel with the specified name ^{*2}
"Tune to channel <number> on XM"	Changes the radio to a satellite radio channel of the specified number ^{*2}

*1: A station list must be built first using the radio screen

*2: Requires a satellite radio subscription

■ Audio*

Command	Action
"Play Playlist <name>"	Plays tracks from the selected playlist
"Play Artist <name>"	Plays tracks from the selected artist
"Play Song <name>"	Plays the selected track
"Play Album <name>"	Plays tracks from the selected album
"Play Genre <name>"	Plays tracks from the selected genre
"Play Composer <name>"	Plays tracks from the selected composer
"Play Podcast <name>"	Plays tracks from the selected podcast
"Play Audiobook <name>"	Plays tracks from the selected audiobook
"Audio On"	Turns the audio system on
"Audio Off"	Turns the audio system off
"Change the audio source to <source name>"	Sets the source to the specified audio mode

*: The audio device must be connected via a USB cable to use the functionality in this section

■ Info*1

Command	Action
"Get the Forecast"	Displays weather information
"Get the Forecast for <city>"*2	Displays weather for the specified city
"Show Traffic"	Displays traffic information
"Show Traffic near here"	Displays traffic information near your current location
"Get traffic along my route"	Displays traffic information along your current route
"Show Traffic on this street"	Displays traffic information along road you are currently driving on
"Show Traffic for saved route"	Displays traffic information for a saved route
"Show Predictive Traffic"	Displays the predictive traffic map

*1: With navigation function

*2: Only major US cities are supported by voice

■ Apps

Command	Action
"Launch <apps>"*	Activates the Lexus Enform App Suite 2.0 application

*: When an application is opened and is in full screen mode, pressing the talk switch will start the voice command system and commands for the currently displayed application will be available

■ Climate

Command	Action
"Turn the AC on/Turn the AC off"	Turns air conditioning system on or off
"Change the Fan speed to <#>"	Changes the set fan speed of the air conditioning system to <#>
"Set temperature to <#> degrees"	Changes the set temperature of the air conditioning system to <#> degrees*
"Increase Temperature/Decrease Temperature"	Increases or decreases the temperature of the air conditioning system
"Increase Fan speed/Decrease Fan Speed"	Increases or decreases the fan speed of the air conditioning system
"Show the front climate control screen"	Displays the screen to control the air conditioning or seat heating system

*: Only within the possible temperature range of the air conditioning system

USB/AUX Ports

There are 2 USB ports and an AUX port in the console box.

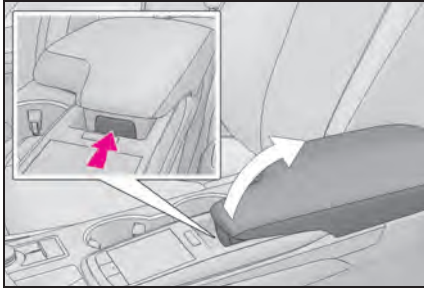

1 Push the knob.

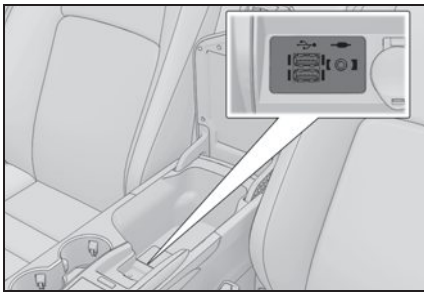

2 Connect a device.

Lexus Enform Safety Connect (if equipped)

Safety Connect is a subscription-based telematics service that uses Global Positioning System (GPS) data and embedded cellular technology to provide safety and security features to subscribers. Safety Connect is supported by Lexus' designated response center, which operates 24 hours per day, 7 days per week.

Safety Connect service is available by subscription on select, telematics hardware-equipped vehicles.

System components

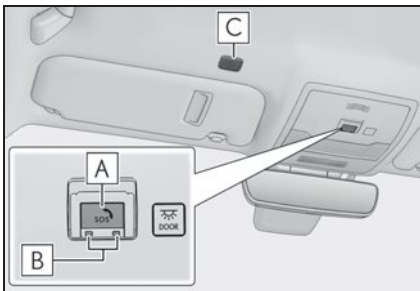

- A** "SOS" button
- B** LED light indicators
- C** Microphone

Services

Subscribers have the following Safety Connect services available:

- **Automatic Collision Notification**
In case of either airbag deployment or severe rear-end collision, the system is designed to automatically call the response center. The responding agent receives the vehicle's location and attempts to speak with the vehicle occupants to assess the level of emergency. If the occupants are unable to communicate, the agent automatically treats the call as an emergency, contacts the nearest emergency services provider to describe the situation, and requests that assistance be sent to the location.
- **Stolen Vehicle Location**
If your vehicle is stolen, Safety Connect can work with local authorities to assist them in locating and recovering the vehicle. After filing a police report, call the Safety Connect response center at 1-800-25-LEXUS (1-800-255-3987) in the United States, 1-877-539-8777 in Puerto Rico or 1-800-265-3987 in Canada, and follow the prompts for Safety Connect to initiate this service.
In addition to assisting law enforcement with recovery of a stolen vehicle, Safety-Connect-equipped vehicle location data may, under certain circumstances, be shared with third parties to locate your vehicle. Further information is available at Lexus.com.

- **Emergency Assistance Button (“SOS”)**
In the event of an emergency on the road, push the “SOS” button to reach the Safety Connect response center. The answering agent will determine your vehicle’s location, assess the emergency, and dispatch the necessary assistance required.
If you accidentally press the “SOS” button, tell the response-center agent that you are not experiencing an emergency.
- **Enhanced Roadside Assistance**
Enhanced Roadside Assistance adds GPS data to the already included warranty-based Lexus roadside service.
Subscribers can press the “SOS” button to reach a Safety Connect response-center agent, who can help with a wide range of needs, such as: towing, flat tire, fuel delivery, etc. For a description of the Roadside Assistance services and their limitations, please see the Safety Connect Terms and Conditions, which are available at Lexus.com.

Subscription

After you have signed the Telematics Subscription Service Agreement and are enrolled, you can begin receiving services.

A variety of subscription terms is available for purchase. Contact your Lexus dealer, call the following or push the “SOS” button in your vehicle for further subscription details.

- **The United States**
1-800-25-LEXUS (1-800-255-3987)
- **Canada**
1-800-26-LEXUS (1-800-265-3987)
- **Puerto Rico**
1-877-539-8777

Lexus Enform Remote (if equipped)

Lexus Enform Remote is a smartphone application that lets you view and remotely control certain aspects of your vehicle.

For details about the functions and services of this application, refer to <http://www.lexus.com/enform/>.

Function of the Lexus Enform Remote is achieved by using DCM (Data Communication Module).

Subscription

After you sign the Telematics Subscription Service Agreement, download the Lexus app from your smartphone's app store, and register within the app (or enroll and complete registration at the dealer), you can begin using these services.

A variety of subscription terms are available. Contact your Lexus dealer, or call 1-800-25-LEXUS (1-800-255-3987) for further subscription details.

Lexus Enform Service Connect (if equipped)

Lexus Enform Service Connect uses DCM (Data Communication Module) to collect and transmit vehicle data that allows Lexus to provide:

- Vehicle Health Report (VHR) (Safety Recalls, Service Campaigns, Current Vehicle Alerts, Required Maintenance, and Vehicle Condition Status)
- Maintenance Notifications
- Vehicle Alert Notifications

For details about this service and how to register, refer to <http://www.lexus.com/enform/>.

The Lexus Enform Service Connect is achieved by using a DCM (Data Communication Module) built in the vehicle.

SiriusXM Satellite Radio

A SiriusXM Satellite Radio is a tuner designed exclusively to receive broadcasts provided under a separate subscription.

For details, refer to “NAVIGATION AND MULTIMEDIA SYSTEM OWNER’S MANUAL”.

Subscription

For SiriusXM Services requiring a subscription (such as SiriusXM Satellite Radio), the following paragraph shall be included.

Required SiriusXM Radio monthly subscriptions sold separately after trial period. Subscription fee is consumer only. All fees and programming subject to change.

For more information, program schedules, and to subscribe or extend subscription after complimentary trial period; more information is available at:

► **U.S.A. Customers:**

Visit www.siriusxm.com or call 1-877-447-0011

► **Canadian Customers:**

Visit www.siriusxm.ca or call 1-877-438-9677

Door Locks

The vehicle can be locked and unlocked using the entry function, wireless remote control or door lock switches.

For details about the entry function or wireless remote control, refer to P.12, 14.

Unlocking and locking the doors from the inside

■ Door lock switches (to lock/unlock)

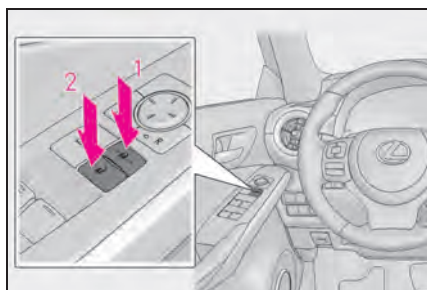

- 1** Locks all the doors
- 2** Unlocks all the doors

■ Inside lock buttons (to lock/unlock)

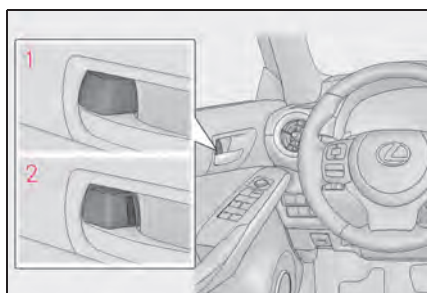

- 1** Locks the door
- 2** Unlocks the door

The front doors can be opened by pulling the inside handle even if the lock buttons are in the lock position.

Rear door child-protector lock

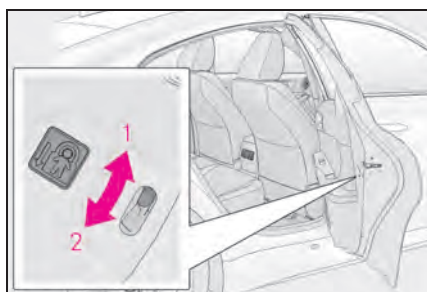

The door cannot be opened from inside the vehicle when the lock is set.

- 1** Unlock
- 2** Lock

These locks can be set to prevent children from opening the rear doors. Push down on each rear door switch to lock both rear doors.

Power Windows

Opening and closing the power windows

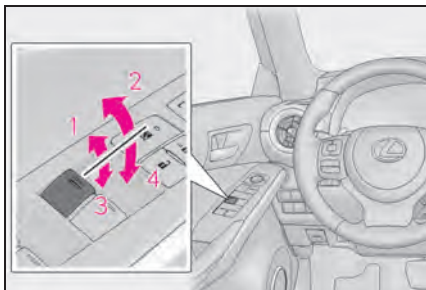

- 1 Closing
- 2 One-touch closing*
- 3 Opening
- 4 One-touch opening*

*: To stop the window partway, operate the switch in the opposite direction.

Preventing accidental operation (window lock switch)

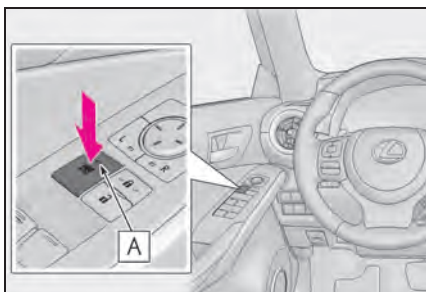

Press the switch to lock the passenger window switches.

The indicator **A** will come on.

Use this switch to prevent children from accidentally opening or closing a passenger window.

Moon Roof (if equipped)

Operating the moon roof

■ Opening and closing



1 Opens the moon roof*

The moon roof stops slightly before the fully open position to reduce wind noise.

Press the switch again to fully open the moon roof.

2 Closes the moon roof*

*: Lightly press either way of the moon roof switch to stop the moon roof partway.

■ Tilting up and down



1 Tilts the moon roof up*

2 Tilts the moon roof down*

*: Lightly press either way of the moon roof switch to stop the moon roof partway.

Fuel Tank Cap

Before refueling the vehicle

- Close all the doors and windows, and turn the engine switch off.
- Confirm the type of fuel.

Opening the fuel tank cap



- 1** With the doors unlocked, press the center of the rear edge of the fuel filler door.

Push until you hear a click and take your hand away to slightly open the fuel filler door. Then open the door fully by hand.

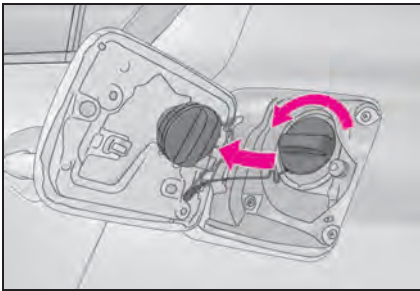

- 2** Turn the fuel tank cap slowly to remove it and put it into the holder on the fuel filler door.

Trunk

Opening the trunk

■ Trunk opener switch

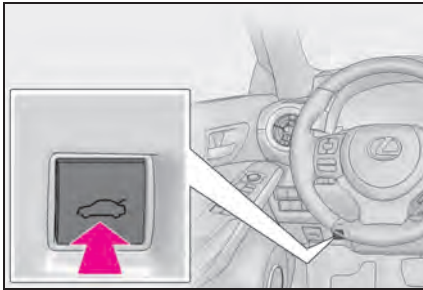

Press the trunk opener switch.

■ Smart access system with push-button start

→P.14

■ Wireless remote control

→P.12

Luggage security system

To protect luggage stored in the trunk against theft, the luggage security system can be set on.

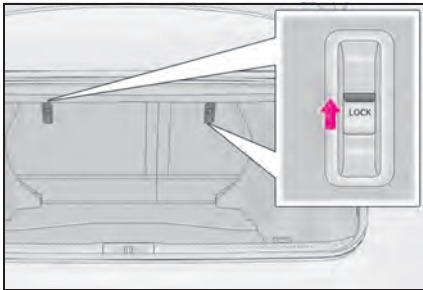

1 Move the luggage security system levers to the lock position.

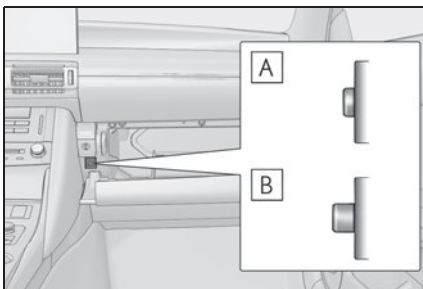

2 To disable the trunk opener, turn the main switch in the glove box off.

A On

B Off

When the main switch is off, the trunk lid cannot be opened even with the wireless remote control or entry function.

Garage Door Opener (if equipped)

The garage door opener can be programmed to operate garage doors, gates, entry doors, door locks, home lighting systems, security systems, and other devices.

System components

The HomeLink® wireless control system in your vehicle has 3 buttons which can be programmed to operate 3 different devices. Refer to the programming methods on the following pages to determine the method which is appropriate for the device.

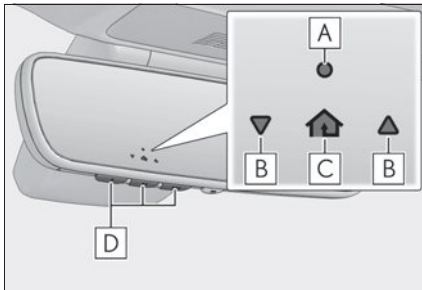

A HomeLink® indicator light

B Garage door operation indicators

C HomeLink® icon

Illuminates while HomeLink® is operating.

D Buttons

■ Before programming HomeLink®

- During programming, it is possible that garage doors, gates, or other devices may operate. For this reason, make sure that people and objects are clear of the garage door or other devices to prevent injury or other potential harm.
- It is recommended that a new battery be placed in the remote control transmitter for more accurate programming.
- Garage door opener motors manufactured after 1995 may be equipped with rolling code protection. If this is the case, you may need a stepladder or other sturdy, safe device to reach the “Learn” or “Smart” button on the garage door opener motor.

■ HomeLink® programming procedure

The programming procedures can also be found at the following URL.

Website: www.homelink.com/lexus



For support, contact customer support at the following.

Help Line: 1-800-355-3515

■ Programming HomeLink®

Steps **1** through **3** must be performed within 60 seconds, otherwise the indicator light will stop flashing and programming will not be able to be completed.

- 1** Press and release the HomeLink® button you want to program and check that the HomeLink® indicator light flashes (orange).

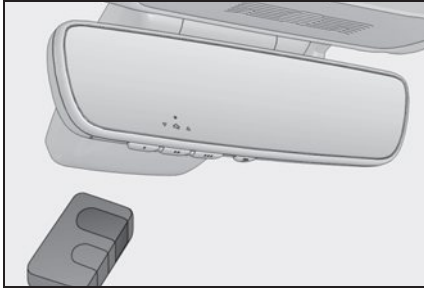

- 2** Point the remote control transmitter for the device at the rear view mirror, 1 to 3 in. (25 to 75 mm) from the HomeLink® buttons.

Keep the HomeLink® indicator light in view while programming.

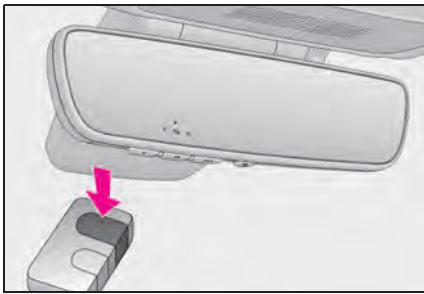

- 3** Program a device.

▶ Programming a device other than an entry gate (for U.S.A. owners)

Press and hold the handheld transmitter button until the HomeLink® indicator light changes from slowly flashing orange to rapidly flashing green (rolling code) or continuously lit green (fixed code), then release the button.

▶ Programming an entry gate (for U.S.A. owners)/Programming a device in the Canadian market

Press and release the remote control transmitter button at 2 second intervals, repeatedly, until the HomeLink® indicator light changes from slowly flashing (orange) to rapidly flashing (green) (rolling code) or continuously lit (green) (fixed code).

- 4** Test the HomeLink® operation by pressing the newly programmed button and observing the indicator light:
 - Indicator light illuminates: Programming of a fixed code device has completed. The garage door or other device should operate when a HomeLink® button is pressed and released.
 - Indicator light flashes rapidly: The garage door opener motor or other device is equipped with a rolling code. To complete programming, firmly press and hold the HomeLink® button for 2 seconds then release it.

- If the garage door or other device does not operate, proceed to “Programming a rolling code system”.

- 5 Repeat the steps above to program another device for any of the remaining HomeLink® buttons.

■ Programming a rolling code system

2 or more people may be necessary to complete rolling code programming.

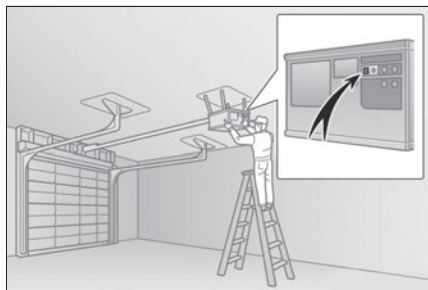

- 1 Locate the “Learn” or “Smart” button on the garage door opener motor in the garage.

This button can usually be found where the hanging antenna wire is attached to the unit. The name and color of the button may vary by manufacturer. Refer to the owner’s manual supplied with the garage door opener motor for details.

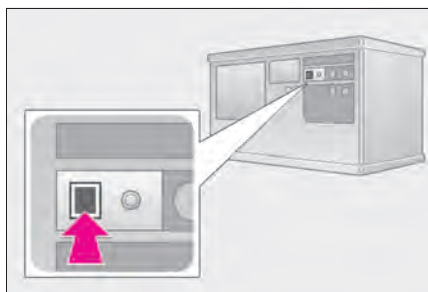

- 2 Press and release the “Learn” or “Smart” button.

Perform **3** within 30 seconds after performing **2**.



- 3 Press and hold the desired HomeLink® button (inside the vehicle) for 2 seconds and release it. Repeat this sequence (press/hold/release) up to 3 times to complete programming.

If the garage door opener motor operates when the HomeLink® button is pressed, the garage door opener motor recognizes the HomeLink® signal.

■ Enabling 2-way communication with a garage door (only available for compatible devices)

When enabled, 2-way communication allows you to check the status of the opening and closing of a garage door through indicators in your vehicle.

2-way communication is only available if the garage door opener motor used is a compatible device. (To check device compatibility, refer to www.homelink.com.)

- 1 Within 5 seconds after programming the garage door opener has been completed, if the garage door opener motor is trained to HomeLink[®], both garage door operation indicators will flash rapidly (green) and the light on the garage door opener motor will blink twice, indicating that 2-way communication is enabled.

If the indicators do not flash, perform **2** and **3** within the first 10 presses of the HomeLink[®] button after programming has been completed.

- 2 Press a programmed HomeLink[®] button to operate a garage door.
- 3 Within 1 minute of pressing the HomeLink[®] button, after the garage door operation has stopped, press the “Learn” or “Smart” button on the garage door opener motor. Within 5 seconds of the establishment of 2-way communication with the garage door opener, both garage door operation indicators in the vehicle will flash rapidly (green) and the light on the garage door opener motor will blink twice, indicating that 2-way communication is enabled.

■ Reprogramming a single HomeLink[®] button

When the following procedure is performed, buttons which already have devices registered to them can be overwritten:

- 1 With one hand, press and hold the desired HomeLink[®] button.
- 2 When the HomeLink[®] indicator starts flashing (orange), continue to hold the HomeLink[®] button and perform “Programming HomeLink[®]” **1** (it takes 20 seconds for the HomeLink[®] indicator to start flashing).

Operating HomeLink[®]

Press the appropriate HomeLink[®] button. The HomeLink[®] indicator light should turn on.

What to do if...

List of Warning/Indicator Lights

Immediately stop the vehicle in a safe place and contact your Lexus dealer. Continuing to drive the vehicle may be dangerous.

BRAKE

(U.S.A.)

Brake system
warning light



(Canada)

(red)

Immediately stop the vehicle in a safe place and contact your Lexus dealer.



Charging system warning light



(U.S.A.)

Malfunction
indicator lamp



Low engine oil pressure
warning light



(Canada)

Have the vehicle inspected by your Lexus dealer immediately.



(yellow)

Brake system warning light



(Blinking
and then
continuously
on)

Tire pressure warning light



SRS warning light



(flashes)

Intuitive parking assist OFF
indicator (if equipped)



(U.S.A.)

ABS warning light



(flashes)

RCTA OFF indicator



(Canada)



(flashes)

PKSB OFF indicator
(if equipped)



Brake Override System
warning light/Drive-Start
Control warning light



(flashes or
illuminates)

PCS warning light



(red or
yellow)

Electric power steering
system warning light



Slip indicator



(flashes)

Brake hold operated indicator

For further information, refer to the "OWNER'S MANUAL".

What to do if...

Follow the correction procedures.



Brake Override System warning light/Drive-Start Control warning light



Low fuel level warning light



Driver's and front passenger's seat belt reminder light



Rear passengers' seat belt reminder light



(Illuminates without blinking)

Tire pressure warning light*¹



(orange)

LTA indicator



(flashes)

Intuitive parking assist OFF indicator (if equipped)



(flashes)

RCTA OFF indicator



(flashes)

PKSB OFF indicator (if equipped)



(flashes or illuminates)

PCS warning light



(flashes)

(U.S.A.)

Parking brake indicator



(flashes)

(Canada)

Stop and check.



High coolant temperature warning light

For further information, refer to the "OWNER'S MANUAL".

What to do if...

See the "OWNER'S MANUAL"



Turn signal indicator



Headlight indicator (U.S.A.)



Tail light indicator (Canada)



Headlight high beam indicator



Automatic High Beam indicator



PCS warning light



Cruise control indicator



Dynamic radar cruise control indicator



Cruise control "SET" indicator



LTA indicator



BSM outside rear view mirror indicators



BSM OFF indicator



Intuitive parking assist OFF indicator (if equipped)



RCTA OFF indicator



PKSB OFF indicator (if equipped)



Slip indicator



VSC OFF indicator



Smart access system with push-button start indicator



(U.S.A.)

Parking brake indicator



(Canada)



Brake hold standby indicator



Brake hold operated indicator



Eco Driving Indicator Light



Snow mode indicator



Low outside temperature indicator

For further information, refer to the "OWNER'S MANUAL".

What to do if...

See the "OWNER'S MANUAL"



Security indicator



(U.S.A.)



(Canada)

"AIR BAG ON/
OFF" indicator

- Drive mode indicators

▶ Except F SPORT models



Eco drive mode indicator



Custom mode indicator
(if equipped)



Sport mode indicator
(if equipped)



SPORT S mode indicator
(if equipped)



Sport S+ mode indicator
(if equipped)

▶ F SPORT models



Custom mode indicator
(if equipped)



Eco drive mode indicator



Sport mode indicator
(if equipped)



Sport S mode indicator
(if equipped)



Sport S+ mode indicator
(if equipped)

For further information, refer to the "OWNER'S MANUAL".

*1: It also comes on due to natural causes such as natural air leaks and tire inflation pressure changes caused by temperature. Adjust the tire inflation pressure to the specified level. The light will turn off after a few minutes. In case the light does not turn off even if the tire inflation pressure is adjusted, have the system checked by your Lexus dealer.

*2: Depending on the operating condition, the color and illuminating/flashing state of the light change.

What to do if...

If the electronic key does not operate properly

Locking and unlocking the doors, unlocking the trunk

■ Doors

Use the mechanical key in order to perform the following operations:

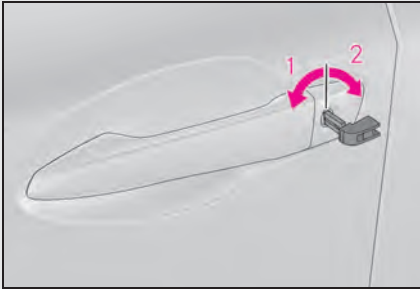

- 1** Locks all the doors
- 2** Unlocks the door

Turning the key rearward unlocks the driver's door. Turning the key once again within 5 seconds unlocks the other doors.

■ Trunk

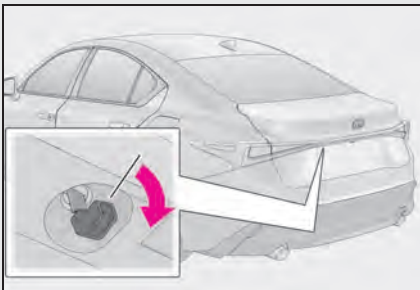

Turn the mechanical key clockwise to open.

What to do if...

Starting the engine

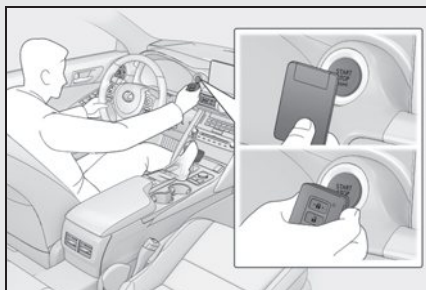

- 1 Ensure that the shift lever is in P and depress the brake pedal.
- 2 Touch the Lexus emblem side of the electronic key to the engine switch.

When the electronic key is detected, a buzzer sounds and the engine switch will turn to IGNITION ON mode.

When the smart access system with push-button start is deactivated in customization setting, the engine switch will turn to ACCESSORY mode.

- 3 Firmly depress the brake pedal and check that  is shown on the multi-information display.
- 4 Press the engine switch.

In the event that the engine still cannot be started, contact your Lexus dealer.

If the electronic key battery becomes depleted, a warning message will be shown on the multi-information display. Replace the battery with a new one. For instructions on replacing the battery, refer to the "OWNER'S MANUAL".

If you need further assistance, contact your Lexus dealer.

What to do if...

If the engine doesn't start

Make sure that the correct operating procedures have been followed.

Brake pedal

Make sure that the brake pedal is firmly depressed when attempting to start the engine. (→P.15)

If the engine still does not start, see the "OWNER'S MANUAL" for more information or contact your Lexus dealer.

Memo

A large white rectangular area with horizontal lines, serving as a memo template. The lines are evenly spaced and extend across the width of the page, providing a guide for writing.



Your Lexus dealer

Your Lexus dealer will provide quality maintenance and any other assistance you may require.

If there is not a Lexus dealer near you, please call the following number:

■ U.S. OWNERS

- In the U.S. mainland or Canada:

Lexus Roadside Assistance

1-800-25-LEXUS or 1-800-255-3987 (Toll-Free)

- In Hawaii:

Servco Automotive Roadside Assistance/Customer Services

1-800-25-LEXUS or 1-800-255-3987 (Toll-Free)

■ CANADIAN OWNERS

- In Canada or the U.S. mainland:

Lexus Roadside Assistance/Customer Service

1-800-26-LEXUS or 1-800-265-3987 (Toll-Free)

Please access our **websites** for further information.

- The U.S. mainland: **www.lexus.com**

- Hawaii: **www.servcolexus.com**

- Canada: **www.lexus.ca**

©2023 TOYOTA MOTOR CORPORATION

All rights reserved. This material may not be reproduced or copied, in whole or in part, without the written permission of Toyota Motor Corporation.



Owner's Manual Quick Guide:

Publication No. OM53G40U

Part No. 01999-53G40

Printed in Japan 01-2310-00 ©

IS500 / IS350 AWD / IS350 / IS300 AWD / IS300

Owner's Manual Quick Guide (北米U)