

2023 FORD RANGER Owner's Manual



The information contained in this publication was correct at the time of release. In the interest of continuous development, we reserve the right to change specifications, design or equipment at any time without notice or obligation. No part of this publication may be reproduced, transmitted, stored in a retrieval system or translated into any language in any form by any means without our written permission. Errors and omissions excepted.

© Ford Motor Company 2022

All rights reserved.

Part Number: -202208-20220809205642

California Proposition 65



WARNING: Operating, servicing and maintaining a passenger vehicle or off-highway motor vehicle can expose you to chemicals including engine exhaust, carbon monoxide, phthalates, and lead, which are known to the State of California to cause cancer and birth defects or other reproductive harm. To minimize exposure, avoid breathing exhaust, do not idle the engine except as necessary, service your vehicle in a well-ventilated area and wear gloves or wash your hands frequently when servicing your vehicle. For more information go to www.P65Warnings.ca.gov/passenger-vehicle.



WARNING: Battery posts, terminals and related accessories contain lead and lead compounds, chemicals known to the State of California to cause cancer and reproductive harm.
Wash your hands after handling.

Table of Contents

Introduction

About This Manual	7
Symbols Glossary	7
Perchlorate	10
Replacement Parts Recommendation	10
Special Notices	10
Mobile Communications Equipment	11

Environment

Protecting the Environment	13
----------------------------------	----

Data Privacy

Data Privacy	14
Service Data	15
Event Data	15
Settings Data	16
Connected Vehicle Data	16
Mobile Device Data	17
Emergency Call System Data	17

At a Glance

Instrument Panel	18
------------------------	----

Child Safety

General Information	20
Installing Child Restraints	22
Booster Seats	29
Child Restraint Positioning	31
Child Safety Locks	32

Seatbelts

Principle of Operation	34
Fastening the Seatbelts	35
Seatbelt Height Adjustment	37
Seatbelt Reminder	37
Child Restraint and Seatbelt Maintenance	39
Seatbelt Extensions	39

Personal Safety System™

Personal Safety System™	40
-------------------------------	----

Supplementary Restraints System

Principle of Operation	41
Driver and Passenger Airbags	42
Front Passenger Sensing System	43
Side Airbags	45
Safety Canopy™	46
Crash Sensors and Airbag Indicator	48
Airbag Disposal	49

911 Assist

What Is 911 Assist	50
Emergency Call Requirements	50
Emergency Call Limitations	51

Keys and Remote Controls

General Information on Radio Frequencies	52
Remote Control	52
Replacing a Lost Key or Remote Control	58
Passive Key Backup Position	58

MyKey™

Principle of Operation	59
Creating a MyKey	60
Clearing All MyKeys	61
Checking MyKey System Status	61
Using MyKey With Remote Start Systems	62
MyKey – Troubleshooting	62

Doors and Locks

Locking and Unlocking	64
-----------------------------	----

Tailgate

Tailgate Lock	68
---------------------	----

Table of Contents

Removing the Tailgate	68
-----------------------------	----

Security

Passive Anti-Theft System	70
Anti-Theft Alarm	70

Steering Wheel

Adjusting the Steering Wheel	72
Audio Control	72
Voice Control	73
Cruise Control	73
Information Display Control	74
Horn	74

Wipers and Washers

Windshield Wipers	75
Autowipers	75
Windshield Washers	76

Lighting

General Information	77
Lighting Control	77
Autolamps	78
Instrument Lighting Dimmer	78
Daytime Running Lamps	79
Automatic High Beam Control	79
Front Fog Lamps	80
Direction Indicators	81
Interior Lamps	81
Ambient Lighting	82
Cargo Lamps	82

Windows and Mirrors

Power Windows	83
Exterior Mirrors	86
Interior Mirror	87
Sun Visors	88

Instrument Cluster

Gauges	89
Warning Lamps and Indicators	92
Audible Warnings and Indicators	95

Information Displays

General Information	96
Information Messages	104

Climate Control

Manual Climate Control	117
Automatic Climate Control	118
Hints on Controlling the Interior Climate	120
Heated Rear Window	122
Heated Exterior Mirrors	122
Cabin Air Filter	122
Remote Start	123

Seats

Sitting in the Correct Position	124
Head Restraints	124
Manual Seats	126
Power Seats	127
Rear Seats	129
Heated Seats	130

Rear Occupant Alert System

What is the Rear Occupant Alert System	132
How Does the Rear Occupant Alert System Work	132
Rear Occupant Alert System Precautions	132
Rear Occupant Alert System Limitations	132
Switching Rear Occupant Alert System On and Off	132
Rear Occupant Alert System Indicators	133

Table of Contents

Rear Occupant Alert System Audible Warnings	133
---	-----

Garage Door Opener

Universal Garage Door Opener	134
------------------------------------	-----

Auxiliary Power Points

Auxiliary Power Points	138
------------------------------	-----

Storage Compartments

Glove Compartment	140
Center Console	140
Overhead Console	140
Rear Seat Armrest	141
Under Seat Storage	141

Starting and Stopping the Engine

General Information	142
Ignition Switch	142
Keyless Starting	143
Starting a Gasoline Engine	143
Engine Block Heater	146

Unique Driving Characteristics

Auto-Start-Stop	148
-----------------------	-----

Fuel and Refueling

Safety Precautions	150
Fuel Quality	150
Fuel Filler Funnel Location	151
Running Out of Fuel	151
Refueling	153
Fuel Consumption	155

Engine Emission Control

Emission Law	157
Catalytic Converter	158

Transmission

Automatic Transmission	161
------------------------------	-----

Four-Wheel Drive

Principle of Operation	165
Using Four-Wheel Drive	165

Rear Axle

Electronic Locking Differential	173
---------------------------------------	-----

Brakes

General Information	175
Hints on Driving With Anti-Lock Brakes	175
Parking Brake	176
Hill Start Assist	176

Traction Control

Principle of Operation	178
Using Traction Control	178

Stability Control

Principle of Operation	179
Using Stability Control	180

Terrain Control

Principle of Operation	182
------------------------------	-----

Trail Control

What Is Trail Control	184
Switching Trail Control On and Off	184
Setting the Trail Control Speed	184
Canceling the Set Speed	184
Trail Control Indicators	185
Trail Control – Troubleshooting	185

Parking Aids

Principle of Operation	186
Rear Parking Aid	187

Table of Contents

Front Parking Aid	187
Rear View Camera	188

Cruise Control

Principle of Operation	192
Using Cruise Control	192
Using Adaptive Cruise Control	193

Driving Aids

Driver Alert	200
Lane Keeping System	201
Blind Spot Information System	206
Cross Traffic Alert	209
Steering	213
Pre-Collision Assist	213

Load Carrying

Load Limit	218
Load Retaining Fixtures	222
Using a Slide-In Camper	223

Towing

Towing a Trailer	224
Trailer Sway Control	225
Recommended Towing Weights	225
Essential Towing Checks	226
Towing the Vehicle on Four Wheels	229

Driving Hints

Breaking-In	231
Economical Driving	231
Cold Weather Precautions	232
Off-Road Driving	232
Driving Through Water	233
Floor Mats	234

Roadside Emergencies

Roadside Assistance	235
Hazard Flashers	236

Jump Starting the Vehicle	236
Transporting the Vehicle	238
Towing Points	239

Crash and Breakdown Information

Automatic Crash Shutoff	241
-------------------------------	-----

Customer Assistance

Getting the Services You Need	242
In California (U.S. Only)	243
The Better Business Bureau (BBB) Auto Line Program (U.S. Only)	244
Utilizing the Mediation/Arbitration Program (Canada Only)	245
Getting Assistance Outside the U.S. and Canada	245
Ordering Additional Owner's Literature	247
Reporting Safety Defects (U.S. Only)	247
Reporting Safety Defects (Canada Only)	247

Fuses

Fuse Box Locations	249
Fuse Specification Chart	250
Changing a Fuse	261

Maintenance

General Information	263
Opening and Closing the Hood	264
Under Hood Overview	265
Engine Oil Dipstick	266
Engine Oil Check	266
Changing the Engine Air Filter	267
Oil Change Indicator Reset	268
Engine Coolant Check	269
Automatic Transmission Fluid Check	273
Brake Fluid Check	273

Table of Contents

Power Steering Fluid Check	274	Vehicle Certification Label	328
Fuel Filter	274	Transmission Code Designation	328
Charging the 12V Battery	274	Capacities and Specifications	329
Changing the 12V Battery	275	Bulb Specification Chart	335
Washer Fluid Check	277		
Checking the Wiper Blades	277	Connected Vehicle	
Changing the Wiper Blades	277	What Is a Connected Vehicle	337
Adjusting the Headlamps	278	Connected Vehicle Requirements	337
Removing a Headlamp	279	Connected Vehicle Limitations	337
Changing a Bulb	279	Connecting the Vehicle to a Mobile Network	337
		Connecting the Vehicle to a Wi-Fi Network - Vehicles With: SYNC 3	337
Vehicle Care		Connected Vehicle – Troubleshooting - Vehicles With: Modem	338
General Information	284	Connected Vehicle – Troubleshooting - Vehicles With: SYNC 3	339
Cleaning Products	284		
Cleaning the Exterior	285	Vehicle Wi-Fi Hotspot	
Waxing	286	Creating a Vehicle Wi-Fi Hotspot - Vehicles Without: SYNC	341
Cleaning the Engine	286	Creating a Vehicle Wi-Fi Hotspot - Vehicles With: SYNC 3	341
Cleaning the Windows and Wiper Blades	287	Changing the Vehicle Wi-Fi Hotspot Name or Password	342
Cleaning the Interior	287		
Cleaning the Instrument Panel and Instrument Cluster Lens	288	Audio System	
Cleaning Leather Seats	288	General Information	343
Repairing Minor Paint Damage	289	Audio Unit - Vehicles Without: SYNC	343
Cleaning the Wheels	289	Audio Unit - Vehicles With: SYNC	345
Vehicle Storage	289	Audio Unit - Vehicles With: SYNC 3	347
		Connecting a Bluetooth® Device - Vehicles With: AM/FM/USB/ Bluetooth, Vehicles Without: SYNC	348
Wheels and Tires		Radio	349
General Information	292	Satellite Radio	349
Tire Care	293	Digital Radio	351
Using Snow Chains	308	Audio Input Jack	353
Tire Pressure Monitoring System	309	USB Port	354
Changing a Road Wheel	313		
Technical Specifications	324		
Capacities and Specifications			
Engine Specifications	325		
Motorcraft Parts	326		
Vehicle Identification Number	327		

Table of Contents

Using Voice Recognition - Vehicles Without: SYNC	355
Media Hub	355

SYNC™

General Information	356
Using Voice Recognition	357
Using SYNC™ With Your Phone	359
SYNC™ Applications and Services	360
Using SYNC™ With Your Media Player	362
SYNC™ Troubleshooting	362

SYNC™ 3

General Information	372
Using Voice Recognition	374
Entertainment	380
Climate	382
Phone	385
Navigation	387
Apps	392
Settings	393
SYNC™ 3 Troubleshooting	395

Accessories

Accessories	408
Auxiliary Switches	409

Ford Protect

Ford Protect	414
--------------------	-----

Scheduled Maintenance

General Maintenance Information	416
Normal Scheduled Maintenance	419
Special Operating Conditions Scheduled Maintenance	422

Customer Information

Warranty Information	426
----------------------------	-----

Appendices

Electromagnetic Compatibility	428
End User License Agreement	431
Declaration of Conformity	456
Type Approvals	456

Introduction

ABOUT THIS MANUAL

Thank you for choosing Ford. We recommend that you take some time to get to know your vehicle by reading this manual. The more that you know about your vehicle, the greater the safety and pleasure you will get from driving it.



WARNING: Driving while distracted can result in loss of vehicle control, crash and injury. We strongly recommend that you use extreme caution when using any device that may take your focus off the road. Your primary responsibility is the safe operation of your vehicle. We recommend against the use of any hand-held device while driving and encourage the use of voice-operated systems when possible. Make sure you are aware of all applicable local laws that may affect the use of electronic devices while driving.

Note: This manual describes product features and options available throughout the range of available models, sometimes even before they are generally available. It may describe options not fitted to the vehicle you have purchased.

Note: Some of the illustrations in this manual may show features as used in different models, so may appear different to you on your vehicle.

Note: Always use and operate your vehicle in line with all applicable laws and regulations.

Note: Pass on this manual when selling your vehicle. It is an integral part of your vehicle.

This manual may qualify the location of a component as left-hand side or right-hand side. The side is determined when facing forward in the seat.

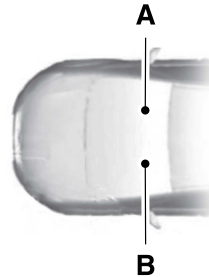

- A Right-hand side.
- B Left-hand side.

SYMBOLS GLOSSARY

These are some of the symbols you may see on your vehicle.



Airbag



Air conditioning system



Air conditioning system lubricant type



Anti-lock braking system



Avoid smoking, flames or sparks



Battery



Battery acid



Blower motor

Introduction



Brake fluid - non petroleum based



Brake system



Brake system



Cabin air filter



Check fuel cap



Child safety door lock or unlock



Child seat lower anchor



Child seat tether anchor



Cruise control



Do not open when hot



Electric Parking brake



Engine air filter



Engine coolant



Engine coolant temperature



Engine oil



Explosive gas



Fan warning



Fasten seatbelt



Flammable



Front fog lamps



Fuel pump reset



Fuse compartment



Hazard flashers



Headlamp high beams



Headlamps on



Heated rear window



Hill descent control



Horn control



Interior luggage compartment release



Jack

Introduction



Keep out of reach of children



Lighting control



Low fuel level



Low tire pressure warning



Maintain correct fluid level



Malfunction Indicator Lamp (MIL)



Note operating instructions



Panic alarm



Parking aid



Parking lamps



Passenger airbag activated



Passenger airbag deactivated



Power steering fluid



Power windows front/rear



Power window lockout



Requires registered technician



Safety alert



See Owner's Manual



See Service Manual



Side airbag



Shield the eyes



Stability control



Stability control off



Trail control



Turn Signal



Windshield defrosting system



Windshield wiping system



Windshield wash and wipe

Introduction

PERCHLORATE

Certain components in your vehicle such as airbag modules, seatbelt pretensioners and remote control batteries may contain perchlorate material. Special handling may apply for service or vehicle end of life disposal.

For more information visit:

Web Address
www.dtsc.ca.gov/hazardouswaste/perchlorate

REPLACEMENT PARTS RECOMMENDATION

We have built your vehicle to the highest standards using quality parts. We recommend that you demand the use of genuine Ford and Motorcraft parts whenever your vehicle requires scheduled maintenance or repair. You can clearly identify genuine Ford and Motorcraft parts by looking for the Ford, FoMoCo or Motorcraft branding on the parts or their packaging.

Scheduled Maintenance and Mechanical Repairs

One of the best ways for you to make sure that your vehicle provides years of service is to have it maintained in line with our recommendations using parts that conform to the specifications detailed in this Owner's Manual.

Genuine Ford and Motorcraft parts meet or exceed these specifications.

Collision Repairs

We hope that you never experience a collision, but accidents happen sometimes.

Genuine Ford replacement collision parts meet our stringent requirements for fit, finish, structural integrity, corrosion protection and dent resistance. During vehicle development we validate that these parts deliver the intended level of protection as a whole system. A great way to know for sure you are getting this level of protection is to use genuine Ford replacement collision parts.

Warranty on Replacement Parts

Genuine Ford and Motorcraft replacement parts are the only replacement parts that benefit from a Ford Warranty.

The Ford Warranty may not cover damage caused to your vehicle as a result of failed non-Ford parts.

For additional information, refer to the terms and conditions of the Ford Warranty.

SPECIAL NOTICES

New Vehicle Limited Warranty

For a detailed description of what is covered by your New Vehicle Limited Warranty, see your warranty guide that is available online. For more information, refer to our website and download your copy of the warranty guide.

Special Instructions

For your added safety, your vehicle is fitted with sophisticated electronic controls.



WARNING: You risk death or serious injury to yourself and others if you do not follow the instruction highlighted by the warning symbol. Failure to follow the specific warnings and instructions could result in personal injury.

Introduction



WARNING: NEVER use a rearward facing child restraint on a seat protected by an ACTIVE AIRBAG in front of it, DEATH or SERIOUS INJURY to the CHILD can occur.

On Board Diagnostics Data Link Connector



WARNING: Do not connect wireless plug-in devices to the data link connector. Unauthorized third parties could gain access to vehicle data and impair the performance of safety related systems. Only allow repair facilities that follow our service and repair instructions to connect their equipment to the data link connector.

Your vehicle has an OBD Data Link Connector (DLC) that is used in conjunction with a diagnostic scan tool for vehicle diagnostics, repairs and reprogramming services. Installing an aftermarket device that uses the DLC during normal driving for purposes such as remote insurance company monitoring, transmission of vehicle data to other devices or entities, or altering the performance of the vehicle, may cause interference with or even damage to vehicle systems. We do not recommend or endorse the use of unapproved aftermarket plug-in devices. The vehicle Warranty will not cover damage caused by an aftermarket plug-in device.

Notice to Owners of Pickup Trucks and Utility Type Vehicles



WARNING: Utility vehicles have a significantly higher rollover rate than other types of vehicles.

Before you drive your vehicle, please read this Owner's Guide carefully. Your vehicle is not a passenger car. As with other vehicles of this type, failure to operate this vehicle correctly may result in loss of vehicle control, vehicle rollover, personal injury or death.

Using Your Vehicle With a Snowplow

Do not use this vehicle for snowplowing.

Your vehicle does not have a snowplowing package.

Using Your Vehicle as an Ambulance

Do not use this vehicle as an ambulance.

Your vehicle does not have the Ambulance Preparation Package.

MOBILE COMMUNICATIONS EQUIPMENT



WARNING: Driving while distracted can result in loss of vehicle control, crash and injury. We strongly recommend that you use extreme caution when using any device that may take your focus off the road. Your primary responsibility is the safe operation of your vehicle. We recommend against the use of any hand-held device while driving and encourage the use of voice-operated systems when possible. Make sure you are aware of all applicable local laws that may affect the use of electronic devices while driving.

Introduction

Using mobile communications equipment is becoming increasingly important in the conduct of business and personal affairs. However, you must not compromise your own or others' safety when using such equipment. Mobile communications can enhance personal safety and security when appropriately used, particularly in emergency situations. Safety must be paramount when using mobile communications equipment to avoid negating these benefits. Mobile communication equipment includes, but is not limited to, cellular phones, pagers, portable email devices, text messaging devices and portable two-way radios.

Environment

PROTECTING THE ENVIRONMENT

You can take significant steps toward protecting the environment with correct vehicle usage and the authorized disposal of waste, cleaning and lubrication materials.

For additional information about our sustainability progress and initiatives, visit www.sustainability.ford.com.

Data Privacy



WARNING: Do not connect wireless plug-in devices to the data link connector. Unauthorized third parties could gain access to vehicle data and impair the performance of safety related systems. Only allow repair facilities that follow our service and repair instructions to connect their equipment to the data link connector.

We respect your privacy and are committed to protecting it. The information contained in this publication was correct at the time of release, but as technology rapidly changes, we recommend that you visit the local Ford website for the latest information.

Your vehicle has electronic control units that have data recording functionality and the ability to permanently or temporarily store data. This data could include information on the condition and status of your vehicle, vehicle maintenance requirements, events and malfunctions. The types of data that can be recorded are described in this section. Some of the data recorded is stored in event logs or error logs.

Note: *Error logs are reset following a service or repair.*

Note: *We may provide information in response to requests from law enforcement, other government authorities and third parties acting with lawful authority or through a legal process. Such information could be used by them in legal proceedings.*

Data recorded includes, for example:

- Operating states of system components, for example fuel level, tire pressure and battery charge level.
- Vehicle and component status, for example wheel speed, deceleration, lateral acceleration and seatbelt status.

- Events or errors in essential systems, for example headlamps and brakes.
- System responses to driving situations, for example airbag deployment and stability control.
- Environmental conditions, for example temperature.

Some of this data, when used in combination with other information, for example an accident report, damage to a vehicle or eyewitness statements, could be associated with a specific person.

Services That We Provide

If you use our services, we collect and use data, for example account information, vehicle location and driving characteristics, that could identify you. We transmit this data through a dedicated, protected connection. We only collect and use data to enable your use of our services to which you have subscribed, with your consent or where permitted by law. For additional information, see the terms and conditions of the services to which you have subscribed.

For additional information about our privacy policy, refer to the local Ford website.

Services That Third Parties Provide

We recommend that you review the terms and conditions and data privacy information for any services equipped with your vehicle or to which you subscribe. We take no responsibility for services that third parties provide.

Data Privacy

SERVICE DATA

Service data recorders in your vehicle are capable of collecting and storing diagnostic information about your vehicle. This potentially includes information about the performance or status of various systems and modules in the vehicle, such as engine, throttle, steering or brake systems. In order to properly diagnose and service your vehicle, Ford Motor Company (Ford of Canada in Canada), and service and repair facilities may access or share among them vehicle diagnostic information received through a direct connection to your vehicle when diagnosing or servicing your vehicle. Additionally, Ford Motor Company (Ford of Canada, in Canada) may, where permitted by law, use vehicle diagnostic information for vehicle improvement or with other information we may have about you, for example, your contact information, to offer you products or services that may interest you. Data may be provided to our service providers such as part suppliers that may help diagnose malfunctions, and who are similarly obligated to protect data. We retain this data only as long as necessary to perform these functions or to comply with law. We may provide information where required in response to official requests to law enforcement or other government authorities or third parties acting with lawful authority or court order, and such information may be used in legal proceedings. For U.S. only (if equipped), if you choose to use connected apps and services, you consent that certain diagnostic information may also be accessed electronically by Ford Motor Company and Ford authorized service facilities, and that the diagnostic information may be used to provide services to you, personalizing your experience, troubleshoot, and to improve products and services and offer you products and services that may interest

you, where permitted by law. For Canada only, for more information, please review the Ford of Canada privacy policy at www.ford.ca, including our U.S. data storage and use of service providers in other jurisdictions who may be subject to legal requirements in Canada, the United States and other countries applicable to them, for example, lawful requirements to disclose personal information to governmental authorities in those countries.

EVENT DATA

This vehicle is equipped with an event data recorder. The main purpose of an event data recorder is to record, in certain crash or near crash-like situations, such as an airbag deployment or hitting a road obstacle; this data will assist in understanding how a vehicle's systems performed. The event data recorder is designed to record data related to vehicle dynamics and safety systems for a short period of time, typically 30 seconds or less.

The event data recorder in this vehicle is designed to record such data as:

- How various systems in your vehicle were operating.
- Whether or not the driver and passenger seatbelts were buckled/fastened.
- How far (if at all) the driver was depressing the accelerator and/or the brake pedal.
- How fast the vehicle was traveling.
- Where the driver was positioning the steering wheel.

This data can help provide a better understanding of the circumstances in which crashes and injuries occur.

Data Privacy

Note: *Event data recorder data is recorded by your vehicle only if a non-trivial crash situation occurs; no data is recorded by the event data recorder under normal driving conditions and no personal data or information (for example name, gender, age, and crash location) is recorded. However, parties, such as law enforcement, could combine the event data recorder data with the type of personally identifying data routinely acquired during a crash investigation.*

To read data recorded by an event data recorder, special equipment is required, and access to the vehicle or the event data recorder is needed. In addition to the vehicle manufacturer, other parties, such as law enforcement, that have such special equipment, can read the information if they have access to the vehicle or the event data recorder.

SETTINGS DATA

Your vehicle has electronic control units that have the ability to store data based on your personalized settings. The data is stored locally in the vehicle or on devices that you connect to it, for example, a USB drive or digital music player. You can delete some of this data and also choose whether to share it through the services to which you subscribe. See **Settings** (page 393).

Comfort and Convenience Data

Data recorded includes, for example:

- Seat and steering wheel position.
- Climate control settings.
- Radio presets.

Entertainment Data

Data recorded includes, for example:

- Music, videos or album art.
- Contacts and corresponding address book entries.
- Navigation destinations.

CONNECTED VEHICLE DATA



The modem has a SIM. The modem was enabled when your vehicle was built and periodically sends messages to stay connected to the cell phone network, receive automatic software updates and send vehicle-related information to us, for example diagnostic information. These messages could include information that identifies your vehicle, the SIM and the electronic serial number of the modem. Cell phone network service providers could have access to additional information, for example cell phone network tower identification. For additional information about our privacy policy, visit www.FordConnected.com or refer to your local Ford website.

Note: *The modem continues to send this information unless you disable the modem or stop the modem from sharing vehicle data by changing the modem settings. See **Connected Vehicle** (page 337).*

Note: *The service can be unavailable or interrupted for a number of reasons, for example environmental or topographical conditions and data plan coverage.*

Note: *To find out if your vehicle has a modem, visit www.FordConnected.com.*

Data Privacy

MOBILE DEVICE DATA

If you connect a mobile device to your vehicle, you can display data from your device on the touchscreen for example, music and album art. You can share your vehicle data with mobile apps on your device through the system. See **Apps** (page 392).

The mobile apps function operates by your connected device sending data to us in the United States. The data is encrypted and includes, for example, the vehicle identification number of your vehicle, the SYNC module serial number, odometer, enabled apps, usage statistics and debugging information. We retain it only as long as necessary to provide the service, to troubleshoot, for continuous improvement and to offer you products and services that may be of interest to you according to your preferences and where allowed by law.

If you connect a cell phone to the system, the system creates a profile that links to that cell phone. The cell phone profile enables more mobile features and efficient operation. The profile contains, for example data from your phonebook, read and unread text messages and call history, including history of calls when your cell phone was not connected to the system.

If you connect a media device, the system creates and retains a media device index of supported media content. The system also records a short diagnostic log of approximately 10 minutes of all recent system activity.

The cell phone profile, media device index and diagnostic log remain in your vehicle unless you delete them and are generally accessible only in your vehicle when you connect your cell phone or media device. If you no longer plan to use the system or your vehicle, we recommend you use the master reset function to erase the stored information. See **Settings** (page 393).

System data cannot be accessed without special equipment and access to your vehicle's module.

For additional information about our privacy policy, refer to the local Ford website.

Note: To find out if your vehicle has connectivity technology, visit www.FordConnected.com.

EMERGENCY CALL SYSTEM DATA

When the emergency call system is active, it may disclose to emergency services that your vehicle has been in a crash involving the deployment of an airbag or activation of the fuel pump shut-off. Certain versions or updates to the emergency call system may also be capable of electronically or verbally disclosing to emergency services operators your vehicle location or other details about your vehicle or crash to assist emergency services operators to provide the most appropriate emergency services. If you do not want to disclose this information, do not activate the emergency call system.

Note: You cannot deactivate emergency call systems that are required by law.

At a Glance

INSTRUMENT PANEL

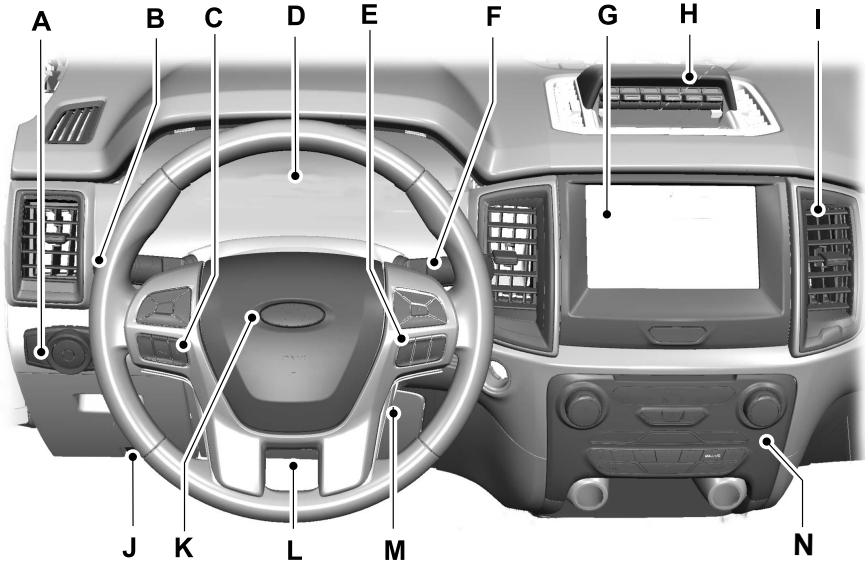

- A Lighting control. See **Lighting Control** (page 77).
- B Direction Indicator. See **Direction Indicators** (page 81).
- C Audio control and Voice control. See **Steering Wheel** (page 72).
- D Instrument cluster. See **Instrument Cluster** (page 89).
- E Cruise control switches. See **Cruise Control** (page 192).
- F Windshield wipers. See **Windshield Wipers** (page 75).
- G Multi-function display. See **General Information** (page 96).
- H Upfitter switch. See **Auxiliary Switches** (page 409).
- I Air vent.
- J Hood release lever. See **Opening and Closing the Hood** (page 264).

At a Glance

- K Horn.
- L Steering wheel adjustment lever. See **Adjusting the Steering Wheel** (page 72).
- M Ignition switch See **Ignition Switch** (page 142).
- N Climate control. See **Climate Control** (page 117).

Child Safety

GENERAL INFORMATION

See the following sections for directions on how to properly use safety restraints for children.



WARNING: Always make sure your child is secured properly in a device that is appropriate for their height, age and weight. Child safety restraints must be bought separately from your vehicle. Failure to follow these instructions and guidelines may result in an increased risk of serious injury or death to your child.



WARNING: All children are shaped differently. The National Highway Traffic Safety Administration and other safety organizations, base their recommendations for child restraints on probable child height, age and weight thresholds, or on the minimum requirements of the law. We recommend that you check with a NHTSA Certified Child Passenger Safety Technician

(CPST) to make sure that you properly install the child restraint in your vehicle and that you consult your pediatrician to make sure you have a child restraint appropriate for your child. To locate a child restraint fitting station and CPST, contact NHTSA toll free at 1-888-327-4236 or go to www.nhtsa.dot.gov. In Canada, contact Transport Canada toll free at 1-800-333-0371 or go to www.tc.gc.ca to find a Child Car Seat Clinic in your area. Failure to properly restrain children in child restraints made especially for their height, age and weight, may result in an increased risk of serious injury or death to your child.



WARNING: On hot days, the temperature inside the vehicle can rise very quickly. Exposure of people or animals to these high temperatures for even a short time can cause death or serious heat related injuries, including brain damage. Small children are particularly at risk.

Child Safety

Recommendations for Safety Restraints for Children

Child	Child Size, Height, Weight, or Age	Recommended Restraint Type
Infants or toddlers	Children weighing 40 lb (18 kg) or less (generally age four or younger).	Use a child restraint (sometimes called an infant carrier, convertible seat, or toddler seat).
Small children	Children who have outgrown or no longer properly fit in a child restraint (generally children who are less than 57 in (1.45 m) tall, are greater than age four and less than age 12, and between 40 lb (18 kg) and 80 lb (36 kg) and upward to 100 lb (45 kg) if recommended by your child restraint manufacturer).	Use a belt-positioning booster seat.
Larger children	Children who have outgrown or no longer properly fit in a belt-positioning booster seat (generally children who are at least 57 in (1.45 m) tall or greater than 80 lb (36 kg) or 100 lb (45 kg) if recommended by child restraint manufacturer).	Use a vehicle seatbelt having the lap belt snug and low across the hips, shoulder belt centered across the shoulder and chest, and seat backrest upright.

- You are required by law to properly use child restraints for infants and toddlers in the United States, Canada and Mexico.
- Many states and provinces require that small children use approved booster seats until they reach age eight, a height of 57 in (1.45 m) tall, or 80 lb (36 kg). Check your local and state or provincial laws for specific requirements about the safety of children in your vehicle.
- When possible, properly restrain children 12 years of age and under in a rear seating position of your vehicle. Accident statistics suggest that children are safer when properly restrained in the rear seating positions than in a front seating position. See **Front Passenger Sensing System** (page 43).
- When installing a rear facing child restraint, adjust the vehicle seats to avoid interference between the child restraint and the vehicle seat in front of the child restraint.

Child Safety

INSTALLING CHILD RESTRAINTS

Child Restraints



E142594

Use a child restraint (sometimes called an infant carrier, convertible seat, or toddler seat) for infants, toddlers, or children weighing 40 lb (18 kg) or less (generally age four or younger).

Using Lap and Shoulder Belts

WARNING: Do not place a rearward facing child restraint in front of an active airbag. Failure to follow this instruction could result in personal injury or death.

WARNING: Properly secure children 12 years old and under in a rear seating position whenever possible. If you are unable to properly secure all children in a rear seating position, properly secure the largest child on the front seat. If you must use a forward facing child restraint on the front seat, move the seat as far back as possible. Failure to follow these instructions could result in personal injury or death.

WARNING: Depending on where you secure a child restraint, and depending on the child restraint design, you may block access to certain seatbelt buckle assemblies and LATCH lower anchors, rendering those features potentially unusable. To avoid risk of injury, make sure occupants only use seating positions where they are able to be properly restrained.

When installing a child restraint with combination lap and shoulder belts:

- Use the correct seatbelt buckle for that seating position.
- Insert the belt tongue into the proper buckle until you hear a snap and feel it latch. Make sure the tongue is securely fastened in the buckle.
- Keep the buckle release button pointing up and away from the child restraint, with the tongue between the child restraint and the release button, to prevent accidental unbuckling.
- Place the vehicle seat upon which the child restraint will be installed in the upright position.
- Put the seatbelt in the automatic locking mode. This vehicle does not require the use of a locking clip.

Perform the following steps when installing the child restraint with combination lap and shoulder belts:

Note: *Although the child restraint illustrated is a forward facing child restraint, the steps are the same for installing a rear facing child restraint.*

Child Safety



1. Position the child restraint in a seat with a combination lap and shoulder belt.



2. Pull down on the shoulder belt and then grasp the shoulder belt and lap belt together.



3. While holding the shoulder and lap belt portions together, route the tongue through the child restraint according to the child restraint manufacturer's instructions. Make sure the belt webbing is not twisted.

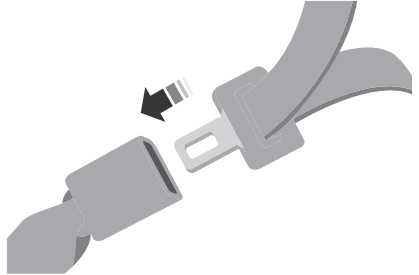

4. Insert the belt tongue into the proper buckle (the buckle closest to the direction the tongue is coming from) for that seating position until you hear a snap and feel the latch engage. Make sure the tongue is latched securely by pulling on it.



5. To put the retractor in the automatic locking mode, grasp the shoulder portion of the belt and pull downward until you pull all of the seatbelt out.

Child Safety

Note: The automatic locking mode is available on the front passenger and rear seats. This vehicle does not require the use of a locking clip.

6. Allow the belt to retract to remove slack. The belt clicks as it retracts to indicate it is in the automatic locking mode.
7. Try to pull the seatbelt out of the retractor to make sure the retractor is in the automatic locking mode (you should not be able to pull more belt out). If the retractor is not locked, unbuckle the belt and repeat Steps 5 and 6.



8. Remove remaining slack from the belt. Force the seat down with extra weight, for example, by pressing down or kneeling on the child restraint as you pull up on the shoulder belt to force slack from the belt. This is necessary to remove the remaining slack that exists once you add the extra weight of the child to the child restraint. It also helps to achieve the proper snugness of the child restraint to your vehicle. Sometimes, a slight lean toward the buckle helps to remove remaining slack from the belt.
9. Attach the tether strap (if the child restraint is equipped).

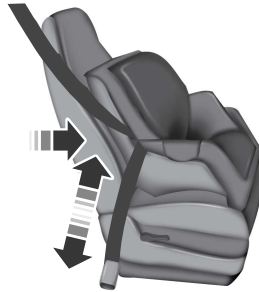

10. Before placing the child in the seat, forcibly move the seat forward and back to make sure the seat is securely held in place.

To check this, grab the seat at the belt path and attempt to move it side to side and forward and back. There should be no more than 1 in (2.5 cm) of movement for proper installation.

We recommend checking with a NHTSA Certified Child Passenger Safety Technician to make certain the child restraint is properly installed. In Canada, check with Transport Canada for referral to a Child Car Seat Clinic.

Using Lower Anchors and Tethers for Children (LATCH)



WARNING: Do not attach two child safety restraints to the same anchor. In a crash, one anchor may not be strong enough to hold two child safety restraint attachments and may break, causing serious injury or death.

Child Safety



WARNING: Depending on where you secure a child restraint, and depending on the child restraint design, you may block access to certain seatbelt buckle assemblies and LATCH lower anchors, rendering those features potentially unusable. To avoid risk of injury, make sure occupants only use seating positions where they are able to be properly restrained.

The LATCH system is composed of three vehicle anchor points: two lower anchors where the vehicle seat backrest and seat cushion meet (called the seat bight) and one top tether anchor behind that seating position.

LATCH compatible child restraints have two rigid or webbing mounted attachments that connect to the two lower anchors at the LATCH equipped seating positions in your vehicle. This type of attachment method eliminates the need to use seatbelts to attach the child restraint. However, you can still use the seatbelt to attach the child restraint if the lower anchors are not used.

For forward-facing child restraints, you must also attach the top tether strap to the proper top tether anchor if a top tether strap has been provided with your child restraint.

Your vehicle has LATCH lower anchors for child restraint installation at the following seating positions.

SuperCrew

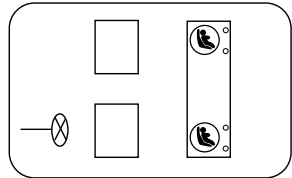

E274695



E166695

For SuperCrew vehicles, the lower LATCH anchors are at the rear section of the rear seat between the cushion and the seat backrest.

SuperCab

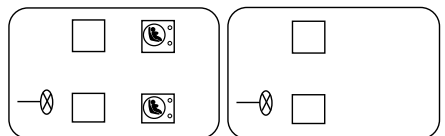

E281347

Child Safety



For SuperCab vehicles, the lower LATCH anchors are at the back panel behind the rear seats.

Follow the child restraint manufacturer's instructions to properly install a child restraint with LATCH attachments.

Follow the instructions later in this chapter on attaching child restraints with tether straps.

Attach LATCH lower attachments of the child restraint only to the anchors shown.

Use of Inboard Lower Anchors from the Outermost Seating Positions (Center Seating Use)



WARNING: The standardized spacing for LATCH lower anchors is 11 in (280 mm) center to center. Do not use LATCH lower anchors for the center seating position unless the child restraint manufacturer's instructions permit and specify using anchors spaced at least as far apart as those in this vehicle.

The lower anchors at the center of the second row rear seat are spaced 25.7 in (652 mm) apart. The standardized spacing for LATCH lower anchors is 11.0 in (280 mm) center to center. You cannot install a child restraint with rigid LATCH attachments at the center seating position. LATCH compatible child restraints (with attachments on belt webbing) can only be

used at this seating position provided that the child restraint manufacturer's instructions permit use with the anchor spacing stated. Do not attach a child restraint to any lower anchor if an adjacent child restraint is attached to that anchor.

Each time you use the child restraint, check that the seat is properly attached to the lower anchors and tether anchor, if applicable. Tug the child restraint from side to side and forward and back where it is secured to the vehicle. The seat should move less than 1 in (2.5 cm) when you do this for a proper installation.

If the child restraint is not anchored properly, the risk of a child being injured in a crash greatly increases.

Combining Seatbelt and LATCH Lower Anchors for Attaching Child Restraints

When used in combination, either the seatbelt or the LATCH lower anchors may be attached first, provided a proper installation is achieved. Attach the tether strap afterward, if included with the child restraint.

Using Tether Straps

Many forward-facing child restraints include a tether strap which extends from the back of the child restraint and hooks to an anchoring point called the top tether anchor. Tether straps are available as an accessory for many older child restraints. Contact the manufacturer of your child restraint for information about ordering a tether strap, or to obtain a longer tether strap if the tether strap on your child restraint does not reach the appropriate top tether anchor in the vehicle.

The passenger seats of your vehicle may have built-in tether strap anchors behind the seats.

Child Safety

For SuperCrew vehicles, the tether anchors are anchor brackets behind the seat on the rear edge of the seat cushion.

For SuperCab vehicles, the tether anchors in your vehicle are loops of webbing above the seat backrest.

The rear seat in the SuperCab has two straps along the top of the seat backrest that function as both routing loops for the tether straps and anchor loops.

The tether strap anchors in your vehicle are in the following positions (shown from top view):

SuperCrew

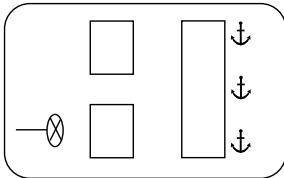

E274697

SuperCab

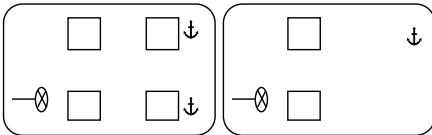

E278365

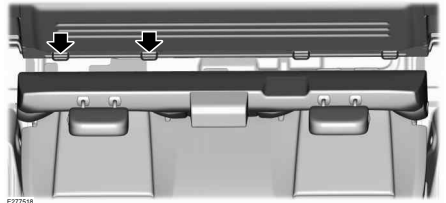

For SuperCab vehicles without rear seats, use either of the two passenger side rear rigid anchors on the back panel as a top tether for the front passenger seat.

Attach the tether strap only to the appropriate tether anchor as shown. The tether strap may not work properly if attached somewhere other than the correct tether anchor.

If you install a child restraint with rigid LATCH attachments, do not tighten the tether strap enough to lift the child restraint off the vehicle seat cushion when the child is seated in it. Keep the tether strap just snug without lifting the front of the child restraint. Keeping the child restraint just touching the vehicle seat gives the best protection in a severe crash.

Once you have installed the child restraint using either the seatbelt, the lower anchors of the LATCH system, or both, you can attach the top tether strap.

Front Seat Tether Strap Attachment (SuperCab)

If the tether strap is clipped incorrectly, the child restraint may not be retained properly in the event of a crash.

If the child restraint is not anchored properly, the risk of a child being injured in a crash greatly increases.

If your child restraint system has a tether strap, and the child restraint manufacturer recommends its use, we also recommend its use.

Child Safety

1. Route the child restraint tether strap over the back of the seat and under the head restraint.

Note: For vehicles with adjustable head restraints, route the tether strap under the head restraint and between the head restraint posts, otherwise route the tether strap over the top of the seat backrest.

2. Locate the correct anchor for the selected seating position. Make sure the seat is locked in the upright position before installing the child restraint.
3. Clip the tether strap to either of the anchors on the back panel.
4. Tighten the child restraint tether strap according to the manufacturer's instructions.

If the tether strap is clipped incorrectly, the child restraint may not be retained properly in the event of a crash.

If the child restraint is not anchored properly, the risk of a child being injured in a crash greatly increases.

If your child restraint system has a tether strap, and the child restraint manufacturer recommends its use, we also recommend its use.

Rear Seat Tether Strap Attachment (SuperCab)

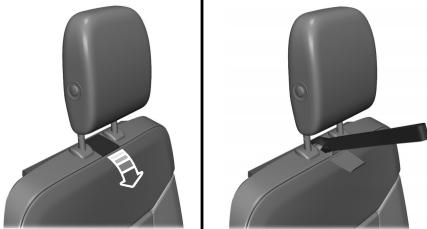

E280119

There are two loops of webbing just above the back of the rear seat (along the bottom edge of the rear window). Use these loops as both routing loops and anchor loops for up to two child restraint tether straps.

For example, you can use the driver side loop as a routing loop for a child restraint in the driver side rear seat and as an anchoring loop for child restraints installed in the passenger side rear seat.

Many tether straps cannot be tightened if the tether strap is hooked to the loop directly behind the child restraint.

To provide a tight tether strap:

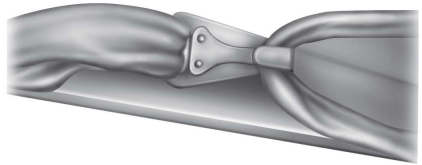

E162715

1. Route the vehicle tether loop between the head restraint posts. Then route the child restraint tether strap through the loop, forward of the head restraint.
2. Hook the strap to the vehicle tether anchor loop in the adjacent seating position. Always put the tether strap through the routing loop. The head restraint support post holds the child restraint tightly, but the head restraint post is not strong enough to hold the child restraint during a crash.
3. Tighten the tether strap according to the child restraint manufacturer's instructions.

If the child restraint is not anchored properly, the risk of a child being injured in a crash greatly increases.

Child Safety

If your child restraint system has a tether strap, and the child restraint manufacturer recommends its use, we also recommend its use.

BOOSTER SEATS



WARNING: Do not put the shoulder section of the seatbelt or allow the child to put the shoulder section of the seatbelt under their arm or behind their back. Failure to follow this instruction could reduce the effectiveness of the seatbelt and increase the risk of injury or death in a crash.

Use a belt-positioning booster seat for children who have outgrown or no longer properly fit in a child safety restraint (generally children who are less than 57 in (1.45 m) tall, are greater than age 4 and less than age 12, and between 40 lb (18 kg) and 80 lb (36 kg) and upward to 100 lb (45 kg) if recommended by your child restraint manufacturer). Many state and provincial laws require that children use approved booster seats until they reach age eight, a height of 57 in (1.45 m) tall, or 80 lb (36 kg).

Booster seats should be used until you can answer YES to ALL of these questions when seated without a booster seat:

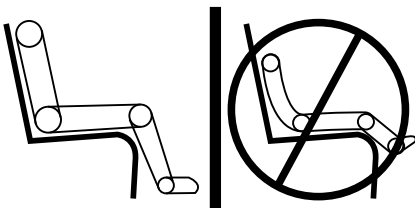

- Can the child sit all the way back against their vehicle seat backrest with knees bent comfortably at the edge of the seat cushion?
- Can the child sit without slouching?
- Does the lap belt rest low across the hips?
- Is the shoulder belt centered on the shoulder and chest?
- Can the child stay seated like this for the whole trip?

Always use booster seats in conjunction with your vehicle lap and shoulder belt.

Types of Booster Seats



- Backless booster seats

If your backless booster seat has a removable shield, remove the shield. If a vehicle seating position has a low seat backrest or no head restraint, a backless booster seat may place your child's head (as measured at the tops of the ears) above the top of the seat. In this case, move the backless booster to another seating position with a higher seat backrest or head restraint and lap and shoulder belts, or consider using a high back booster seat.

Child Safety



If, with a backless booster seat, you cannot find a seating position that adequately supports your child's head, a high back booster seat would be a better choice.

Children and booster seats vary in size and shape. Choose a booster that keeps the lap belt low and snug across the hips, never up across the stomach, and lets you adjust the shoulder belt to cross the chest and rest snugly near the center of the shoulder. The following drawings compare the ideal fit (center) to a shoulder belt uncomfortably close to the neck and a shoulder belt that could slip off the shoulder. The drawings also show how the lap belt should be low and snug across the child's hips.

- High back booster seats



Child Safety

If the booster seat slides on the vehicle seat upon which it is being used, placing a rubberized mesh sold as shelf or carpet liner under the booster seat may improve this condition. Do not introduce any item thicker than this under the booster seat. Check with the booster seat manufacturer's instructions.

CHILD RESTRAINT POSITIONING



WARNING: Do not place a rearward facing child restraint in front of an active airbag. Failure to follow this instruction could result in personal injury or death.



WARNING: Properly secure children 12 years old and under in a rear seating position whenever possible. If you are unable to properly secure all children in a rear seating position, properly secure the largest child on the front seat. If you must use a forward facing child restraint on the front seat, move the seat as far back as possible. Failure to follow these instructions could result in personal injury or death.



WARNING: Always carefully follow the instructions and warnings provided by the manufacturer of any child restraint to determine if the restraint device is appropriate for your child's size, height, weight, or age. Follow the child restraint manufacturer's instructions and warnings provided for installation and use in conjunction with the instructions

and warnings provided by your vehicle manufacturer. A safety seat that is improperly installed or utilized, is inappropriate for your child's height, age, or weight or does not properly fit the child may increase the risk of serious injury or death.



WARNING: Do not allow a passenger to hold a child on their lap when your vehicle is moving. Failure to follow this instruction could result in personal injury or death in the event of a sudden stop or crash.



WARNING: Do not use pillows, books or towels to boost your child's height. Failure to follow this instruction could result in personal injury or death.



WARNING: Properly secure child restraints or booster seats when they are not in use. They could become projectiles in a sudden stop or crash. Failure to follow this instruction could result in personal injury or death.



WARNING: Do not put the shoulder section of the seatbelt or allow the child to put the shoulder section of the seatbelt under their arm or behind their back. Failure to follow this instruction could reduce the effectiveness of the seatbelt and increase the risk of injury or death in a crash.



WARNING: Do not leave children or pets unattended in your vehicle. Failure to follow this instruction could result in personal injury or death.

Child Safety

Recommendations for Attaching Child Safety Restraints for Children

Restraint Type	Combined Weight of Child and Child Restraint	Use Any Attachment Method as Indicated Below by X				
		LATCH (Lower Anchors and Top Tether Anchor)	LATCH (Lower Anchors Only)	Seatbelt and Top Tether Anchor	Seatbelt and LATCH (Lower Anchors and Top Tether Anchor)	Seatbelt Only
Rear facing child restraint	Up to 65 lb (29.5 kg)		X			X
Rear facing child restraint	Over 65 lb (29.5 kg)					X
Forward facing child restraint	Up to 65 lb (29.5 kg)	X		X	X	
Forward facing child restraint	Over 65 lb (29.5 kg)			X	X	

Note: The child restraint must rest tightly against the vehicle seat upon which it is installed. It may be necessary to lift or remove the head restraint. See **Seats** (page 124).

CHILD SAFETY LOCKS (IF EQUIPPED)

When these locks are set, the rear doors cannot be opened from the inside.

Child Safety



The childproof locks are located on the rear edge of each rear door and must be set separately for each door.

Left-Hand Side

Turn counterclockwise to lock and clockwise to unlock.

Right-Hand Side

Turn clockwise to lock and counterclockwise to unlock.

Seatbelts

PRINCIPLE OF OPERATION



WARNING: Always drive and ride with your seatback upright and the lap belt snug and low across the hips.



WARNING: Children must always be properly restrained.



WARNING: Do not allow a passenger to hold a child on their lap when your vehicle is moving. Failure to follow this instruction could result in personal injury or death in the event of a sudden stop or crash.



WARNING: All occupants of your vehicle, including the driver, should always properly wear their seatbelts, even when an airbag supplemental restraint system is provided. Failure to properly wear your seatbelt could seriously increase the risk of injury or death.



WARNING: It is extremely dangerous to ride in a cargo area, inside or outside of a vehicle. In a crash, people riding in these areas are more likely to be seriously injured or killed. Do not allow people to ride in any area of your vehicle that is not equipped with seats and seatbelts. Make sure everyone in your vehicle is in a seat and properly using a seatbelt. Failure to follow this warning could result in serious personal injury or death.



WARNING: In a rollover crash, an unbelted person is significantly more likely to die than a person wearing a seatbelt.



WARNING: Each seating position in your vehicle has a specific seatbelt assembly made up of one buckle and one tongue designed to be used as a pair. Use the shoulder belt on the outside shoulder only. Never wear the shoulder belt under the arm. Never use a single seatbelt for more than one person.



WARNING: Properly secure children 12 years old and under in a rear seating position whenever possible. If you are unable to properly secure all children in a rear seating position, properly secure the largest child on the front seat. If you must use a forward facing child restraint on the front seat, move the seat as far back as possible. Failure to follow these instructions could result in personal injury or death.



WARNING: Seatbelts and seats may be hot in a vehicle that is in the sunshine. The hot seatbelts or seats may burn a small child. Check seat covers and buckles before you place a child anywhere near them.

All seating positions in this vehicle have lap and shoulder seatbelts. All occupants of the vehicle should always properly wear their seatbelts, even when an airbag supplemental restraint system is provided.

The seatbelt system consists of:

- Lap and shoulder seatbelts.
- Shoulder seatbelt with automatic locking mode - except driver seatbelt.
- Height adjuster at the front outermost seating positions - if equipped.
- Seatbelt pretensioner at the front outermost and rear outermost seating positions.

Seatbelts



- Seatbelt warning light and tone.



- Crash sensors and monitoring system with readiness indicator.

The seatbelt pretensioners are designed to tighten the seatbelts when activated. In frontal and near-frontal crashes, the seatbelt pretensioners may be activated alone or, if the crash is of sufficient severity, together with the front airbags. In side crashes and rollovers, the pretensioners will be activated when the Safety Canopy is activated.

FASTENING THE SEATBELTS

The front outboard and rear safety restraints in the vehicle are combination lap and shoulder belts.

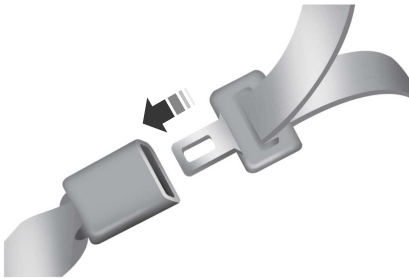

1. Insert the belt tongue into the proper buckle (the buckle closest to the direction the tongue is coming from) until you hear a snap and feel it latch. Make sure that you securely fasten the tongue in the buckle.

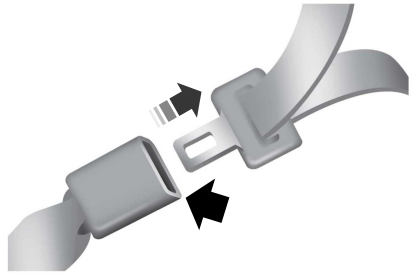

2. To unfasten, press the release button and remove the tongue from the buckle.

Using Seatbelts During Pregnancy



WARNING: Always ride and drive with your seatback upright and properly fasten your seatbelt. Fit the lap portion of the seatbelt snugly and low across the hips. Position the shoulder portion of the seatbelt across your chest. Pregnant women must follow this practice. See the following figure.

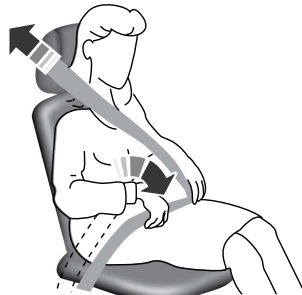

Seatbelts

Pregnant women should always wear their seatbelt. Position the lap belt portion of a combination lap and shoulder belt low across the hips below the belly and worn as tight as comfort allows. Position the shoulder belt to cross the middle of the shoulder and the center of the chest.

Seatbelt Locking Modes



WARNING: If your vehicle is involved in a crash, have the seatbelts and associated components inspected as soon as possible. Failure to follow this instruction could result in personal injury or death.

All safety restraints in the vehicle are combination lap and shoulder belts. The driver seatbelt has the first type of locking mode, and the front outboard passenger and rear seat seatbelts have both types of locking modes described as follows:

Vehicle Sensitive Mode

This is the normal retractor mode, which allows free shoulder belt length adjustment to your movements and locking in response to vehicle movement. For example, if the driver brakes suddenly or turns a corner sharply, or the vehicle receives an impact of about 5 mph (8 km/h) or more, the combination seatbelts lock to help reduce forward movement of the driver and passengers.

In addition, the design of the retractor is to lock if you pull the webbing out too quickly. If the seatbelt retractor locks, slowly lower the height adjuster to allow the seatbelt to retract. If the retractor does not unlock, pull the seatbelt out slowly then feed a

small length of webbing back toward the stowed position. For rear seatbelts, recline the rear seat backrest or push the seat backrest cushion away from the seatbelt. Feed a small length of webbing back toward the stowed position.

Automatic Locking Mode

In this mode, the shoulder belt automatically pre-locks. The belt retracts to remove any slack in the shoulder belt. The automatic locking mode is not available on the driver seatbelt.

When to Use the Automatic Locking Mode

Use this mode any time you install a child safety seat, except a booster, in passenger front or rear seating positions. Properly restrain children 12 years old and under in a rear seating position whenever possible. See **Child Safety** (page 20).

How to Use the Automatic Locking Mode



1. Buckle the combination lap and shoulder belt.
2. Grasp the shoulder portion and pull downward until you pull the entire belt out. Allow the belt to retract. As the belt retracts, you will hear a clicking sound. This indicates the seatbelt is now in the automatic locking mode.

Seatbelts

How to Disengage the Automatic Locking Mode

Unbuckle the combination lap and shoulder belt and allow it to retract completely to disengage the automatic locking mode and turn on the vehicle sensitive (emergency) locking mode.

SEATBELT HEIGHT ADJUSTMENT

WARNING: Position the seatbelt height adjuster so that the seatbelt rests across the middle of your shoulder. Failure to adjust the seatbelt correctly could reduce its effectiveness and increase the risk of injury in a crash.

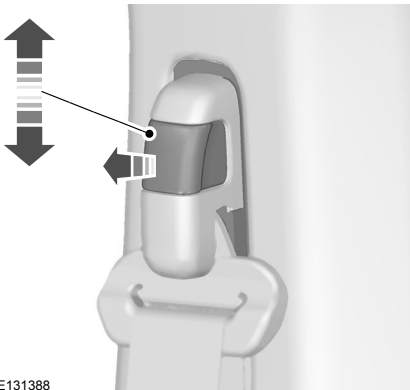

E131388

To adjust the shoulder belt height:

1. Pull the locking button and slide the height adjuster up or down.
2. Release the button and pull down on the height adjuster to make sure it is locked in place.

SEATBELT REMINDER

WARNING: The system will only provide protection when you use the seatbelt correctly.

This system monitors all seating positions and provides audio and graphic feedback.



This lamp illuminates and a warning tone sounds if you do not fasten your seatbelt when you switch the ignition on. The lamp and tone turn off when you fasten your seatbelt or about one minute has elapsed.

When the initial warning expires for the driver, more warnings are provided for the driver and front passenger. This lamp illuminates and a warning tone sounds if you or your front passenger do not fasten the seatbelt buckle and the vehicle speed exceeds 6 mph (9.7 km/h). To deactivate the warning, see Deactivating and Activating the Belt-Minder Feature.

Note: To avoid inadvertent warnings, do not place large objects on the seat.



This lamp illuminates when you switch the ignition on, identifying the number of seating positions with fastened buckles. It illuminates again when a seating position changes from unfastened to fastened.

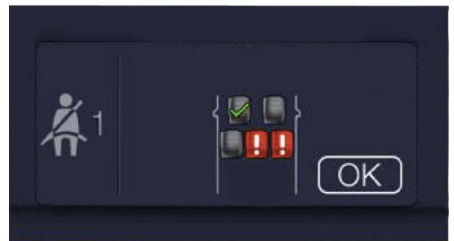

Seatbelts

This warning displays and a tone sounds if an occupant unfastens the rear seatbelt buckle or it becomes unfastened.

Note: If a rear seat is unoccupied, or an occupant never fastens the seatbelt buckle to begin with, the warning will not display.

Note: Front seating positions appear in this warning display. Warnings for unfastened front seatbelt buckles appear in the initial warning lamp.

Seatbelt Status

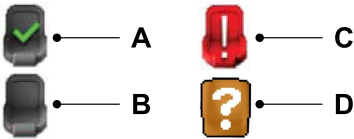
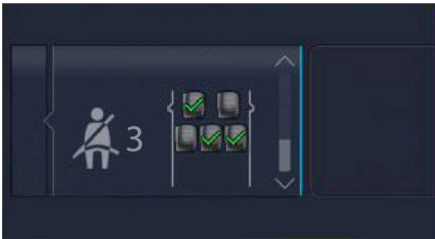

- A Seatbelt fastened.
- B Seatbelt not fastened.
- C Seatbelt recently unfastened.
- D Fault.

To view the seatbelt status, use the information display controls on the steering wheel.

Deactivating and Activating the Seatbelt Reminder (Front Seats Only)



WARNING: While the system allows you to deactivate it, this system is designed to improve your chances of being safely belted and surviving an accident. We recommend you leave the system activated for yourself and others who may use the vehicle.

Note: The driver and front passenger warnings switch on and off independently. When you perform this procedure for one seating position, do not buckle the other position as this terminates the process.

Read Steps 1 - 4 before starting the procedure.

Make sure that:

- You set the parking brake.
 - The transmission is in park (P).
 - The ignition is off.
 - You close all vehicle doors.
 - You unbuckle the driver and front passenger seatbelts.
1. Switch the ignition on. Do not start the engine.
 2. Wait until the seatbelt warning lamp turns off (about one minute). After Step 2, wait an additional five seconds before proceeding with Step 3. Once you start Step 3, you must complete the procedure within 60 seconds.
 3. For the seating position you are switching off, buckle then unbuckle the seatbelt three times at a moderate speed, ending in the unbuckled state. After Step 3, the seatbelt warning lamp turns on.
 4. When the seatbelt warning lamp is on, buckle then unbuckle the seatbelt. After Step 4, the seatbelt warning lamp flashes for confirmation.

Seatbelts

- This switches the feature off if it is currently on.
- This switches the feature on if it is currently off.

CHILD RESTRAINT AND SEATBELT MAINTENANCE

Inspect the vehicle seatbelts and child safety seat systems periodically to make sure they work properly and are not damaged. Inspect the vehicle and child restraint seatbelts to make sure there are no nicks, tears or cuts. Replace if necessary. All vehicle seatbelt assemblies, including retractors, buckles, front seatbelt buckle assemblies, buckle support assemblies (slide bar-if equipped), shoulder belt height adjusters (if equipped), shoulder belt guide on seat backrest (if equipped), child safety seat LATCH and tether anchors, and attaching hardware, should be inspected after a crash. Read the child restraint manufacturer's instructions for additional inspection and maintenance information specific to the child restraint.

We recommend that all seatbelt assemblies in use in vehicles involved in a crash be replaced. However, if the crash was minor and an authorized dealer finds that the belts do not show damage and continue to operate properly, they do not need to be replaced. Seatbelt assemblies not in use during a crash should also be inspected and replaced if either damage or improper operation is noted.

Properly care for seatbelts. See **Vehicle Care** (page 284).

SEATBELT EXTENSIONS



WARNING: Persons who fit into the vehicle's seatbelt should not use an extension. Unnecessary use could result in serious personal injury in the event of a crash.



WARNING: Only use extensions provided free of charge by our dealers. The dealer will provide an extension designed specifically for this vehicle, model year and seating position. The use of an extension intended for another vehicle, model year or seating position may not offer you the full protection of your vehicle's seatbelt restraint system.



WARNING: Never use seatbelt extensions to install child restraints.



WARNING: Do not use extensions to change the way the seatbelt fits across the torso, over the lap or to make the seatbelt buckle easier to reach.

If, because of body size or driving position, it is not possible to properly fasten the seatbelt over your lap and shoulder, an extension that is compatible with the seatbelts is available free of charge from our dealers. Only use our seatbelt extensions made by the original equipment seatbelt manufacturer with our seatbelts. Ask your authorized dealer if your extension is compatible with your vehicle restraint system.

Personal Safety System™

The Personal Safety System provides an improved overall level of frontal crash protection to front seat occupants and is designed to help further reduce the risk of airbag-related injuries. The system is able to analyze different occupant conditions and crash severity before activating the appropriate safety devices to help better protect a range of occupants in a variety of frontal crash situations.

The Vehicle Personal Safety System consists of:

- Driver and passenger dual-stage airbag supplemental restraints.
- Front seat outboard seatbelts with pretensioners, energy management retractors and seatbelt usage sensors.
- Driver seat position sensor.
- Front passenger sensing system.
- Passenger airbag status indicator.
- Front crash severity sensors.
- Restraints control module with impact and safing sensors.
- Restraint system warning lamp and tone.
- The electrical wiring for the airbags, crash sensors, seatbelt pretensioners, front seatbelt usage sensors, driver seat position sensor, front passenger sensing system and indicator lights.

How Does the Personal Safety System Work?

The Personal Safety System can adapt the deployment strategy of the safety devices according to crash severity and occupant conditions. A collection of crash and occupant sensors provides information to the restraints control module. During a crash, the restraints control module may deploy the seatbelt pretensioners, one or both stages of the dual-stage airbags based on crash severity and occupant conditions.

Supplementary Restraints System

PRINCIPLE OF OPERATION

 **WARNING:** Airbags do not inflate slowly or gently, and the risk of injury from a deploying airbag is the greatest close to the trim covering the airbag module.

 **WARNING:** All occupants of your vehicle, including the driver, should always properly wear their seatbelts, even when an airbag supplemental restraint system is provided. Failure to properly wear your seatbelt could seriously increase the risk of injury or death.

 **WARNING:** Properly secure children 12 years old and under in a rear seating position whenever possible. If you are unable to properly secure all children in a rear seating position, properly secure the largest child on the front seat. If you must use a forward facing child restraint on the front seat, move the seat as far back as possible. Failure to follow these instructions could result in personal injury or death.

 **WARNING:** Do not place your arms on the airbag cover or through the steering wheel. Failure to follow this instruction could result in personal injury.

 **WARNING:** Do not place a rearward facing child restraint in front of an active airbag. Failure to follow this instruction could result in personal injury or death.

 **WARNING:** Do not attempt to service, repair, or modify the supplementary restraint system or associated components. Failure to follow this instruction could result in personal injury or death.

 **WARNING:** Several airbag system components get hot after inflation. To reduce the risk of injury, do not touch them after inflation.

 **WARNING:** If a supplementary restraint system component has deployed, it will not function again. Have the system and associated components inspected as soon as possible. Failure to follow this instruction could result in personal injury or death.

The airbags are a supplemental restraint system and are designed to work with the seatbelts to help protect the driver and right front passenger from certain upper body injuries. Airbags do not inflate slowly; there is a risk of injury from a deploying airbag.

Note: *You will hear a loud bang and see a cloud of harmless powdery residue if an airbag deploys. This is normal.*

The airbags inflate and deflate rapidly upon activation. After airbag deployment, it is normal to notice a smoke-like, powdery residue or smell the burnt propellant. This may consist of cornstarch, talcum powder (to lubricate the bag) or sodium compounds (for example, baking soda) that result from the combustion process that inflates the airbag. Small amounts of sodium hydroxide may be present which may irritate the skin and eyes, but none of the residue is toxic.

While the system is designed to help reduce serious injuries, contact with a deploying airbag may also cause abrasions or swelling. Temporary hearing loss is also a possibility as a result of the noise associated with a deploying airbag. Because airbags must inflate rapidly and with considerable force, there is the risk of death or serious injuries such as fractures, facial and eye injuries or internal injuries,

Supplementary Restraints System

particularly to occupants who are not properly restrained or are otherwise out of position at the time of airbag deployment. Thus, it is extremely important that occupants be properly restrained as far away from the airbag module as possible while maintaining vehicle control.

Routine maintenance of the airbags is not required.

DRIVER AND PASSENGER AIRBAGS



WARNING: Do not place your arms on the airbag cover or through the steering wheel. Failure to follow this instruction could result in personal injury.



WARNING: Keep the areas in front of the airbags free from obstruction. Do not affix anything to or over the airbag covers. Objects could become projectiles during airbag deployment or in a sudden stop. Failure to follow this instruction could result in personal injury or death.



WARNING: Airbags can kill or injure a child in a child restraint. Never place a rear-facing child restraint in front of an active airbag. If you must use a forward-facing child restraint in the front seat, move the seat upon which the child restraint is installed all the way back.

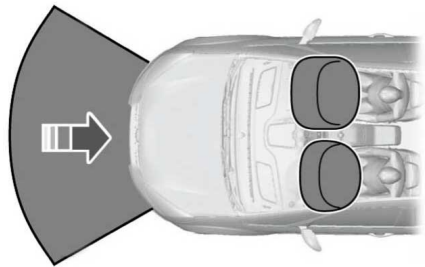

The driver and passenger front airbags will deploy during significant frontal and near frontal crashes.

The driver and passenger front airbag system consists of:

- Driver and passenger airbag modules.
- Front passenger sensing system.
- Crash sensors and monitoring system with readiness indicator. See **Crash Sensors and Airbag Indicator** (page 48).



Proper Driver and Front Passenger Seating Adjustment



WARNING: National Highway Traffic Safety Administration (NHTSA) recommends a minimum distance of at least 10 in (25 cm) between an occupant's chest and the driver airbag module.

To properly position yourself away from the airbag:

- Move your seat to the rear as far as you can while still reaching the pedals comfortably.
- Recline the seat slightly (one or two degrees) from the upright position.

Supplementary Restraints System

After all occupants have adjusted their seats and put on seatbelts, it is very important that they continue to sit properly. Properly seated occupants sit upright, lean against the seat back, and center themselves on the seat cushion, with their feet comfortably extended on the floor. Sitting improperly can increase the chance of injury in a crash event. For example, if an occupant slouches, lies down, turns sideways, sits forward, leans forward or sideways, or puts one or both feet up, the chance of injury during a crash greatly increases.

Children and Airbags

WARNING: Airbags can kill or injure a child in a child restraint. Never place a rear-facing child restraint in front of an active airbag. If you must use a forward-facing child restraint in the front seat, move the seat upon which the child restraint is installed all the way back.



Children must always be properly restrained. Accident statistics suggest that children are safer when properly restrained in the rear seating positions than in the front seating position. Failure to follow these instructions may increase the risk of injury in a crash.

FRONT PASSENGER SENSING SYSTEM

WARNING: Even with advanced restraints systems, properly restrain children 12 and under in a rear seating position. Failure to follow this could seriously increase the risk of injury or death.

WARNING: Sitting improperly, out of position or with the seatback reclined too far can take weight off the seat cushion and affect the decision of the passenger sensing system, resulting in serious injury or death in the event of a crash. Always sit upright against your seat back, with your feet on the floor.

WARNING: Any alteration or modification to the front passenger seat may affect the performance of the front passenger sensing system. This could seriously increase the risk of injury or death.

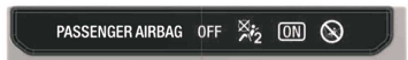

The front passenger sensing system uses a passenger airbag status indicator which illuminates indicating that the front passenger frontal airbag is either on (enabled) or off (disabled). The indicator lamp is in the center stack of the instrument panel.

Note: When you first switch the ignition on, the passenger airbag status indicator off and on lamps illuminate for a short period to confirm they are functional.

Supplementary Restraints System

The front passenger sensing system is designed to disable (will not inflate) the front passenger frontal airbag under certain conditions:

- The front passenger seat is unoccupied.
- The system determines an infant is present in a child restraint.
- A passenger takes their weight off of the seat for a period of time.
- If there is a problem with the airbag system or the passenger sensing system.

Note: *Even with this technology, parents are strongly encouraged to always properly restrain children in the rear seat.*

- When the front passenger sensing system disables (will not inflate) the front passenger frontal airbag, the passenger airbag status indicator illuminates the off lamp and stays lit to remind you that the front passenger frontal airbag is disabled.
- If you have installed the child restraint and the passenger airbag status indicator illuminates the on lamp, then switch your vehicle off, remove the child restraint from your vehicle and reinstall the restraint following the child restraint manufacturer's instructions.

The front passenger sensing system works with sensors that are part of the front passenger seat and seatbelt. The sensors are designed to detect the presence of a properly seated occupant and determine if the front passenger frontal airbag should be enabled.

- When the front passenger sensing system enables the front passenger frontal airbag (may inflate), the passenger airbag status indicator illuminates the on lamp and remains illuminated.

If a person of adult size is sitting in the front passenger seat, but the passenger airbag status indicator off lamp is lit, it is possible that the person is not properly sitting in the seat. If this happens:

- Switch your vehicle off and ask the person to place the seat backrest in an upright position.
- Have the person sit upright in the seat, centered on the seat cushion, with the person's legs comfortably extended.
- Restart your vehicle and have the person remain in this position for about two minutes. This allows the system to detect that person and enable the passenger frontal airbag.
- If the indicator off lamp remains lit even after this, you should advise the person to ride in the rear seat.

Occupant	Passenger Airbag Status Indicator	Passenger Airbag
Empty	OFF: Illuminated	Disabled
	ON: Not Illuminated	
Child	OFF: Illuminated	Disabled
	ON: Not Illuminated	
Adult	OFF: Not Illuminated	Enabled
	ON: Illuminated	

Supplementary Restraints System

After all occupants have adjusted their seats and put on seatbelts, it is very important that they continue to sit properly. A properly seated occupant sits upright, leaning against the seat backrest, and centered on the seat cushion, with their feet comfortably extended on the floor. Sitting improperly can increase the chance of injury in a crash event. For example, if an occupant slouches, lies down, turns sideways, sits forward, leans forward or sideways, or puts one or both feet up, the chance of injury during a crash greatly increases.

If you think that the state of the passenger airbag status indicator lamp is incorrect, check for the following:

- Objects lodged underneath the seat.
- Objects between the seat cushion and the center console.
- Objects hanging off the seat backrest.
- Objects stowed in the seat backrest map pocket.
- Objects placed on the occupant's lap.
- Cargo interference with the seat
- Other passengers pushing or pulling on the seat.
- Rear passenger feet and knees resting or pushing on the seat.

The conditions listed above may cause the weight of a properly seated occupant to be incorrectly interpreted by the front passenger sensing system. The person in the front passenger seat may appear heavier or lighter due to the conditions described in the previous list.



Make sure the front passenger sensing system is operating properly. See **Crash Sensors and Airbag Indicator** (page 48).

If the airbag readiness light is lit, do the following:

The driver and adult passengers should check for objects lodged underneath the front passenger seat or cargo interfering with the seat.

If objects are lodged or cargo is interfering with the seat, take the following steps to remove the obstruction:

- Pull your vehicle over.
- Switch your vehicle off.
- Driver or adult passengers should check for any objects lodged underneath the front passenger seat or cargo interfering with the seat.
- Remove the obstruction(s) (if found).
- Restart your vehicle.
- Wait at least two minutes and verify that the airbag readiness light in the instrument cluster is no longer illuminated.
- If the airbag readiness light in the instrument cluster remains illuminated, this may or may not be a problem due to the front passenger sensing system.

Do not attempt to repair or service the system. Immediately take your vehicle to an authorized dealer.

If it is necessary to modify an advanced front airbag system to accommodate a person with disabilities, contact your Customer Relationship Center.

SIDE AIRBAGS





WARNING: Do not place objects or mount equipment on or near the airbag cover, on the side of the front or rear seatbacks, or in areas that may come into contact with a deploying airbag. Failure to follow these instructions may increase the risk of personal injury in the event of a crash.

Supplementary Restraints System

 **WARNING:** Accessory seat covers not released by Ford Motor Company could prevent the deployment of the airbags and increase the risk of injuries in a crash.

 **WARNING:** Do not lean your head on the door. The side airbag could injure you as it deploys from the side of the seatback.

 **WARNING:** Do not attempt to service, repair, or modify the supplementary restraint system or associated components. Failure to follow this instruction could result in personal injury or death.

 **WARNING:** If a supplementary restraint system component has deployed, it will not function again. Have the system and associated components inspected as soon as possible. Failure to follow this instruction could result in personal injury or death.

The side airbags are on the outermost side of the front seat backrests. In certain sideways crashes or rollover events, the side airbags will be inflated. The airbag was designed to inflate between the door panel and occupant to further enhance the protection provided to occupants in side impact crashes.



The system consists of the following:

- A label or embossed side panel indicating that your vehicle has side airbags.
- Side airbags inside the driver and front passenger seat backrests.



Crash sensors and monitoring system with readiness indicator.

See **Crash Sensors and Airbag Indicator** (page 48).

The design and development of the side airbag system included recommended testing procedures that were developed by a group of automotive safety experts known as the Side Airbag Technical Working Group. These recommended testing procedures help reduce the risk of injuries related to the deployment of side airbags.

SAFETY CANOPY™

 **WARNING:** Do not place objects or mount equipment on or near the headliner at the siderail that may come into contact with a deploying curtain airbag. Failure to follow these instructions may increase the risk of personal injury in the event of a crash.

Supplementary Restraints System

WARNING: Do not lean your head on the door. The curtain airbag could injure you as it deploys from the headliner.

WARNING: Do not attempt to service, repair, or modify the supplementary restraint system or associated components. Failure to follow this instruction could result in personal injury or death.

WARNING: All occupants of your vehicle, including the driver, should always properly wear their seatbelts, even when an airbag supplemental restraint system is provided. Failure to properly wear your seatbelt could seriously increase the risk of injury or death.

WARNING: To reduce risk of injury, do not obstruct or place objects in the deployment path of the airbag.

WARNING: If a supplementary restraint system component has deployed, it will not function again. Have the system and associated components inspected as soon as possible. Failure to follow this instruction could result in personal injury or death.

The Safety Canopy deploys during significant side crashes or when a certain likelihood of a rollover event is detected by the rollover sensor. The Safety Canopy is mounted to the roof side rail sheet metal, behind the headliner, above each row of seats. In certain sideways crashes or rollover events, the Safety Canopy will be

activated, regardless of which seats are occupied. The Safety Canopy is designed to inflate between the side window area and occupants to further enhance protection provided in side impact crashes and rollover events.

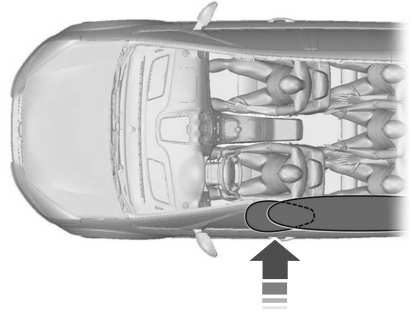

The system consists of the following:

- Safety Canopy curtain airbags above the trim panels over the front and rear side windows identified by a label or wording on the headliner or roof-pillar trim.
- A flexible headliner which opens above the side doors to allow air curtain deployment



• Crash sensors and monitoring system with a readiness indicator. See **Crash Sensors and Airbag Indicator** (page 48).

Properly restrain children 12 years old and under in the rear seats. The Safety Canopy will not interfere with children restrained using a properly installed child or booster seat because it is designed to inflate downward from the headliner above the doors along the side window opening.

Supplementary Restraints System

The design and development of the Safety Canopy included recommended testing procedures that were developed by a group of automotive safety experts known as the Side Airbag Technical Working Group. These recommended testing procedures help reduce the risk of injuries related to the deployment of side airbags (including the Safety Canopy).



The readiness light will not illuminate immediately after you switch the ignition on.

- The readiness light either flashes or stays lit.
- A series of five beeps is heard. The tone pattern repeats periodically until the problem, the light or both are repaired.

CRASH SENSORS AND AIRBAG INDICATOR



WARNING: Modifying or adding equipment to the front of your vehicle could affect the performance of the airbag system, increasing the risk of injury. This includes the hood, bumper system, frame, front body structure, tow hooks, hood pins, push bar and snowplows.

Your vehicle has a collection of crash and occupant sensors which provide information to the restraints control module. The restraints control module deploys (activates) the front and rear seatbelt pretensioners, driver airbag, passenger airbag, seat mounted side airbags and the Safety Canopy. Based on the type of crash, the restraints control module deploys the appropriate safety devices.

The restraints control module also monitors the readiness of the above safety devices plus the crash and occupant sensors. The readiness of the safety system is indicated by a warning indicator light in the instrument cluster or by a backup tone if the warning light is not working. Routine maintenance of the airbag is not required.

A difficulty with the system is indicated by one or more of the following:

If any of these things happen, even intermittently, have the supplemental restraint system serviced at an authorized dealer immediately. Unless serviced, the system may not function properly in the event of a crash.

The seatbelt pretensioners and the front airbag supplemental restraint system are designed to activate when the vehicle sustains frontal deceleration sufficient to cause the restraints control module to deploy a safety device.

The fact that the seatbelt pretensioners or front airbags did not activate for all occupants in a crash does not mean that something is wrong with the system. Rather, it means the restraints control module determined the accident conditions (crash severity, belt usage) were not appropriate to activate these safety devices.

- The design of the front airbags is to activate only in frontal and near-frontal crashes (not rollovers, side impacts or rear impacts) unless the crash causes sufficient frontal deceleration.
- The design of the seatbelt pretensioners is to activate in frontal, near-frontal and side crashes and in rollovers.

Supplementary Restraints System

- The design of the side airbags is to inflate in certain side impact crashes. Side airbags may activate in other types of crashes if the vehicle experiences sufficient sideways motion or deformation.
- The design of the Safety Canopy is to inflate in certain side impact crashes or rollover events. The Safety Canopy may activate in other types of crashes if the vehicle experiences sufficient sideways motion or deformation, or a certain likelihood of rollover.

AIRBAG DISPOSAL

Contact your authorized dealer as soon as possible. Airbags must be disposed of by qualified personnel.

911 Assist

WHAT IS 911 ASSIST

If a crash deploys an airbag, excluding knee airbags and rear inflatable seatbelts, or activates the fuel pump shut-off, your vehicle may be able to contact emergency services by dialing 911 through a paired and connected **Bluetooth**®-enabled phone.

Website
www.owner.ford.com
www.syncmyride.ca
www.syncmaroute.ca

Not all crashes will deploy an airbag or activate the fuel pump shut-off (the triggers for 911 Assist). If a connected cell phone sustains damage or loses its connection to SYNC during a crash, SYNC will search for and try to connect to a previously paired cell phone; SYNC will then attempt to call emergency services.

Before making the call:

- SYNC provides a short window of time (about 10 seconds) to cancel the call. If you fail to cancel the call, SYNC attempts to dial 911.
- SYNC says the following, or a similar message: "SYNC will attempt to call 911, to cancel the call, press Cancel on your screen or press and hold the phone button on your steering wheel."

If you do not cancel the call, and SYNC makes a successful call, a pre-recorded message plays for the 911 operator, and then the occupant(s) in your vehicle is able to talk with the operator. Be prepared to provide your name, phone number and location immediately, because not all 911 systems are capable of receiving this information electronically.

During an emergency call, the system transmits vehicle data to emergency services.

EMERGENCY CALL REQUIREMENTS



WARNING: Do not wait for 911 Assist to make an emergency call if you can do it yourself. Dial emergency services immediately to avoid delayed response time which could increase the risk of serious injury or death after a crash. If you do not hear 911 Assist within five seconds of the crash, the system or phone may be damaged or non-functional.



WARNING: Always place your phone in a secure location in your vehicle so it does not become a projectile or get damaged in a crash. Failure to do so may cause serious injury to someone or damage the phone which could prevent 911 Assist from working properly.



WARNING: Unless the 911 Assist setting is set on before a crash, the system will not dial for help which could delay response time, potentially increasing the risk of serious injury or death after a crash.

- SYNC must be powered and working properly at the time of the incident and throughout feature activation and use.
- The 911 Assist feature must be set on before the incident.
- You must pair and connect a **Bluetooth**® enabled and compatible cell phone to SYNC.
- A connected **Bluetooth**® enabled phone must have the ability to make and maintain an outgoing call at the time of the incident.

911 Assist

- A connected **Bluetooth**® enabled phone must have adequate network coverage, battery power and signal strength.
- The vehicle must have battery power and be located in the U.S., Canada or in a territory in which 911 is the emergency number.

Note: *If any user sets 911 Assist to on or off, that setting applies for all paired phones. If 911 Assist is switched off and the phone is connected to SYNC, an icon displays on the status bar.*

Note: *Every phone operates differently. While SYNC 911 Assist works with most cellular phones, some may have trouble using this feature.*

EMERGENCY CALL LIMITATIONS

The SYNC 911 Assist feature only operates in the U.S., Canada or in a territory in which 911 is the emergency number.

- Your cellular phone or 911 Assist hardware sustains damage in a crash.
- The vehicle's battery or the SYNC system has no power.
- The phone(s) thrown from your vehicle are the ones paired and connected to the system.

Keys and Remote Controls

GENERAL INFORMATION ON RADIO FREQUENCIES

This device complies with Part 15 of the FCC Rules and with Industry Canada license-exempt RSS standard(s). Operation is subject to the following two conditions: (1) This device may not cause harmful interference, and (2) This device must accept any interference received, including interference that may cause undesired operation.



WARNING: Changes or modifications not expressly approved by the party responsible for compliance could void the user's authority to operate the equipment. The term "IC:" before the radio certification number only signifies that Industry Canada technical specifications were met.

The typical operating range for your transmitter is approximately 33 ft (10 m). Vehicles with the remote start feature will have a greater range.

One of the following could cause a decrease in operating range:

- Weather conditions.
- Nearby radio towers.
- Structures around the vehicle.
- Other vehicles parked next to your vehicle.

The radio frequency used by your remote control can also be used by other radio transmitters, for example amateur radios, medical equipment, wireless headphones, wireless remote controls, cell phones, battery chargers and alarm systems. If the frequencies are jammed, you will not be able to use your remote control. You can lock and unlock the doors with the key.

Note: Make sure to lock your vehicle before leaving it unattended.

Note: If you are in range, the remote control will operate if you press any button unintentionally.

Note: The remote control contains sensitive electrical components. Exposure to moisture or impact may cause permanent damage.

Intelligent Access (If Equipped)

The system uses a radio frequency signal to communicate with your vehicle and authorize your vehicle to unlock when one of the following conditions are met:

- You activate the front exterior door handle switch.
- You press the luggage compartment button.
- You press a button on the transmitter.

If excessive radio frequency interference is present in the area or if the transmitter battery is low, you may need to mechanically unlock your door. You can use the mechanical key blade in your intelligent access key to open the driver door in this situation. See **Remote Control** (page 52).

REMOTE CONTROL

Integrated Keyhead Transmitter (If Equipped)

Use the key blade to start your vehicle and unlock or lock the driver door from outside your vehicle. The integrated keyhead transmitter functions as a programmed ignition key that operates all the locks and starts your vehicle, as well as a remote control.

Keys and Remote Controls



E277016

Press the button to release the key blade. Press and hold the button to fold the key blade back in when not in use.



Note: Your vehicle keys came with a security label that provides important key cut information. Keep the label in a safe place for future reference.

Intelligent Access Key (If Equipped)

Note: You may not be able to shift out of park (P) unless the intelligent access key is inside your vehicle.



E279948

The remote control operates the power locks. The remote control must be in your vehicle to use the push button start.

Removable Key Blade

The remote control also contains a removable key blade that you can use to unlock your vehicle.

Keys and Remote Controls



E279949

Press the release button and pull the key blade out.



Note: Your vehicle keys came with a security label that provides important key cut information. Keep the label in a safe place for future reference.

Replacing the Battery

WARNING: Keep batteries away from children to prevent ingestion. Failure to follow this instruction could result in personal injury or death. If ingested, immediately seek medical attention.

WARNING: If the battery compartment does not securely close, stop using the remote control and replace it as soon as possible. In the meantime, keep the remote control away from children. Failure to follow this instruction could result in personal injury or death.

Note: Refer to local regulations when disposing of remote control batteries.

Note: Do not wipe off any grease on the battery terminals or on the back surface of the circuit board.

Note: Replacing the battery does not erase the programmed key from your vehicle. The remote control should operate normally.

A message appears in the information display when the remote control battery is low. See **General Information** (page 96).

Integrated Keyhead Transmitter

The remote control uses one coin-type three-volt lithium battery.

Press the button to release the key blade before beginning the procedure.

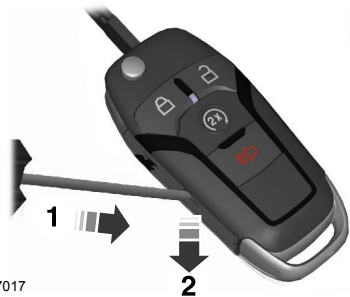

E277017

1. Insert a suitable tool, for example a screwdriver, in the position shown and gently push the clip.

Keys and Remote Controls

2. Press the clip down to release the battery cover.

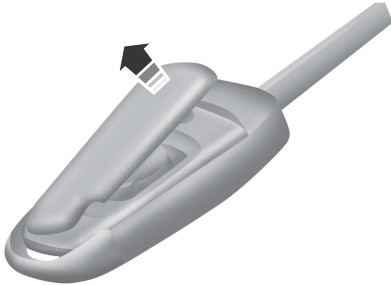

3. Carefully remove the cover.

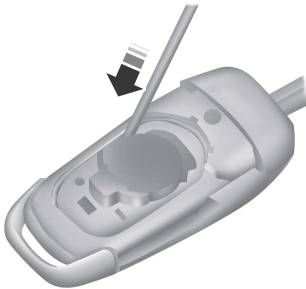

Note: Do not touch the battery contacts or the printed circuit board with the screwdriver.

4. Insert a screwdriver as shown to release the battery.

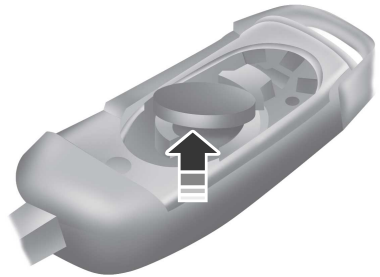

5. Remove the battery.
6. Install a new battery with the + facing up.
7. Replace the battery cover.

Intelligent Access Key

The remote control uses one coin-type three-volt lithium battery.



E279949

1. Push the release button and pull the key blade out.

Keys and Remote Controls

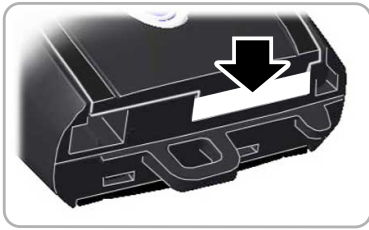

E218401

2. Twist a thin coin under the tab hidden behind the key blade head to remove the battery cover.

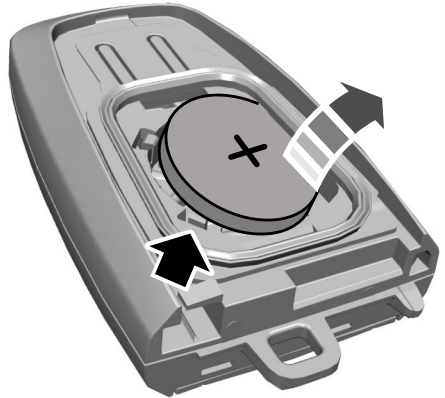

3. Insert a suitable tool, for example a screwdriver, in the position shown and carefully remove the battery.
4. Install a new battery with the + facing upward.
5. Reinstall the battery housing cover onto the remote control and install the key blade.

Car Finder



Press the button twice within three seconds. The horn sounds and the direction indicators flash.

Sounding a Panic Alarm (If Equipped)

Note: The panic alarm only operates when the ignition is off.



Press the button to activate the alarm. Press the button again or switch the ignition on to deactivate.

Keys and Remote Controls

Remote Start (If Equipped)



WARNING: Do not start the engine in a closed garage or in other enclosed areas. Exhaust fumes are toxic. Always open the garage door before you start the engine. Failure to follow this instruction could result in personal injury or death.

Note: Do not use remote start if your fuel level is low.



The remote start button is on the remote control.

This feature allows you to start your vehicle from the outside. The remote control has an extended operating range.

If your vehicle has automatic climate control, you can configure it to operate when you remote start your vehicle. See **Climate Control** (page 117). A manual climate control system will run at the setting it was set to when you switched your vehicle off.

Many states and provinces have restrictions for the use of remote start. Check your local and state or provincial laws for specific requirements regarding remote start systems.

The remote start system does not work if:

- The ignition is on.
- The alarm system triggers.
- You disable the feature.
- The hood is open.
- The transmission is not in park (P).
- The vehicle battery voltage is too low.
- The service engine soon light is on.

Remote Control Feedback (If Equipped)

An LED on the remote control provides status feedback of remote start or stop commands.

LED	Status
Solid green	Remote start successful
Solid red	Remote stop successful
Blinking red	Request failed or status not received
Blinking green	Status incomplete

Remote Starting Your Vehicle

Note: You must press each button within three seconds of each other. If you do not follow this sequence, your vehicle does not start remotely, the direction indicators do not flash twice and the horn does not sound.

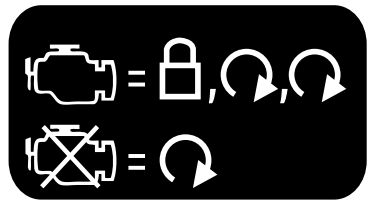

E138626

To remote start your vehicle:

1. Press the lock button to lock all the doors.
2. Press the remote start button twice. The exterior lamps flash twice.

The horn sounds if the system fails to start.

Note: You must press the push button ignition switch on the instrument panel once while applying the brake pedal before driving your vehicle.

Keys and Remote Controls

The power windows do not work during remote start and the radio does not turn on automatically.

The parking lamps remain on and your vehicle will run for 5, 10 or 15 minutes, depending on the setting.

Extending the Engine Running Time

To extend the engine running time duration of your vehicle during remote start, repeat steps 1 and 2 while the engine is running. If the duration is set to 15 minutes, the duration extends by another 15 minutes. For example, if your vehicle had been running from the first remote start for 10 minutes, your vehicle continues to run now for a total of 30 minutes. You can extend the engine running time duration to a maximum of 30 minutes.

Wait at least five seconds before remote starting after the engine stops running.

Turning Your Vehicle Off After Remote Starting



Press the button once. Your vehicle and the parking lamps turn off.

You may have to be closer to your vehicle than when starting due to ground reflection and the added noise of your running vehicle.

You can switch this feature on or off in the information display.

REPLACING A LOST KEY OR REMOTE CONTROL

Replacement keys or remote controls can be purchased from an authorized dealer. Authorized dealers can program remote controls for your vehicle.

PASSIVE KEY BACKUP POSITION (IF EQUIPPED)

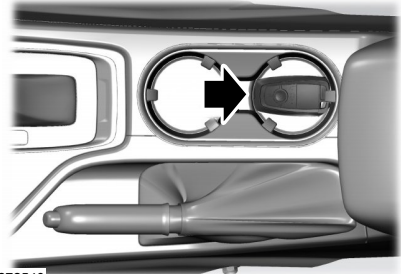

E272540

Place the passive key in the position shown, with the buttons facing upward. Make sure that you place the key fob in the center of the cup holder.

The top or bottom end of the key must be pointing towards the front or rear of the vehicle.

With the key in this position, press the brake or clutch pedal, then press the start button to switch on your vehicle.

PRINCIPLE OF OPERATION

MyKey allows you to program keys with restricted driving modes to promote good driving habits. You can program the restrictions to all keys except one. Any keys that you did not program are administrator keys or admin keys.

You can use admin keys to:

- Create a MyKey with certain vehicle restrictions.
- Program certain MyKey settings.
- Clear all MyKey restrictions.

After you program a MyKey, you can view the following information through the information display:

- The total number of admin keys and MyKeys for your vehicle.
- The total distance a MyKey driver traveled with your vehicle.

Note: Every MyKey receives the same restrictions and settings. You cannot program them individually.

Note: For vehicles equipped with a push-button start switch: When both a MyKey and an admin key are present when you start your vehicle, the system recognizes the admin key only.

Standard Settings

Not every vehicle includes the features listed below. If your vehicle has this equipment, then you cannot change the following settings when using a MyKey:

- Seatbelt reminder or Belt-Minder™. MyKey mutes the audio system until drivers, and in some instances, passengers, fasten their seatbelts.
Note: If your vehicle includes an AM/FM radio or a very basic audio system, then the radio may not mute.
- Earlier low-fuel warning. The low-fuel warning activates earlier for MyKey drivers, giving them more time to refuel.
- Certain driver alerts, stability systems or parking aids turn on automatically when you use the MyKey system. For example, Blind Spot Information System (BLIS), cross traffic alert, lane departure warning or forward collision warning. **Note:** MyKey drivers may be able to turn the lane departure warning feature off, but this feature turns back on automatically with every new key cycle.
- Restricted touchscreen operation in some markets. For example, MyKey may prevent manual navigation destination input while the vehicle is in any gear other than park (P) or when the vehicle reaches a certain rate of speed.
- Satellite radio adult content restrictions, if this feature is available in your market.

Optional Settings

You can configure certain vehicle feature settings when you first create a MyKey. You can also change the settings afterward with an admin key.

Note: *Not every feature applies to every vehicle in every market. When they are available for your vehicle, then they appear in the information display, providing choices to switch them on or off, or to select a more specific setting.*

- Various vehicle speed limits so the MyKey driver cannot exceed certain speeds. The information display shows warnings followed by an audible tone when the MyKey driver reaches the set speed. You cannot override the set speed by fully depressing the accelerator pedal.



WARNING: Do not set MyKey maximum speed limit to a limit that will prevent the driver from maintaining a safe speed considering posted speed limits and prevailing road conditions. The driver is always responsible to drive in accordance with local laws and prevailing conditions. Failure to do so could result in accident or injury.

- Various vehicle speed reminders so MyKey drivers know when their vehicle speed approaches the limits. Warnings appear in the information display and a tone sounds when the MyKey drivers exceed the set vehicle speed.
- The audio system's maximum volume limits to 45% so MyKey drivers can concentrate on the road. A message appears in the information display when MyKey drivers attempt to exceed the limited volume. MyKey also disables the automatic volume control. **Note:** If your vehicle includes an AM/FM radio or a very basic audio system, then the radio may not limit.
- Always on setting. This setting forces certain features to remain on and active for MyKey drivers. For example, E911 or emergency assistance and the do not disturb features stay on even if a MyKey driver uses the feature's control to switch it off. When selected, you will not be able to turn off Advance Trac or traction control (if your vehicle has this feature).

CREATING A MYKEY

Use the information display to create a MyKey:

1. Insert the key you want to program into the ignition. If your vehicle has a push-button start, place the remote control into the backup slot. See **Starting a Gasoline Engine** (page 143).
2. Switch the ignition on.
3. Access the main menu in the information display and then scroll through the menus to change the settings of your MyKey. From the MyKey menu select the option Create MyKey. See **Information Displays** (page 96).

4. Select **Yes** if you want to create the key as MyKey. A confirmation message appears on the screen.
5. Switch the ignition off.

You successfully created a MyKey. Make sure you label it so you can distinguish it from the admin keys.

You can also program configurable settings for the key(s). See **Programming and Changing Configurable Settings**.

Programming and Changing Configurable Settings

Use the information display to access your configurable MyKey settings.

1. Switch the ignition on using an admin key or transmitter you want to program.
2. Access the main menu in the information display and then scroll through the menus to change the settings of your MyKey. See **Information Displays** (page 96).
3. Follow the instructions in the display. The programmed restrictions apply when you switch the vehicle off, open and close the driver door and restart your vehicle with the programmed key or transmitter.

Note: *You can clear or change your MyKey settings at any time during the same key cycle as you created the MyKey. Once you have switched the vehicle off, however, you need an admin key to change or clear your MyKey settings. When you make any changes to your MyKey settings, you change the settings for every MyKey. You cannot make individual changes to apply to certain MyKeys.*

CLEARING ALL MYKEYS

When you clear your MyKeys, you remove all restrictions and return all MyKeys to their original admin key status at once. To clear all MyKeys of all MyKey settings, use the information display.

1. Switch the ignition on using an admin key.
2. Access the main menu in the information display and then scroll through the menus to begin clearing your MyKey programming. See **Information Displays** (page 96).
3. Follow the instructions in the display.
4. A confirmation message appears in the display after you finish clearing your MyKeys.

Note: *When you clear your MyKeys, you remove all restrictions and return all MyKeys to their original admin key status. You cannot remove the MyKey restrictions individually.*

CHECKING MYKEY SYSTEM STATUS

You can find information about your programmed MyKeys by using the information display. See **Information Displays** (page 96).

MyKey Distance

Tracks the distance when drivers use a MyKey. The only way to delete the accumulated distance is by using an admin key to clear all MyKeys. If the distance does not accumulate as expected, then the intended user is not using the MyKey, or an admin key user recently cleared and then recreated a MyKey.

Number of MyKeys

Indicates the number of MyKeys programmed to your vehicle. Use this feature to detect how many MyKeys you have for your vehicle and determine when all MyKeys have been deleted.

Number of Admin Keys

Indicates how many admin keys are programmed to your vehicle. Use this feature to determine how many admin keys you have for your vehicle, and detect if an additional MyKey has been programmed.

USING MYKEY WITH REMOTE START SYSTEMS

MyKey is not compatible with non Ford-approved, aftermarket remote start systems. If you choose to install a remote start system, see an authorized dealer for a Ford-approved remote start system.

MYKEY – TROUBLESHOOTING

Condition	Potential Causes
I cannot create a MyKey.	The key or transmitter used to start the vehicle does not have admin privileges. Vehicles with keyless start: Make sure you place the transmitter into the backup slot. See Passive Anti-Theft System (page 70). The key or transmitter used to start the vehicle is the only admin key. There always has to be at least one admin key. The passive anti-theft system is disabled or in unlimited mode.
I cannot program the configurable settings.	The transmitter used to start your vehicle does not have admin privileges. There are no MyKeys programmed to the vehicle. See Creating a MyKey (page 60).
I cannot clear the MyKeys.	The key or transmitter used to start the vehicle does not have admin privileges. No MyKeys are created. See Creating a MyKey (page 60).
I lost the only admin key.	Purchase a new key or transmitter from an authorized dealer.

MyKey™

Condition	Potential Causes
I lost a key.	Program a spare key or transmitter. You may need to see an authorized dealer. See Passive Anti-Theft System (page 70).
The MyKey distance does not accumulate.	The MyKey user is not using the MyKey. An admin key holder cleared the MyKeys and created new MyKeys. The key system has been reset.
No MyKey functions with the transmitter.	An admin transmitter is present at vehicle start. There are no MyKeys programmed to your vehicle. See Creating a MyKey (page 60).

Doors and Locks

LOCKING AND UNLOCKING

You can use the power door lock control or the remote control to lock and unlock your doors. This is also true for the tailgate if your vehicle comes with power tailgate lock. See **Tailgate Lock** (page 68).

Note: Always take your keys and lock all doors when leaving your vehicle.

Note: Do not use the door latch assembly to attach any accessory, such as handles or steps, as this can cause damage to your vehicle.

Power Door Locks

The power door lock control is on the driver and front passenger door panels.

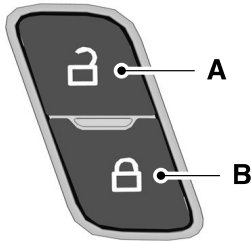

- A Unlock.
- B Lock.

Door Lock Indicator

An LED on the power door lock control illuminates when you lock the door.

Door Lock Switch Inhibitor

The power door lock switch no longer operates after 20 seconds. You must unlock your vehicle with the remote control, or switch the ignition on to restore function to these switches.

Remote Control

Unlocking the Doors - Two-Stage Unlock



Press the button to unlock the driver door.

Press the button again within three seconds to unlock all doors. The direction indicators will flash.

With the ignition off, press and hold both the lock and unlock buttons on the remote control for three seconds to change between driver door or all door unlock mode. The direction indicators will flash twice to indicate a change to the unlocking mode. Driver door mode only unlocks the driver door when you press the unlock button once. All door mode unlocks all doors when you press the unlock button once. The unlocking mode applies to the remote control and Intelligent Access Key.

Locking the Doors



Press the button to lock all doors. The direction indicators will flash.

Press the button again within three seconds to confirm that all the doors are closed. The doors will lock again, the horn will sound and the direction indicators will flash if all the doors are closed.

Locking and Unlocking the Doors with the Key Blade

Turn the top of the key toward the front of your vehicle once to lock all doors. Turn the top of the key toward the rear of your vehicle once to unlock only the driver door.

If the central locking function does not operate, lock the doors individually using the key in the position shown.

Doors and Locks

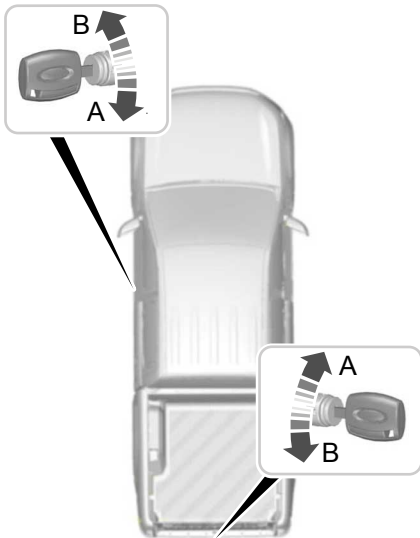

E237137

- A Unlock.
- B Lock.

Opening a Rear Door from the Inside

Pull the interior door handle twice to unlock and open a rear door. The first pull unlocks the door and the second pull opens the door.

Activating Intelligent Access (if Equipped)

General Information

You can unlock and lock the vehicle without taking the keys out of your pocket or purse when your passive key is within 3 ft (1 m) of your vehicle. Passive entry uses a sensor on the back of the front door handle for unlocking and a separate sensor on the face of each door handle for locking.

The system does not function if:

- The vehicle battery has no charge.
- The key battery has no charge.
- The key frequencies have jammed.

Note: The system is available on the front doors only.

Note: The system may not function if the key is close to metal objects or electronic devices, for example keys or a cell phone.

Note: If the system does not function, use the key blade to lock and unlock your vehicle. See **Remote Control** (page 52).

Note: The system also unlocks and locks the luggage compartment.

Unlocking Using Passive Entry



With your passive key within 3 ft (1 m) of your vehicle, touch the unlock sensor on the back of the door handle for a brief period and then pull on the door handle to unlock, being careful not to touch the lock sensor at the same time, or to pull the door handle too quickly. The system requires a brief delay to authenticate your passive key.

Doors and Locks

Locking Using Passive Entry

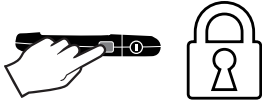

With your passive key within 3 ft (1 m) of your vehicle, touch the outer door handle lock sensor for approximately one second to lock, being careful not to touch the unlock sensor on the back of the door handle at the same time. After locking, you can immediately pull on the door handle to confirm locking occurred without inadvertently unlocking.

Note: Do not use the outside door handle as an anchor-point for the cargo strap.

Smart Unlocks for Integrated Keyhead Transmitter (If Equipped)

This helps to prevent you from locking yourself out of your vehicle if the key is still in the ignition.

When you open one of the front doors and lock your vehicle with the power door lock control, all the doors will lock then unlock and the horn will sound twice if the key is still in the ignition.

You can still lock your vehicle with the key in the ignition by:

- Pressing the lock button on the remote control even if the doors are not closed.

If both front doors are closed, you can lock your vehicle by any method, regardless of whether the key is in the ignition or not.

Mislock (If Equipped)

The horn sounds twice and the direction indicators do not flash:

- If any door or the luggage compartment is open.
- If the hood is open on vehicles with an anti-theft alarm or remote start.

You can switch this feature on or off in the information display. See **General Information** (page 96).

Autolock (If Equipped)

Autolock locks all the doors when:

- All doors are closed.
- The ignition is on.
- You shift into any gear putting your vehicle in motion.
- Your vehicle reaches a speed greater than 4 mph (7 km/h).

Autolock repeats when:

- You open then close any door while the ignition is on and your vehicle speed is 4 mph (7 km/h) or lower.
- Your vehicle reaches a speed greater than 4 mph (7 km/h).

Autounlock

Autounlock unlocks all the doors when:

- The ignition is on, all the doors are closed, and your vehicle has been moving at a speed greater than 4 mph (7 km/h).
- Your vehicle comes to a stop and you switch the ignition off or to the accessory position.
- You open the driver door within 10 minutes of switching the ignition off or to accessory.

Doors and Locks

Note: *The doors do not autounlock if you electronically lock your vehicle after you switch the ignition off and before you open the driver door.*

Enabling or Disabling Autounlock

You can enable or disable the autounlock feature in the information display or an authorized dealer can do it for you. See **General Information** (page 96).

Tailgate

TAILGATE LOCK

The tailgate lock can help prevent theft of the tailgate.

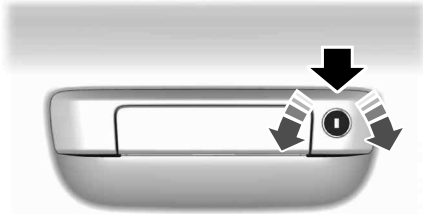

Insert the ignition key into the tailgate lock. Turn it to the left to lock the tailgate. Turn it to the right to unlock the tailgate.

Power Tailgate Lock (If Equipped)

You can use the power door lock control or the remote control to lock and unlock your tailgate.

REMOVING THE TAILGATE



WARNING: Always properly secure cargo to prevent shifting cargo or cargo falling from the vehicle. Failure to do so could result in compromised vehicle stability and serious personal injury to vehicle occupants or others.

You can remove the tailgate for more loading room.

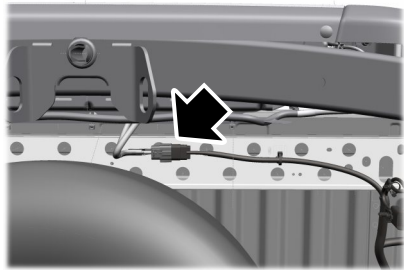

1. Locate and disconnect the in-line connector. It is under the pickup box on the center right-hand side of the vehicle near the spare tire.
2. There is a protective cap in the glove box. Install it on the in-line connector that remains under the pickup box.
3. Partially lower the tailgate. Carefully feed the tailgate harness up through the gap between the pickup box and the bumper and place it out of the way under the pickup box.
4. Lower the tailgate.

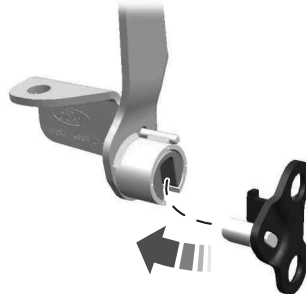

5. Lift the tailgate to 45 degrees from horizontal.
6. Lift the right side off its hinge.

Tailgate

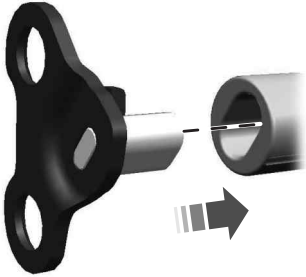

7. Remove the tailgate from the left-hand side hinge by sliding it to the right.
Reverse the steps to reinstall the tailgate.

Security

PASSIVE ANTI-THEFT SYSTEM

Note: The system is not compatible with non-Ford aftermarket remote start systems. Use of these systems could result in vehicle starting problems and a loss of security protection.

Note: Metallic objects, electronic devices or a second coded key on the same key chain could cause vehicle starting problems if they are too close to the key when starting the engine. Prevent these objects from touching the coded key while starting the engine. Switch the ignition off, move all objects on the key chain away from the coded key and restart the engine if a problem occurs.

Note: Do not leave a duplicate coded key in the vehicle. Always take your keys and lock all doors when leaving the vehicle.

SecuriLock®

The system is an engine immobilization system. It helps to prevent anyone from starting the engine without using a coded key programmed to your vehicle. Using the wrong key could prevent the engine from starting. A message may appear in the information display.

If you are unable to start the engine with a correctly coded key, there is a problem with the system and a message could appear in the information display.

Automatic Arming

The vehicle arms immediately after you switch the ignition off.

Automatic Disarming

Switching the ignition on with a coded key disarms the vehicle.

Replacement Keys

Note: Your vehicle comes with two integrated keyhead transmitters or two intelligent access keys.

The integrated keyhead transmitter functions as a programmed ignition key that operates all the locks and starts the vehicle, as well as a remote control.

The intelligent access key functions as a programmed key that operates the driver door lock and activates the intelligent access with push button start system, as well as a remote control.

If your programmed transmitters or standard SecuriLock coded keys (integrated keyhead transmitters only) are lost or stolen and you do not have an extra coded key, you will need to have your vehicle towed to an authorized dealer. You need to erase the key codes from your vehicle and program new coded keys.

Store an extra programmed key away from the vehicle in a safe place to help prevent any inconveniences. See your authorized dealer to purchase additional spare or replacement keys.

Programming a Spare Intelligent Access Key (If Equipped)

See your authorized dealer to have additional keys programmed to your vehicle.

ANTI-THEFT ALARM (IF EQUIPPED)

Alarm System

Perimeter Alarm

The perimeter alarm is a deterrent against unauthorized access to your vehicle through the doors, luggage compartment and the hood.

Security

Panic Alarm (If Equipped)

The alarm can be activated using the remote control.

Triggering the Alarm

- If someone opens a door or the hood without a valid key or remote control.
- If you switch the ignition on without a valid key.

If the alarm sounds, the alarm horn sounds for 30 seconds and the hazard warning lamps flash for five minutes.

Any further attempts to carry out one of the above will sound the alarm again.

Arming the Alarm

Press the lock button once to lock your vehicle and arm the alarm.

Disarming the Alarm

Disarm the alarm by any of the following actions:

- Unlock the doors with the key and switch the ignition on with a correctly coded key within 12 seconds.
- Unlock the doors or luggage compartment using the remote control.

Steering Wheel

ADJUSTING THE STEERING WHEEL



WARNING: Do not adjust the steering wheel when your vehicle is moving.

Note: Make sure that you are sitting in the correct position. See **Sitting in the Correct Position** (page 124).

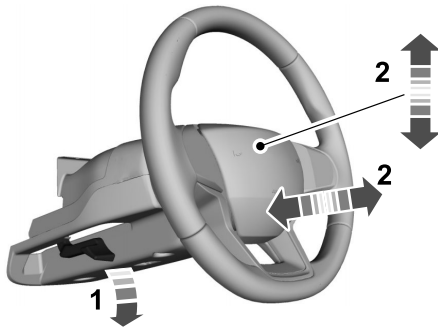

E279960

1. Unlock the steering column.
2. Adjust the steering wheel to the desired position.

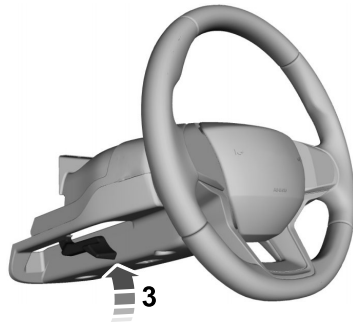

E279962

3. Lock the steering column.

AUDIO CONTROL

Type One



E279395

Steering Wheel

Type Two



E272251



E272252

You can operate the following functions with the control:



Press to access phone mode or to answer a phone call.



Press to end a phone call.



Press to silence the current media



Press + or - to increase or to decrease volume levels.



Press to access the previous media selection.



Press to access the next media selection.



Press to change the media source.



Press to access the settings menu on the SYNC screen.



Press to access the home screen.

VOICE CONTROL

The controls are on the steering wheel.



Press and release to activate voice recognition.

CRUISE CONTROL (IF EQUIPPED)

Type One



E200995

See **Using Cruise Control** (page 192).

Steering Wheel

Type Two

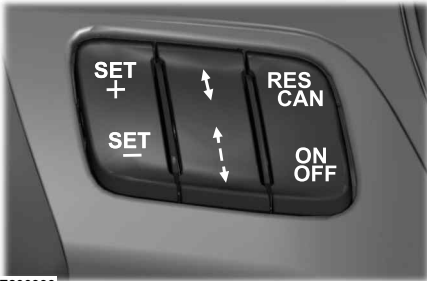

E200996

See **Using Adaptive Cruise Control** (page 193).

Use the controls to adjust the information display. Navigate through the screen and press **OK** to select. See **General Information** (page 96).

HORN



INFORMATION DISPLAY CONTROL



E205893

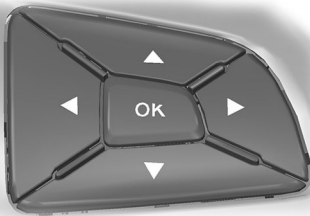

E201420

Wipers and Washers

WINDSHIELD WIPERS



Push the lever up or down to operate the windshield wipers.

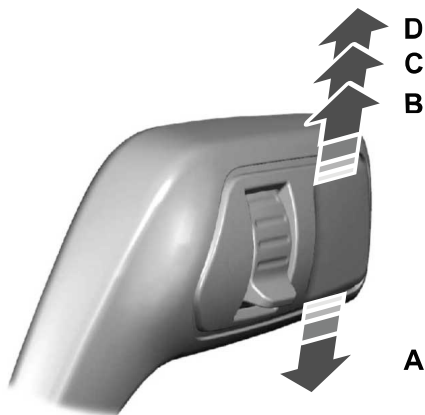

- A Single wipe.
- B Intermittent wipe.
- C Normal wipe.
- D High-speed wipe.

Note: Fully defrost the windshield before you switch the windshield wipers on.

Note: Make sure that you switch the windshield wipers off before entering a car wash.

Note: If streaks or smears appear on the windshield, clean the windshield and the wiper blades. If that does not resolve the issue, install new wiper blades.

Note: Do not operate the wipers on a dry windshield. This may scratch the glass, damage the wiper blades or cause the wiper motor to burn out. Always use the windshield washers before wiping a dry windshield.

Intermittent Wipe

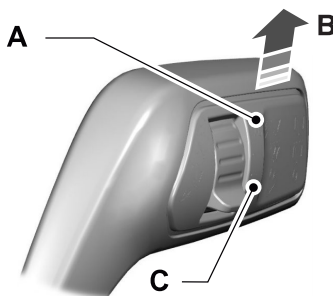

- A Shortest wipe interval.
- B Intermittent wipe.
- C Longest wipe interval.

Use the rotary control to adjust the intermittent wipe interval.

Speed Dependent Wipers

When your vehicle speed increases, the interval between wipes decreases.

AUTOWIPERS (IF EQUIPPED)

Wet or winter driving conditions with ice, snow or salty road mist can cause inconsistent and unexpected wiping or smearing.

Wipers and Washers

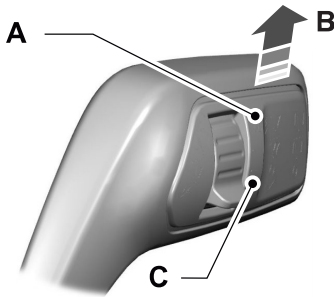

- A High sensitivity.
- B Autowipers On.
- C Low sensitivity.

Use the rotary control to adjust the sensitivity of the autowipers. When you select low sensitivity, the wipers operate when the sensor detects a large amount of water on the windshield. When you select high sensitivity, the wipers operate when the sensor detects a small amount of water on the windshield.

Keep the outside of the windshield clean. The rain sensor is very sensitive and the wipers may operate if dirt, mist or insects hit the windshield.

In these conditions, you can do the following:

- Lower the sensitivity of the autowipers to reduce the amount of smearing on the windshield.
- Switch to normal or high-speed wipe.
- Switch autowipers off.

Note: Fully defrost the windshield before you switch the windshield wipers on.

Note: Make sure that you switch the windshield wipers off before entering a car wash.

Note: If streaks or smears appear on the windshield, clean the windshield and the wiper blades. If that does not resolve the issue, install new wiper blades.

Note: If you switch autolamps and autowipers on, the headlamps turn on when the windshield wipers continuously operate.

Autowipers Settings

Autowipers defaults to on and remains on until you switch it off in the information display. When you switch off autowipers, the wipers operate in intermittent mode.

WINDSHIELD WASHERS



Pull the lever toward you to operate the windshield washers.

When you release the lever, the wipers operate for a short time. When activated, a courtesy wipe occurs a short time after the wipers stop to clear any remaining washer fluid.

Note: You can switch courtesy wipe on or off in the information display. See **Information Displays** (page 96).

Note: Do not operate the washers when the washer reservoir is empty. This could cause the washer pump to overheat.

Lighting

GENERAL INFORMATION

Condensation in the Exterior Front Lamps and Rear Lamps

Exterior front lamps and rear lamps have vents to accommodate normal changes in air pressure.

Condensation can be a natural by-product of this design. When moist air enters the lamp assembly through the vents, there is a possibility that condensation can occur when the temperature is cold. When normal condensation occurs, a fine mist can form on the interior of the lens. The fine mist eventually clears and exits through the vents during normal operation.

Clearing time may take as long as 48 hours under dry weather conditions.

Examples of acceptable condensation are:

- The presence of a fine mist (no streaks, drip marks or large droplets).
- A fine mist covers less than 50% of the lens.

Examples of unacceptable condensation are:

- A water puddle inside the lamp.
- Streaks, drip marks or large droplets present on the interior of the lens.

If you see any unacceptable condensation, have your vehicle checked by an authorized dealer.

LIGHTING CONTROL

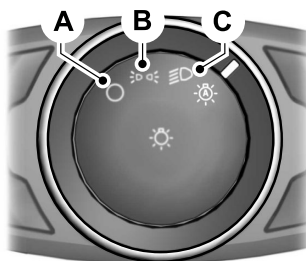

- A Lamps off.
- B Parking lamps, instrument panel lamps, license plate lamps and tail lamps.
- C Headlamps.

Headlamp High Beam



E242674



Push the lever away from you to switch the high beam on.

Push the lever forward again or pull the lever toward you to switch the high beams off.

Lighting

Flashing the Headlamp High Beam



E242675

Slightly pull the lever toward you and release it to flash the headlamps.

AUTOLAMPS



WARNING: The system does not relieve you of your responsibility to drive with due care and attention. You may need to override the system if it does not turn the headlamps on in low visibility conditions, for example daytime fog.

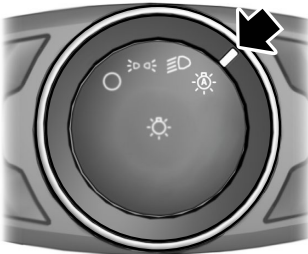

E142451

When the lighting control is in the autolamps position, the headlamps turn on in low light situations, or when the wipers turn on.

The headlamps remain on for a period of time after you switch the ignition off. Use the information display controls to adjust the period of time that the headlamps remain on.

Note: If you switch the autolamps on, you cannot switch the high beams on until the system turns the low beams on.

Windshield Wiper Activated Headlamps

When you switch the autolamps on, the headlamps turn on within 10 seconds of switching the wipers on. They turn off approximately 60 seconds after you switch the windshield wipers off.

The headlamps do not turn on with the wipers:

- During a single wipe.
- When using the windshield washers.
- If the wipers are in intermittent mode.

Note: If you switch the autolamps and the autowipers on, the headlamps turn on when the windshield wipers continuously operate.

INSTRUMENT LIGHTING DIMMER

Note: When disconnecting the battery or when it runs out of charge, the illuminated components turn to the maximum setting.

Lighting

Vehicles With Front Fog Lamps

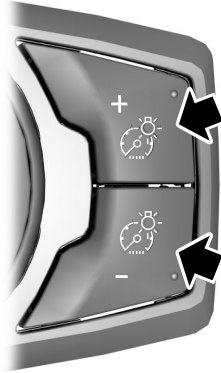

E231828

Press repeatedly or press and hold until you reach the desired level.

Vehicles Without Front Fog Lamps



E165366

- A Press repeatedly or press and hold to dim.
- B Press repeatedly or press and hold to brighten.

DAYTIME RUNNING LAMPS

WARNING: The daytime running lamps system does not activate the rear lamps and may not provide adequate lighting during low visibility driving conditions. Make sure you switch the headlamps on, as appropriate, during all low visibility conditions. Failure to do so may result in a crash.

The system turns the lamps on in daylight conditions.

To switch the system on, switch the lighting control to any position except headlamps.

AUTOMATIC HIGH BEAM CONTROL

WARNING: The system does not relieve you of your responsibility to drive with due care and attention. You may need to override the system if it does not turn the high beams on or off.

The system turns on high beams if it is dark enough and no other traffic is present. If it detects an approaching vehicle's headlamps or tail lamps, or street lighting ahead, the system turns off high beams before they can distract other road users. Low beams remain on.

Note: The system may not operate properly if the sensor is blocked. Keep the windshield free from obstruction or damage.

Note: The system may not operate properly in cold or inclement conditions. You can switch on the high beams by overriding the system.

Lighting

Note: If the system detects a blockage, for example bird droppings, bug splatter, snow or ice, the system goes into low beam mode until you clear the blockage. A message may appear in the information display if the camera is blocked.

Note: Using much larger tires or equipping vehicle accessories such as snowplows can modify your vehicle's ride height and degrade automatic high beam control performance.

A camera sensor, centrally mounted behind the windshield of your vehicle, continuously monitors conditions to turn the high beams on and off.

Once the system is active, the high beams turn on if:

- The ambient light level is low enough.
- There is no traffic in front of your vehicle.
- The vehicle speed is greater than approximately 32 mph (51 km/h).

The system turns the high beams off if:

- The ambient light level is high enough that high beams are not required.
- The system detects an approaching vehicle's headlamps or tail lamps.
- The vehicle speed falls below approximately 27 mph (44 km/h).
- The system detects severe rain, snow or fog.
- The camera is blocked.

Switching the System On and Off

Switch the system on using the information display. See **Information Displays** (page 96).

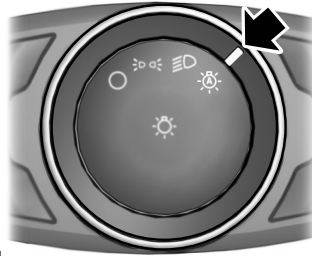

E142451

Switch the lighting control to the autolamps position. See **Autolamps** (page 78).

Overriding the System

Push the lever away from you to switch between high beam and low beam.

Automatic High Beam Indicator



The indicator illuminates to confirm when the system is ready to assist.

FRONT FOG LAMPS

Using the Front Fog Lamps

To switch the lamps on or off:

1. Set the lighting control to the parking lamps, headlamps or autolamps position.

Note: When the lighting control is in the autolamps position, you cannot switch the fog lamps on unless the low beam headlamps are on.

- 2.



Press the button on the lighting control to switch the front fog lamps on or off.

Note: Only switch the front fog lamps on during reduced visibility.

Lighting

Note: The brightness of the daytime running lamps may decrease when the front fog lamps are on.

Note: The lights on the front fog lamps turn off when you switch the high beams on.

Front Fog Lamp Indicator



It illuminates when you switch the front fog lamps on.

DIRECTION INDICATORS

Switching the Direction Indicators On and Off



Push the lever up or down to switch the direction indicators on.

Note: Tap the lever up or down to make the direction indicators flash three times.

Set the lever to the middle position to switch the direction indicators off.

Direction Indicator



Flashes when you switch the direction indicators on.

Note: An increase in the rate of flashing warns of a failed indicator bulb.

INTERIOR LAMPS

Courtesy Lamp

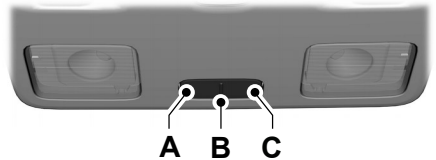

E249790

- A Switch all lamps on.
- B Switch lamps on and off by door.
- C Switch all lamps off.

If you set the switch to the door position, the courtesy lamp illuminates when you unlock or open any door. If you leave a door open with the ignition switched off, the courtesy lamp goes off after some time to prevent your vehicle battery from losing charge. To switch it back on, switch the ignition on for a short time.

The courtesy lamp also illuminates when you switch the ignition off. It goes off after a short time or when you start the engine.

If you set the switch to the all on position with the ignition switched off, the courtesy lamp illuminates. It goes off after a short time to prevent your vehicle battery from losing charge. To switch it back on, switch the ignition on for a short time.

Reading Lamps



Lighting

Press the edge of the lamp lens to switch on and off.

If you switch the ignition off, the reading lamps turn off after a short time.

Note: *This is to prevent the vehicle battery from losing charge.*

Rear Courtesy Lamp

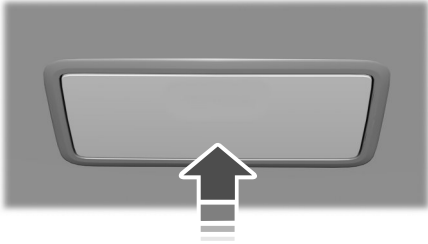

For rear lamps without a position switch, press the lamp lens to switch on and off.

AMBIENT LIGHTING (IF EQUIPPED)

Use the touchscreen to select the following:



Select the settings option on the feature bar.



Select ambient lighting.



E280369

Switching Ambient Lighting On

Touch a color once.

Changing the Color

Touch any color once.

Adjusting the Brightness

Drag the selected color up or down.

Switching Ambient Lighting Off

Touch the selected color once or drag the selected color down to zero brightness.

CARGO LAMPS



Press the button on the lighting control to switch on the lamps.

Note: *The lamps turn off when you reach 3 mph (5 km/h).*

Note: *The cargo lamps gradually turn off after a period of time.*

Windows and Mirrors

POWER WINDOWS



WARNING: Do not leave children or pets unattended in your vehicle. Failure to follow this instruction could result in personal injury or death.



WARNING: When closing the power windows, verify they are free of obstruction and make sure that children and pets are not in the proximity of the window openings.

Note: If you operate the switches often during a short period of time the system might become inoperable for a certain time to prevent damage due to overheating.

Note: If you operate both the switch on the relevant door and the switch for that window on the driver's door at the same time, the window stops moving.

Note: You may hear a pulsing noise when you open just one of the windows. Lower the opposite window slightly to reduce this noise.

Driver Door Switches (Single Cab)

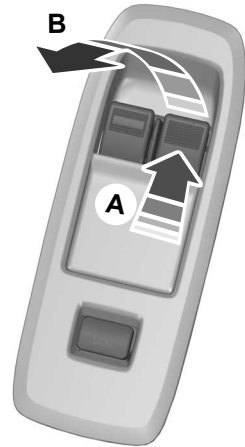

E131469

- A Press the switch to open the window.
- B Lift the switch to close the window.

Windows and Mirrors

Driver Door Switches (Double Cab)

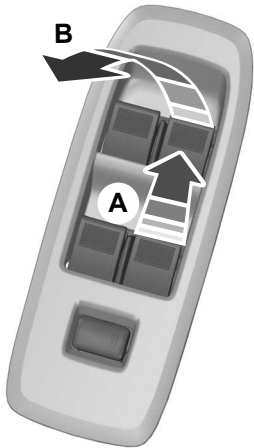

E131466

- A Press the switch to open the window.
- B Lift the switch to close the window.

Front and Rear Passenger Door Switches

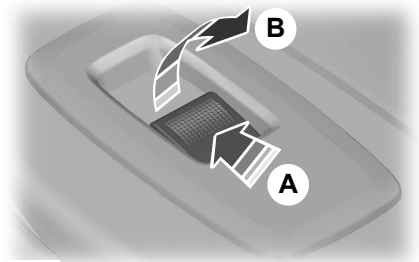

E131467

- A Press the switch to open the window.
- B Lift the switch to close the window.

Opening and Closing the Driver Side Window Automatically

Press or lift the switch to the second action point and release it.

Press again or lift it to stop the window.

Opening and Closing Other Windows Automatically (If Equipped)

Press or lift the switch to the second action point and release it.

Press again or lift it to stop the window.

Safety Switch for the Rear Windows

Note: Once you press the safety switch, you can still operate the rear windows and front passenger window from the driver door if you have global opening and closing.

Windows and Mirrors

Note: In vehicles without global opening and closing, you cannot operate the rear windows from driver side when you press the safety switch. In certain vehicles, you cannot operate front passenger windows as well.

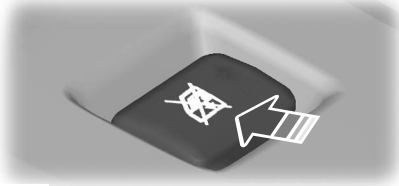

E131468

Press the control to lock or unlock the rear window controls.

Resetting the Memory of the Electric Windows - Vehicle with One Touch Up/Down on Driver Side only

Note: The bounce back feature remains turned off until you reset the memory.

In the event of a flat battery or after the battery is disconnected from the vehicle, you must reset the memory for the driver window.

1. Open the window and then try to close it using the one-touch feature.
2. Lift and hold the switch to the second action point until you fully close the window.
3. Lift and hold the switch for more than two seconds and release.
4. Open the window using the first action point and try to close it automatically using the second action point.
5. If the window does not open or close automatically when you press the switch or lift it to the second action point, repeat the procedure.

Safety Mode

Note: The anti-trap function is not active during this procedure.

If the system detects a malfunction, it enters a safety mode. The windows move a little at a time and then stop again. Close the windows by pressing the switch again when the windows stop moving.

Contact an authorized dealer.

Bounce-Back

The window automatically stops and reverses some distance if it detects an obstacle when closing.

Overriding the Bounce-Back Feature

 **WARNING:** If you override bounce-back, the window does not reverse if it detects an obstacle. Take care when closing the windows to avoid personal injury or damage to your vehicle.

Proceed as follows to override this protection feature when there is a resistance, for example in winter:

1. Close the window twice until it reaches the point of resistance and let it reverse.
2. Close the window a third time to the point of resistance. The bounce-back feature is now disabled and you can close the window manually. The window will go past the point of resistance and you can close it fully.

See an authorized dealer as soon as possible if the window does not close after the third attempt.

Resetting the Bounce-Back Feature

Note: The bounce-back feature remains turned off until you reset the memory.

Windows and Mirrors

If you disconnect the battery, you must reset the bounce-back memory separately for each window.

1. Lift and hold the switch until you fully close the window.
2. Release the switch.
3. Lift the switch again for one second.
4. Press and hold the switch until you fully close the window.
5. Release the switch.
6. Lift and hold the switch until you fully close the window.
7. Open the window and then try to close it automatically.
8. Reset and repeat the procedure if the window does not close automatically.

EXTERIOR MIRRORS

Power Exterior Mirrors (If Equipped)



WARNING: Do not adjust the mirrors when your vehicle is moving. This could result in the loss of control of your vehicle, serious personal injury or death.

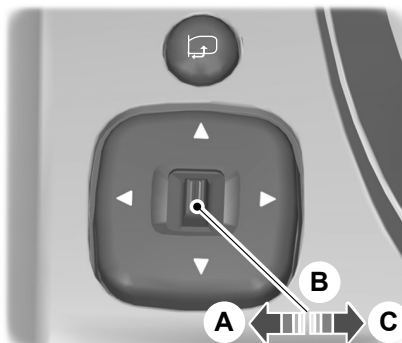

E131480

- A Left-hand side.
- B Off.
- C Right-hand side.

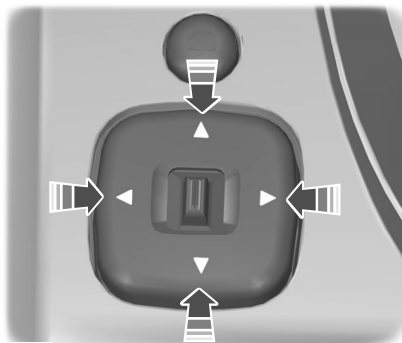

E131481

Press the arrows to adjust the mirror.

Fold Away Exterior Mirrors

Push the mirror toward the door window glass.

Make sure that you fully engage the mirror in its support when returning it to its original position.

Windows and Mirrors

Power-Folding Mirrors (If Equipped)

The power folding mirrors operate with the ignition on.

Note: *The mirrors no longer operate if you switch the ignition off.*

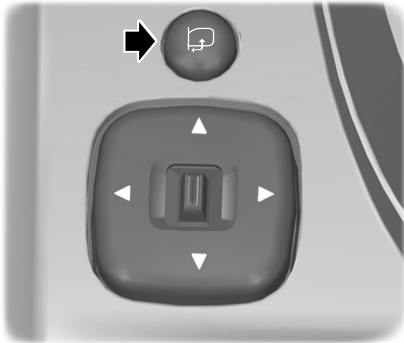

E131482

Press the button to fold the mirrors inward.

Release the button to stop and reverse the direction of movement, or to fold the mirrors outward.

Loose Mirror

If you manually fold your power-folding mirrors, they may not work properly even after you re-position them. You need to reset them if:

- The mirrors vibrate when you drive.
- The mirrors feel loose.
- The mirrors do not stay in the folded or unfolded position.
- One of the mirrors is not in its normal driving position.

To reset the power-fold feature:

1. Push the mirrors fully forward.
2. Press the mirror folding switch and guide the mirror to detent point, you will hear a click at this point.

3. Let the mirror fold toward your vehicle on its own.
4. Verify by pressing the mirror folding switch to fold mirrors inward and back out 2 or 3 times.

Note: *You may hear a loud noise as you reset the power-folding mirrors. This sound is normal. Repeat this process as needed each time you manually fold the mirrors.*

Heated Exterior Mirrors (If Equipped)

The heated exterior mirrors will remove ice, mist and fog. See **Heated Rear Window** (page 122).

Signal Indicator Mirrors (If Equipped)

The outer portion of the appropriate mirror housing blinks when you switch on the direction indicator.

Puddle Lamps (If Equipped)

The lamps on the bottom part of the mirror housing light when you use your transmitter to unlock the doors or when you open a door.

Blind Spot Information System (If Equipped)

See **Blind Spot Information System** (page 206).

INTERIOR MIRROR



WARNING: Do not adjust the mirrors when your vehicle is moving. This could result in the loss of control of your vehicle, serious personal injury or death.

Windows and Mirrors

Manual Dimming Mirror

Pull the tab below the mirror toward you to reduce the effect of bright light from behind.

Automatic Dimming Mirror (If Equipped)

The mirror dims to reduce the effect of bright light from behind. It returns to normal when the bright light from behind is no longer present or if you shift into reverse (R).

Do not block the sensors on the front and back of the mirror.

Note: A rear center passenger or raised rear center head restraint could prevent light from reaching the sensor.

Illuminated Vanity Mirror (If Equipped)

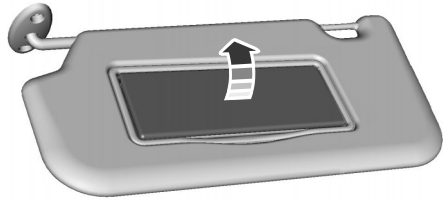

E162197

Lift the cover to switch the lamp on.

SUN VISORS

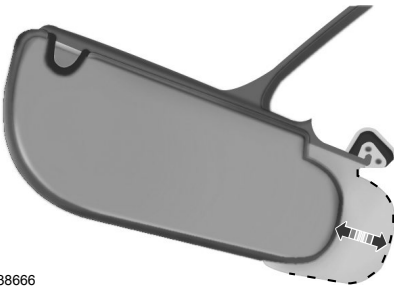

E138666

Rotate the sun visor toward the side window and extend it rearward for extra shade.

Instrument Cluster

GAUGES

Type 1 and 2

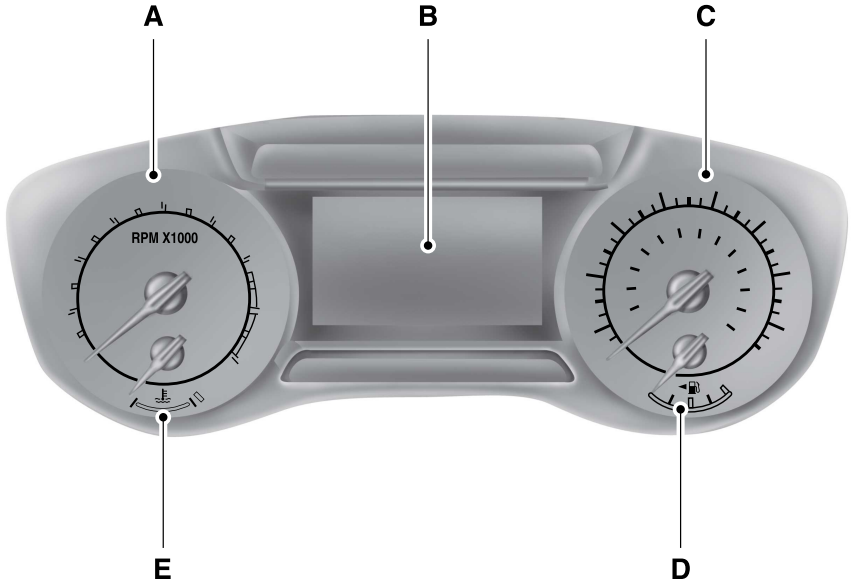

E271817

- A Tachometer
- B Information Display (Type 2 shown Type 1 similar)
- C Speedometer
- D Fuel Gauge
- E Engine Coolant Temperature Gauge

Information Display

Odometer

Located in the bottom of the information display. Registers the accumulated distance your vehicle has traveled.

Compass

Displays the vehicle's heading direction.

Trip Computer

See **General Information** (page 96).

Instrument Cluster

Vehicle Settings and Personalization

See **General Information** (page 96).

Engine Coolant Temperature Gauge



WARNING: Do not remove the coolant reservoir cap when the engine is on or the cooling system is hot. Wait 10 minutes for the cooling system to cool down. Cover the coolant reservoir cap with a thick cloth to prevent the possibility of scalding and slowly remove the cap. Failure to follow this instruction could result in personal injury.

Indicates engine coolant temperature. At normal operating temperature, the level indicator will be in the normal range. If the engine coolant temperature exceeds the normal range, stop your vehicle as soon as safely possible, switch off the engine and let the engine cool.

Note: Do not restart the engine until the cause of overheating has been resolved.

Fuel Gauge

The fuel gauge indicates about how much fuel is in the fuel tank.

The arrow adjacent to the fuel pump symbol indicates on which side of your vehicle the fuel filler door is located.

Note: The fuel gauge may vary slightly when your vehicle is moving or on a slope.

Low Fuel Reminder

A low fuel level reminder displays and sounds when the distance to empty reaches 75 mi (120 km) to empty for MyKey, and at 50 mi (80 km), 25 mi (40 km), 10 mi (20 km) and 0 mi (0 km) for all vehicle keys.

Note: The low fuel reminder can appear at different fuel gauge positions depending on fuel economy conditions. This variation is normal.

Instrument Cluster

Type 3

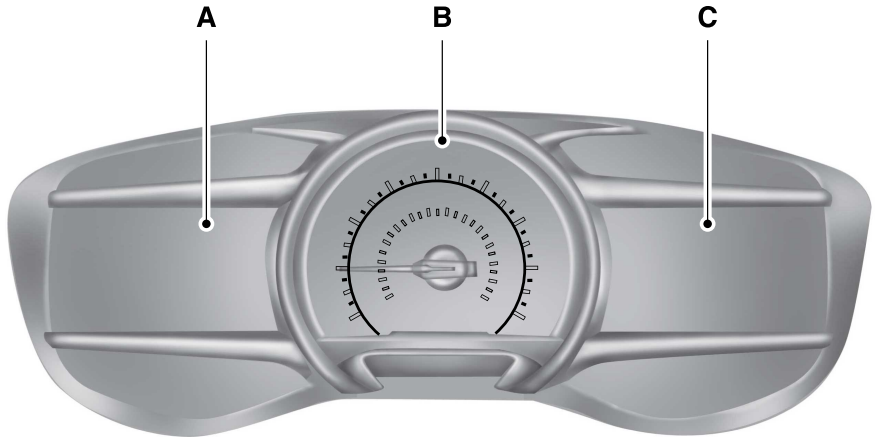

- A Left Information Display
- B Speedometer
- C Right Information Display. See **General Information** (page 96).

Left Information Display

Odometer

Located in the bottom of the information display. Registers the accumulated distance your vehicle has traveled.

Trip Computer

See **General Information** (page 96).

Vehicle Settings and Personalization

See **General Information** (page 96).

Instrument Cluster

WARNING LAMPS AND INDICATORS

The following warning lamps and indicators alert you to a vehicle condition that may become serious. Some lamps illuminate when you start your vehicle to make sure they work. If any lamps remain on after starting your vehicle, refer to the respective system warning lamp for further information.

Note: *Some warning indicators appear in the information display and operate the same as a warning lamp but do not illuminate when you start your vehicle.*

Adaptive Cruise Control Indicator (If Equipped)



It illuminates when you switch the system on.

It illuminates white when the system is in standby mode. It illuminates green when you set the adaptive cruise speed.

See **Using Adaptive Cruise Control** (page 193).

Anti-Lock Braking System



If it illuminates when you are driving, this indicates a malfunction. Your vehicle continues to have normal braking without the anti-lock brake system function. Have your vehicle checked as soon as possible.

Automatic Headlamp High Beam Indicator (If Equipped)



It illuminates when the system turns the headlamp high beam on.

See **Automatic High Beam Control** (page 79).

Auto-Start-Stop Indicator



It illuminates when the engine has automatically stopped. It flashes to inform you when the engine needs to restart. The indicator is shown with a strikethrough if the system is not available.

See **Auto-Start-Stop** (page 148).

Battery



It illuminates when you switch the ignition on.

If it illuminates when the engine is running this indicates a malfunction. Have your vehicle checked as soon as possible.

Blind Spot Monitor (If Equipped)



It illuminates when you switch the system off.

See **Blind Spot Information System** (page 206).

Brake System Warning Lamp

 **WARNING:** Driving your vehicle with the warning lamp on is dangerous. A significant decrease in braking performance may occur. It may take you longer to stop your vehicle. Have your vehicle checked as soon as possible. Driving extended distances with the parking brake engaged can cause brake failure and the risk of personal injury.

Note: *Indicators vary depending on region.*

This lamp is a dual function lamp and illuminates when:

Instrument Cluster

- You apply the parking brake with the ignition on.
- Your vehicle has a brake fault or low brake fluid level, regardless of parking brake position.

BRAKE If the lamp illuminates when you are moving, you may have the parking brake applied. Make sure that the parking brake is off. Have your vehicle checked as soon as possible if the lamp continues to illuminate.



Cruise Control Indicator (If Equipped)



It illuminates when you switch the system on.
See **Using Cruise Control** (page 192).

Direction Indicator



Flashes when the left or right direction indicator or the hazard flasher turns on. An increase in the rate of flashing warns of a failed indicator bulb.

Door Ajar Warning Lamp



It illuminates when you switch the ignition on and remains on if any door is open.

Electronic Locking Differential (If Equipped)



Illuminates when using the electronic locking differential.

Engine Coolant Temperature Warning Lamp



If it illuminates when your vehicle is moving, this indicates that the engine is overheating. Stop your vehicle as soon as it is safe to do so and switch the engine off. Have your vehicle checked as soon as possible.

See **Engine Coolant Check** (page 269).

Fasten Seatbelt Warning Lamp



It illuminates and a chime sounds until you fasten the seatbelts.

Fasten Rear Seatbelt Warning Lamp (If Equipped)



It illuminates and a chime sounds until you fasten the rear seatbelts.

Four-Wheel Drive Indicators (If Equipped)



Illuminates when four-wheel drive low is engaged.



Illuminates when four-wheel drive high is engaged.

Front Airbag



If it fails to illuminate when you start your vehicle, continues to flash or remains on, it indicates a malfunction. Have the system checked.

Front Fog Lamp Indicator (If Equipped)



It illuminates when you switch the front fog lamps on.

Instrument Cluster

Headlamp High Beam Indicator



It illuminates when you switch the headlamp high beam on. It flashes when you use the headlamp flasher.

Hood Ajar Warning Lamp



Illuminates when the ignition is on and the hood is not completely closed.

Low Beam Malfunction (If Equipped)



Lights when there is a malfunction with the low beam headlamp.

Low Fuel Level Warning Lamp



If it illuminates when you are driving, refuel as soon as possible.

Low Tire Pressure Warning Lamp



It illuminates when your tire pressure is low. If the lamp remains on with the engine running or when driving, check the tire pressure as soon as possible.

It also momentarily illuminates when you switch the ignition on to confirm the lamp is functional. If it does not illuminate when you switch the ignition on, or begins to flash at any time, have the system checked by your authorized dealer.

Low Washer Fluid Level Warning Lamp



It illuminates when the washer fluid is low.

Oil Pressure Warning Lamp



It illuminates when you switch the ignition on.

If it illuminates when the engine is running this indicates a malfunction. Stop your vehicle as soon as it is safe to do so and switch the engine off. Check the engine oil level. If the oil level is sufficient, this indicates a system malfunction. Have your vehicle checked as soon as possible.

See **Engine Oil Check** (page 266).

Parking Lamps



It illuminates when you switch the parking lamps on.

Powertrain Malfunction/Reduced Power/Electronic Throttle Control



Illuminates when the system has detected a powertrain or a four-wheel drive fault. Contact an authorized dealer as soon as possible.

Service Engine Soon



If it illuminates when the engine is running this indicates a malfunction. The On Board Diagnostics system has detected a malfunction of the vehicle emission control system.

If it flashes, engine misfire may be occurring. Increased exhaust gas temperatures could damage the catalytic converter or other vehicle components. Drive in a moderate fashion, avoid heavy acceleration and deceleration and have your vehicle immediately serviced.

It illuminates when you switch the ignition on prior to engine start to check the bulb and to indicate whether your vehicle is ready for Inspection and Maintenance (I/M) testing.

Instrument Cluster

Normally, it illuminates until the engine is cranked and automatically turns off if no malfunctions are present. However, if after 15 seconds it flashes eight times, this indicates that your vehicle is not ready for Inspection and Maintenance (I/M) testing. See **Emission Law** (page 157).

Stability Control and Traction Control Indicator



Flashes during operation.

If it does not illuminate when you switch the ignition on, or remains on when the engine is running, this indicates a malfunction. Have your vehicle checked as soon as possible.

See **Using Stability Control** (page 180).

Stability Control and Traction Control Off Warning Lamp



It illuminates when you switch the system off.

Tow Haul Indicator (If Equipped)



It illuminates when you switch the system on.

Trail Control (If Equipped)



It illuminates when you switch the system on.

AUDIBLE WARNINGS AND INDICATORS

Key in Ignition Warning Chime (If Equipped)

Sounds when you open the driver's door and you have left the key in the ignition.

Keyless Warning Alert (If Equipped)

Sounds the horn twice when you exit your vehicle with the intelligent access key, after the last door is closed and your keyless vehicle is in RUN, indicating your vehicle is still on.

Headlamps On Warning Chime

Sounds when you remove the key from the ignition and open the driver's door and you have left the headlamps or parking lamps on.

Parking Brake On Warning Chime

Sounds when you have left the parking brake on and drive your vehicle. If the warning chime remains on after you have released the parking brake, have the system checked by an authorized dealer immediately.

Information Displays

GENERAL INFORMATION



WARNING: Driving while distracted can result in loss of vehicle control, crash and injury. We strongly recommend that you use extreme caution when using any device that may take your focus off the road. Your primary responsibility is the safe operation of your vehicle. We recommend against the use of any hand-held device while driving and encourage the use of voice-operated systems when possible. Make sure you are aware of all applicable local laws that may affect the use of electronic devices while driving.

Note: *Your vehicle may or may not be equipped with all the messages listed in this chapter. Your vehicle will not display messages of systems it is not equipped with.*

Various systems on your vehicle can be controlled using the information display controls on the steering wheel. Corresponding information is displayed in the information display.

Information Display Controls (Type 1 and Type 2)



E205893

- Press the up or down arrow buttons to scroll through the list.
- Press the right arrow button to enter a sub-menu.
- Press the left arrow button to exit a menu.
- Press and hold the left arrow button at any time to return to the main menu display (escape button).
- Press the **OK** button to choose and confirm settings or messages.

Menu

You can access the menu using the information display control.



This icon gives you the ability to switch a feature on or off. A check in the box indicates the feature is enabled, and unchecked indicates the feature is disabled.

Note: *Some options may appear slightly different or not at all if the items are optional.*

Information Displays

Trip 1 and 2
Digital Speedo
Distance to E
Trip Odometer
Trip Timer
Average Fuel
Outside Temp.
All Values ¹

¹Type 2

- Digital Speedometer - Shows the speed your vehicle is traveling.
- Distance to E - Shows the approximate distance your vehicle can travel before running out of fuel.
- Trip Odometer — Registers the distance of individual journeys.
- Trip Timer — The timer stops when you turn your vehicle off and restarts when you restart your vehicle.
- Average Fuel — Shows the average fuel economy for a given trip.
- Outside Temperature — Shows the outside air temperature.
- All Values — Shows the Distance to E, Trip Odometer, Trip Timer and Average Fuel.

Note: Press and hold **OK** on the current screen to reset the respective trip, distance, time and fuel information.

Fuel Economy
Distance to E
Inst Fuel Econ
Average Fuel
Fuel History ¹
Average Speed

Information Displays

Fuel Economy
All Values ¹
Auto StartStop

¹ Type 2

- Distance to Empty - Shows the approximate distance your vehicle can travel before running out of fuel.
- Inst Fuel Economy - Shows a visual graph of your instantaneous fuel economy along with your Avg MPG since the function was last reset.
- Average Fuel — Shows the average fuel economy for a given trip.
- Fuel History - Shows a bar chart of your fuel history.
- Average Speed — Shows your average speed for a given trip.
- All Values — Shows all fuel economy values (DTE, Inst Fuel Econ, Avg Fuel).
- Auto StartStop - Available Auto Start-Stop messaging will provide details about what is happening with your system. See **Information Messages** (page 104).

Note: You can reset your average fuel economy by pressing and holding the **OK** button on the left hand steering wheel controls.

Driver Assist	
Traction control	
Cross Traffic ¹	
Cruise Control ¹	Enter the submenu and select your setting
Driver Alert ¹	Enter the submenu and select your setting
Hill Start Assist	
Lane Keeping System ¹	Enter the submenu and select your setting
Pre-Collision	Enter the submenu and select your setting
Rear Park Aid	
Speed Limiter ¹	Enter the submenu and select your setting
Tire Monitor	

Information Displays

Driver Assist	
Tire Pressure	
Trailer Sway	

¹Type 2

Settings			
Vehicle	Auto Engine Off		
	Easy Entry/Exit		
	Lighting	Enter the submenu and select your setting	
	Locks	Enter the submenu and select your setting	
	Neutral Tow	Hold OK to Initialize Neutral Tow	
	Oil Life Reset	oil Life XXX% - Hold OK to Reset	
	Remote Start	Enter the submenu and select your setting	
	Windows	Enter the submenu and select your setting	
	Wipers	Enter the submenu and select your setting	
	MyKey	Create MyKey	Hold OK to Create MyKey
		911 Assist	Enter the submenu and select your setting
		Do Not Disturb	Enter the submenu and select your setting
		Traction Control	Enter the submenu and select your setting
		Max Speed	Enter the submenu and select your setting
Speed Minder		Enter the submenu and select your setting	
Volume Limiter			

Information Displays

Settings		
	Clear MyKeys	Hold OK to Clear All MyKeys
Display Setup	Distance	Enter the submenu and select your setting
	Temperature	Enter the submenu and select your setting
	Tire Pressure	Enter the submenu and select your setting
	Language	Enter the submenu and select your setting

Information Display Controls (Type 3)



E205893

- Press the up or down arrow buttons to scroll through the list.
- Press the right arrow button to enter a sub-menu.
- Press the left arrow button to exit a menu.

- Press and hold the left arrow button at any time to return to the main menu display (escape button).
- Press the **OK** button to choose and confirm settings or messages.

Main menu

From the main menu bar on the left side of the information display, you can choose from the following categories:

- Display Mode
- Trip 1 & 2
- Fuel Economy
- Driver Assist
- Settings

Scroll up or down to highlight one of the categories, then press the right arrow key or **OK** to enter into that category. Press the left arrow key as needed to exit back to the main menu.

Display Mode

Use the up/down arrow buttons to choose between the following display options.

Information Displays

Display Mode
Distance to Empty
Tach and Gauges
Off Road
Digital Speedometer
Tire Pressure
Average Speed

Trip 1 & 2

You can access the menu using the information display control.

Note: Some options may appear slightly different or not at all if the items are optional.

Trip 1 & 2
All Values

All Values — shows all trip values (Trip Timer, Odometer and Average Fuel).

- Trip Odometer — Shows your accumulated trip distance.
- Trip Timer— The timer stops when you turn your vehicle off and restarts when you restart your vehicle.
- Average Fuel — Shows your average fuel economy for a given trip.

Note: You can reset your trip information by pressing and holding the **OK** button on the left hand steering wheel controls.

Fuel Economy

Use the left and right arrow buttons to choose the desired fuel economy display.

Information Displays

Fuel Economy
Fuel Economy
Fuel History
Auto StartStop

- Fuel Economy - Shows a visual graph of your instantaneous fuel economy, average fuel economy and distance to empty.
- Fuel History - Shows a bar chart of your fuel history from the past 30 min, average fuel economy and distance to empty.
- Auto StartStop - Available Auto Start-Stop messaging will provide details about what is happening with your system. See **Information Messages** (page 104).

Note: You can reset your average fuel economy by pressing and holding the **OK** button on the left hand steering wheel controls.

Driver Assist

Note: Some items are optional and may not appear.

In this mode, you can configure different driver setting choices.

Driver Assist		
Blind Spot	Blind spot	
	Trailer	Enter the submenu and select your setting
	Trailer Length	Enter the submenu and select your setting
Cross Traffic Alert		
Hill Start Assist		
Rear Park Aid		
Trailer Sway		
Chimes	Enter the submenu and select your setting	
Cruise Control	Enter the submenu and select your setting	
Driver Alert	Enter the submenu and select your setting	

Information Displays

Driver Assist	
Lane Keeping Sys	Enter the submenu and select your setting
Pre-Collision	Enter the submenu and select your setting
Tire Monitor	Tire Monitor

Settings

Note: Some items are optional and may not appear.

In this mode, you can configure different driver setting choices.

Settings		
Vehicle	Alarm	Enter the submenu and select your setting
	Auto Engine Off	
	Lighting	Enter the submenu and select your setting
	Locks	Enter the submenu and select your setting
	Neutral Tow	Enter the submenu and select your setting
	Oil Life Reset	XXX% - Hold OK to Reset
	Remote Start	Enter the submenu and select your setting
	Seatbelts	
	Windows	Enter the submenu and select your setting
	Wipers	Enter the submenu and select your setting
MyKey	Mykey Status	Mykey Status
	Create MyKey	Hold OK to Create MyKey
	911 Assist	Always On or User Selectable
	Do Not Disturb	Enter the submenu and select your setting
	Traction Control	Enter the submenu and select your setting
	Max Speed	Enter the submenu and select your setting
	Speed Minder	Enter the submenu and select your setting
	Volume Limiter	

Information Displays

Settings		
	Clear MyKeys	Hold OK to Clear All MyKeys
Display Setup	Measurement Units	Enter the submenu and select your setting
	Temperature	Enter the submenu and select your setting
	Gauge Display	Enter the submenu and select your setting
	Tire Pressure	Enter the submenu and select your setting
	Language	Enter the submenu and select your setting

INFORMATION MESSAGES

Note: Depending on your vehicle options and instrument cluster type, not all messages display or are available. The system may abbreviate or shorten certain messages depending upon which cluster type you have.



E205893

Press the **OK** button to acknowledge and remove some messages from the information display.

The system removes other messages after a short time.

You need to confirm certain messages before you can access the menus.

Information Displays

Adaptive Cruise Control

Message	Action
Adaptive Cruise Malfunction	A radar malfunction is preventing the adaptive cruise control from engaging. See Using Cruise Control (page 192).
Adaptive Cruise Not Available	A condition exists such that the adaptive cruise cannot function properly. See Using Cruise Control (page 192).
Adaptive Cruise Not Available Sensor Blocked See Manual	You have a blocked sensor due to bad weather, ice, mud or water in front of the radar sensor. You can typically clean the sensor to resolve. See Using Cruise Control (page 192).
Normal Cruise Active Automatic Braking Turned Off	The system has disabled the automatic braking.
Front Sensor Not Aligned	A radar malfunction is preventing the adaptive cruise control from engaging.
Adaptive Cruise - Driver Resume Control	The adaptive cruise has reinstated controls to the driver.
Adaptive Cruise Speed Too Low to Activate	Your vehicle speed is too slow to activate the adaptive cruise.
Adaptive Cruise Shift Down	The adaptive cruise is automatically adjusting the gap distance and you need to shift the transmission into a lower gear.

Airbag

Message	Action
Occupant Sensor BLOCKED Remove Objects Near Passenger Seat	Displays when the system detects a malfunction due to a blocked sensor.

Alarm and Security

Message	Action
Vehicle Alarm To Stop Alarm, Start Vehicle.	Alarm triggered due to unauthorized entry. See Anti-Theft Alarm (page 70).

Information Displays

Auto-Start-Stop

Message	Action
Auto StartStop Manual Restart Required	The system is not functioning. A manual restart is required.
Auto StartStop Press Clutch to Start Engine	The engine needs to be restarted, press the clutch pedal to start.
Auto StartStop Press a Pedal to Start Engine	The engine needs to be restarted, press any pedal to start.
Auto StartStop Select Neutral To Start Engine	Select neutral for the system to restart the engine.
Vehicle is ON	Displays when the vehicle is in StartStop when the door is opened. Switch the ignition off before leaving the vehicle if the system has shut down the engine.
Auto StartStop Malfunction Service Required	The system detects a fault that requires service. Stop your vehicle in a safe place. Have your vehicle checked as soon as possible.
Auto StartStop Press Brake Harder to Activate	The engine needs to be restarted, press the brake pedal harder to start.
Auto StartStop Not Available	Conditions are not met for the Auto StartStop system to function properly.
Auto StartStop Shift to P, then Restart Engine	Select park for the system to restart the engine.

Information Displays

Battery and Charging System

Message	Action
Check Charging System	The charging system needs servicing. If the warning stays on or continues to come on, have your vehicle checked as soon as possible.
Low Battery Features Temporarily Turned Off	The battery management system detects an extended low-voltage condition. Your vehicle will disable various features to help preserve the battery. Turn off as many of the electrical loads as soon as possible to improve system voltage. If the system voltage has recovered, the disabled features will operate again as normal.
Turn Power Off To Save Battery	The battery management system determines that the battery is at a low state of charge. Turn your ignition off as soon as possible to protect the battery. This message will clear once you restart your vehicle and the battery state of charge has recovered. Turning off unnecessary electrical loads will allow faster battery state-of-charge recovery.
Charging System Service Soon	The charging system needs servicing. If the warning stays on or continues to come on, have your vehicle checked as soon as possible.
Charging System Service Now	The charging system needs servicing. Have your vehicle checked as soon as possible.
Battery State of Charge Low	The battery management system determines that the battery is at a low state of charge. Turn your ignition off as soon as possible to protect the battery. This message clears once you restart your vehicle and the battery state of charge has recovered.

Blind Spot Information and Cross Traffic Alert System

Message	Action
Blindspot System Fault	A fault with the system has occurred. Have your vehicle checked as soon as possible.
Blindspot Not Available Sensor Blocked See Manual	The system sensors are blocked. See Blind Spot Information System (page 206).
Cross Traffic Alert	The system detects a vehicle.

Information Displays

Message	Action
Cross Traffic Not Available Sensor Blocked See Manual	The blind spot information system and cross traffic alert system sensors are blocked. See Blind Spot Information System (page 206).
Cross Traffic System Fault	A fault with the system has occurred. Have your vehicle checked as soon as possible.
Cross Traffic Alert Deactivated Trailer Attached	The system automatically turns off and displays this message when you connect a trailer to the vehicle that does not have a trailer blind spot system or when you switch the trailer blind spot system off through the information display. See Blind Spot Information System (page 206).
Blind Spot Alert Deactivated Trailer Attached	The system automatically turns off and displays this message when you connect a trailer to the vehicle that does not have a trailer blind spot system or when you connect a trailer and do not set up a Blind Spot Trailer. See Blind Spot Information System (page 206).
Trailer Blind Spot not Operational above Specified Measurements	Displays when the trailer width is wider than 8.2 ft (2.5 m) or longer than 33 ft (10 m).

Doors and Locks

Message	Action
X Door Ajar	The door(s) listed is not completely closed.

Driver Alert

Message	Action
Driver Alert Warning Rest Now	Stop and rest as soon as it is safe to do so.
Driver Alert Warning Rest Suggested	Take a rest soon.

Information Displays

Drivetrain

Message	Action
To Engage Locking Differential Slow to XX mph/km/h	Slow the vehicle to the displayed speed to allow the electronic locking differential to engage.
To Engage Locking Differential Release Accelerator Pedal	The electronic locking differential requests the accelerator to be released in order to engage.
Check Locking Differential	An electronic locking differential (ELD) system fault is present. Have your vehicle checked as soon as possible.
Neutral Tow Enabled Leave Transmission in Neutral	The transfer case is in the neutral position. This message indicates that your vehicle is safe to be towed with all four wheels on the ground.
Neutral Tow Disabled	The transfer case is NOT in the neutral position. This message indicates that your vehicle is NOT safe to be towed with all four wheels on the ground.

Engine

Message	Action
Power Reduced to Lower Engine Temp	The engine has reduced power to help reduce high engine temperature.
Brake Applied Power Reduced	Displays when the accelerator pedal is entrapped or both accelerator and brake pedals are applied at the same time. Have your vehicle checked as soon as possible.

Fuel

Message	Action
Fuel Level Low	An early reminder of a low fuel condition.
Check Fuel Fill Inlet	The fuel fill inlet may not be properly closed.

Information Displays

Keys and Intelligent Access

Message	Action
To START Press Brake	A reminder to press the brake while starting the vehicle.
No Key Detected	The system does not detect a key in your vehicle.
Restart Now or Key is Needed	You pressed the StartStop button to switch off the engine and your vehicle does not detect your intelligent access key inside your vehicle.
Run Power Active	Your vehicle is in the run ignition state.
Starting System Fault	There is a problem with your vehicle's starting system. Have your vehicle checked as soon as possible.
Key Program Successful	You have successfully programmed an intelligent access key to the system.
Key Program Failure	You have failed to program an intelligent access key to the system.
Max Number of Keys Learned	You have programmed the maximum number of keys to the system.
Not Enough Keys Learned	You have not programmed enough keys to the system.
Key Battery Low Replace Soon	The key battery is low. Change the battery as soon as possible.
Engine ON	Informs you that you are exiting your vehicle and the engine is on.

Information Displays

Lane Keeping System

Message	Action
Lane Keeping Sys. Malfunction Service Required	The system has malfunctioned. Have your vehicle checked as soon as possible.
Front Camera Temporarily Not Available	The system has detected a condition that has caused the system to be temporarily unavailable. See Lane Keeping System (page 201).
Front Camera Low Visibility Clean Screen	The system has detected a condition that requires you to clean the windshield in order for it to operate properly.
Front Camera Malfunction Service Required	The system has malfunctioned. Have your vehicle checked as soon as possible.
Keep Hands on Steering Wheel	The system requests you to keep your hands on the steering wheel.

Maintenance

Message	Action
Low Engine Oil Pressure	Stop your vehicle as soon as safely possible and turn off the engine. Check the oil level. If the warning stays on or continues to come on with your engine running, have your vehicle checked as soon as possible.
Change Engine Oil Soon	The engine oil life remaining is 10% or less.
Oil Change Required	The oil life left is at 0%.
Brake Fluid Level Low	The brake fluid level is low, inspect the brake system immediately.
Check Brake System	The brake system needs servicing. Stop your vehicle in a safe place. Have your vehicle checked as soon as possible.
Transport / Factory Mode Contact Dealer	Your vehicle is still in Transport or Factory mode. This may not allow some features to operate properly. Have your vehicle checked as soon as possible.
See Manual	The powertrain needs service due to a powertrain malfunction.

Information Displays

MyKey

Message	Action
MyKey not Created	You cannot program a MyKey.
MyKey Active Drive Safely	MyKey is active.
Speed Limited to XX MPH/km/h	When switching on your vehicle and MyKey is in use, displays that the MyKey speed limit is on.
Near Vehicle Top Speed	MyKey is in use and the MyKey speed limit is on and the vehicle speed is approaching 81 mph (130 km/h).
Vehicle at Top Speed of MyKey Setting	You have reached the speed limit set for your MyKey.
Check Speed Drive Safely	You have an active MyKey with a programmed set speed limit.
Buckle Up to Unmute Audio	Belt-Minder turns on with a MyKey in use.
AdvanceTrac On - MyKey Setting	With a MyKey in use, AdvanceTrac turns on.
Traction Control On - MyKey Setting	With a MyKey in use, traction control turns on.
MyKey Park Aid Cannot be Deactivated	With a MyKey in use, park aid is always on.
Lane Keeping Alert On MyKey Setting	With a MyKey in use, lane keeping alert turns on.

Information Displays

Park Aid

Message	Action
Check Front Park Aid	The system has detected a condition that requires service. Have your vehicle checked as soon as possible. See Front Parking Aid (page 187).
Check Rear Park Aid	The system has detected a condition that requires service. Have your vehicle checked as soon as possible. See Rear Parking Aid (page 187).
Front Park Aid On Off	Displays the park aid status.
Rear Park Aid On Off	Displays the park aid status.

Power Steering

Message	Action
Steering Fault Service Now	The power steering system has detected a condition that requires service. Have your vehicle checked as soon as possible.
Steering Loss Stop Safely	The power steering system is not working. Stop your vehicle in a safe place. Have your vehicle checked as soon as possible.
Steering Assist Fault Service Required	The power steering system has detected a condition within the power steering system, passive entry or the passive start system requires service. Have your vehicle checked as soon as possible.

Pre-Collision Assist

Message	Action
Collision Warning Malfunction	A fault with the system has occurred. Have your vehicle checked as soon as possible.
Collision Warning Not Available Sensor Blocked See Manual	You have a blocked sensor due to bad weather, ice, mud or water in front of the radar sensor. You can typically clean the sensor to resolve. See Pre-Collision Assist (page 213).
Collision Warning Not Available	A fault with the system has occurred. Have your vehicle checked as soon as possible.

Information Displays

Remote Start

Message	Action
To Drive: Press Start Button	A reminder to push the start button to drive your vehicle after a remote start.

Starting System

Message	Action
To START Press Brake	A reminder to apply the brake when starting your vehicle.
Cranking Time Exceeded	The starter has exceeded its cranking time in attempting to start your vehicle.
Engine Start Pending Please Wait	The starter is attempting to start your vehicle.
Pending Start Cancelled	The system has cancelled the pending start.

Tire Pressure Monitoring System

Message	Action
Tire Pressure Low	One or more tires on your vehicle has low tire pressure.
Tire Pressure Monitor Fault	The tire pressure monitoring system is malfunctioning. If the warning stays on or continues to come on, have your vehicle checked as soon as possible. See Tire Pressure Monitoring System (page 309).
Tire Pressure Sensor Fault	A tire pressure sensor is malfunctioning or your spare tire is in use. See Tire Pressure Monitoring System (page 309). If the warning stays on or continues to come on, have your vehicle checked as soon as possible.

Traction Control

Message	Action
Traction Control Off	The status of the traction control system after you switched it off.
Traction Control On	The status of the traction control system after you switched it on.

Information Displays

Trail Control

Message	Action
Reduce Speed To Enter Trail Control	You must reduce your vehicle speed to use trail control.
Trail Control Not Available with Park Brake Applied	You must release the park brake to use trail control.
Trail Control Enabled Use SET Button to Set Speed	You successfully enabled trail control and must press SET to activate.
Trail Control Off Driver Resume Control	A trail control system fault has occurred, the driver must resume control.
Trail Control Off	The system has switched off.
Trail Control Fault See Manual	A system fault is present. See What Is Trail Control (page 184).
Trail Control Not Available with Cruise Control Active	You must switch the cruise control off to use trail control.
Trail Control Not Available with Driver Door Open	You must close the door to use trail control.
Descent Control Now Active Press Trail Control Switch To Exit	Descent control mode is active and you have to press the trail control switch to exit.

Trailer

Message	Action
Trailer Connected	A correct trailer connection is sensed during a given ignition cycle.
Trailer Disconnected	A trailer connection becomes disconnected, either intentionally or unintentionally, and has been sensed during a given ignition cycle.
Trailer Sway Reduce Speed	The trailer sway control has detected trailer sway.
Trailer Wiring Fault	There are certain faults in your vehicle wiring and trailer wiring/brake system. See Towing a Trailer (page 224).
Trailer Left Turn Lamps Fault Check Lamps	There is a fault with your trailer turn lamp. Check your lamp.

Information Displays

Message	Action
Trailer Right Turn Lamps Fault Check Lamps	There is a fault with your trailer turn lamp. Check your lamp.
Trailer Battery Not Charging See Manual	There is a fault with your trailer battery. See Towing a Trailer (page 224).
Trailer Lighting Module Fault See Manual	There is a fault with your vehicle trailer lighting module. See Towing a Trailer (page 224).

4WD

Message	Action
Check 4x4	A 4X4 system fault is present. Have your vehicle checked as soon as possible.
4x4 Shift in Progress	The 4X4 system is making a shift.
For 4x4 LOW Shift to N	Displays when you attempt to switch to 4X4 LOW and you do not shift the transmission to neutral (N).
For 4x4 LOW Slow to 3 MPH	Displays when you attempt to switch to 4X4 LOW and your vehicle's speed is greater than 3 mph (5 km/h).
To Exit 4x4 LOW Shift to N	Displays when you attempt to switch from 4X4 LOW and you do not shift the transmission to neutral (N).
To Exit 4x4 LOW Slow to 3 MPH	Displays when you attempt to switch from 4X4 LOW and your vehicle's speed is greater than 3 mph (5 km/h).

Climate Control

MANUAL CLIMATE CONTROL

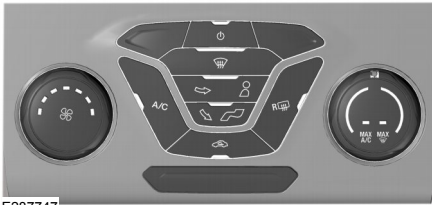

E287747

Directing the Airflow



Press and release the button to direct airflow to the windshield air vents and de-mister.



Press and release the button to direct airflow to the instrument panel air vents.



Press and release the button to direct airflow to the footwell air vents.

You can direct air through the windshield and footwell air vents or the instrument panel and footwell air vents at the same time.

Setting the Blower Motor Speed

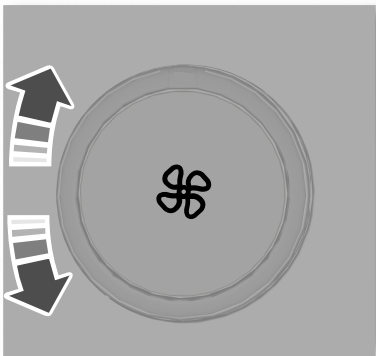

Turn the control to adjust the volume of air circulated in the vehicle.

Setting the Temperature

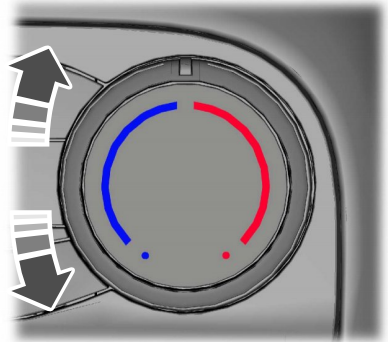

Turn the control to set the temperature.

Switching the Air Conditioning On and Off



Press and release the button.

Use air conditioning with recirculated air to improve cooling performance and efficiency.

Note: In certain conditions such as maximum defrost, the air conditioning compressor may continue to operate even though you switch off the air conditioning.

Switching the Climate Control On and Off



Press and release the button.

Climate Control

Switching Maximum Air Conditioning On and Off



Turn the temperature control counterclockwise to the lowest setting.

Note: Recirculated air flows through the instrument panel air vents, air conditioning turns on and the blower motor adjusts to the highest speed.

Switching Maximum Defrost On and Off



Turn the temperature control clockwise to the highest setting.

Note: Air flows through the windshield air vents, and the blower motor adjusts to the highest speed.

You can also use this setting to defog and clear the windshield of a thin covering of ice. The heated rear window also turns on when you select maximum defrost.

Note: To prevent window fogging, you cannot select recirculated air when maximum defrost is on.

Switching Recirculated Air On and Off



Press and release the button to switch between outside air and recirculated air.

The air currently in the passenger compartment recirculates. This may reduce the time needed to cool the interior, when used with A/C, and reduce unwanted odors from entering your vehicle.

Note: Recirculated air may turn off, or prevent you from switching on, in all air flow modes except MAX A/C to reduce the risk of fogging. Recirculation may also turn on and off in various air distribution control combinations during hot weather to improve cooling efficiency.

AUTOMATIC CLIMATE CONTROL



Note: You can switch temperature units between Fahrenheit and Celsius.

Note: You can control some of the climate features through the touchscreen.

Setting the Temperature

Press and release **+** or **-** on the left-hand side of the climate control to set the left-hand temperature.

Note: This control also adjusts the right-hand side temperature when you switch off dual zone mode.

Press and release **+** or **-** on the right-hand side of the climate control to set the right-hand temperature.

Setting the Blower Motor Speed



Press and release **+** or **-** to adjust the volume of air circulated in the vehicle.

Switching Auto Mode On and Off



Press and release the button to switch on automatic operation, then set the temperature.

The system adjusts the blower motor speed, air distribution, air conditioning operation, and outside or recirculated air to reach and maintain the temperature you have set.

Climate Control

Note: You can also switch off dual zone mode by pressing and holding the button for more than two seconds.

Switching the Air Conditioning On and Off



Press and release the button.

Use air conditioning with recirculated air to improve cooling performance and efficiency.

Note: In certain conditions such as maximum defrost, the air conditioning compressor may continue to operate even though you switch off the air conditioning.

Switching the Climate Control On and Off



Press and release the button.

Switching Defrost On and Off



Press and release the button to distribute air through the windshield air vents and de-mister.

You can also use this setting to defog and clear the windshield of a thin covering of ice.

Switching the Heated Seats On and Off



Press and release the button to cycle through the various heat settings and off.

See **Heated Seats** (page 130).

Switching Maximum Air Conditioning On and Off



Press and release the button for maximum cooling.

The left-hand and right-hand settings set to LO, recirculated air flows through the instrument panel air vents, air conditioning turns on and the blower motor adjusts to the highest speed.

Switching Maximum Defrost On and Off



Press and release the button for maximum defrosting.

The left-hand and right-hand settings set to HI, outside air flows through the windshield air vents, and the blower motor adjusts to the highest speed.

You can also use this setting to defog and clear the windshield of a thin covering of ice.

Note: To prevent window fogging, you cannot select recirculated air when maximum defrost is on.

Note: The heated rear window also turns on when you select maximum defrost.

Switching Recirculated Air On and Off



Press and release the button to switch between outside air and recirculated air.

The air currently in the passenger compartment recirculates. This may reduce the time needed to cool the interior, when used with **A/C**, and reduce unwanted odors from entering your vehicle.

Climate Control

Note: Recirculated air may turn off, or prevent you from switching on, in all air flow modes except **MAX A/C** to reduce the risk of fogging. Recirculation may also turn on and off in various air distribution control combinations during hot weather to improve cooling efficiency.

HINTS ON CONTROLLING THE INTERIOR CLIMATE

General Hints

Note: Prolonged use of recirculated air may cause the windows to fog up.

Note: You may feel a small amount of air from the footwell air vents regardless of the air distribution setting.

Note: To reduce humidity build-up inside your vehicle, do not drive with the system switched off or with recirculated air always switched on.

Note: Do not place objects under the front seats as this may interfere with the airflow to the rear seats.

Note: Remove any snow, ice or leaves from the air intake area at the base of the windshield.

Note: To improve the time to reach a comfortable temperature in hot weather, drive with the windows open until you feel cold air through the air vents.

Manual Climate Control

Note: To reduce fogging of the windshield during humid weather, adjust the air distribution control to the windshield air vents position.

Automatic Climate Control

Note: Adjusting the settings when your vehicle interior is extremely hot or cold is not necessary. The system automatically adjusts to heat or cool the interior to your selected temperature as quickly as possible. For the system to function efficiently, the instrument panel and side air vents should be fully open.

Note: If you select **AUTO** during cold temperatures, the system directs airflow to the windshield and side window vents. In addition, the fan may run at a slower speed until the engine warms up.

Note: If you select **AUTO** during hot temperatures and the inside of the vehicle is hot, the system automatically uses recirculated air to maximize interior cooling. Fan speed may also reduce until the air cools.

Quickly Heating the Interior

	Manual climate control	Automatic climate control
1	Adjust the fan speed to the highest setting.	Press AUTO .
2	Adjust the temperature control to the full heat setting.	Adjust the temperature control to the desired setting.
3	Direct air to the footwell using the air distribution buttons.	

Climate Control

Recommended Settings for Heating

	Manual climate control	Automatic climate control
1	Adjust the fan speed to the center setting.	Press AUTO .
2	Adjust the temperature control to the midway point of the hot settings.	Adjust the temperature control to the desired setting. Use 72°F (22°C) as a starting point, then adjust the setting as necessary.
3	Direct air to the footwell using the air distribution buttons.	

Quickly Cooling the Interior

	Manual climate control	Automatic climate control
1	Select MAX A/C .	Select MAX A/C .
2	Drive with the windows open until you feel cold air through the air vents.	

Recommended Settings for Cooling

	Manual climate control	Automatic climate control
1	Adjust the fan speed to the center setting.	Press AUTO .
2	Adjust the temperature control to the midway point of the cold settings.	Adjust the temperature control to the desired setting. Use 72°F (22°C) as a starting point, then adjust the setting as necessary.
3	Direct air to the instrument panel using the air distribution buttons.	

Climate Control

Defogging the Side Windows in Cold Weather

	Manual climate control	Automatic climate control
1	Direct air to the windshield using the air distribution buttons.	Press the defrost button.
2	Press A/C .	Adjust the temperature control to the desired setting. Use 72°F (22°C) as a starting point, then adjust the setting as necessary.
3	Adjust the temperature control to the desired setting.	
4	Adjust the fan speed to the highest setting.	

HEATED REAR WINDOW (IF EQUIPPED)



Press the button to clear the rear window of thin ice and fog. The heated rear window turns off after a short period of time.

Note: Do not use harsh chemicals, razor blades or other sharp objects to clean or remove decals from the inside of the heated rear window. The vehicle warranty may not cover damage to the heated rear window grid lines.

HEATED EXTERIOR MIRRORS (IF EQUIPPED)

When you switch the heated rear window on, the heated exterior mirrors turn on.

Note: Do not remove ice from the mirrors with a scraper or adjust the mirror glass when it is frozen in place.

Note: Do not clean the mirror housing or glass with harsh abrasives, fuel or other petroleum-based cleaning products. The vehicle warranty may not cover damage caused to the mirror housing or glass.

CABIN AIR FILTER

Your vehicle is equipped with a cabin air filter, which gives you and your passengers the following benefits:

- It improves your driving comfort by reducing particle concentration.
- It improves the interior compartment cleanliness.
- It protects the climate control components from particle deposits.

You can locate the cabin air filter behind the glove box.

Note: Make sure you have a cabin air filter installed at all times. This prevents foreign objects from entering the system. Running the system without a filter in place could result in degradation or damage to the system.

Replace the filter at regular intervals. See **Scheduled Maintenance** (page 416).

Climate Control

For additional cabin air filter information, or to replace the filter, see an authorized dealer.

REMOTE START (IF EQUIPPED)

You can switch this feature on or off and adjust the settings using the information display controls. See **Information Displays** (page 96).

The climate control system adjusts the interior temperature during remote start.

You cannot adjust the climate control setting during remote start operation. Switch the ignition on to make adjustments.

Based on your remote start settings, the following vehicle-dependent features may or may not remain on after remote starting your vehicle:

- Climate controlled seats.
- Heated steering wheel.
- Heated mirrors.
- Heated rear window.
- Windshield wiper de-icer.

Note: *For dual zone climate controlled seats, the passenger seat setting defaults to match the driver seat during remote start.*

Automatic Settings

If **Auto** is on, the system sets the interior temperature to 72°F (22°C) and heats or cools the vehicle interior as required to achieve comfort.

Note: *In cold weather, the heated rear window and heated mirrors turn on.*

Last Settings

If **Last Settings** is on, the system uses the settings last selected before you turned off the vehicle.

Heated and Cooled Features

In **Auto** mode, certain heated features may switch on during cold weather, and cooled features during hot weather.

Seats

SITTING IN THE CORRECT POSITION

WARNING: Sitting improperly, out of position or with the seatback reclined too far can take weight off the seat cushion and affect the decision of the passenger sensing system, resulting in serious injury or death in the event of a crash. Always sit upright against your seat back, with your feet on the floor.

WARNING: Do not recline the seat backrest too far as this can cause the occupant to slide under the seatbelt, resulting in personal injury in the event of a crash.

WARNING: Do not place objects higher than the top of the seat backrest. Failure to follow this instruction could result in personal injury or death in the event of a sudden stop or crash.

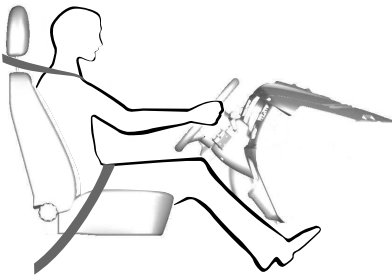

When you use them properly, the seat, head restraint, seatbelt and airbags will provide optimum protection in the event of a crash.

We recommend that you follow these guidelines:

- Sit in an upright position with the base of your spine as far back as possible.
- Do not recline the seat backrest so that your torso is more than 30 degrees from the upright position.
- Adjust the head restraint so that the top of it is level with the top of your head and as far forward as possible. Make sure that you remain comfortable.
- Keep sufficient distance between yourself and the steering wheel. We recommend a minimum of 10 in (25 cm) between your breastbone and the airbag cover.
- Hold the steering wheel with your arms slightly bent.
- Bend your legs slightly so that you can press the pedals fully.
- Position the shoulder strap of the seatbelt over the center of your shoulder and position the lap strap tightly across your hips.

Make sure that your driving position is comfortable and that you can maintain full control of your vehicle.

HEAD RESTRAINTS

WARNING: Fully adjust the head restraint before you sit in or operate your vehicle. This will help minimize the risk of neck injury in the event of a crash. Do not adjust the head restraint when your vehicle is moving.

Seats



WARNING: The head restraint is a safety device. Whenever possible it should be installed and properly adjusted when the seat is occupied. Failure to adjust the head restraint properly could reduce its effectiveness during certain impacts.



WARNING: Adjust the head restraints for all passengers before you drive your vehicle. This will help minimize the risk of neck injury in the event of a crash. Do not adjust the head restraints when your vehicle is moving.

Note: Adjust the seat backrest to an upright driving position before adjusting the head restraint. Adjust the head restraint so that the top of it is level with the top of your head and as far forward as possible. Make sure that you remain comfortable. If you are extremely tall, adjust the head restraint to its highest position.

Front Seat Head Restraints

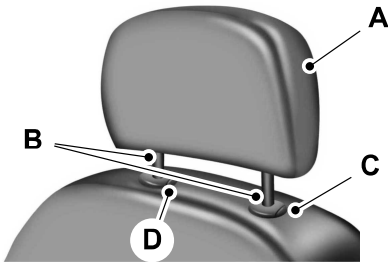

Rear Seat Outermost Head Restraints-If equipped

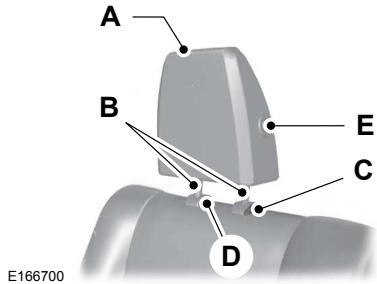

Rear Seat Center Head Restraint-If equipped

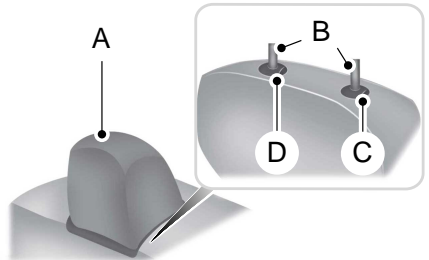

The head restraints consist of:

- A An energy absorbing head restraint.
- B Two steel stems.
- C Guide sleeve adjust and release button.
- D Guide sleeve unlock and remove button-if equipped.
- E Fold button-rear seat outermost only-if equipped.

Seats

Adjusting the Head Restraint

Raising the Head Restraint

Pull the head restraint up.

Lowering the Head Restraint

1. Press and hold button C.
2. Push the head restraint down.

Removing the Head Restraint

1. Pull up the head restraint until it reaches the highest adjustment position.
2. Press and hold buttons C and D.
3. Pull up the head restraint.

Note: For the double cab rear outermost seats, fold the seat backrest forward for easier removal of the head restraints.

Installing the Head Restraint

Align the steel stems into the guide sleeves and push the head restraint down until it locks.

Folding the Head Restraint

Note: The rear seat outermost head restraints may fold forward for improved visibility.

1. Press and hold button E.
2. Pull the head restraint back up to reset.

 **WARNING:** Make sure the seat fully locks into place by rocking it backward and forward.

Moving the Seat Backward and Forward



MANUAL SEATS

 **WARNING:** Do not adjust the driver seat or seat backrest when your vehicle is moving. This may result in sudden seat movement, causing the loss of control of your vehicle.

Seats

Adjusting the Recliner



Adjusting the Lumbar Support (if Equipped)



Adjusting the Seat Height



POWER SEATS (IF EQUIPPED)

 **WARNING:** Do not adjust the driver seat or seat backrest when your vehicle is moving. This may result in sudden seat movement, causing the loss of control of your vehicle.

 **WARNING:** Do not place cargo or any objects behind the seatback before returning it to the original position.

Seats

Moving the Seat Backward and Forward

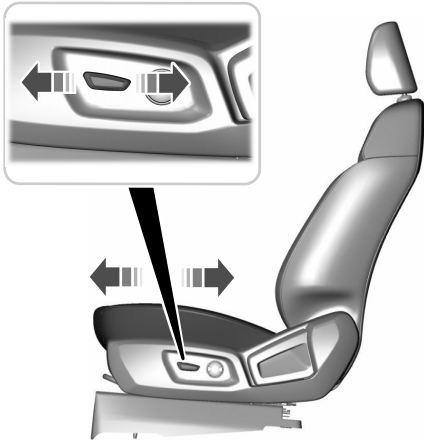

E274074

Adjusting the Recliner



E273885

Adjusting the Driver Seat Height

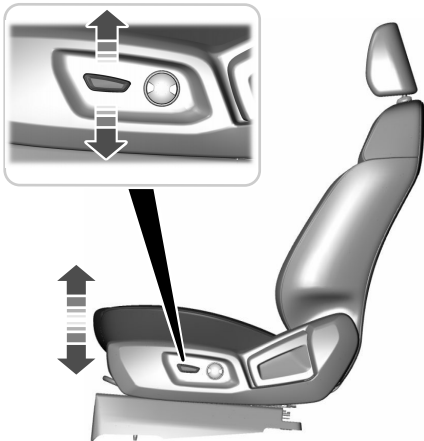

E273890

Adjusting the Lumbar

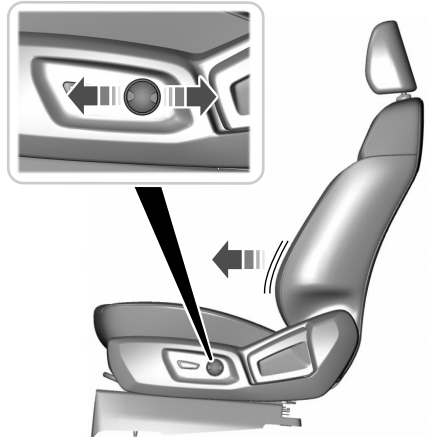

E273887

Seats

REAR SEATS (IF EQUIPPED)

Removing the Seat Cushion

Super Cab

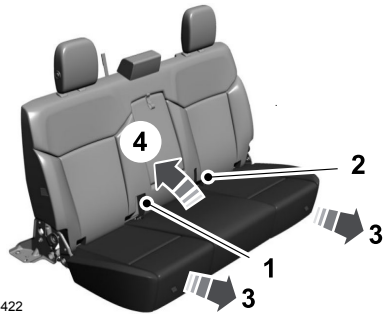
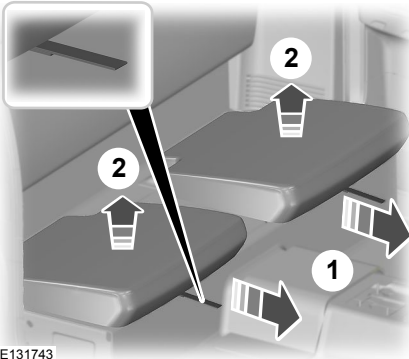

1. Place the passenger side seat buckles behind the elastic strap on the seat backrest.
2. Place the driver side seat buckle behind the elastic strap on the seat backrest.
3. Pull the tether straps.
4. Raise the seat cushion.

Note: When folding the cushion up, make sure that the seatbelt buckles are visible to an occupant and are not under the seat.

Folding the Seat Cushion



Unfolding the Seat Cushion



WARNING: Make sure that cargo and other objects are not trapped under the seat cushion and that you return the seat cushion to the full-down position. Failure to do so may prevent the seat from operating properly, which could increase the risk of serious injury in a crash.

Seats



E275423

1. Push the seat cushion down.
2. Remove the seatbelt buckles from behind the elastic strap on the seat backrest.

Note: You must stow the cushion tether strap in the pocket provided.

Folding the Seat Backrest



WARNING: When folding the seat backrest down, take care not to get your fingers caught in the mechanism.

Note: Do not use the rear surface of the rear seat backrest as a load floor.

Note: Do not unlatch and fold the seat backrest when the seat cushion is folded up.



E275420

1. Pull the release strap up.
2. Push the seat backrest forward.

Unfolding the Seat Backrest



WARNING: Make sure that the seats and the seat backrests are secure and fully locked in their catches.

Note: When unfolding the seat backrest, make sure that the seatbelts are visible to an occupant and not caught behind the seat.

HEATED SEATS (IF EQUIPPED)



WARNING: People who are unable to feel pain to their skin because of advanced age, chronic illness, diabetes, spinal cord injury, medication, alcohol use, exhaustion or other physical conditions, must use caution when using the heated seat. The heated seat may cause burns even at low temperatures,

Seats

especially if used for long periods of time. Do not place anything on the seat that may block the heat, such as a blanket or cushion. This can cause the heated seat to overheat. Do not puncture the seat with pins, needles or other pointed objects. This damages the heating element and can cause the heated seat to overheat. An overheated seat may cause serious personal injury.

Do not do the following:

- Place heavy objects on the seat.
- Operate the heated seat if water or any other liquid spills on the seat. Allow the seat to dry thoroughly.
- Operate the heated seats unless the engine is running. Doing so could drain your vehicle battery.



Press the heated seat symbol to cycle through the various heat settings and off. More indicator lights indicate warmer settings.

The heated seats only operate when you switch the ignition on.

The maximum temperature is reached after five or six minutes. It is regulated thermostatically.

The heated seats remain on until you either switch the heated seats off or you switch the ignition off.

Rear Occupant Alert System (If Equipped)

WHAT IS THE REAR OCCUPANT ALERT SYSTEM

The rear occupant alert system monitors vehicle conditions and notifies you to check for rear seat occupants when you switch the ignition off.

HOW DOES THE REAR OCCUPANT ALERT SYSTEM WORK

The system monitors when rear doors have been opened and closed to indicate the potential presence of an occupant in the rear seat.

A message displays in the information and entertainment display screen and an audible warning sounds when you switch the ignition off after any of the following conditions have been met:

- A rear door is opened or closed while the ignition is on.
- You switch the ignition on within 15 minutes of a rear door opening and closing.
- You switch the ignition on within 15 minutes of the alert having displayed or sounded.

REAR OCCUPANT ALERT SYSTEM PRECAUTIONS



WARNING: On hot days, the temperature inside the vehicle can rise very quickly. Exposure of people or animals to these high temperatures for even a short time can cause death or serious heat related injuries, including brain damage. Small children are particularly at risk.



WARNING: Do not leave children or pets unattended in your vehicle. Failure to follow this instruction could result in personal injury or death.

REAR OCCUPANT ALERT SYSTEM LIMITATIONS

The system does not detect the presence of objects or passengers in the rear seat. It monitors when rear doors are opened and closed.

Note: *It is possible to receive an alert when there is no rear seat occupant, but alert conditions are met.*

Note: *It is possible to receive no alert when there is an occupant in the rear seat, if alert conditions are not met. For example, if a rear seat occupant does not enter the vehicle through a rear door.*

Note: *The audible warning does not sound when the front door is opened before you switch the ignition off.*

SWITCHING REAR OCCUPANT ALERT SYSTEM ON AND OFF

1. Press **Settings** on the touchscreen.
2. Press **Vehicle**.
3. Switch **Rear Occupant Alert** on or off.

Note: *The default setting is on.*

Note: *Performing a master reset causes the system to switch on again.*

Semiannual Reminder (If Equipped)

When you switch the system off, a message appears every six months as a reminder that the system is off. You can switch the system back on or leave it off.

Rear Occupant Alert System (If Equipped)

REAR OCCUPANT ALERT SYSTEM INDICATORS



Message
Check rear seats for occupants.

Displays when you switch your vehicle off after the alert conditions are met.

The message displays for a short period of time. Press **Close** to acknowledge and remove the message.

Note: Depending on your SYNC version, the graphic may look different from what you see here.

REAR OCCUPANT ALERT SYSTEM AUDIBLE WARNINGS

Sounds when you switch your vehicle off after the alert conditions are met.

The warning sounds for a short period of time.

Garage Door Opener (If Equipped)

UNIVERSAL GARAGE DOOR OPENER

HomeLink Wireless Control System



WARNING: Do not use the system with any garage door opener that does not have the safety stop and reverse feature as required by U.S. Federal Safety Standards (this includes any garage door opener manufactured before April 1, 1982). A garage door opener which cannot detect an object, signaling the door to stop and reverse, does not meet current federal safety standards. Using a garage door opener without these features increases the risk of serious injury or death.

Note: Make sure that the garage door and security device are free from obstruction when you are programming. Do not program the system with the vehicle in the garage.

Note: Make sure you keep the original remote control transmitter for use in other vehicles as well as for future system programming.

Note: We recommend that upon the sale or lease termination of your vehicle, you erase the programmed function buttons for security reasons. See **Erasing the Function Button Codes** later in this section.

Note: You can program a maximum of three devices. To change or replace any of the three devices after it has been initially programmed, you must first erase the current settings. See **Erasing the Function Button Codes**.



The universal garage door opener replaces the common hand-held garage door opener with a three-button transmitter integrated into the driver's sun visor.

The system includes two primary features, a garage door opener and a platform for remote activation of devices within the home. You can program garage doors as well as entry gate operators, security systems, entry door locks and home or office lighting.

Additional system information can be found online at www.homelink.com, www.youtube.com/user/HomeLinkGentex or by calling the toll-free help line at 1-800-355-3515.

In-Vehicle Programming

This process is to program your in-vehicle HomeLink function button with your hand-held transmitter.

Note: The programming steps below assume you will be programming HomeLink that was not previously programmed. If your HomeLink was previously programmed, you may need to erase your HomeLink buttons. See **Erasing the Function Button Codes**.

Note: Put a new battery in the hand-held transmitter. This allows for quicker training and accurate transmission of the radio-frequency signal.

Garage Door Opener (If Equipped)

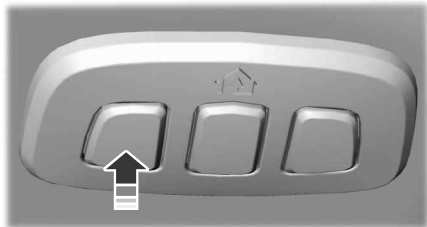

1. With your vehicle parked outside of the garage, switch your ignition to the **on** position, but do not start your vehicle.
2. Press and release the function button that you would like to program.
3. Hold your hand-held garage door transmitter 1–3 in (2–8 cm) away from the HomeLink button you want to program.
4. Press and hold the hand-held transmitter button you want to program while watching the indicator light on HomeLink. Continue to hold the hand-held button until the HomeLink indicator light flashes rapidly or is continuously on.

Note: You may need to use a different method if you live in Canada or have difficulties programming your gate operator or garage door opener. See **Gate Operator / Canadian Programming**.

5. Press and hold the HomeLink button you programmed for two seconds, then release. You may need to do this twice to activate the door. If your garage door does not operate, watch the HomeLink indicator light.

If the indicator light stays on, the programming is complete. Your device should activate when the HomeLink button is pressed and released.

If the indicator light flashes rapidly, press and hold for two seconds and release the programmed HomeLink button. Repeat the "press/hold/release" sequence up to three times to complete the programming process. If your device still does not operate, you must program your garage door. See **Programming Your Garage Door Opener Motor**.

To program additional buttons, repeat Steps 1 – 4.

For questions or comments, please contact HomeLink at www.homelink.com, www.youtube.com/user/HomeLinkGentex or by calling the toll-free help line at 1-800-355-3515.

Programming Your Garage Door Opener Motor

Note: You may need a ladder to reach the unit and you may need to remove the cover or lamp lens on your garage door opener.



1. Press the learn button on the garage door opener motor and then you have 30 seconds to complete the next two steps.
2. Return to your vehicle.

Garage Door Opener (If Equipped)

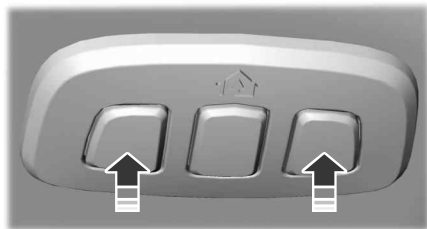
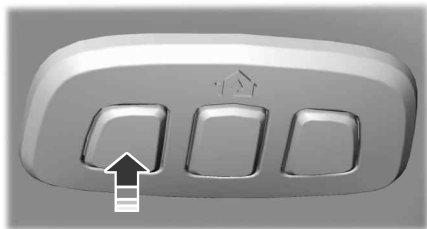

3. Press and hold the function button you want to program for 2 seconds, then release. Repeat this step. Depending on your brand of garage door opener, you may need to repeat this sequence a third time.

Gate Operator / Canadian Programming

Canadian radio-frequency laws require transmitter signals to “time-out” (or quit) after several seconds of transmission – which may not be long enough for HomeLink to pick up the signal during programming. Similar to this Canadian law, some U.S. gate operators are designed to “time-out” in the same manner.

Note: *If programming a garage door opener or gate operator, it is advised to unplug the device during the “cycling” process to prevent possible overheating.*

1. Press and release, **every two seconds**, your hand-held transmitter until the HomeLink indicator light changes to a rapidly blinking or continuously on light.
2. Release the hand-held transmitter button.
3. Continue programming HomeLink. See **In-Vehicle Programming, Step 4.**

Erasing the Function Button Codes

Note: *You cannot erase individual buttons.*

1. Press and hold the outer two function buttons simultaneously for approximately 10 seconds until the indicator light above the buttons flashes rapidly.
2. When the indicator light flashes, release the buttons. You erased the codes for all buttons.

Reprogramming a Single Button

To program a device to a previously trained button, follow these steps:

1. Press and hold the desired button. Do NOT release the button.
2. The indicator light begins to flash after 20 seconds. Without releasing the button, follow Step 1 in the Programming section.

For questions or comments, contact HomeLink at www.homelink.com, www.youtube.com/user/HomeLinkGentex or by calling the toll-free help line at 1-800-355-3515.

Garage Door Opener (If Equipped)

FCC and RSS-210 Industry Canada Compliance

This device complies with Part 15 of the FCC Rules and with RSS-210 of Industry Canada. Operation is subject to the following two conditions: (1) this device may not cause harmful interference, and (2) this device must accept any interference received, including interference that may cause undesired operation.



WARNING: Changes or modifications not expressly approved by the party responsible for compliance could void the user's authority to operate the equipment. The term "IC:" before the radio certification number only signifies that Industry Canada technical specifications were met.

This equipment complies with FCC radiation exposure limits set forth for an uncontrolled environment. End Users must follow the specific operating instructions for satisfying RF exposure compliance. This transmitter must be at least 8 in (20 cm) from the user and must not be co-located or operating in conjunction with any other antenna or transmitter.

The term "IC:" before the certification/registration number only signifies that Industry Canada technical specifications were met.

Auxiliary Power Points

12 V DC Power Point



WARNING: Do not use a power point for operating a cigar lighter. Incorrect use of the power points can cause damage not covered by the vehicle warranty, and can result in fire or serious injury.

Note: When you switch the ignition on, you can use the socket to power 12 V appliances with a maximum current rating of 15 A.

If the power supply does not work after you switch the ignition off, switch the ignition on.

Note: Do not hang any accessory from the accessory plug.

Note: Do not use the power point over the vehicle capacity of 12 V DC 180 watts or a fuse may blow.

Note: Always keep the power point caps closed when not in use.

Do not insert objects other than an accessory plug into the power point. This damages the power point and may blow the fuse.

Run the vehicle for full capacity use of the power point.

To prevent the battery from running out of charge:

- Do not use the power point longer than necessary when the engine is not running.
- Do not leave devices plugged in overnight or when you park your vehicle for extended periods.

Location

Power points may be in the following locations:

- On the front of the center console.
- Inside the center console.

- On the rear of the center console.
- Inside the luggage compartment.

110 V AC Power Point (If Equipped)



WARNING: Do not keep electrical devices plugged in the power point whenever the device is not in use. Do not use any extension cord with the 110 volt AC power point, since it will defeat the safety protection design. Doing so may cause the power point to overload due to powering multiple devices that can reach beyond the 150 watt load limit and could result in fire or serious injury.

Note: The power point turns off when you switch the ignition off, or when the battery voltage drops below 11 volts.

You can use the power point for electric devices that require up to 150 watts. It is on the rear of the center console.

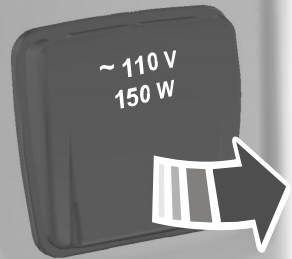

Auxiliary Power Points

When the indicator light on the power point is:

- On: The power point is working, the ignition is on and a device is plugged in.
- Off: The power point is off, the ignition is off or no device is plugged in.
- Flashing: The power point is in fault mode.

The power outlet temporarily turns off power when in fault mode if the device exceeds the 150 watt limit. Unplug your device and switch the ignition off. Switch the ignition back on, but do not plug your device back in. Let the system cool off and switch the ignition off to reset the fault mode. Switch the ignition back on and make sure the indicator light remains on.

Do not use the power point for certain electric devices, including:

- Cathode-ray, tube-type televisions.
- Motor loads, such as vacuum cleaners, electric saws and other electric power tools or compressor-driven refrigerators.
- Measuring devices, which process precise data, such as medical equipment or measuring equipment.
- Other appliances requiring an extremely stable power supply such as microcomputer-controlled electric blankets or touch-sensor lamps.

Storage Compartments

GLOVE COMPARTMENT

The glove box is on the passenger side of the instrument panel.

Open the glove box using the latch handle.



E223956

Glove Box with Lock (If Equipped)

Lock the glove box using the ignition key. To lock, close the glove box and insert the ignition key into the glove box lock and rotate it clockwise. Remove the key.

To unlock the glove box, insert the ignition key into the glove box lock and rotate it counter clockwise.

CENTER CONSOLE

Stow items in the cup holder carefully as items may become loose during hard braking, acceleration or crashes, including hot drinks which may spill.

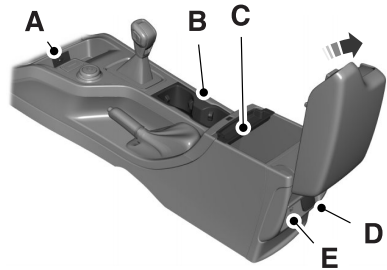

E277291

- A Audio input and or USB port.
- B Cup holders.
- C Coin storage.
- D Auxiliary power point (if equipped).
- E USB charger (if equipped).

OVERHEAD CONSOLE (IF EQUIPPED)

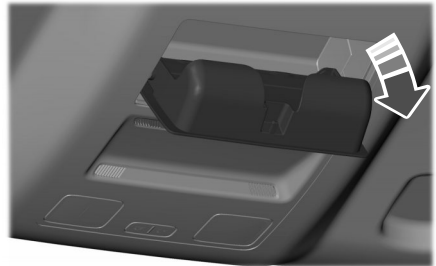

E277082

Press near the rear edge of the door to open it.

Storage Compartments

REAR SEAT ARMREST (IF EQUIPPED)

2. Lift the handle in the direction shown.
3. Slide it in the direction shown to remove the under seat storage cover.

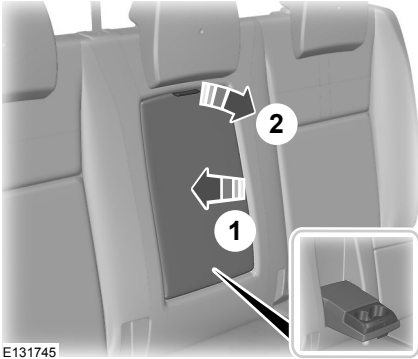

E131745

1. Push the armrest into the seatback to store it.
2. Pull the strap to open the armrest.

UNDER SEAT STORAGE

SuperCab

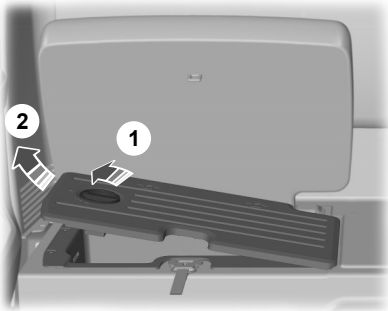

E188672

1. Lift the seat cushion. See **Rear Seats** (page 129).

Starting and Stopping the Engine

GENERAL INFORMATION

WARNING: Extended idling at high engine speeds can produce very high temperatures in the engine and exhaust system, creating the risk of fire or other damage.

WARNING: Do not park, idle or drive your vehicle on dry grass or other dry ground cover. The emission system heats up the engine compartment and exhaust system, creating the risk of fire.

WARNING: Do not start the engine in a closed garage or in other enclosed areas. Exhaust fumes can be toxic. Always open the garage door before you start the engine.

WARNING: Exhaust leaks may result in entry of harmful and potentially lethal fumes into the passenger compartment. If you smell exhaust fumes inside your vehicle, have your vehicle inspected immediately. Do not drive if you smell exhaust fumes.

WARNING: Switching off the engine when your vehicle is still moving results in a significant decrease in braking assistance. Higher effort is required to apply the brakes and to stop your vehicle. A significant decrease in steering assistance could also occur. The steering does not lock, but higher effort could be required to steer your vehicle. When you switch the ignition off, some electrical circuits, for example airbags, also turn off. If you unintentionally switch the ignition off, shift into neutral (N) and restart the engine.

If you disconnect the battery, your vehicle may exhibit some unusual driving characteristics for approximately 5 mi (8 km) after you reconnect it. This is because the engine management system must realign itself with the engine. You can disregard any unusual driving characteristics during this period.

The powertrain control system meets all Canadian interference-causing equipment standard requirements regulating the impulse electrical field or radio noise.

When you start the engine, avoid pressing the accelerator pedal before and during operation. Only use the accelerator pedal when you have difficulty starting the engine.

IGNITION SWITCH (IF EQUIPPED)



E247596

Note: Make sure the key is clean before inserting it into any lock cylinder.

Note: Do not leave the key in the ignition for an extended period of time when the engine is not running. This is to prevent the vehicle battery from losing charge.

Starting and Stopping the Engine

Switching the Ignition Off

Turn the key to position **0**.

Switching the Ignition to Accessory Mode

Turn the key to position **I**. Electrical accessories, for example the radio, operate without the engine running.

Switching the Ignition On

Turn the key to position **II**. All electrical circuits and accessories are operational and the warning lamps and indicators illuminate.

Starting the Engine

Turn the key to position **III**. Release the key when the engine starts.

KEYLESS STARTING (IF EQUIPPED)

Note: *The system may not function if the intelligent access key is close to metal objects or electronic devices, for example keys or a cell phone.*

Note: *A valid intelligent access key must be located inside your vehicle to switch the ignition on and start your vehicle.*

Ignition Modes



E144447

The keyless starting system has three modes:

Off: Turns the ignition off.

- Without applying the brake pedal, press and release the button once when the ignition is in the on mode, or when your vehicle is running but is not moving.

On: All electrical circuits are operational and the warning lamps and indicators illuminate.

- Without applying the brake pedal, press and release the button once.

Start: Starts your vehicle. The engine may not start when your vehicle starts.

- Press the brake pedal, and then press the button for any length of time. An indicator light on the button illuminates when the ignition is on and when your vehicle starts.

STARTING A GASOLINE ENGINE

When you start the engine, the idle speed increases. This helps to warm up the engine. If the engine idle speed does not slow down automatically, have your vehicle checked by an authorized dealer.

Starting and Stopping the Engine

Note: You can crank the engine for a total of 60 seconds without the engine starting before the starting system temporarily disables. The 60 seconds does not have to be all at once. For example, if you crank the engine three times for 20 seconds each time, without the engine starting, you reached the 60-second time limit. A message appears in the information display alerting you that you exceeded the cranking time. You cannot attempt to start the engine for at least 15 minutes. After 15 minutes, you are limited to a 15-second engine cranking time. You need to wait 60 minutes before you can crank the engine for 60 seconds again.

Before starting your vehicle, check the following:

- Make sure all occupants have fastened their seatbelt.
- Make sure the headlamps and electrical accessories are off.
- Make sure the parking brake is on.
- Make sure the transmission is in park (P).
- Switch the ignition on.

Vehicles with an Ignition Key

Note: Do not touch the accelerator pedal.

1. Fully depress the brake pedal.
2. Turn the key to the start position to start the engine.

Note: The engine may continue cranking for up to 15 seconds or until it starts.

Note: If you cannot start the engine on the first try, wait for a short period and try again.

Vehicles with Keyless Start

Note: Do not touch the accelerator pedal.

Note: You must have your intelligent access key in your vehicle in order to shift the transmission out of park (P).

1. Fully depress the brake pedal.
2. Press the push button ignition switch.

The system does not function if:

- The passive key frequencies are jammed.
- The key battery has no charge.

If you are unable to start your vehicle, do the following:

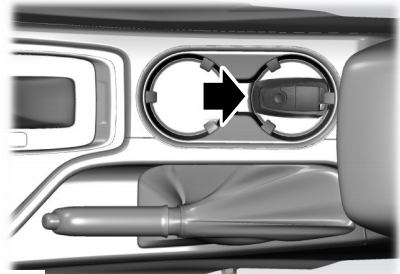

E272540

1. Open the floor console storage compartment lid.
2. Insert the passive key into the backup slot.
3. With the key in this position, press the brake pedal then press the push button ignition switch to switch the ignition on and start your vehicle.

Fast Restart

The fast restart feature allows you to restart your vehicle within 20 seconds of switching it off, even if it does not detect a valid passive key. After 20 seconds, you can no longer start your vehicle if it does not detect a valid passive key. Within 20 seconds of switching the engine off, press the brake pedal and press the push button ignition switch.

Starting and Stopping the Engine

Once your vehicle starts, it remains running until you press the push button ignition switch, even if your vehicle does not detect a valid passive key. If you open and close a door while your vehicle is running, the system searches for a valid passive key. You cannot start your vehicle if the system does not detect a valid passive key within 20 seconds.

Failure to Start

If you cannot start the engine after three attempts, wait 10 seconds and follow this procedure:

1. Fully depress the brake pedal.
2. Shift into park (P).
3. Fully depress the accelerator pedal and hold it there.
4. Start the engine.

Automatic Engine Shutdown

For vehicles with a keyless ignition, this feature automatically shuts down the engine if it has been idling for an extended period. The ignition also turns off in order to save battery power. Before your vehicle shuts down, a message appears in the information display showing a timer counting down from 30 seconds. If you do not intervene within 30 seconds, your vehicle shuts down. Another message appears in the information display to inform you that your vehicle has shut down to save fuel. Start your vehicle as you normally do.

Automatic Engine Shutdown Override

Note: You cannot permanently switch off the automatic shutdown feature. When you switch it off temporarily, it turns on at the next ignition cycle.

You can stop the shutdown, or reset the timer, at any point before the 30-second countdown has expired by doing any of the following:

- You can reset the timer by interacting with your vehicle, for example pressing the brake or accelerator pedal.
- You can temporarily switch off the shutdown feature any time the ignition is on using the information display. See **Information Displays** (page 96). The feature only remains off for the current ignition cycle.
- During the 30-second countdown, the system prompts you to press OK or RESET to temporarily switch the feature off for the current ignition cycle only.

Stopping the Engine When Your Vehicle is Stationary

Vehicles with an Ignition Key

1. Shift into park (P).
2. Switch the ignition off.
3. Apply the parking brake.

Vehicles with Keyless Start

1. Shift into park (P).
2. Press the push button ignition switch.
3. Apply the parking brake.

Note: The ignition, all electrical circuits and all warning lamps and indicators will be turned off.

Note: If the engine is idling for 30 minutes, the ignition and engine automatically shut down.

Starting and Stopping the Engine

Stopping the Engine When Your Vehicle is Moving



WARNING: Switching off the engine when your vehicle is still moving results in a significant decrease in braking assistance. Higher effort is required to apply the brakes and to stop your vehicle. A significant decrease in steering assistance could also occur. The steering does not lock, but higher effort could be required to steer your vehicle. When you switch the ignition off, some electrical circuits, for example airbags, also turn off. If you unintentionally switch the ignition off, shift into neutral (N) and restart the engine.

Vehicles with an Ignition Key

1. Shift into neutral and use the brakes to bring your vehicle to a safe stop.
2. When your vehicle has stopped, shift into park (P) and switch the ignition off.
3. Apply the parking brake.

Vehicles with Keyless Start

1. Shift into neutral and use the brakes to bring your vehicle to a safe stop.
2. When your vehicle has stopped, shift into park (P).
3. Press and hold the push button ignition switch, or press it three times within two seconds.
4. Apply the parking brake.

Guarding Against Exhaust Fumes



WARNING: Exhaust leaks may result in entry of harmful and potentially lethal fumes into the passenger compartment. If you smell exhaust fumes inside your vehicle, have your vehicle inspected immediately. Do not drive if you smell exhaust fumes.

Important Ventilating Information

If you stop your vehicle and then leave the engine idling for long periods, we recommend that you do one of the following:

- Open the windows at least 1 in (3 cm).
- Set your climate control to outside air.

ENGINE BLOCK HEATER (IF

EQUIPPED)



WARNING: Failure to follow engine block heater instructions could result in property damage or serious personal injury.



WARNING: Do not use your heater with ungrounded electrical systems or two-pronged adapters. There is a risk of electrical shock.



WARNING: Do not fully close the hood, or allow it to drop under its own weight when using the engine block heater. This could damage the power cable and may cause an electrical short resulting in fire, injury and property damage.

Note: The heater is most effective when outdoor temperatures are below 0°F (-18°C).

Starting and Stopping the Engine

The heater acts as a starting aid by warming the engine coolant. This allows the climate control system to respond quickly. The equipment includes a heater element, installed in the engine block and a wire harness. You can connect the system to a grounded 120-volt AC electrical source.

We recommend that you do the following for a safe and correct operation:

- Use a 16-gauge outdoor extension cord that is product certified by Underwriter's Laboratory (UL) or Canadian Standards Association (CSA). This extension cord must be suitable for use outdoors, in cold temperatures, and be clearly marked Suitable for Use with Outdoor Appliances. Do not use an indoor extension cord outdoors. This could result in an electric shock or become a fire hazard.
- Use as short an extension cord as possible.
- Do not use multiple extension cords.
- Make sure that when in operation, the extension cord plug and heater cord plug connections are free and clear of water. This could cause an electric shock or fire.
- If the block heater cord is under the hood, Do Not remove the wiring from its original location. Do Not close the hood on the extension wiring.
- Make sure your vehicle is parked in a clean area, clear of combustibles.
- Make sure the heater, heater cord and extension cord are firmly connected.
- Check for heat anywhere in the electrical hookup once the system has been operating for approximately 30 minutes.

- Make sure the system is unplugged and properly stowed before starting and driving your vehicle. Make sure the protective cover seals the prongs of the block heater cord plug when not in use.
- Make sure the heater system is checked for proper operation before winter.

Using the Engine Block Heater

Make sure the receptacle terminals are clean and dry prior to use. Clean them with a dry cloth if necessary.

The heater uses 0.4 to 1.0 kilowatt-hours of energy per hour of use. The system does not have a thermostat. It achieves maximum temperature after approximately three hours of operation. Using the heater longer than three hours does not improve system performance and unnecessarily uses electricity.

Unique Driving Characteristics

AUTO-START-STOP (IF EQUIPPED)

The system helps reduce fuel consumption by automatically shutting off and restarting the engine while your vehicle is stopped. The engine will restart automatically when you release the brake pedal. In some situations, your vehicle may restart automatically, for example:

- To maintain interior comfort
- To recharge the battery

Note: *Power assist steering is turned off when the engine is off.*



WARNING: Apply the parking brake, shift into park (P), switch the ignition off and remove the key before you leave your vehicle. Failure to follow this instruction could result in personal injury or death.



WARNING: Apply the parking brake, shift into park (P), switch the ignition off and remove the key before you open the hood or have any service or repair work completed. If you do not switch the ignition off, the engine could restart at any time. Failure to follow this instruction could result in personal injury or death.



WARNING: The system may require the engine to automatically restart when the auto-start-stop indicator illuminates green or flashes amber. Failure to follow this instruction could result in personal injury.

The Auto-Start-Stop system status is available at a glance within the information display. See **Information Displays** (page 96).

Enabling Auto-Start-Stop

The system is automatically enabled every time you start your vehicle if the following conditions are met:

- The Auto-Start-Stop button is not pressed (not illuminated).
- Your vehicle exceeds an initial speed of 3 mph (5 km/h) after you have initially started the vehicle.
- Your vehicle is stopped.
- Your foot is on the brake pedal.
- The transmission is in drive (D).
- The driver's door is closed.
- There is adequate brake vacuum.
- The interior compartment has been cooled or warmed to an acceptable level.
- The front windshield defroster is off.
- The steering wheel is not turned rapidly or is not at a sharp angle.
- The vehicle is not on a steep road grade.
- The battery is within optimal operating conditions (battery state of charge and temperature in range).
- The engine coolant is at operating temperature.
- Elevation is below approximately 12,000 ft (3,650 m).
- Ambient temperature is moderate.



The green Auto-Start-Stop indicator light on the instrument cluster will illuminate to indicate when the automatic engine stop occurs.



If the instrument cluster is equipped with a grey Auto-Start-Stop indicator light, it is illuminated when automatic engine stop is not available due to one of the above noted conditions not being met.

Unique Driving Characteristics

Automatic Engine Restart

Any of the following conditions will result in an automatic restart of the engine:

- Your foot is removed from the brake pedal.
- You press the accelerator pedal.
- You press the accelerator and the brake pedal at the same time.
- The driver safety belt becomes unfastened or the driver door is ajar.
- The transmission is moved into reverse (R).
- Your vehicle is moving.
- The battery is not within optimal operating conditions.
- The maximum engine off time is exceeded.
- When you press the Auto-Start-Stop button while the engine is stopped automatically.
- The heated windshield is turned on.

Any of the following conditions may result in an automatic restart of the engine:

- The blower fan speed is increased or the climate control temperature is changed.
- An electrical accessory is turned on or plugged in.

Disabling Auto-Start-Stop



Press the Auto-Start-Stop button located on the center console to switch the system off.

The button will illuminate. The system will only be deactivated for the current ignition cycle. Press the button again to restore Auto-Start-Stop function.

If your vehicle is in an Auto-Start-Stop state and you shift the transmission to reverse without pressing the brake, a message telling you to press the brake appears. You must press the brake pedal within 60 seconds, or you will need to shift to park and manually restart your vehicle.

Note: *If the Shift to P, Restart Engine message appears and the amber Auto-Start-Stop indicator light is flashing, automatic restart is not available. The vehicle must be restarted manually. See **Information Displays** (page 96).*

Fuel and Refueling

SAFETY PRECAUTIONS

 **WARNING:** Do not overfill the fuel tank. The pressure in an overfilled tank may cause leakage and lead to fuel spray and fire.

 **WARNING:** The fuel system may be under pressure. If you hear a hissing sound near the fuel filler inlet, do not refuel until the sound stops. Otherwise, fuel may spray out, which could cause serious personal injury.

 **WARNING:** Fuels can cause serious injury or death if misused or mishandled.

 **WARNING:** Fuel may contain benzene, which is a cancer-causing agent.

 **WARNING:** When refueling always shut the engine off and never allow sparks or open flames near the fuel tank filler valve. Never smoke or use a cell phone while refueling. Fuel vapor is extremely hazardous under certain conditions. Avoid inhaling excess fumes.

Follow these guidelines when refueling:

- Extinguish all smoking materials and any open flames before refueling your vehicle.
- Always switch the engine off before refueling.
- Automotive fuels can be harmful or fatal if swallowed. Fuel is highly toxic and if swallowed can cause death or permanent injury. If fuel is swallowed immediately call a physician, even if no symptoms are immediately apparent. The toxic effects of fuel may not be apparent for hours.

- Avoid inhaling fuel vapors. Inhaling fuel vapor can lead to eye and respiratory tract irritation. In severe cases, excessive or prolonged breathing of fuel vapor can cause serious illness and permanent injury.
- Avoid getting fuel in your eyes. If you splash fuel in your eyes, immediately remove contact lenses (if worn), flush with water for 15 minutes and seek medical attention. Failure to seek proper medical attention could lead to permanent injury.
- Fuels can be harmful if absorbed through the skin. If you splash fuel on your skin, clothing or both, promptly remove contaminated clothing and thoroughly wash your skin with soap and water. Repeated or prolonged skin contact causes skin irritation.
- Be particularly careful if you are taking Antabuse or other forms of Disulfiram for the treatment of alcoholism. Breathing fuel vapors could cause an adverse reaction, serious personal injury or sickness. Immediately call a physician if you experience any adverse reactions.

FUEL QUALITY

Choosing the Right Fuel

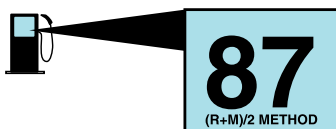

Your vehicle is designed to operate on regular unleaded gasoline with a minimum pump (R+M)/2 octane rating of 87.

Fuel and Refueling

Some fuel stations, particularly those in high altitude areas, offer fuels posted as regular unleaded gasoline with an octane rating below 87. The use of these fuels could result in engine damage that will not be covered by the vehicle warranty.

For best overall vehicle and engine performance, premium fuel with an octane rating of 91 or higher is recommended. The performance gained by using premium fuel is most noticeable in hot weather as well as other conditions, for example when towing a trailer. See **Towing** (page 224).

Do not be concerned if the engine sometimes knocks lightly. However, if the engine knocks heavily while using fuel with the recommended octane rating, contact an authorized dealer to prevent any engine damage.

We recommend Top Tier detergent gasolines, where available to help minimize engine deposits and maintain optimal vehicle and engine performance. For additional information, refer to www.toptiergas.com.

Note: *Use of any fuel for which the vehicle was not designed can impair the emission control system, cause loss of vehicle performance, and cause damage to the engine which may not be covered by the vehicle Warranty.*

Do not use:

- Diesel fuel.
- Fuels containing kerosene or paraffin.
- Fuel containing more than 15% ethanol or E85 fuel.
- Fuels containing methanol.
- Fuels containing metallic-based additives, including manganese-based compounds.

- Fuels containing the octane booster additive, methylcyclopentadienyl manganese tricarbonyl (MMT).
- Leaded fuel, using leaded fuel is prohibited by law.

The use of fuels with metallic compounds such as methylcyclopentadienyl manganese tricarbonyl (commonly known as MMT), which is a manganese-based fuel additive, will impair engine performance and affect the emission control system.

FUEL FILLER FUNNEL LOCATION

The fuel filler funnel is located under the rear bench seat or behind the rear seat.

RUNNING OUT OF FUEL

Running out of fuel can cause damage not covered by the vehicle Warranty.

If your vehicle runs out of fuel:

- Add a minimum of 1.3 gal (5 L) of fuel to restart the engine.
- You may need to switch the ignition from off to on several times after refueling to allow the fuel system to pump the fuel from the tank to the engine. When restarting, cranking time takes a few seconds longer than normal.

Note: *If your vehicle is on a steep slope, more fuel may be required.*

Filling a Portable Fuel Container



WARNING: Flow of fuel through a fuel pump nozzle can produce static electricity. This can cause a fire if you are filling an ungrounded fuel container.

Fuel and Refueling

Use the following guidelines to avoid electrostatic charge build-up, which can produce a spark, when filling an ungrounded fuel container:

- Only use an approved fuel container to transfer fuel to your vehicle. Place the container on the ground when filling it.
- Do not fill a fuel container when it is inside your vehicle (including the cargo area).
- Keep the fuel pump nozzle in contact with the fuel container when filling it.
- Do not use a device that holds the fuel pump nozzle lever in the fill position.

Adding Fuel From a Portable Fuel Container

 **WARNING:** Do not insert the nozzle of a fuel container or an aftermarket funnel into the fuel filler neck. This may damage the fuel system filler neck or its seal and cause fuel to run onto the ground.

 **WARNING:** Do not try to pry open or push open the capless fuel system with foreign objects. This could damage the fuel system and its seal and cause injury to you or others.

 **WARNING:** Do not dispose of fuel in the household refuse or the public sewage system. Use an authorized waste disposal facility.

When refueling the vehicle fuel tank from a fuel container, use the fuel filler funnel included with your vehicle. See **Fuel Filler Funnel Location** (page 151).

Note: *Do not use aftermarket funnels as they may not work with the capless fuel system and can damage it.*

When refueling the vehicle fuel tank from a fuel container, do the following:

1. Fully open the fuel filler door.
2. Fully insert the fuel filler funnel into the fuel filler inlet.



3. Add fuel to your vehicle from the fuel container.
4. Remove the fuel filler funnel.
5. Fully close the fuel filler door.
6. Clean the fuel filler funnel and place it back in your vehicle or correctly dispose of it.

Note: *Extra funnels can be purchased from an authorized dealer if you choose to dispose of the funnel.*

Fuel and Refueling

REFUELING

Refueling System Overview

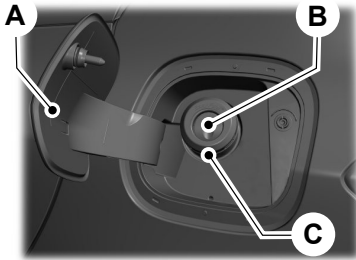

- A Fuel filler door.
- B Fuel tank filler valve.
- C Fuel tank filler pipe.

Your vehicle does not have a fuel tank filler cap.

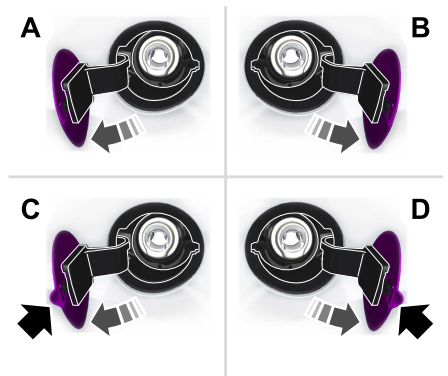

- A Left-hand side. To open the fuel filler door, press the center rear edge of the fuel filler door and then release.
- B Right-hand side. To open the fuel filler door, press the center rear edge of the fuel filler door and then release.
- C Left-hand side. Pull the rear of the fuel filler door to open it.
- D Right-hand side. Pull the rear of the fuel filler door to open it.

Refueling Your Vehicle

⚠ WARNING: When refueling always shut the engine off and never allow sparks or open flames near the fuel tank filler valve. Never smoke or use a cell phone while refueling. Fuel vapor is extremely hazardous under certain conditions. Avoid inhaling excess fumes.

Fuel and Refueling

WARNING: The fuel system may be under pressure. If you hear a hissing sound near the fuel filler inlet, do not refuel until the sound stops. Otherwise, fuel may spray out, which could cause serious personal injury.

WARNING: Do not pry open the fuel tank filler valve. This could damage the fuel system. Failure to follow this instruction could result in fire, personal injury or death.

WARNING: Do not remove the fuel pump nozzle from its fully inserted position when refueling.

WARNING: Stop refueling when the fuel pump nozzle automatically shuts off for the first time. Failure to follow this will fill the expansion space in the fuel tank and could lead to fuel overflowing.

WARNING: Do not overfill the fuel tank. The pressure in an overfilled tank may cause leakage and lead to fuel spray and fire.

WARNING: Wait at least five seconds before removing the fuel pump nozzle to allow any residual fuel to drain into the fuel tank.

1. Fully open the fuel filler door.
2. Select the correct fuel pump nozzle for your vehicle.

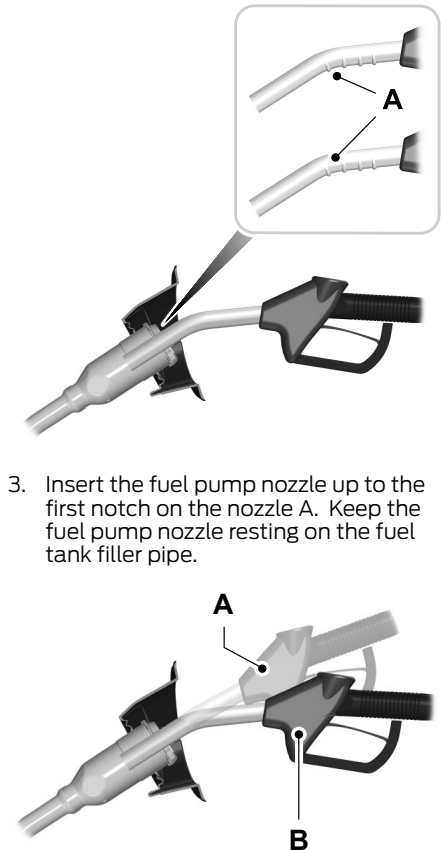

3. Insert the fuel pump nozzle up to the first notch on the nozzle. Keep the fuel pump nozzle resting on the fuel tank filler pipe.

4. Hold the fuel pump nozzle in position B when refueling. Holding the fuel pump nozzle in position A can affect the flow of fuel and shut off the fuel pump nozzle before the fuel tank is full.

E139203

Fuel and Refueling

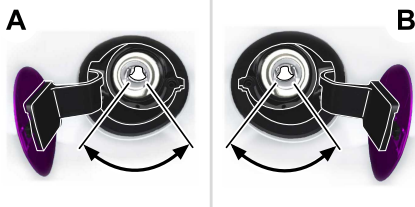

5. Operate the fuel pump nozzle within the area shown.

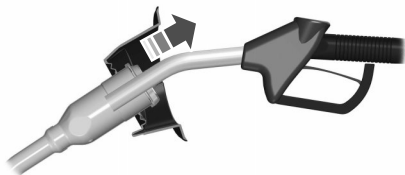

6. When you finish refueling slightly raise the fuel pump nozzle and slowly remove it.
7. Fully close the fuel filler door.

Do not attempt to start the engine if you have filled the fuel tank with incorrect fuel. Incorrect fuel use could cause damage not covered by the vehicle Warranty. Have your vehicle immediately checked.

Refueling System Warning (If Equipped)

If the fuel tank filler valve does not fully close, a message could appear in the information display.

Message
Check Fuel Fill Inlet

If the message appears, do the following:

1. Stop your vehicle as soon as it is safe to do so and switch the engine off.
2. Shift into park (P) or neutral (N).

3. Apply the parking brake.
4. Fully open the fuel filler door.
5. Check the fuel tank filler valve for any debris that may be restricting its movement.
6. Remove any debris from the fuel tank filler valve.
7. Fully insert a fuel pump nozzle or the fuel filler funnel provided with your vehicle into the fuel filler pipe. See **Fuel Filler Funnel Location** (page 151). This action should dislodge any debris that may be preventing the fuel tank filler valve from fully closing.
8. Remove the fuel pump nozzle or fuel filler funnel from the fuel filler pipe.
9. Fully close the fuel filler door.

Note: The message may not immediately reset. If the message continues to appear and a warning lamp illuminates, have your vehicle checked as soon as possible.

FUEL CONSUMPTION

Advertised Capacity

The advertised capacity is the maximum amount of fuel that you can add to the fuel tank when the fuel gauge indicates empty. See **Capacities and Specifications** (page 325).

In addition, the fuel tank contains an empty reserve. The empty reserve is an unspecified amount of fuel that remains in the fuel tank when the fuel gauge indicates empty.

Note: When refueling your vehicle after the fuel gauge indicates empty, you might not be able to refuel the full amount of the advertised capacity due to the empty reserve still present in the fuel tank.

Fuel and Refueling

Filling the Fuel Tank

For consistent results when refueling:

- Turn the ignition off before fueling; an inaccurate reading results if the engine is left running.
- Use the same fill rate (low-medium-high) each time the tank is filled.
- Allow no more than one automatic shut-off when refueling.

Results are most accurate when the filling method is consistent.

Calculating Fuel Economy

Your vehicle calculates fuel economy figures through the trip computer average fuel function. See **Information Displays** (page 96).

The first 1,000 mi (1,500 km) of driving is the break-in period of the engine. A more accurate measurement is obtained after 2,000 mi (3,000 km).

1. Completely fill the fuel tank and record the initial odometer reading.
2. Each time you fill the fuel tank, record the amount of fuel added.
3. After at least three fill ups, fill the fuel tank and record the current odometer reading.
4. Subtract your initial odometer reading from the current odometer reading.

To calculate L/100 km (liters per 100 kilometers) fuel consumption, multiply the liters used by 100, then divide by kilometers traveled. To calculate MPG (miles per gallon) fuel consumption, divide miles traveled by gallons used.

Keep a record for at least one month and record the type of driving, for example city or highway. This provides an accurate estimate of your vehicle's fuel economy under current driving conditions. Keeping records during summer and winter shows how temperature impacts fuel economy.

Conditions

- Heavily loading your vehicle reduces fuel economy.
- Carrying unnecessary weight in your vehicle may reduce fuel economy.
- Avoid adding accessories that increase aerodynamic drag to your vehicle such as bug deflectors, car top carriers and ski or bike racks.
- Using fuel blended with alcohol may lower fuel economy.
- Fuel economy may decrease with lower temperatures.
- Fuel economy may decrease when driving short distances.
- You will get better fuel economy when driving on flat terrain than when driving on hilly terrain.

Engine Emission Control

EMISSION LAW



WARNING: Do not remove or alter the original equipment floor covering or insulation between it and the metal floor of the vehicle. The floor covering and insulation protect occupants of the vehicle from the engine and exhaust system heat and noise. On vehicles with no original equipment floor covering insulation, do not carry passengers in a manner that permits prolonged skin contact with the metal floor. Failure to follow these instructions may result in fire or personal injury.

U.S. federal laws and certain state laws prohibit removing or rendering inoperative emission control system components. Similar federal or provincial laws may apply in Canada. We do not approve of any vehicle modification without first determining applicable laws.



Tampering with emissions control systems including related sensors or the Diesel Exhaust Fluid system can result in reduced engine power and the illumination of the service engine soon light.

Tampering With a Noise Control System

Federal laws prohibit the following acts:

- Removal or rendering inoperative by any person other than for purposes of maintenance.
- Repair or replacement of any device or element of the design incorporated into a new vehicle for the purpose of noise control prior to its sale or delivery to the ultimate purchaser or while it is in use.
- The use of the vehicle after any person removes or renders inoperative any device or element of the design.

The U.S. Environmental Protection Agency may presume to constitute tampering as follows:

- Removal of hood blanket, fender apron absorbers, fender apron barriers, underbody noise shields or acoustically absorptive material.
- Tampering or rendering inoperative the engine speed governor, to allow engine speed to exceed manufacturer specifications.

If the engine does not start, runs rough, experiences a decrease in engine performance, experiences excess fuel consumption or produces excessive exhaust smoke, check for the following:

- A plugged or disconnected air inlet system hose.
- A plugged engine air filter element.
- Water in the fuel filter and water separator.
- A clogged fuel filter.
- Contaminated fuel.
- Air in the fuel system, due to loose connections.
- An open or pinched sensor hose.
- Incorrect engine oil level.

Engine Emission Control

- Incorrect fuel for climatic conditions.
- Incorrect engine oil viscosity for climactic conditions.

Note: *Some vehicles have a lifetime fuel filter that is integrated with the fuel tank. Regular maintenance or replacement is not needed.*

Note: *If these checks do not help you correct the concern, have your vehicle checked as soon as possible.*

Noise Emissions Warranty, Prohibited Tampering Acts and Maintenance

On January 1, 1978, Federal regulation became effective governing the noise emission on trucks over 10,000 lb (4,536 kg) Gross Vehicle Weight Rating (GVWR). The preceding statements concerning prohibited tampering acts and maintenance, and the noise warranty found in the Warranty Guide, are applicable to complete chassis cabs over 10,000 lb (4,536 kg) GVWR.

CATALYTIC CONVERTER



WARNING: Do not park, idle or drive your vehicle on dry grass or other dry ground cover. The emission system heats up the engine compartment and exhaust system, creating the risk of fire.



WARNING: The normal operating temperature of the exhaust system is very high. Never work around or attempt to repair any part of the exhaust system until it has cooled. Use special care when working around the catalytic converter. The catalytic converter heats up to a very high temperature after only a short period of engine operation and stays hot after the engine is switched off.



WARNING: Exhaust leaks may result in entry of harmful and potentially lethal fumes into the passenger compartment. If you smell exhaust fumes inside your vehicle, have your vehicle inspected immediately. Do not drive if you smell exhaust fumes.



WARNING: Do not allow people or animals in truck beds that have modifications, such as bed covers or slide-in campers, when the engine is running. Exhaust fumes are toxic. Failure to follow this instruction could result in personal injury or death.

Your vehicle has various emission control components and a catalytic converter that enables it to comply with applicable exhaust emission standards.

To make sure that the catalytic converter and other emission control components continue to work properly:

- Do not crank the engine for more than 10 seconds at a time.
- Do not run the engine with a spark plug lead disconnected.
- Do not push-start or tow-start your vehicle. Use booster cables. See **Jump Starting the Vehicle** (page 236).
- Use only the specified fuel listed.
- Do not switch the ignition off when your vehicle is moving.
- Avoid running out of fuel.
- Have the items listed in scheduled maintenance information performed according to the specified schedule.

Note: *Your vehicle warranty does not cover resulting component damage.*

The scheduled maintenance items listed in scheduled maintenance information are essential to the life and performance of your vehicle and to its emissions system.

Engine Emission Control

If you use anything other than our parts for maintenance replacements or for service of components affecting emission control, such aftermarket parts should be equivalent to our genuine parts in performance and durability.

Illumination of the service engine soon indicator, charging system warning light or the temperature warning light, fluid leaks, strange odors, smoke or loss of engine power could indicate that the emission control system is not working properly.

An improperly operating or damaged exhaust system may allow exhaust to enter the vehicle. Have a damaged or improperly operating exhaust system inspected and repaired immediately.

Do not make any unauthorized changes to your vehicle or engine. By law, vehicle owners and anyone who manufactures, repairs, services, sells, leases, trades vehicles, or supervises a fleet of vehicles are not permitted to intentionally remove an emission control device or prevent it from working. Information about your vehicle's emission system is on the Vehicle Emission Control Information Decal located on or near the engine. This decal also lists engine displacement.

Please consult your warranty information for complete details.

On-Board Diagnostics (OBD-II)

Your vehicle has a computer known as the on-board diagnostics system (OBD-II) that monitors the engine's emission control system. The system protects the environment by making sure that your vehicle continues to meet government emission standards. The OBD-II system also assists a service technician in properly servicing your vehicle.



When the service engine soon indicator illuminates, the OBD-II system has detected a malfunction. Temporary malfunctions may cause the service engine soon indicator to illuminate. Examples are:

1. Your vehicle has run out of fuel—the engine may misfire or run poorly.
2. Poor fuel quality or water in the fuel—the engine may misfire or run poorly.
3. The fuel fill inlet may not have closed properly. See **Refueling** (page 153).
4. Driving through deep water—the electrical system may be wet.

You can correct these temporary malfunctions by filling the fuel tank with good quality fuel, properly closing the fuel fill inlet or letting the electrical system dry out. After three driving cycles without these or any other temporary malfunctions present, the service engine soon indicator should stay off the next time you start the engine. A driving cycle consists of a cold engine startup followed by mixed city and highway driving. You do not require additional vehicle service.

If the service engine soon indicator remains on, have your vehicle serviced at the first available opportunity. Although some malfunctions detected by the OBD-II may not have symptoms that are apparent, continued driving with the service engine soon indicator on can result in increased emissions, lower fuel economy, reduced engine and transmission smoothness and lead to more costly repairs.

Engine Emission Control

Readiness for Inspection and Maintenance (I/M) Testing

Some state and provincial and local governments may have Inspection/Maintenance (I/M) programs to inspect the emission control equipment on your vehicle. Failure to pass this inspection could prevent you from getting a vehicle registration.



If the service engine soon indicator is on or the bulb does not work, your vehicle may need service. See On-Board Diagnostics.

Your vehicle may not pass the I/M test if the service engine soon indicator is on or not working properly, for example, the bulb does not work, or if the OBD-II system has determined that some of the emission control systems have not been properly checked. In this case, the vehicle is not ready for I/M testing.

If you have just serviced the vehicle's engine or transmission or the battery has recently run down or you have replaced it, the OBD-II system may indicate that the vehicle is not ready for I/M testing. To determine if the vehicle is ready for I/M testing, turn the ignition key to the on position for 15 seconds without cranking the engine. If the service engine soon indicator blinks eight times, it means that the vehicle is not ready for I/M testing; if the service engine soon indicator stays on solid, it means that your vehicle is ready for I/M testing.

The OBD-II system checks the emission control system during normal driving. A complete check may take several days.

If the vehicle is not ready for I/M testing, you can perform the following driving cycle consisting of mixed city and highway driving:

1. 15 minutes of steady driving on an expressway or highway followed by 20 minutes of stop-and-go driving with at least four 30-second idle periods.
2. Allow your vehicle to sit for at least eight hours with the ignition off. Then, start the vehicle and complete the above driving cycle. The vehicle must warm up to its normal operating temperature. Once started, do not turn off the vehicle until the above driving cycle is complete.

If the vehicle is still not ready for I/M testing, you need to repeat the above driving cycle.

Transmission

AUTOMATIC TRANSMISSION



WARNING: Always fully apply the parking brake and make sure you shift into park (P). Failure to follow this instruction could result in personal injury or death.



WARNING: Do not apply the brake pedal and accelerator pedal simultaneously. Applying both pedals simultaneously for more than a few seconds will limit engine performance, which may result in difficulty maintaining speed in traffic and could lead to serious injury.

Note: A cold engine has a higher idle speed. This increases the tendency for your vehicle to creep when you have selected a drive gear.

Transmission Selector Lever Positions

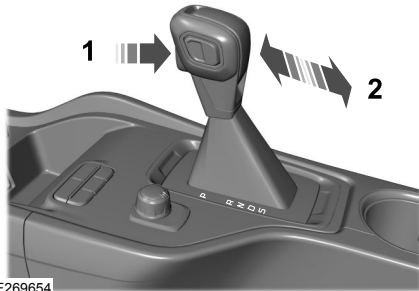

E269654

- P Park.
- R Reverse.
- N Neutral.
- D Drive.
- S Sport mode and manual shifting.

To select a position, depress the button (1) then pull back on the selector lever (2) to engage reverse (R), neutral (N) or drive (D). To select sport mode, first engage drive (D), depress button (1) and then pull back on the selector lever (2). The current gear displays in the instrument panel.

Park (P)

Note: To move the transmission selector lever from park (P), apply the brake with the ignition key in position II.

Note: An audible warning sounds if you open the driver door and you have not moved the selector lever to park (P). The battery saver deactivates the audible warning after a period of time.

In this position, there is no power transmitted to the driven wheels, and the transmission locks. You can start the engine with the transmission selector lever in this position.

Reverse (R)

Shift the selector lever to reverse (R) to allow your vehicle to move backward.

Neutral (N)

In this position, there is no power transmitted to the driven wheels, but the transmission does not lock. You can start the engine with the transmission selector lever in this position.

Drive (D)

Drive (D) is the normal driving position for the best fuel economy and smoothness. Shift the transmission selector lever to drive (D) to allow your vehicle to move forward and shift through the forward gears.

The transmission shifts to the appropriate gear for optimum performance based on ambient temperature, road slope, vehicle load and your input.

Transmission

Sport Mode (S)

Switch on sport mode by shifting the transmission selector lever to sport (S). In sport (S), the transmission selects the optimum gear for best performance. This gear selection is typically lower than that of drive (D), and the shifts are faster.

Tow Mode



To switch on tow mode, press the button on the center console until tow mode is active. The indicator light illuminates in the instrument cluster when the system becomes active.

The tow mode feature:

- Moves upshifts to higher engine speeds to reduce the frequency of transmission shifting.
- Provides engine braking in all forward gears, which slows your vehicle and assists you in controlling your vehicle when descending a slope.
- Depending on driving conditions and load conditions, may downshift the transmission, slow your vehicle and control your vehicle speed when descending a hill, without pressing the accelerator pedal. The amount of downshift braking provided varies based upon the amount you press the brake pedal.

The tow mode feature improves transmission operation when towing a trailer or a heavy load. All transmission gear ranges are available when using tow mode.

To switch off the tow mode feature and return to normal driving mode, press the button on the center console twice. The indicator light turns off when the system turns off. Tow mode also turns off when you power down your vehicle.

SelectShift™ Automatic Transmission

This feature gives you the ability to change gears up or down as desired.

If the engine speed does not exceed the maximum allowable limit, the vehicle allows the downshifts. SelectShift automatically downshifts at low engine speeds to prevent engine stalls.

Note: *Engine damage could occur if you maintain excessive engine revving without shifting.*

SelectShift does not automatically upshift, even if the engine is approaching the RPM limit.

For 10 speed transmissions - with the transmission selector lever in sport (S) position:

- Press the (+) button on the transmission selector lever to upshift.
- Press the (-) button on the transmission selector lever to downshift.

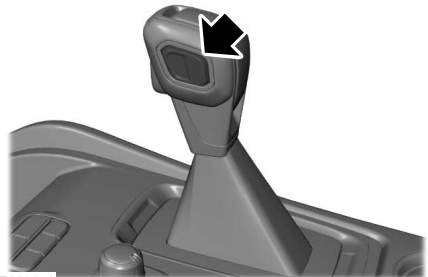

E269656

To exit this mode, return the transmission selector lever to drive (D).

When your vehicle is stationary, you can only select the 1st and 2nd gears. Manual shifting is sequential. Therefore, you cannot skip gears.

Transmission

Progressive Range Selection

This system gives you the ability to lockout gears from the automatic shifting range. This could provide you with an improved driving experience for example, in slippery conditions or when experiencing a steep slope.

With the transmission in drive (D), press the – button to active progressive range selection. The instrument cluster indicates the available and selected gears.

All available gears display with the current gear indicated. Press the – button again to lock out gears beginning with the highest gear. For example, press the – button or twice to lock out 10th and 9th gears. Only the available gears display, and the transmission shifts between the available gears. Press the + button to unlock gears to allow the transmission to shift to higher gears. The transmission shifts within the gear range you select.

Brake-Shift Interlock



WARNING: When doing this procedure, you need to take the transmission out of park (P) which means your vehicle can roll freely. To avoid unwanted vehicle movement, always fully apply the parking brake prior to doing this procedure. Use wheels chocks if appropriate.



WARNING: If the parking brake is fully released, but the brake warning lamp remains illuminated, the brakes may not be working properly. Have your vehicle checked as soon as possible.

Note: Some markets disable this feature.

Your vehicle has a feature that prevents moving the gearshift lever from park (P) when the ignition is on and you do not press the brake pedal.

The system requires service if you cannot move the gearshift lever out of park (P) with the ignition on and the brake pedal pressed. It is possible that a fuse has blown, or your vehicle's brake lamps are not operating properly. See **Fuses** (page 249).

If the fuse has not blown and the brake lamps are properly working, the following procedure allows you to move the selector lever from park (P):

Note: See an authorized dealer as soon as possible if you use this procedure.

10 Speed Transmission

Apply the parking brake and switch the ignition off before performing this procedure.

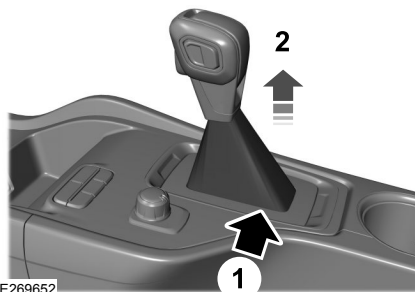

1. Insert a screwdriver between the shifter boot material and the trim ring (1) to release the retainer tabs from the top panel trim ring.
2. Lift the shifter boot (2) upwards.

Transmission

If Your Vehicle Gets Stuck in Mud or Snow

Note: Do not rock your vehicle if the engine is not at normal operating temperature or damage to the transmission could occur.

Note: Do not rock your vehicle for more than a minute or damage to the transmission and tires could occur, or the engine could overheat.

If your vehicle gets stuck in mud or snow, you can rock it out by shifting between forward and reverse gears, stopping between shifts in a steady pattern. Press lightly on the accelerator in each gear.

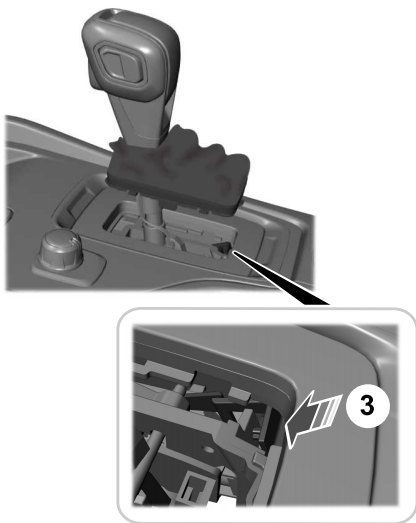

E269653

3. Locate the lower white lever (3) on the side of the transmission selector lever.
4. Using the screwdriver, move the lower white lever (3) toward the front of the transmission selector lever.
5. When holding the lower white lever (3) in the forward position, move the transmission selector lever out of the park (P) position and into another gear.

Automatic Transmission Adaptive Learning

This feature may increase durability and provide consistent shift feel over the life of your vehicle. A new vehicle or transmission may have firm shifts, soft shifts or both. This operation is normal and does not affect function or durability of the transmission. Over time, the adaptive learning process fully updates transmission operation.

Four-Wheel Drive (If Equipped)

PRINCIPLE OF OPERATION

The four-wheel drive system in your vehicle is a part-time system activated using the rotary switch mounted in the center console. In normal rear-wheel drive, the 2H drive operation system directs torque to the rear axle. Moving the switch to 4H or 4L directs drive torque to both the front and rear axles, providing four-wheel drive.

Depending on your vehicle, further four-wheel drive options may be available on the switch panel located on the center console.

USING FOUR-WHEEL DRIVE

Note: *There is additional important information regarding the safe operation of this type of vehicle in this manual. See **General Information** (page 292).*

Note: *Do not use 4H or 4L modes on dry, hard surfaced roads. Doing so can produce excessive noise, increase tire wear and could damage drive components. We intend 4H or 4L modes only for consistently slippery or loose surfaces. Use of 4L mode on these surfaces could produce some noise, such as occasional clunks, but should not damage drive components.*

Note: *When you select 4L when your vehicle is moving, it does not perform a shift until your vehicle is stationary. This is normal and is no reason for concern.*

Note: *You can switch on and switch off the electronic locking differential by pressing the locking differential button. See **Electronic Locking Differential** (page 173).*

4WD Indicator Lights

Note: *When a 4X4 system fault is present, the system typically remains in whichever 4X4 mode you selected prior to the fault condition occurring. It should never default to 4X2. When the warning displays, have your vehicle serviced by an authorized dealer.*

4X4 HIGH



Continuously illuminates when you select 4H.

4X4 LOW



Continuously illuminates when you select 4L.

CHECK 4X4



Displays when a 4X4 fault is present.

Using the Electronic Shift on the Fly 4WD system

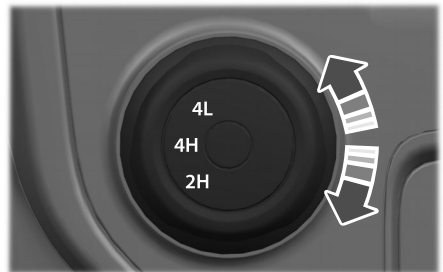

E277079

2H (4X2)

For general on-road driving, this mode provides optimal smoothness and fuel economy. Sends power to the rear wheels only.

Four-Wheel Drive (If Equipped)

Note: 2H may engage or disengage based on terrain mode selection. See **Principle of Operation** (page 165).

4H (4X4 HIGH)

Provides mechanically locked four-wheel drive power to both the front and rear wheels for use in off-road or winter conditions such as deep snow, sand or mud. This mode is not for use on dry pavement.

Note: 4H may engage or disengage based on terrain mode selection. See **Principle of Operation** (page 165).

4L (4X4 LOW)

Provides mechanically locked four-wheel drive power to both the front and rear wheels with additional gearing for increased torque multiplication. Intended only for off-road applications such as deep sand, steep slopes, or pulling heavy objects.

Note: 4L may engage or disengage based on terrain mode selection. See **Principle of Operation** (page 165).

Shifting Between 4WD System Modes

Note: Momentarily releasing the accelerator pedal when performing a shift aids the performance of engagement or disengagement.

Note: Do not perform this operation if the rear wheels are slipping, or when applying the accelerator pedal.

Note: It is normal to hear some noise as the system shifts or engages.

You can move the control between 2H to 4H at a stop or when driving up to 68 mph (110 km/h). The information display may display a message indicating a 4X4 shift and the LED for the selected mode flashes. Once the shift is complete, the LED light for the selected mode remains illuminated.

Shifting To or From 4L (4X4 Low)

Note: It is normal to hear some noise as the system shifts or engages.

1. Stop your vehicle when it is safe to do so.
2. Place the transmission in neutral (N).
3. Move the transfer shift switch to the desired position.

The information display displays a message indicating a 4X4 shift is in progress followed by the system mode selected. If any of the above shift conditions are not present, the shift does not occur and the information display shows information guiding you through the proper shifting procedures.

How Your Vehicle Differs From Other Vehicles



WARNING: Vehicles with a higher center of gravity (utility and four-wheel drive vehicles) handle differently than vehicles with a lower center of gravity (passenger cars). Avoid sharp turns, excessive speed and abrupt steering in these vehicles. Failure to drive cautiously increases the risk of losing control of your vehicle, vehicle rollover, personal injury and death.

Truck and utility vehicles can differ from some other vehicles. Your vehicle may be higher to allow it to travel over rough terrain without getting hung up or damaging underbody components.

The differences that make your vehicle so versatile also make it handle differently than an ordinary passenger car.

Four-Wheel Drive (If Equipped)

Maintain steering wheel control at all times, especially in rough terrain. Since sudden changes in terrain can result in abrupt steering wheel motion, make sure you grip the steering wheel from the outside. Do not grip the spokes of the steering wheel.

Drive cautiously to avoid vehicle damage from concealed objects such as rocks and stumps.

Either know the terrain or examine maps of the area before driving. Map out your route before driving in the area. To maintain steering and braking control of your vehicle, have all four wheels on the ground and they need to be rolling, not sliding or spinning.

Driving Off-Road With Truck and Utility Vehicles

Note: *Your vehicle may have a front air dam. Due to low ground clearance, you can damage it when taking your vehicle off-road. You can take the air dam off by removing the bolts that secure it.*

We design four-wheel drive vehicles for driving on sand, snow, mud and rough terrain and they have operating characteristics that are somewhat different from conventional vehicles, both on and off the road.

The transfer case supplies power to all four wheels. On four-wheel drive vehicles, the transfer case allows you to select different 4WD modes when necessary. Become thoroughly familiar with this information before you operate your vehicle.

Four-wheel drive uses all four wheels to power your vehicle. This increases traction, enabling you to drive over terrain and road conditions that a conventional two-wheel drive vehicle cannot.

Basic Operating Principles

- Drive slower in strong crosswinds which can affect the normal steering characteristics of your vehicle.
- When driving your vehicle on surfaces made slippery by loose sand, water, gravel, snow or ice, proceed with care.
- Do not use 4H or 4L on dry, hard surfaced roads. Doing so can produce excessive noise, increase tire wear and could damage drive components. Use 4H or 4L modes for consistently slippery or loose surfaces.

If Your Vehicle Leaves the Road

If your vehicle leaves the road, reduce your vehicle speed and avoid severe braking. When your vehicle speed decreases, ease your vehicle back onto the road. Do not sharply turn the steering wheel when returning your vehicle to the road.

It may be safer to stay on the shoulder of the road and gradually slow down before returning to the road. You may lose control if you do not slow down or if you too sharply or abruptly turn the steering wheel.

It may be less risky to strike small objects, such as freeway reflectors, with minor damage to your vehicle rather than attempt a sudden return to the road which could cause your vehicle to slide sideways out of control or roll over. Remember, your safety and the safety of others should be your primary concern.

Emergency Maneuvers

In an unavoidable emergency situation where you must make a sudden sharp turn, remember to avoid over-driving your vehicle and turn the steering wheel only as rapidly and as far as required to avoid the emergency. Excessive steering can result in loss of vehicle control. Apply smooth pressure to the accelerator pedal or brake pedal when you require changes in vehicle

Four-Wheel Drive (If Equipped)

speed. Avoid abrupt steering, acceleration and braking. This could result in an increased risk of vehicle roll over, loss of vehicle control and personal injury. Use the available road surface to bring your vehicle to a safe direction of travel.

In the event of an emergency stop, avoid skidding the tires and do not attempt any sharp steering wheel movements.

If your vehicle goes from one type of surface to another, such as concrete to gravel, there can be a change in the way your vehicle responds to a maneuver using steering, acceleration or braking.

Operating Four-Wheel Drive with a Spare or Mismatched Tires

On four-wheel drive vehicles, the size of the spare tire can affect the four-wheel drive system. If there is a significant difference between the size of the spare tire and the remaining tires, you could have limited four-wheel drive functionality, added noise, discomfort and driveline damage. Due to normal tire wear, your spare tire is not necessarily the same size as your on-road tires, which makes your spare tire a dissimilar size. Use the spare tire on a limited basis only. When driving with a dissimilar wheel and tire assembly do not:

- Exceed 50 mph (80 km/h) with a four-wheel drive mode turned on.
- Turn on a four-wheel drive mode unless the vehicle is stationary.
- Use a four-wheel drive mode on dry pavement.

Driving with the full-size dissimilar spare wheel and tire assembly can limit four-wheel drive functionality, especially when driving in a mechanically locked four-wheel drive mode. You can experience the following:

- Additional noise from the transfer case or other drive components.
- Difficulty shifting out of a mechanically locked four-wheel drive mode.
- Driveline component damage.

Mechanical Shift Blocking

On vehicles with an electronic shift-on-the-fly transfer case, the transfer case distributes torque to the front wheels by mechanically interlocking the front and rear driveshafts together. Various external factors can affect shifting performance of this type of system including, but not limited to:

- Vehicle acceleration.
- Dissimilar tire sizes.
- High steering input.

For vehicles with an electronic shift-on-the-fly transfer case, when shifting into two-wheel drive high on dry, hard surfaced roads, we recommend that the following procedure is followed to reduce the likelihood of a mechanical shift block:

- While driving straight, come to a stop on a flat, horizontal surface.
- Shift into park (P).
- Select 2H and wait for the 2H LED to become solid.
- Shift into reverse (R) and let the vehicle roll backward up to 5 ft (1 m).
- Shift into drive (D) and let the vehicle roll forward up to 5 ft (1 m).
- Driving the vehicle around a tight turn at a slow speed.

If the system is mechanically blocked, one or more of the following actions can relieve the mechanical shift block:

- Momentary acceleration.
- Momentary braking.
- Bringing the vehicle to a stop.

Four-Wheel Drive (If Equipped)

- Shifting the transmission to neutral and back to drive.
- Shifting the transmission to reverse and back to drive.
- Driving the vehicle around a tight turn at a slow speed.

Driving in Special Conditions with Four-Wheel Drive

Four-wheel drive vehicles are suitable for driving on sand, snow, mud and rough roads and have operating characteristics that are somewhat different from conventional vehicles, both on and off the freeway.

When driving at slow speeds off road under high load conditions, use a low gear when possible. Low gear operation maximizes the engine and transmission cooling capability.

Basic Operating Principles

When driving your vehicle on surfaces made slippery by loose sand, water, gravel, snow or ice, proceed with care.

Sand

When driving over sand, try to keep all four wheels on the most solid area of the trail. Shift to a lower gear and drive steadily through the terrain. Apply the accelerator slowly and avoid excessive wheel slip.

Do not drive your vehicle in deep sand for an extended period of time. This can cause the system to overheat.

To resume operation, switch the ignition off and allow the system to cool down for a minimum of 15 minutes.

When driving at slow speeds in deep sand under high outside temperatures, use a low gear when possible. Low gear operation maximizes the engine and transmission cooling capability.

Avoid driving at excessive speeds, this causes vehicle momentum to work against you and your vehicle could become stuck to the point that you could require assistance from another vehicle. Remember, you may be able to back out the way you came if you proceed with caution.

Mud and Water

Mud

Be cautious of sudden changes in vehicle speed or direction when you are driving in mud. Even four-wheel drive vehicles can lose traction in slick mud. If your vehicle does slide, steer in the direction of the slide until you regain control of your vehicle.

After driving through mud, clean off residue stuck to rotating driveshafts and tires. Excess mud stuck on tires and rotating driveshafts can cause an imbalance that could damage drive components.

Water

If you must drive through high water, drive slowly. Water may limit traction or brake capability.

When driving through water, determine the depth and avoid water higher than the bottom of the hubs. If the ignition system gets wet, your vehicle could stall.

Once through water, try the brakes. Wet brakes do not stop your vehicle as effectively as dry brakes. Drying improves by applying light pressure to the brake pedal when slowly moving.

Note: *Driving through deep water may damage the transmission. If you submerge the front or rear axle in water, have the axle lubricant and power transfer unit lubricant checked, and change if necessary.*

Four-Wheel Drive (If Equipped)



“Tread Lightly” is an educational program designed to increase public awareness of land-use regulations and responsibilities in our nation’s wilderness areas. We join the U.S. Forest Service and the Bureau of Land Management in encouraging you to help preserve our national forest and other public and private lands by “treading lightly.”

Driving on Hilly or Sloping Terrain

Although natural obstacles may make it necessary to travel diagonally up or down a hill or steep incline, you should drive straight up or straight down.

Note: *Avoid turning on steep slopes or hills. A danger lies in losing traction, slipping sideways and possible vehicle roll over. Do not drive over the crest of a hill without seeing what conditions are on the other side. Do not drive in reverse over a hill without the aid of an observer. Whenever driving on a hill, determine beforehand the route you intend to use.*

When climbing a steep slope or hill, start in a lower gear rather than downshifting to a lower gear from a higher gear once the ascent has started. This reduces strain on the engine and the possibility of stalling.

If your vehicle stalls, do not try to turn around because this could cause vehicle roll over. It is better to reverse back to a safe location.

Apply just enough power to the wheels to climb the hill. Too much power could cause the tires to slip, spin or lose traction, resulting in loss of vehicle control.



Descend a hill in the same gear you would use to climb up the hill to avoid excessive brake application and brake overheating. Do not descend in neutral (N). Move the transmission selector lever to a lower gear. When descending a steep hill, avoid sudden hard braking as you could lose control. Make sure the front wheels are turning so you can steer your vehicle.

If your vehicle has anti-lock brakes, steadily apply the brakes. Do not pump the brakes.

Driving on Snow and Ice



WARNING: If you are driving in slippery conditions that require tire chains or cables, then it is critical that you drive cautiously. Keep speeds down, allow for longer stopping distances and avoid aggressive steering to reduce the chances of a loss of vehicle control which can lead to serious injury or death. If the rear end of your vehicle slides while cornering, steer in the direction of the slide until you regain control of your vehicle.

Note: *Excessive tire slippage can cause transmission damage*

Four-Wheel Drive (If Equipped)

Four-wheel drive vehicles have advantages over two-wheel drive vehicles in snow and ice but can skid like any other vehicle. Should you start to slide when driving on snowy or icy roads, turn the steering wheel in the direction of the slide until you regain control.

Avoid sudden applications of power and quick changes of direction on snow and ice. Apply the accelerator slowly and steadily when starting from a full stop.

Avoid sudden braking. Although a four-wheel drive vehicle may accelerate better than a two-wheel drive vehicle in snow and ice, it cannot stop any faster as braking occurs at all four wheels. Do not become overconfident of road conditions.

Make sure you allow sufficient distance between you and other vehicles for stopping. Drive slower than usual and consider using one of the lower gears. In emergency stopping situations, apply the brake steadily. Do not pump the brake pedal. See **Hints on Driving With Anti-Lock Brakes** (page 175).

If Your Vehicle Gets Stuck In Mud or Snow



WARNING: Do not spin the wheels at over 34 mph (55 km/h). The tires may fail and injure a passenger or bystander.

If your vehicle gets stuck in mud or snow, you may rock it out by shifting between forward and reverse gears, stopping between shifts in a steady pattern. Press lightly on the accelerator in each gear.

Note: Do not rock your vehicle if the engine is not at normal operating temperature, damage to the transmission could occur.

Note: Do not rock your vehicle for more than a minute, damage to the transmission and tires could occur or the engine could overheat.

Parking



WARNING: If the parking brake is fully released, but the brake warning lamp remains illuminated, the brakes may not be working properly. Have your vehicle checked as soon as possible.



WARNING: Apply the parking brake, shift into park (P), switch the ignition off and remove the key before you leave your vehicle. Failure to follow this instruction could result in personal injury or death.

On four-wheel drive vehicles, when the transfer case is in the neutral (N) position, the engine and transmission disconnect from the rest of the driveline. Therefore, your vehicle is free to roll even if the automatic transmission is in park (P) or the manual transmission is in gear. Do not leave your vehicle unattended with the transfer case in the neutral (N) position. Fully set the parking brake and turn off the ignition when leaving your vehicle.

Maintenance and Modifications

We designed and tested the suspension and steering systems on your vehicle to provide predictable performance whether loaded or empty. For this reason, we strongly recommend that you do not make modifications such as adding or removing parts that include lift kits or stabilizer bars, or by using replacement parts not equivalent to the original factory equipment.

We recommend that you use caution when your vehicle has either a high load or device such as ladders or luggage racks. Any modifications to your vehicle that raise the center of gravity could cause your vehicle to roll over when there is a loss of vehicle control.

Four-Wheel Drive (If Equipped)

Failure to maintain your vehicle correctly could void the warranty, increase your repair cost, reduce vehicle performance and operational capabilities, and adversely affect you and your passenger's safety. We recommend you frequently inspect your vehicle's chassis components when your vehicle is subject to off road usage.

Rear Axle

ELECTRONIC LOCKING DIFFERENTIAL (IF EQUIPPED)

Note: Do not operate the system on dry hard surface roads. Doing so could lead to excessive tire noise and wear. Use the system only on consistently slippery or loose surfaces.

The system locks the left and right portions of the rear axle together to form a solid driving axle, resulting in increased rear wheel traction in certain conditions.

Press and hold the electronic differential lock button for 2 seconds to activate the system.

Note: The lock button is on the center console.

Note: Do not perform this operation when cruise control or trail control are selected and active. The system may not engage as expected.



E277073

The electronic differential lock can lock and unlock when the internal gears are aligned and no torque load is placed on the differential. To aid alignment, drive the vehicle in a straight line with the accelerator pedal released. Alternatively, drive slowly forward and backward while moving the steering wheel from side to side to allow the electronic differential lock to lock.

High vehicle speed and high accelerator pedal application inhibit the electronic locking differential system engagement. Follow the instruction on the instrument cluster for engagement and disengagement.

Note: You can use the system in any drive mode 2H, 4H or 4L.

Note: When you engage the system, the Electronic Stability Program (ESP) functions such as Stability Control, Traction Control, Hill Descent Control, Emergency stop signal, Hill Start Assist and Trailer Sway Control are deactivated, the ESP Off indicator illuminates, and the HDC on indicator turns off.

Note: When the anti-lock braking system is operating, the system disengages.

The electronic locking differential system can affect various terrain modes. See **Principle of Operation** (page 182).

Operating Electronic Locking Differential with Spare or Mismatched Tires

The size of the spare tire can affect the performance of the electronic locking differential system. When there is a significant size difference between the two rear tires, you could have limited electronic locking differential functionality. If your electronic locking differential has difficulty disengaging, release your accelerator pedal and turn the steering wheel in the opposite direction while rolling forward.

Note: We recommend that you engage and disengage the electronic locking differential when stopped, and a spare tire is mounted on the rear axle.

Rear Axle

Electronic Locking Differential Engagement Speed and Availability

Terrain Modes (4X4 Modes)	Engagement Speed	Automatic Disen-gage Speed	Automatic Re-Engagement Speed
Normal (2H, 4H)	20 mph (30 km/h)	25 mph (41 km/h)	20 mph (30 km/h)
grass/Gravel/Snow (4H)	20 mph (30 km/h)	25 mph (41 km/h)	20 mph (30 km/h)
Mud/Ruts (4H)	20 mph (30 km/h)	25 mph (41 km/h)	20 mph (30 km/h)
Sand (4H)	55 mph (90 km/h)	60 mph (100 km/h)	55 mph (90 km/h)
4X4 Modes	Engagement Speed	Automatic Disen-gage Speed	Automatic Re-Engagement Speed
4L	No set Speed	No set Speed	No set Speed

Brakes

GENERAL INFORMATION

Note: Occasional brake noise is normal. If a metal-to-metal, continuous grinding or continuous squeal sound is present, the brake linings may be worn-out and an authorized dealer should check them. If the vehicle has continuous vibration or shudder in the steering wheel while braking, an authorized dealer should check your vehicle.

Note: Brake dust may accumulate on the wheels, even under normal driving conditions. Some dust is inevitable as the brakes wear and does not contribute to brake noise. See **Cleaning the Wheels** (page 289).

Wet brakes result in reduced braking efficiency. Gently press the brake pedal a few times when driving from a car wash or standing water to dry the brakes.

Brake Over Accelerator

In the event the accelerator pedal becomes stuck or entrapped, apply steady and firm pressure to the brake pedal to slow the vehicle and reduce engine power. If you experience this condition, apply the brakes and bring your vehicle to a safe stop. Switch the engine off, move the transmission to park (P) and apply the parking brake. Inspect the accelerator pedal and the area around it for any items or debris that may be obstructing its movement. If none are found and the condition persists, have your vehicle towed to the nearest authorized dealer.

Emergency Brake Assist

Emergency brake assist detects when you brake heavily by measuring the rate at which you press the brake pedal. It provides maximum braking efficiency as long as you press the pedal. Emergency brake assist can reduce stopping distances in critical situations.

Anti-lock Brake System

This system helps you maintain steering control during emergency stops by keeping the brakes from locking.



This lamp momentarily illuminates when you switch the ignition on. If the light does not illuminate during start up, remains on or flashes, the anti-lock braking system may be disabled. Have the system checked by an authorized dealer. If the anti-lock brake system is disabled, normal braking is still effective.

See **Warning Lamps and Indicators** (page 92).

Note: Indicators vary depending on region.



This lamp also illuminates momentarily when you switch the ignition on to confirm the lamp is functional. If it does not illuminate when you switch the ignition on, or begins to flash at any time, have the system checked by an authorized dealer. If the brake warning lamp illuminates with the parking brake released, have the system checked immediately.

HINTS ON DRIVING WITH ANTI-LOCK BRAKES

The anti-lock brake system does not eliminate the risks when:

- You drive too closely to the vehicle in front of you.
- Your vehicle is hydroplaning.
- You take corners too fast.
- The road surface is poor.

Brakes

Note: If the system activates, the brake pedal could pulse and may travel further. Maintain pressure on the brake pedal. You may also hear a noise from the system. This is normal.

PARKING BRAKE



WARNING: Always fully apply the parking brake and make sure you shift into park (P). Switch the ignition off and remove the key whenever you leave your vehicle.

To apply the parking brake:

1. Firmly press the brake pedal.
2. Pull the parking brake lever upward to its fullest extent.

Note: Do not press the release button when pulling the parking brake lever upward.

Note: If you park your vehicle on a hill and facing uphill, shift into park (P) and turn the steering wheel away from the curb.

Note: If you park your vehicle on a hill and facing downhill, shift into park (P) and turn the steering wheel toward the curb.

To release the parking brake:

1. Firmly press the brake pedal.
2. Slightly pull the parking brake lever upward.
3. Press the release button and push the parking brake lever downward.

HILL START ASSIST



WARNING: The system does not replace the parking brake. When you leave your vehicle, always apply the parking brake.



WARNING: You must remain in your vehicle when the system turns on. At all times, you are responsible for controlling your vehicle, supervising the system and intervening, if required. Failure to take care may result in the loss of control of your vehicle, serious personal injury or death.



WARNING: The system will turn off if a malfunction is apparent or if you rev the engine excessively. Failure to take care may result in the loss of control of your vehicle, serious personal injury or death.

The system makes it easier to pull away when your vehicle is on a slope without the need to use the parking brake.

When the system is active, your vehicle remains stationary on the slope for two to three seconds after you release the brake pedal. This allows time to move your foot from the brake to the accelerator pedal. The system releases the brakes automatically once the engine has developed sufficient torque to prevent your vehicle from rolling down the slope. This is an advantage when pulling away on a slope, for example from a car park ramp, traffic lights or when reversing uphill into a parking space.

The system activates on any slope that causes your vehicle to roll.

Note: There is no warning light to indicate the system is either on or off.

Using Hill Start Assist

1. Press the brake pedal to bring your vehicle to a complete standstill. Keep the brake pedal pressed and shift into first gear when facing uphill or reverse (R) when facing downhill.

Brakes

2. If the sensors detect that your vehicle is on a slope, the system activates automatically.
3. When you remove your foot from the brake pedal, your vehicle remains on the slope without rolling away for about two to three seconds. This hold time automatically extends if you are in the process of driving off.
4. Drive off in the normal manner. The system releases the brakes automatically.

Note: *When you remove your foot from the brake pedal and press the pedal again when the system is active, you will experience significantly reduced brake pedal travel. This is normal.*

Switching the System On and Off

Vehicles with Automatic Transmission

You cannot turn the system on or off. When you switch the ignition on, the system automatically turns on.

Traction Control

PRINCIPLE OF OPERATION

The traction control system helps avoid drive wheel spin and loss of traction.

If your vehicle begins to slide, the system applies the brakes to individual wheels and, when needed, reduces engine power at the same time. If the wheels spin when accelerating on slippery or loose surfaces, the system reduces engine power in order to increase traction.

USING TRACTION CONTROL



WARNING: Operating your vehicle with the traction control disabled could lead to an increased risk of loss of vehicle control, vehicle rollover, personal injury and death.

The system automatically turns on each time you switch the ignition on.

If your vehicle is stuck in mud or snow, switching traction control off may be beneficial as this allows the wheels to spin.

Note: *When you switch traction control off, stability control remains fully active.*

Switching the System Off

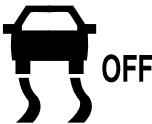

E166706

The switch for the stability and traction control system is on the console.

When you switch the system off, a message and an illuminated icon appear on the instrument cluster.

Use the switch again to return the traction control system to normal operation.

Your vehicle may have MyKey restrictions regarding this feature. See **Principle of Operation** (page 59).

System Indicator Lights and Messages



The stability and traction control light temporarily illuminates on engine start-up and flashes:

- When a driving condition activates either of the systems.
- If a problem occurs in either of the systems.



The stability and traction control off light temporarily illuminates on engine start-up and stays on:

- When you switch the traction control system off.
- When you select an alternative stability control mode.

Stability Control

PRINCIPLE OF OPERATION



WARNING: Vehicle modifications involving braking system, aftermarket roof racks, suspension, steering system, tire construction and wheel and tire size may change the handling characteristics of your vehicle and may adversely affect the performance of the electronic stability control system. In addition, installing any stereo loudspeakers may interfere with and adversely affect the electronic stability control system. Install any aftermarket stereo loudspeaker as far as possible from the front center console, the tunnel, and the front seats in order to minimize the risk of interfering with the electronic stability control sensors. Reducing the effectiveness of the electronic stability control system could lead to an increased risk of loss of vehicle control, vehicle rollover, personal injury and death.



WARNING: Remember that even advanced technology cannot defy the laws of physics. It's always possible to lose control of a vehicle due to inappropriate driver input for the conditions. Aggressive driving on any road condition can cause you to lose control of your vehicle increasing the risk of personal injury or property damage. Activation of the electronic stability control system is an indication that at least some of the tires have exceeded their ability to grip the road; this could reduce the operator's ability to control the vehicle potentially resulting in a loss of vehicle control, vehicle rollover, personal injury and death. If your electronic stability control system activates, SLOW DOWN.

The system automatically turns on each time you switch the ignition on.

If the stability control or traction control system detects a fault, the following may occur:

- The stability and traction control light illuminates steadily.
- The stability control and traction control systems do not enhance your vehicle's ability to maintain traction of the wheels.

If the stability control or traction control system activates, the following may occur:

- The stability and traction control light flashes.
- Your vehicle slows down.
- Reduced engine power.
- A vibration in the brake pedal.
- The brake pedal is stiffer than usual.
- If the driving condition is severe and your foot is not on the brake pedal, the pedal may move as the system applies higher brake force.

The stability control system has several features built into it to help you maintain control of your vehicle.

Electronic Stability Control

The system helps to prevent your vehicle skidding or laterally sliding by individually applying the brakes to one or more wheels and, if necessary, reducing engine power.

Roll Stability Control

The system helps to prevent rollovers by detecting your vehicle's roll motion, and individually applying the brakes to one or more wheels.

Traction Control

The system enhances your vehicle's ability to maintain traction of the wheels by detecting and controlling wheel spin. See **Using Traction Control** (page 178).

Stability Control

USING STABILITY CONTROL

AdvanceTrac™ with Roll Stability Control™ (RSC™)

The system automatically turns on each time you switch the ignition on.

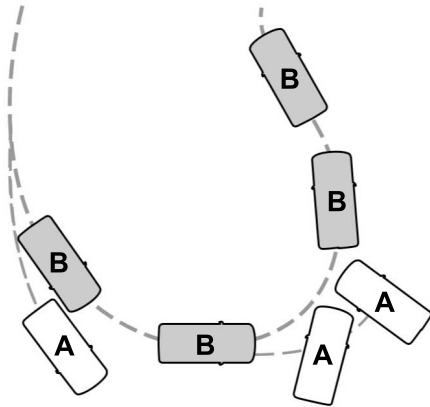

- A Vehicle without stability control skidding off its intended route.
- B Vehicle with stability control maintaining control on a slippery surface.

You can switch the electronic stability control systems off.

When you shift the transmission into reverse (R), the systems are disabled.

You can switch the traction control system off or on independently. See **Using Traction Control** (page 178).

AdvanceTrac with RSC Features

Button functions	Stability control OFF light	Roll stability control	Electronic stability control	Traction control system
Default at start-up	Illuminated during bulb check	Enabled	Enabled	Enabled
Button pressed momentarily	Illuminated	Enabled	Enabled	Disabled
Button pressed and held for more than 5 seconds	Illuminated	After Enabled ¹	Disabled	Disabled

Stability Control

AdvanceTrac with RSC Features				
Button pressed again after deactivation	Not illuminated	Enabled	Enabled	Enabled
Transfer case switched to 4WD Low	Illuminated	Enabled ¹	Disabled	Disabled

¹ Roll Stability Control is disabled in the Sand Terrain Mode.

Terrain Control (If Equipped)

PRINCIPLE OF OPERATION

Using the Terrain Management System

The terrain management system optimizes drivability and comfort by maximizing traction when operating on different types of terrain.

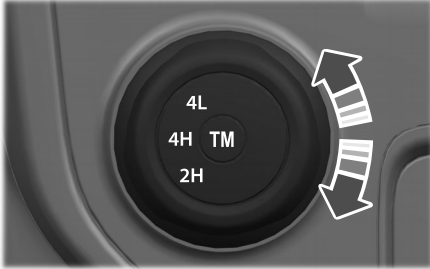

E282969

Press the TM button on the center console to choose between the following modes:

Note: Changing terrain modes could automatically change your 4x4 setting for optimal performance.



Normal - For on-road conditions. Select this mode before driving on surfaces which are similar to a hard road surface or once the need for a special mode has passed.

Note: This is the default when you switch on your vehicle and whenever you select 4x2 via the four-wheel drive control.



Grass/Gravel/Snow - For off-road conditions. Select this mode where loose or slippery material such as packed snow, ice, grass, or a thin layer of gravel or sand covers a firm surface. If your vehicle cannot gain traction in deep snow, switching off the traction control system could help.

Note: Make sure you switch traction control back on when you regain traction.



Mud/Ruts - For off-road conditions. Select this mode for muddy, rutted, soft or uneven terrain.



Sand - For off-road conditions. Select this mode in soft dry sand or deep gravel. If crossing wet sand that could be sufficiently deep enough for the wheels to sink into the surface, select Mud/Ruts mode.

Note: The Grass/Gravel/Snow, Sand and Mud/Ruts modes are for off-road use only.

Note: The curve control portion of the AdvanceTrac® system is unavailable when you select Sand or Mud/Ruts. If the system becomes inoperable, selecting some modes may not be possible and a message displays. If it becomes inoperable due to a system fault, all of the mode indicators on the control turn off and one of the following messages appears in the information display:

TERRAIN MANAGEMENT SYSTEM FAULT

Switching the engine on and off may clear the fault. If that does not work, have the system serviced by an authorized dealer.

MODE CHANGE NOT ACCEPTED, RETRY

This mode change cannot be made at the time of your request. Try the mode change again.

Off-road Screen

You can continuously monitor the real-time status of your vehicle's off-road systems using the information display.

Terrain Control (If Equipped)

Note: Operating your vehicle in any of the off-road modes does not guarantee that it cannot become stuck in sand, snow or mud or other debris. It is your responsibility to assess off-road situations and determine if the terrain is passable.

Transfer Case Availability

Drive selection / Terrain mode	Normal ¹	Grass/Gravel/Snow	Mud/Ruts	Sand
4x2	Available	Not Available	Not Available	Not Available
4x4 High	Available	Available	Available	Available
4x4 Low	Available	Available	Available	Available

¹ Default Terrain Mode across ignition cycles.

Trail Control (If Equipped)

WHAT IS TRAIL CONTROL



WARNING: The system does not control speed in low traction conditions or extremely steep slopes. The system is designed to be an aid and does not relieve you of your responsibility to drive with due care and attention. Failure to follow this instruction could result in personal injury.



WARNING: The system does not replace the parking brake. When you leave your vehicle, always apply the parking brake and shift the transmission into park (P) for automatic transmission or first gear for manual transmission.

Trail control lets you focus on steering during low-speed and off-road use by controlling your vehicle's acceleration and braking.

You can use trail control under the following speeds:

- 20 mph (31 km/h) in two-wheel or four-wheel drive high range.
- 10 mph (15 km/h) in four-wheel drive low range.
- 5 mph (8 km/h) in reverse (R).

You may hear a noise from the anti-lock brake system pump motor when you use the system. This is normal.

SWITCHING TRAIL CONTROL ON AND OFF



Press the button.

The system switches off if you press the button again or exceed 42 mph (68 km/h).

SETTING THE TRAIL CONTROL SPEED



E262918

Note: The buttons are on the steering wheel.

Drive to the speed you prefer.



Press the button to increase the current set speed.



Press the button to decrease the current set speed.

Note: The indicator changes color.

You can adjust the set speed in small or large increments. Press the toggle button upward or downward once to adjust the set speed in small increments. Press and hold the toggle button upward or downward to adjust the set speed in large increments.

You can also adjust the set speed by braking.

Note: Pressing the brake pedal does not switch off the system.

CANCELING THE SET SPEED



Press the button.

Trail Control (If Equipped)

TRAIL CONTROL INDICATORS



TRAIL CONTROL – TROUBLESHOOTING

TRAIL CONTROL – INFORMATION MESSAGES

Message	Action
Reduce Speed To Enter Trail Control	Displays when you must reduce your vehicle speed to use trail control.
Trail Control Not Available with Park Brake Applied	Displays when you must release the park brake to use trail control.
Trail Control Enabled Use SET Button to Set Speed	Displays when you successfully enabled trail control and can set a speed with the SET+ or SET- control.
Trail Control Off Driver Resume Control	Displays when a system fault has occurred when trail control was active and the driver must resume control.
Trail Control Off	Displays when the system has turned off.
Trail Control Fault See Manual	Displays when a system fault is present. See the trail control section in your Owner's Manual.
Trail Control To Activate Select Gear	Displays when you must be in drive (D), neutral (N) or reverse (R) to use trail control.
Trail Control Not Available with Cruise Control Active	Displays when you must switch the cruise control off to use trail control.
Trail Control Not Available with Driver Door Open	Displays when you must close the driver door to use trail control.
Descent Control Now Active Press Trail Control Switch To Exit	You switched Descent Control off, causing the system to turn trail control propulsion off. The vehicle still brakes if descending a hill. You must press the trail control switch to reset the system and switch it off. You can press the switch again to switch this system on.

Parking Aids

PRINCIPLE OF OPERATION

 **WARNING:** To help avoid personal injury, always use caution when in reverse (R) and when using the sensing system.

 **WARNING:** The system may not detect objects with surfaces that absorb reflection. Always drive with due care and attention. Failure to take care may result in a crash.

 **WARNING:** Traffic control systems, fluorescent lamps, inclement weather, air brakes, external motors and fans may affect the correct operation of the sensing system. This may cause reduced performance or false alerts.

 **WARNING:** The system may not detect small or moving objects, particularly those close to the ground.

 **WARNING:** If damage occurs in the immediate area surrounding the sensor, have your vehicle checked as soon as possible.

 **WARNING:** The parking aid system can only assist you to detect objects when your vehicle is moving at parking speeds. To help avoid personal injury you must take care when using the parking aid system.

 **WARNING:** In cold and severe weather conditions the system may not function. Rain, snow and spray can all limit sensor performance.

 **WARNING:** The system may not function if the sensor is blocked.

Note: If your vehicle has MyKey™, the sensing system cannot be switched off when a MyKey™ is present. See **Principle of Operation** (page 59).

Note: Do not clean the sensors with sharp objects.

Note: If your vehicle sustains damage to the bumper or fascia and you leave it misaligned or bent, the sensing zone could be altered causing inaccurate measurement of obstacles or false alerts.

Note: Add-on devices such as large trailer hitches, bike or surfboard racks, license plate brackets, or bumper covers installed around the bumper or fascia can block the normal detection zone of the system causing false alerts. Remove the add-on devices to prevent false alerts.

Note: When you connect a trailer to your vehicle, the rear parking aid could detect the trailer and therefore provide an alert. Disable the rear parking aid when you connect a trailer to prevent the alert.

The sensing system warns you of obstacles within a certain range of your vehicle. The system turns on when you switch the ignition on.

You can switch the system off through the information display menu or from the pop-up message that appears once you shift the transmission into reverse (R). See **General Information** (page 96). If your vehicle has a parking aid button, you can switch the system off by pressing the button. The system turns on when you switch the ignition on.

If a fault is present in the system, a warning message appears in the information display. See **Information Messages** (page 104).

Parking Aids

REAR PARKING AID (IF EQUIPPED)

The rear sensors are only active when the transmission is in reverse (R). As your vehicle moves closer to the obstacle, the rate of the audible warning increases. When the obstacle is less than 12 in (30 cm) away, the warning sounds continuously. If the system detects a stationary or receding object farther than 12 in (30 cm) from the corners of the bumper, the tone sounds for only three seconds. Once the system detects an object approaching, the warning sounds again.



Coverage area of up to 6 ft (1.8 m) from the rear bumper. There may be decreased coverage area at the outer corners of the bumper.

The system detects certain objects while the transmission is in reverse (R):

- Your vehicle is moving toward a stationary object at a speed of 3 mph (5 km/h) or less.
- Your vehicle is not moving, but a moving object is approaching the rear of your vehicle at a speed of 3 mph (5 km/h) or less.
- Your vehicle is moving at a speed of less than 3 mph (5 km/h) and a moving object is approaching the rear of your vehicle at a speed of less than 3 mph (5 km/h).

The system provides audio warnings only when your vehicle is moving or when your vehicle is stationary and the detected obstacle is less than 12 in (30 cm) away from the bumper.

Obstacle Distance Indicator (If Equipped)

The system provides obstacle distance indication through the information display. The distance indicator displays when the transmission is in reverse (R).

The indicator displays:

- As the distance to the obstacle decreases the indicator blocks illuminate and move towards the vehicle icon.
- If there is no obstacle detected, the distance indicator blocks are greyed out.

FRONT PARKING AID (IF EQUIPPED)

The front sensors are active when the transmission is in any position other than park (P) and your vehicle is traveling at low speed.

Parking Aids



If the transmission is in reverse (R), the front sensing system provides audio warnings when your vehicle is moving and the detected obstacle is moving towards your vehicle. Once the vehicle is stationary, the audio warning stops after two seconds. Visual indication is always present in reverse (R).

If the transmission is in drive (D) or any other forward gear (for example, low (L), sport (S) or any forward gear in a manual transmission), the front sensing system provides audio and visual warnings when your vehicle is moving below a speed of 5 mph (8 km/h) and an obstacle is inside the detection area. Once the vehicle is stationary, the audio warning stops after two seconds and the visual indication stops after four seconds. If the obstacles detected are within 12 in (30 cm), the visual indication remains on.

If the transmission is in neutral (N), the system provides visual indication only when your vehicle is moving at 5 mph (8 km/h) or below and an obstacle is inside the detection area. Once your vehicle is stationary, the visual indication stops after four seconds.

REAR VIEW CAMERA



WARNING: The rear view camera system is a reverse aid supplement device that still requires the driver to use it in conjunction with the interior and exterior mirrors for maximum coverage.



WARNING: Objects that are close to either corner of the bumper or under the bumper, might not be seen on the screen due to the limited coverage of the camera system.

Coverage area of up to 28 in (70 cm) from the front bumper. The coverage area decreases at the outer corners.

When your vehicle approaches an object, a warning tone sounds. When your vehicle moves closer to an object, the warning tone repeat rate increases. The warning tone sounds continuously when an object is 12 in (30 cm) or less from the front bumper.

You can switch the system off through the information display menu or from the pop-up message that appears once you shift the transmission into reverse (R). See **General Information** (page 96). If your vehicle has a parking aid button, you can switch the system off by pressing the button.

Obstacle Distance Indicator (if Equipped)

The system provides obstacle distance indication through the information display.

The indicator displays:

- As the distance to the obstacle decreases the indicator blocks illuminate and move towards the vehicle icon.
- If there is no obstacle detected, the distance indicator blocks turn grey.

Parking Aids



WARNING: Reverse your vehicle slowly. Failure to follow this instruction could result in the loss of control of your vehicle, personal injury or death.



WARNING: Use caution when turning camera features on or off when the transmission is not in park (P). Make sure your vehicle is not moving.

The rear view camera system provides a video image of the area behind your vehicle.

During operation, lines appear in the display which represent your vehicle's path and proximity to objects behind your vehicle.

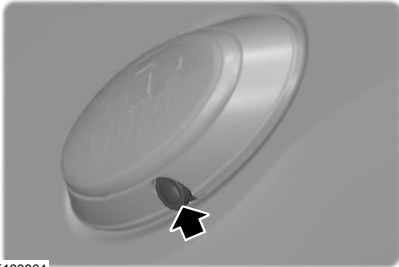

E133364

The rear view camera is on the tailgate.

Using the Rear View Camera System

The rear view camera system displays what is behind your vehicle when you place the transmission in reverse (R).

The system uses three types of guides to help you see what is behind your vehicle:

- Active guidelines: Show the intended path of your vehicle while reversing.
- Fixed guidelines: Show the actual path your vehicle is moving in while reversing in a straight line. This can be helpful when backing into a parking space or aligning your vehicle with another object behind you.
- Centerline: Helps align the center of your vehicle with an object (for example, a trailer).

Note: *If the image comes on while the transmission is not in reverse (R), have the system inspected by your authorized dealer.*

Note: *When towing, the camera only sees what you are towing behind your vehicle. This might not provide adequate coverage as it usually provides in normal operation and you might not see some objects. In some vehicles, the guidelines may disappear once you engage the trailer tow connector.*

The camera may not operate correctly under the following conditions:

- Nighttime or dark areas if the reverse lamps are not operating.
- Mud, water or debris obstructs the camera's view. Clean the lens with a soft, lint-free cloth and non-abrasive cleaner.
- The rear of your vehicle is hit or damaged, causing the camera to become misaligned.

Camera System Settings

You can access the rear view camera system settings in the display screen. See **Settings** (page 393).

Camera guidelines

Note: *Active guidelines and fixed guidelines are only available when the transmission is in reverse (R).*

Parking Aids

Note: The centerline is only available if active or fixed guidelines are on.

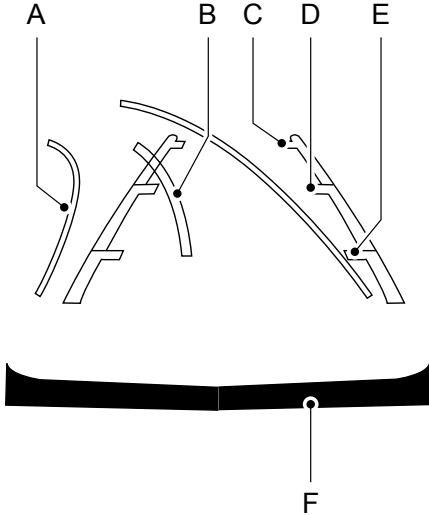

E142436

- A Active guidelines
- B Centerline
- C Fixed guideline: Green zone
- D Fixed guideline: Yellow zone
- E Fixed guideline: Red zone
- F Rear bumper

Active guidelines only show with fixed guidelines. To use active guidelines, turn the steering wheel to point the guidelines toward an intended path. If the steering wheel position changes while reversing, your vehicle might deviate from the original intended path.

The fixed and active guidelines fade in and out depending on the steering wheel position. The active guidelines do not show when the steering wheel position is straight.

Always use caution while reversing. Objects in the red zone are closest to your vehicle and objects in the green zone are farther away. Objects are getting closer to your vehicle as they move from the green zone to the yellow or red zones. Use the side view mirrors and rear view mirror to get better coverage on both sides and rear of your vehicle.

Obstacle Distance Indicator (If Equipped)

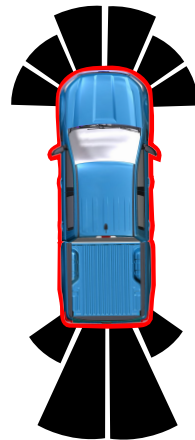

The system provides an image of your vehicle and the sensor zones. The zones will highlight green, yellow and red when the parking aid sensors detect an object in the coverage area.

Parking Aids

Manual Zoom



WARNING: When manual zoom is on, the full area behind your vehicle may not show. Be aware of your surroundings when using the manual zoom feature.

Note: *Manual zoom is only available when the transmission is in reverse (R).*

Note: *Only the centerline shows when you enable manual zoom.*

Selectable settings for this feature are zoom in (+) and zoom out (-). Press the symbol on the camera screen to change the view. The default setting is zoom off.

This allows you to get a closer view of an object behind your vehicle. The zoomed image keeps the bumper in the image to provide a reference. The zoom is only active while the transmission is in reverse (R).

Rear Camera Delay

Selectable settings for this feature are on and off. The default setting for the rear camera delay is OFF.

When shifting the transmission out of reverse (R) and into any gear other than park (P), the camera image remains in the display until your vehicle speed reaches 6 mph (10 km/h). This occurs when the rear camera delay feature is on.

Cruise Control (If Equipped)

PRINCIPLE OF OPERATION

Cruise control lets you maintain a set speed without keeping your foot on the accelerator pedal. You can use cruise control when your vehicle speed is greater than 20 mph (30 km/h).

USING CRUISE CONTROL (IF EQUIPPED)



WARNING: Do not use cruise control on winding roads, in heavy traffic or when the road surface is slippery. This could result in loss of vehicle control, serious injury or death.



WARNING: When you are going downhill, your vehicle speed could increase above the set speed. The system does not apply the brakes.

Note: *The system cancels if your vehicle speed drops below 10 mph (16 km/h) under the set speed when driving uphill.*



E266656

The cruise controls are on the steering wheel. See **Cruise Control** (page 73).

Switching Cruise Control On

Press **ON**.



The indicator appears in the information display.

Setting the Cruise Speed

Drive to the speed you prefer.

SET+

Press to set the current speed.

SET-

Press to set the current speed.

Take your foot off the accelerator pedal.

Note: *The indicator changes color.*

Changing the Set Speed

SET+

Press and release to increase the set speed in small increments.

SET-

Press and release to decrease the set speed in small increments.

Press and hold either button to accelerate or decelerate, respectively. Release the button when you reach the speed you prefer.

Press the accelerator or brake pedal until you reach the speed you prefer. Press either button.

Note: *If you accelerate by pressing only the accelerator pedal, the set speed does not change. When you release the accelerator pedal, your vehicle returns to the speed that you previously set.*

Canceling the Set Speed

CAN

Press the button, or tap the brake pedal to cancel the set speed.

Note: *The system remembers the set speed.*

Cruise Control (If Equipped)

Resuming the Set Speed

RES

Press to resume the set speed.

Switching Cruise Control Off

OFF

Press and release the button when the system is in standby mode or switch the ignition off.

Note: *You erase the set speed when you switch the system off.*

USING ADAPTIVE CRUISE CONTROL (IF EQUIPPED)



WARNING: You are responsible for controlling your vehicle at all times. The system is designed to be an aid and does not relieve you of your responsibility to drive with due care and attention. Failure to follow this instruction could result in the loss of control of your vehicle, personal injury or death.



WARNING: Pay close attention to changing road conditions such as entering or leaving a highway, on roads with intersections or roundabouts, roads without visible lanes of travel, roads that are unpaved, or steep slopes. Failure to follow this instruction could result in the loss of control of your vehicle, personal injury or death.



WARNING: Do not use the system in poor visibility, for example fog, heavy rain, spray or snow.



WARNING: Do not use the system when towing a trailer that has aftermarket electronic trailer brake controls. Failure to follow this instruction could result in the loss of control of your vehicle, personal injury or death.



WARNING: Do not use tire sizes other than those recommended because this can affect the normal operation of the system. Failure to do so may result in a loss of vehicle control, which could result in serious injury.



WARNING: The system may not detect stationary or slow moving vehicles below 6 mph (10 km/h).



WARNING: The system does not detect pedestrians or objects in the road.



WARNING: The system does not detect oncoming vehicles in the same lane.



WARNING: The system is not a crash warning or avoidance system.



WARNING: Do not use the system with a snow plow blade installed.

The system adjusts your vehicle speed to maintain the set gap between you and the vehicle in front of you in the same lane. You can select four gap settings.

The system uses a radar sensor that directly projects a beam in front of your vehicle.

Cruise Control (If Equipped)



E266656

The adaptive cruise controls are on the steering wheel.

Switching Adaptive Cruise Control On



Press and release the button.



The indicator, current gap setting and set speed appear in the information display.

The color of the indicator changes to indicate the system status. Gray indicates the system is on but inactive. Green indicates that you set the speed and the system is active.

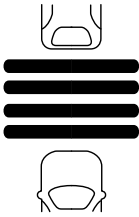

E164805

Setting the Adaptive Cruise Speed

Drive to the speed you prefer. The minimum set speed is 20 mph (30 km/h).

SET+

SET-

Press and release either button.

Take your foot off the accelerator pedal.

The indicator, current gap setting and set speed appear in the information display.

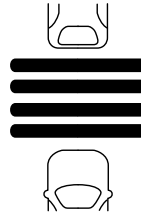

E164805

A vehicle graphic illuminates if there is a vehicle detected in front of you.

Note: When adaptive cruise control is active, the speedometer may vary slightly from the set speed displayed in the information display.

Following a Vehicle



WARNING: When following a vehicle that is braking, your vehicle does not always decelerate quickly enough to avoid a crash without driver intervention. Apply the brakes when necessary. Failure to follow this instruction could result in personal injury or death.



WARNING: The system only warns of vehicles detected by the radar and camera sensors. In some cases there may be no warning or a delayed warning. Apply the brakes when necessary. Failure to follow this instruction could result in personal injury or death.

Cruise Control (If Equipped)

Note: When you are following a vehicle and you switch on a direction indicator, adaptive cruise control may provide a small temporary acceleration to help you pass.

Note: The brakes may emit noise when applied by the system.

When a vehicle ahead of you enters the same lane or a slower vehicle is ahead in the same lane, the vehicle speed adjusts to maintain a preset gap distance. A vehicle graphic illuminates in the instrument cluster.

Your vehicle maintains a consistent gap from the vehicle ahead until:

- The vehicle in front of you accelerates to a speed above the set speed.
- The vehicle in front of you moves out of the lane you are in.
- Your vehicle speed falls below 12 mph (20 km/h).
- You set a new gap distance.

The system applies the brakes to slow your vehicle to maintain a safe gap distance from the vehicle in front. The system only applies limited braking. You can override the system by applying the brakes.

If the system determines that its maximum braking level is not sufficient, an audible warning sounds, a message appears in the information display and an indicator flashes when the system continues to brake. Take immediate action.

Setting the Gap Distance

You can decrease or increase the distance between your vehicle and the vehicle in front by pressing the gap control.



Press and release to decrease the gap distance.



Press and release to increase the gap distance.

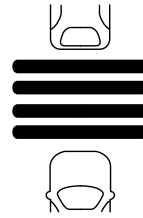

E164805

The selected gap appears in the information display as shown by the bars in the image.

Note: The gap setting is time dependent and therefore the distance adjusts with your vehicle speed.

Note: It is your responsibility to select a gap appropriate to the driving conditions.

Adaptive Cruise Control Gap Settings

Graphic display, bars indicated between vehicles	Distance Gap	Dynamic behavior
1	Closest.	Sport.
2	Close.	Normal.
3	Medium.	Normal.
4	Far.	Comfort.

Each time you switch the system on, it selects the last chosen gap setting.

Overriding the Set Speed

 **WARNING:** If you override the system by pressing the accelerator pedal, it does not automatically apply the brakes to maintain a gap from any vehicle ahead.

Cruise Control (If Equipped)

When you press the accelerator pedal, you override the set speed and gap distance.



Use the accelerator pedal normally to intentionally exceed the set speed limit.

When you override the system, the green indicator light illuminates and the vehicle image does not appear in the information display.

The system resumes operation when you release the accelerator pedal. The vehicle speed decreases to the set speed, or a lower speed if following a slower vehicle.

Changing the Set Speed

SET+

Press and release to increase the set speed in small increments.

SET-

Press and release to decrease the set speed in small increments.

Press and hold either button to change the set speed in large increments. Release the button when the set speed equals the speed you prefer.

Press the accelerator or brake pedal until you reach the speed you prefer. Press either button.

The system may apply the brakes to slow the vehicle to the new set speed. The set speed displays continuously in the information display when the system is active.

Canceling the Set Speed

CAN

Press and release the button or tap the brake pedal.

The set speed does not erase.

Resuming the Set Speed

RES

Press and release the button.

Your vehicle speed returns to the previously set speed and gap setting. The set speed displays continuously in the information display when the system is active.

Note: *Only use resume if you are aware of the set speed and intend to return to it.*

Automatic Cancellation

The system is not functional at vehicle speeds below 12 mph (20 km/h). The information display indicates low engine speed, an audible alarm sounds and the automatic braking releases if the vehicle drops below this speed.

Automatic cancellation can also occur when:

- The tires lose traction.
- You apply the parking brake.

Note: *If the engine speed drops too low, an audible warning sounds and a message appears in the information display. Automatic braking releases.*

Hilly Condition Usage

Note: *An audible alarm sounds and the system shuts down if it applies brakes for an extended period of time. This allows the brakes to cool. The system normally functions again when the brakes have cooled.*

Select a lower gear during prolonged downhill driving on steep slopes, such as mountainous areas, when the system is active. In such situations, the system needs additional engine braking to reduce the load on the vehicle's regular brake system to prevent the brakes from overheating.

Cruise Control (If Equipped)

Switching Adaptive Cruise Control Off

ON OFF Press and release the button when the system is in standby mode, or switch the ignition off.

Note: You erase the set speed and gap setting when you switch the system off.

Detection Issues



WARNING: On rare occasions, detection issues can occur due to the road infrastructures, for example bridges, tunnels and safety barriers. In these cases, the system may brake late or unexpectedly. At all times, you are responsible for controlling your vehicle, supervising the system and intervening, if required.



WARNING: If the system malfunctions, have your vehicle checked as soon as possible.

The radar sensor has a limited field of view. It may not detect vehicles at all or detect a vehicle later than expected in some situations. The lead vehicle graphic does not illuminate if the system does not detect a vehicle in front of you.

A

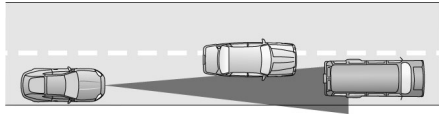

B

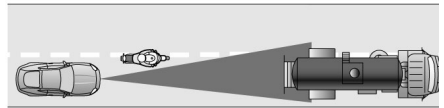

C

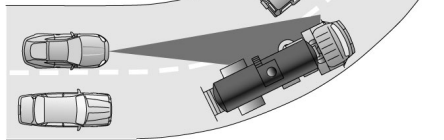

Detection issues can occur:

- A When driving on a different line than the vehicle in front.
- B With vehicles that edge into your lane. The system can only detect these vehicles once they move fully into your lane.
- C There may be issues with the detection of vehicles in front when driving into and coming out of a bend or curve in the road.

In these cases, the system may brake late or unexpectedly. You should stay alert and take action when necessary.

If something hits the front end of your vehicle or damage occurs, the radar-sensing zone may change. This could cause missed or false vehicle detection.

Cruise Control (If Equipped)

Optimal system performance requires a clear view of the road by the windshield-mounted camera.

Optimal performance may not occur if:

- The camera is blocked.
- There is poor visibility or lighting conditions.
- There are bad weather conditions.

System Not Available

Conditions that can cause the system to deactivate or prevent the system from activating when requested include:

- A blocked sensor.
- High brake temperature.
- A failure in the system or a related system.

Blocked Sensor

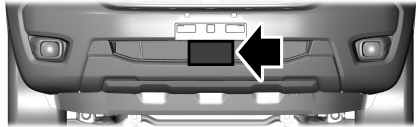
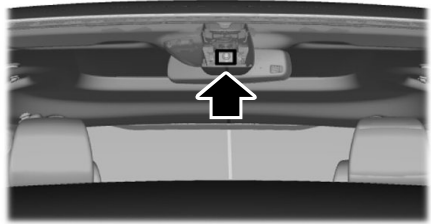

E271779

A message displays if something obstructs the radar signals from the sensor. The sensor is in the lower grille. The system cannot detect a vehicle ahead and does not function when something blocks the sensor.

Note: *You cannot see the sensor. It is behind a fascia panel.*

Keep the front of your vehicle free of dirt, metal badges or objects. Vehicle front protectors and aftermarket lights may also block the sensor.

Cruise Control (If Equipped)

Possible Causes and Actions for This Message Displaying:

Cause	Action
The surface of the radar is dirty or obstructed.	Clean the grille surface in front of the radar or remove the object causing the obstruction.
The surface of the radar is clean but the message remains in the display.	Wait a short time. It may take several minutes for the radar to detect that it is free from obstruction.
Heavy rain or snow is interfering with the radar signals.	Do not use the system in these conditions because it may not detect any vehicles ahead.
Water, snow or ice on the surface of the road may interfere with the radar signals.	Do not use the system in these conditions because it may not detect any vehicles ahead.
You are in a desert or remote area with no other vehicles and no roadside objects.	Wait a short time or switch to normal cruise control.

Due to the nature of radar technology, it is possible to get a blockage warning with no actual block. A false blocked condition either self clears, or clears after you restart your vehicle.

Switching to Normal Cruise Control



WARNING: Normal cruise control will not brake when your vehicle is approaching slower vehicles. Always be aware of which mode you have selected and apply the brakes when necessary.



The cruise control indicator light replaces the adaptive cruise control indicator light if you select normal cruise control. The gap setting does not display, and the system does not respond to lead vehicles. Automatic braking remains active to maintain set speed.

You can change from adaptive cruise control to normal cruise control through the information display. See **General Information** (page 96).

Note: *The system remembers the last setting when you start your vehicle.*

Driving Aids

DRIVER ALERT (IF EQUIPPED)

PRINCIPLE OF OPERATION



WARNING: You are responsible for controlling your vehicle at all times. The system is designed to be an aid and does not relieve you of your responsibility to drive with due care and attention. Failure to follow this instruction could result in the loss of control of your vehicle, personal injury or death.



WARNING: The system may not function if the sensor is blocked.



WARNING: Take regular rest breaks if you feel tired. Do not wait for the system to warn you.



WARNING: Certain driving styles may result in the system warning you even if you are not feeling tired.



WARNING: In cold and severe weather conditions the system may not function. Rain, snow and spray can all limit sensor performance.



WARNING: The system will not operate if the sensor cannot track the road lane markings.



WARNING: If damage occurs in the immediate area surrounding the sensor, have your vehicle checked as soon as possible.



WARNING: The system may not correctly operate if your vehicle is fitted with a suspension kit not approved by us.

Note: *The system may not operate correctly if you modify the ride height.*

Note: *Keep the windshield free from obstructions. For example, bird droppings, insects, snow or ice.*

Note: *If the camera is blocked or if the windshield is damaged, the system may not function.*

Note: *If enabled in the menu, the system activates at speeds above 40 mph (64 km/h). When below the activation speed, the information display informs the driver that the system is unavailable.*

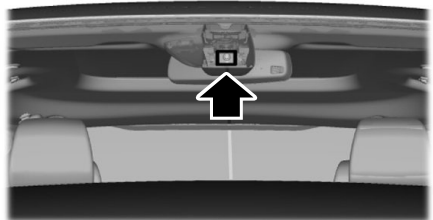

E249505

The system automatically monitors your driving behavior using various inputs including the front camera sensor.

If the system detects that your driving alertness is reduced below a certain threshold, the system alerts you using a chime and a message in the information display.

USING DRIVER ALERT

Switching the System On and Off

Switch the system on or off using the information display. See **General Information** (page 96).

When active, the system monitors your alertness level based upon your driving behavior in relation to the lane markings and other factors.

Driving Aids

System Warnings

Note: *The system does not issue warnings below approximately 40 mph (64 km/h).*

The warning system has two stages. First, the system issues a temporary warning that you need to take a rest. This message only appears for a short time. If the system detects further reduction in driving alertness, it may issue another warning that remains in the information display for a longer time. You can press OK on the steering wheel control to clear the warning.

System Display

When active, the system runs automatically in the background and only issues a warning if required. You can view the status at any time using the information display. See **General Information** (page 96).

The alertness level is shown by six steps in a colored bar.

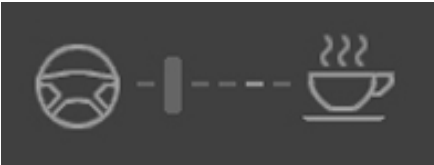

E131358

The current assessment of your alertness is within a typical range.

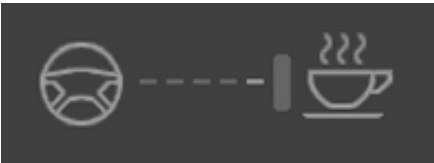

E131359

The current assessment of your alertness indicates that you should rest as safely possible.

The status bar travels from left to right as the calculated alertness level decreases. As the meter approaches the rest icon, the color turns from green to yellow to red.

The yellow position indicates the first warning is active and the red position indicates the second warning is active.

Note: *If you have recently received a warning, you should consider resting, even if the current assessment is within the typical range.*

Note: *If the camera sensor cannot track the road lane markings, or if your vehicle speed drops below approximately 40 mph (64 km/h), the alertness level changes to grey for a short time and the information display informs you that the system is unavailable.*

Resetting the System

You can reset the system by either:

- Switching the ignition off and on.
- Stopping the vehicle and then opening and closing the driver's door.

LANE KEEPING SYSTEM (IF

EQUIPPED)



WARNING: You are responsible for controlling your vehicle at all times. The system is designed to be an aid and does not relieve you of your responsibility to drive with due care and attention. Failure to follow this instruction could result in the loss of control of your vehicle, personal injury or death.



WARNING: Always drive with due care and attention when using and operating the controls and features on your vehicle.

Driving Aids

WARNING: In cold and severe weather conditions the system may not function. Rain, snow and spray can all limit sensor performance.

WARNING: The system will not operate if the sensor cannot track the road lane markings.

WARNING: The sensor may incorrectly track lane markings as other structures or objects. This can result in a false or missed warning.

WARNING: The system may not operate properly if the sensor is blocked. Keep the windshield free from obstruction.

WARNING: If damage occurs in the immediate area surrounding the sensor, have your vehicle checked as soon as possible.

WARNING: The system may not correctly operate if your vehicle is fitted with a suspension kit not approved by us.

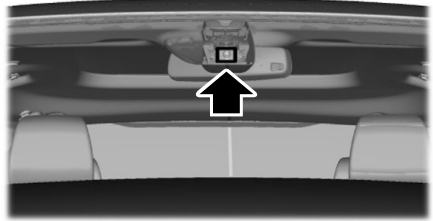

E249505

When you switch the system on and it detects an unintentional drift out of your lane is likely to occur, the system notifies or assists you to stay in your lane through the steering system and information display. In Alert mode, the system provides a warning by vibrating the steering wheel. In Aid mode, the system provides steering assistance by gently counter steering your vehicle back into the lane.

When the system is functioning in the combined Alert and Aid mode, the system first provides steering assistance by gently counter steering your vehicle back into the lane, followed by a warning that vibrates the steering wheel if the vehicle is still out of the lane markings.

Switching the System On and Off

Note: The system on or off setting is stored until it is manually changed, unless a MyKey is detected. If the system detects a MyKey, it defaults to on and the mode sets to alert.



E132099

Note: The system works above 40 mph (64 km/h).

Note: The system works as long as the camera can detect one lane marking.

Note: When you select aid or alert and aid mode and the system detects no steering activity for a short period, the system alerts you to put your hands on the steering wheel. **The system may detect a light grip or touch on the steering wheel as hands off driving.**

Note: The system may not function with a blocked camera, or if the windshield is damaged or dirty.

Driving Aids

Press the button on the direction indicator stalk to switch the system on or off.

System Settings

The system has optional setting menus available. The system stores the last known selection for each of these settings. You do not need to readjust your settings each time you switch the system on.

Mode: This setting allows you to select which of the system features you can enable.

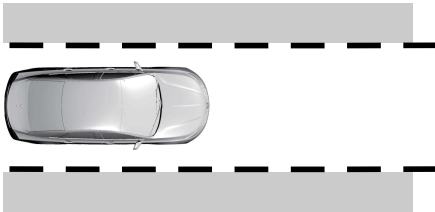

Alert only – Provides a steering wheel vibration when the system detects an unintended lane departure.

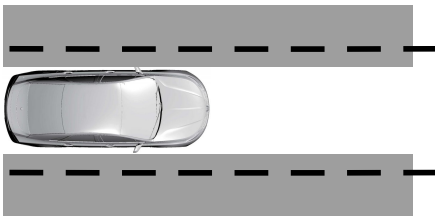

Aid only – Provides steering assistance toward the lane center when the system detects an unintended lane departure.

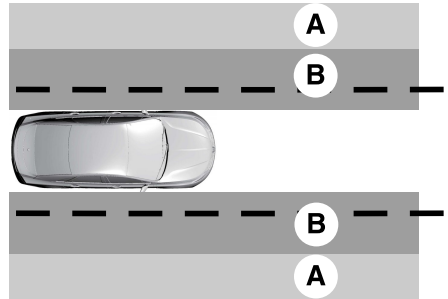

A Alert

B Aid

Alert + Aid – Provides steering assistance toward the lane center.

If your vehicle continues drifting out of the lane after the lane keeping aid corrects the vehicle, the system provides a steering wheel vibration.

Note: *The alert and aid diagrams illustrate general zone coverage. They do not provide exact zone parameters.*

Intensity: This setting affects the intensity of the steering wheel vibration used for the alert and alert + aid modes. **This setting does not affect the aid mode.**

- Low.
- Normal.
- High.

Driving Aids

System Display



E151660

If you switch the system on in alert mode, an overhead graphic of a vehicle with lane markings appears in the information display.

If you switch the system on in aid or alert and aid mode, a separate white icon also appears, or in some vehicles arrows display with the lane markings.

When you switch off the system, the lane marking graphics do not display.

While the system is on, the color of the lane markings change to indicate the system status.

Grey: Indicates that the system is temporarily unable to provide a warning or intervention on the indicated side. This may be because:

- Your vehicle is under the activation speed.
- Your vehicle is in a dynamic maneuver.
- The road has no or poor lane markings in the camera field-of-view.
- The camera is obscured or unable to detect the lane markings due to environmental, traffic or vehicle conditions. For example, significant sun angles, shadows, snow, heavy rain or fog, following a large vehicle that is blocking or shadowing the lane or poor headlamp illumination.

See **Troubleshooting** for additional information.

Green: Indicates that the system is available or ready to provide a warning or intervention on the indicated side.

Yellow: Indicates that the system is providing or has just provided a lane keeping aid intervention.

Red: Indicates that the system is providing or has just provided a lane keeping alert warning.

The system can be temporarily suppressed at any time by the following:

- Quick braking.
- Fast acceleration.
- Using the direction indicator.
- Evasive steering maneuver.
- Driving too close to the lane markings.

Troubleshooting

Why is the feature not available when I can see the lane markings on the road?
Your vehicle speed is outside the operational range of the feature.
The sun is shining directly into the camera lens.
A quick intentional lane change has occurred.
Your vehicle stays too close to the lane markings.

Driving Aids

Why is the feature not available when I can see the lane markings on the road?

Driving at high speeds in curves.

The last alert warning or aid intervention occurred a short time ago.

Ambiguous lane markings, for example in construction zones.

Rapid transition from light to dark, or from dark to light.

Sudden offset in lane markings.

ABS or AdvanceTrac™ is active.

There is a camera blockage due to dirt, grime, fog, frost or water on the windshield.

You are driving too close to the vehicle in front of you.

Transitioning between no lane markings to lane markings or vice versa.

There is standing water on the road.

Faint lane markings, for example partial yellow lane markings on concrete roads.

Lane width is too narrow or too wide.

The camera has not been calibrated after a windshield replacement.

Driving on tight roads or on uneven roads.

Why does the vehicle not come back toward the middle of the lane, as expected, in the Aid or Alert and Aid mode?

High cross winds are present.

There is a large road crown.

Rough roads, grooves or shoulder drop-offs.

Heavy uneven loading of the vehicle or improper tire inflation pressure.

The tires have been changed, or the suspension has been modified.

Driving Aids

BLIND SPOT INFORMATION SYSTEM (IF EQUIPPED)



WARNING: Do not use the blind spot information system as a replacement for using the interior and exterior mirrors or looking over your shoulder before changing lanes. The blind spot information system is not a replacement for careful driving.



WARNING: The system may not operate properly during severe weather conditions, for example snow, ice, heavy rain and spray. Always drive with due care and attention. Failure to take care may result in a crash.

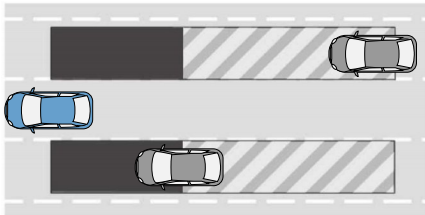

The system is designed to detect vehicles that may have entered the blind spot zone. The detection area is on both sides of your vehicle, approximately extending rearward from the exterior mirrors to 13 ft (4 m) beyond the rear bumper. The detection area approximately extends to 59 ft (18 m) beyond the rear bumper when the vehicle speed is greater than 30 mph (48 km/h) to alert you of faster approaching vehicles.

Note: The system does not prevent contact with other vehicles. It is not designed to detect parked vehicles, pedestrians, animals or other infrastructures.

Using the Blind Spot Information System

Vehicles with Automatic Transmission

The system turns on when all of the following occur:

- You start your vehicle.
- You shift into drive (D).
- The vehicle speed is greater than 6 mph (10 km/h).

Note: The system does not operate in park (P) or reverse (R).

System Lights and Messages



When the system detects a vehicle, an alert indicator illuminates in the exterior mirror on the side the approaching vehicle is coming from. If you turn the direction indicator on for that side of your vehicle, the alert indicator flashes.

Note: The system may not alert you if a vehicle quickly passes through the detection zone.

Driving Aids

Blocked Sensors

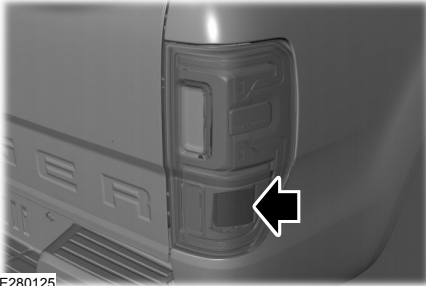

The sensors are inside the tail lamp on both sides of your vehicle.

If the sensors become blocked, a message may appear in the information display. See **Information Messages** (page 104). The alert indicators remain illuminated but the system does not alert you.

Note: Keep the sensors free from snow, ice and large accumulations of dirt.

Note: Do not cover the sensors with bumper stickers, repair compound or other objects.

Note: Blocked sensors could affect system performance.

Note: Bike and cargo racks could cause false alerts due to obstruction of the sensor. We recommend switching the feature off when using a bike or cargo rack.

Blind Spot Information System with Trailer Tow (If Equipped)

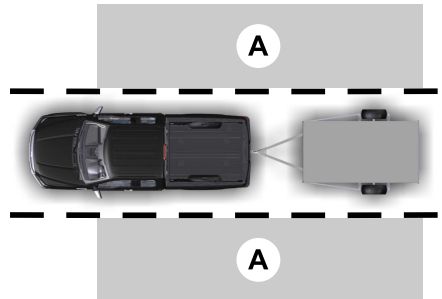

The blind spot information system with trailer tow is designed to aid you in detecting vehicles that may have entered the detection area zone (A). The detection area is on both sides of your vehicle and trailer, extending rearward from the exterior mirrors to the end of your trailer. When you attach a trailer and have set up a blind spot trailer, the blind spot information system with trailer tow becomes active when driving forward above 6 mph (10 km/h).

You can switch the system off in the information display. See **General Information** (page 96). If you switch the blind spot information system off, blind spot information system with trailer tow automatically turns off.

Driving Aids

Setting up a Blind Spot Trailer

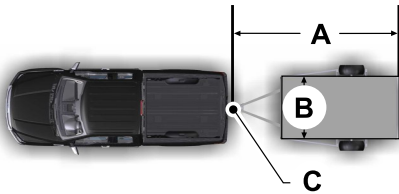

- A Trailer length
- B Trailer width
- C Trailer hitch ball

You can set-up a trailer to work with the system through the information display. See **General Information** (page 96). When setting up a trailer, a sequence of screens appear asking for trailer information.

- Select Trailer Screen: Trailer A, Trailer B or Trailer C.

Select one of the trailers and press OK.

The menu goes to the next screen.

- Is the width less than 8.2 ft (2.5 m) and length less than 33 ft (10 m)?

If no, the system turns off.

If yes, the menu goes to the next screen.

- Trailer width measurement:

The width of the trailer is measured at the front of the trailer. It is not measured at the widest point of the trailer. The maximum width at the front of the trailer that the system can support is 8.2 ft (2.5 m).

Note: You do not need to enter an exact trailer width measurement. You only need to confirm that the width of the trailer is 8.2 ft (2.5 m) or less.

- Trailer length measurement:

The trailer length is the distance between the trailer hitch ball and the rear of the trailer. The maximum length that the system can support is 33 ft (10 m).

- Enter length of trailer:

Toggle up or down using the menu buttons increases or decreases the measurement by 3 ft (1 m). Select a length that is equal to or within 3 ft (1 m) of the actual measured length. For example, if the actual measured length is 25 ft (7.6 m), toggle the length in the menu to 27 ft (8.2 m). When you enter the length of the trailer, the system setup is saved.

Note: When you connect a trailer and do not set up a Blind Spot Trailer, the system turns off and a warning appears in the instrument display.

Note: If the trailer is actually a bike rack or cargo rack with electrical lighting, enter a length of 3 ft (1 m). Cross Traffic Alert remains on for trailers with a length of 3 ft (1 m) or less.

Note: Proper measurement and measurement entry is required for the system to function as designed.

System Operation

If you select a trailer in the information display prior to connecting a trailer, the system loads that configuration and the information display shows a message when you connect the trailer. A second message appears stating cross traffic alert is off. The blind spot information system with trailer tow still normally functions when driving forward.

If you connect a trailer prior to selecting a trailer in the information display, a message appears asking you to select a trailer from the list of trailers or to add a trailer. In order for the blind spot information system with trailer tow to function, you must select an existing trailer

Driving Aids

or add a new trailer. If you ignore the request or if you exit the screen, a message appears stating the system has turned off due to a trailer connect. This message may not appear until your vehicle speed reaches 22 mph (35 km/h).

The blind spot information system with trailer tow activates when driving forward for that particular trailer set up. If you cycle the ignition, the blind spot information system with trailer tow continues to function using the last trailer you select.

Trailer Considerations

The system is designed to work with a trailer with a front width of 8.2 ft (2.5 m) or less, and a total length from the trailer hitch ball to the rear of the trailer of 33 ft (10 m) or less.

Some trailers may cause a slight change in system performance:

- Large box trailers may cause false alerts to occur when driving next to infrastructures or near parked cars. A false alert may also occur while making a 90-degree turn.
- Trailers that have a width greater than 8.2 ft (2.5 m) at the front and have a total length greater than 20 ft (6 m) may cause delayed alerts when a vehicle is passing at high speed.
- Box trailers that have a width greater than 8.2 ft (2.5 m) at the front may cause early alerts when you pass a vehicle.
- Clam shell or V-Nose box trailers with a width greater than 8.2 ft (2.5 m) at the front may cause delayed alerts when a vehicle traveling the same speed as your vehicle merges lanes.

System Errors

If the system detects a fault, a warning lamp illuminates and a message displays. See **Information Messages** (page 104).

Switching the System On and Off

You can switch the system off using the information display. See **General Information** (page 96). When you switch the system off, you do not receive alerts and the information display shows a system off message. The warning indicator in the cluster also illuminates. When you switch the system on or off, the alert indicators flash twice.

Note: *The system remembers the last setting when you start your vehicle.*

To permanently switch the system off, contact an authorized dealer.

CROSS TRAFFIC ALERT (IF EQUIPPED)



WARNING: Do not use the cross traffic alert system as a replacement for using the interior and exterior mirrors or looking over your shoulder before reversing out of a parking space. The cross traffic alert system is not a replacement for careful driving.



WARNING: The system may not operate properly during severe weather conditions, for example snow, ice, heavy rain and spray. Always drive with due care and attention. Failure to take care may result in a crash.

The system alerts you of vehicles approaching from the sides behind your vehicle when you shift into reverse (R).

Driving Aids

Using Cross Traffic Alert

The system detects vehicles that approach at a speed between 4 mph (6 km/h) and 37 mph (60 km/h). Coverage decreases when the sensors are partially, mostly or fully obstructed. Slowly reversing helps

increase the coverage area and effectiveness.

The system turns on when you start the engine and you shift into reverse (R). The system turns off when you shift out of reverse (R).

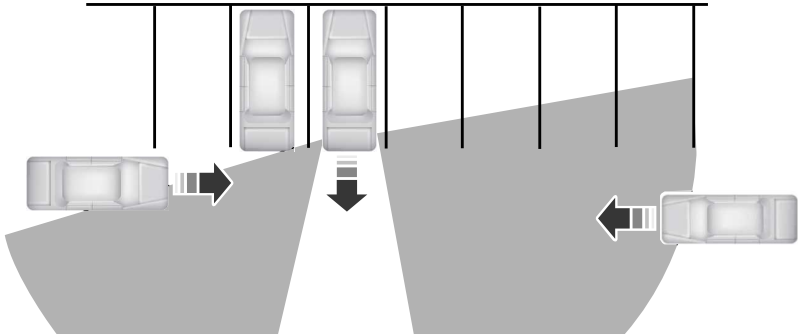

The sensor on the left-hand side is only partially obstructed and zone coverage on the right-hand side is maximized.

Driving Aids

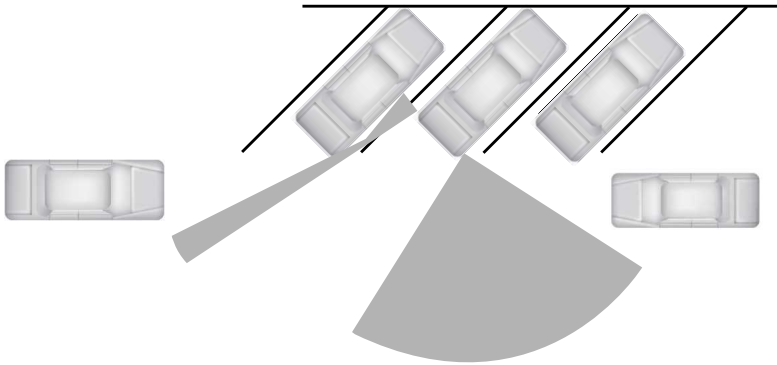

Zone coverage also decreases when parking at narrow angles. The sensor on the left-hand side is mostly obstructed and zone coverage on that side is severely reduced.

Cross Traffic Alert System Sensors

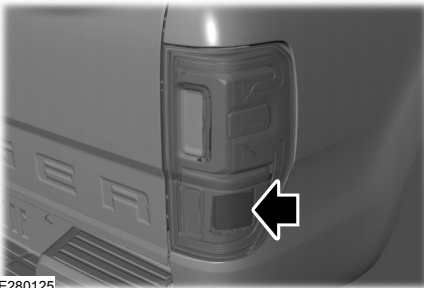

The sensors are inside the tail lamp on both sides of your vehicle.

Note: Keep the sensors free from snow, ice and large accumulations of dirt.

Note: Do not cover the sensors with bumper stickers, repair compound or other objects.

Note: Blocked sensors could affect system performance.

If the sensors are blocked, a message may appear in the information display when you shift into reverse (R).

Cross Traffic Alert System Limitations

The system may not correctly operate when any of the following occur:

- The sensors are blocked.
- Adjacently parked vehicles or objects are obstructing the sensors.
- Vehicles approach at speeds less than 4 mph (6 km/h) or greater than 37 mph (60 km/h).
- The vehicle speed is greater than 7 mph (12 km/h).
- You reverse out of an angled parking space.

Driving Aids

Cross Traffic Alert Behavior When Trailer is Attached

Note: *The system may not correctly operate when towing a trailer. For vehicles with an approved trailer tow module and tow bar, the system turns off when you attach a trailer. For vehicles with an aftermarket trailer tow module or tow bar, we recommend that you switch the system off when you attach a trailer.*

Cross traffic alert remains on when you attach a trailer in vehicles that come with blind spot information system with trailer tow under the following conditions:

- You connect a trailer.
- The trailer is a bike rack or cargo rack with a maximum length of 3 ft (1 m).
- You set the trailer length to 3 ft (1 m) in the information display.

See **Blind Spot Information System** (page 206).

Switching the System On and Off

To switch the system on or off, adjust the setting. Depending on your vehicle options, the setting could be in the following:

Cross Traffic Alert Information Messages

Message	Action
Cross Traffic Alert	Displays instead of indication arrows when the system detects a vehicle. Check for approaching traffic.
Cross Traffic Not Available Sensor Blocked See Manual	Indicates blocked cross traffic alert system sensors. Clean the sensors. If the message continues to appear, have your vehicle checked as soon as possible.
Cross Traffic System Fault	The system has malfunctioned. Have your vehicle checked as soon as possible.
Cross Traffic Alert Deactivated Trailer Attached	Displays if you attach a trailer to your vehicle.

- Information display. See **General Information** (page 96).
- Touchscreen. See **Settings** (page 393).

Note: *The system turns on every time you switch the ignition on. To permanently switch the system off, contact an authorized dealer.*

Cross Traffic Alert Indicator



When the system detects an approaching vehicle, a tone sounds, a warning lamp illuminates in the relevant exterior mirror and arrows appear in the information display to show which side the approaching vehicle is coming from.

Note: *If arrows do not display, a message appears in the information display.*

If the system malfunctions, a warning lamp illuminates in the instrument cluster and a message appears in the information display. Have your vehicle checked as soon as possible.

Note: *In exceptional conditions, the system could alert you, even when there is nothing in the detection zone, for example a vehicle passing further away from your vehicle.*

Driving Aids

STEERING

Electric Power Steering



WARNING: The electric power steering system has diagnostic checks that continuously monitor the system. If a fault is detected, a message displays in the information display. Stop your vehicle as soon as it is safe to do so. Switch the ignition off. After at least 10 seconds, switch the ignition on and watch the information display for a steering system warning message. If a steering system warning message returns, have the system checked as soon as possible.



WARNING: If the system detects an error, you may not feel a difference in the steering, however a serious condition may exist. Have your vehicle checked as soon as possible. Failure to do so may result in loss of steering control.

If your vehicle loses electrical power while you are driving (or if the ignition is turned off), you can steer the vehicle manually, but it takes more effort. You must adapt your speed and driving behavior to reduced steering assist. Extreme continuous steering may increase the effort it takes for you to steer. This occurs to prevent internal overheating and permanent damage to your steering system. If this should occur, you will neither lose the ability to steer the vehicle manually nor will it cause permanent damage. Typical steering and driving maneuvers will allow the system to cool down and steering assist will return to normal.

Steering Tips

If the steering wanders or pulls, check for:

- An improperly inflated tire.
- Uneven tire wear.
- Loose or worn suspension components.
- Loose or worn steering components.
- Improper vehicle alignment.

A high crown in the road or high crosswinds may also make the steering seem to wander or pull.

PRE-COLLISION ASSIST (IF EQUIPPED)



WARNING: You are responsible for controlling your vehicle at all times. The system is designed to be an aid and does not relieve you of your responsibility to drive with due care and attention. Failure to follow this instruction could result in the loss of control of your vehicle, personal injury or death.





WARNING: The system does not detect vehicles that are driving in a different direction, pedestrians, cyclists or animals. Apply the brakes when necessary. Failure to follow this instruction could result in the loss of control of your vehicle, personal injury or death.



WARNING: The system does not operate during hard acceleration or steering. Failure to take care may lead to a crash or personal injury.

Driving Aids

 **WARNING:** The system may fail or operate with reduced function during cold and severe weather conditions. Snow, ice, rain, spray and fog can adversely affect the system. Keep the front camera and radar free of snow and ice. Failure to take care may result in the loss of control of your vehicle, serious personal injury or death.

 **WARNING:** Some situations and objects prevent hazard detection. For example low or direct sunlight, inclement weather, unconventional vehicle types, and pedestrians. Apply the brakes when necessary. Failure to follow this instruction could result in the loss of control of your vehicle, personal injury or death.

 **WARNING:** The system cannot help prevent all crashes. Do not rely on this system to replace driver judgment and the need to maintain a safe distance and speed.

Note: To achieve full system performance, you must break in the braking system. See **General Information** (page 175).

Note: The warning indicator may flash for a short period of time when you start your vehicle.

Using the Pre-Collision Assist System

The Pre-Collision Assist system is active at speeds above approximately 3 mph (5 km/h) and pedestrian detection is active at speeds up to 50 mph (80 km/h).



If your vehicle is rapidly approaching another stationary vehicle, a vehicle traveling in the same direction as yours, or a pedestrian within your driving path the system provides three levels of functionality:

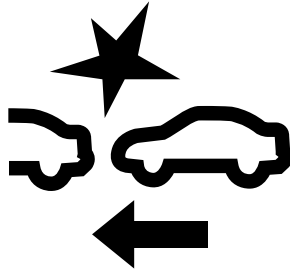

1. Alert
2. Brake Support
3. Active Braking

Alert: When active, the system provides a flashing visual warning and an audible warning sound.

Brake Support: Assists the driver in reducing collision speed by preparing the brake system for rapid braking. Brake support does not automatically activate the brakes, but if the driver presses the brake pedal even lightly, brake support could add additional braking up to full force.

Active Braking: Active braking may activate if the system determines that a collision is imminent. The system may help the driver reduce impact damage or avoid the crash completely.

Note: If you perceive Pre-Collision Assist alerts as being too frequent or disturbing, then you can reduce the alert sensitivity, though the manufacturer recommends using the highest sensitivity setting where possible. Setting lower sensitivity would lead to fewer and later system warnings.

Driving Aids

Distance Indication and Alert

This function provides a graphical indication of the time gap to other preceding vehicles traveling in the same direction. The distance indication and alert screen in the information display shows a graphic similar to the one that follows.

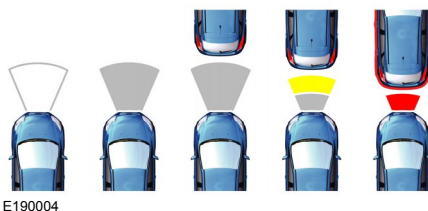

E190004

If the time gap to a preceding vehicle is small, a red visual indication displays to the driver.

Note: *Distance indication and alert deactivates and the graphics do not display when adaptive cruise control is active.*

Speed	Sensitivity	Graphics	Distance Gap	Time Gap
62 mph (100 km/h)	Normal	Grey	>82 ft (25 m)	>0.9sec
62 mph (100 km/h)	Normal	Yellow	56–82 ft (17–25 m)	0.6sec – 0.9sec
62 mph (100 km/h)	Normal	Red	<56 ft (17 m)	<0.6sec

Adjusting Pre-Collision Assist Settings

You can adjust alert and distance alert sensitivity to one of three possible settings by using the information display control. See **General Information** (page 96).

You can switch the distance alert and indication function off using the information display controls. See **General Information** (page 96).

If required, you can switch active braking off using the information display controls. See **General Information** (page 96).

Note: *We recommend that you turn the Pre-Collision Assist system off if you install a snow plow or similar object in such a way that it may block the radar sensor. Your vehicle remembers the last selected setting when you switch it off and then back on.*

Driving Aids

Blocked Sensors

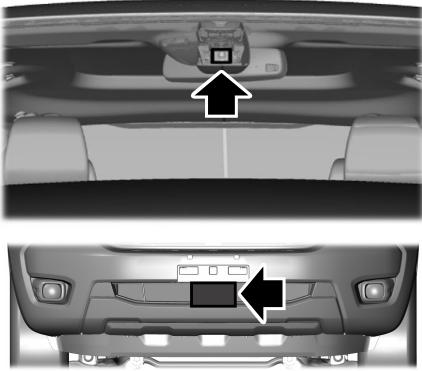

If a message regarding a blocked sensor or camera appears in the information display, the radar signals or camera images are obstructed. The radar sensor is located behind a fascia cover near the driver side of the lower grille. With an obstructed radar, the Pre-Collision Assist system does not function and cannot detect a vehicle ahead. With the front camera obstructed, the Pre-Collision Assist system does not respond to pedestrians or stationary vehicles and the system performance on moving vehicles reduces. The following table lists possible causes and actions for when this message displays.

E271779

Cause	Action
The surface of the radar in the grille is dirty or obstructed in some way.	Clean the grille surface in front of the radar or remove the object causing the obstruction.
The surface of the radar in the grille is clean but the message remains in the display.	Wait a short time. It may take several minutes for the radar to detect that there is no obstruction.
Heavy rain, spray, snow, or fog is interfering with the radar signals.	The Pre-Collision Assist system is temporarily disabled. Pre-Collision Assist should automatically reactivate a short time after the weather conditions improve.
Swirling water, or snow or ice on the surface of the road may interfere with the radar signals.	The Pre-Collision Assist system is temporarily disabled. Pre-Collision Assist should automatically reactivate a short time after the weather conditions improve.

Driving Aids

Cause	Action
Radar is out of alignment due to a front end impact.	Contact an authorized dealer to have the radar checked for proper coverage and operation.
The windshield in front of the camera is dirty or obstructed in some way.	Clean the outside of the windshield in front of the camera.
The windshield in front of the camera is clean but the message remains in the display.	Wait a short time. It may take several minutes for the camera to detect that there is no obstruction.

Note: *Proper system operation requires a clear view of the road by the camera. Have any windshield damage in the area of the camera's field of view repaired.*

Note: *If something hits the front end of your vehicle or damage occurs, the radar sensing zone may change. This could cause missed or false vehicle detections. Contact an authorized dealer to have the radar checked for proper coverage and operation.*

Note: *If your vehicle detects excessive heat at the camera or a potential misalignment condition, a message may display in the information display indicating temporary sensor unavailability. When operational conditions are correct, the message deactivates. For example, when the ambient temperature around the sensor decreases or the sensor automatically recalibrates successfully.*

Load Carrying

LOAD LIMIT

Vehicle Loading - with and without a Trailer

This section guides you in the proper loading of your vehicle, trailer, or both. Keep your loaded vehicle weight within its design rating capability, with or without a trailer. Properly loading your vehicle provides maximum return of vehicle design performance. Before you load your vehicle, become familiar with the following terms for determining your vehicle's weight rating, with or without a trailer, from the vehicle's Tire and Loading Information label or Safety Compliance Certification label.

Tire and Loading Label Information Example:



TIRE AND LOADING INFORMATION

SEATING CAPACITY TOTAL: 5 FRONT: 2 REAR: 3

The combined weight of occupants and cargo should never exceed: 385 kg or 850 lbs.

TIRE	SIZE	COLD TIRE PRESSURE
FRONT	235/45R18 94V	235 KPA, 34 PSI
REAR	235/45R18 94V	235 KPA, 34 PSI
SPARE	NONE	NONE

SEE OWNER'S
MANUAL FOR
ADDITIONAL
INFORMATION



TIRE AND LOADING INFORMATION RENSEIGNEMENTS SUR LES PNEUS ET LE CHARGEMENT

SEATING CAPACITY / NOMBRE DE PLACES TOTAL 5 FRONT AVANT 2 REAR ARRIERE 3

The combined weight of occupants and cargo should never exceed 396 kg or 875 lbs.
Le poids total des occupants et du chargement ne doit jamais dépasser 396 kg ou 875 lbs.

TIRE / PNEU	SIZE / DIMENSIONS	COLD TIRE PRESSURE / PRESSION DES PNEUS A FROID
FRONT AVANT	235/40R19 96V	255 KPA, 37 PSI
REAR ARRIERE	235/40R19 96V	255 KPA, 37 PSI
SPARE / SECOURS	T125/80R16 97M	415 KPA, 60 PSI

SEE OWNER'S
MANUAL FOR
ADDITIONAL
INFORMATION
VOIR LE MANUEL
DE L'USAGER
POUR PLUS DE
RENSEIGNEMENTS

Payload

Payload is the combined weight of cargo and passengers that your vehicle is carrying. The maximum payload for your vehicle appears on the Tire and Loading label. The label is either on the B-pillar or the edge of the driver door. Vehicles exported outside the US and Canada may not have a tire and loading label. Look for "The combined weight of occupants and cargo should never exceed XXX kg OR XXX lb" for maximum payload. The payload listed on the Tire and Loading Information label

Load Carrying

is the maximum payload for your vehicle as built by the assembly plant. If you install any additional equipment on your vehicle, you must determine the new payload. Subtract the weight of the equipment from the payload listed on the Tire and Loading label. When towing, trailer tongue weight or king pin weight is also part of payload.



WARNING: The appropriate loading capacity of your vehicle can be limited either by volume capacity (how much space is available) or by payload capacity (how much weight the vehicle should carry). Once you have reached the maximum payload of your vehicle, do not add more cargo, even if there is space available. Overloading or improperly loading your vehicle can contribute to loss of vehicle control and vehicle rollover.

GAWR (Gross Axle Weight Rating)

GAWR is the maximum allowable weight that a single axle (front or rear) can carry. These numbers are on the Safety Compliance Certification label. The label is located on the door hinge pillar, door-latch post, or the door edge that meets the door-latch post, next to the driver seating position.



The total load on each axle must never exceed its Gross Axle Weight Rating.

GVWR (Gross Vehicle Weight Rating)

GVWR is the maximum allowable weight of the fully loaded vehicle. This includes all options, equipment, passengers and cargo. It appears on the Safety Compliance Certification label. The label is located on the door hinge pillar, door-latch post, or the door edge that meets the door-latch post, next to the driver seating position.

The gross vehicle weight must never exceed the Gross Vehicle Weight Rating.

Safety Compliance Certification Label Example:

<p style="text-align: center;">MFD. BY FORD MOTOR CO.</p> <table style="width: 100%; border-collapse: collapse;"> <tr> <td>DATE: XXXXX</td> <td>GAWR: XXXXKG (XXXXLBS)</td> </tr> <tr> <td>FRONT GAWR: XXXXKG (XXXXLBS)</td> <td>REAR GAWR: XXXXKG (XXXXLBS)</td> </tr> <tr> <td>XXXKG (XXXXLBS)</td> <td>WITH XXXXKG (XXXXLBS) TRES</td> </tr> <tr> <td>XXXXXXXXXXXXXXXXXX</td> <td>TRES XXXXKG (XXXXLBS)</td> </tr> <tr> <td>XXXXXXXXXX</td> <td>RMS XXXXKG (XXXXLBS)</td> </tr> <tr> <td>AT XXXX kPa/ XXX PSI(COLD) AT XXXX kPa/ XXX PSI(COLD)</td> <td></td> </tr> </table> <p><small>THIS VEHICLE CONFORMS TO ALL APPLICABLE FEDERAL MOTOR VEHICLE SAFETY AND TIRES PROVISION STANDARDS IN EFFECT ON THE DATE OF MANUFACTURE SHOWN ABOVE.</small></p> <p>VIN: XXXXXXXXXXXXXXXXXXXXX</p> <p>TYPE: XXXX</p>  <p>EXP: 08 2022 000000 FC: 00 0000 0000 00 1000 10000 10 1000 1000 1000 XXX XX X XX X XXX XXXX XXXX XXXX XXXX XXXX XXXX XXXX XXXX</p>	DATE: XXXXX	GAWR: XXXXKG (XXXXLBS)	FRONT GAWR: XXXXKG (XXXXLBS)	REAR GAWR: XXXXKG (XXXXLBS)	XXXKG (XXXXLBS)	WITH XXXXKG (XXXXLBS) TRES	XXXXXXXXXXXXXXXXXX	TRES XXXXKG (XXXXLBS)	XXXXXXXXXX	RMS XXXXKG (XXXXLBS)	AT XXXX kPa/ XXX PSI(COLD) AT XXXX kPa/ XXX PSI(COLD)		<p style="text-align: center;">MFD. BY FORD MOTOR CO.</p> <table style="width: 100%; border-collapse: collapse;"> <tr> <td>DATE: XXXXX</td> <td>GVWR: XXXXKG (XXXXLBS)</td> </tr> <tr> <td colspan="2" style="text-align: center;">FRONT GAWR/PBBE AX / REAR GAWR/PBBE AX</td> </tr> <tr> <td colspan="2" style="text-align: center;">XXXX (XXXX) / XXXX (XXXX)</td> </tr> <tr> <td colspan="2" style="text-align: center;">XXXX (XXXX) / XXXX (XXXX)</td> </tr> <tr> <td colspan="2" style="text-align: center;">XXXX (XXXX) / XXXX (XXXX)</td> </tr> <tr> <td colspan="2" style="text-align: center;">XXXX (XXXX) / XXXX (XXXX)</td> </tr> <tr> <td colspan="2" style="text-align: center;">XXXX (XXXX) / XXXX (XXXX)</td> </tr> <tr> <td colspan="2" style="text-align: center;">XXXX (XXXX) / XXXX (XXXX)</td> </tr> </table> <p><small>THIS VEHICLE CONFORMS TO ALL APPLICABLE FEDERAL MOTOR VEHICLE SAFETY AND TIRES PROVISION STANDARDS IN EFFECT ON THE DATE OF MANUFACTURE SHOWN ABOVE.</small></p> <p>VIN: XXXXXXXXXXXXXXXXXXXXX</p> <p>TYPE: XXXX</p>  <p>EXP: 08 2022 000000 FC: 00 0000 0000 00 1000 10000 10 1000 1000 1000 XXX XX X XX X XXX XXXX XXXX XXXX XXXX XXXX XXXX XXXX XXXX</p>	DATE: XXXXX	GVWR: XXXXKG (XXXXLBS)	FRONT GAWR/PBBE AX / REAR GAWR/PBBE AX		XXXX (XXXX) / XXXX (XXXX)		XXXX (XXXX) / XXXX (XXXX)		XXXX (XXXX) / XXXX (XXXX)		XXXX (XXXX) / XXXX (XXXX)		XXXX (XXXX) / XXXX (XXXX)		XXXX (XXXX) / XXXX (XXXX)	
DATE: XXXXX	GAWR: XXXXKG (XXXXLBS)																												
FRONT GAWR: XXXXKG (XXXXLBS)	REAR GAWR: XXXXKG (XXXXLBS)																												
XXXKG (XXXXLBS)	WITH XXXXKG (XXXXLBS) TRES																												
XXXXXXXXXXXXXXXXXX	TRES XXXXKG (XXXXLBS)																												
XXXXXXXXXX	RMS XXXXKG (XXXXLBS)																												
AT XXXX kPa/ XXX PSI(COLD) AT XXXX kPa/ XXX PSI(COLD)																													
DATE: XXXXX	GVWR: XXXXKG (XXXXLBS)																												
FRONT GAWR/PBBE AX / REAR GAWR/PBBE AX																													
XXXX (XXXX) / XXXX (XXXX)																													
XXXX (XXXX) / XXXX (XXXX)																													
XXXX (XXXX) / XXXX (XXXX)																													
XXXX (XXXX) / XXXX (XXXX)																													
XXXX (XXXX) / XXXX (XXXX)																													
XXXX (XXXX) / XXXX (XXXX)																													

Load Carrying



WARNING: Exceeding the Safety Compliance Certification label vehicle weight limits can adversely affect the performance and handling of your vehicle, cause vehicle damage and can result in the loss of control of your vehicle, serious personal injury or death.

Maximum Loaded Trailer Weight

Maximum loaded trailer weight is the highest possible weight of a fully loaded trailer the vehicle can tow. Consult an authorized dealer (or the RV and Trailer Towing Guide available at an authorized dealer) for more detailed information.

GCWR (Gross Combined Weight Rating)

GCWR is the maximum allowable weight of the vehicle and the loaded trailer, including all cargo and passengers, that the vehicle can handle without risking damage. (Important: The towing vehicle's braking system is rated for operation at Gross Vehicle Weight Rating, not at Gross Combined Weight Rating.) Separate functional brakes should

be used for safe control of towed vehicles and for trailers where the Gross Combined Weight of the towing vehicle plus the trailer exceed the Gross Vehicle Weight Rating of the towing vehicle.

The gross combined weight must never exceed the Gross Combined Weight Rating.

Note: For trailer towing information refer to the *RV and Trailer Towing Guide* available at an authorized dealer.



WARNING: Do not exceed the GVWR or the GAWR specified on the certification label.



WARNING: Do not use replacement tires with lower load carrying capacities than the original tires because they may lower your vehicle's GVWR and GAWR limitations. Replacement tires with a higher limit than the original tires do not increase the GVWR and GAWR limitations.



WARNING: Exceeding any vehicle weight rating can adversely affect the performance and handling of your vehicle, cause vehicle damage and can result in the loss of control of your vehicle, serious personal injury or death.

Load Carrying

Steps for determining the correct load limit:

1. Locate the statement "The combined weight of occupants and cargo should never exceed XXX kg or XXX lb." on your vehicle's placard.
2. Determine the combined weight of the driver and passengers that will be riding in your vehicle.
3. Subtract the combined weight of the driver and passengers from XXX kg or XXX lb.
4. The resulting figure equals the available amount of cargo and luggage load capacity. For example, if the "XXX" amount equals 1,400 lb. and there will be five 150 lb. passengers in your vehicle, the amount of available cargo and luggage load capacity is 650 lb.
(1400 - (5 x 150) = 1400 - 750 = 650 lb.)
5. Determine the combined weight of luggage and cargo being loaded on the vehicle. That weight may not safely exceed the available cargo and luggage load capacity calculated in Step 4.
6. If your vehicle will be towing a trailer, load from your trailer will be transferred to your vehicle. Consult this manual to determine how this reduces the available cargo and luggage load capacity of your vehicle.

Helpful examples for calculating the available amount of cargo and luggage load capacity

Suppose your vehicle has a 1400-pound (635-kilogram) cargo and luggage capacity. You decide to go golfing. Is there enough load capacity to carry you, four of your friends and all the golf bags? You and four friends average 220 pounds (99 kilograms) each and the golf bags weigh approximately 30 pounds (13.5 kilograms) each. The calculation would be: $1400 - (5 \times 220) - (5 \times 30) = 1400 - 1100 - 150 = 150$ pounds. Yes, you have enough load capacity in your vehicle to transport four friends and your golf bags. In metric units, the calculation would be: $635 \text{ kilograms} - (5 \times 99 \text{ kilograms}) - (5 \times 13.5 \text{ kilograms}) = 635 - 495 - 67.5 = 72.5$ kilograms.

Suppose your vehicle has a 1400-pound (635-kilogram) cargo and luggage capacity. You and one of your friends decide to pick up cement from the local home improvement store to finish that patio you have been planning for the past two years. Measuring the inside of the vehicle with the rear seat folded down, you have room for twelve 100-pound (45-kilogram) bags of cement. Do you have enough load capacity to transport the cement to your home? If you and your friend each weigh 220 pounds (99 kilograms), the calculation would be: $1400 - (2 \times 220) - (12 \times 100) = 1400 - 440$

Load Carrying

- 1200 = - 240 pounds. No, you do not have enough cargo capacity to carry that much weight. In metric units, the calculation would be: 635 kilograms - (2 x 99 kilograms) - (12 x 45 kilograms) = 635 - 198 - 540 = -103 kilograms. You will need to reduce the load weight by at least 240 pounds (104 kilograms). If you remove three 100-pound (45-kilogram) cement bags, then the load calculation would be: 1400 - (2 x 220) - (9 x 100) = 1400 - 440 - 900 = 60 pounds. Now you have the load capacity to transport the cement and your friend home. In metric units, the calculation would be: 635 kilograms - (2 x 99 kilograms) - (9 x 45 kilograms) = 635 - 198 - 405 = 32 kilograms.

The above calculations also assume that the loads are positioned in your vehicle in a manner that does not overload the front or the rear gross axle weight rating specified for your vehicle on the Safety Compliance Certification label.

Special Loading Instructions for Owners of Pick-up Trucks and Utility-type Vehicles



WARNING: When loading the roof racks, we recommend you evenly distribute the load, as well as maintain a low center of gravity. Loaded vehicles, with higher centers of gravity, may

handle differently than unloaded vehicles. Take extra precautions, such as slower speeds and increased stopping distance, when driving a heavily loaded vehicle.

LOAD RETAINING FIXTURES (IF

EQUIPPED)

Tie Down Points



WARNING: Do not use the load retaining fixtures for towing. Failure to follow this instruction could result in personal injury.



WARNING: Do not exceed the maximum load rating of the load retaining fixtures. Failure to follow this instruction could result in personal injury.



WARNING: Check the load retaining fixtures for damage before using them. Failure to follow this instruction could result in personal injury.

Note: Use the load retaining fixtures to retain the loads within the loadspace. Using the load retaining fixtures for any other purpose may lead to vehicle damage.

Note: Exceeding the maximum load rating of the load retaining fixtures may lead to vehicle damage.

Note: The number of tie down points may vary depending on your vehicle model.

Load Carrying

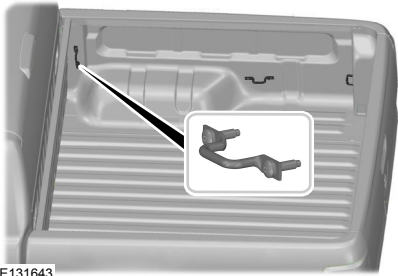

E131643

Load Rating of the Tie Down Points: 661 lb
(300 kg).

USING A SLIDE-IN CAMPER

We do not recommend using your pickup
for carrying a slide-in camper.

Towing

TOWING A TRAILER



WARNING: Do not exceed the GVWR or the GAWR specified on the certification label.



WARNING: Towing trailers beyond the maximum recommended gross trailer weight exceeds the limit of your vehicle and could result in engine damage, transmission damage, structural damage, loss of vehicle control, vehicle rollover and personal injury.



WARNING: Do not exceed the lowest rating capacity for your vehicle or trailer hitch. Overloading your vehicle or trailer hitch can impair your vehicle stability and handling. Failure to follow this instruction could result in the loss of control of your vehicle, personal injury or death.



WARNING: Do not cut, drill, weld or modify the trailer hitch. Modifying the trailer hitch could reduce the hitch rating.



WARNING: Make sure that the vertical load on the tow ball is between the minimum and maximum recommended weight at all times. Failure to follow this instruction could result in the loss of control of your vehicle, personal injury or death.



WARNING: Do not tow a trailer fitted with electric trailer brakes unless your vehicle is fitted with a compatible aftermarket electronic trailer brake controller. Failure to follow this instruction could result in the loss of control of your vehicle, personal injury or death. For additional information and assistance, we recommend that you contact an authorized dealer.

Note: *Your vehicle includes trailer stability control if it has an electronic stability program.*

When towing a trailer:

- Obey country specific regulations for towing a trailer.
- Place loads as low as possible and central to the axle of your trailer. For best stability of the trailer in an unloaded vehicle, place the load in the trailer towards the nose within the maximum nose load as this gives the best stability. See **Recommended Towing Weights** (page 225).

Towing

- Reduce the stipulated permitted gross combination mass by 3% for every additional 1,000 ft (300 m) in high altitude regions above 1,000 ft (300 m).
- Use a low gear when descending a steep downhill slope.
- Do not use four-wheel drive while towing for extended periods of time on dry surfaces. See **Using Four-Wheel Drive** (page 165).

The stability of your vehicle to trailer combination is dependent on the quality of the trailer.

TRAILER SWAY CONTROL (IF EQUIPPED)

 **WARNING:** Turning off trailer sway control increases the risk of loss of vehicle control, serious injury or death. Ford does not recommend disabling this feature except in situations where speed reduction may be detrimental (such as hill climbing), the driver has significant trailer towing experience, and can control trailer sway and maintain safe operation.

Note: *This feature does not prevent trailer sway, but reduces it once it begins.*

Note: *This feature cannot stop all trailers from swaying.*

Note: *In some cases, if vehicle speed is too high, the system may activate multiple times, gradually reducing vehicle speed.*

This feature applies your vehicle brakes at individual wheels and, if necessary, reduces engine power. If the trailer begins to sway, the stability control light flashes and the message **TRAILER SWAY REDUCE SPEED** appears in the information display. The first thing to do is slow your vehicle down, then pull safely to the side of the road and check for proper tongue load and trailer load distribution. See **Load Carrying** (page 218).

RECOMMENDED TOWING WEIGHTS

Market	Website
United States of America	https://www.fleet.ford.com/towing-guides/
Canada	https://www.fleet.ford.ca/towing-guides/

Towing

ESSENTIAL TOWING CHECKS

Follow these guidelines for safe towing:

- Do not tow a trailer until you drive your vehicle at least 1,000 mi (1,600 km).
- Consult your local motor vehicle laws for towing a trailer.
- See the instructions included with towing accessories for the proper installation and adjustment specifications.
- Service your vehicle more frequently if you tow a trailer. See your scheduled maintenance information. See **Scheduled Maintenance** (page 416).
- If you use a rental trailer, follow the instructions the rental agency gives you.

See **Load limits** in the Load Carrying chapter for load specification terms found on the tire label and Safety Compliance label and instructions on calculating your vehicle's load. See **Load Limit** (page 218).

Remember to account for the trailer tongue weight as part of your vehicle load when calculating the total vehicle weight.

Trailer Towing Connector

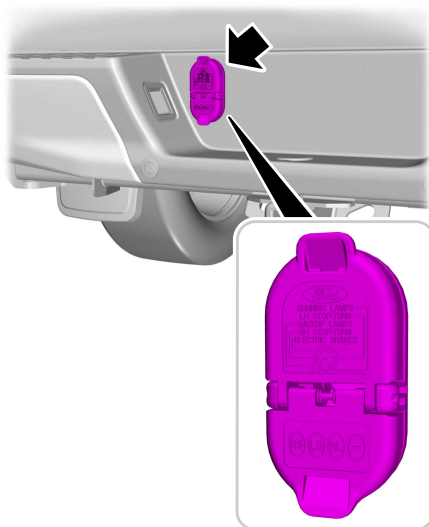

When attaching the trailer wiring connector to your vehicle, only use a proper fitting connector that works with the vehicle and trailer functions. Some seven-position connectors may have the SAE J2863 logo, which confirms that it is the proper wiring connector and works correctly with your vehicle.

Color	Function
Yellow	Left turn signal and stop lamp
White	Ground (-)
Blue	Electric brakes
Green	Right turn signal and stop lamp
Orange	Battery (+) ¹

Towing

Color	Function
Brown	Running lights
Grey	Reverse lights

¹Your vehicle must recognize the trailer before the trailer can receive power.

Safety Chains

Note: Do not attach safety chains to the bumper. Always connect the safety chains to the frame or hook retainers of your trailer hitch.

Install trailer safety chains to the trailer hitch as recommended by the manufacturer. Cross the chains under the trailer tongue and allow enough slack for turning tight corners. Do not allow the chains to drag on the ground.

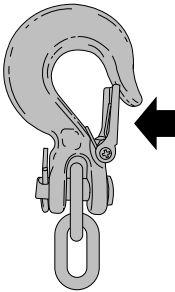

If the trailer safety chain hook has a latch, make sure the latch is fully closed.

Trailer Brakes



WARNING: Do not connect a trailer's hydraulic brake system directly to your vehicle's brake system. Your vehicle may not have enough braking power and your chances of having a collision greatly increase.

Electric brakes and manual, automatic or surge-type trailer brakes are safe if you install them properly and adjust them to the manufacturer's specifications. The trailer brakes must meet local and federal regulations.

The rating for the tow vehicle's braking system operation is at the gross vehicle weight rating, not the gross combined weight rating.

Separate functioning brake systems are required for safe control of towed vehicles and trailers weighing more than 1500 lb (680 kg) when loaded.

Trailer Lamps



WARNING: Never connect any trailer lamp wiring to the vehicle's tail lamp wiring; this may damage the electrical system resulting in fire. Contact your authorized dealer as soon as possible for assistance in proper trailer tow wiring installation. Additional electrical equipment may be required.

Trailer lamps are required on most towed vehicles. Make sure all running lights, brake lights, turn signals and hazard lights are working.

Before Towing a Trailer

Practice turning, stopping and backing up to get the feel of your vehicle-trailer combination before starting on a trip. When turning, make wider turns so the trailer wheels clear curbs and other obstacles.

When Towing a Trailer

- Do not drive faster than 70 mph (113 km/h) during the first 500 mi (800 km).
- Do not make full-throttle starts.

Towing

- Check your hitch, electrical connections and trailer wheel lug nuts thoroughly after you have traveled 50 mi (80 km).
- When stopped in congested or heavy traffic during hot weather, place the transmission in park (P) to aid engine and transmission cooling and to help A/C performance.
- Turn off the speed control with heavy loads or in hilly terrain. The speed control may turn off automatically when you are towing on long, steep grades.
- Shift to a lower gear when driving down a long or steep hill. Do not apply the brakes continuously, as they may overheat and become less effective.
- If your transmission is equipped with a Grade Assist or Tow/Haul feature, use this feature when towing. This provides engine braking and helps eliminate excessive transmission shifting for optimum fuel economy and transmission cooling.
- If your vehicle is equipped with AdvanceTrac with RSC, this system may turn on during typical cornering maneuvers with a heavily loaded trailer. This is normal. Turning the corner at a slower speed while towing may reduce this tendency.
- If you are towing a trailer frequently in hot weather, hilly conditions, at the gross combined weight rating, or any combination of these factors, consider refilling your rear axle with synthetic gear lubricant if the axle is not already filled with it. See **Capacities and Specifications** (page 325).
- Allow more distance for stopping with a trailer attached. Anticipate stops and brake gradually.
- Avoid parking on a grade. However, if you must park on a grade:

1. Turn the steering wheel to point your vehicle tires away from traffic flow.
2. Set your vehicle parking brake.
3. Place the automatic transmission in park (P).
4. Place wheel chocks in front and back of the trailer wheels. Chocks are not included with your vehicle.

Your vehicle may be equipped with a temporary or conventional spare tire. A temporary spare tire is different in diameter or width, tread-type, or is from a different manufacturer than the road tires on your vehicle. Consult information on the tire label or Safety Compliance label for limitations when using.

Launching or Retrieving a Boat or Personal Watercraft (PWC)

Note: *Disconnect the wiring to the trailer before backing the trailer into the water.*

Note: *Reconnect the wiring to the trailer after removing the trailer from the water.*

When backing down a ramp during boat launching or retrieval:

- Do not allow the static water level to rise above the bottom edge of the rear bumper.
- Do not allow waves to break higher than 6 in (15 cm) above the bottom edge of the rear bumper.

Exceeding these limits may allow water to enter vehicle components:

- Causing internal damage to the components.
- Affecting driveability, emissions, and reliability.

Replace the rear axle lubricant anytime the rear axle has been submerged in water. Water may have contaminated the rear axle lubricant, which is not normally checked or changed unless a leak is suspected or other axle repair is required.

Towing

TOWING THE VEHICLE ON FOUR WHEELS



WARNING: If your vehicle has a steering wheel lock make sure the ignition is in the accessory or on position when being towed.

Emergency Towing

If your vehicle becomes inoperable without access to wheel dollies, a car-hauling trailer or a flatbed transport vehicle, you can flat-tow with all wheels on the ground, regardless of the powertrain and transmission configuration, under the following conditions:

- Your vehicle is facing forward for towing in a forward direction.
- Place the transmission in neutral (N). If you cannot move the transmission into neutral (N), you may need to override the gear shifter. See **Automatic Transmission** (page 161).
- Maximum speed is 35 mph (55 km/h).
- Maximum distance is 50 mi (80 km).

Recreational Towing



WARNING: Do not disconnect the battery when recreationally towing your vehicle. This prevents the transfer case from shifting properly and could cause the vehicle to roll, even if the transmission is in park (P).



WARNING: Placing the transfer case in its neutral position could cause your vehicle to freely roll. Make sure you press and hold the brake pedal and the vehicle is in a secure, safe position when you place the transfer case in its neutral position.

Follow these guidelines if you have a need for recreational towing. An example of recreational towing would be towing your vehicle behind a motorhome. These guidelines are to make sure that you do not damage the transmission.

You can only tow your vehicle with all wheels on the ground by placing the transfer case in its neutral position and engaging the recreational tow feature. Perform the following steps after positioning your vehicle behind the tow vehicle and properly securing them together.

Note: Put your climate control system in recirculated air mode to prevent exhaust fumes from entering your vehicle.

Note: Failure to put the transfer case in its neutral position can damage vehicle components.

Note: You can check the towing status at any time by opening the driver door or turning the ignition to the accessory or on position. **Neutral Tow Enabled Leave Transmission in Neutral** appears in the instrument cluster display to confirm you can recreationally tow your vehicle.

Switching Neutral Tow On

1. Switch your vehicle to accessory mode by pressing the push button ignition switch without pressing the brake pedal or by turning the key to the on position.
2. Press and hold the brake pedal.
3. Rotate the four-wheel drive control to **2H**.
4. Shift the transmission to neutral (N).
5. Using the instrument cluster controls on the steering wheel, select **Settings**.
6. Select **Vehicle**.
7. Select **Neutral Tow**.

Towing

8. Press and hold the **OK** button until a confirmation message appears in the information display.

Note: If completed successfully, the information display shows **Neutral Tow Enabled Leave Transmission in Neutral**. This indicates that your vehicle is safe to tow with all wheels on the ground.

Note: If you do not see a confirmation message in the instrument cluster display, you must switch your vehicle off and perform the procedure again from the beginning.

Note: You could hear noise as the transfer case shifts into its neutral position. This is normal.

9. Leave the transmission in neutral (N) and switch your vehicle off by pressing the push button ignition switch once without pressing the brake pedal or turning the key as far toward the off position.

Note: Vehicles with keys do not turn to the off position when the transmission is in neutral (N). You must leave the key in the ignition when towing. Use the keyless entry keypad or an extra set of keys to lock and unlock your vehicle.

10. Release the brake pedal.

Switching Neutral Tow Off

1. With your vehicle still properly secured to the tow vehicle, switch your vehicle to accessory mode by pressing the push button ignition switch without pressing the brake pedal or by turning the key to the on position.
2. Press and hold the brake pedal.
3. Shift the transmission out of neutral (N) and into park (P).

Note: If completed successfully, the four-wheel drive control indicates **2H** and the instrument cluster display shows **Neutral Tow Disabled**.

Note: If the indicator light and message do not display, you must perform the procedure again from the beginning.

Note: You could hear a noise as the transfer case shifts out of its neutral position. This is normal.

4. Apply the parking brake, then disconnect your vehicle from the tow vehicle.
5. Release the parking brake, start your vehicle, and shift into drive (D) to make sure the transfer case is out of its neutral position.
6. If the transfer case does not successfully shift out of its neutral position, apply the parking brake. Have your vehicle checked as soon as possible.

Driving Hints

BREAKING-IN

You need to break in new tires for approximately 300 mi (480 km). During this time, your vehicle may exhibit some unusual driving characteristics.

Avoid driving too fast during the first 1,000 mi (1,600 km). Vary your speed frequently and change up through the gears early. Do not labor the engine.

Do not tow during the first 1,000 mi (1,600 km).

ECONOMICAL DRIVING

Your fuel economy is affected by several things, such as how you drive, the conditions you drive under, and how you maintain your vehicle.

You may improve your fuel economy by keeping these things in mind:

- Accelerate and slow down in a smooth, moderate fashion.
- Drive at steady speeds without stopping.
- Anticipate stops; slowing down may eliminate the need to stop.
- Combine errands and minimize stop-and-go driving.
- Close the windows for high-speed driving.
- Drive at reasonable speeds (traveling at 55 mph [88 km/h] uses 15% less fuel than traveling at 65 mph [105 km/h]).
- Keep the tires properly inflated and use only the recommended size.
- Use the recommended engine oil.
- Perform all regularly scheduled maintenance.

Avoid these actions; they reduce your fuel economy:

- Sudden accelerations or hard accelerations.
- Revving the engine before turning it off.
- Idle for periods longer than one minute.
- Warm up your vehicle on cold mornings.
- Use the air conditioner or front defroster.
- Use the speed control in hilly terrain.
- Rest your foot on the brake pedal while driving.
- Drive a heavily loaded vehicle or tow a trailer.
- Carry unnecessary weight (approximately 1 mpg [0.4 km/L] is lost for every 400 lb [180 kilogram] of weight carried).
- Driving with the wheels out of alignment.

Conditions

- Heavily loading a vehicle or towing a trailer may reduce fuel economy at any speed.
- Adding certain accessories to your vehicle (for example bug deflectors, rollbars, light bars, running boards, ski racks or luggage racks) may reduce fuel economy.
- To maximize the fuel economy, drive with the tonneau cover installed (if equipped).
- Using fuel blended with alcohol may lower fuel economy.
- Fuel economy may decrease with lower temperatures during the first 5–10 mi (12–16 km) of driving.
- Driving on flat terrain offers improved fuel economy as compared to driving on hilly terrain.

Driving Hints

- Transmissions give their best fuel economy when operated in the top cruise gear and with steady pressure on the gas pedal.
- Four-wheel-drive operation (if equipped) is less fuel efficient than two-wheel-drive operation.
- Always keep available ground clearance in mind and pick a route that minimizes the risk of catching the underside of the vehicle on an obstacle.
- When negotiating low speed obstacles, applying light brake pressure in conjunction with the throttle helps prevent the vehicle from jerking and allows you to negotiate the obstacle in a more controlled manner. Using 4L also helps with this.

COLD WEATHER PRECAUTIONS

The functional operation of some components and systems can be affected at temperatures below approximately -13°F (-25°C).

OFF-ROAD DRIVING

Before going off-roading, consult with your local governmental agencies to determine designated off-road trails and recreation areas. Also, be sure to understand any off-road vehicle registration requirements for the area in which you plan on driving.

Before taking your vehicle off-roading, a basic vehicle inspection should be done to make sure that the vehicle is in top working condition.

Basic Off-road Driving Techniques

- Grip the steering wheel with thumbs on the outside of the rim. This reduces the risk of injury due to abrupt steering wheel motions that occur when negotiating rough terrain. Do not grip the steering wheel with thumbs inside the rim.
- Look ahead on your route noting upcoming obstacles, surface texture or color changes or any other factors which may indicate a change in available traction, and adjust the vehicle speed and route accordingly.

Crossing Obstacles

- Review the path ahead before attempting to cross any obstacle. It is best if the obstacle is reviewed from outside the vehicle so that there is a good understanding of terrain condition both in front of and behind the obstacle.
- If a large obstacle such as a rock cannot be avoided, choose a path that places the rock directly under the tire rather than the undercarriage of the vehicle. This helps prevent damage to your vehicle.

Hill Climbing



WARNING: Extreme care should be used when steering the vehicle in reverse down a slope so as not to cause the vehicle to swerve out of control.

Driving Hints

- Always attempt to climb a steep hill along the fall line of the slope and not diagonally.
- If the vehicle is unable to make it up the hill, DO NOT attempt to turn back down the slope. Place the vehicle in low range and slowly back down in reverse.
- When descending a steep slope, select low gear and activate hill descent control. Use the throttle and brake pedals to control your descent speed as described earlier in this section using hill descent control. Hill descent control is functional in reverse (R) and should be used in this situation.
- Inspect the wheels for dents, cracks, or other damage.
- Clear any debris from the exhaust components. For example, grass or hay.

After Off-Road Driving

It is important to complete a full vehicle inspection after off-road driving. Some items to check include:

- Check the wheels and undercarriage for a buildup of mud or debris, which can cause vehicle vibration.
- Make sure that the grille and radiator are clear of any obstructions that may affect cooling.
- Make sure that the brakes are in proper working order and free of any mud, stones and debris, which can become trapped around the brake rotor, backing plate and caliper.
- Check that the air filter is clean and dry.
- Inspect for torn or punctured boots on ball joints, half shafts, steering gears.
- Inspect exhaust system for damage or looseness.
- Inspect undercarriage fasteners. If any are loose or damaged, tighten or replace and make sure that you use the proper torque specification.

DRIVING THROUGH WATER

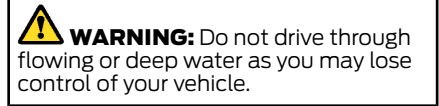

Note: *Driving through standing water can cause vehicle damage.*

Note: *Engine damage can occur if water enters the air filter.*

Before driving through standing water, check the depth. Never drive through water that is higher than the bottom of the wheel hubs.

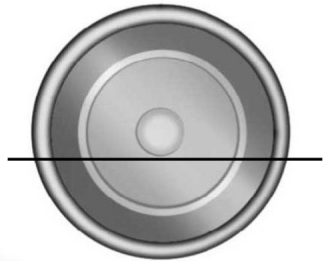

When driving through standing water, drive very slowly and do not stop your vehicle. Your brake performance and traction may be limited. After driving through water and as soon as it is safe to do so:

- Lightly press the brake pedal to dry the brakes and to check that they work.
- Check that the horn works.

Driving Hints

- Check that the exterior lights work.
- Turn the steering wheel to check that the steering power assist works.

FLOOR MATS



WARNING: Use a floor mat designed to fit the footwell of your vehicle that does not obstruct the pedal area. Failure to follow this instruction could result in the loss of control of your vehicle, personal injury or death.



WARNING: Pedals that cannot move freely can cause loss of vehicle control and increase the risk of serious personal injury.



WARNING: Secure the floor mat to both retention devices so that it cannot slip out of position and interfere with the pedals. Failure to follow this instruction could result in the loss of control of your vehicle, personal injury or death.



WARNING: Do not place additional floor mats or any other covering on top of the original floor mats. This could result in the floor mat interfering with the operation of the pedals. Failure to follow this instruction could result in the loss of control of your vehicle, personal injury or death.



WARNING: Always make sure that objects cannot fall into the driver foot well while your vehicle is moving. Objects that are loose can become trapped under the pedals causing a loss of vehicle control.



To install floor mats that have eyelets, position the floor mat eyelet over the retention post and press down to lock in position. Repeat for all eyelets on the floor mat.

To remove the floor mats, reverse the installation procedure.

Note: Regularly check the floor mats to make sure they are secure.

Roadside Emergencies

ROADSIDE ASSISTANCE

Vehicles Sold in the United States: Getting Roadside Assistance

To fully assist you should you have a vehicle concern, Ford Motor Company offers a complimentary roadside assistance program. This program is separate from the New Vehicle Limited Warranty.

The service is available:

- 24 hours a day, seven days a week.
- For the coverage period supplied with your vehicle.

Roadside Assistance covers:

- A flat tire change with a good spare (except vehicles supplied with a tire inflation kit).
- Battery jump start.
- Lock-out assistance (key replacement cost is the customer's responsibility).
- Fuel delivery — independent service contractors, if not prohibited by state, local or municipal law, shall deliver up to 2 gal (8 L) of gasoline or 5 gal (20 L) of diesel fuel to a disabled vehicle. Roadside Assistance limits fuel delivery service to two no-charge occurrences within a 12-month period.
- Winch out — available within 100 ft (30 m) of a paved or county maintained road, no recoveries.

- Towing — independent service contractors, if not prohibited by state, local or municipal law, shall tow Ford eligible vehicles to an authorized dealer within 35 mi (56 km) of the disablement location or to the nearest authorized dealer. If a member requests a tow to an authorized dealer that is more than 35 mi (56 km) from the disablement location, the member shall be responsible for any mileage costs in excess of 35 mi (56 km).
- Roadside Assistance includes up to \$200 for a towed trailer if the disabled eligible vehicle requires service at the nearest authorized dealer. If the towing vehicle is operational but the trailer is not, then the trailer does not qualify for any roadside services.

Vehicles Sold in the United States: Using Roadside Assistance

Complete the roadside assistance identification card and place it in your wallet for quick reference. This card is in the Owner's Manual kit.

United States vehicle customers who require Roadside Assistance, call 1-800-241-3673.

If you need to arrange roadside assistance for yourself, Ford Motor Company reimburses a reasonable amount for towing to the nearest dealership within 35 mi (56 km). To obtain reimbursement information, United States vehicle customers call 1-800-241-3673. Customers need to submit their original receipts.

Roadside Emergencies

Vehicles Sold in Canada: Getting Roadside Assistance

To fully assist you should you have a vehicle concern, Ford Motor Company of Canada, Limited offers a complimentary roadside assistance program. This program is eligible within Canada or the continental United States.

The service is available 24 hours a day, seven days a week.

This program is separate from the New Vehicle Limited Warranty, but the coverage is concurrent with the powertrain coverage period of your vehicle. Canadian roadside coverage and benefits may differ from the U.S. coverage.

If you require more information, please call us in Canada at 1-800-665-2006, or visit our website at www.ford.ca.

HAZARD FLASHERS

Note: *The hazard flashers operate when the ignition is in any position, or if the key is not in the ignition. If used when the vehicle is not running, the battery loses charge. As a result, there may be insufficient power to restart your vehicle.*



The flasher control is on the instrument panel. Use your hazard flashers when your vehicle is creating a safety hazard for other motorists.

- Press the flasher control and all front and rear direction indicators flash.
- Press the button again to switch them off.

JUMP STARTING THE VEHICLE



WARNING: The gases around the battery can explode if exposed to flames, sparks, or lit cigarettes. An explosion could result in personal injury or vehicle damage.



WARNING: Batteries contain sulfuric acid which can burn skin, eyes and clothing, if contacted.



WARNING: Use only an adequate-sized cable with insulated clamps.

Preparing Your Vehicle

Note: *Do not attempt to push-start your automatic transmission vehicle. Automatic transmissions do not have push-start capability. Attempting to push-start a vehicle with an automatic transmission may cause transmission damage.*

Note: *Use only a 12-volt supply to start your vehicle.*

Note: *Do not disconnect the battery of the disabled vehicle as this could damage the vehicle's electrical system.*

Park the booster vehicle close to the hood of the disabled vehicle, making sure the two vehicles do not touch. Turn all accessories off.

Roadside Emergencies

Connecting the Jumper Cables



WARNING: Do not attach the cables to fuel lines, engine rocker covers, the intake manifold or electrical components as grounding points. Stay clear of moving parts. To avoid reverse polarity connections, make sure that you correctly identify the positive (+) and negative (-) terminals on both the disabled and booster vehicles before connecting the cables. Battery positions may vary.

Note: In the illustration, the bottom vehicle represents the booster vehicle.

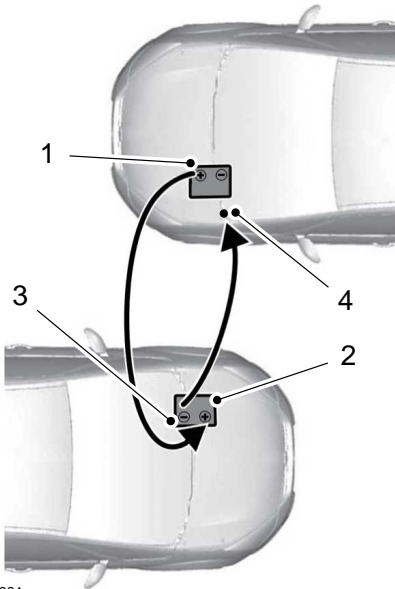

E142664

1. Connect the positive (+) jumper cable to the positive (+) terminal of the discharged battery.

2. Connect the other end of the positive (+) cable to the positive (+) terminal of the assisting battery.
3. Connect the negative (-) cable to the negative (-) terminal of the assisting battery.

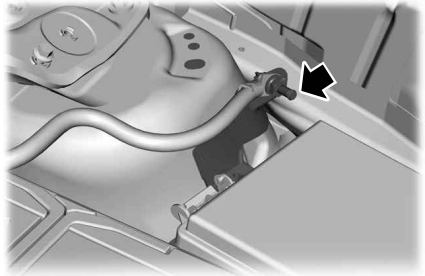

E152134

4. Make the final connection of the negative (-) cable to an exposed metal part of the stalled vehicle's engine, or connect the negative (-) cable to the ground connection point, if available.



WARNING: Do not connect the end of the second cable to the negative (-) terminal of the battery to be jumped. A spark may cause an explosion of the gases that surround the battery.

Jump Starting

1. Start the engine of the booster vehicle and rev the engine moderately, or press the accelerator gently to keep your engine speed between 2000 and 3000 rpms, as shown in your tachometer.
2. Start the engine of the disabled vehicle.
3. After starting the disabled vehicle, run both vehicle engines for an additional three minutes before disconnecting the jumper cables.

Roadside Emergencies

Removing the Jumper Cables

Remove the jumper cables in the reverse order that they were connected.

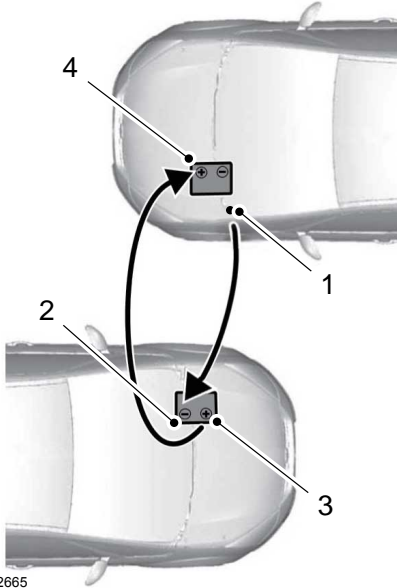

1. Remove the jumper cable from the ground metal surface or connecting point, if available.
2. Remove the jumper cable on the negative (-) terminal of the booster vehicle's battery.
3. Remove the jumper cable from the positive (+) terminal of the booster vehicle's battery.
4. Remove the jumper cable from the positive (+) terminal of the disabled vehicle's battery.

After starting your disabled vehicle and removing the jumper cables, allow your vehicle to idle for several minutes so the battery can recharge.

TRANSPORTING THE VEHICLE



WARNING: Block the wheels to help prevent the vehicle from moving.



WARNING: Unexpected and possibly sudden vehicle movement may occur if you do not take these precautions.

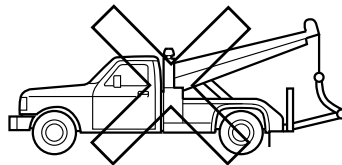
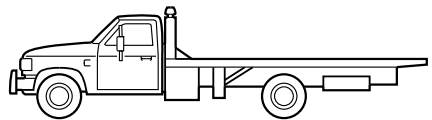
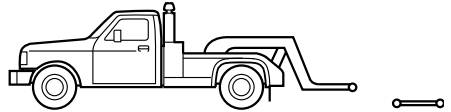

If you need to tow your vehicle, contact a professional towing service or, if you are a member of a roadside assistance program, your roadside assistance service provider.

Roadside Emergencies

We recommend the use of a wheel lift and dollies or flatbed equipment to tow your vehicle. Do not tow with a slingbelt. We do not approve a slingbelt towing procedure. If you tow your vehicle incorrectly, or by any other means, vehicle damage may occur.

We produce a towing manual for all authorized tow truck operators. Have your tow truck operator refer to this manual for proper hook-up and towing procedures for your vehicle.

It is acceptable to have your two-wheel drive vehicle towed with the front wheels on the ground (without dollies) and the rear wheels off the ground.

We recommend towing a four-wheel drive vehicle with all wheels off the ground, such as using a wheel lift and dollies or flatbed equipment. However, it is acceptable to use a wheel lift to raise the rear of your vehicle so long as, depending on vehicle configuration, you perform the following before towing:

- If your vehicle has an electronic shift-on-the-fly transfer case, make sure you switch the four-wheel drive control to the **2H** position before towing.

Note: Towing an electronic shift-on-the-fly four-wheel drive vehicle with the front wheels on the ground without disengaging the front hubs may cause damage to the automatic transmission.

Note: Towing a two-wheel drive vehicle or an electronic shift-on-the-fly four-wheel drive vehicle with the rear wheels on the ground for more than 50 mi (80 km) or faster than 35 mph (56 km/h) may cause damage to the automatic transmission.

TOWING POINTS

Note: Some towing points may not be on your vehicle.

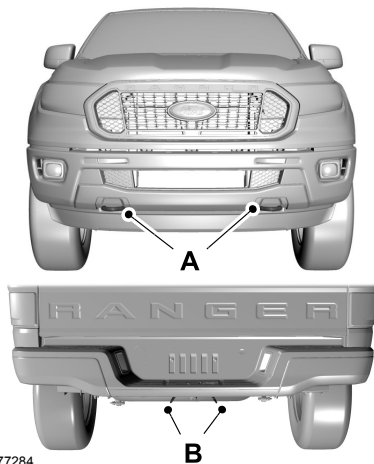

E277284

- A Front towing eyes.
- B Rear safety chain loop.

Your vehicle comes with frame-mounted front recovery hooks. These hooks should never have a load applied to them greater than the gross vehicle weight rating of your vehicle.

Before using recovery hooks:

- Make sure all attaching points are secure and capable of withstanding the applied load.
- Never use chains, cables or tow straps with metal hook ends.
- Only use recovery straps that have a minimum breaking strength two to three times the gross vehicle weight of the stuck vehicle.
- Make sure the recovery strap is in good condition and free of visible cuts, tears or damage.

Roadside Emergencies

- Use a damper device such as a tarp, heavy blanket or piece of carpet draped over the recovery strap to help absorb the energy in the event the strap breaks.
- Make sure the stuck vehicle is not loaded heavier than its gross vehicle weight rating specified on the certification label.
- Always align the tow vehicle and stuck vehicle in a straight line (within 10 degrees).
- Keep bystanders to the **sides** of the vehicle, at a distance of at least twice the length of the recovery strap. This helps avoid injury from the hazard of a recovery hook or strap breaking, or a vehicle lurching into their path.

Crash and Breakdown Information

AUTOMATIC CRASH SHUTOFF

WHAT IS AUTOMATIC CRASH SHUTOFF

The automatic crash shutoff is designed to stop the fuel going to the engine in the event of a moderate or severe crash.

Note: *Not every impact causes a shutoff.*

AUTOMATIC CRASH SHUTOFF PRECAUTIONS



WARNING: If your vehicle has been involved in a crash, have the fuel system checked. Failure to follow this instruction could result in fire, personal injury or death.

RE-ENABLING YOUR VEHICLE

1. Switch the ignition off.
2. Attempt to start your vehicle.
3. Switch the ignition off.
4. Attempt to start your vehicle.

Note: *If your vehicle does not start after the third attempt, have your vehicle checked as soon as possible.*

Customer Assistance

GETTING THE SERVICES YOU NEED

Warranty repairs to your vehicle must be performed by an authorized dealer. While any authorized dealer handling your vehicle line will provide warranty service, we recommend you return to your selling authorized dealer who wants to ensure your continued satisfaction.

Please note that certain warranty repairs require special training and equipment, so not all authorized dealers are authorized to perform all warranty repairs. This means that, depending on the warranty repair needed, you may have to take your vehicle to another authorized dealer.

A reasonable time must be allowed to perform a repair after taking your vehicle to the authorized dealer. Repairs will be made using Ford or Motorcraft® parts, or remanufactured or other parts that are authorized by Ford.

Away From Home

If you are away from home when your vehicle needs service, contact the Ford Customer Relationship Center or use the online resources listed below to find the nearest authorized dealer.

In the United States:

Mailing address

Ford Motor Company
Customer Relationship Center
P.O. Box 6248
Dearborn, MI 48126

Telephone

1-800-392-3673 (FORD)
TDD for the hearing impaired:
7-1-1 (where offered by your telephone service provider)

If your vehicle is configured as a motorhome please call 1-800-444-3311 for support.

Additional information and resources are available online:

Website
www.owner.ford.com

These are some of the items that can be found online:

- U.S. dealer locator by Dealer Name, City/State or Zip Code.
- Owner Manuals.
- Maintenance Schedules.
- Recalls.
- Ford Extended Service Plans.
- Ford Genuine Accessories.
- Service specials and promotions.

In Canada:

Mailing address

Customer Relationship Centre
Ford Motor Company of Canada, Limited
P.O. Box 2000
Oakville, Ontario L6K 0C8

Telephone

1-800-565-3673 (FORD)
TDD for the hearing impaired:
7-1-1 (where offered by your telephone service provider)

Website
www.ford.ca

Facebook

FordServiceCA (English)
FordServiceQC (Français)

Twitter

@FordServiceCA

Customer Assistance

Additional Assistance

If you have questions or concerns, or are unsatisfied with the service you are receiving, follow these steps:

1. Contact your Sales Representative or Service Advisor at your selling or servicing authorized dealer.
2. If your inquiry or concern remains unresolved, contact the Sales Manager, Service Manager or Customer Relations Manager.
3. If you require assistance or clarification on Ford Motor Company policies, please contact the Ford Customer Relationship Center.

In order to help us serve you better, please have the following information available when contacting a Customer Relationship Center:

- Vehicle Identification Number.
- Your telephone number (home and business).
- The name of the authorized dealer and city where located.
- The vehicle's current odometer reading.

In some states within the United States, you must directly notify Ford in writing before pursuing remedies under your state's warranty laws, and Ford is also allowed a final repair attempt.

Additionally, in some states within the United States, a consumer has the option of submitting a warranty dispute to the BBB Auto Line before taking action under the Magnuson-Moss Warranty Act, or to the extent allowed by state law, before pursuing replacement or repurchase remedies provided by certain state laws. This dispute handling procedure is not required prior to enforcing state created rights or other rights which are independent of the Magnuson-Moss Warranty Act or state replacement or repurchase laws.

IN CALIFORNIA (U.S. ONLY)

California Civil Code Section 1793.2(d) requires that, if a manufacturer or its representative is unable to repair a motor vehicle to conform to the vehicle's applicable express warranty after a reasonable number of attempts, the manufacturer shall be required to either replace the vehicle with one substantially identical or repurchase the vehicle and reimburse the buyer in an amount equal to the actual price paid or payable by the consumer (less a reasonable allowance for consumer use). The consumer has the right to choose whether to receive a refund or replacement vehicle.

California Civil Code Section 1793.22(b) presumes that the manufacturer has had a reasonable number of attempts to conform the vehicle to its applicable express warranties if, within the first 18 months of ownership of a new vehicle or the first 18,000 mi (29,000 km), whichever occurs first:

1. Two or more repair attempts are made on the same non-conformity likely to cause death or serious bodily injury OR
2. Four or more repair attempts are made on the same nonconformity (a defect or condition that substantially impairs the use, value or safety of the vehicle) OR
3. The vehicle is out of service for repair of nonconformities for a total of more than 30 calendar days (not necessarily all at one time).

In the case of 1 or 2 above, the consumer must also notify the manufacturer of the need for the repair of the nonconformity at the following address:

Ford Motor Company
16800 Executive Plaza Drive
Mail Drop 3NE-B
Dearborn, MI 48126

Customer Assistance

You are required to submit your warranty dispute to BBB AUTO LINE before asserting in court any rights or remedies conferred by California Civil Code Section 1793.22(b). You are also required to use BBB AUTO LINE before exercising rights or seeking remedies created by the Federal Magnuson-Moss Warranty Act, 15 U.S.C. sec. 2301 et seq. If you choose to seek redress by pursuing rights and remedies not created by California Civil Code Section 1793.22(b) or the Magnuson-Moss Warranty Act, resort to BBB AUTO LINE is not required by those statutes.

THE BETTER BUSINESS BUREAU (BBB) AUTO LINE PROGRAM (U.S. ONLY)

Your satisfaction is important to Ford Motor Company and to your dealer. If a warranty concern has not been resolved using the three-step procedure outlined earlier in this chapter in the Getting the Services you need section, you may be eligible to participate in the BBB AUTO LINE program.

The BBB AUTO LINE program consists of two parts – mediation and arbitration. During mediation, a representative of the BBB will contact both you and Ford Motor Company to explore options for settlement of the claim. If an agreement is not reached during mediation or you do not want to participate in mediation, and if your claim is eligible, you may participate in the arbitration process. An arbitration hearing will be scheduled so that you can present your case in an informal setting before an impartial person. The arbitrator considers the testimony provided and makes a decision after the hearing.

Disputes submitted to the BBB AUTO LINE program are usually decided within 40 days after you file your claim with the BBB. You are not bound by the decision, and may reject the decision and proceed to court where all findings of the BBB Auto Line dispute, and decision, are admissible in the court action. Should you choose to accept the BBB AUTO LINE decision, Ford is then bound by the decision, and must comply with the decision within 30 days of receipt of your acceptance letter.

BBB AUTO LINE Application: Using the information that follows, please call or write to request a program application. You will be asked for your name and address, general information about your new vehicle, information about your warranty concerns, and any steps you have already taken to try to resolve them. A Customer Claim Form will be mailed that needs to be completed, signed and returned to the BBB along with proof of ownership. Upon receipt, the BBB reviews the claim for eligibility under the Program Summary Guidelines.

You can get more information by calling BBB AUTO LINE at 1-800-955-5100, or writing to:

**BBB AUTO LINE a Division of BBB National Programs, Inc.
1676 International Drive, Suite 550
McLean, VA 22102**

BBB AUTO LINE applications can also be requested by calling the Ford Motor Company Customer Relationship Center at 1-800-392-3673.

For additional information, refer to the Better Business Bureau website.

Note: *Ford Motor Company reserves the right to change eligibility limitations, modify procedures, or to discontinue this process at any time without notice and without obligation.*

Customer Assistance

UTILIZING THE MEDIATION/ARBITRATION PROGRAM (CANADA ONLY)

For vehicles delivered to authorized Canadian dealers. In those cases where you continue to feel that the efforts by Ford of Canada and the authorized dealer to resolve a factory-related vehicle service concern have been unsatisfactory, Ford of Canada participates in an impartial third party mediation/arbitration program administered by the Canadian Motor Vehicle Arbitration Plan (CAMVAP).

The CAMVAP program is a straight forward and relatively speedy alternative to resolve a disagreement when all other efforts to produce a settlement have failed. This procedure is without cost to you and is designed to eliminate the need for lengthy and expensive legal proceedings.

In the CAMVAP program, impartial third-party arbitrators conduct hearings at mutually convenient times and places in an informal environment. These impartial arbitrators review the positions of the parties, make decisions and, when appropriate, render awards to resolve disputes. CAMVAP decisions are fast, fair, and final as the arbitrator's award is binding on both you and Ford of Canada.

CAMVAP services are available in all Canadian territories and provinces. For more information, without charge or obligation, call your CAMVAP Provincial Administrator directly at 1-800-207-0685 or visit www.camvap.ca.

GETTING ASSISTANCE OUTSIDE THE U.S. AND CANADA

Before exporting your vehicle to a foreign country, contact the appropriate foreign embassy or consulate. These officials can inform you of local vehicle registration regulations and where to find unleaded fuel or petrol/gas engines or the proper sulfur fuel for diesel engines.

If you cannot find the proper fuel recommended for your vehicle, contact our Customer Relationship Center.

The use of improper fuels in your vehicle without proper conversion may damage the effectiveness of your emission control system and may cause engine knocking or serious engine damage. Ford Motor Company or Ford of Canada is not responsible for any damage caused by use of improper fuel. Using improper fuels may also result in difficulty importing your vehicle back into the United States.

If your vehicle must be serviced while you are traveling or living in Asia-Pacific Region, Sub-Saharan Africa, U.S. Virgin Islands and/or Puerto Rico, Central America, the Caribbean, and Israel and the Middle East, contact the nearest authorized dealer. If the authorized dealer cannot help you, contact the corresponding Ford Customer Assistance Center:

FORD MOTOR COMPANY
Customer Relationship Centers in:

Customer Assistance

Customer Relationship Center	Phone	Fax	E-mail
Asia Pacific	N/A	N/A	apemrc@ford.com
Caribbean and Central America	+1-800-841-3673	N/A	atnclien@ford.com
Middle East	Ford 80004443673	971 4 3327 266	menacac@ford.com
	Lincoln 80004441067		
	UAE 80004441066		
	Saudi Arabia 8008443673		
	Mobily and Zain cell phone users in Saudi 800850078		
	Kuwait 22280384		
North Africa	N/A	N/A	nafcrc@ford.com
Puerto Rico and U.S. Virgin Islands	+1-800-841-3673	N/A	atnclien@ford.com
Sub-Saharan Africa	N/A	N/A	ssacrc@ford.com
South Korea	+82-02-1600-6003	N/A	infokr1@ford.com or infokr@lincoln.com

If you buy your vehicle in North America and then relocate to any of the above locations, register your vehicle identification number (VIN) and new address with Ford Global Trade Services by emailing, expcso@ford.com.

If you are in another foreign country, contact the nearest authorized dealer. In the event your inquiry is unresolved, communicate your concern with the dealership's Sales Manager, Service Manager or Customer Relations Manager. If you require additional assistance or clarification, please contact the respective Customer Relationship Center as previously listed.

Customers in the U.S. should call 1-800-392-3673.

Customer Assistance

ORDERING ADDITIONAL OWNER'S LITERATURE

To order the publications in this portfolio, contact Helm, LLC at:

HELM, LLC
47911 Halyard Drive, Suite 200
Plymouth, Michigan 48170
Attention: Customer Service

Or to order a free publication catalog, call toll free: 1-800-782-4356

Monday-Friday 8:00 a.m. - 6:00 p.m. EST

Helm, LLC can also be reached by their website:

www.helminc.com

(Items in this catalog may be purchased by credit card, check or money order.)

Obtaining a French Owner's Manual

French Owner's Manual can be obtained from your authorized dealer or by contacting Helm, LLC using the contact information listed previously in this section.

REPORTING SAFETY DEFECTS (U.S. ONLY)

If you believe that your vehicle has a defect which could cause a crash or could cause injury or death, you should immediately inform the National Highway Traffic Safety Administration (NHTSA) in addition to notifying Ford Motor Company.

If NHTSA receives similar complaints, it may open an investigation, and if it finds that a safety defect exists in a group of vehicles, it may order a recall and remedy campaign. However, NHTSA cannot become involved in individual problems between you, your dealer, or Ford Motor Company.

To contact NHTSA, you may call the Vehicle Safety Hotline toll-free at 1-888-327-4236 (TTY: 1-800-424-9153); go to www.safercar.gov; or write to:

Administrator

1200 New Jersey Avenue,
Southeast

Washington, D.C. 20590

You can also obtain other information about motor vehicle safety from www.safercar.gov.

REPORTING SAFETY DEFECTS (CANADA ONLY)

If you believe that your vehicle has a defect which could cause a crash or could cause injury or death, you should immediately inform Transport Canada and Ford of Canada.

Customer Assistance

Transport Canada Contact Information	
Website (English)	http://tc.canada.ca/recalls
Website (French)	http://tc.canada.ca/rappels
Phone	1-800-333-0510

Ford of Canada Contact Information	
Website	www.ford.ca
Phone	1-800-565-3673

Fuses

FUSE BOX LOCATIONS

Left-Hand Drive

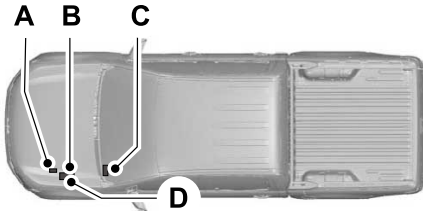

E264973

- A Pre-fuse box.
- B Engine compartment fuse box.
- C Passenger compartment fuse box.
- D High current fuse box.

Note: *The passenger compartment fuse box is on the right-hand side for right-hand drive vehicles.*

Pre-fuse Box

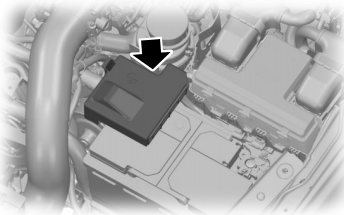

E206156

Your vehicle has a pre-fuse box in the engine compartment attached to the positive battery post. This box contains several high current fuses. If replacement of these high current fuses is required, see an authorized dealer.

Engine Compartment Fuse Box

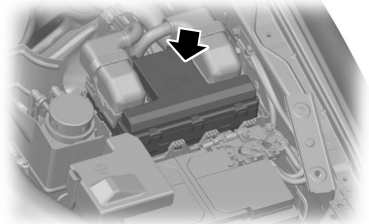

E206157

WARNING: Always disconnect the battery before servicing high current fuses.

WARNING: To reduce risk of electrical shock, always replace the cover to the power distribution box before reconnecting the battery or refilling fluid reservoirs.

The engine compartment fuse box has high-current fuses that protect your vehicle's main electrical systems from overloads.

When you disconnect and reconnect the battery, you need to reset some features. See **Changing the 12V Battery** (page 275).

Lift the release lever at the rear of the cover to remove it.

Fuses

High Current Fuse Box

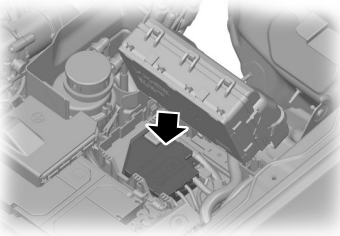

E206158

Your vehicle has a pre-fuse box in the engine compartment below the engine compartment fuse box. This box contains several high current fuses. If replacement of these high current fuses is required, see an authorized dealer.

Passenger Compartment Fuse Box

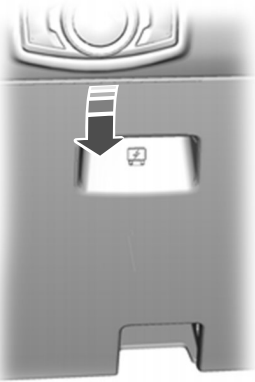

E206167

The fuse box is behind the access cover on the outermost side of the steering column.

FUSE SPECIFICATION CHART

Engine Compartment Fuse Box



WARNING: Always disconnect the battery before servicing high current fuses.



WARNING: To reduce risk of electrical shock, always replace the cover to the power distribution box before reconnecting the battery or refilling fluid reservoirs.

The engine compartment fuse box has high-current fuses that protect the vehicle's main electrical systems from overloads. When you disconnect and reconnect the battery, you need to reset some features. See **Changing the 12V Battery** (page 275). Lift the release levers at the rear of the cover to remove it.

Fuses

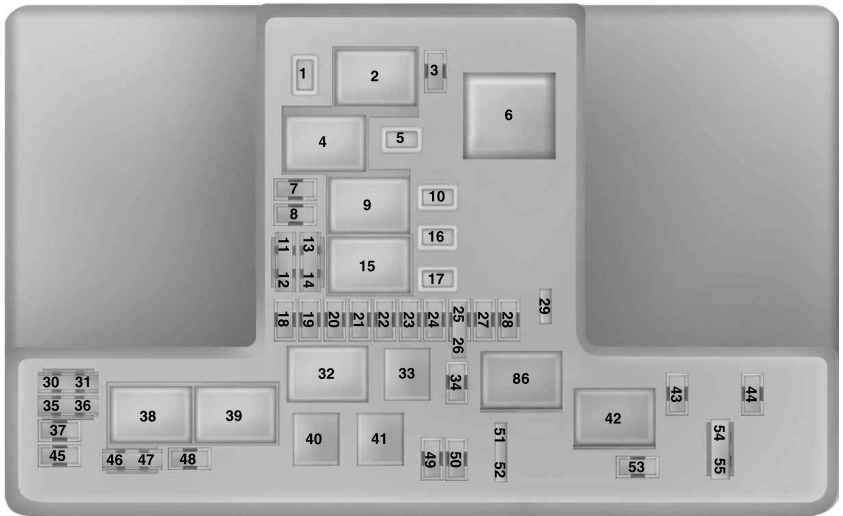

Item	Rating	Protected Component
1	-	Not used.
2	-	Starter motor solenoid relay.
3	5 A ²	Rain sensor.
4	-	Blower motor relay.
5	20 A ¹	Auxiliary power point 3 - console rear.
6	-	Trailer park lamp relay.
7	20 A ²	Powertrain control module.
8	20 A ²	Canister vent solenoid. Fuel vapor shutoff valve. Canister purge valve. Variable cam timing valve 1 and 2.

Fuses

Item	Rating	Protected Component
		Heated oxygen sensors.
9	-	Powertrain control module relay.
10	20 A ¹	Auxiliary power point 1 - instrument panel.
11	15 A ³	Ignition coils.
12	15 A ³	A/C control drive. Transaxle warmer. Auxiliary water pump. Aspirator valve control. Fan clutch. Oil pump. Turbo bypass.
13	-	Not used.
14	-	Not used.
15	-	Run/start relay.
16	20 A ¹	Auxiliary power point 2 - instrument panel.
17	20 A ¹	Auxiliary power point - rear cargo area.
18	-	Not used.
19	10 A ²	Electric power assist steering.
20	-	Not used.
21	5 A ²	Transmission run/start relay.
22	10 A ²	A/C compressor.
23	5 A ²	Voltage quality module.
24	-	Not used.
25	10 A ³	Anti-lock brake system.
26	10 A ³	Not used (spare).
27	-	Not used.

Fuses

Item	Rating	Protected Component
28	10 A ²	Powertrain control module.
29	7.5 A ²	USB charge port.
30	-	Not used.
31	-	Not used.
32	-	Fuel pump relay.
33	-	A/C clutch relay.
34	10 A ²	Trailer reverse lamp.
35	-	Not used.
36	-	Not used.
37	10 A ²	Heated exterior mirror.
38	-	Trailer right-hand turn and stop lamp relay.
39	-	Trailer left-hand turn and stop lamp relay.
40	-	Trailer reverse lamp relay.
41	-	Horn relay.
42	-	Four wheel drive motor no. 2 relay.
43	-	Not used.
44	-	Not used.
45	-	Not used.
46	10 A ³	Not used (spare).
47	10 A ³	Brake pedal switch.
48	20 A ²	Horn.
49	15 A ²	Transmission control module oil pump.
50	10 A ²	Not used (spare).
51	-	Not used.

Fuses

Item	Rating	Protected Component
52	-	Not used.
53	15 A ²	Rear differential lock.
54	-	Not used.
55	-	Not used.
86	-	Four wheel drive motor no. 1 relay.

¹ M-type fuse.

² Micro 2 fuse.

³ Micro 3 fuse.

Power Distribution Box - Bottom

There are fuses on the bottom of the fuse box. To access the bottom of the fuse box:

2. Lift the rear of the fuse box from the cradle.

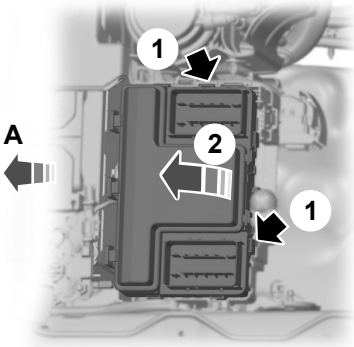

E206171

- A Toward the front of the vehicle.
1. Release the two latches on both sides of the fuse box.

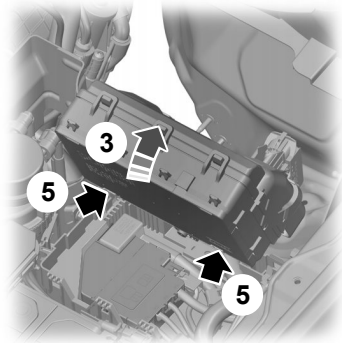

E206174

3. Move the fuse box toward the rear of the engine compartment and rotate as shown.
4. Pivot the rear of the fuse box to access the bottom side.
5. Release the two latches to open the fuse cover.

Fuses

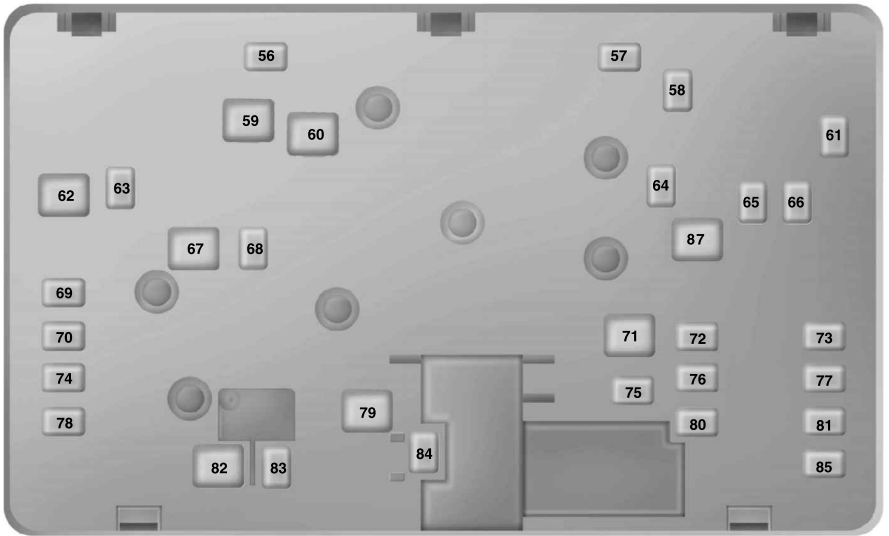

Item	Rating	Protected Component
56	15 A ¹	Trailer left-hand turn and stop lamp.
57	-	Not used.
58	-	Not used.
59	-	Not used.
60	30 A ²	Fuel pump control module.
61	-	Not used.
62	50 A ²	Body control module 1 - lighting.
63	15 A ¹	Trailer right-hand turn and stop lamp.
64	30 A ¹	Trailer brakes.

Fuses

Item	Rating	Protected Component
65	20 A ¹	Heated driver seat.
66	25 A ¹	Four-wheel drive.
67	50 A ²	Body control module 2 - lighting.
68	30 A ¹	Rear window defroster.
69	30 A ¹	Anti-lock brake system valves.
70	30 A ¹	Passenger power seat.
71	25 A ²	Trailer park lamps.
72	-	Not used.
73	30 A ¹	Trailer module.
74	30 A ¹	Driver power seat.
75	-	Not used.
76	-	Not used.
77	-	Not used.
78	-	Not used.
79	40 A ²	Blower motor.
80	20 A ¹	Heated passenger seat.
81	40 A ¹	Inverter.
82	60 A ²	Anti-lock brake system pump.
83	30 A ¹	Windshield wiper motor.
84	30 A ¹	Starter motor solenoid.

Fuses

Item	Rating	Protected Component
85	-	Not used.
87	40 A ²	Trailer module.

¹M-type fuse.

²LPJ-type fuse.

Battery Mounted Fuse Link

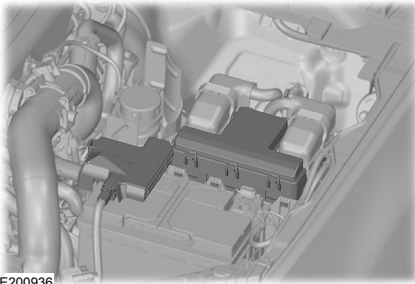

Item	Rating	Protected Component
1	300 A	Alternator (with auxiliary fuse and relay box).
	225 A	Alternator (without auxiliary fuse and relay box).
2	125 A	Electronic power assist steering.

Fuses

High Current Fuse Box

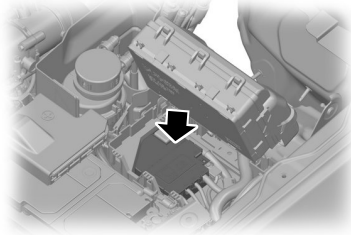

E206158

Item	Rating	Protected Component
1	-	Not used.
2	125 A	Body control module.
3	50 A	Voltage quality module (supplies rear lamp blind spot, rear view camera, head up display, 4x4 switch, image processing module and adaptive cruise control radar).
4	-	Busbar through to power distribution box.
5	100 A	Auxiliary fuse and relay box.

Passenger Compartment Fuse Box

The fuse box is below and outermost of the steering column behind the access cover.

Fuses

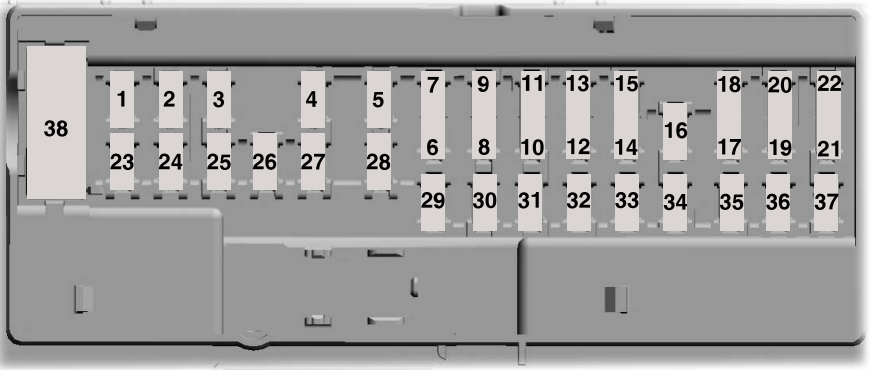

Item	Rating	Protected Component
1	-	Not used.
2	7.5 A ¹	Not used (spare).
3	20 A ¹	Driver door lock.
4	5 A ¹	Not used (spare).
5	20 A ¹	Branded audio amplifier.
6	10 A ²	Not used (spare).
7	10 A ²	Not used (spare).
8	10 A ²	Anti-theft alarm horn.
9	10 A ²	Telematics.
10	5 A ²	Not used (spare).
11	5 A ²	Not used (spare).
12	7.5 A ²	Electronic control panel.

Fuses

Item	Rating	Protected Component
		Climate control.
13	7.5 A ²	Instrument cluster. Steering column control module. Data link connector.
14	10 A ²	Extended power module (for restraints module and occupant module).
15	10 A ²	Data link module. Data link connector.
16	15 A ¹	Not used (spare).
17	5 A ²	Not used (spare).
18	5 A ²	Ignition switch. Lock solenoid. Push button start.
19	7.5 A ²	Extended power module (for restraints module and occupant module).
20	7.5 A ²	Auxiliary switches.
21	5 A ²	Humidity and in-car temperature sensor.
22	5 A ²	Not used (spare).
23	10 A ¹	Inverter. Door lock switch.
24	20 A ¹	Central locking system.
25	30 A ¹	Driver door power window.
26	30 A ¹	Not used (spare).
27	30 A ¹	Not used (spare).
28	20 A ¹	Branded audio amplifier.
29	30 A ¹	Not used (spare).
30	30 A ¹	Not used (spare).

Fuses

Item	Rating	Protected Component
31	15 A ¹	SYNC.
32	10 A ¹	Radio transceiver module. Door entry remote.
33	20 A ¹	Audio unit.
34	30 A ¹	Run/start relay.
35	5 A ¹	Not used (spare).
36	15 A ¹	Auto-dimming interior mirror. Mirror adjustment control.
37	20 A ¹	Not used (spare).
38	30 A ³	Power windows.

¹ Micro 2 fuse.

² Micro 3 fuse.

³ PTC fuse.

CHANGING A FUSE

Fuses



WARNING: Always replace a fuse with one that has the specified amperage rating. Using a fuse with a higher amperage rating can cause severe wire damage and could start a fire.

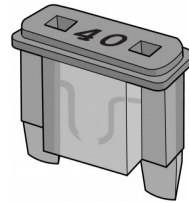

E217331

If electrical components in the vehicle are not working, a fuse may have blown. Blown fuses are identified by a broken wire within the fuse. Check the appropriate fuses before replacing any electrical components.

Fuses

Fuse Types

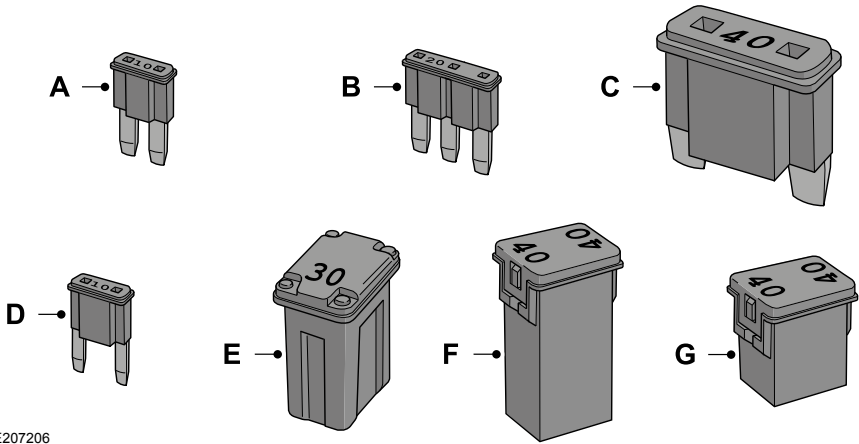

E207206

Callout	Fuse Type
A	Micro 2
B	Micro 3
C	Maxi
D	Mini
E	M Case
F	J Case
G	J Case Low Profile

Maintenance

GENERAL INFORMATION

Have your vehicle serviced regularly to help maintain its roadworthiness and resale value. There is a large network of authorized dealers that are there to help you with their professional servicing expertise. We believe that their specially trained technicians are best qualified to service your vehicle properly and expertly. They are supported by a wide range of highly specialized tools developed specifically for servicing your vehicle.

If your vehicle requires professional service, an authorized dealer can provide the necessary parts and service. Check your warranty information to find out which parts and services are covered.

Use only recommended fuels, lubricants, fluids and service parts conforming to specifications. Motorcraft® parts are designed and built to provide the best performance in your vehicle.

Precautions

- Do not work on a hot engine.
- Make sure that nothing gets caught in moving parts.
- Do not work on a vehicle with the engine running in an enclosed space, unless you are sure you have enough ventilation.
- Keep all open flames and other burning material (such as cigarettes) away from the battery and all fuel related parts.

Working with the Engine Off

1. Set the parking brake and shift the transmission to park (P).
2. Switch off the engine.
3. Block the wheels.

Working with the Engine On

 **WARNING:** To reduce the risk of vehicle damage and personal burn injuries, do not start your engine with the air cleaner removed and do not remove it while the engine is running.

 **WARNING:** Switch the ignition off and apply the parking brake.

 **WARNING:** Do not touch the electronic ignition system parts after you have switched the ignition on or when the engine is running. The system operates at high voltage. Failure to adhere to this warning could result in serious personal injury or death.

 **WARNING:** Keep your hands and clothing clear of the engine cooling fan.

1. Set the parking brake and shift the transmission to park (P).
2. Block the wheels.

Maintenance

OPENING AND CLOSING THE HOOD

Opening the Hood



E206129

1. Pull the hood release lever.

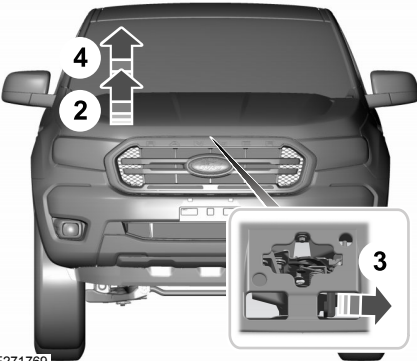

E271769

2. Slightly lift the hood.
3. Release the hood latch by pushing the secondary release lever to your left-hand side.

4. Open the hood.

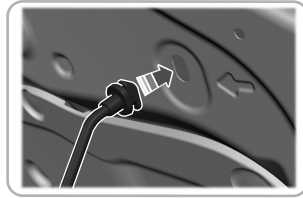

5. Open the hood and support it with the prop rod.

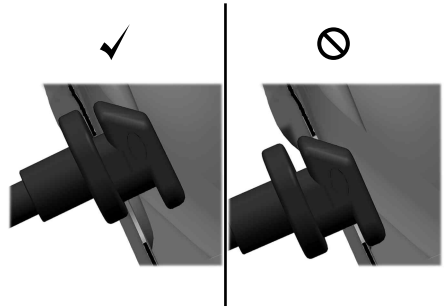

6. Make sure you fully engage the prop rod end cap with the hood.

Closing the Hood

1. Ensure you fully stow the prop rod prior to lowering the hood.
2. Lower the hood and ensure you fully latch it.

Note: Make sure that you correctly close the hood.

Maintenance

UNDER HOOD OVERVIEW

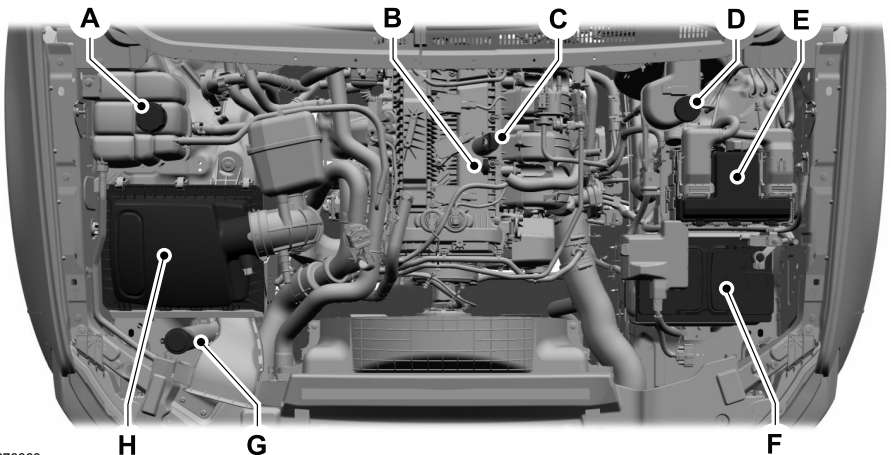

E276868

- A Engine coolant reservoir. See **Engine Coolant Check** (page 269).
- B Engine oil dipstick. See **Engine Oil Dipstick** (page 266).
- C Engine oil filler cap. See **Engine Oil Check** (page 266).
- D Brake fluid reservoir. See **Brake Fluid Check** (page 273).
- E Engine compartment fuse box. See **Changing a Fuse** (page 261).
- F Battery. See **Changing the 12V Battery** (page 275).
- G Windshield washer fluid reservoir. See **Washer Fluid Check** (page 277).
- H Air filter assembly. See **Changing the Engine Air Filter** (page 267).

Maintenance

ENGINE OIL DIPSTICK

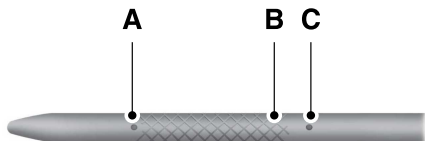

- A Minimum.
- B Nominal.
- C Maximum.

ENGINE OIL CHECK

To check the engine oil level consistently and accurately, do the following:

1. Make sure the parking brake is on. Make sure the transmission is in park (P) or neutral (N).
2. Run the engine until it reaches normal operating temperature.
3. Make sure that your vehicle is on level ground.
4. Switch the engine off and wait 15 minutes for the oil to drain into the oil pan. Checking the engine oil level too soon could result in an inaccurate reading.
5. Open the hood. See **Opening and Closing the Hood** (page 264).
6. Remove the dipstick and wipe it with a clean, lint-free cloth. See **Under Hood Overview** (page 265).

7. Reinstall the dipstick and remove it again to check the oil level. See **Engine Oil Dipstick** (page 266).
8. Make sure that the oil level is between the maximum and minimum marks. If the oil level is at the minimum mark, add oil immediately.
9. If the oil level is correct, replace the dipstick and make sure it is fully seated.

Note: Do not remove the dipstick when the engine is running.

Note: If the oil level is between the maximum and minimum marks, the oil level is acceptable. Do not add oil.

Note: The oil consumption of new engines reaches its normal level after approximately 3,000 mi (5,000 km).

Note: If oil levels are continuously noted above the maximum mark, contact your authorized dealer.

Note: Increases in oil level can occur from frequent short trips that do not allow the engine to get to operating temperature as well as frequent idling and low speed driving for long periods of time.

Adding Engine Oil



WARNING: Do not add engine oil when the engine is hot. Failure to follow this instruction could result in personal injury.



WARNING: Do not remove the filler cap when the engine is running.

Do not use supplemental engine oil additives because they are unnecessary and could lead to engine damage that may not be covered by the vehicle Warranty.

Maintenance

Only use oils certified for gasoline engines by the American Petroleum Institute (API). An oil with this trademark symbol conforms to the current engine and emission system protection standards and fuel economy requirements of the International Lubricants Specification Advisory Committee (ILSAC).

To top up the engine oil level do the following:

1. Clean the area surrounding the engine oil filler cap before you remove it.
2. Remove the engine oil filler cap. See **Under Hood Overview** (page 265). Turn it counterclockwise and remove it.
3. Add engine oil that meets our specifications. See **Capacities and Specifications** (page 329). You may have to use a funnel to pour the engine oil into the opening.
4. Recheck the oil level.
5. If the oil level is correct, replace the dipstick and make sure it is fully seated.
6. Replace the engine oil filler cap. Turn it clockwise until you feel a strong resistance.

Note: Do not add oil further than the maximum mark. Oil levels above the maximum mark may cause engine damage. See your dealer if your oil level is continuously above the maximum mark.

Note: Make sure you install the oil filler cap correctly.

Note: Soak up any spillage with an absorbent cloth immediately.

CHANGING THE ENGINE AIR FILTER



WARNING: To reduce the risk of vehicle damage and personal burn injuries, do not start your engine with the air cleaner removed and do not remove it while the engine is running.

When changing the engine air filter, do not allow debris or foreign material to enter the air induction system. Engine components are susceptible to damage not covered by the vehicle Warranty.

Change the air filter element at the correct interval. See **Scheduled Maintenance** (page 416).

Incorrect component use can cause damage not covered by the vehicle Warranty. See **Motorcraft Parts** (page 326).

To replace the air filter element do the following:

Maintenance

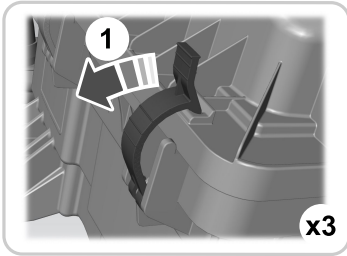
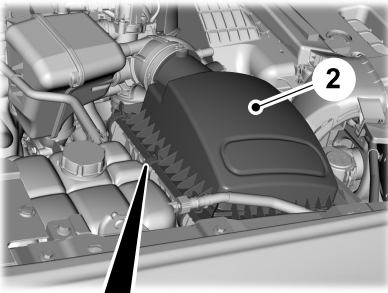

E276908

1. Remove the clips that secure the air filter housing cover.
2. Carefully lift the air filter housing cover.
3. Remove the air filter element from the air filter housing.
4. Wipe any dirt or debris from the air filter housing and cover to make sure no dirt gets in the engine and that you have a good seal.
5. Install a new air filter element. Be careful not to crimp the filter element edges between the air filter housing and cover. This could cause filter damage and allow unfiltered air to enter the engine if it is not properly seated.
6. Install the air filter housing cover.
7. Engage the clips to secure the air filter housing cover to the air filter housing.

OIL CHANGE INDICATOR RESET

Use the information display controls on the steering wheel to reset the oil change indicator.

From the main menu scroll to:

Message	Action and description
Settings	Press the right arrow button, then from this menu scroll to the following message.
Vehicle	Press the right arrow button, then from this menu scroll to the following message.
Oil Life	Press the right arrow button, then from this menu scroll to the following message.
Hold OK to Reset	Press and hold the OK button until the instrument cluster displays the following message. Reset Successful
	When the oil change indicator resets the instrument cluster displays 100%. Remaining Life {00}%
	If the instrument cluster displays one of the following messages, repeat the process. Not Reset Reset Cancelled

Maintenance

ENGINE COOLANT CHECK



WARNING: Do not remove the coolant reservoir cap when the engine is on or the cooling system is hot. Wait 10 minutes for the cooling system to cool down. Cover the coolant reservoir cap with a thick cloth to prevent the possibility of scalding and slowly remove the cap. Failure to follow this instruction could result in personal injury.



WARNING: Do not dispose of coolant in the household refuse or the public sewage system. Use an authorized waste disposal facility.



WARNING: Do not put coolant in the windshield washer reservoir. If sprayed on the windshield, coolant could make it difficult to see through the windshield.



WARNING: To reduce the risk of personal injury, make sure the engine is cool before unscrewing the coolant pressure relief cap. The cooling system is under pressure. Steam and hot liquid can come out forcefully when you loosen the cap slightly.

When the engine is cold, check the concentration and level of the coolant at the intervals listed in the scheduled maintenance information. See **Scheduled Maintenance** (page 416).

Note: Make sure that the coolant level is between the **MIN** and the **MAX** marks on the coolant reservoir.

Note: Coolant expands when it is hot. The level may extend beyond the **MAX** mark.

Maintain coolant concentration within 48% to 50%, which equates to a freeze point between -29°F (-34°C) and -35°F (-37°C). Coolant concentration should be checked using a refractometer. We do not recommend the use of hydrometers or coolant test strips for measuring coolant concentration.

Adding Coolant



WARNING: Do not remove the coolant reservoir cap when the engine is on or the cooling system is hot. Wait 10 minutes for the cooling system to cool down. Cover the coolant reservoir cap with a thick cloth to prevent the possibility of scalding and slowly remove the cap. Failure to follow this instruction could result in personal injury.



WARNING: Do not allow the fluid to touch your skin or eyes. If this happens, rinse the affected areas immediately with plenty of water and contact your physician.



WARNING: Do not add coolant further than the **MAX** mark.

Note: Automotive fluids are not interchangeable. Take care not to put engine coolant in the windshield washer fluid reservoir or windshield washer fluid in the engine coolant reservoir.

Note: Do not use stop leak pellets, cooling system sealants, or non-specified additives as they can cause damage to the engine cooling or heating systems. Resulting component damage may not be covered by the vehicle Warranty.

Maintenance

It is very important to use prediluted coolant approved to the correct specification in order to avoid plugging the small passageways in the engine cooling system. See **Capacities and Specifications** (page 325). Do not mix different colors or types of coolant in your vehicle. Mixing of engine coolants or using an incorrect coolant may harm the engine or cooling system components and may not be covered by the vehicle Warranty.

Note: *If prediluted coolant is not available, use the approved concentrated coolant diluting it to 50/50 with deionized or distilled water. See **Capacities and Specifications** (page 325). Using water that has not been deionised may contribute to deposit formation, corrosion and plugging of the small cooling system passageways.*

Note: *Coolants marketed for all makes and models may not be approved to our specifications and may cause damage to the cooling system. Resulting component damage may not be covered by the vehicle Warranty.*

If the coolant level is at or below the minimum mark, add prediluted coolant immediately.

To top up the coolant level do the following:

1. Unscrew the cap slowly. Any pressure escapes as you unscrew the cap.
2. Add prediluted coolant approved to the correct specification. See **Capacities and Specifications** (page 325).
3. Add enough prediluted coolant to reach the correct level.
4. Replace the coolant reservoir cap. Turn the cap clockwise until it contacts the hard stop.

5. Check the coolant level in the coolant reservoir the next few times you drive your vehicle. If necessary, add enough prediluted engine coolant to bring the coolant level to the correct level.

If you have to add more than 1.1 qt (1 L) of engine coolant per month, have your vehicle checked as soon as possible. Operating an engine with a low level of coolant can result in engine overheating and possible engine damage.

In case of emergency, you can add a large amount of water without engine coolant in order to reach a vehicle service location. In this instance, qualified personnel:

1. Must drain the cooling system.
2. Chemically clean the coolant system.
3. Refill with engine coolant as soon as possible.

Water alone, without engine coolant, can cause engine damage from corrosion, overheating or freezing.

Do not use the following as a coolant substitute:

- Alcohol.
- Methanol.
- Brine.
- Any coolant mixed with alcohol or methanol antifreeze.

Alcohol and other liquids can cause engine damage from overheating or freezing.

Do not add extra inhibitors or additives to the coolant. These can be harmful and compromise the corrosion protection of the coolant.

Recycled Coolant

We do not recommend the use of recycled coolant as an approved recycling process is not yet available.

Maintenance

Dispose of used engine coolant in an appropriate manner. Follow your community's regulations and standards for recycling and disposing of automotive fluids.

Severe Climates

If you drive in extremely cold climates:

- It may be necessary to increase the coolant concentration above 50%.
- A coolant concentration of 60% provides improved freeze point protection. Coolant concentrations above 60% decrease the overheat protection characteristics of the coolant and may cause engine damage.

If you drive in extremely hot climates:

- You can decrease the coolant concentration to 40%.
- Coolant concentrations below 40% decrease the freeze and corrosion protection characteristics of the coolant and may cause engine damage.

Vehicles driven year-round in non-extreme climates should use prediluted coolant for optimum cooling system and engine protection.

Coolant Change

At specific mileage intervals, as listed in the scheduled maintenance information, the coolant should be changed. Add prediluted coolant approved to the correct specification. See **Capacities and Specifications** (page 325).

Fail-Safe Cooling

Fail-safe cooling allows you to temporarily drive your vehicle before any incremental component damage occurs. The fail-safe distance depends on ambient temperature, vehicle load and terrain.

How Fail-Safe Cooling Works



If the engine begins to overheat, the coolant temperature gauge moves toward the red zone:



A warning lamp illuminates and a message may appear in the information display.

If the engine reaches a preset over-temperature condition, the engine automatically switches to alternating cylinder operation. Each disabled cylinder acts as an air pump and cools the engine.

When this occurs, your vehicle still operates, however:

- Engine power is limited.
- The air conditioning system turns off.

Continued operation increases the engine temperature, causing the engine to completely shut down. Your steering and braking effort increases in this situation.

When the engine temperature cools, you can re-start the engine. Have your vehicle checked as soon as possible to minimize engine damage.

When Fail-Safe Mode Is Activated



WARNING: Fail-safe mode is for use during emergencies only. Operate your vehicle in fail-safe mode only as long as necessary to bring your vehicle to rest in a safe location and seek immediate repairs. When in fail-safe mode, your vehicle will have limited power, will not be able to maintain high-speed operation, and may completely shut down without warning, potentially losing engine power, power steering assist, and power brake assist, which may increase the possibility of a crash resulting in serious injury.

Maintenance



WARNING: Do not remove the coolant reservoir cap when the engine is on or the cooling system is hot. Wait 10 minutes for the cooling system to cool down. Cover the coolant reservoir cap with a thick cloth to prevent the possibility of scalding and slowly remove the cap. Failure to follow this instruction could result in personal injury.

Your vehicle has limited engine power when in the fail-safe mode, drive your vehicle with caution. Your vehicle does not maintain high-speed operation and the engine may operate poorly.

Remember that the engine is capable of automatically shutting down to prevent engine damage. In this situation:

1. Pull off the road as soon as safely possible and switch the engine off.
2. If you are a member of a roadside assistance program, we recommend that you contact your roadside assistance service provider.
3. If this is not possible, wait a short period for the engine to cool.
4. Check the coolant level. If the coolant level is at or below the minimum mark, add prediluted coolant immediately.
5. When the engine temperature cools, you can re-start the engine. Have your vehicle checked as soon as possible to minimize engine damage.

Note: *Driving your vehicle without repair increases the chance of engine damage.*

Engine Coolant Temperature Management (If Equipped)



WARNING: To reduce the risk of crash and injury, be prepared that the vehicle speed may reduce and the vehicle may not be able to accelerate with full power until the coolant temperature reduces.

If you tow a trailer with your vehicle, the engine may temporarily reach a higher temperature during severe operating conditions, for example ascending a long or steep grade in high ambient temperatures.

At this time, you may notice the coolant temperature gauge moves toward the red zone and a message may appear in the information display.

You may notice a reduction in vehicle speed caused by reduced engine power in order to manage the engine coolant temperature. Your vehicle may enter this mode if certain high-temperature and high-load conditions take place. The amount of speed reduction depends on vehicle loading, grade and ambient temperature. If this occurs, there is no need to stop your vehicle. You can continue to drive.

The air conditioning may automatically turn on and off during severe operating conditions to protect the engine from overheating. When the coolant temperature decreases to the normal operating temperature, the air conditioning turns on.

If the coolant temperature gauge moves fully into the red zone, or if the coolant temperature warning or service engine soon messages appear in your information display, do the following:

Maintenance

1. Stop your vehicle as soon as it is safe to do so. Fully apply the parking brake, shift into park (P) or neutral (N).
2. Leave the engine running until the coolant temperature gauge needle returns to the normal position. If the temperature does not drop after several minutes, follow the remaining steps.
3. Switch the engine off and wait for it to cool. Check the coolant level.
4. If the coolant level is at or below the minimum mark, add prediluted coolant immediately.
5. If the coolant level is normal, restart the engine and continue.

AUTOMATIC TRANSMISSION FLUID CHECK

Note: *Transmission fluid should be checked by an authorized dealer. If required, fluid should be added by an authorized dealer.*

Have an authorized dealer check and change the transmission fluid at the correct service interval. See **Maintenance** (page 263). Your transmission does not consume fluid. However, the fluid level should be checked if the transmission is not working properly, (i.e., if the transmission slips or shifts slowly) or if you notice some sign of fluid leakage.

Do not use supplemental transmission fluid additives, treatments or cleaning agents. The use of these materials may affect transmission operation and result in damage to internal transmission components.

BRAKE FLUID CHECK



WARNING: Do not use any fluid other than the recommended brake fluid as this will reduce brake efficiency. Use of incorrect fluid could result in the loss of vehicle control, serious personal injury or death.



WARNING: Only use brake fluid from a sealed container. Contamination with dirt, water, petroleum products or other materials may result in brake system damage or failure. Failure to adhere to this warning could result in the loss of vehicle control, serious personal injury or death.



WARNING: Do not allow the fluid to touch your skin or eyes. If this happens, rinse the affected areas immediately with plenty of water and contact your physician.



WARNING: The brake system could be affected if the brake fluid level is below the **MIN** mark or above the **MAX** mark on the brake fluid reservoir.

Maintenance



1. Park your vehicle on a level surface.
2. Look at the brake fluid reservoir to see where the brake fluid level is relative to the **MIN** and the **MAX** marks on the reservoir.

Note: If the brake fluid level is between the **MIN** and the **MAX** marks on the reservoir, it is acceptable.

Note: If the brake fluid level is below the **MIN** mark or above the **MAX** mark, have your vehicle checked as soon as possible.

Note: To avoid fluid contamination, the reservoir cap must remain in place and fully tight, unless you are adding fluid.

Only use fluid that meets our specifications. See **Capacities and Specifications** (page 325).

Brake Fluid Service Interval

Brake fluid absorbs water over time which degrades the effectiveness of the brake fluid. Change the brake fluid at the specified intervals to prevent degraded braking performance.

For detailed interval information, see Scheduled Maintenance in your Owner's Manual or your local maintenance guide.

POWER STEERING FLUID CHECK

Your vehicle is equipped with an electric power steering (EPS) system. There is no fluid reservoir to check or fill.

FUEL FILTER

Your vehicle is equipped with a lifetime fuel filter that is integrated with the fuel tank. Regular maintenance or replacement is not needed.

CHARGING THE 12V BATTERY

Battery Management System (If Equipped)

The battery management system monitors battery conditions and takes actions to extend battery life. If excessive battery drain is detected, the system may temporarily disable certain electrical features to protect the battery. Those electrical accessories affected include the rear defrost, heated/cooled seats, climate control fan, heated steering wheel, audio and navigation system. A message may be shown in the information displays to alert the driver that battery protection actions are active. These messages are only for notification that an action is taking place, and not intended to indicate an electrical problem or that the battery requires replacement.

Maintenance

Electrical accessory installation

Note: Charging and replacing the battery requires the driver power window to be re-initialized. See **Windows and Mirrors** (page 83).

To ensure proper operation of the Battery Management System, any electrical devices that are added to your vehicle should not have their ground connection made directly at the negative battery post.

A connection at the negative battery terminal can cause inaccurate measurements of the battery condition and potential incorrect system operation.

When a battery replacement is required, you must use a recommended replacement battery that matches the electrical requirements of the vehicle.

After battery replacement, or in some cases after charging the battery with the external charger, the Battery Management System requires eight hours of vehicle sleep time (key off with doors closed) to relearn the new battery state of charge. Prior to relearning the state of charge, the Battery Management System may disable electrical features (to protect the battery) earlier than normal.

CHANGING THE 12V BATTERY



WARNING: Batteries normally produce explosive gases which can cause personal injury. Therefore, do not allow flames, sparks or lighted substances to come near the battery. When working near the battery, always shield your face and protect your eyes. Always provide correct ventilation.



WARNING: When lifting a plastic-cased battery, excessive pressure on the end walls could cause acid to flow through the vent caps, resulting in personal injury and damage to the vehicle or battery. Lift the battery with a battery carrier or with your hands on opposite corners.



WARNING: Keep batteries out of reach of children. Batteries contain sulfuric acid. Avoid contact with skin, eyes or clothing. Shield your eyes when working near the battery to protect against possible splashing of acid solution. In case of acid contact with skin or eyes, flush immediately with water for a minimum of 15 minutes and get prompt medical attention. If acid is swallowed, call a physician immediately.



WARNING: Battery posts, terminals and related accessories contain lead and lead compounds. Wash hands after handling.



WARNING: This vehicle may have more than one battery. Removing the battery cables from only one battery does not disconnect your vehicle electrical system. Make sure you disconnect the battery cables from all batteries when disconnecting power. Failure to do so may cause serious personal injury or property damage.



WARNING: For vehicles with Auto-Start-Stop the battery requirement is different. You must replace the battery with one of exactly the same specification.

The battery is located in the engine compartment. See **Under Hood Overview** (page 265).

Maintenance

Your vehicle has a maintenance-free battery. It does not require additional water during service.

If your vehicle battery has a cover, make sure you correctly install it after cleaning or replacing the battery.

For longer, trouble-free operation, keep the top of the battery clean and dry and the battery cables tightly fastened to the battery terminals. If any corrosion is present on the battery or terminals, remove the cables from the terminals and clean with a wire brush. You can neutralize the acid with a solution of baking soda and water.

We recommend that you disconnect the negative battery cable terminal from the battery if you plan to store your vehicle for an extended period.

To maintain correct operation of the battery management system, if you add any electrical devices to your vehicle, do not connect the ground connection directly to the negative battery terminal. A connection at the negative battery terminal can cause inaccurate measurements of the battery condition and potential incorrect system operation.

Note: *Electrical accessories or components added to your vehicle by you or an authorized dealer, may adversely affect battery performance, durability and the performance of other electrical systems on your vehicle.*

If a replacement battery is required, we recommend you use a Ford replacement battery that matches the electrical requirements of your vehicle.

If you disconnect or replace the battery and your vehicle has an automatic transmission, transmission must relearn its adaptive strategy. Because of this, the transmission may shift firmly when first driven. This is normal operation while the transmission fully updates its operation to optimum shift feel.

Remove and Reinstall the Battery

To disconnect or remove the battery, do the following:

1. Apply the parking brake and switch the ignition off.
2. Switch all electrical equipment off, for example lights and radio.
3. Wait a minimum of two minutes before disconnecting the battery.

Note: *The engine management system has a power hold function and remains powered for a period after you switch the ignition off. This is to allow diagnostic and adaptive tables to be stored. Disconnecting the battery without waiting can cause damage not covered by the vehicle Warranty.*

4. Disconnect the negative (-) battery cable terminal first.
5. Disconnect the positive (+) battery cable terminal last.
6. Remove the battery securing clamp.
7. Remove the battery.
8. Install in the reverse order.

Note: *Before reconnecting the battery, make sure the ignition remains switched off.*

Note: *If you only disconnect the negative battery cable terminal, make sure it is isolated or placed away from the battery terminal to avoid un-intended connection or arcing.*

Note: *Make sure the battery cable terminals are fully tightened.*

Maintenance

Note: If you disconnect or replace the battery, you must reset the clock and the pre-set radio stations once the battery is reconnected.

Battery Disposal



Make sure that you dispose of old batteries in an environmentally friendly way.

Seek advice from your local authority about recycling old batteries.

WASHER FLUID CHECK



WARNING: If you operate your vehicle in temperatures below 40°F (5°C), use washer fluid with antifreeze protection. Failure to use washer fluid with antifreeze protection in cold weather could result in impaired windshield vision and increase the risk of injury or accident.

Add fluid to fill the reservoir if the level is low. Only use a washer fluid that meets Ford specifications. See **Capacities and Specifications** (page 325).

State or local regulations on volatile organic compounds may restrict the use of methanol, a common windshield washer antifreeze additive. Washer fluids containing non-methanol antifreeze agents should be used only if they provide cold weather protection without damaging the vehicle's paint finish, wiper blades or washer system.

CHECKING THE WIPER BLADES



E222238

Run the tip of your fingers over the edge of the blade to check for roughness.

Clean the wiper blades with isopropyl alcohol or windshield washer concentrate.

CHANGING THE WIPER BLADES

Changing the Windshield Wiper Blades

Note: The windshield wiper blades are different in length.

Note: If you install wiper blades of the wrong length, the wiper blades can clash damaging the wiper system.



E279824

Maintenance

1. Pull the wiper blade and arm away from the glass.

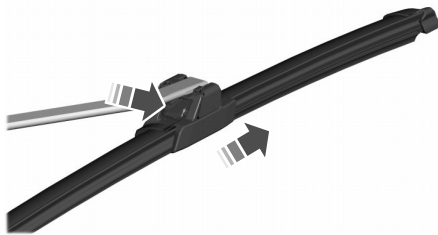

E279825

2. Squeeze the blade's lock pin and tab on the bottom of the arm to release the wiper blade.
3. Slide the blade out to remove it from the arm hook.
4. Install in the reverse order.

Note: Make sure that the wiper blade locks into place.

ADJUSTING THE HEADLAMPS

Vertical Aim Adjustment

If your vehicle has been involved in a crash, have the aim of the headlamp beam checked by an authorized dealer.

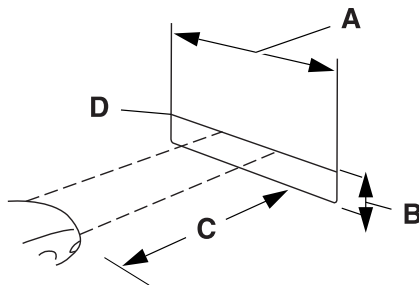

- A 8 ft (2.4 m)
- B Ground to the center of the headlamp high beam bulb
- C 25 ft (7.6 m)
- D Horizontal reference line

Vertical Aim Adjustment Procedure

1. Park your vehicle on level ground approximately 25 ft (7.6 m) from a wall or screen.
2. Measure the distance from the ground to the center of the headlamp high beam bulb and mark an 8 ft (2.4 m) long horizontal reference line on the wall or screen at this height.

Note: There may be an identifying mark on the lens to help you locate the center line of the headlamp high beam bulb. Refer to the graphic below step 4.

Note: To see a clearer light pattern for adjusting, you may want to block the light from one headlamp while adjusting the other.

3. Switch on the low beam headlamps and open the hood.

Maintenance



4. On the wall or screen you will observe a flat zone of high intensity light located at the top of the beam pattern. If the top edge of the flat zone of high intensity light is not on the horizontal reference line, adjust the aim of the headlamp beam.

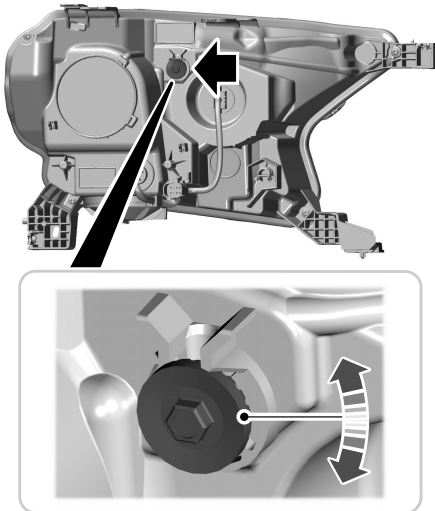

E284602

5. Use a suitable tool, for example a screwdriver or socket wrench, to turn the adjuster clockwise or counterclockwise to adjust the vertical aim of the headlamp. The horizontal edge of the brighter light should touch the horizontal reference line.
6. Close the hood and switch off the lamps.

REMOVING A HEADLAMP

Contact an authorized dealer.

CHANGING A BULB

Replacing the Headlamp Bulbs

Note: Do not touch the bulb glass.

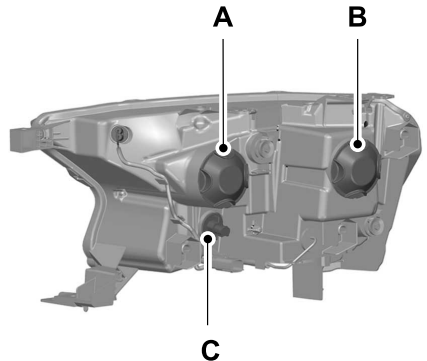

E284568

Headlamp assembly:

- A. High beam bulb.
- B. Low beam bulb.
- C. Front park and direction indicator bulb.

Maintenance

Replacing the High Beam Headlamp Bulb

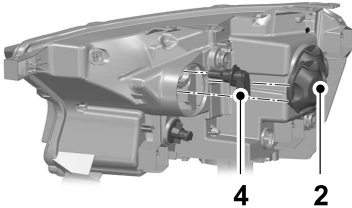

E284569

1. Make sure the lamps are off.
2. With the hood open, locate and carefully remove the cover.
3. Disconnect the electrical connector.
4. Turn the bulb counterclockwise and remove it.
5. Install the new bulb in reverse order.

Replacing the Low Beam Headlamp Bulb

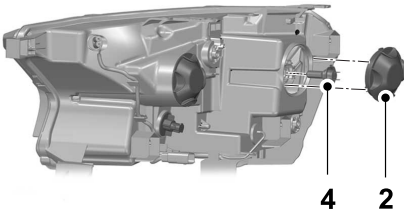

E284581

1. Make sure the lamps are off.
2. With the hood open, locate and carefully remove the cover.
3. Disconnect the electrical connector.
4. Turn the bulb counterclockwise and remove it.

5. Install the new bulb in reverse order.

Replacing the Front Park and Direction Indicator Bulb

1. Make sure the lamps are off.
2. Turn the bulb holder counterclockwise and remove it.
3. Remove the bulb by pulling it straight out.
4. Install the new bulb in reverse order.

Replacing LED Headlamp Bulbs

All bulbs in this assembly except for the direction indicator bulb are LED. If an LED fails have your vehicle checked as soon as possible. Contact an authorized dealer.

Front Side Marker Bulb

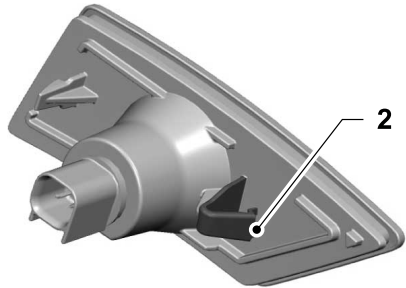

1. Make sure the lamps are off.
2. Remove the lamp from the wheel lip molding by releasing the clip.
3. Turn the bulb holder counterclockwise and remove it.
4. Remove the bulb by pulling it straight out.
5. Install the new bulb in reverse order.

Maintenance

Approach Lamp and Side Direction Indicator (If Equipped)

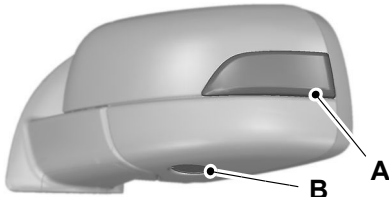

E133683

- A Side direction indicator.
- B Approach lamp.

If an LED fails have your vehicle checked as soon as possible. Contact an authorized dealer.

Front Fog Lamps

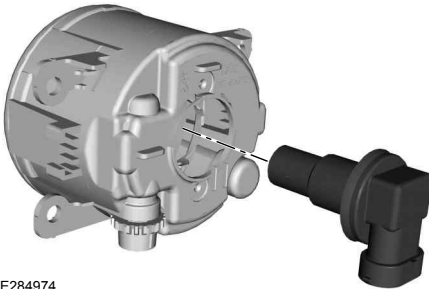

E284974

1. Make sure the lamps are off.
2. To access the bulb, reach behind the bumper.
3. Disconnect the electrical connector.
4. Turn the bulb counterclockwise and remove it.
5. Install the new bulb in reverse order.

Note: You cannot separate the bulb from the bulb holder.

Replacing LED Fog Lamp Bulbs (If Equipped)

If an LED fails have your vehicle checked as soon as possible. Contact an authorized dealer.

Rear Lamps

Type 1

Tail, Brake, Reversing, and Direction Indicator

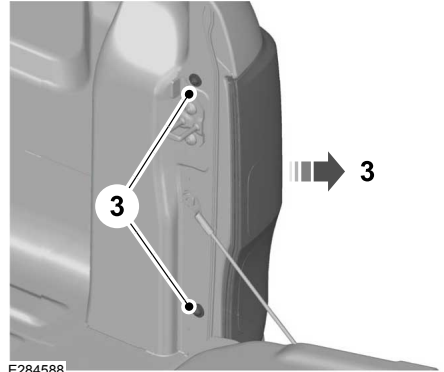

E284588

Maintenance

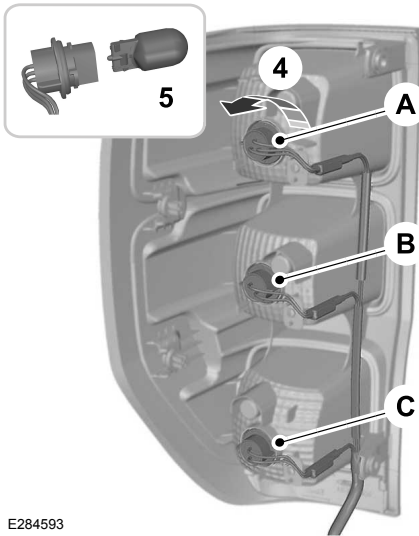

E284593

- A Brake and rear park bulb.
- B Rear direction indicator bulb.
- C Reverse lamp bulb.

1. Make sure the lamps are off.
2. Open the tailgate to access the rear lamp assemblies.
3. Remove the two bolts from the tail lamp assembly. Then, carefully pull the lamp assembly from the tailgate pillar by releasing the two retaining tabs.
4. Turn the bulb holder counterclockwise and remove it.
5. Remove the bulb by pulling it straight out.
6. Install the new bulb in reverse order.

Replacing LED Brake, Rear, Direction Indicator and Reverse Lamp Bulbs

If an LED fails have your vehicle checked as soon as possible. Contact an authorized dealer.

Type 2

Tail, Brake, Reversing Lamp and Direction Indicator

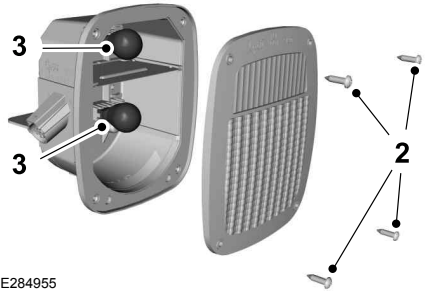

E284955

1. Make sure the lamps are off.
2. Undo the screws to remove the outer lens and access the bulbs.
3. Remove the bulb by pulling it straight out.
4. Install the new bulb in reverse order.

Maintenance

License Plate Lamp

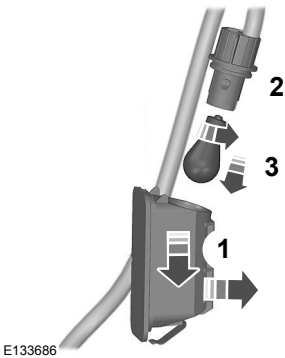

1. Make sure the lamps are off.
2. Use a screwdriver to carefully remove the lamp from the rear bumper.
3. Turn the bulb holder counterclockwise and remove it.
4. Remove the bulb by pulling it straight out.
5. Install the new bulb in reverse order.

3. Remove the bulb socket by rotating it counterclockwise and pulling it out of the lamp assembly.
4. Pull the bulb straight out of the socket.
5. Install the new bulb in reverse order.

Replacing LED Cargo Lamp and High-mount Brake Lamp Bulbs

If an LED fails have your vehicle checked as soon as possible. Contact an authorized dealer.

Central High Mounted Brake Lamp

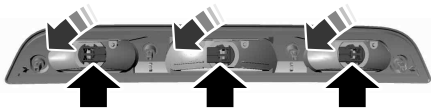

1. Make sure the lamps are off.
2. Remove the four screws and move the lamp assembly away from the vehicle to expose the bulb sockets.

Vehicle Care

GENERAL INFORMATION

Your dealer has many quality products available to clean your vehicle and protect its finishes.

CLEANING PRODUCTS

Materials

For best results, use the following products or products of equivalent quality:

For additional information and assistance, we recommend that you contact an authorized dealer.

Name	Specification
Motorcraft® Bug and Tar Remover, ZC-42 (U.S. & Canada)	
Motorcraft® Custom Bright Metal Cleaner, ZC-15 (U.S. & Canada)	ESR-M5B194-B
Motorcraft® Detail Wash, ZC-3-A (U.S. & Canada)	ESR-M14P4-A
Motorcraft® Engine Shampoo and Degreaser, ZC-20 (U.S.)	ESR-M14P3-A
Motorcraft® Engine Shampoo, CXC-66-A (Canada)	
Motorcraft® Premium Leather and Vinyl Cleaner, ZC-56 (U.S. & Canada)	
Motorcraft® Multi-Purpose Cleaner, CXC-101 (Canada)	
Motorcraft® Premium Windshield Wash Concentrate with Bitterant, ZC-32-B2 (U.S.)	WSS-M14P19-A
Motorcraft® Premium Quality Windshield Washer Fluid, CXC-37-F/M (Canada)	WSS-M14P19-A
Motorcraft® Professional Strength Carpet & Upholstery Cleaner, ZC-54 (U.S. & Canada)	
Motorcraft® Premium Glass Cleaner, CXC-100 (Canada)	ESR-M14P5-A
Motorcraft® Spot and Stain Remover, ZC-14 (U.S.)	
Motorcraft® Ultra-Clear Spray Glass Cleaner, ZC-23 (U.S.)	ESR-M14P5-A
Motorcraft® Wheel and Tire Cleaner, ZC-37-A (U.S. & Canada)	

Vehicle Care

CLEANING THE EXTERIOR

Wash your vehicle regularly with cool or lukewarm water and a neutral pH shampoo, we recommend Motorcraft Detail Wash.

- Never use strong household detergents or soap, for example dish washing or laundry liquid. These products can discolor and spot painted surfaces.
- Never wash your vehicle when it is hot to the touch, or during strong or direct sunlight.
- Dry your vehicle with a chamois or soft terry cloth towel to eliminate water spotting.
- Immediately remove fuel spillages, bird droppings, insect deposits and road tar. These may cause damage to your vehicle's paintwork or trim over time. We recommend Motorcraft Bug and Tar Remover.
- Remove any exterior accessories, for example antennas, before entering a car wash.
- When filling with AdBlue®, remove any residue on painted surfaces immediately.

Note: *Suntan lotions and insect repellents can damage painted surfaces. If these substances come in contact with your vehicle, wash the affected area as soon as possible.*

Cleaning the Exterior Precautions

Immediately remove fuel spillages, AdBlue residuals, bird droppings, insect deposits and road tar. These may cause damage to your vehicle's paintwork or trim over time.

Remove any exterior accessories, for example antennas, before entering a car wash.

Cleaning the Exterior Lamps

Note: *Do not scrape the exterior lamps lenses or use abrasives, alcoholic solvents or chemical solvents to clean them.*

Note: *Do not wipe the exterior lamps when they are dry.*

Exterior Chrome Parts

- Apply a high quality-cleaning product to bumpers and other chrome parts. Follow the manufacturer's instructions. We recommend Motorcraft Custom Bright Metal Cleaner.
- Do not apply the cleaning product to hot surfaces. Do not leave the cleaning product on chrome surfaces longer than the time recommended.
- Using non-recommended cleaners can result in severe and permanent cosmetic damage.

Note: *Never use abrasive materials, for example steel wool or plastic pads as they can scratch the chrome surface.*

Note: *Do not use chrome cleaner, metal cleaner or polish on wheels or wheel covers.*

Exterior Plastic Parts

For routine cleaning we recommend Motorcraft Detail Wash. If tar or grease spots are present, we recommend Motorcraft Bug and Tar Remover.

Stripes or Graphics (If Equipped)

Hand washing your vehicle is preferred however, pressure washing may be used under the following conditions:

- Do not use water pressure higher than 2,000 psi (14,000 kPa).
- Do not use water hotter than 179°F (82°C).

Vehicle Care

- Use a spray with a 40 degree wide spray angle pattern.
- Keep the nozzle at a 12 in (305 mm) distance and 90 degree angle to your vehicle's surface.

Note: *Holding the pressure washer nozzle at an angle to the vehicle's surface may damage graphics and cause the edges to peel away from the vehicle's surface.*

Underbody

Regularly clean the entire underside of your vehicle. This includes the chassis, body floor sheet metal and wheel wells using fresh water. Keep body and door drain holes free of debris or foreign material.

Under Hood

For removing black rubber marks from under the hood we recommend Motorcraft Wheel and Tire Cleaner or Motorcraft Bug and Tar Remover.

WAXING

Regular waxing is necessary to protect your car's paint from the elements. We recommend that you wash and wax the painted surface once or twice a year.

When washing and waxing, park your vehicle in a shaded area out of direct sunlight. Always wash your vehicle before applying wax.

- Use a quality wax that does not contain abrasives.
- Follow the manufacturer's instructions to apply and remove the wax.
- Apply a small amount of wax in a back-and-forth motion, not in circles.

- Do not allow wax to come in contact with any non-body (low-gloss black) colored trim. The wax will discolor or stain the parts over time.
 - Roof racks.
 - Bumpers.
 - Grained door handles.
 - Side moldings.
 - Mirror housings.
 - Windshield cowl area.
- Do not apply wax to glass areas.
- After waxing, your car's paint should feel smooth, and be free of streaks and smudges.

CLEANING THE ENGINE

Engines are more efficient when they are clean because grease and dirt buildup keep the engine warmer than normal.

When washing:

- Take care when using a power washer to clean the engine. The high-pressure fluid could penetrate the sealed parts and cause damage.
- Do not spray a hot engine with cold water to avoid cracking the engine block or other engine components.
- Spray Motorcraft Engine Shampoo and Degreaser on all parts that require cleaning and pressure rinse clean. In Canada, use Motorcraft Engine Shampoo.

Note: *If your vehicle has an engine cover remove the cover before application of Motorcraft Engine Shampoo and Degreaser. Immediately rinse away any over spray.*

Vehicle Care

- Never wash or rinse the engine while it is hot or running; water in the running engine may cause internal damage.
- Never wash or rinse any ignition coil, spark plug wire or spark plug well, or the area in and around these locations.
- Cover the battery, power distribution box, and air filter assembly to prevent water damage when cleaning the engine.

CLEANING THE WINDOWS AND WIPER BLADES

Car wash chemicals and environmental fallout can result in windshield and wiper blade contamination. Dirty windshield and wipers will result in poor windshield wiper operation. Keep the windshield and wiper blades clean to maintain windshield wiper performance.

To clean the windshield and wiper blades:

- Clean the windshield with a non-abrasive glass cleaner. When cleaning the interior of the windshield, avoid getting any glass cleaner on the instrument panel or door panels. Wipe any glass cleaner off these surfaces immediately.
- For windshields contaminated with tree sap, chemicals, wax or bugs, clean the entire windshield using steel wool (no greater than 0000 grade) in a circular motion and rinse with water.
- Clean the wiper blades with isopropyl rubbing alcohol or windshield washer concentrate.

Note: *Do not use razor blades or other sharp objects to clean or remove decals from the inside of the heated rear window. The vehicle warranty does not cover damage caused to the heated rear window grid lines.*

CLEANING THE INTERIOR



WARNING: Do not use cleaning solvents, bleach or dye on the vehicle's seatbelts, as these actions may weaken the belt webbing.



WARNING: On vehicles equipped with seat-mounted airbags, do not use chemical solvents or strong detergents. Such products could contaminate the side airbag system and affect performance of the side airbag in a crash.

For fabric, carpets, cloth seats and seats equipped with side airbags:

- Remove dust and loose dirt with a vacuum cleaner.
- Remove light stains and soil with Motorcraft Professional Strength Carpet & Upholstery Cleaner.
- If grease or tar is present on the material, spot-clean the area first with Motorcraft Spot and Stain Remover. In Canada, use Motorcraft Multi-Purpose Cleaner.
- If a ring forms on the fabric after spot cleaning, clean the entire area immediately (but do not oversaturate) or the ring will set.
- Do not use household cleaning products or glass cleaners, which can stain and discolor the fabric and affect the flame retardant abilities of the seat materials.

Mirrors

Do not clean the housing or glass of any mirror with harsh abrasives, fuel or other petroleum or ammonia-based cleaning products.

Vehicle Care

CLEANING THE INSTRUMENT PANEL AND INSTRUMENT CLUSTER LENS



WARNING: Do not use chemical solvents or strong detergents when cleaning the steering wheel or instrument panel to avoid contamination of the airbag system.

Note: Follow the same procedure as cleaning leather seats for cleaning leather instrument panels and leather interior trim surfaces. See **Cleaning Leather Seats** (page 288).

Clean the instrument panel and cluster lens with a clean, damp and soft cloth, then use a clean, dry and soft cloth to dry these areas.

- Avoid cleaners or polishes that increase the gloss of the upper portion of the instrument panel. The dull finish in this area helps protect you from undesirable windshield reflection.
- Do not use any household cleaning products or glass cleaners as these may damage the finish of the instrument panel, interior trim and cluster lens.
- Wash or wipe your hands clean if you have been in contact with certain products such as insect repellent and suntan lotion to avoid possible damage to the interior painted surfaces.
- Do not allow air fresheners and hand sanitizers to spill onto interior surfaces. If a spill occurs, wipe off immediately. Your warranty may not cover these damages.

If a staining liquid like coffee or juice has been spilled on the instrument panel or on interior trim surfaces:

1. Wipe up spilled liquid using a clean, soft cloth as quickly as possible.
2. Use Motorcraft Premium Leather and Vinyl Cleaner or a commercially available leather cleaning product for automotive interiors. Test any cleaner or stain remover on an inconspicuous area.
3. Alternatively, wipe the surface with a clean, soft cloth and a mild soap and water solution. Dry the area with a clean, soft cloth.
4. If necessary, apply more soap and water solution or cleaning product to a clean, soft cloth and press it onto the soiled area. Allow this to set at room temperature for 30 minutes.
5. Remove the soaked cloth, then with a clean, damp cloth, use a rubbing motion for 60 seconds on the soiled area.
6. Dry the area with a clean, soft cloth.

CLEANING LEATHER SEATS

Note: Follow the same procedure as cleaning leather seats for cleaning leather instrument panels and leather interior trim surfaces.

For routine cleaning, wipe the surface with a soft, damp cloth and a mild soap and water solution. Dry the area with a clean, soft cloth.

For cleaning and removing stains such as dye transfer, use Motorcraft Premium Leather and Vinyl Cleaner or a commercially available leather cleaning product for automotive interiors.

Note: Test any cleaner or stain remover on an inconspicuous area.

Vehicle Care

You should:

- Remove dust and loose dirt with a vacuum cleaner.
- Clean and treat spills and stains as soon as possible.

Do not use the following products as these may damage the leather:

- Oil and petroleum or silicone-based leather conditioners.
- Household cleaners.
- Alcohol solutions.
- Solvents or cleaners intended specifically for rubber, vinyl and plastics.

REPAIRING MINOR PAINT DAMAGE

We recommend that you contact an authorized dealer to identify your vehicle color code. Authorized dealers have touch-up paint to match your vehicle's color.

Before repairing minor paint damage, use a cleaner to remove particles such as bird droppings, tree sap, insect deposits, tar spots, road salt and industrial fallout.

Read the instructions before using cleaning products.

CLEANING THE WHEELS

1. Regularly clean them with a wheel cleaner. We recommend that you use Ford approved wheel cleaner if available.
2. Remove dirt and brake dust with a sponge.
3. Remove tar and grease with a bug and tar remover. We recommend that you use Ford approved bug and tar remover if available.

4. Thoroughly rinse the wheels with water after cleaning.

If you intend on parking your vehicle for an extended period after cleaning the wheels with a wheel cleaner, drive your vehicle for a few minutes before doing so. This reduces the risk of corrosion of the brake discs, brake pads and linings.

Do not clean the wheels when they are hot.

Note: *Some car washes could damage wheel rims and covers.*

Note: *Using non-recommended cleaners, harsh cleaning products, chrome wheel cleaners or abrasive materials could damage wheel rims, covers and bolts.*

VEHICLE STORAGE

If you plan on storing your vehicle for 30 days or more, read the following maintenance recommendations to make sure your vehicle stays in good operating condition.

We engineer and test all motor vehicles and their components for reliable, regular driving. Under various conditions, long-term storage may lead to degraded engine performance or failure unless you use specific precautions to preserve engine components.

General

- Store all vehicles in a dry, ventilated place.
- Protect from sunlight, if possible.
- If vehicles are stored outside, they require regular maintenance to protect against rust and damage.

Vehicle Care

Body

- Wash your vehicle thoroughly to remove dirt, grease, oil, tar or mud from exterior surfaces, rear-wheel housing and the underside of front fenders.
- Periodically wash your vehicle if it is stored in exposed locations.
- Touch-up exposed or primed metal to prevent rust.
- Cover chrome and stainless steel parts with a thick coat of auto wax to prevent discoloration. Re-wax as necessary when you wash your vehicle.
- Lubricate all hood, door and luggage compartment hinges and latches with a light grade oil.
- Cover interior trim to prevent fading.
- Keep all rubber parts free from oil and solvents.

Engine

- Change the engine oil and filter prior to storage because used engine oil contains contaminants which may cause engine damage.
- Start the engine every 15 days for a minimum of 15 minutes. Run at fast idle with the climate controls set to defrost until the engine reaches normal operating temperature.
- With your foot on the brake, shift through all the gears while the engine is running.
- We recommend that you change the engine oil before you use your vehicle again.

Fuel system

- Fill the fuel tank with high-quality fuel until the first automatic shutoff of the fuel pump nozzle.

Cooling system

- Protect against freezing temperatures.
- When removing your vehicle from storage, check coolant fluid level. Confirm that there are no cooling system leaks and that fluid is at the recommended level.

Disconnecting Your 12 Volt Battery

- Check and recharge as necessary. Keep connections clean.
- If storing your vehicle for more than 30 days without recharging the battery, we recommend that you disconnect the battery cables to maintain battery charge for quick starting.

Note: *It is necessary to reset memory features if you disconnect the battery cables.*

Brakes

- Make sure the brakes and parking brake release fully.

Tires

- Maintain recommended air pressure.

Miscellaneous

- Make sure all linkages, cables, levers and pins under your vehicle are covered with grease to prevent rust.
- Move vehicles at least 25 ft (7.5 m) every 15 days to lubricate working parts and prevent corrosion.

Vehicle Care

Removing Vehicle From Storage

When your vehicle is ready to come out of storage, do the following:

- Wash your vehicle to remove any dirt or grease film build-up on window surfaces.
- Check windshield wipers for any deterioration.
- Check under the hood for any foreign material that may have collected during storage such as mice or squirrel nests.
- Check the exhaust for any foreign material that may have collected during storage.
- Check tire pressures and set tire inflation per the Tire Label.
- Check brake pedal operation. Drive your vehicle 15 ft (4.5 m) back and forth to remove rust build-up.
- Check fluid levels (including coolant, oil and gas) to make sure there are no leaks, and fluids are at recommended levels.
- If you remove the battery, clean the battery cable ends and check for damage.

Contact an authorized dealer if you have any concerns or issues.

Wheels and Tires

GENERAL INFORMATION

Notice to utility vehicle and truck owners



WARNING: Utility vehicles have a significantly higher rollover rate than other types of vehicles.



WARNING: Vehicles with a higher center of gravity (utility and four-wheel drive vehicles) handle differently than vehicles with a lower center of gravity (passenger cars). Avoid sharp turns, excessive speed and abrupt steering in these vehicles. Failure to drive cautiously increases the risk of losing control of your vehicle, vehicle rollover, personal injury and death.



WARNING: In a rollover crash, an unbelted person is significantly more likely to die than a person wearing a seatbelt.



WARNING: Do not become overconfident in the ability of four-wheel drive vehicles. Although a four-wheel drive vehicle may accelerate better than a two-wheel drive vehicle in low traction situations, it won't stop any faster than two-wheel drive vehicles. Always drive at a safe speed.

Utility vehicles and trucks handle differently than passenger cars in the various driving conditions that are encountered on streets, highways and off-road. Utility vehicles and trucks are not designed for cornering at speeds as high as passenger cars any more than low-slung sports cars are designed to perform satisfactorily under off-road conditions.

Study your owner's manual and any supplements for specific information about equipment features, instructions for safe driving and additional precautions to reduce the risk of an accident or serious injury.

Four-wheel drive system (If Equipped)

A vehicle equipped with four-wheel drive (when selected) has the ability to use all four wheels to power itself. This increases traction which could enable you to safely drive over terrain and road conditions that a conventional two-wheel drive vehicle cannot.

On some four-wheel drive models, the initial shift from two-wheel drive to four-wheel drive while the vehicle is moving can cause a momentary clunk and ratcheting sound. These sounds are normal as the front drivetrain comes up to speed and are not cause for concern.

Note: *In four-wheel drive vehicles, the size of the spare tire relative to the remaining tires can have an effect on the 4x4 system's ability to engage and disengage.*

Operating 4WD Vehicles with a Spare tire or Mismatched Tires

On four-wheel drive vehicles, the size of the spare tire can affect the 4X4 system. If there is a significant difference between the size of the spare tire and the remaining tires, the four-wheel drive functionality will be limited.

When driving with the full-size dissimilar spare wheel and tire assembly, we recommend that you do not:

- Exceed 50 mph (80 km/h) with 4WD mode turned on.
- Turn on a 4WD mode unless the vehicle is stationary.
- Use 4WD mode on dry pavement.

Wheels and Tires

When driving with the full-size dissimilar spare wheel and tire assembly, 4WD functionality could be limited, especially when driving in a mechanically locked 4WD mode. You could experience the following:

- Additional noise from the transfer case or other drive components.
- Difficulty shifting out of a mechanically locked 4WD mode.

Use of a dissimilar spare wheel and tire assembly could lead to impairment of the following:

- Comfort and noise.
- Winter weather driving capability.
- Wet driving capability.
- Four-wheel drive capability.

How your vehicle differs from other vehicles

Sport utility vehicles and trucks can differ from some other vehicles in a few noticeable ways. Your vehicle could be:

- Higher - to allow higher load carrying capacity and to allow it to travel over rough terrain without damaging underbody components.
- Shorter - to give it the capability to approach inclines and drive over the crest of a hill without damaging underbody components. All other things held equal, a shorter wheelbase could make your vehicle quicker to respond to steering inputs than a vehicle with a longer wheelbase.
- Narrower - to provide greater maneuverability in tight spaces, particularly in off-road use.

As a result of the above dimensional differences, Sport utility vehicles and trucks often will have a higher center of gravity and a greater difference in center of gravity between the loaded and unloaded condition. These differences that make your vehicle so versatile also make it handle differently than an ordinary passenger car.

TIRE CARE

Information About Uniform Tire Quality Grading



Tire Quality Grades apply to new pneumatic passenger car tires. The Quality grades can be found where applicable on the tire sidewall between tread shoulder and maximum section width. For example: **Treadwear 200 Traction AA Temperature A.**

These Tire Quality Grades are determined by standards that the United States Department of Transportation has set.

Wheels and Tires

Tire Quality Grades apply to new pneumatic passenger car tires. They do not apply to deep tread, winter-type snow tires, space-saver or temporary use spare tires, light truck or LT type tires, tires with nominal rim diameters of 10 to 12 inches or limited production tires as defined in Title 49 Code of Federal Regulations Part 575.104 (c)(2).

U.S. Department of Transportation Tire quality grades:

The U.S. Department of Transportation requires us to give you the following information about tire grades exactly as the government has written it.

Treadwear

The treadwear grade is a comparative rating based on the wear rate of the tire when tested under controlled conditions on a specified government test course. For example, a tire graded 150 would wear one and one-half (1 ½) times as well on the government course as a tire graded 100. The relative performance of tires depends upon the actual conditions of their use, however, and could depart significantly from the norm due to variations in driving habits, service practices, and differences in road characteristics and climate.

Traction AA A B C



WARNING: The traction grade assigned to this tire is based on straight-ahead braking traction tests, and does not include acceleration, cornering, hydroplaning or peak traction characteristics.

The traction grades, from highest to lowest are AA, A, B, and C. The grades represent the tire's ability to stop on wet pavement as measured under controlled conditions on specified government test surfaces of asphalt and concrete. A tire marked C could have poor traction performance.

Temperature A B C



WARNING: The temperature grade for this tire is established for a tire that is properly inflated and not overloaded. Excessive speed, underinflation, or excessive loading, either separately or in combination, can cause heat buildup and possible tire failure.

The temperature grades are A (the highest), B and C, representing the tire's resistance to the generation of heat and its ability to dissipate heat when tested under controlled conditions on a specified indoor laboratory

Wheels and Tires

test wheel. Sustained high temperature can cause the material of the tire to degenerate and reduce tire life, and excessive temperature can lead to sudden tire failure. The grade C corresponds to a level of performance which all passenger car tires must meet under the Federal Motor Vehicle Safety Standard No. 139. Grades B and A represent higher levels of performance on the laboratory test wheel than the minimum required by law.

Glossary of Tire Terminology

***Tire label:** A label showing the original equipment tire sizes, recommended inflation pressure and the maximum weight the vehicle can carry.

***Tire Identification Number (TIN):** A number on the sidewall of each tire providing information about the tire brand and manufacturing plant, tire size and date of manufacture. Also referred to as DOT code.

***Inflation pressure:** A measure of the amount of air in a tire.

***Standard load:** A class of P-metric or Metric tires designed to carry a maximum load at set pressure. For example: For P-Metric tires 35 psi (2.4 bar) and for Metric 36 psi (2.5 bar). Increasing the inflation pressure beyond this pressure will not increase the tire's load carrying capability.

***Extra load:** A class of P-metric or Metric tires designed to carry a heavier maximum load at 42 psi (2.9 bar). Increasing the inflation pressure beyond this pressure will not increase the tire's load carrying capability.

***kPa:** Kilopascal, a metric unit of air pressure.

***PSI:** Pounds per square inch, a standard unit of air pressure.

***Cold tire pressure:** The tire pressure when the vehicle has been stationary and out of direct sunlight for an hour or more and prior to the vehicle being driven for 1 mile (1.6 kilometers).

***Recommended inflation pressure:** The cold inflation pressure found on the Safety Compliance Certification Label (affixed to either the door hinge pillar, door-latch post, or the door edge that meets the door-latch post, next to the driver's seating position), or Tire Label located on the B-pillar or the edge of the driver's door.

Wheels and Tires

B-pillar: The structural member at the side of the vehicle behind the front door.

***Bead area of the tire:** Area of the tire next to the rim.

***Sidewall of the tire:** Area between the bead area and the tread.

***Tread area of the tire:** Area of the perimeter of the tire that contacts the road when mounted on the vehicle.

***Rim:** The metal support (wheel) for a tire or a tire and tube assembly upon which the tire beads are seated.

Information Contained on the Tire Sidewall

Both United States and Canada Federal regulations require tire manufacturers to place standardized information on the sidewall of all tires. This information identifies and describes the fundamental characteristics of the tire and also provides a U.S. DOT Tire Identification Number for safety standard certification and in case of a recall.

Information on P Type Tires

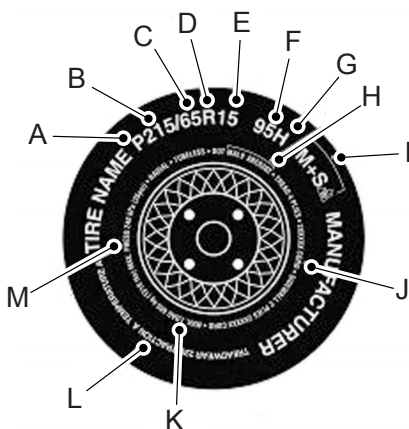

P215/65R15 95H is an example of a tire size, load index and speed rating. The definitions of these items are listed below. (Note that the tire size, load index and speed rating for your vehicle could be different from this example.)

A. **P:** Indicates a tire, designated by the Tire and Rim Association, that could be used for service on cars, sport utility vehicles, minivans and light trucks. **Note:** If your tire size does not begin with a letter this could mean it is designated by either the European Tire and Rim Technical Organization or the Japan Tire Manufacturing Association.

Wheels and Tires

B. 215: Indicates the nominal width of the tire in millimeters from sidewall edge to sidewall edge. In general, the larger the number, the wider the tire.

C. 65: Indicates the aspect ratio which gives the tire's ratio of height to width.

D. R: Indicates a radial type tire.

E. 15: Indicates the wheel or rim diameter in inches. If you change your wheel size, you will have to purchase new tires to match the new wheel diameter.

F. 95: Indicates the tire's load index. It is an index that relates to how much weight a tire can carry. You could find this information in your owner's manual. If not, contact a local tire dealer.

Note: *This information will not be included on all tires because it is not required by federal law.*

G. H: Indicates the tire's speed rating. The speed rating denotes the speed at which a tire is designed to be driven for extended periods of time under a standard condition of load and inflation pressure. The tires on your vehicle could operate at different conditions for load and inflation pressure. These speed ratings could need to be adjusted for the difference in conditions. The ratings range from 81 mph (130 km/h) to 186 mph (299 km/h). These ratings are listed in the following chart.

Note: *This information will not be included on all tires because it is not required by federal law.*

Letter rating	mph (km/h)
M	81 (130)
N	87 (140)
Q	99 (159)
R	106 (171)
S	112 (180)
T	118 (190)
U	124 (200)
H	130 (210)
V	149 (240)
W	168 (270)
Y	186 (299)

Note: *For tires with a maximum speed capability over 149 mph (240 km/h), tire manufacturers sometimes use the letters ZR. For those with a maximum speed capability over 186 mph (299 km/h), tire manufacturers always use the letters ZR.*

H. U.S. DOT Tire Identification Number: This begins with the letters DOT and indicates that the tire meets all federal standards. The next two numbers or letters are the plant code designating where it was manufactured, the next two are the tire size code and

Wheels and Tires

the last four numbers represent the week and year the tire was built. For example, the numbers 317 mean the 31st week of 1997. After 2000 the numbers go to four digits. For example, 2501 means the 25th week of 2001. The numbers in between are identification codes used for traceability. This information is used to contact customers if a tire defect requires a recall.

I. **M+S or M/S:** Mud and Snow, or

AT: All Terrain, or

AS: All Season.

J. **Tire Ply Composition and Material Used:** Indicates the number of plies or the number of layers of rubber-coated fabric in the tire tread and sidewall. Tire manufacturers also must indicate the ply materials in the tire and the sidewall, which include steel, nylon, polyester, and others.

K. **Maximum Load:** Indicates the maximum load in kilograms and pounds that can be carried by the tire (affixed to either the door hinge pillar, door-latch post, or the door edge that meets the door-latch post, next to the driver's seating position), or Tire Label located on the B-pillar or the edge of the driver's door.

L. **Treadwear, Traction and Temperature Grades:**

***Treadwear:** The treadwear grade is a comparative rating based on the wear rate of the tire when tested under controlled conditions on a specified government test course. For example, a tire graded 150 would wear 1½ times as well on the government course as a tire graded 100.

***Traction:** The traction grades, from highest to lowest are AA, A, B, and C. The grades represent the tire's ability to stop on wet pavement as measured under controlled conditions on specified government test surfaces of asphalt and concrete. A tire marked C could have poor traction performance.

***Temperature:** The temperature grades are A (the highest), B and C, representing the tire's resistance to the generation of heat and its ability to dissipate heat when tested under controlled conditions on a specified indoor laboratory test wheel.

M. **Maximum Inflation Pressure:** Indicates the tire manufacturers' maximum permissible pressure or the pressure at which the maximum load can be carried by the tire. This pressure is normally higher than the vehicle manufacturer's recommended cold inflation pressure which can be found on the Safety Compliance Certification Label (affixed to either the door hinge pillar,

Wheels and Tires

door-latch post, or the door edge that meets the door-latch post, next to the driver's seating position), or Tire Label located on the B-pillar or the edge of the driver's door. The cold inflation pressure should never be set lower than the recommended pressure on the vehicle label.

The tire suppliers could have additional markings, notes or warnings such as standard load or radial tubeless.

Additional Information Contained on the Tire Sidewall for LT Type Tires

Note: *Tire Quality Grades do not apply to this type of tire.*

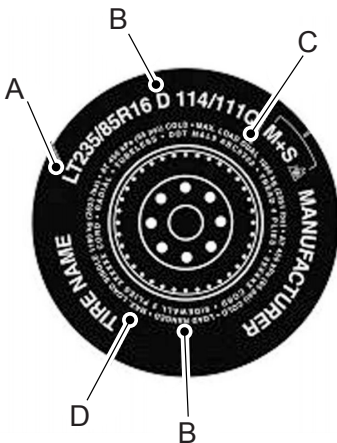

LT type tires have some additional information beyond those of P type tires. These differences are described below.

A. LT: Indicates a tire, designated by the Tire and Rim Association, that is intended for service on light trucks.

B. Load Range and Load Inflation Limits: Indicates the tire's load-carrying capabilities and its inflation limits.

C. Maximum Load Dual lb (kg) at psi (kPa) cold: Indicates the maximum load and tire pressure when the tire is used as a dual; defined as four tires on the rear axle (a total of six or more tires on the vehicle).

D. Maximum Load Single lb (kg) at psi (kPa) cold: Indicates the maximum load and tire pressure when the tire is used as a single; defined as two tires (total) on the rear axle.

Information on T Type Tires

T145/80D16 is an example of a tire size.

Note: *The temporary tire size for your vehicle could be different from this example. Tire Quality Grades do not apply to this type of tire.*

Wheels and Tires

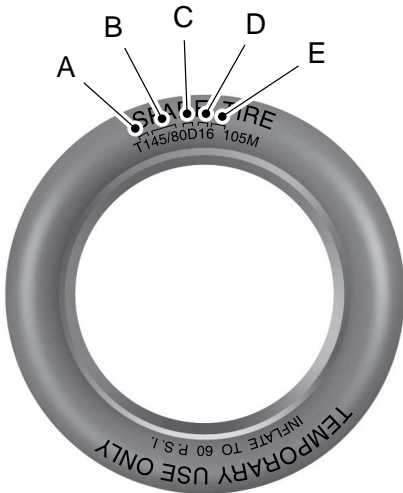

T type tires have some additional information beyond those of P type tires. These differences are described below:

A. **T:** Indicates a type of tire, designated by the Tire and Rim Association, that is intended for temporary service on cars, sport utility vehicles, minivans and light trucks.

B. **145:** Indicates the nominal width of the tire in millimeters from sidewall edge to sidewall edge. In general, the larger the number, the wider the tire.

C. **80:** Indicates the aspect ratio which gives the tire's ratio of height to width. Numbers of 70 or lower indicate a short sidewall.

D. **D:** Indicates a diagonal type tire.

R: Indicates a radial type tire.

E. **16:** Indicates the wheel or rim diameter in inches. If you change your wheel size, you will have to purchase new tires to match the new wheel diameter.

Location of the Tire Label

You will find a Tire Label containing tire inflation pressure by tire size and other important information located on the B-Pillar or the edge of the driver's door. See **Load Carrying** (page 218).

Inflating Your Tires

Safe operation of your vehicle requires that your tires are properly inflated. Remember that a tire can lose up to half of its air pressure without appearing flat.

Every day before you drive, check your tires. If one looks lower than the others, use a tire gauge to check pressure of all tires and adjust if required.

At least once a month and before long trips, inspect each tire and check the tire pressure with a tire gauge (including spare, if equipped). Inflate all tires to the inflation pressure recommended by us.

Wheels and Tires

You are strongly urged to buy a reliable tire pressure gauge, as automatic service station gauges could be inaccurate. We recommend the use of a digital or dial-type tire pressure gauge rather than a stick-type tire pressure gauge.

Use the recommended cold inflation pressure for optimum tire performance and wear. Under-inflation or over-inflation could cause uneven treadwear patterns.



WARNING: Under-inflation is the most common cause of tire failures and may result in severe tire cracking, tread separation or blowout, with unexpected loss of vehicle control and increased risk of injury. Under-inflation increases sidewall flexing and rolling resistance, resulting in heat buildup and internal damage to the tire. It also may result in unnecessary tire stress, irregular wear, loss of vehicle control and accidents. A tire can lose up to half of its air pressure and not appear to be flat!

Always inflate your tires to our recommended inflation pressure even if it is less than the maximum inflation pressure information found on the tire. Our recommended tire inflation pressure is found on the Safety Compliance Certification Label or

Tire Label (affixed to either the door hinge pillar, door-latch post, or the door edge that meets the door-latch post, next to the driver's seating position), or Tire Label located on the B-pillar or the edge of the driver's door. Failure to follow the tire pressure recommendations can cause uneven treadwear patterns and adversely affect the way your vehicle handles.

Note: *Do not reduce tire pressure to change the ride characteristics of the vehicle. If you do not maintain the inflation pressure at the levels specified by us, your vehicle could experience a condition known as shimmy. Shimmy is a severe vibration and oscillation in the steering wheel after the vehicle travels over a bump or dip in the road that does not dampen out by itself. Shimmy could result from significant under-inflation of the tires, improper tires (load range, size, or type), or vehicle modifications such as lift-kits. In the event that your vehicle experiences shimmy, you should slowly reduce speed by either lifting off the accelerator pedal or lightly applying the brakes. The shimmy will cease as the vehicle speed decreases.*

Maximum Inflation Pressure is the tire manufacturer's maximum permissible pressure and the pressure at which the maximum load can be carried by the tire. This pressure is normally higher than

Wheels and Tires

the manufacturer's recommended cold inflation pressure which can be found on the Safety Compliance Certification Label (affixed to either the door hinge pillar, door-latch post, or the door edge that meets the door-latch post, next to the driver's seating position), or Tire Label located on the B-pillar or the edge of the driver's door. The cold inflation pressure should never be set lower than the recommended pressure on the Safety Compliance Certification Label or Tire Label.

When weather temperature changes occur, tire inflation pressures also change. A 10°F (6°C) temperature drop can cause a corresponding drop of 1 psi (7 kPa) in inflation pressure. Check your tire pressures frequently and adjust them to the proper pressure which can be found on the Safety Compliance Certification Label or Tire Label.

To check the pressure in your tire(s):

1. Make sure the tires are cool, meaning they are not hot from driving even a mile.

Note: *If you are checking tire pressure when the tire is hot, (for example, driven more than 1 mile [1.6 kilometers]), never bleed or reduce air pressure. The tires are hot from driving and it is normal for pressures to increase above recommended cold pressures. A hot tire at or below recommended cold inflation pressure could be significantly under-inflated.*

Note: *If you have to drive a distance to get air for your tire(s), check and record the tire pressure first and add the appropriate air pressure when you get to the pump. It is normal for tires to heat up and the air pressure inside to go up as you drive.*

2. Remove the cap from the valve on one tire, then firmly press the tire gauge onto the valve and measure the pressure.

3. Add enough air to reach the recommended air pressure.

Note: *If you overfill the tire, release air by pressing on the metal stem in the center of the valve. Then recheck the pressure with your tire gauge.*

4. Replace the valve cap.

5. Repeat this procedure for each tire, including the spare.

Wheels and Tires

Note: Some spare tires operate at a higher inflation pressure than the other tires. For T type mini-spare tires, see the Dissimilar spare wheel and tire assembly information for a description. Store and maintain at 60 psi (4.15 bar). For full-size and dissimilar spare tires, see the Dissimilar spare wheel and tire assembly information for a description. Store and maintain at the higher of the front and rear inflation pressure as shown on the Safety Compliance Certification Label or Tire Label.

6. Visually inspect the tires to make sure there are no nails or other objects embedded that could poke a hole in the tire and cause an air leak.

7. Check the sidewalls to make sure there are no gouges, cuts or bulges.

Inspecting Your Tires and Wheel Valve Stems

Periodically inspect the tire treads for uneven or excessive wear and remove objects such as stones, nails or glass that could be wedged in the tread grooves. Check the tire and valve stems for holes, cracks, or cuts that could permit air leakage and repair or replace the tire and replace the valve stem. Inspect the tire sidewalls for cracking, cuts, bruises and other signs of damage or excessive wear. If internal damage to the tire is suspected, have the tire dismantled and

inspected in case it needs to be repaired or replaced. For your safety, tires that are damaged or show signs of excessive wear should not be used because they are more likely to blow out or fail.

Improper or inadequate vehicle maintenance can cause tires to wear abnormally. Inspect all your tires, including the spare, frequently, and replace them if one or more of the following conditions exist:

Tire Wear

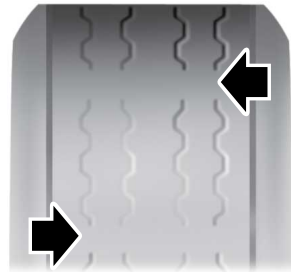

When the tread is worn down to one sixteenth of an inch (2 millimeters), tires must be replaced to help prevent your vehicle from skidding and hydroplaning. Built-in treadwear indicators, or wear bars, which look like narrow strips of smooth rubber across the tread will appear on the tire when the tread is worn down to one sixteenth of an inch (2 millimeters).

Wheels and Tires

When the tire tread wears down to the same height as these wear bars, the tire is worn out and must be replaced.

Damage

Periodically inspect the tire treads and sidewalls for damage (such as bulges in the tread or sidewalls, cracks in the tread groove and separation in the tread or sidewall). If damage is observed or suspected have the tire inspected by a tire professional. Tires can be damaged during off-road use, so inspection after off-road use is also recommended.

Age



WARNING: Tires degrade over time depending on many factors such as weather, storage conditions, and conditions of use (load, speed, inflation pressure) the tires experience throughout their lives.



WARNING: In general, tires should be replaced after six years regardless of tread wear. However, heat caused by hot climates or frequent high loading conditions can accelerate the aging process and may require tires to be replaced more frequently.



WARNING: You should replace your spare tire when you replace the road tires or after six years due to aging even if it has not been used.

U.S. DOT Tire Identification Number

Both United States and Canada Federal regulations require tire manufacturers to place standardized information on the sidewall of all tires. This information identifies and describes the fundamental characteristics of the tire and also provides a U.S. DOT Tire Identification Number for safety standard certification and in case of a recall.

This begins with the letters DOT and indicates that the tire meets all federal standards. The next two numbers or letters are the plant code designating where it was manufactured, the next two are the tire size code and the last four numbers represent the week and year the tire was built. For example, the numbers 317 mean the 31st week of 1997. After 2000 the numbers go to four digits. For example, 2501 means the 25th week of 2001. The numbers in between are identification codes used for traceability. This information is used to contact customers if a tire defect requires a recall.

Wheels and Tires

Tire Replacement Requirements

Your vehicle is equipped with tires designed to provide a safe ride and handling capability.



WARNING: Only use replacement tires and wheels that are the same size, load index, speed rating and type (such as P-metric versus LT-metric or all-season versus all-terrain) as those originally provided by Ford. The recommended tire and wheel size may be found on either the Safety Compliance Certification Label (affixed to either the door hinge pillar, door-latch post, or the door edge that meets the door-latch post, next to the driver's seating position), or the Tire Label which is located on the B-Pillar or edge of the driver's door. If this information is not found on these labels, then you should contact your authorized dealer as soon as possible. Use of any tire or wheel not recommended by Ford can affect the safety and performance of your vehicle, which could result in an increased risk of loss of vehicle control, vehicle rollover, personal injury and death.



WARNING: To reduce the risk of serious injury, when mounting replacement tires and wheels, you should not exceed the maximum pressure indicated on the sidewall of the tire to set the beads without additional precautions listed below. If the beads do not seat at the maximum pressure indicated, re-lubricate and try again.



WARNING: When inflating the tire for mounting pressures up to 20 psi (1.38 bar) greater than the maximum pressure on the tire sidewall, the following precautions must be taken to protect the person mounting the tire:

- Make sure that you have the correct tire and wheel size.
- Lubricate the tire bead and wheel bead seat area again.
- Stand at a minimum of 12 ft (3.66 m) away from the wheel and tire assembly.
- Use both eye and ear protection.



WARNING: For a mounting pressure more than 20 psi (1.38 bar) greater than the maximum pressure, a Ford dealer or other tire service professional should do the mounting.

Wheels and Tires



WARNING: Always inflate steel carcass tires with a remote air fill with the person inflating standing at a minimum of 12 ft (3.66 m) away from the wheel and tire assembly.

Important: Remember to replace the wheel valve stems when the road tires are replaced on your vehicle.

The two front tires or two rear tires should generally be replaced as a pair, except if the vehicle is equipped with four wheel drive. Vehicles equipped with four wheel drive should have all four tires replaced simultaneously. Unevenly worn tires, mismatched makes, models or brands can be different in size, resulting in potential damage to the four wheel drive system.

The tire pressure sensors mounted in the wheels are not designed to be used in aftermarket wheels.

The use of wheels or tires not recommended by us could affect the operation of your tire pressure monitoring system.

If the tire pressure monitoring system indicator is flashing, the system is malfunctioning. Your replacement tire might be incompatible with your tire pressure monitoring system, or some component of the system could be damaged.

Safety Practices



WARNING: If your vehicle is stuck in snow, mud or sand, do not rapidly spin the tires; spinning the tires can tear the tire and cause an explosion. A tire can explode in as little as three to five seconds.



WARNING: Do not spin the wheels at over 34 mph (55 km/h). The tires may fail and injure a passenger or bystander.

Driving habits have a great deal to do with your tire mileage and safety.

- *Observe posted speed limits
- *Avoid fast starts, stops and turns
- *Avoid potholes and objects on the road
- *Do not run over curbs or hit the tire against a curb when parking

Highway Hazards

No matter how carefully you drive there is always the possibility that you could eventually have a flat tire on the highway. Drive slowly to the closest safe area out of traffic. This could further damage the flat tire, but your safety is more important.

Wheels and Tires

If you feel a sudden vibration or ride disturbance while driving, or you suspect your tire or vehicle has been damaged, immediately reduce your speed. Drive with caution until you can safely pull off the road. Stop and inspect the tires for damage. If a tire is under-inflated or damaged, deflate it, remove wheel and replace it with your spare tire and wheel. If you cannot detect a cause, have the vehicle towed to the nearest repair facility or tire dealer to have the vehicle inspected.

Tire and Wheel Alignment

A bad jolt from hitting a curb or pothole can cause the front end of your vehicle to become misaligned or cause damage to your tires. If your vehicle seems to pull to one side when you are driving, the wheels could be out of alignment. Have an authorized dealer check the wheel alignment periodically.

Wheel misalignment in the front or the rear can cause uneven and rapid treadwear of your tires and should be corrected by an authorized dealer. Front-wheel drive vehicles and those with an independent rear suspension could require alignment of all four wheels.

The tires should also be balanced periodically. An unbalanced tire and wheel assembly could result in irregular tire wear.

Tire Rotation



WARNING: If the tire label shows different tire pressures for the front and rear tires and the vehicle has a tire pressure monitoring system, then you need to update the settings for the system sensors. Always perform the system reset procedure after tire rotation. If you do not reset the system, it may not provide a low tire pressure warning when necessary.

Note: *If your tires show uneven wear ask an authorized dealer to check for and correct any wheel misalignment, tire imbalance or mechanical problem involved before tire rotation.*

Note: *Your vehicle could be equipped with a dissimilar spare wheel and tire assembly. A dissimilar spare wheel and tire assembly is defined as a spare wheel and tire assembly that is different in brand, size or appearance from the road tires and wheels. If you have a dissimilar spare wheel and tire assembly it is intended for temporary use only and should not be used in a tire rotation.*

Note: *After having your tires rotated, inflation pressure must be checked and adjusted to the vehicle requirements.*

Wheels and Tires

Note: *Uneven tread depth between the front and rear tires could lead to degradation in 4WD engagement and disengagement performance, additional noise from the 4WD system or damage.*

Rotating your tires at the recommended interval (as indicated in the Scheduled Maintenance chapter) will help your tires wear more evenly, providing better tire performance and longer tire life.

Rear-wheel drive vehicles and four-wheel drive vehicles (front tires at left of diagram)

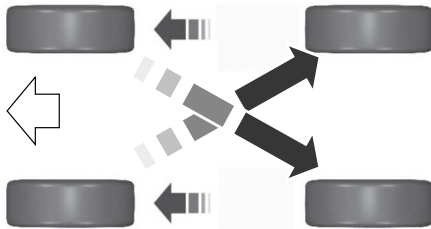

Sometimes irregular tire wear can be corrected by rotating the tires.

USING SNOW CHAINS

WARNING: Do not exceed 30 mph (50 km/h). Failure to follow this instruction could result in the loss of control of your vehicle, personal injury or death.

WARNING: Do not use snow chains on snow-free roads.

WARNING: Only fit snow chains to specified tires.

WARNING: If your vehicle is fitted with wheel trims, remove them before fitting snow chains.

WARNING: Snow tires must be the same size, load index and speed rating as those originally provided by Ford. Use of any tire or wheel not recommended by Ford can affect the safety and performance of your vehicle, which could result in an increased risk of loss of control, vehicle rollover, personal injury and death. Additionally, the use of non-recommended tires and wheels can cause steering, suspension, axle, transfer case or power transfer unit failure. Follow the Ford recommended tire inflation pressure found on the Safety Compliance Certification Label (on the door hinge pillar, door latch post or the door edge that meets the door latch post, next to the driver seat), or Tire Label on the B-Pillar or the edge of the driver door. Failure to follow the tire pressure recommendations can cause uneven treadwear patterns and adversely affect the way your vehicle handles.

Note: *The suspension insulation and bumpers help prevent vehicle damage. Do not remove these components from your vehicle when using snow tires and chains.*

Wheels and Tires

The tires on your vehicle have all-weather treads to provide traction in rain and snow. However, in some climates, you may need to use snow tires and snow chains. If you need to use snow chains, we recommend you use steel wheels of the same size and specifications, as snow chains may chip aluminum wheels.

Note: Only use snow chains on applicable tire sizes.

Only fit snow chains to the following specified tires:

- 255/70 R16 111T.
- 255/65 R17 110T.
- 265/65 R17 112T.
- 265/60 R18 110T.
- LT265/65 R17 109T.
- LT265/70 R17 112T.

Only use S-Class snow chains, 0.6 in (15 mm) chain links.

Only use manual tensioning chains. Do not use self-tensioning chains.

Only use snow chains in pairs on the rear axle.

Note: The anti-lock brake system continues to operate normally.

Follow these guidelines when using snow tires and chains:

- If possible, avoid fully loading your vehicle.
- Install chains securely, verifying that the chains do not touch any wiring, brake lines, or fuel lines.
- Drive cautiously. If you hear the chains rub or bang against your vehicle, stop and retighten the chains. If this does not work, remove the chains to prevent damage to your vehicle.
- Remove the tire chains when you no longer need them. Do not use tire chains on dry roads.

If you have any questions regarding snow chains, please contact your authorized dealer.

Vehicles with Stability Control

When stability control is on, your vehicle may exhibit some unusual driving characteristics. To reduce this, switch traction control off. See **Using Traction Control** (page 178).

TIRE PRESSURE MONITORING SYSTEM



WARNING: The tire pressure monitoring system is not a substitute for manually checking tire pressures. You should periodically check tire pressures using a pressure gauge. Failure to correctly maintain tire pressures could increase the risk of tire failure, loss of control, vehicle rollover and personal injury.

Note: You should only use tire sealants in roadside emergencies as they may cause damage to the tire pressure monitoring system sensor.

Note: If the tire pressure monitoring system sensor becomes damaged, it may not function.



Each tire, including the spare (if provided), should be checked monthly when cold and inflated to the inflation pressure recommended by the vehicle manufacturer on the vehicle placard or tire inflation pressure label. (If your vehicle has tires of a different size than the size indicated on the vehicle placard or tire inflation pressure label, you should determine the proper tire inflation pressure for those tires).

Wheels and Tires

As an added safety feature, your vehicle has been equipped with a Tire Pressure Monitoring System (TPMS) that illuminates a low tire pressure telltale when one or more of your tires is significantly under-inflated. Accordingly, when the low tire pressure telltale illuminates, you should stop and check your tires as soon as possible, and inflate them to the proper pressure. Driving on a significantly under-inflated tire causes the tire to overheat and can lead to tire failure. Under-inflation also reduces fuel efficiency and tire tread life, and may affect the vehicle's handling and stopping ability.

Please note that the TPMS is not a substitute for proper tire maintenance, and it is the driver's responsibility to maintain correct tire pressure, even if under-inflation has not reached the level to trigger illumination of the TPMS low tire pressure telltale.

Your vehicle has also been equipped with a TPMS malfunction indicator to indicate when the system is not operating properly. The TPMS malfunction indicator is combined with the low tire pressure telltale. When the system detects a malfunction, the telltale will flash for approximately one minute and then remain continuously illuminated. This sequence will continue upon subsequent vehicle start-ups as long as the malfunction exists.

When the malfunction indicator is illuminated, the system may not be able to detect or signal low tire pressure as intended. TPMS malfunctions may occur for a variety of reasons, including the installation of replacement or alternate tires or wheels on the vehicle that prevent the TPMS from functioning properly. Always check the TPMS malfunction telltale after replacing one or more tires or wheels on your vehicle to ensure that the replacement or alternate tires and wheels allow the TPMS to continue to function properly.

This device complies with Part 15 of the FCC Rules and with License exempt RSS Standards of Industry Canada. Operation is subject to the following two conditions:

1. This device may not cause harmful interference, and
2. This device must accept any interference received, including interference that may cause undesired operation.



WARNING: Changes or modifications not expressly approved by the party responsible for compliance could void the user's authority to operate the equipment. The term "IC:" before the radio certification number only signifies that Industry Canada technical specifications were met.

Changing Tires With a Tire Pressure Monitoring System



Note: Each road tire is equipped with a tire pressure sensor located inside the wheel and tire assembly cavity. The pressure sensor is attached to the valve stem. The pressure sensor is covered by the tire and is not visible unless the tire is removed. Take care when changing the tire to avoid damaging the sensor.

You should always have your tires serviced by an authorized dealer.

Wheels and Tires

Check the tire pressure periodically (at least monthly) using an accurate tire gauge. See **When Inflating Your Tires** in this chapter.

Understanding Your Tire Pressure Monitoring System



The tire pressure monitoring system measures pressure in your road tires and sends the tire pressure readings to your vehicle. You can view the tire pressure readings through the information display. See **General Information** (page 96). The low tire pressure warning light will turn on if the tire pressure is significantly low. Once

the light is illuminated, your tires are under-inflated and need to be inflated to the manufacturer's recommended tire pressure. Even if the light turns on and a short time later turns off, your tire pressure still needs to be checked.

When Your Temporary Spare Tire is Installed

When one of your road tires needs to be replaced with the temporary spare, the system will continue to identify an issue to remind you that the damaged road wheel and tire assembly needs to be repaired and put back on your vehicle.

To restore the full function of the tire pressure monitoring system, have the damaged road wheel and tire assembly repaired and remounted on your vehicle.

When You Believe Your System is Not Operating Properly

The main function of the tire pressure monitoring system is to warn you when your tires need air. It can also warn you in the event the system is no longer capable of functioning as intended. See the following chart for information concerning your tire pressure monitoring system:

Wheels and Tires

Low tire pressure warning light	Possible cause	Customer action required
Solid warning light	Tire(s) under-inflated	Make sure tires are at the proper pressure. See Inflating your tires in this chapter. After inflating your tires to the manufacturer's recommended pressure as shown on the Tire Label (located on the edge of driver's door or the B-Pillar), the vehicle must be driven for at least two minutes over 20 mph (32 km/h) before the light turns off.
	Spare tire in use	Repair the damaged road wheel and tire assembly and reinstall it on the vehicle to restore system function. For a description on how the system functions, see When Your Temporary Spare Tire is Installed in this section.
	TPMS malfunction	If the tires are properly inflated and the spare tire is not in use but the light remains on, contact your authorized dealer as soon as possible.
Flashing warning light	Spare tire in use	Repair the damaged road wheel and tire assembly and reinstall it on the vehicle to restore system function. For a description on how the system functions, see When Your Temporary Spare Tire is Installed in this section.
	TPMS malfunction	If the tires are properly inflated and the spare tire is not in use but the light remains on, contact your authorized dealer as soon as possible.

When Inflating Your Tires



WARNING: Do not use the tire pressure displayed in the information display as a tire pressure gauge. Failure to follow this instruction could result in personal injury or death.

When putting air into your tires (such as at a gas station or in your garage), the tire pressure monitoring system may not respond immediately to the air added to your tires.

It may take up to two minutes of driving over 20 mph (32 km/h) for the light to turn off after you have filled your tires to the recommended inflation pressure.

Wheels and Tires

How Temperature Affects Your Tire Pressure

The tire pressure monitoring system monitors tire pressure in each pneumatic tire. While driving in a normal manner, a typical passenger tire inflation pressure may increase about 2–4 psi (14–28 kPa) from a cold start situation. If the vehicle is stationary overnight with the outside temperature significantly lower than the daytime temperature, the tire pressure may decrease about 3 psi (21 kPa) for a drop of 30°F (17°C) in ambient temperature. This lower pressure value may be detected by the tire pressure monitoring system as being significantly lower than the recommended inflation pressure and activate the system warning light for low tire pressure. If the low tire pressure warning light is on, visually check each tire to verify that no tire is flat. If one or more tires are flat, repair as necessary. Check the air pressure in the road tires. If any tire is under-inflated, carefully drive the vehicle to the nearest location where air can be added to the tires. Inflate all the tires to the recommended inflation pressure.

CHANGING A ROAD WHEEL



WARNING: If the tire pressure monitor sensor becomes damaged it may not function.

If you get a flat tire when driving, do not heavily apply the brake. Instead, gradually decrease your speed. Firmly hold the steering wheel and slowly move to a safe place on the side of the road.

Have a flat serviced by an authorized dealer in order to prevent damage to the system sensors. See **Tire Pressure Monitoring System** (page 309). Replace the spare tire with a road tire as soon as possible. During repairing or replacing of the flat tire, have the authorized dealer inspect the system sensor for damage.

Note: *The use of tire sealant could damage your tire pressure monitoring system and should only be used in roadside emergencies.*

Note: *The tire pressure monitoring system indicator light illuminates when the spare tire is in use. To restore the full function of the monitoring system, all road wheels with tire pressure monitoring sensors must be mounted on this vehicle.*

Dissimilar Spare Wheel and Tire Assembly Information



WARNING: Failure to follow these guidelines could result in an increased risk of loss of vehicle control, injury or death.

If you have a dissimilar spare wheel and tire, then it is intended for temporary use only. This means that if you need to use it, you should replace it as soon as possible with a road wheel and tire assembly that is the same size and type as the road tires and wheels that were originally provided by Ford.

A dissimilar spare wheel and tire assembly is defined as a spare wheel and tire assembly that is different in brand, size or appearance from the other road tires and wheels on your vehicle.

Wheels and Tires

Full-size dissimilar spare

When driving with the full-size dissimilar spare wheel and tire assembly, do not:

- Exceed 50 mph (80 km/h).
- Use more than one dissimilar spare wheel and tire assembly at a time.
- Use snow chains on the end of the vehicle with the dissimilar spare wheel and tire assembly.

When driving with the full-size dissimilar spare wheel and tire assembly, 4WD functionality may be limited, especially when driving in a mechanically locked 4WD mode. You may experience the following:

- Additional noise from the transfer case or other drive components.
- Difficulty shifting out of a mechanically locked 4WD mode.

When driving with the full-size dissimilar spare wheel and tire assembly you do not:

- Exceed 50 mph (80 km/h) in 4WD.
- Engage 4WD unless the vehicle is stationary.
- Use 4WD on dry pavement.

The usage of a full-size dissimilar spare wheel and tire assembly can lead to impairment of the following:

- Handling, stability and braking performance.
- Comfort and noise.
- Ground clearance and parking at curbs.
- Winter weather driving capability.
- Wet weather driving capability.
- Four-wheel drive capability.

When driving with the full-size dissimilar spare wheel and tire assembly additional caution should be given to:

- Towing a trailer.
- Driving vehicles equipped with a camper body.
- Driving vehicles with a load on the cargo rack.

Drive cautiously when using a full-size dissimilar spare wheel and tire assembly and seek service as soon as possible.

Tire Change Procedure



WARNING: The jack supplied with this vehicle is only intended for changing a flat tire in an emergency. Do not attempt to do any other work on your vehicle when it is supported by the jack, as your vehicle could slip off the jack. Failure to follow this instruction could result in personal injury or death.



WARNING: To help prevent your vehicle from moving when changing a wheel, shift the transmission into park (P), set the parking brake and use an appropriate block or wheel chock to secure the wheel diagonally opposite to the wheel being changed. For example, when changing the front left wheel, place an appropriate block or wheel chock on the right rear wheel.





WARNING: Do not attempt to change a tire on the side of the vehicle close to moving traffic. Pull far enough off the road to avoid the danger of being hit when operating the jack or changing the wheel.



WARNING: Only use the jack provided as original equipment with your vehicle.

Wheels and Tires

 **WARNING:** No person should place any portion of their body under a vehicle that is supported by a jack.

 **WARNING:** The jack supplied with this vehicle is only intended for changing wheels. Do not use the vehicle jack other than when you are changing a wheel in an emergency.

 **WARNING:** The jack should be used on level firm ground wherever possible.

 **WARNING:** Check that the vehicle jack is not damaged or deformed and the thread is lubricated and clean.

 **WARNING:** Never place anything between the vehicle jack and the ground.

 **WARNING:** Never place anything between the vehicle jack and your vehicle.

 **WARNING:** It is recommended that the wheels of the vehicle be chocked, and that no person should remain in a vehicle that is being jacked.

Park on a level surface, activate the hazard flashers and set the parking brake. Then, place the transmission in park (P) and turn the engine off.

Note: Only use the spare tire carrier to stow the tire and wheel combination provided with your vehicle. Other tire and wheel combinations will cause the tire carrier to fail.

Note: Do not use impact tools or power tools on the spare tire carrier, as this could cause a winch malfunction and prevent a secure fit. The spare tire carrier tightening torque should be 29,50 lb.ft (40 Nm) +/- 4.43 lb.ft (6 Nm).

Note: When jacking the vehicle passengers should not be in the vehicle.

Vehicle Jack

 **WARNING:** Ensure screwthread is adequately lubricated before use.

 **WARNING:** The jack should be used on level firm ground wherever possible.

 **WARNING:** Switch the ignition off and apply the park brake fully before lifting vehicle.

 **WARNING:** It is recommended that the wheels of the vehicle be chocked, and that no person should remain in a vehicle that is being jacked.

 **WARNING:** No person should place any portion of their body under a vehicle that is supported by a jack.

 **WARNING:** Do not get under a vehicle that is supported by a jack.

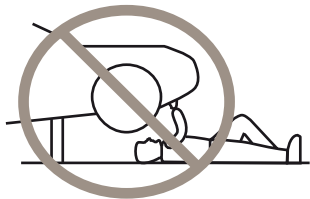

 **WARNING:** The jack supplied with this vehicle is only intended for changing wheels. Do not use the vehicle jack other than when you are changing a wheel in an emergency.

Wheels and Tires

Vehicle Jack Assembly

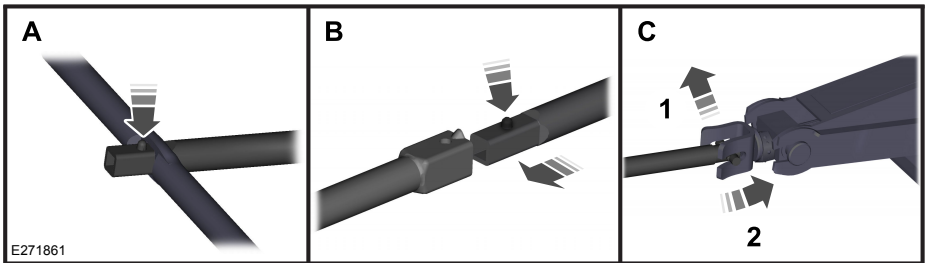
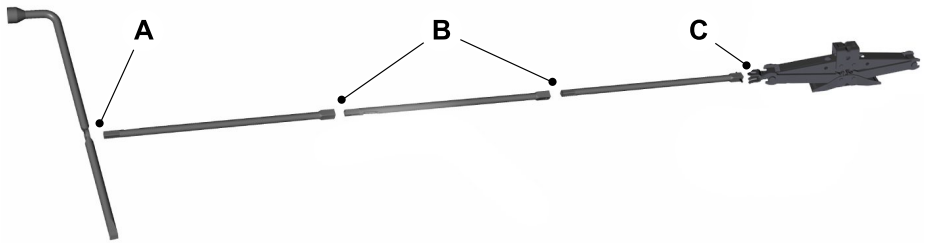

E271861

- A Wheel brace.
- B Jack handle and extensions.
- C Vehicle jack.

The jack, wheel brace, extensions and jack handle are in the cab.

Your jack does not require maintenance or additional lubrication over the service life of your vehicle.

Do not use the jack if it is visibly damaged or does not operate freely. Replace the damaged jack with a jack specified for use on your vehicle if you detect these conditions.

Wheels and Tires

SuperCab

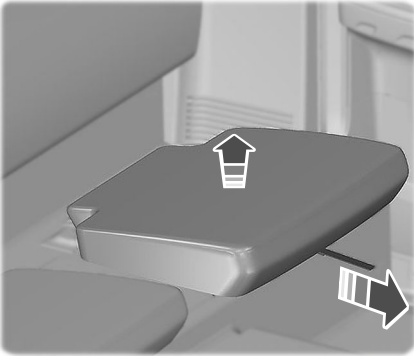

1. Pull the release strap on the left-hand side rear seat.
2. Remove the rear seat.

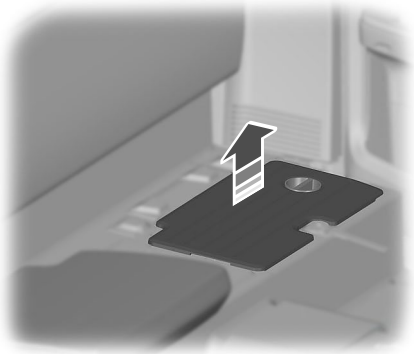

3. Carefully remove the cover.

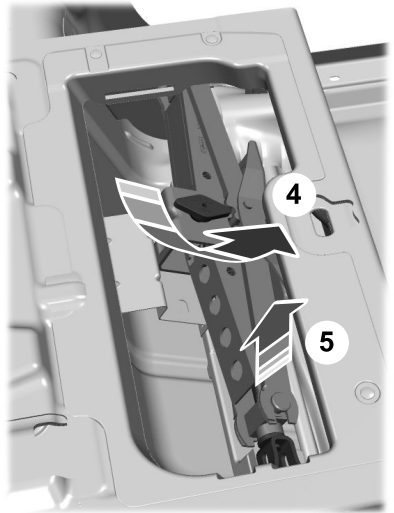

4. Remove the bolt.
5. Lift the jack from the foam block and remove the jack from your vehicle.
6. Remove the tools.

Note: Pay close attention to the orientation of the jack and tool kit bag, because you need to reinstall them after changing the tire.

Wheels and Tires

SuperCrew

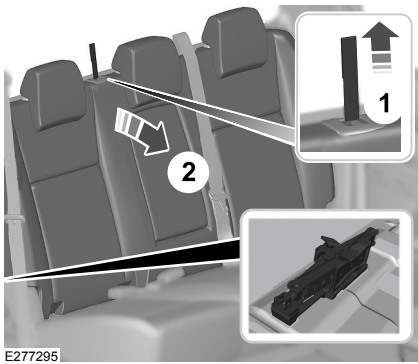

1. Lift the release strap.
2. Lower the seat backrest.
3. Remove the bolt.
4. Lift the jack from the foam block and remove the jack from your vehicle.

Note: The jack and tools are stored separately.

Note: Pay close attention to the orientation of the jack and tool kit bag, because you need to reinstall them after changing the tire.

SuperCrew

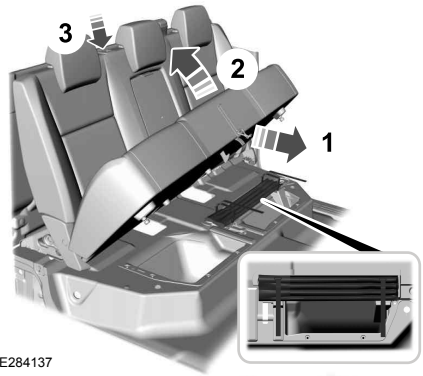

1. Pull the release strap out.
2. Fully lift the seat cushion up into the locked position.
3. Loosen the D-ring straps to form a loop.
4. Remove the tools.

Spare Wheel

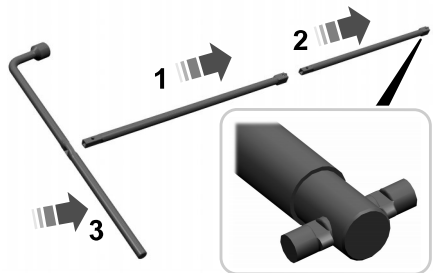

Wheels and Tires

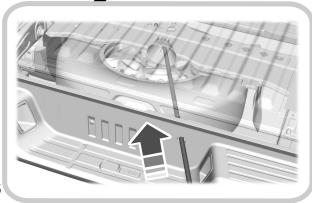
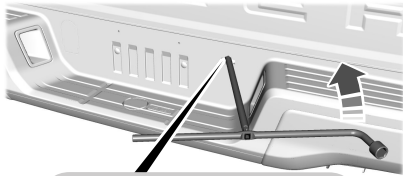

E283035

2. Insert the jack handle into the guide hole. Turn counterclockwise until the wheel rests on the ground, and there is slack in the cable.

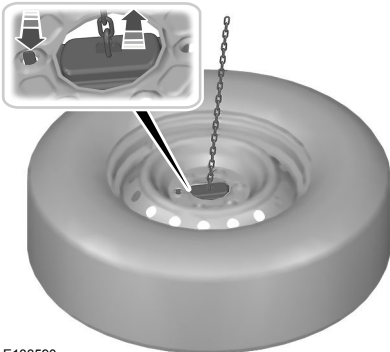

E133590

3. Pass the bracket and cable through the wheel opening.

Note: If the spare wheel is not the same type and size as your vehicle road wheel, drive the shortest distance possible.

Note: Do not fit more than one spare wheel on your vehicle at any one time.

Note: The spare wheel has a label showing the maximum driving speed. Drive with caution and at no more than the permitted maximum speed.

Note: The usage of a dissimilar spare wheel or tire at any one wheel location can lead to impairment of the handling, stability and braking performance, comfort and noise.

Note: When driving with a spare tire, do not switch on four-wheel drive mode unless you need to get your vehicle unstuck.

Note: The spare wheel is underneath the rear of the vehicle.

Note: Only two extensions are used to lower the rear wheel.

Jacking and Lifting Points

 **WARNING:** Use only the specified jacking points. If you use other locations, you could damage the body, steering, suspension, engine, braking system or the fuel lines.

Wheels and Tires

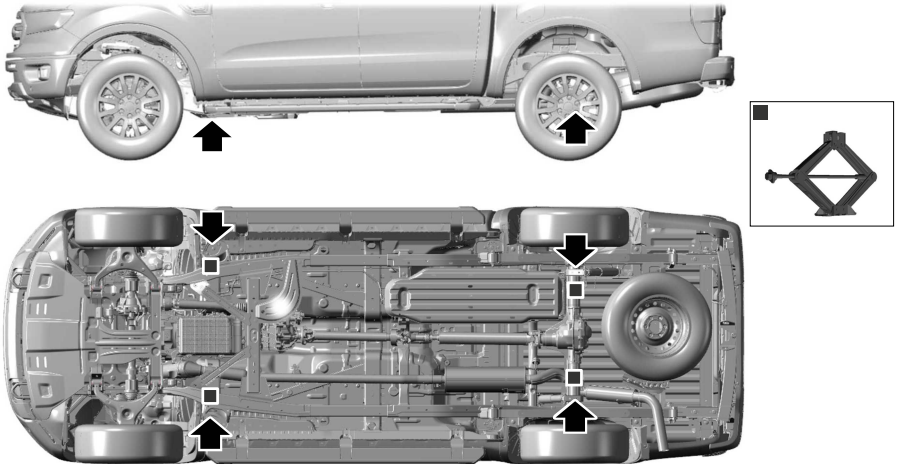

Note: Only use the jack on the specified front jacking points.

Note: Only use the jack on the specified points on the rear axle tube for the rear jacking points.

Note: Use the arrow indicator on the frame for the front jacking point.

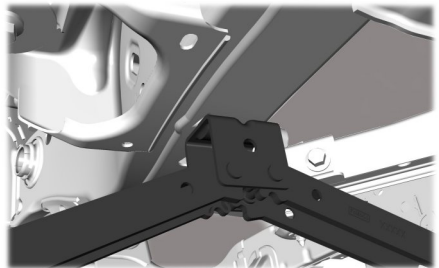
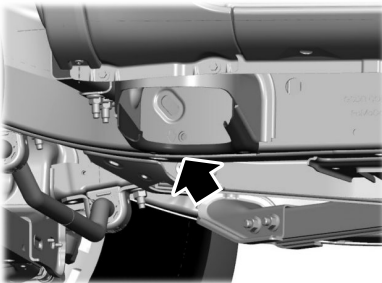

Wheels and Tires

Removing a Road Wheel

WARNING: Park your vehicle in such a position that neither the traffic nor you are hindered or endangered.

WARNING: Make sure that the wheels are pointing straight ahead.

WARNING: If your vehicle has a manual transmission, shift into first or reverse gear. If your vehicle has an automatic transmission, shift into park (P).

WARNING: Secure the diagonally opposite wheel with an appropriate block or wheel chock.

WARNING: Make sure that the vehicle jack is vertical to the jacking point and the base is flat on the ground.

WARNING: Never place anything between the vehicle jack and your vehicle.

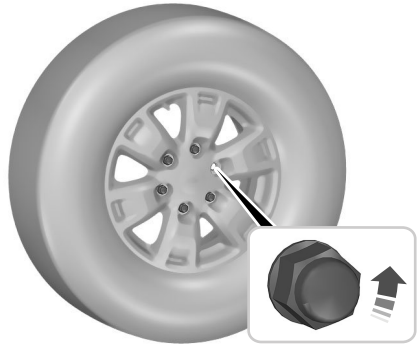

5. Remove the wheel nuts and the road wheel.

Note: Assemble the three handles to jack the rear of the vehicle.

Note: Do not lay alloy road wheels face down on the ground.

Installing a Road Wheel

WARNING: Use only approved wheel and tire sizes. Using other sizes could damage your vehicle.

WARNING: Do not fit run flat tires on vehicles that were not originally fitted with them. See an authorized dealer for more details about compatibility.

WARNING: Make sure there is no grease or oil on the threads or the surface between the wheel lugs and nuts. This can cause the lug nuts to loosen while driving.

WARNING: Have the lug nuts checked for tightness and the tire pressure checked as soon as possible.

1. Install the wheel.

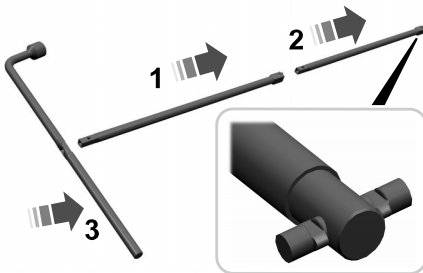

1. Assemble the jack handle.
2. Ensure screwthread on the jack is adequately lubricated before use.
3. Loosen the wheel nuts.
4. Raise your vehicle until the tire is clear of the ground.

Wheels and Tires

2. Install the wheel nuts finger tight.
3. Install the locking wheel nut key.

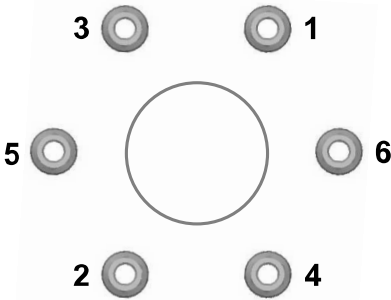

E79156

4. Partially tighten the wheel nuts in the sequence shown.
5. Lower the vehicle and remove the jack.
6. Fully tighten the wheel nuts in the sequence shown. See **Technical Specifications** (page 324).
7. Make sure that the projection of the cap is positioned on the same position as the projection of the hub.

Note: Make sure the wheel and hub contact surfaces are free from foreign matter.

Note: Make sure that the cones on the wheel nuts are against the wheel.

Note: If the spare wheel is different in size or construction to the road wheels, replace it as soon as possible.

Stowing the Flat Tire

1. Place the wheel flat on the ground, with the outer face of the wheel facing up.
2. Tilt the bracket, and pass it through the center of the wheel.

3. Fully insert the jack handle into the guide hole and turn the jack handle clockwise until the tire raises to its stowed position underneath your vehicle and is securely seated. The spare tire carrier tightening torque should be 29.50 lb.ft (40 Nm) +/- 4.43 lb.ft (6 Nm).
4. Stow the wheel brace, jack, and jack handle away.

Note: Do not use impact tools or power tools on the spare tire carrier, as this could cause a winch malfunction and prevent a secure fit.

Stowing the Vehicle Jack and Tool Kit - SuperCab

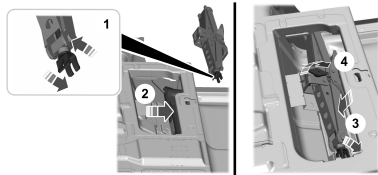

1. Before bringing the jack back into the vehicle, rotate the lead screw of the jack counterclockwise to collapse the jack height. Do not fully tighten.
2. Install the tool kit in the bin.
3. Place the jack on the foam block and pull the top of the jack up, to align the jack load rest hole with the hole of the floor bracket.
4. Insert the wing bolt and tighten the wing bolt by hand.
5. Install the cover.

Wheels and Tires

Stowing the Vehicle Jack - SuperCrew

1. Before bringing the jack back into the

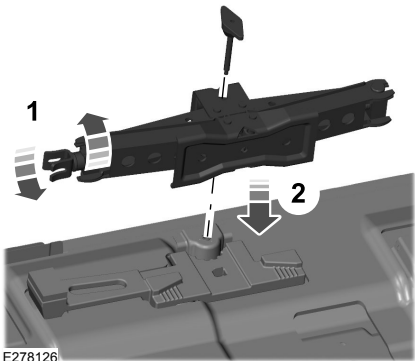

2. Place the jack on the foam block and pull the top of the jack up, to align the jack load rest hole with the hole of the floor bracket.
3. Insert the wing bolt and tighten the wing bolt by hand.

vehicle, rotate the lead screw of the jack counterclockwise to collapse the jack height. Make sure the jack is not fully closed.

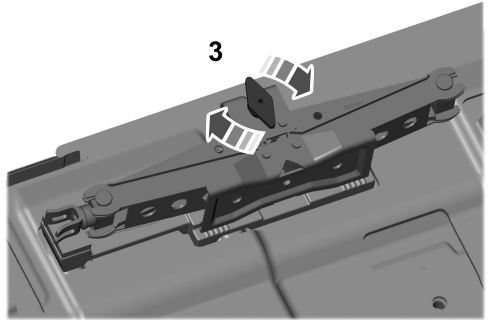

1. Place the tools inside the tool bag.
2. Install the tool bag on the plastic bin by passing them through the D-ring straps and placing them as shown in the image.
3. Pull the straps forward to tighten.

Stowing the Tool Kit - SuperCrew

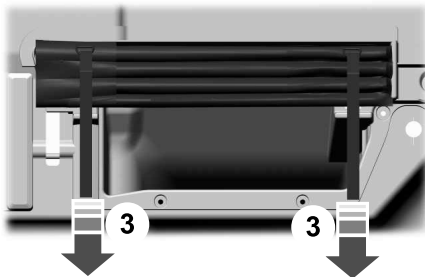

E284139

Wheels and Tires

TECHNICAL SPECIFICATIONS

Wheel Lug Nut Torque Specifications



WARNING: When you install a wheel, always remove any corrosion, dirt or foreign materials present on the mounting surfaces of the wheel or the surface of the wheel hub, brake drum or brake disc that contacts the wheel. Make sure to secure any fasteners that attach the rotor to the hub so they do not interfere with the mounting surfaces of the wheel. Installing wheels without correct metal-to-metal contact at the wheel mounting surfaces can cause the wheel nuts to loosen and the wheel to come off while your vehicle is in motion, resulting in loss of vehicle control, personal injury or death.

Bolt Size	lb.ft (Nm) ¹
M12 x 1.5	100 lb.ft (135 Nm)

¹ Torque specifications are for nut and bolt threads free of dirt and rust. Use only our recommended replacement fasteners.

Retighten the lug nuts to the specified torque within 100 miles (160 kilometers) after any wheel disturbance, such as tire rotation, changing a flat tire or wheel removal.



A Wheel pilot bore.

Inspect the wheel pilot hole and mounting surface prior to installation. Remove any visible corrosion or loose particles.

Capacities and Specifications

ENGINE SPECIFICATIONS

Engine	2.3L EcoBoost
Displacement.	138.00 in ³ (2,261.41 cm ³)
Required fuel.	Minimum 87 octane
Firing order.	1-3-4-2
Ignition system.	Coil on plug
Spark plug gap.	0.028–0.031 in (0.7–0.8 mm)
Compression ratio.	10:1

Drivebelt Routing

2.3L EcoBoost Engine

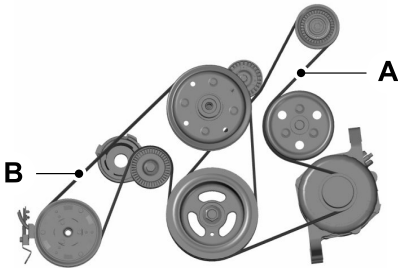

E276823

- Short, narrow width drivebelt is on first pulley groove closest to engine.
- Long, wide width drivebelt is on second pulley groove farthest from engine.

Capacities and Specifications

MOTORCRAFT PARTS

Component	Part Number
Air filter element.	FA-1943
Oil filter. ¹	FL-910-S
Battery.	BAGM-48H6-760 BAGM-94RH7-800
Spark plugs. ²	SP-594
Transmission filter (10R80).	FT-215
Cabin air filter.	FP-88
Windshield wiper blade.	WW-2615-A (driver side) WW-1615-A (passenger side)

¹ If a Motorcraft oil filter is not available, use an oil filter that aligns to SAE/USCAR – 36 Performance Specifications. Filter Type B.

² For spark plug replacement, contact a dealer. Replace the spark plugs at the appropriate intervals.

See **Scheduled Maintenance** (page 416).

We recommend Motorcraft replacement parts available at a dealer or at fordparts.com for scheduled maintenance. We engineer the parts for your vehicle to meet or exceed our specifications. Use of other parts could impact vehicle performance, emissions and durability. Your warranty could be void for any damage related to use of other parts.

Capacities and Specifications

VEHICLE IDENTIFICATION NUMBER

The vehicle identification number is located on the left-hand side of the instrument panel.



E142476

Please note that in the graphic, XXXX is representative of your vehicle identification number.

The Vehicle Identification Number contains the following information:

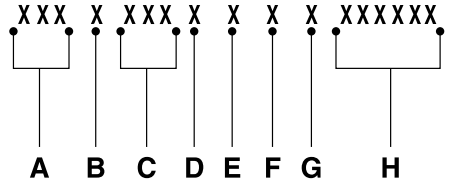

- A World manufacturer identifier
- B Brake system, Gross Vehicle Weight Rating, Restraint Devices and their locations
- C Make, vehicle line, series, body type
- D Engine type
- E Check digit
- F Model year
- G Assembly plant
- H Production sequence number

Capacities and Specifications

VEHICLE CERTIFICATION LABEL

MFD. BY FORD MOTOR CO.

DATE: XX/XX GVWR: XXXX KG (XXXX LB)
 FRONT GAWR: REAR GAWR:
 XXXX KG (XXXX LB) WITH XXXX KG (XXXX LB) WITH
 XXXXXXXXXXXXXXXX TIRES XXXXXXXXXXXXXXXX TIRES
 XXXXXXXX RIMS XXXXXXXX RIMS
 AT XXXX kPa/ XXX PSI COLD AT XXXX kPa/ XXX PSI COLD

THIS VEHICLE CONFORMS TO ALL APPLICABLE FEDERAL MOTOR VEHICLE SAFETY AND THEFT PREVENTION STANDARDS IN EFFECT ON THE DATE OF MANUFACTURE SHOWN ABOVE.

VIN: XXXXXXXXXXXXXXXX XXXXX
 TYPE: XXXX XXXXX



EXT PNT: XX XXXXX RC: XX DSO: XXXX
 WB INT TR TP/PS R AXLE TR SPR XXXX
 XXX XX XXX X XX X XXXX XXXX
 XXXXXXXXXXXXXXX XXX XXXX-XXXXXXXX-XX

E167469

The National Highway Traffic Safety Administration Regulations require that a Safety Compliance Certification Label be affixed to a vehicle and prescribe where the Safety Compliance Certification Label may be located. The Safety Compliance Certification Label shall be affixed to either the door hinge pillar, the door latch post, or the edge of the door near the door latch, next to the driver's seating position.

TRANSMISSION CODE DESIGNATION

MFD. BY FORD MOTOR CO.

DATE: XX/XX GVWR: XXXX KG (XXXX LB)
 FRONT GAWR: REAR GAWR:
 XXXX KG (XXXX LB) WITH XXXX KG (XXXX LB) WITH
 XXXXXXXXXXXXXXXX TIRES XXXXXXXXXXXXXXXX TIRES
 XXXXXXXX RIMS XXXXXXXX RIMS
 AT XXXX kPa/ XXX PSI COLD AT XXXX kPa/ XXX PSI COLD

THIS VEHICLE CONFORMS TO ALL APPLICABLE FEDERAL MOTOR VEHICLE SAFETY AND THEFT PREVENTION STANDARDS IN EFFECT ON THE DATE OF MANUFACTURE SHOWN ABOVE.

VIN: XXXXXXXXXXXXXXXX XXXXX
 TYPE: XXXX XXXXX



EXT PNT: XX XXXXX RC: XX DSO: XXXX
 WB INT TR TP/PS R AXLE TR SPR XXXX
 XXX XX XXX X XX X XXXX XXXX
 XXXXXXXXXXXXXXX XX XXXX-XXXXXXXX-XX

E167814

The transmission code is on the Safety Compliance Certification Label. The following table shows the transmission code along with the transmission description.

Description	Code
Ten-speed automatic transmission 10R80	U

Capacities and Specifications

CAPACITIES AND SPECIFICATIONS

Use oil and fluid that meets the defined specification and viscosity grade.

If you do not use oil and fluid that meets the defined specification and viscosity grade, it could result in:

- Component damage not covered by the vehicle warranty.
- Longer engine cranking periods.
- Increased emission levels.

- Reduced engine performance.
- Reduced fuel economy.
- Reduced brake performance.

Air Conditioning System

 **WARNING:** The air conditioning refrigerant system contains refrigerant under high pressure. Only qualified personnel should service the air conditioning refrigerant system. Opening the air conditioning refrigerant system can cause personal injury.

Capacities

Variant	Refrigerant	Refrigerant Oil
All.	24 oz (0.675 kg)	3.38 fl oz (100 ml)

Materials

Name	Specification
R-1234yf Refrigerant(U.S.) R-1234yf Refrigerant / Frigorigène R-1234yf(Canada) YN-33-A(U.S.) HS7Z-19B519-BA(Canada)	WSS-M17B21-A
Motorcraft® R-1234yf Refrigerant PAG Oil(U.S.) Motorcraft® R-1234yf Refrigerant PAG Oil / Huile PAG pour frigorigène R-1234yf Motorcraft®(Canada) YN-35(U.S. & Canada)	WSS-M2C300-A2

Automatic Transmission

Note: Only use MERCON® ULV transmission fluid for automatic transmissions that require MERCON® ULV transmission fluid. The use of any other fluid could cause transmission damage.

Capacities and Specifications

Capacities

Variant	Quantity
All.	12.8 qt (12.1 L) ¹

¹ Approximate dry fill capacity. Actual amount could vary during fluid changes.

Materials

Name	Specification
Motorcraft® MERCON® ULV Automatic Transmission Fluid(U.S.) Motorcraft® MERCON® ULV Automatic Transmission Fluid / MERCON® ULV huile pour boîtes automatique Motorcraft®(Canada) XT-12-QULV(U.S. & Canada)	WSS-M2C949-A, MERCON® ULV

Engine Coolant

Capacities

Variant	Quantity
All.	11.6 qt (11 L)

Materials

Name	Specification
Motorcraft® Yellow Prediluted Antifreeze/ Coolant(U.S.) Motorcraft® Yellow Prediluted Antifreeze/Coolant / Antigel/liquide de refroidissement prédilué jaune Motorcraft®(Canada) VC-13DL-G(U.S.) CVC-13DL-G(Canada)	WSS-M97B57-A2

Capacities and Specifications

Engine Oil



An oil that displays this symbol conforms to current engine, emission system and fuel economy performance standards of ILSAC.

We recommend Motorcraft® motor oil for your vehicle. If Motorcraft® oil is not available, use motor oils of the recommended viscosity grade that display the API Certification Mark for gasoline engines.

Do not use supplemental engine oil additives because they are unnecessary and could lead to engine damage that your vehicle warranty does not cover.

Capacities

Variant	Including the Oil Filter
All.	6.2 qt (5.9 L)

Materials

Name	Specification
Motorcraft® SAE 5W-30 Synthetic Blend Motor Oil (U.S.) Motorcraft® SAE 5W-30 Super Premium Motor Oil / Huile moteur de très haute qualité SAE 5W-30 Motorcraft® (Canada) XO-5W30-Q1SP (U.S.) CXO-5W30-LSP6 (Canada)	WSS-M2C961-A1

Alternative Engine Oil for Extremely Cold Climates

To improve engine cold start performance, we recommend that you use the following alternative engine oil in extremely cold climates, where the ambient temperature reaches -22.0°F (-30°C) or below.

Capacities and Specifications

Materials

Name	Specification
Engine Oil - SAE 0W-30 - Synthetic Blend	WSS-M2C963-A1

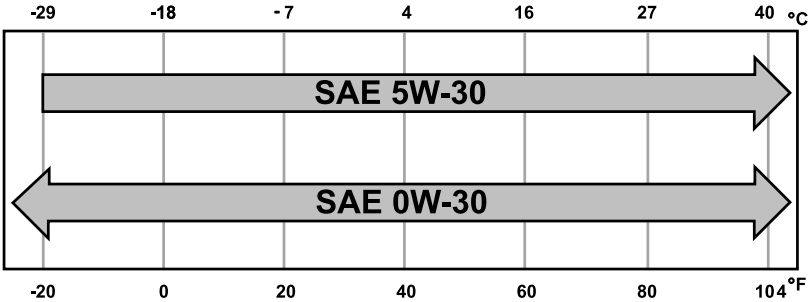

Fuel Tank

Capacities

Variant	Quantity
All.	18.8 gal (71.2 L)

Grease

Materials

Name	Specification
Motorcraft® Premium Long-Life Grease(U.S.) Motorcraft® Premium Long-Life Grease / Graisse longue durée de qualité première Motor- craft®(Canada) XG-1-E1(U.S. & Canada)	ESA-MIC75-B
Motorcraft® Multi-Purpose Grease Spray(U.S.) Motorcraft® Multi-Purpose Grease Spray / Graisse tout usage en aérosol Motorcraft®(Canada) XL-5-A(U.S. & Canada)	ESB-MIC93-B

Capacities and Specifications

Hydraulic Brake System

Materials

Name	Specification
Motorcraft® DOT 4 LV High Performance Motor Vehicle Brake Fluid(U.S.) Motorcraft® DOT 4 LV High Performance Motor Vehicle Brake Fluid / Liquide de frein automobile haute performance DOT 4 LV Motorcraft®(Canada) PM-20(U.S. & Canada)	WSS-M6C65-A2

Note: We recommend using DOT 4 Low Viscosity (LV) High Performance Brake Fluid or equivalent meeting WSS-M6C65-A2. Use of any fluid other than the recommended fluid could cause reduced brake performance and not meet our performance standards. Keep brake fluid clean and dry. Contamination with dirt, water, petroleum products or other materials could result in brake system damage and possible failure.

Locks

Materials

Name	Specification
Motorcraft® Penetrating and Lock Lubricant(U.S.) Motorcraft® Penetrating Fluid / Liquide dégrissant Motorcraft®(Canada) XL-1(U.S.) CXC-51-A(Canada)	-

Transfer Case

Capacities

Variant	Quantity
Power Transfer Unit (PTU) fluid (four-wheel drive).	23.67 fl oz (700 ml)

Capacities and Specifications

Materials

Name	Specification
Motorcraft® MERCON® LV Automatic Transmission Fluid(U.S.) Motorcraft® MERCON® LV Automatic Transmission Fluid / Huile pour boîte automatique MERCON® LV Motorcraft®(Canada) XT-10-QLVC(U.S.) CXT-10-LV6(Canada)	WSS-M2C938-AMERCON® LV,

Front Axle

Capacities

Variant	Quantity
Four-wheel drive.	0.82 ± 0.03 qt (0.775 ± 0.025 L)

Materials

Name	Specification
Motorcraft® SAE 80W-90 Premium Rear Axle Lubricant(U.S.) Motorcraft® SAE 80W-90 Premium Axle Lubricant / Lubrifiant pour essieux de très haute qualité SAE 80W-90 Motorcraft®(Canada) XY-80W90-QL(U.S.) CXY-80W90-1L(Canada)	WSP-M2C197-A

Rear Axle

Capacities

Variant	Quantity
Standard axle.	1.9 qt (1.78 L)
Locking axle.	1.7 qt (1.595 L)

Capacities and Specifications

Materials

Name	Specification
Motorcraft® SAE 80W-90 Premium Rear Axle Lubricant (U.S.) Motorcraft® SAE 80W-90 Premium Axle Lubricant / Lubrifiant pour essieux de très haute qualité SAE 80W-90 Motorcraft® (Canada) XY-80W90-QL (U.S.) CXY-80W90-1L (Canada)	WSP-M2C197-A

Washer Reservoir

Capacities

Variant	Quantity
All.	Fill as required.

Materials

Name	Specification
Motorcraft® Premium Windshield Wash Concentrate with Bitterant (U.S.) Motorcraft® Premium Quality Windshield Washer Fluid / Liquide lave-glace de haute qualité Motorcraft® (Canada) ZC-32-B2 (U.S.) CXC-37-F/M (Canada)	WSS-M14P19-A

BULB SPECIFICATION CHART

Bulb	Specification	Power (Watts)
Headlamp low beam.	H11LL	55
Headlamp high beam.	HB3LL	60
Headlamps. ¹	LED	LED
Front park/direction indicator bulb (Clear).	W21/5W	21/5

Capacities and Specifications

Bulb	Specification	Power (Watts)
Front park/direction indicator bulb (Amber).	7444NA	28/8
Front side marker bulb.	194	3.78
Front fog lamp bulb.	H11	55
Front fog lamps. ¹	LED	LED
Rear brake/park bulb.	W21/5W	21/5
Rear direction indicator bulb.	WY21W	21
Rear direction/park/stop lamp. ¹	LED	LED
Reverse lamp. ¹	LED	LED
Reverse lamp bulb - type 1.	W21W	21
Rear direction/park/stop lamp bulb.	3157K	26.9
Reverse lamp bulb - type 2.	3157K	26.9
License plate lamp.	W5W	5
Center high mounted brake lamp.	912	12.8
Center high mounted brake lamp. ¹	LED	LED
Cargo lamp bulb.	912	12.8
Cargo lamp. ¹	LED	LED

¹Optional LED lamps.

Note: LED lamps are not serviceable. See an authorized dealer if they fail.

Connected Vehicle

WHAT IS A CONNECTED VEHICLE

A connected vehicle has technology that allows your vehicle to connect to a mobile network and for you to access a range of features. When used in conjunction with the FordPass app, it could allow you to monitor and control your vehicle further, for example checking the tire pressures, the fuel level and the vehicle location. For additional information, refer to the local Ford website.

CONNECTED VEHICLE REQUIREMENTS

Connected service and related feature functionality requires a compatible vehicle network.

Some remote features require additional service activation. Log in to your Ford account for details. Some restrictions, third party terms and message or data rates may apply.

CONNECTED VEHICLE LIMITATIONS

Evolving technology, cellular networks, or regulations could affect functionality and availability, or continued provision of some features. These changes could even stop some features from functioning.

CONNECTING THE VEHICLE TO A MOBILE NETWORK

WHAT IS THE MODEM



The modem allows access to a range of features built into your vehicle.

ENABLING AND DISABLING THE MODEM - VEHICLES WITH: AM/FM/USB/BLUETOOTH

1. Using the information display control on the steering wheel, select **Settings**.
2. Select **FordPass**.
3. Select **Connectivity**.
4. Switch connectivity features on or off.

ENABLING AND DISABLING THE MODEM - VEHICLES WITH: SYNC 3

1. Press **Settings**.
2. Press **FordPass Connect**.
3. Press **Connectivity Settings**.
4. Switch connectivity features on or off.

CONNECTING FORDPASS TO THE MODEM

1. Make sure that the modem is enabled using the vehicle settings menu.
2. Open the FordPass app on your device and log in.
3. Add your vehicle or select your vehicle if already added.
4. Select the option to activate your vehicle.
5. Make sure that the name on the screen matches the name shown in your FordPass account.
6. Confirm that FordPass account is connected to the modem.

CONNECTING THE VEHICLE TO A WI-FI NETWORK - VEHICLES WITH: SYNC 3

1. Press **Settings**.
2. Press **Wi-Fi**.

Connected Vehicle

3. Switch **Wi-Fi** on.

4. Press **View Available Networks**.

5. Select an available Wi-Fi network.

Note: *Enter the network password to connect to a secure network.*

CONNECTED VEHICLE – TROUBLESHOOTING - VEHICLES WITH: MODEM

Symptom	Possible Cause and Resolution
I cannot confirm the connection of my FordPass account to the modem.	<ul style="list-style-type: none">- Modem is not enabled.<ul style="list-style-type: none">• Switch connectivity features on.- Weak network signal.<ul style="list-style-type: none">• Move your vehicle closer to a place where the network signal is not obstructed.

Connected Vehicle

CONNECTED VEHICLE – TROUBLESHOOTING - VEHICLES WITH: SYNC 3

Symptom	Possible Cause and Resolution
I cannot connect to a Wi-Fi network.	<ul style="list-style-type: none"> – Password error. <ul style="list-style-type: none"> • Enter the correct network password. – Weak network signal. <ul style="list-style-type: none"> • Move your vehicle closer to the Wi-Fi hotspot or to a place where the network signal is not obstructed. – Multiple access points in range with the same SSID. <ul style="list-style-type: none"> • Use a unique name for your SSID. Do not use the default name unless it contains a unique identifier, for example as part of the MAC address.
The Wi-Fi connection disconnects after successful connection.	<ul style="list-style-type: none"> – Weak network signal. <ul style="list-style-type: none"> • Move your vehicle closer to the Wi-Fi hotspot or to a place where the network signal is not obstructed.
I am close to a Wi-Fi hotspot but the network signal strength is weak.	<ul style="list-style-type: none"> – Obstructed network signal. <ul style="list-style-type: none"> • If your vehicle has a heated windshield, position your vehicle so that the windshield is not facing the Wi-Fi hotspot. • If your vehicle has metallic tinting on the windows but not on the windshield, position your vehicle so that the windshield is facing the Wi-Fi hotspot or open the windows that are facing the hotspot. • If your vehicle has metallic tinting on the windows and the windshield, open the windows that are facing the hotspot. • If your vehicle is in a garage and you have the garage door closed, open the garage door.
I cannot see a network in the list of available networks that I expect to see.	<ul style="list-style-type: none"> – Hidden network. <ul style="list-style-type: none"> • Make the network visible and try again.

Connected Vehicle

Symptom	Possible Cause and Resolution
I cannot see the Wi-Fi hotspot name when I search for Wi-Fi networks on my cell phone or other device.	<ul style="list-style-type: none">- System limitation.<ul style="list-style-type: none">• Make sure Wi-Fi hotspot visibility is on.• The system does not provide a Wi-Fi hotspot at this time.
Software downloads take too long.	<ul style="list-style-type: none">- Weak network signal.<ul style="list-style-type: none">• Move your vehicle closer to the Wi-Fi hotspot or to a place where the network signal is not obstructed.- Wi-Fi hotspot in high demand or has a slow Internet connection.<ul style="list-style-type: none">• Use a more reliable Wi-Fi hotspot.
The system seems to connect to a Wi-Fi network and the signal strength is excellent but the software does not update.	<ul style="list-style-type: none">- No software update available.- Wi-Fi network requires a subscription or acceptance of terms and conditions.<ul style="list-style-type: none">• Test the connection using another device. If the network requires a subscription or acceptance of terms and conditions, contact the network service provider.

Vehicle Wi-Fi Hotspot (If Equipped)

CREATING A VEHICLE WI-FI HOTSPOT - VEHICLES WITHOUT: SYNC

Use your FordPass app to create and change the name and password of your Wi-Fi hotspot. Visit your regional website for more information on the FordPass app.

Make sure your FordPass account is connected to the Connectivity Device. See **Connecting FordPass to the Modem** (page 337).

Note: *The Wi-Fi Hotspot may be defaulted to off. If so you will need to switch it on using the FordPass app.*

Connecting a Device to the Wi-Fi Hotspot

1. On your device, turn on Wi-Fi and select the hotspot from the list of available Wi-Fi networks.
2. When prompted, enter the password.

Purchasing a Data Plan

1. Connect a device to the hotspot.

Note: *The vehicle network carrier's portal opens on your device.*

2. If the portal does not open on your device, open a website and it redirects to the vehicle network carrier's portal.

Note: *Secure websites do not redirect.*

Note: *If you have an active plan, the system does not redirect to the vehicle network carrier's portal when you connect a device. Visit the vehicle network carrier's website to purchase more data.*

Note: *If data usage information is available in the vehicle hotspot menu, it is approximate.*

Note: *If you carry out a master reset, the system does not remove your vehicle from your vehicle network carrier's account. To remove your vehicle from the account, contact your vehicle network carrier.*

Note: *The vehicle network carrier provides Vehicle Hotspot services, subject to your vehicle network carrier agreement, coverage and availability.*

CREATING A VEHICLE WI-FI HOTSPOT - VEHICLES WITH: SYNC 3

You can create a Wi-Fi hotspot in your vehicle and allow devices to connect to it for access to the Internet.

1. Select **Settings**.
2. Select **FordPass Connect**.
3. Select **Vehicle Hotspot**.

Note: *The vehicle hotspot default setting is on.*

4. Select **Settings**.
5. Select **Edit**.
6. Select **Wi-Fi Visibility**.

Note: *The Wi-Fi Visibility default setting is on.*

Finding the Wi-Fi Hotspot Name and Password

1. Select **Settings**.
2. Select **FordPass Connect**.
3. Select **Vehicle Hotspot**.
4. Select **Settings**.

Note: *The SSID is the hotspot name.*

5. Select **View Password**.

Vehicle Wi-Fi Hotspot (If Equipped)

Connecting a Device to the Wi-Fi Hotspot

1. On your device, turn on Wi-Fi and select the hotspot from the list of available Wi-Fi networks.
2. When prompted, enter the password.

Purchasing a Data Plan

1. Connect a device to the hotspot.

Note: *The vehicle network carrier's portal opens on your device.*

2. If the portal does not open on your device, open a website and it redirects to the vehicle network carrier's portal.

Note: *Secure websites do not redirect.*

Note: *If you have an active plan, the system does not redirect to the vehicle network carrier's portal when you connect a device. Visit the vehicle network carrier's website to purchase more data.*

Note: *If data usage information is available in the vehicle hotspot menu, it is approximate.*

Note: *If you carry out a master reset, the system does not remove your vehicle from your vehicle network carrier's account. To remove your vehicle from the account, contact your vehicle network carrier.*

Note: *The vehicle network carrier provides Vehicle Hotspot services, subject to your vehicle network carrier agreement, coverage and availability.*

CHANGING THE VEHICLE WI-FI HOTSPOT NAME OR PASSWORD

1. Select **Settings**.
2. Select **FordPass Connect**.
3. Select **Vehicle Hotspot**.
4. Select **Settings**.

5. Select **Edit**.
6. Select **Change SSID Name**.
7. Enter your required SSID.
8. Select **Done**.
9. Select **Change Password**.
10. Enter your required password.
11. Select **Done**.

Audio System

GENERAL INFORMATION

Radio Frequencies and Reception Factors

AM and FM frequencies are established by the Federal Communications Commission (FCC) and the Canadian Radio and Telecommunications Commission (CRTC). Those frequencies are:

- AM: 530-1710 kHz
- FM: 87.9-107.9 MHz

Note: *Listening to loud audio for long periods of time could damage your hearing.*

Radio Reception Factors	
Distance and strength	The further you travel from an AM or FM station, the weaker the signal and the weaker the reception.
Terrain	Hills, mountains, tall buildings, bridges, tunnels, freeway overpasses, parking garages, dense tree foliage and thunderstorms can interfere with the reception.
Station overload	When you pass a ground-based broadcast repeating tower, a stronger signal may overtake a weaker one and result in the audio system muting.

AUDIO UNIT - VEHICLES WITHOUT: SYNC



WARNING: Driving while distracted can result in loss of vehicle control, crash and injury. We strongly recommend that you use extreme caution when using any device that may take your focus off the road. Your primary responsibility is the safe operation of your vehicle. We recommend against the use of any hand-held device while driving and encourage the use of voice-operated systems when possible. Make sure you are aware of all applicable local laws that may affect the use of electronic devices while driving.



Audio System

Accessing the Clock Settings



Press and release the button to access the clock setting.

Use the center arrow controls to change the hours and minutes.

Accessing the Media Source Menu



Press and release the button to open the media source menu.

You can press this multiple times to change to a media device or scroll through the media sources using the arrow buttons. Press **OK** to select a source.

Accessing the Menu



Press and release the button to access different audio system features.

Accessing the Phone Features



Press and release the button to access the phone features of the system.

Accessing the Sound Settings



Press and release the button to access settings for Treble, Midrange, Bass, Fade and Balance.

Adjusting the Volume

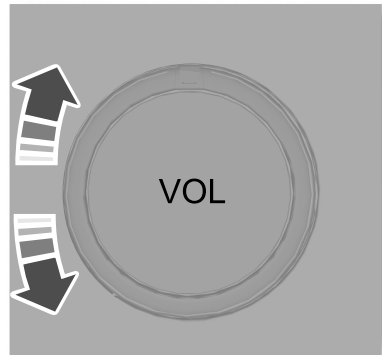

Turn to adjust the volume.

Changing Radio Stations

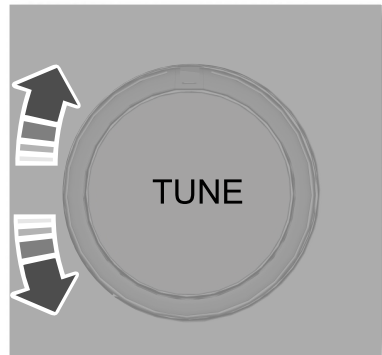

In radio mode, turn to search through the radio frequency band.

Listening to the Radio



Press and release the button to listen to the radio or change the radio frequency band.

Audio System

Muting the Audio



Press and release the button to mute the playing audio.

Switching the Audio Unit On and Off



Press and release the button.

Using the Display Control

Use the up and down arrow buttons to select the various settings. When you make your selection, press the left and right arrow buttons to change the settings.



Press and release to confirm a selection.

Press and release the function buttons below the display to select different functions of the audio system depending on which mode you are in.

Using the Number Block

In radio mode, store and recall your favorite radio stations. To store a favorite station, press and hold until the sound returns. In phone mode, enter a phone number.

Using Seek, Fast Forward and Reverse



In radio mode, select a frequency band and press and release either button. The system stops at the first station it finds in that direction.

AUDIO UNIT - VEHICLES WITH: SYNC

 **WARNING:** Driving while distracted can result in loss of vehicle control, crash and injury. We strongly recommend that you use extreme caution when using any device that may take your focus off the road. Your primary responsibility is the safe operation of your vehicle. We recommend against the use of any hand-held device while driving and encourage the use of voice-operated systems when possible. Make sure you are aware of all applicable local laws that may affect the use of electronic devices while driving.



Accessing the Apps Menu



Press and release the button to access the apps menu. Follow the on-screen prompts to make your selection.

Accessing the Clock Settings



Press and release the button to access the clock setting.

Use the center arrow controls to change the hours and minutes.

Audio System

Accessing the Media Source Menu



Press and release the button to open the media source menu.

You can press this multiple times to change to a SYNC-Media device or scroll through the media sources using the arrow buttons. Press **OK** to select a source.

Accessing the Information Menu



Press and release the button to access the information menu. Follow the on-screen prompts to make your selection.

Accessing the Phone Features



Press and release the button to access the phone features of the SYNC system.

Accessing the Settings Menu



Press and release the button to access the settings menu. Follow the on-screen prompts to make your selection.

Accessing the Sound Settings



Press and release the button to access settings for Treble, Midrange, Bass, Fade and Balance.

Adjusting the Volume

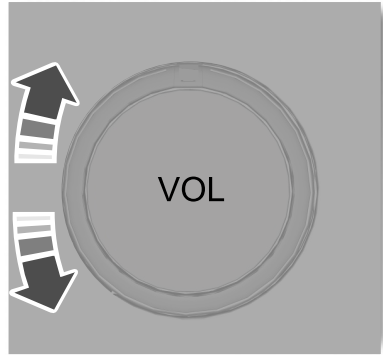

Turn to adjust the volume.

Changing Radio Stations

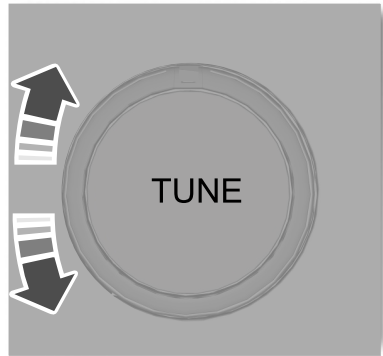

In radio mode, turn to search through the radio frequency band.

Listening to the Radio



Press and release the button to listen to the radio or change the radio frequency band.

Audio System

Playing or Pausing Media



Press and release the button to either play or pause the audio.

Switching the Audio Unit On and Off



Press and release the button.

Switching the Display On and Off



Press and release the button.

Switching Repeat Mode On and Off



Press and release the button to repeat the current media source.

Switching Shuffle Mode On and Off



Press and release the button to shuffle the current media source.

Using a Cell Phone



Press and release to either answer an incoming phone call or to make a phone call.



Press and hold to end a phone call.

Using the Display Control

Use the up and down arrow buttons to select the various settings. When you make your selection, press the left and right arrow buttons to change the settings.



Press and release to confirm a selection.

Using the Number Block

In radio mode, store and recall your favorite radio stations. To store a favorite station press and hold until the sound returns.

In phone mode, enter a phone number.

Using Seek, Fast Forward and Reverse



In radio mode, select a frequency band and press and release either button. The system stops at the first station it finds in that direction.

AUDIO UNIT - VEHICLES WITH: SYNC 3



WARNING: Driving while distracted can result in loss of vehicle control, crash and injury. We strongly recommend that you use extreme caution when using any device that may take your focus off the road. Your primary responsibility is the safe operation of your vehicle. We recommend against the use of any hand-held device while driving and encourage the use of voice-operated systems when possible. Make sure you are aware of all applicable local laws that may affect the use of electronic devices while driving.

Note: *The touchscreen system controls most of the audio features.*

Note: *Some features, such as satellite radio, may not be available in your location. Check with an authorized dealer.*

Audio System



Adjusting the Volume

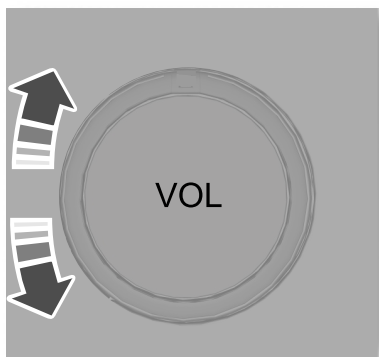

Turn to adjust the volume.

Changing Radio Stations

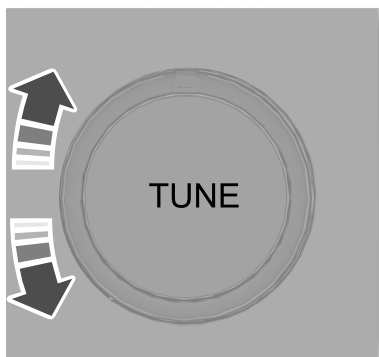

In radio mode, turn to search through the radio frequency band.

In satellite radio mode, turn to find the previous or next available satellite radio station.

Playing or Pausing Media



Press and release the button to either play or pause the audio.

Switching the Audio Unit On and Off



Press and release the button.

Using Seek, Fast Forward and Reverse



In radio mode, select a frequency band and press and release either button. The system stops at the first station it finds in that direction.

In satellite radio mode, press and release to select the next or previous satellite radio station. If you select a specific category such as jazz, rock or news, press to find the next or previous station in that category.

CONNECTING A BLUETOOTH® DEVICE - VEHICLES WITH: AM/FM/USB/BLUETOOTH, VEHICLES WITHOUT: SYNC

Pairing a Device



Press the button.

Audio System

Select **BT Devices** and follow the instructions on the screen.

Note: When pairing a new device, you can choose to download contacts and set this as the primary device.

RADIO

Antenna

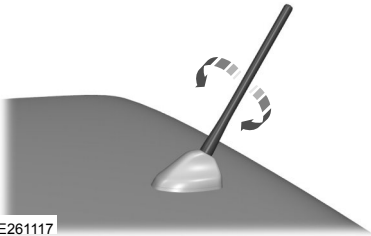

You can temporarily remove the mast by unscrewing it from the base. Make sure you firmly screw in the mast when reattaching it to maintain optimum radio reception.

Note: Remove the antenna mast before entering a car wash.

SATELLITE RADIO (IF EQUIPPED)

SiriusXM® Satellite Radio broadcasts a variety of music, news, sports, weather, traffic and entertainment satellite radio channels. For more information and a complete list of SiriusXM satellite radio channels, visit www.siriusxm.com in the United States, www.siriusxm.ca in Canada, or call SiriusXM at 1-888-539-7474.

Note: This receiver includes the eCos real-time operating system. eCos is published under the eCos License.

Satellite Radio Reception Factors

Potential Satellite Radio Reception Issues	
Antenna obstructions	For optimal reception performance, keep the antenna clear of snow and ice build-up and keep luggage and other material as far away from the antenna as possible. Factory-installed and aftermarket vehicle structures including, but not limited to, roof racks and soft top roofs in a partially open position could reduce reception performance.
Terrain	Hills, mountains, tall buildings, bridges, tunnels, freeway overpasses, parking garages, dense tree foliage and thunderstorms can interfere with your reception.
Station overload	When you pass a ground-based broadcast-repeating tower, a stronger signal could overtake a weaker one and the audio system may mute.
Satellite radio signal interference	Your display may show ACQUIRING . . . to indicate the interference and the audio system could mute.

Audio System

SiriusXM Satellite Radio Service

Note: *SiriusXM reserves the unrestricted right to change, rearrange, add or delete programming including canceling, moving or adding particular channels, and its prices, at any time, with or without notice to you. Neither SiriusXM and its affiliates, nor Ford Motor Company and its affiliates will be liable to you or any third party for any such modifications, suspension, or termination.*



SiriusXM satellite radio is a subscription-based satellite radio service that broadcasts a variety of music, sports, news, weather, traffic and entertainment programming. Your factory-installed SiriusXM satellite radio system includes hardware and a limited subscription term, which begins on the date of sale or lease of your vehicle. See an authorized dealer for availability.

For more information on extended subscription terms, a service fee is required, the online media player and a complete list of SiriusXM satellite radio channels, and other features, please visit www.siriusxm.com in the United States, www.siriusxm.ca in Canada, or call SiriusXM at 1-888-539-7474.

Satellite Radio Electronic Serial Number (ESN)

You need your ESN to activate, modify or track your satellite radio account. When in satellite radio mode, tune to channel 0.

Troubleshooting

Message	Condition	Action
Acquiring...	Radio requires more than two seconds to produce audio for the selected channel.	No action required. This message should disappear shortly.
Satellite antenna fault SIRIUS system failure	There is an internal module or system failure present.	If this message does not clear shortly, or with an ignition key cycle, your receiver may have a fault. See an authorized dealer for service.
Invalid Channel	The channel is no longer available.	Tune to another channel or choose another preset.
Unsubscribed Channel	Your subscription does not include this channel.	Contact SiriusXM at 1-888-539-7474 to subscribe to the channel, or tune to another channel.

Audio System

Message	Condition	Action
No Signal	The signal is lost from the SiriusXM satellite or SiriusXM tower to your vehicle antenna.	The signal is blocked. When you move into an open area, the signal should return.
Updating...	Update of channel programming in progress.	No action required. The process may take up to three minutes.
Questions? Call 1-888-539-7474	Your satellite service is no longer available.	Contact SiriusXM at 1-888-539-7474 to resolve subscription issues.
None found Check Channel Guide	All the channels in the selected category are either skipped or locked.	Use the channel guide to turn off the Lock or Skip function on that station.
Subscription Updated	SiriusXM has updated the channels available for your vehicle.	No action required.

DIGITAL RADIO (IF EQUIPPED)

Note: *HD Radio broadcasts are not available in all markets.*

HD Radio technology is the digital evolution of analog AM/FM radio. Your system has a special receiver that allows it to receive digital broadcasts, where available, in addition to the analog broadcasts, it already receives. Digital broadcasts provide a better sound quality than analog broadcasts with free, crystal-clear audio and no static or distortion. For more information, and a guide to available stations and programming, please visit www.hdradio.com.

When HD Radio is on and you tune to a station broadcasting HD Radio technology, you may notice the HD Radio logo on your screen. When this logo is available, you may also see Title and Artist fields on-screen.

The multicast indicator appears in FM mode, only, if the current station is broadcasting multiple digital broadcasts. The highlighted numbers signify available digital channels where new or different content is available. HD1 signifies the main programming status and is available in analog and digital broadcasts. Other multicast stations, HD2 through HD7, are only available digitally.

When HD Radio broadcasts are active, you can access the following functions:

- **Memory presets** allow you to save an active channel as a memory preset. Touch and hold a memory preset slot until the sound returns. There is a brief mute while the radio saves the station. Sound returns when finished. When switching to an HD2 or HD3 memory preset, the sound mutes before the digital audio plays, because the system has to reacquire the digital signal.

Audio System

Note: As with any saved radio station, you cannot access the saved station if your vehicle is outside the station's reception area.

HD Radio Reception and Station Troubleshooting

Potential Reception Issues	
Reception area	If you are listening to a multicast station and you are on the fringe of the reception area, the station may mute due to weak signal strength.
	If you are listening to HD1, the system switches back to the analog broadcast until the digital broadcast is available again. However, if you are listening to any of the possible HD2-HD7 multicast channels, the station mutes and stays muted unless it is able to connect to the digital signal again.
Station blending	When the system first receives a station, aside from HD2-HD7 multicast stations, it first plays the station in the analog version. Once the receiver verifies the station is an HD Radio station, it shifts to the digital version. Depending on the station quality, you may hear a slight sound change when the station changes from analog to digital. Blending is the shift from analog to digital sound or digital back to analog sound.

In order to provide the best possible experience, use the contact form to report any station issues found while listening to a station broadcasting with HD Radio technology. Independent entities own and operate each station. These stations are responsible for the accuracy of all audio streams and data fields.

Audio System

Potential Station Issues		
Issues	Cause	Action
Echo, stutter, skip or repeat in audio. Increase or decrease in audio volume.	This is poor time alignment by the radio broadcaster.	No action required. This is a broadcast issue.
Sound fading or blending in and out.	The radio is shifting between analog and digital audio.	No action required. The reception issue may clear up as you continue to drive.
There is an audio mute delay when selecting HD2 or HD3, multicast preset or direct tune.	The digital multicast is not available until the HD Radio broadcast is decoded. Once decoded, the audio is available.	No action required. This is normal behavior. Wait until the audio is available.
Cannot access the HD2 or HD3 multicast channels when recalling a preset or from a direct tune.	The previously stored multicast preset or direct tune is not available in your current reception area.	No action required. The station is not available in your current location.
Text information does not match currently playing audio.	Data service issue by the radio broadcaster.	Fill out the station issue form at website listed below. ¹
There is no text information shown for currently selected frequency.	Data service issue by the radio broadcaster.	Fill out the station issue form at website listed below. ¹

¹ <http://hdradio.com/stations/feedback>.

HD Radio Technology manufactured under license from iBiquity Digital Corporation and foreign patents. HD Radio and the HD and HD Radio logos are proprietary trademarks of DTS. Ford and DTS are not responsible for the content sent using HD Radio technology. Content may be changed, added or deleted at any time at the station owner's discretion.

AUDIO INPUT JACK



WARNING: Driving while distracted can result in loss of vehicle control, crash and injury. We strongly recommend that you use extreme caution when using any device that may take your focus off the road. Your primary responsibility is the safe operation of your vehicle. We recommend against the use of any

Audio System

hand-held device while driving and encourage the use of voice-operated systems when possible. Make sure you are aware of all applicable local laws that may affect the use of electronic devices while driving.



WARNING: Always place your device in a secure location in your vehicle so it does not become a projectile in a sudden stop or crash. Failure to follow this instruction could result in personal injury.

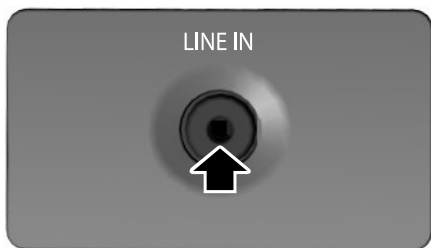

E191758

The auxiliary input jack allows you to connect and play music from your portable music player through your vehicle speakers.

You can use any portable music player designed for use with headphones.

Your audio extension cable must have male connectors at each end.

1. Make sure your vehicle is stationary with the audio system and the portable music player switched off.
2. Plug the extension cable from the device into the audio input jack.
3. Switch your audio system on, and select the desired FM station.
4. Adjust the volume as desired.
5. Switch on your device and adjust the volume to half the maximum level.

6. Press **AUX** until **LINE** or **LINE IN** appears in the display. You should hear music from your device even if it is low.
7. Adjust the volume on your device until it reaches the volume level of the FM station. Do this by switching back and forth between the **AUX** and FM controls.

Use the vehicle audio unit buttons to restore playback from the vehicle audio unit, while your device remains connected.

Note: *The audio extension cable must be long enough for you to safely store the device when your vehicle is moving.*

Note: *For optimum performance when using any auxiliary device set the volume on the device high. This reduces audio interference when charging the device using the vehicle power supply.*

Note: *For safety reasons, do not connect or adjust the settings on your device while your vehicle is moving.*

USB PORT (IF EQUIPPED)



WARNING: Driving while distracted can result in loss of vehicle control, crash and injury. We strongly recommend that you use extreme caution when using any device that may take your focus off the road. Your primary responsibility is the safe operation of your vehicle. We recommend against the use of any hand-held device while driving and encourage the use of voice-operated systems when possible. Make sure you are aware of all applicable local laws that may affect the use of electronic devices while driving.

Audio System

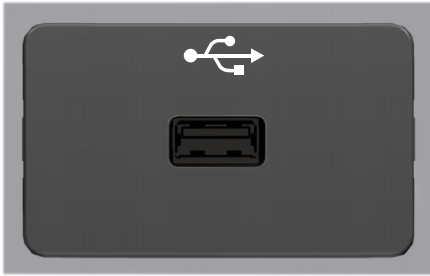

The USB port allows you to plug in media playing devices, memory sticks and charge devices.

Note: Not all USB ports in your vehicle have data transfer capabilities. See **Auxiliary Power Points** (page 138).

USING VOICE RECOGNITION - VEHICLES WITHOUT: SYNC

Voice Pass Through

This system allows you to use the voice recognition features of your phone.



Press the voice control button on the steering wheel.

Note: This only works when connected via Bluetooth. See **Connecting a Bluetooth® Device** (page 348).

Note: When using voice pass through use the language set on the device.

MEDIA HUB (IF EQUIPPED)



WARNING: Driving while distracted can result in loss of vehicle control, crash and injury. We strongly recommend that you use extreme caution when using any device that may take your focus off the road. Your primary responsibility is the safe operation of your vehicle. We recommend against the use of any hand-held device while driving and encourage the use of voice-operated systems when possible. Make sure you are aware of all applicable local laws that may affect the use of electronic devices while driving.

The media hub may be on the instrument panel or center console.

The media hub may contain one or more of the following inputs:

See **USB Port** (page 354).

See **Audio Input Jack** (page 353).

GENERAL INFORMATION

SYNC is an in-vehicle communications system that works with your Bluetooth enabled cellular phone and portable media player. This allows you to:

- Make and receive calls.
- Access and play music from your portable music player.
- Use 911 Assist or Emergency Assistance and applications via SYNC AppLink.*
- Access phonebook contacts and music using voice commands.
- Stream music from your connected phone.
- Text message.
- Use the advanced voice recognition system.
- Charge your USB device (if your device supports this).

*These features are not available in all markets and may require activation. Available AppLink enabled apps vary by market.

Make sure that you review your device's manual before using it with SYNC.

Support

SYNC support is available at your regional Ford website. See **SYNC™ Troubleshooting** (page 362).

SYNC Owner Account

Why do I need a SYNC owner account?

- Essential for keeping up with the latest software downloads available for SYNC.
- Access to customer support for any questions you may have.

Driving Restrictions

For your safety, certain features are speed-dependent and restricted when your vehicle is traveling over 3 mph (5 km/h).

Safety Information



WARNING: Driving while distracted can result in loss of vehicle control, crash and injury. We strongly recommend that you use extreme caution when using any device that may take your focus off the road. Your primary responsibility is the safe operation of your vehicle. We recommend against the use of any hand-held device while driving and encourage the use of voice-operated systems when possible. Make sure you are aware of all applicable local laws that may affect the use of electronic devices while driving.

When using SYNC:

- Do not operate playing devices if the power cords or cables are broken, split or damaged. Place cords and cables out of the way, so they do not interfere with the operation of pedals, seats, compartments or safe driving abilities.
- Do not leave playing devices in your vehicle during extreme conditions as it could cause them damage. See your device's manual for further information.
- Do not attempt to service or repair the system. See an authorized dealer.

Privacy Information

When a cellular phone is connected to SYNC, the system creates a profile within your vehicle that is linked to that cellular phone. This profile is created in order to offer you more cellular features and to operate more efficiently. Among other things, this profile may contain data about your cellular phone book, text messages

(read and unread), and call history, including history of calls when your cellular phone was not connected to the system. In addition, if you connect a media device, the system creates and retains an index of supported media content. The system also records a short development log of approximately 10 minutes of all recent system activity. The log profile and other system data may be used to improve the system and help diagnose any problems that may occur.

The cellular profile, media device index, and development log will remain in the vehicle unless you delete them and are generally accessible only in the vehicle when you connect the cellular phone or media player. If you no longer plan to use the system or the vehicle, we recommend you perform a Master Reset to erase all stored information.

No one can access system data without special equipment and access to the vehicle's SYNC module. Ford Motor Company and Ford of Canada will not access the system data for any purpose other than as described absent consent, a

court order, or where required by law enforcement, other government authorities, or other third parties acting with lawful authority. Other parties may seek to access the information independently of Ford Motor Company and Ford of Canada. For further privacy information, see the section on 911 Assist. See **SYNC™ Applications and Services** (page 360).

USING VOICE RECOGNITION

This system helps you control many features using voice commands. This allows you to keep your hands on the wheel and focus on what is around you.

Initiating a Voice Session



Press the voice button. A list of available voice commands appear in the display.

Global Voice Commands

These voice commands are always available. You can say them at any time.

Global Voice Commands	
Help	Gives you available commands you can use on the current screen.
List of Commands	Gives you a list of possible voice commands.
Cancel	This command ends the voice session. You can also cancel a session by pressing seek up, seek down, or holding the voice button for two or more seconds.

Helpful Hints

- Make sure the interior of your vehicle is as quiet as possible. Wind noise from open windows and road vibrations may prevent the system from correctly recognizing spoken commands.
- Before giving a voice command, wait for the system announcement to finish, followed by a single tone. Any command spoken before this does not register with the system.
- Speak naturally, without long pauses between words.
- You can interrupt the system at any time while it is speaking by pressing the voice button. You can cancel a voice session by pressing and holding the voice button.

System Interaction and Feedback

The system provides feedback through audible tones, prompts, questions and spoken confirmations depending on the situation and the chosen level of interaction. You can customize the voice recognition system to provide more or less instruction and feedback.

The default setting is to a higher level of interaction in order to help you learn to use the system. You can change these settings at any time.

Adjusting the Interaction Level



Press the voice button. When prompted, say:

Voice Command	Action and Description
Interaction Mode Standard	Provides more detailed interaction and guidance. (Recommended for first time users.)
Interaction Mode Advanced	Provides less audible interaction and guidance.

Phone Confirmation

Using phone confirmations; the system asks you to verify before placing any calls.

To adjust this setting press the voice button, when prompted say:

Voice Command	Action and Description
Phone Confirmation Off	When enabled, this feature prompts you to confirm any voice initiated call command prior to placing the call.
Phone Confirmation On	The system makes a best guess; occasionally, the system asks you to confirm settings.

USING SYNC™ WITH YOUR PHONE

Hands-free calling is one of the main features of SYNC. While the system supports a variety of features, many are dependent on your cellular phone's functionality. At a minimum, most cellular phones with Bluetooth wireless technology support the following functions:

- Answering an incoming call.
- Ending a call.
- Dialing a number.
- Redialing.
- Call waiting notification.
- Caller identification.

Other features, such as text messaging using **Bluetooth®** and automatic phonebook download, are phone-dependent features.

Pairing a Phone

Wirelessly pairing your phone with SYNC allows you to make and receive hands-free calls.

Note: Make sure to switch on the ignition and the radio. Shift the transmission into park (P) for automatic transmission or neutral (N) for manual transmission.

Using the Audio System

Note: To scroll through the menus, press the up and down arrows on your audio system.

1. Make sure to switch on your phone's **Bluetooth®** feature before starting the search. See your device's manual if necessary.
2. Press the **Settings** button.
3. Select Bluetooth from the menu.
4. Press the **OK** button.

5. Select the option to add. This starts the pairing process.
6. When a message to begin pairing appears in the center display, search for SYNC on your device.

Depending on your phone's capability and your market, the system may prompt you with questions, such as setting the current phone as the primary phone and downloading your phonebook.

Using Voice Commands



Make sure to switch on your phone's **Bluetooth®** feature before starting the search. See your device's manual if necessary.

Press the voice button and when prompted say:

Voice Command	Action and Description
Pair Phone	Follow the instructions on the center display.

Phone Voice Commands



Press the voice button. You can do things like place a phone call and access text messages. When prompted, say a command. See the following table for examples of commands.

Voice Command
___ List of Commands
Help
Call ___
Dial ___
Text Messages

__ is a dynamic listing, meaning that it could be the name of anything, such as a contact or phone number.

Phone Controls

Use the phone buttons on your steering wheel to answer, reject, or hang up a call.

Accessing Features through the Phone Menu

You can access your call history, phonebook, sent text messages, as well as access phone and system settings.

1. Press the **PHONE** button to enter the phone menu.
2. Scroll through the menu to view contacts, text messages, and the phone dialer.

SYNC™ APPLICATIONS AND SERVICES

- SYNC AppLink: Allows you to connect to and use certain applications if your phone is compatible.

These features may require activation. Available AppLink enabled apps vary by market.

SYNC Mobile Apps

The system enables voice and steering wheel control of SYNC AppLink enabled smartphone apps. When an app is running through AppLink, you can control main features of the app through voice commands and steering wheel controls.

Note: You must pair and connect your smartphone to SYNC to access AppLink.

Note: Android users need to connect the phone to SYNC using **Bluetooth®**.

Note: For information about available apps, supported devices and troubleshooting, please refer to the local Ford website.

Note: Availability of SYNC AppLink enabled apps vary by region.

Note: Make sure you have an active account for the app that you have downloaded. Some apps work automatically with no setup. Other apps want you to configure your personal settings and personalize your experience by creating stations or favorites. We recommend you do this at home or outside of your vehicle.

To Access Using the SYNC Menu

Press the Mobile Apps button to access the menu on-screen. Then select:

Menu Item	Action and Description
Find Mobile Apps	Scroll through the list of available applications and select a particular app.

Note: If you cannot find a compatible SYNC AppLink app, make sure the required app is running on the mobile device.

To Access Using Voice Commands

Press the voice button, then when prompted say:

Voice Command	Action and Description
Mobile Applications	Say the name of the application after the tone. The app should start. When an app is running through SYNC, you can press the voice button and speak commands specific to the app, for example Play Playlist Road Trip.
List Applications	SYNC lists all of the currently available mobile apps.
Find Applications	Searches your connected mobile device for SYNC-compatible mobile apps.
Help	Use this command to discover the available voice commands.

App Permissions

App permissions are organized by groups. You can individually grant these group permissions. You can change a group permission status any time when not driving, by using the settings menu.

When you launch an app using SYNC, the system may ask you to grant certain permissions, for example:

- To allow your vehicle to provide vehicle information to the app such as, but not limited to: Fuel level, fuel economy, fuel consumption, engine speed, rain sensor, odometer, VIN, external temperature, gear position, tire pressure, and headlamp status.
- To allow your vehicle to provide driving characteristic information such as, but not limited to: MyKey, seatbelt status, engine revolutions per minute, gear position, braking events, steering wheel angle, and accelerator pedal position.

- To allow your vehicle to provide location information, including: GPS and speed.
- To allow the app to send push notifications using the touchscreen display and voice capabilities while running in a background state. Push notifications may be particularly useful for news or location based apps.

Note: *You only need to grant permissions the first time you use an app with SYNC.*

Note: *Ford is not responsible or liable for any damages or loss of privacy relating to usage of an app, or dissemination of any vehicle data that you approve Ford to provide to an app.*

Enabling SYNC Mobile Apps

To enable mobile apps, SYNC requires user consent to send and receive app authorization information and updates using the data plan associated with the connected device.

Data is sent to Ford in the United States through the connected device. The information is encrypted and includes, for example, the vehicle identification number of your vehicle, the SYNC module serial number, odometer, enabled apps, usage statistics and debugging information. Updates may take place.

Note: You must enable mobile apps for each connected device the first time you select a mobile app using the system.

Note: Standard data rates apply. Ford is not responsible for any additional charges you may receive from your service provider, when your vehicle sends or receives data through the connected device. This includes any additional charges incurred due to driving in areas when roaming out of a home network.

USING SYNC™ WITH YOUR MEDIA PLAYER

SYNC supports digital media sources including: iPod, **Bluetooth®** devices, and most USB drives. SYNC also supports audio formats, such as MP3, WMA, WAV and ACC.

Media Sources

The **AUX** or **MEDIA** button allows you to view and select available media sources.

Press the **AUX** or **MEDIA** button to view your sources. Use the directional arrows and OK button to select your source. You can also use the steering wheel audio controls.

Audio Voice Commands



Press the voice button. You can do things like play a specific song or album, or tune to a radio station. When prompted, say a command. See the following table for example commands. Not all commands may be available on your vehicle.

Command
___ List of Commands
Help
Pause
Play
AM ___
FM ___
CD Player
Sirius Channel ___
USB
Bluetooth Audio

___ is a dynamic listing, meaning that it could be the name of anything, such as an artist, station, or media source.

SYNC™ TROUBLESHOOTING

Your SYNC system is easy to use. However, should questions arise, see the tables below.

Use your local Ford website at any time to check your phone's compatibility, register your account and set preferences as well as access a customer representative via an online chat (during certain hours).

SYNC™ (If Equipped)

Market	Website(s)
North America	www.SYNCMyRide.com www.SYNCMyRide.ca www.syncmaroute.ca

Phone Issues		
Issue	Possible Cause(s)	Possible Solution(s)
There is excessive background noise during a phone call.	The audio control settings on your phone may be affecting SYNC performance.	Review your phone's manual about audio adjustments.
During a call, I can hear the other person but they cannot hear me.	This may be a possible phone malfunction.	Try turning off the device, resetting the device, removing the device's battery, then trying again.
SYNC is not able to download my phonebook.	<p>This is a phone-dependent feature.</p> <p>This may be a possible phone malfunction.</p>	<p>Go to the website to review your phone's compatibility.</p> <p>Try turning off the device, resetting the device or removing the device's battery, then trying again.</p> <p>Try pushing your phonebook contacts to SYNC by using the Add Contacts feature.</p> <p>Use the SYNCmyphone feature available on the website.</p>
The system says Phonebook Downloaded but the phonebook in SYNC is empty or missing contacts.	This may be a limitation on your phone's capability.	<p>Try pushing your phonebook contacts to SYNC by using the Add Contacts feature.</p> <p>If the missing contacts are stored on your SIM card, try moving them to the device memory.</p>

SYNC™ (If Equipped)

Phone Issues		
Issue	Possible Cause(s)	Possible Solution(s)
		<p>Remove any pictures or special ring tones associated with the missing contact.</p> <p>Depending upon your phone, you may have to grant SYNC permission to access your phonebook contacts. Make sure to confirm when prompted by your phone during the phonebook download.</p>
<p>I am having trouble connecting my phone to SYNC.</p>	<p>This is a phone-dependent feature.</p> <p>This may be a possible phone malfunction.</p>	<p>Go to the website to review your phone's compatibility.</p> <p>Try turning off the device, resetting the device or removing the device's battery, then trying again.</p> <p>Try deleting your device from SYNC, deleting SYNC from your device and trying again.</p> <p>Check the security and auto accept and prompt always settings relative to the SYNC Bluetooth® connection on your phone.</p> <p>Update your device's firmware.</p> <p>Turn off the Auto phonebook download setting.</p>

SYNC™ (If Equipped)

Phone Issues		
Issue	Possible Cause(s)	Possible Solution(s)
Text messaging is not working on SYNC.	<p>This is a phone-dependent feature.</p> <p>This may be a possible phone malfunction.</p>	<p>Go to the website to review your phone's compatibility.</p> <p>Try turning off the device, resetting the device or removing the device's battery, then trying again.</p>
I cannot return to the Phone menu when selecting a contact.	You are on the Select a Character screen.	Press the Phone button to return to the Phone menu.

USB and Media Issues		
Issue	Possible Cause(s)	Possible Solution(s)
I am having trouble connecting my device.	This may be a possible device malfunction.	<p>Try turning off the device, resetting the device, removing the device's battery, then trying again.</p> <p>Make sure you are using the manufacturer's cable.</p> <p>Make sure you insert the USB cable correctly into the device and the USB port.</p> <p>Make sure that the device does not have an auto-install program or active security settings.</p>
SYNC does not recognize my device when I turn on the car.	This is a device limitation.	Make sure you are not leaving the device in your vehicle during very hot or cold temperatures.
Bluetooth ® audio does not stream.	This is a phone-dependent feature.	Review the device compatibility chart on the SYNC website to confirm your phone supports the Bluetooth ® audio streaming function.

SYNC™ (If Equipped)

USB and Media Issues		
Issue	Possible Cause(s)	Possible Solution(s)
	The device is not connected.	Make sure you correctly connect the device to SYNC, and that you have pressed play on your device.
SYNC does not recognize music that is on my device.	<p>Your music files may not contain the correct artist, song title, album or genre information.</p> <p>The file may be corrupted.</p> <p>The song may have copy-right protection, which does not allow it to play.</p>	<p>Make sure that all song details are populated.</p> <p>Some devices require you to change the USB settings from mass storage to MTP class.</p>
I cannot change the Sirius station.	Sirius Replay is active.	Switch radio bands and return to Sirius or switch the feature off. You can then change the Sirius station using the directional buttons.

Voice Command Issues		
Issue	Possible Cause(s)	Possible Solution(s)
SYNC does not understand what I am saying.	<p>You may be using the wrong voice commands.</p> <p>You may be speaking too soon or at the wrong time.</p>	<p>Review the phone voice commands and the media voice commands at the beginning of their respective sections.</p> <p>After pressing the voice icon, wait until after the tone sounds and Listening appears before saying a command. Any command spoken before this does not register with the system.</p>
SYNC does not understand the name of a song or artist.	You may be using the wrong voice commands.	Review the media voice commands at the beginning of the media section.

SYNC™ (If Equipped)

Voice Command Issues		
Issue	Possible Cause(s)	Possible Solution(s)
	<p>You may be saying the name differently than the way you saved it.</p> <p>The system may not be reading the name the same way you are saying it.</p>	<p>Say the song or artist exactly as listed. If you say "Play Artist Prince", the system does not play music by Prince and the Revolution or Prince and the New Power Generation.</p> <p>Make sure you are saying the complete title, such as "California remix featuring Jennifer Nettles".</p> <p>If the song titles are in all CAPS, you have to spell them. LOLA requires you to say "L-O-L-A".</p> <p>Do not use special characters in the title. The system does not recognize them.</p>
<p>SYNC does not understand or is calling the wrong contact when I want to make a call.</p>	<p>You may be using the wrong voice commands.</p> <p>You may be saying the name differently than the way you saved it.</p>	<p>Review the Phone voice commands at the beginning of the phone section.</p> <p>Make sure you are saying the contacts exactly as they are listed. For example, if you save a contact as Joe Wilson, say "Call Joe Wilson".</p> <p>Using the SYNC phone menu, open the phonebook and scroll to the name SYNC is having trouble understanding. SYNC will read the name to you, giving you some idea of the pronunciation SYNC is expecting.</p>

SYNC™ (If Equipped)

Voice Command Issues		
Issue	Possible Cause(s)	Possible Solution(s)
	<p>The system may not be reading the name the same way you are saying it.</p> <p>Contacts in your phonebook may be very short and similar, or they may contain special characters.</p> <p>Your phonebook contacts may be in CAPS.</p>	<p>The system works better if you list full names, such as "Joe Wilson" rather than "Joe".</p> <p>Do not use special characters, such as 123 or ICE, as the system does not recognize them.</p> <p>If a contact is in CAPS, you have to spell it. JAKE requires you to say "Call J-A-K-E".</p>

AppLink Issues		
Issue	Possible Cause(s)	Possible Solution(s)
<p>AppLink Mobile Applications: When I select "Find New Apps," SYNC does not find any applications.</p>	<p>An AppLink capable phone is not connected to SYNC.</p>	<p>Ensure you have a compatible smartphone; an Android with OS 2.3 or higher or an iPhone 3GS or newer with iOS 5.0 or higher. Additionally, ensure your phone is paired and connected to SYNC in order to find AppLink-capable apps on your device. iPhone users must also connect to SYNC's USB port with an Apple USB cable.</p>
<p>My phone is connected, but I still cannot find any apps.</p>	<p>AppLink-enabled apps are not installed and running on your mobile device.</p>	<p>Ensure you have downloaded and installed the latest version of the app from your phone's app store. Ensure the app is running on your phone. Some apps require you to register or</p>

SYNC™ (If Equipped)

AppLink Issues		
Issue	Possible Cause(s)	Possible Solution(s)
		login on the app on the phone before using them with AppLink. Also, some may have a Ford SYNC setting, so check the app's settings menu on the phone.
My phone is connected, my app(s) are running, but I still cannot find any apps.	Sometime apps do not properly close and re-open their connection to SYNC, over ignition cycles, for example.	<p>Closing and restarting apps may help SYNC find the application if you cannot discover it inside the vehicle.</p> <p>On an Android device, if apps have an Exit or Quit option, select that then restart the app. If the app does not have that option, you can also manually Force Close the app by going to the phone's settings menu, selecting Apps, then finding the particular app and choosing Force stop. Remember to restart the app afterwards, then select Find New Apps on SYNC.</p> <p>On an iPhone with iOS7+, to force close an app, double tap the home button then swipe up on the app to close it. Touch the home button again, then select the app again to restart it. After a few seconds, the app should appear in the SYNC Mobile App menu.</p>

SYNC™ (If Equipped)

AppLink Issues		
Issue	Possible Cause(s)	Possible Solution(s)
My Android phone is connected, my app(s) are running, I restarted them, but I still cannot find any apps.	There is a Bluetooth® bug on some older versions of the Android operating system that may cause apps that were found on your previous vehicle drive to not be found again if you have not turned off Bluetooth® .	Reset the Bluetooth® on your phone by turning it off and then turning Bluetooth® back on. If you are in your vehicle, SYNC should be able to automatically re-connect to your phone if you press the Phone button.
My iPhone phone is connected, my app is running, I restarted the app but I still cannot find it on SYNC.	The USB connection to SYNC may need to be reset.	Unplug the USB cable from the phone, wait a moment, and plug the USB cable back in to the phone. After a few seconds, the app should appear in SYNC's Mobile Apps Menu. If not, "Force Close" the application and restart it.
I have an Android phone. I found and started my media app on SYNC, but there is no sound or the sound is very low.	The Bluetooth® volume on the phone may be low.	Try increasing the Bluetooth® volume of the device by using the device's volume control buttons which are most often found on the side of the device.
I can only see some of the AppLink apps running on my phone listed in SYNC's Mobile Apps Menu.	Some Android devices have a limited number of Bluetooth® links apps can use to connect. If you have more AppLink apps on your phone than the number of available Bluetooth® links, you will not see all of your apps listed in SYNC's mobile apps menu.	Force close or uninstall the apps you do not want SYNC to find. If the app has a "Ford SYNC" setting, disable that setting in the app's settings menu on the phone.

SYNC™ (If Equipped)

SYNC System Reset

The SYNC system in your vehicle has System Reset feature that can be performed if the function of a SYNC feature is lost. This reset is intended to restore functionality and will not erase any information previously stored in the system (Such as paired devices, phonebook, call history, text messages, or user settings). To perform a System Reset, press and hold the Seek Up (>>) button while pressing and holding the Radio Power button. Release both buttons after 2-3 seconds. Please allow a few minutes for the reset to complete. After a few minutes has passed you can resume using the SYNC system.

GENERAL INFORMATION



WARNING: Driving while distracted can result in loss of vehicle control, crash and injury. We strongly recommend that you use extreme caution when using any device that may take your focus off the road. Your primary responsibility is the safe operation of your vehicle. We recommend against the use of any hand-held device while driving and encourage the use of voice-operated systems when possible. Make sure you are aware of all applicable local laws that may affect the use of electronic devices while driving.

About SYNC

The system allows you to interact with the entertainment, information and communication systems on your vehicle using voice commands and a touchscreen. The system provides easy interaction with audio, phone, navigation, mobile apps and settings.

Note: You can switch the system on and use it for up to an hour without switching the ignition on.

Note: You can use the system after you switch the ignition off for up to 10 minutes or until you open a door.

Note: For your safety, some features are speed-dependent. Their use is limited to when your vehicle speed is less than 3 mph (5 km/h).

Using the Touchscreen

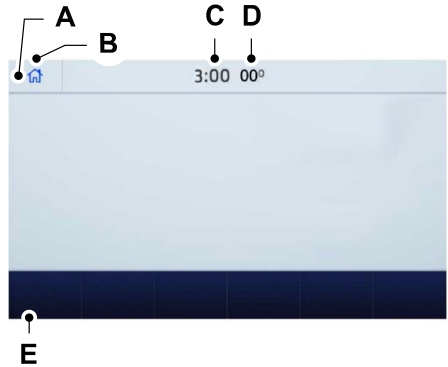

- A Status bar.
- B Home screen.
- C Clock. See **Entertainment** (page 380).
- D Outside air temperature.
- E Feature bar.

Status Bar

-  Cell phone microphone muted.
-  Audio system muted.
-  Software update installed.
-  Wi-Fi connected.
-  Cell phone roaming.
-  Text message received.

SYNC™ 3 (If Equipped)



Automatic crash notification system off.



Cell phone network signal strength.



Vehicle data sharing on.



Vehicle location sharing on.



Vehicle data and vehicle location sharing on.



Wireless charger active.

Feature Bar



Select to use the radio, a USB, a media player or a **Bluetooth®** device. See **Entertainment** (page 380).



Select to adjust climate settings. See **Climate** (page 382).



Select to make calls and access the phonebook on your cell phone. See **Phone** (page 385).



Select to use the navigation system. See **Navigation** (page 387).



Select to search for and use compatible apps on your iOS or Android device. See **Apps** (page 392).



Select to adjust system settings. See **Entertainment** (page 380).

Cleaning the Touchscreen

See **Cleaning the Interior** (page 287).

Updating the System

Updating the System Using a USB Drive

Downloading an Update

1. Go to the SYNC update page on the local Ford website.
2. Download the update.

Note: *The website notifies you if an update is available.*

3. Insert a USB drive into your computer.

Note: *The USB drive needs to be empty and meet the minimum requirements detailed on the website.*

4. Follow the instructions provided to download the update to the USB drive.

Installing an Update

Note: *You can use the system when an installation is in progress.*

1. Disconnect all other USB devices from the USB ports.
2. Connect the USB drive with the update to a USB port.

Note: *Installation starts automatically within 10 minutes.*

Updating the System Using a Wi-Fi Network Connection

Connecting to a Wi-Fi Network



Select the settings option on the feature bar.

1. Select **Automatic Updates**.
2. Select **System Wi-Fi**.
3. Switch **System Wi-Fi** on.
4. Select **Available Wi-Fi Networks**.
5. Select an available Wi-Fi network.

Note: *Enter the network password to connect to a secure network.*

Switching Automatic System Updates On



Select the settings option on the feature bar.

1. Select **Automatic Updates**.
2. Switch **Automatic System Updates** on.

The system is now set to check for and receive system updates when it is connected to a Wi-Fi network.

Note: You can use the system when a download is in progress.

Note: If the system is disconnected from the Wi-Fi network when a download is in progress, the download continues the next time the system is connected to a Wi-Fi network.

Additional Information and Assistance

For additional information and assistance, we recommend that you contact an authorized dealer or refer to the local Ford website.

USING VOICE RECOGNITION

The system allows you to interact with the entertainment, information and communication systems on your vehicle using voice commands. This allows you to keep your hands on the steering wheel and focus on what is in front of you.



Press the voice control button on the steering wheel and wait for the voice prompt.

Note: Press the voice control button again to interrupt a voice prompt and begin speaking.

Note: Turn the volume control when a voice prompt plays to adjust the volume.

Note: Press and hold the voice control button on the steering wheel to use Siri on your iOS device.

The following voice commands are designed to help you from any screen:

- **List of Commands**
- **Help**

The following tables list some of the more frequently used voice commands. For a complete list of voice commands, refer to our website.

General

Voice Command	Description
___ List of Commands	Get a list of voice commands for a specific feature. ¹
Cancel	Cancel an active voice session.
___ Help	Get a list of voice commands for a specific feature. ¹
Go back	Return to the previous screen.
Main Menu	Go to the main menu.

SYNCTM 3 (If Equipped)

Voice Command	Description
Next Page	Go to the next page.
Previous Page	Go to the previous page.

¹ Add the name of the feature to the command.

Entertainment

Audio Source

Voice Command	Description
Radio	Use the radio.
CD Player	Use the CD player.
Bluetooth Stereo	Use a Bluetooth ® device.
USB	Use a USB or media player.

Radio

Voice Command	Description
AM	Listen to AM radio.
AM ____	Tune to a specific AM frequency. ¹
Sirius Channel ____	Listen to SiriusXM radio. ²
FM	Listen to FM radio.
FM ____	Tune to a specific FM frequency. ¹

¹ Add the radio frequency to two decimal places to the command.

² You can say the Sirius channel name or number such as "Sirius Channel 16" or "Sirius The Pulse".

SYNC™ 3 (If Equipped)

USB and Media Player

Voice Command	Description
Play Album ___	Play your music by category. ¹
Play Artist ___	
Play Genre ___	
Play Playlist ___	
Play Song ___	
Play Audiobook ___	
Play Podcast ___	
Browse All Albums	Browse music on a USB device.
Browse All Artists	
Browse All Audiobooks	
Browse All Genres	
Browse All Playlists	
Browse All Podcasts	
Browse All Songs	
Browse Album ___	Browse your music by category on a USB device. ¹
Browse Artist ___	
Browse Audiobook ___	
Browse Genre ___	
Browse Playlist ___	
Browse Podcast ___	

¹ Add an album name, artist name, audiobook name, genre name, playlist name, podcast name or track name to the command. Say the name exactly as it appears on your device.

Climate (If Equipped)

You can control the temperature of the vehicle using voice commands.

___ is a dynamic listing, meaning that for climate voice commands it can be the desired degrees for the temperature setting.

SYNCTM 3 (If Equipped)

To adjust the temperature, say:

Voice command	Description
Set Temperature ___	Adjust the temperature between 60–85°F (15.5–29.5°C).

Phone

Voice Command	Description
Pair Phone	Pair a cell phone or Bluetooth ®-enabled device.
Redial	Redial the last number that you dialed.
Dial ___	Dial a number. ¹
Call ___	Call a specific contact from your phonebook. ²
Call ___ ___	Call a specific contact from your phonebook at a specific location. ³
Listen to Message	Listen to a text message.
Listen to Message ___	Listen to a specific text message from a list of text messages.
Reply to Message	Reply to the last text message.

¹ Add the number you want to dial to the command.

² Add a contact name from your phonebook to the command. Say the first and last name of your contact exactly as it appears on your device.

³ Add a contact name and location from your phonebook to the command. Say the first and last name of your contact exactly as it appears on your device.

SYNC™ 3 (If Equipped)

Navigation (If Equipped)

Setting a Destination

Voice Command	Description
Find an Address	Enter a destination address. When prompted, provide the house number, the street and city.
Find a Place	Search for a point of interest by name or by category.
Find the Next ___	Search for a nearby point of interest by category. ¹
Find a POI Category	Search for a point of interest category. ¹
Drive Home	Set your saved home address as your destination.
Drive to Work	Set your saved place of work as your destination.
Show Previous Destinations	Display and select from a list of previous destinations.
Show Favorites	Display and select from a list of favorite destinations.

¹ Add a point of interest category or the name of a major brand or chain to the command.

Route Guidance

Voice Command	Description
Cancel Route	Cancel the current route.
Detour	Select an alternate route.
Repeat Instruction	Repeat the last guidance prompt.
Show Route	Display an overview of the route.
Show Traffic	Display a list of traffic events on your route.
Show Map	Display the map on the touchscreen.
North Up	Display a two-dimensional map with north toward the top of the touchscreen.
Heading Up	Display a two-dimensional map with the direction you are traveling toward the top of the touchscreen.
Show 3D	Display a three-dimensional map with the direction you are traveling toward the front.

SYNCTM 3 (If Equipped)

Apps

General

Voice Command	Description
Mobile Applications	Start an app. The system prompts you for the app name.
List Applications	Get a list of apps running on your device.
Find Applications	Search and connect to apps running on your device.

Active App

Voice Command	Description
___ Help	Get a list of voice commands for a specific app. ¹
Exit ___	Close an app. ¹

¹Add an app name to the command.

SiriusXM Traffic and Travel Link (If Equipped)

Voice command	Description
Show Traffic	Displays a list of traffic incidents.
Show Weather Map	Displays the current weather map.
Show Fuel Prices	Displays a list of fuel prices.
Show 5 Day Forecast	Displays the 5 day weather forecast.

Voice Settings

Voice Command	Description
Voice Settings	Go to the voice settings menu.
Interaction Mode Novice	Switch long voice prompts on.
Interaction Mode Advanced	Switch short voice prompts on.
Phone Confirmation On	Switch call confirmation on. The system prompts you to confirm before making a call.
Phone Confirmation Off	Switch call confirmation off. The system does not prompt you to confirm before making a call.
Voice Command Lists On	Switch the display of voice commands on.
Voice Command Lists Off	Switch the display of voice commands off.

Automatic Blower Motor Speed Reduction

If necessary, the system decreases the blower motor speed when you are using voice commands to reduce the amount of background noise in your vehicle. It returns to normal when you are done.

Switching Automatic Blower Motor Speed Reduction Off

Simultaneously press the **A/C** and recirculated air buttons.

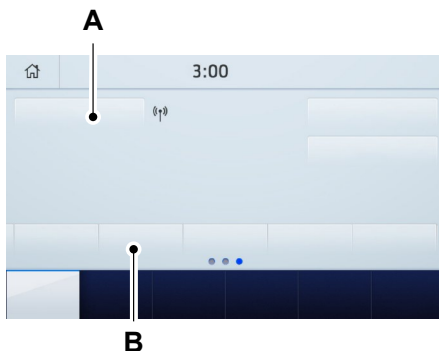

ENTERTAINMENT



Select the entertainment option on the feature bar.

- A Audio source. Select to choose a different audio source.
- B Presets. Swipe left to view more presets.

You can access these options using the touchscreen or voice commands.

Using the Radio

Setting a Radio Station Using the Touchscreen

Directly Tuning a Radio Station

Select **Sources**.

Select **AM** or **FM**.

Select **Frequency**.

Enter the frequency of the radio station and select **Enter**.

Note: You must enter the frequency to two decimal places.

Selecting a Radio Station From a List

Select **Sources**.

Select **FM** or **DAB**.

Select **Station**.

Select a radio station from the list.

Switching Traffic Announcements On

Select **Traffic (TA)**.

Note: If you switch traffic announcements on, traffic announcements broadcast by radio stations interrupt the current audio source to help you plan your route.

Storing a Radio Station

You can use the different sets of presets to allow different drivers to store their favorite radio stations.

Set a radio station.

Select **Presets**.

Note: Only do this if you wish to select a different set of presets.

Press and hold one of the preset buttons.

Note: The radio briefly mutes to indicate the radio station has been stored.

Streaming Music From a Bluetooth® Device.

Check the compatibility of your device on the regional Ford website.

Pair your device. See **Phone** (page 385).

Select **Sources**.



1. Select **Bluetooth®**.

Searching for Tracks on Bluetooth® Device.

Select **Browse**.

Select a track.

Note: Select the cover art to view information about the current track.

Repeating Tracks on Bluetooth® Device.



Select the repeat icon to repeat tracks.

Note: You can repeat one track or all tracks on an audio format **Bluetooth®** Device. You can repeat one track, all tracks or all tracks in one folder on a **Bluetooth®** Device.

Note: A small number one appears next to the repeat icon to indicate that a track is set to repeat. A small folder icon appears next to it to indicate that a folder is set to repeat

Playing Tracks on Bluetooth® Device in a Random Order.



Select to play tracks in a random order.

Playing Music From a USB or Media Player

Connect your device to a USB port.

Select **Sources**.



Select USB.

Note: *The system indexes your music before you can play it.*

Searching for Tracks on a USB or Media Player

Select **Browse**.

Select a track.

Note: *Select the cover art to view information about the current track.*

Note: *You can also browse by album, artist, audiobook, genre, playlist, podcast or track name.*

Repeating Tracks on a USB or Media Player



Select the repeat icon to repeat tracks.

Note: *You can repeat one track or all tracks on an audio format USB or media player. You can repeat one track, all tracks or all tracks in one folder on a USB or media player.*

Note: *A small number one appears next to the repeat icon to indicate that a track is set to repeat. A small folder icon appears next to it to indicate that a folder is set to repeat*

Supported Devices

The system supports most USB and media players, including iOS and Android devices.

Supported File Formats

The system supports the following file formats:

- MP3, MP4, WMA, WAV, AAC, AIFF, APE, DSD, and FLAC audio file formats.
- MP3, WMA, WAV, M4A, M4B, AAC, and FLAC file extensions.
- FAT, exFAT, and NTFS file systems.

Audio File Metadata

The system organizes files on your USB or media player by metadata tags. Metadata tags contain information about the file. If the metadata tags for the files on your USB or media player contain no information, the system classifies them as unknown. The system can index up to 50000 tracks on a USB device or media player, and up to 10 devices.

CLIMATE

Touch the climate button on the touchscreen to access the climate control features.

Note: *You can switch temperature units between Fahrenheit and Celsius. See **Settings** (page 393).*

Accessing the Climate Control Menu



Touch the button to access additional controls for the front climate system.

Directing the Airflow



Touch the button to direct airflow to the windshield air vents and de-mister.



Touch the button to direct airflow to the instrument panel air vents.



Touch the button to direct airflow to the footwell air vents.

You can direct air through any combination of these air vents.

Setting the Blower Motor Speed



Touch up or down to increase or decrease the volume of air that circulates in your vehicle.

Setting the Temperature

Touch up or down on the left-hand temperature control to set the left-hand temperature.

Note: This control also adjusts the right-hand side temperature when you switch off dual zone mode.

Touch up or down on the right-hand temperature control to set the right-hand temperature.

Switching Auto Mode On and Off



Touch the button to switch on automatic operation, then set the temperature.

The system adjusts the blower motor speed, air distribution, air conditioning operation, and outside or recirculated air to reach and maintain the temperature you have set.

Switching the Air Conditioning On and Off



A pop-up appears on the screen to display the air conditioning options.

MAX A/C: Touch the button to activate and maximize cooling. The driver and passenger temperatures are set to LO, recirculated air flows through the instrument panel vents, air conditioning automatically turns on and the fan automatically adjusts to the highest speed.

A/C: Touch to switch the air conditioning on or off. Use A/C with recirculated air to improve cooling performance and efficiency.

Note: In certain conditions, such as maximum defrost, the air conditioning compressor may continue to operate even though you switch off the air conditioning.

Switching the Climate Control On and Off



Touch the button.

Switching the Climate Controlled Seats On and Off



Touch the button to cycle through the various climate controlled seat settings.

Switching Dual Zone Mode On and Off



Touch the button to switch on temperature control for the right-hand side of the vehicle.

Switching the Heated Exterior Mirrors On and Off



Touch the button.

Switching the Heated Windshield On and Off



Touch the button to clear the windshield of thin ice and fog. The heated windshield turns off after a short period of time.

Switching the Heated Rear Window On and Off



Touch the button to clear the rear window of thin ice and fog.

Switching the Heated Seats On and Off



Touch the button to cycle through the various heat settings.

Switching the Heated Steering Wheel On and Off



Touch the button.

Switching Maximum Air Conditioning On and Off



Touch the button for maximum cooling.

Recirculated air flows through the instrument panel air vents, air conditioning turns on and the blower motor adjusts to the highest speed.

Switching Maximum Defrost On and Off



Touch the button for maximum defrosting.

Air flows through the windshield air vents, and the blower motor adjusts to the highest speed.

You can also use this setting to defog and clear the windshield of a thin covering of ice.

Note: To prevent window fogging, you cannot select recirculated air when maximum defrost is on.

Note: The heated rear window also turns on when you select maximum defrost.

Note: Depending on your region, air conditioning turns on.

Switching Recirculated Air On and Off



Touch the button to switch between outside air and recirculated air.

The air currently in the passenger compartment recirculates. This may reduce the time needed to cool the interior, when used with **A/C**, and reduce unwanted odors from entering your vehicle.

Note: Recirculated air may turn off, or prevent you from switching on, in all air flow modes except **MAX A/C** to reduce the risk of fogging. Recirculation may also turn on and off in various air distribution control combinations during hot weather to improve cooling efficiency.

Switching the Ventilated Seats On and Off



Touch the button to cycle through the various ventilated seat settings.

Accessing Rear Climate Controls



Touch the button to access additional controls for the rear climate system.

Rear Climate Control Lock Indicator



Touch the button.

When on, you can only operate the rear passenger settings through the front controls.

Switching Rear Auto Mode On and Off



Touch the button to switch on rear automatic operation, then set the temperature.

SYNC™ 3 (If Equipped)

Switching the Rear Climate Controlled Seats On and Off



Touch the button to cycle through the various climate controlled seat settings.

Switching the Rear Heated Seats On and Off



Touch the button to cycle through the various heat settings.

Switching the Rear Ventilated Seats On and Off



Touch the button to cycle through the various ventilated seat settings.

PHONE



WARNING: Driving while distracted can result in loss of vehicle control, crash and injury. We strongly recommend that you use extreme caution when using any device that may take your focus off the road. Your primary responsibility is the safe operation of your vehicle. We recommend against the use of any hand-held device while driving and encourage the use of voice-operated systems when possible. Make sure you are aware of all applicable local laws that may affect the use of electronic devices while driving.

Check the compatibility of your device on the regional website.

Pairing Your Cell Phone for the First Time

Go to the settings menu on your device and switch **Bluetooth®** on.



Select the phone option on the feature bar.

1. Select **Add Phone**.

Note: A prompt alerts you to search for your vehicle on your cell phone.

2. Select your vehicle on your cell phone.

Note: A number appears on your cell phone and on the touchscreen.

3. Confirm that the number on your cell phone matches the number on the touchscreen.

Note: The touchscreen indicates that you have successfully paired your cell phone.

4. Download the phonebook from your cell phone when you are prompted.

Note: If you pair more than one cell phone, use the phone settings to specify the primary phone. You can change this setting at any time.

Using Your Cell Phone (If Equipped)

Recent Call List

Display and select an entry from a list of previous calls.

Contacts

Display a smart search form to look up your contacts. Use the List button to alphabetically sort your contacts.

Change Phone

Display the list of paired or connected devices that you can select.

Phone Settings

Change ring tones, alerts or pair another phone.

Do Not Disturb

Reject incoming calls and switch ring tones and alerts off.

SYNC™ 3 (If Equipped)

Phone Keypad

Directly dial a number.

Mute

Mute the microphone when in a call.

Phone Voice Assistant

Say a command to use the Google or Siri voice assistant available on your connected phone to access supported features.

Text Messaging

Setting Text Message Notification

iOS

1. Go to the settings menu on your cell phone.

Using Text Messaging

Menu Item	Description
Hear It	Hear the text message.
View	View the text message.
Call	Call the sender.
Reply	Reply to the text message with a standard text message.

Apple CarPlay (If Equipped)

1. Connect your device to a USB port.
2. Follow the instructions on the touchscreen.

Note: Certain features of the system are not available when you are using Apple CarPlay.

Switching Apple CarPlay Off



Select the settings option on the feature bar.

2. Select **Bluetooth®**.
3. Select the information icon to the right of your vehicle.
4. Switch text message notification on.

Android

1. Go to the settings menu on your cell phone.
2. Select **Bluetooth®**.
3. Select the profiles option.
4. Select the phone profile.
5. Switch text message notification on.

1. Select **Apple CarPlay Preferences**.
2. Switch **Apple CarPlay** off.

Android Auto (If Equipped)

1. Connect your device to a USB port.
2. Follow the instructions on the touchscreen.

Note: You might need to enable Android Auto from the settings menu.

Note: Certain features of the system are not available when you are using Android Auto.

SYNC™ 3 (If Equipped)

Switching Android Auto Off



Select the settings option on the feature bar.

1. Select **Android Auto**.
2. Switch **Android Auto** off.

NAVIGATION (IF EQUIPPED)

Note: For more information, refer to our website.



Select the navigation option on the feature bar.

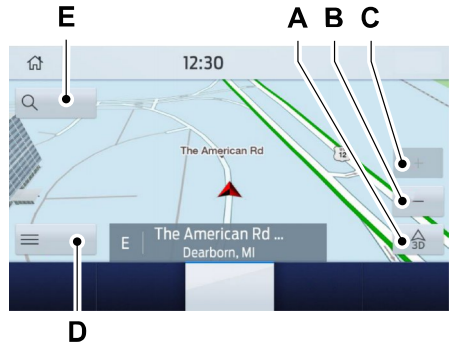

- A Map view menu.
- B Zoom out.
- C Zoom in.
- D Route guidance menu.
- E Destination entry menu.

Setting a Destination

Destination Entry Menu

Item	Description
Search	Enter a destination address.
Previous Destinations	Display and select from a list of previous destinations.
Home	Set your saved home address as your destination
Work	Set your saved place of work as your destination.
Favorites	Display and select from a list of favorite destinations.

Setting a Destination Using the Text Entry Screen

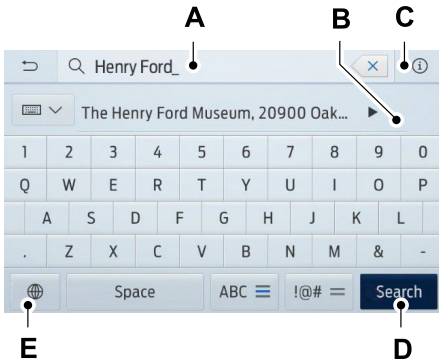

- A Text entry field.
- B Automatic suggestions based on the text you enter.
- C Information icon.
- D Search.
- E Keyboard settings.

Note: Select one of the suggestions to copy the detail to the text entry field.

You can search by entering all or part of the destination, such as the Address, POI Category or Name, Intersection, City, Latitude/Longitude, etc. **Tips:** If you do not specify a location, the system will use the current vehicle location. You can specify a location by address, city, state or zip code. For additional search support, please visit: support.ford.com.

Note: Press the button in the top right-hand corner of the main map to display estimated time of arrival, the remaining travel time or distance to destination.

Setting a Destination Using the Map Screen

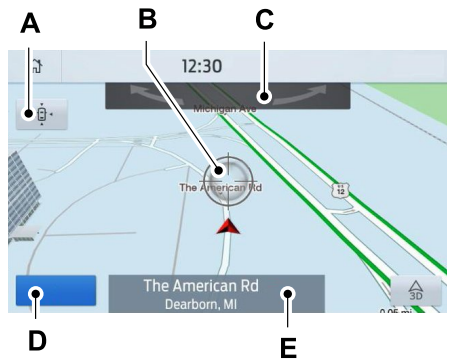

- A Re-center the map.
- B Selected location.
- C 3D map rotation. Swipe left or right.
- D Start route guidance.
- E Destination name.

Select the location on the map.

Select **Start** to begin route guidance.

Changing the Format of the Map

Display the map in one of the following formats:

- A two-dimensional map with the direction you are traveling toward the top of the screen.
- A two-dimensional map with north toward the top of the screen.
- A three-dimensional map with the direction you are traveling toward the front.

Zoom

Display more or less detail on the map.

SYNC™ 3 (If Equipped)

Note: Use pinch gestures to zoom in and out. Place two fingers on the screen and move them apart to zoom in. Place two fingers on the screen and bring them together to zoom out.

Route Guidance

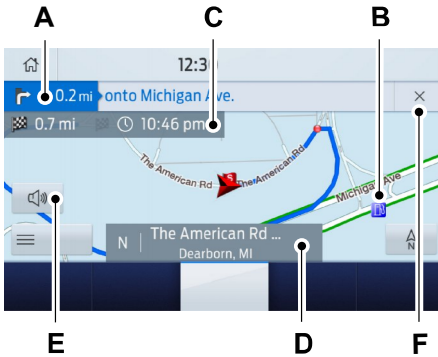

- C Estimated time of arrival, distance to destination or time to destination.
- D Current road.
- E Mute guidance prompts.
- F Cancel route guidance.

Note: To change guidance prompt volume, turn the volume control when a guidance prompt plays.

- A Turn indicator. Select to hear the last voice prompt.
- B Point of interest.

Route Guidance Menu

Menu Item	Description
Screen View	Adjust your map preferences for when route guidance is active.
Full Map	View a full-screen map when route guidance is active.
Highway Exit Info	View highway exit information for your current route.
Turn List	View the turn list for your current route. Select a road to avoid it.
Traffic List	You can find the SiriusXM Traffic and Travel Link information by pressing this button. This information requires an active subscription to SiriusXM Traffic and Travel Link. When a route is not active, a list of nearby traffic incidents displays. When a route is active, you can choose to display a list of traffic nearby or on the route.

SYNC™ 3 (If Equipped)

Menu Item	Description
Navigation Settings	Adjust navigation settings. See Settings (page 393).
Where Am I?	View information about your current location.
Cancel Route	Cancel route guidance.
View Route	View the entire current route on the map.
Detour	View an alternative route compared to your current one.
Edit Waypoints	Change the order or remove waypoints.
Optimize Order	The system determines the order of waypoints for you.
Go	Go to the next screen and start the new route.

Adjusting the Guidance Prompt Volume

Turn the volume control when a guidance prompt plays to adjust the volume.

Note: *If you have inadvertently adjusted the volume to zero, press the turn indicator button to play the last voice prompt and then adjust the volume to the desired level.*

Muting Guidance Prompts



Select the mute option on the screen to mute guidance prompts.

Note: *The system mutes the next and all future guidance prompts.*

Adding Waypoints

You can add a waypoint to a navigation route as a destination along your route. You can add up to five waypoints.

1. Select the search option on the map.
2. Set a destination.
3. Select **Add Waypoint**.
4. Select **Go**.

Canceling Route Guidance



Select the route guidance menu option on the active guidance screen.

Select **Cancel Route**.

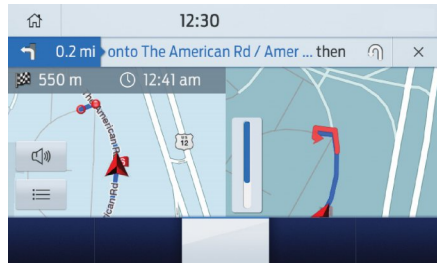

Note: *The route guidance menu option is always in the bottom right-hand corner of the main map.*

cityseeker (If Equipped)



E225487

cityseeker, when available, is a service that provides more information about certain points of interest such as restaurants, hotels and attractions.

Note: *cityseeker information is limited to approximately 1,110 cities (1,049 in the United States, 36 in Canada and 15 in Mexico).*

When you have selected a point of interest, the location and information appear, such as address, phone number and a star rating.

Press **More Information** to see a photo, a review, a list of services and facilities, the average room or meal price and the web address. This screen displays the point of interest icons.

For restaurants, cityseeker can provide information such as star rating, average cost, review, handicap access, hours of operation, and website address.

For hotels, cityseeker can provide information such as star rating, price category, review, check-in and checkout times, hotel service icons and website address. Hotel service icons include:

- Restaurant
- Business center
- Handicap facilities
- Laundry
- Refrigerator
- 24-hour room service

- Fitness center
- Internet access
- Pool
- Wi-Fi

Attractions include nearby landmarks, amusement parks, historic buildings and more. cityseeker can provide information such as star rating, reviews, hour of operation and admission price.

SiriusXM Traffic and Travel Link (If Equipped)

SiriusXM Traffic and Travel Link is available on vehicles equipped with navigation and only in select markets. You must activate and subscribe to receive SiriusXM Traffic and Travel Link information. It helps you locate the best gas prices, find movie listings, get current traffic alerts, view the weather map, get accurate ski conditions and see current sports scores.

The system calculates a reasonable efficient route based on available speed limits, traffic, and road conditions. You may know a local shortcut that is more efficient at a given time than the route provided by SYNC 3, but you should expect a slight difference in minutes or miles with the SYNC 3 route.

Michelin Travel Guide (If Equipped)

The Michelin travel guide is a service that provides additional information about certain places of interest, for example restaurants, hotels and tourist sites. Points of interest that have Michelin travel guide information display a button to show you more information. Push the button to see the additional information. If you have paired your phone with the system, you can press the phone button to directly establish a call with the selected point of interest.

Navigation Map Accuracy and Updates

HERE is the digital map provider for the navigation application. If you find map data errors, you may report them directly to HERE by going to www.here.com. HERE evaluates all reported map errors and responds with the result of their investigation by e-mail.

The navigation system map data may contain inaccurate or incomplete information due to the passage of time, changing circumstances, sources used and the nature of collecting comprehensive geographic data, any of which may lead to incorrect results. Inaccurate speed limit information, turn restrictions and other road attributes may affect the determined route and associated guidance.

Annual navigation map updates are available for purchase through your dealership. Depending on your purchase agreement, you might be eligible for a free map update. You can choose to download the map data update onto a USB, order a USB, or use Wi-Fi to deliver automatic updates. To update your map data over Wi-Fi, your vehicle must be connected to a Wi-Fi access point. Map data files are large, so it is highly recommended to perform the update when free Wi-Fi is available otherwise high data rates may apply. For USB updates, free map update eligibility, and other details, contact dealers at 1-866-462-8837 in the United States and Canada or 800-557-5539 in Mexico or visit our local website for more information.

APPS

The system allows you to interact with select mobile apps while keeping your eyes on the road. Voice commands, steering wheel buttons, or a quick tap on your touchscreen give you advanced control of compatible mobile apps. You can also stream your favorite music or podcasts, share your time of arrival with friends, and keep connected safely.

When you start an app through the system for the first time, you could be asked to grant certain permissions. You can review and change the permissions that you have granted at any time when your vehicle is not moving. We recommend that you check your data plan before using your apps through the system. Using them could result in additional charges. We also recommend that you check the app provider's terms and conditions and privacy policy before using their app. Make sure that you have an active account for apps that you want to use through the system. Some apps work with no setup. Others require you to configure some personal settings before you can use them.

Note: For more information about available apps, visit the local Ford website.

Using Apps on an iOS Device



Select the apps option on the feature bar.

1. If your device is connected via USB, switch Apple CarPlay off. See **Phone** (page 385).
2. Connect your iOS device to a USB port or pair and connect using **Bluetooth®**.
3. If prompted to enable CarPlay, select Disable.
4. Start the apps on your device that you want to use through SYNC.

SYNC™ 3 (If Equipped)

Note: If you close the apps on your device, you will not be able to use them through the system.

1. Select the app that you want to use on the touchscreen.

Note: Connect your device to a USB port if you want to use a navigation app. When using a navigation app, keep your device unlocked and the app open.

Using Apps on an Android Device



Select the apps option on the feature bar.

1. If your device is connected via USB, switch Android Auto off. See **Phone** (page 385).
2. Pair your device. See **Phone** (page 385).
3. Start the apps on your device that you want to use through SYNC.

Note: If you close the apps on your device, you will not be able to use them through the system.

4. Select **Find Mobile Apps**.

Note: The system searches and connects to compatible apps that are running on your device.

5. Select the app that you want to use on the touchscreen.

Note: Mobile apps on your device use the USB port to establish a connection with SYNC. Some devices may lose the ability to play music over USB when mobile apps are enabled.

Using Mobile Navigation on an Android Device

1. Connect your device to a USB port.
2. Switch Android Auto off. See **Phone** (page 385).
3. Switch on Enable Mobile Apps via USB in the Mobile Apps Settings tile.

4. Select the apps option on the feature bar.
5. Select the navigation app that you want to use on the touchscreen.

Note: When using a navigation app, keep your device unlocked and the app open.

SETTINGS



Press the button to enter the settings menu.



Once you select a tile, press the button next to a menu item to view an explanation of the setting.

Sound

Select this tile to adjust the sound settings.

Clock

Select this tile to adjust the clock settings.

Bluetooth®

Select this tile to switch **Bluetooth®** on and off and adjust the settings.

Phone

Select this tile to connect, disconnect, and manage the connected device settings.

Audio

Select this tile to adjust the audio settings.

Driver Assist (If Equipped)

Select this tile to adjust Driver Assist features like Park Aid, Lane Keeping system, Pedestrian Detection, and Auto-Start-Stop.

SYNC™ 3 (If Equipped)

Vehicle

Select this tile to adjust the vehicle settings like windows, alarm, lighting, and MyKey settings.

FordPass (If Equipped)

Select this tile to adjust the FordPass settings.

General

Select this tile to adjust settings like language, measurement units, or to reset the system.

Emergency Assistance

Select this tile to switch Emergency Assistance on and off.

Automatic Updates

Select this tile to adjust automatic update settings.

Mobile Apps

Select this tile to adjust permissions, enable, disable, and update mobile apps.

Display

Select this tile to adjust display settings like brightness and auto dim.

Charge Settings (If Equipped)

Select this tile to adjust the electric vehicle charge settings.

Voice Control

Select this tile to adjust voice control settings like command confirmations and displayed lists.

Navigation (If Equipped)

Select this tile to adjust navigation settings like map preferences and route guidance.

Multi Contour Seats (If Equipped)

Select this tile to adjust the position and massage function of your multi-contour seats.

Seats (If Equipped)

Select this tile to adjust the lumbar function of your seats.

Message Center (If Equipped)

Select this tile to view vehicle messages.

Personal Profiles (If Equipped)

Select this tile to adjust recalled memory features when using Personal Profiles.

Valet Mode (If Equipped)

Select this tile to enable and disable valet mode.

SYNC™ 3 TROUBLESHOOTING

Voice Recognition

Symptom	Possible Cause and Resolution
The system does not understand what I am saying.	<ul style="list-style-type: none"> – You might not be using supported voice commands. <ul style="list-style-type: none"> • See Using Voice Recognition (page 374). • For a complete list of voice commands, refer to our website. – You might be speaking too soon. <ul style="list-style-type: none"> • Wait for the voice prompt before you speak.
The system does not understand the name of a track or artist.	<ul style="list-style-type: none"> – Device limitation. Bluetooth® does not support voice commands. <ul style="list-style-type: none"> • Connect your device to a USB port. • If you have an iOS device, press and hold the voice control button on the steering wheel to use Siri to play specific tracks. – You might not be using supported voice commands. <ul style="list-style-type: none"> • See Using Voice Recognition (page 374). • For a complete list of voice commands, refer to our website. – You might not be saying the name exactly as it appears on your device. <ul style="list-style-type: none"> • Say the name of the track or artist exactly as it appears on your device. Spell out any abbreviations in the name. – The name contains special characters, for example *, - or +. <ul style="list-style-type: none"> • Rename the files on your device or use the touchscreen to select and play the track.
The system does not understand the name of a contact in the phonebook on my device and calls the wrong contact.	<ul style="list-style-type: none"> – You might not be saying the name exactly as it appears on your device. <ul style="list-style-type: none"> • Say the first and last name of the contact exactly as it appears on your device. Spell out any abbreviations in the name. – The name contains special characters, for example *, - or +. <ul style="list-style-type: none"> • Rename the contact on your device or use the touchscreen to select and call the contact.

SYNC™ 3 (If Equipped)

Symptom	Possible Cause and Resolution
The system does not understand certain names of contacts in the phonebook on my device.	<ul style="list-style-type: none">– You might not be saying the name exactly as it appears on your device.<ul style="list-style-type: none">• Say the first and last name of the contact exactly as it appears on your device. The system applies phonetic pronunciation rules of the selected language to the names of contacts in the phonebook on your device. Select the name of the contact on the touchscreen and use the Hear it option to get an idea of how the system expects you to pronounce it.
The system voice prompts and the pronunciation of some words do not seem to be very accurate.	<ul style="list-style-type: none">– Device limitation.<ul style="list-style-type: none">• The system uses text-to-speech technology and uses a synthetically generated voice rather than pre-recorded human voice.

USB and Bluetooth® Audio

Symptom	Possible Cause and Resolution
I cannot connect my device.	<ul style="list-style-type: none">– Device malfunction.<ul style="list-style-type: none">• Disconnect your device. Switch your device off and on to reset it and try again.– Cable connection issue.<ul style="list-style-type: none">• Correctly connect the cable to your device and the vehicle USB port.– Incompatible cable.<ul style="list-style-type: none">• Use the cable recommended by the manufacturer of your device.

SYNCTM 3 (If Equipped)

Symptom	Possible Cause and Resolution
	<ul style="list-style-type: none"> – Incorrect device settings. <ul style="list-style-type: none"> • Make sure that your device does not have an auto-install program or active security settings. • Check that your device is not set only to charge. – Device lock screen enabled. <ul style="list-style-type: none"> • Unlock your device before connecting it.
The system does not recognize my device.	<ul style="list-style-type: none"> – Device limitation. <ul style="list-style-type: none"> • Do not leave your device in your vehicle during very hot or very cold weather conditions. – Cable connection issue. <ul style="list-style-type: none"> • Correctly connect the cable to your device and the vehicle USB port. – Incompatible cable. <ul style="list-style-type: none"> • Use the cable recommended by the manufacturer of your device.
The system does not understand the name of a track or artist.	<ul style="list-style-type: none"> – Device limitation. Bluetooth® does not support voice commands. <ul style="list-style-type: none"> • Connect your device to a USB port. • If you have an iOS device, press and hold the voice control button on the steering wheel to use Siri to play specific tracks.
I cannot stream audio from my Bluetooth® device.	<ul style="list-style-type: none"> – Incompatible device. <ul style="list-style-type: none"> • Check the compatibility of your device on our website. – Device not connected. <ul style="list-style-type: none"> • Pair your device. See Phone (page 385). – Media player not running. <ul style="list-style-type: none"> • Start the media player on your device.
The system does not recognize the music on my device.	<ul style="list-style-type: none"> – Missing or incorrect audio file metadata, for example artist, song title, album or genre. <ul style="list-style-type: none"> • Repair the files on your device. – Corrupt files. <ul style="list-style-type: none"> • Repair the files on your device.

SYNC™ 3 (If Equipped)

Symptom	Possible Cause and Resolution
	<ul style="list-style-type: none"> – Copyright-protected files. <ul style="list-style-type: none"> • Use a device that contains files that are not copyright protected. – Unsupported file format. <ul style="list-style-type: none"> • Repair or convert the files to a supported format. See Settings (page 393). – Device indexing required. <ul style="list-style-type: none"> • Re-index your device. See Settings (page 393). – Device lock screen enabled. <ul style="list-style-type: none"> • Unlock your device before connecting it.
Sometimes I cannot hear a track playing on my device.	<ul style="list-style-type: none"> – Device malfunction. <ul style="list-style-type: none"> • Disconnect your device. Switch your device off and on to reset it and try again.
When I disconnect my iOS device the audio volume is set to maximum.	<ul style="list-style-type: none"> – Device limitation. <ul style="list-style-type: none"> • Turn the volume down on your device.
The system does not play the tracks on my USB drive in the correct order.	<p>If the system does not play the tracks on your USB device in the correct order, the following information could help:</p> <ul style="list-style-type: none"> – If you are selecting USB as the audio source when the system is still indexing, SYNC plays tracks sorted alphabetically by file name in the root directory. – If you are selecting USB as the audio source after the system has finished indexing, SYNC plays all tracks sorted alphabetically by the title in the ID3 tag regardless of where they are located. SYNC uses the file name if the title in the ID3 tag does not exist. – If you are selecting the option to play all tracks from the browsing menu, SYNC plays all tracks sorted alphabetically by the title in the ID3 tag regardless of where they are located. SYNC uses the file name if the title in the ID3 tag does not exist. – If you are selecting a track when using the explore device option, SYNC plays tracks sorted alphabetically by file name in the folder you have selected. SYNC then plays all tracks in any subfolders in the folder you have selected.

SYNCTM 3 (If Equipped)

Phone

Symptom	Possible Cause and Resolution
During a call, I can hear excessive background noise.	<ul style="list-style-type: none">– Incorrect cell phone settings.<ul style="list-style-type: none">• Check and adjust the audio settings on your cell phone. Refer to your cell phone's user manual.
During a call, I can hear the other person but they cannot hear me.	<ul style="list-style-type: none">– Cell phone malfunction.<ul style="list-style-type: none">• Switch your cell phone on and off, and vehicle Bluetooth® on and off and try again.– Cell phone microphone muted.<ul style="list-style-type: none">• Unmute your cell phone microphone.– Privacy mode is enabled.<ul style="list-style-type: none">• Switch off privacy mode.
During a call, I cannot hear the other person and they cannot hear me.	<ul style="list-style-type: none">– System restart required.<ul style="list-style-type: none">• Switch the ignition off and open the door. Close the door and lock the vehicle. Wait until the touchscreen is off and any illuminated USB ports are not illuminated. Unlock the vehicle, switch the ignition on and try again.
I cannot download a phone-book.	<ul style="list-style-type: none">– Incompatible cell phone.<ul style="list-style-type: none">• Check the compatibility of your cell phone on our website.– Incorrect cell phone settings.<ul style="list-style-type: none">• Allow the system to retrieve contacts from your cell phone. Refer to your cell phone's user manual.– Incorrect system settings.<ul style="list-style-type: none">• Switch automatic phonebook download on. See Settings (page 393).– Cell phone malfunction.<ul style="list-style-type: none">• Switch your cell phone off and on to reset it and try again.

SYNC™ 3 (If Equipped)

Symptom	Possible Cause and Resolution
A message displays suggesting that my phonebook has downloaded but it is empty or it has missing contacts.	<ul style="list-style-type: none"> – Incorrect cell phone settings. <ul style="list-style-type: none"> • Allow the system to retrieve contacts from your cell phone. Refer to your cell phone's user manual. • Check the location of the missing contacts on your cell phone. If they are stored on the SIM card, move them to the cell phone memory. – Incorrect system settings. <ul style="list-style-type: none"> • Switch automatic phonebook download on. See Settings (page 393).
I cannot connect my cell phone.	<ul style="list-style-type: none"> – Incompatible cell phone. <ul style="list-style-type: none"> • Check the compatibility of your cell phone on our website. – Cell phone malfunction. <ul style="list-style-type: none"> • Switch your cell phone off and on to reset it and try again. • Install the latest cell phone firmware. • Delete your device from the system and delete SYNC from your device and try again. • Switch automatic phonebook download off. See Settings (page 393).
Text messaging does not work.	<ul style="list-style-type: none"> – You might not have switched on text message notifications. <ul style="list-style-type: none"> • Switch text message notifications on. See Phone (page 385). – Incompatible cell phone. <ul style="list-style-type: none"> • Check the compatibility of your cell phone on our website. – Cell phone malfunction. <ul style="list-style-type: none"> • Switch your cell phone off and on to reset it and try again.
I cannot hear text messages.	<ul style="list-style-type: none"> – Device message sharing is not enabled. <ul style="list-style-type: none"> • Check the permissions on your device to ensure text message sharing is enabled. – Incompatible cell phone. <ul style="list-style-type: none"> • Check the compatibility of your cell phone on our website.

SYNCTM 3 (If Equipped)

Navigation (If Equipped)

Symptom	Possible Cause and Resolution
I cannot enter a street name when I am abroad.	– Incorrect entry method. <ul style="list-style-type: none">• Enter the street name with the country.
The system does not recognize coordinates.	– Using the wrong coordinates format. <ul style="list-style-type: none">• Use the format ##. #####, ##. ##### (for N/S, E/W). Add a minus before coordinates if the direction is West and keep a positive value if the direction is East, for example 12.5412 means East and -12.5412 means West.

SYNC™ 3 (If Equipped)

Apps

Symptom	Possible Cause and Resolution
The system cannot find any apps.	<ul style="list-style-type: none">– Incompatible device.<ul style="list-style-type: none">• You need an Android device with OS 4.3 or higher or an iOS device with iOS 8.0 or higher. Pair and connect your Android device to find compatible apps. Connect your iOS device to a USB port or pair and connect using Bluetooth®.
I have a compatible device and it is correctly connected but the system still cannot find any apps.	<ul style="list-style-type: none">– Compatible apps are not installed on your device.<ul style="list-style-type: none">• Download and install the latest version of the app.– Compatible apps are not running on your device.<ul style="list-style-type: none">• Start the apps to allow the system to find them and make sure you sign in to any apps if required.– Incorrect app settings.<ul style="list-style-type: none">• Check and adjust the app settings on your device and allow SYNC to access the app if required.
I have a compatible device, it is correctly connected and my apps are running but the system still cannot find any apps.	<ul style="list-style-type: none">– Apps failed to fully close.<ul style="list-style-type: none">• Restart the apps and try again.• If you have an Android device with apps that have an exit or quit option, use this and then restart the apps. Alternatively, use the force stop option in the settings menu on your device.• If you have an iOS device with iOS 8.0 or higher, tap the home button on your device twice and then swipe the app upward to close it.
I have an Android device that is correctly connected, I have restarted my apps and they are running but the system still cannot find them.	<ul style="list-style-type: none">– An issue on some older versions of the Android operating system could result in apps not being found.<ul style="list-style-type: none">• Switch Bluetooth® off and on again to force the system to reconnect to your device.

SYNCTM 3 (If Equipped)

Symptom	Possible Cause and Resolution
I have an iOS device that is correctly connected, I have restarted my apps and they are running but the system still cannot find them.	<ul style="list-style-type: none">- Cable connection issue.<ul style="list-style-type: none">• Disconnect the cable from your device, wait for a moment and then connect it again to force the system to reconnect to your device.
I have an Android device running a media app which the system has found but I cannot hear the sound or the sound is very quiet.	<ul style="list-style-type: none">- Device volume is low.<ul style="list-style-type: none">• Turn the volume up on your device.
I have an Android device running a number of compatible apps but the system cannot find all of them.	<ul style="list-style-type: none">- Device limitation. If you have more apps running on your device than the number of available Bluetooth® links, the system cannot find all of them.<ul style="list-style-type: none">• Close some of the apps to allow the system to find those that you want to use.

Wi-Fi Connectivity

Symptom	Possible Cause and Resolution
I cannot connect to a Wi-Fi network.	<ul style="list-style-type: none"> – Password error. <ul style="list-style-type: none"> • Enter the correct network password. – Weak network signal. <ul style="list-style-type: none"> • Move your vehicle closer to the Wi-Fi hotspot or to a place where the network signal is not obstructed. – Multiple access points in range with the same SSID. <ul style="list-style-type: none"> • Use a unique name for your SSID. Do not use the default name unless it contains a unique identifier, for example as part of the MAC address.
The Wi-Fi connection disconnects after successful connection.	<ul style="list-style-type: none"> – Weak network signal. <ul style="list-style-type: none"> • Move your vehicle closer to the Wi-Fi hotspot or to a place where the network signal is not obstructed.
I am close to a Wi-Fi hotspot but the network signal strength is weak.	<ul style="list-style-type: none"> – Obstructed network signal. <ul style="list-style-type: none"> • If your vehicle has a heated windshield, position your vehicle so that the windshield is not facing the Wi-Fi hotspot. • If your vehicle has metallic tinting on the windows but not on the windshield, position your vehicle so that the windshield is facing the Wi-Fi hotspot or open the windows that are facing the hotspot. • If your vehicle has metallic tinting on the windows and the windshield, open the windows that are facing the hotspot. • If your vehicle is in a garage and you have the garage door closed, open the garage door.
I cannot see a network in the list of available networks that I expect to see.	<ul style="list-style-type: none"> – Hidden network. <ul style="list-style-type: none"> • Make the network visible and try again.

SYNC™ 3 (If Equipped)

Symptom	Possible Cause and Resolution
I cannot see SYNC when I search for Wi-Fi networks on my cell phone or other device.	<ul style="list-style-type: none"> – System limitation. <ul style="list-style-type: none"> • SYNC does not provide a Wi-Fi hotspot at this time.
Software downloads take too long.	<ul style="list-style-type: none"> – Weak network signal <ul style="list-style-type: none"> • Move your vehicle closer to the Wi-Fi hotspot or to a place where the network signal is not obstructed. – Wi-Fi hotspot in high demand or has a slow Internet connection. <ul style="list-style-type: none"> • Use a more reliable Wi-Fi hotspot.
The system seems to connect to a Wi-Fi network and the signal strength is excellent but the software does not update.	<ul style="list-style-type: none"> – No software update available. – Wi-Fi network requires a subscription or acceptance of terms and conditions. <ul style="list-style-type: none"> • Test the connection using another device. If the network requires a subscription or acceptance of terms and conditions, contact the network service provider.

Personal Profiles (If Equipped)

Symptom	Possible Cause and Resolution
I cannot create a profile.	You might not have set up Personal Profiles.
	You might have entered an invalid profile.
	You might not have selected a memory button when prompted.
	You might not have the ignition on or in park (P), or you shifted out park (P) when creating a profile.
	Personal Profiles has been switched off.
I cannot link a remote control.	You might not have selected the lock button on the remote control.
	The remote control selected was already associated with another profile and the system declined to overwrite.
	The system performed a profile recall when linking a remote control.

SYNC™ 3 (If Equipped)

Symptom	Possible Cause and Resolution
	You might not have the ignition on or in park (P), or you shifted out park (P) when creating a profile.
	You might be using the old linking method.
My personalized settings do not save.	Personal Profiles does not support your unsaved settings.
	A different personal profile is active.
	Another user changed the settings for the wrong personal profile.
My profile will not recall.	You might not have created a personal profile.
	Personal Profiles is turned off.
	The profile you requested is already active.
	You might not have linked the memory button you are using to a profile.
	You might not have linked the remote control you are using to a profile.
	You might be using the wrong remote control.
	You might be pressing a button other than the unlock or remote start on a linked remote control.
You might have deleted the personal profile.	
My preset positions recall, but my profile does not.	Personal Profiles is turned off.
My profile recalls but my preset positions do not.	The vehicle is in motion.
	The preset positions are the same as the guest or previously active profile.
I lost a remote control.	Unlink and relink your remote control in the Personal Profiles menu. You may need to see your authorized dealer.
I lost all profiles.	You might have erased and reprogrammed the remote controls. This could happen if you let a dealership add a new remote control to replace a lost one.
	Someone performed a master reset.

Resetting the System

1. Simultaneously press and hold the seek up and the audio unit power buttons until the screen goes black.
2. Wait three minutes to allow the system to complete the reset.
3. Press the audio unit power button to switch the system on.

Note: *You can reset the system to restore functionality that has stopped working. The system reset is designed to restore functionality and not delete any data that you have stored.*

Additional Information and Assistance

For additional information and assistance, we recommend that you contact an authorized dealer or refer to our website.

Accessories

For a complete listing of the accessories that are available for your vehicle, please contact your authorized dealer or visit the online store web site:

Web Address (United States)
www.Accessories.Ford.com

Web Address (Canada)
www.Accessories.Ford.ca

We will repair or replace any properly authorized dealer-installed Ford Original Accessory found to be defective in factory-supplied materials or workmanship during the warranty period, as well as any component damaged by the defective accessories.

We will warrant your Ford Original Accessory through the warranty that provides the greatest benefit:

- 24 months, unlimited mileage.
- The remainder of your new vehicle limited warranty.

Contact an authorized dealer for details and a copy of the warranty.

Ford Licensed Accessories are the accessory manufacturer's designs. The manufacturer develops and therefore warrants Ford Licensed Accessories, and does not design or test these accessories to Ford Motor Company engineering requirements. Contact an authorized Ford dealer for the manufacturer's limited warranty details, and request a copy of the Ford Licensed Accessories product limited warranty from the accessory manufacturer.

For maximum vehicle performance, keep the following information in mind when adding accessories or equipment to your vehicle:

- When adding accessories, equipment, passengers and luggage to your vehicle, do not exceed the total weight capacity of the vehicle or of the front or rear axle (GVWR or GAWR as indicated on the Safety Compliance Certification label). Ask an authorized dealer for specific weight information.
- The Federal Communications Commission (FCC) and Canadian Radio Telecommunications Commission (CRTC) regulate the use of mobile communications systems that are equipped with radio transmitters, for example two-way radios, telephones and theft alarms. Any such equipment installed in your vehicle should comply with Federal Communications Commission (FCC) and Canadian Radio Telecommunications Commission (CRTC) regulations and should be installed only by an authorized dealer.
- An authorized dealer needs to install mobile communications systems. Improper installation may harm the operation of your vehicle, particularly if the manufacturer did not design the mobile communication system specifically for automotive use.
- If you or an authorized Ford dealer add any non-Ford electrical or electronic accessories or components to your vehicle, you may adversely affect battery performance and durability. In addition, you may also adversely affect the performance of other electrical systems in the vehicle.

Accessories

AUXILIARY SWITCHES (IF EQUIPPED)

For maximum vehicle performance, keep the following information in mind when adding accessories or equipment to your vehicle:

- When adding accessories, equipment, passengers and luggage to your vehicle, do not exceed the total weight capacity of the vehicle or of the front or rear axle (GVWR or GAWR as indicated on the Safety Compliance Certification label). Ask an authorized dealer for specific weight information.
- The Federal Communications Commission (FCC) and Canadian Radio Telecommunications Commission (CRTC) regulate the use of mobile communications systems equipped with radio transmitters, for example, two-way radios, telephones and theft alarms. Any such equipment installed in your vehicle should comply with Federal Communications Commission (FCC) and Canadian Radio Telecommunications Commission (CRTC) regulations, and should be installed by an authorized dealer.
- An authorized dealer needs to install mobile communications systems. Improper installation may harm the operation of your vehicle, particularly if the manufacturer did not design the mobile communication system specifically for automotive use.
- If you or an authorized Ford dealer add any non-Ford electrical or electronic accessories or components to your vehicle, you may adversely affect battery performance and durability. In addition, you may also adversely affect the performance of other electrical systems in the vehicle.



The auxiliary switch option package provides six switches mounted in the instrument panel. These switches operate when the vehicle is running. We recommend, however, that the engine remain running to maintain battery charge when using the auxiliary switches for extended periods of time or higher current draws.

When switched on, the auxiliary switches provide electrical battery power for a variety of personal or commercial uses. Switch 1 is provided with 25 amps fuse. Switch 2 is provided with 15 amps fuse. Switch 3 is provided with 10 amps fuse. Switches 4, 5 and 6 provided with a 5 amps fuse.

The relay box for the auxiliary switches is in the left front of the engine compartment. See your authorized dealer for service.

The relays are coded as shown:

Accessories

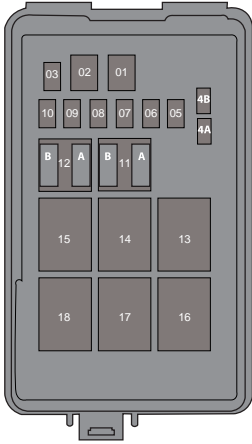

Each switch includes a blunt-cut, wire located next to the auxiliary fuse and relay box in the left front of the engine bay.

Fuse or Relay Number	Fuse Rating	Protected Component
1	25A ¹	Fuse 11A and 11B.
2	20A ¹	Fuse 12A and 12B.
3	25A ²	Relay AUX1.
4A	-	Not used.
4B	-	Not used.
5	15A ²	Relay AUX2.
6	-	Not used.
7	-	Not used.
8	-	Not used.
9	-	Not used.
10	-	Not used.
11A	10A ³	Relay AUX3.

Accessories

Fuse or Relay Number	Fuse Rating	Protected Component
11B	5A ³	Relay AUX4.
12A	5A ³	Relay AUX5.
12B	5A ³	Relay AUX6.
13	-	Relay AUX3 violet with green trace.
14	-	Relay AUX4 brown.
15	-	Relay AUX5 blue with orange trace.
16	-	Relay AUX2 green with brown trace.
17	-	Relay AUX6 yellow with orange trace.
18	-	Relay AUX1 yellow.

¹ LPJ-type fuse.

² M-type fuse.

³ Mini fuse.

Accessories

The power leads are coded as shown:

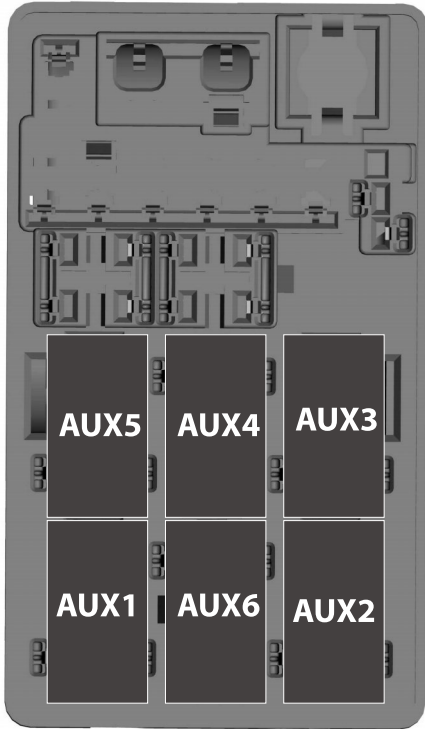

Switch	Circuit Number	Wire Color	Fuse Amp Rating
AUX 1	CAC05A	Yellow	25A ¹
AUX 2	CAC06A	Green with brown trace	15A ¹
AUX 3	CAC07A	Violet with green trace	10A ²
AUX 4	CAC08A	Brown	5A ²

Accessories

Switch	Circuit Number	Wire Color	Fuse Amp Rating
AUX 5	CAC13A	Blue with orange trace	5A ²
AUX 6	CAC14A	Yellow with orange trace	5A ²

¹ M-type fuse.

² Mini fuse

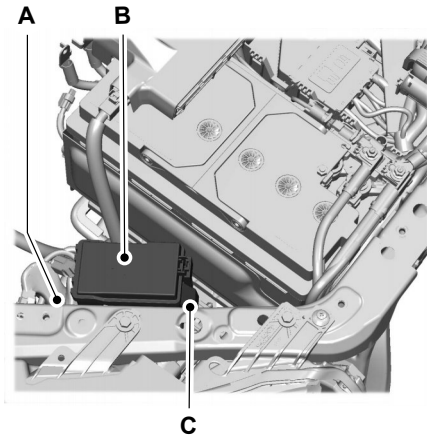

A - Press tabs to release mounting bracket.

B - Auxiliary fuse and relay box.

C - The power lead location.

Ford Protect

PROTECT YOURSELF FROM THE RISING COST OF VEHICLE REPAIRS WITH A FORD PROTECT EXTENDED SERVICE PLAN.

Ford Protect Extended Service Plans (U.S. Only)

Ford Protect extended service plan means peace of mind. It is the extended service plan backed by Ford Motor Company, and provides more protection beyond the New Vehicle Limited Warranty coverage. When you visit your Ford Dealer, Insist on Ford Protect extended service plans!

Ford Protect Can Quickly Pay for Itself

One trip to the Service Center could easily exceed the price of your Ford Protect extended service plan. With Ford Protect extended service plan you minimize your risk for unexpected repair bills and rising repair costs.

Up to 1,000+ Covered Vehicle Components

There are four mechanical Ford Protect extended service plans with different levels of coverage. Ask your authorized dealer for details.

1. PremiumCARE - Our most comprehensive coverage. With over 1,000 covered components, this plan is so complete it is probably easier to list what is not covered.
2. ExtraCARE - Covers 113 components, and includes many high-tech items.
3. BaseCARE - Covers 84 components.
4. PowertrainCARE - Covers 29 critical components.

Ford Protect extended service plans are honored by all authorized Ford dealers in the U.S., Canada and Mexico.

That means you get:

- Reliable, quality service at any Ford or Lincoln dealership.
- Repairs performed by factory trained technicians, using genuine parts.

Rental Car Reimbursement

1st day Rental Benefit

If you bring your car into your dealer for service, we'll give you a loaner to use for the day.

Extended Rental Benefits

If your vehicle is kept overnight for covered repairs, you are eligible for rental car coverage, including warranty repairs, and Field Service Actions.

Roadside Assistance

Exclusive 24/7 roadside assistance, including:

- Towing, flat-tire change and battery jump starts.
- Out of fuel and lock-out assistance.
- Travel expense reimbursement for lodging, meals and rental car.
- Assistance for taxi, shuttle, rental car coverage or other transportation.

Transferable Coverage

If you sell your vehicle before your Ford Protect extended service plan coverage expires, you can transfer any remaining coverage to the new owner. Which should give you and your potential buyer a little more peace of mind.

Ford Protect

Less Cost to Properly Maintain Your Vehicle

Ford Protect extended service plan also offers a Premium Maintenance Plan that covers all scheduled maintenance, and selected wear items. The coverage is prepaid, so you never have to worry about the cost of your vehicle's maintenance.

Covered maintenance includes:

- Windshield wiper blades.
- Spark plugs.
- The clutch disc (if equipped).
- Brake pads and linings.
- Shock absorbers.
- Struts.
- Engine belts.
- Engine coolant hoses, clamps and O-rings.
- Diesel exhaust fluid replenishment (if equipped).
- Cabin air filter replacement every 20,000 mi (32,000 km) (electric vehicles only).

Interest Free Finance Options

Just a 5% down payment will provide you with an affordable, no interest, no fee payment program allowing you all the security and benefits Ford Protect extended service plan has to offer while paying over time. You are pre-approved with no credit check or hassles. To learn more, call our Ford Protect extended service plan specialists at 800-367-3377.

Ford Protect Extended Service Plan
P.O. Box 321067
Detroit, MI 48232

Ford Protect Extended Service Plan (CANADA ONLY)

You can get more protection for your vehicle by purchasing a Ford Protect extended service plan. Ford Protect extended service plan is the only service contract backed by Ford Motor Company of Canada, Limited. Depending on the plan you purchase, Ford Protect extended service plan provides benefits such as:

- Rental reimbursement.
- Coverage for certain maintenance and wear items.
- Protection against repair costs after your New Vehicle Limited Warranty Coverage expires.
- Roadside Assistance benefits.

There are several Ford Protect extended service plans available in various time, distance and deductible combinations. Each plan is tailored to fit your own driving needs, including reimbursement for towing and rental. When you purchase Ford Protect extended service plan, you receive added peace-of-mind protection throughout Canada, the United States and Mexico, provided by a network of participating authorized Ford Motor Company dealers.

Note: *Repairs performed outside of Canada and the United States are not eligible for Ford Protect extended service plan coverage.*

This information is subject to change. For more information; visit your local Ford of Canada dealer or www.ford.ca to find the Ford Protect extended service plan that is right for you.

Scheduled Maintenance

GENERAL MAINTENANCE INFORMATION

Why Maintain Your Vehicle?

Carefully following the maintenance schedule helps protect against major repair expenses resulting from neglect or inadequate maintenance and may help to increase the value of your vehicle when you sell or trade it. Keep all receipts for completed maintenance with your vehicle.

We have established regular maintenance intervals for your vehicle based upon rigorous testing. It is important that you have your vehicle serviced at the proper times. These intervals serve two purposes; one is to maintain the reliability of your vehicle and the second is to keep your cost of owning your vehicle down.

It is your responsibility to have all scheduled maintenance performed and to make sure that the materials used meet the specifications identified in this owner's manual. See **Capacities and Specifications** (page 325).

Failure to perform scheduled maintenance invalidates warranty coverage on parts affected by the lack of maintenance.

Why Maintain Your Vehicle at Your Dealership?

Factory-Trained Technicians

Service technicians participate in extensive factory-sponsored certification training to help them become experts on the operation of your vehicle. Ask your dealership about the training and certification their technicians have received.

Genuine Ford and Motorcraft® Replacement Parts

Dealerships stock Ford, Motorcraft and Ford-authorized branded re-manufactured replacement parts. These parts meet or exceed our specifications. Parts installed at your dealership carry a nationwide 24-month or unlimited mile (kilometer) parts and labor limited warranty.

If you do not use our authorized parts, they may not meet our specifications and depending on the part, it could affect emissions compliance.

Convenience

Many dealerships have extended evening and Saturday hours to make your service visit more convenient and they offer one stop shopping. They can perform any services that are required on your vehicle, from general maintenance to collision repairs.

Note: *Not all dealers have extended hours or body shops. Please contact your dealer for details.*

Protecting Your Investment

Maintenance is an investment that pays dividends in the form of improved reliability, durability and resale value. To maintain the proper performance of your vehicle and its emission control systems, make sure you have scheduled maintenance performed at the designated intervals.

Your vehicle has an Intelligent Oil-Life Monitor system, a message appears in the information display at the proper oil change interval. This interval may be up to one year or 10,000 mi (16,000 km), hybrid vehicles may exceed 10,000 mi (16,000 km).

Scheduled Maintenance

Your vehicle can be driven in such a way that dilutes and increases the level of oil by short trips that do not allow the engine to get to operating temperature, extended idling, and low speed driving for long periods of time.

When the oil change message appears in the information display, it is time for an oil change. Make sure you perform the oil change within two weeks or 500 mi (800 km) of the message appearing. Make sure you reset the Intelligent Oil-Life Monitor after each oil change. See **Oil Change Indicator Reset** (page 268).

If your information display resets prematurely or becomes inoperative, you should perform the oil change interval at six months or 5,000 mi (8,000 km) from your last oil change. Never exceed one year or 10,000 mi (16,000 km) between oil change intervals.

Your vehicle is very sophisticated and built with multiple, complex, performance systems. Every manufacturer develops these systems using different specifications and performance features. That is why it is important to rely upon your dealership to properly diagnose and repair your vehicle.

We have recommended maintenance intervals for various parts and component systems based upon engineering testing. We rely upon this testing to determine the most appropriate mileage for replacement of oils and fluids to protect your vehicle at the lowest overall cost to you and recommends against maintenance schedules that deviate from the scheduled maintenance information.

We strongly recommend the use of only genuine Ford, Motorcraft or Ford-authorized re-manufactured replacement parts engineered for your vehicle.

Additives and Chemicals

This owner's manual and our Workshop Manual list the recommended additives and chemicals for your vehicle. We do not recommend using chemicals or additives not approved by us as part of your vehicle's normal maintenance. Please consult your warranty information.

Oils, Fluids and Flushing

In many cases, fluid discoloration is a normal operating characteristic and, by itself, does not necessarily indicate a concern or that the fluid needs to be changed. However, a qualified expert, such as the factory-trained technicians at your dealership, should inspect discolored fluids that also show signs of overheating or foreign material contamination immediately.

Make sure to change your vehicle's oils and fluids at the specified intervals or in conjunction with a repair. Flushing is a viable way to change fluid for many vehicle sub-systems during scheduled maintenance. It is critical that systems are flushed only with new fluid that is the same as that required to fill and operate the system or using a Ford-approved flushing chemical.

Owner Checks and Services

Make sure you perform the following basic maintenance checks and inspections every month or at six-month intervals.

Scheduled Maintenance

Check Every Month
Engine oil level.
Function of all interior and exterior lights.
Tires (including spare) for wear and proper pressure.
Windshield washer fluid level.
Fuel and water separator. Drain if necessary (or if indicated by the information display).
Holes and slots in the tail pipe to make sure they are functional and clear of debris.

Check Every Six Months
Battery connections. Clean if necessary.
Body and door drain holes for obstructions. Clean if necessary.
Cooling system fluid level and coolant strength.
Door weatherstrips for wear. Lubricate if necessary.
Hinges, latches and outside locks for proper operation. Lubricate if necessary.
Parking brake for proper operation.
Seatbelts and seat latches for wear and function.
Safety warning lamps (brake, ABS, airbag and seatbelt) for operation.
Washer spray and wiper operation. Clean or replace blades as necessary.

Multi-Point Inspection

In order to keep your vehicle running right, it is important to have the systems on your vehicle checked regularly. This can help identify potential issues and prevent major problems. We recommend having the following multi-point inspection performed at every scheduled maintenance interval to help make sure your vehicle keeps running great.

Scheduled Maintenance

Multi-Point Inspection	
Accessory drive belt(s)	Hazard warning system operation
Battery performance	Horn operation
Engine air filter	Radiator, cooler, heater and air conditioning hoses
Exhaust system	Suspension components for leaks or damage
Exterior lamps operation	Steering and linkage
Fluid levels ¹ ; fill if necessary	Tires (including spare) for wear and proper pressure ²
For oil and fluid leaks	Windshield for cracks, chips or pits
Half-shaft dust boots	Washer spray and wiper operation

¹ Brake, coolant recovery reservoir, automatic transmission and window washer.

² If your vehicle comes with a temporary mobility kit, check the tire sealant expiration Use By date on the canister. Replace as needed.

Be sure to ask your dealership service advisor or technician about the multi-point vehicle inspection. It is a comprehensive way to perform a thorough inspection of your vehicle. Your checklist gives you immediate feedback on the overall condition of your vehicle.

NORMAL SCHEDULED MAINTENANCE

Intelligent Oil-Life Monitor™

Your vehicle has an Intelligent Oil-Life Monitor that determines when you should change the engine oil based on how you use your vehicle. By using several important factors in its calculations, the monitor helps reduce the cost of owning your vehicle and reduces environmental waste at the same time.

This means you do not have to remember to change the oil on a mileage-based schedule. Your vehicle lets you know when an oil change is due by displaying a message in the information display.

The following table provides examples of vehicle use and its impact on oil change intervals. It is a guideline only. Actual oil change intervals depend on several factors and generally decrease with severity of use.

Scheduled Maintenance

When to Expect the OIL CHANGE REQUIRED Message	
Interval¹	Vehicle Use and Example
7,500–10,000 mi (12,000–16,000 km)	Normal
	Normal commuting with highway driving No, or moderate, load or towing Flat to moderately hilly roads No extended idling
5,000–7,500 mi (8,000–12,000 km)	Severe
	Moderate to heavy load or towing Mountainous or off-road conditions Extended idling Extended hot or cold operation
3,000–5,000 mi (5,000–8,000 km)	Extreme
	Maximum load or towing Extreme hot or cold operation Extended engine idling

¹Hybrid vehicles may achieve longer distances between oil changes, but do not exceed the 1 year maximum oil change interval. Remaining oil life can be accessed through the information display. See **Information Displays** (page 96).

Scheduled Maintenance

Normal Maintenance Intervals

At Every Oil Change Interval as Indicated by the Information Display¹
Change the engine oil and filter.
Rotate the tires, inspect tire wear and measure the tread depth.
Perform a multi-point inspection, recommended.
Inspect the automatic transmission fluid level, if your vehicle has a dipstick. Consult your dealer for requirements.
Inspect the brake pads, shoes, rotors, drums, brake linings, hoses and the parking brake.
Inspect the engine cooling system strength and hoses.
Inspect the exhaust system and heat shields.
Inspect the front axle and U-joints. Lubricate if equipped with grease fittings. Four-wheel drive vehicles.
Inspect the half-shaft boots.
Inspect the steering linkage, ball joints, suspension, tire-rod ends, driveshaft and the U-joints. Lubricate any areas with grease fittings.
Inspect the wheels and related components for abnormal noise, wear, looseness or drag.

¹ Do not exceed one year or 10,000 mi (16,000 km) between service intervals.

Brake Fluid Maintenance¹	
Every 3 Years	Change the brake fluid. ²

¹ Perform this maintenance item every 3 years. Do not exceed the designated time for the interval.

² Brake fluid servicing requires special equipment available at your authorized dealer.

Scheduled Maintenance

Other Maintenance Items ¹	
Every 20,000 mi (32,000 km)	Replace the cabin air filter.
Every 30,000 mi (48,000 km)	Replace the engine air filter.
Every 100,000 mi (160,000 km)	Replace the spark plugs.
	Inspect the accessory drive belt or belts. ²
Every 150,000 mi (240,000 km)	Change the automatic transmission fluid and filter.
	Change the front axle fluid. Four-wheel drive vehicles.
	Change the rear axle fluid.
	Change the transfer case fluid. Four-wheel drive vehicles.
	Replace the accessory drive belt or belts.
At 200,000 mi (320,000 km)	Change the engine coolant. ³

¹ Perform these maintenance items within 3,000 mi (4,800 km) of the last engine oil and filter change. Do not exceed the designated distance for the interval.

² After initial inspection, inspect every other oil change until replaced.

³ Initial replacement at 10 years or 200,000 mi (320,000 km), then every five years or 100,000 mi (160,000 km).

SPECIAL OPERATING CONDITIONS SCHEDULED MAINTENANCE

If you operate your vehicle **primarily** in any of the following conditions, you need to perform extra maintenance, as indicated. If you operate your vehicle **occasionally** under any of these conditions, it is not necessary to perform the extra maintenance. For specific recommendations, see your dealership service advisor or technician.

Perform the services shown in the following tables when specified or within 3,000 mi (4,800 km) of the **OIL CHANGE REQUIRED** message appearing in the information display.

Scheduled Maintenance

- Example 1:** The **OIL CHANGE REQUIRED** message comes on at 28,751 mi (46,270 km). Perform the 30,000 mi (48,000 km) automatic transmission fluid replacement.
- Example 2:** The **OIL CHANGE REQUIRED** message has **not** come on, but the odometer reads 30,000 mi (48,000 km) (for example, the Intelligent Oil-Life Monitor was reset at 25,000 mi (40,000 km)). Perform the engine air filter replacement.

Towing a Trailer or Using a Car-top Carrier	
As required	Change engine oil and filter as indicated by the information display and perform services listed in the Normal Scheduled Maintenance chart.
Inspect frequently, service as required	Inspect and lubricate U-joints.
	See axle maintenance items under Exceptions .
Every 60,000 mi (96,000 km)	Replace spark plugs.

Extensive Idling or Low-speed Driving for Long Distances, as in Heavy Commercial Use (Such as Delivery, Taxi, Patrol Car or Livery)	
As required	Change engine oil and filter as indicated by the information display and perform services listed in the Normal Scheduled Maintenance chart.
Inspect frequently, service as required	Replace engine air filter.
Every 60,000 mi (96,000 km)	Replace spark plugs.

Scheduled Maintenance

Operating in Dusty or Sandy Conditions (Such as Unpaved or Dusty Roads)	
Inspect frequently, service as required	Replace engine air filter.
Every 5,000 mi (8,000 km)	Inspect the wheels and related components for abnormal noise, wear, looseness or drag.
	Rotate tires, inspect tires for wear and measure tread depth.
Every 5,000 mi (8,000 km) or six months	Change engine oil and filter. ¹

¹Reset your Intelligent Oil-Life Monitor after each engine oil and filter change.

Off-road Operation	
Inspect frequently, service as required	Inspect steering linkage, ball joints and U-joints. Lubricate if equipped with grease fittings.
	Replace engine air filter.
Every 5,000 mi (8,000 km) or six months	Change engine oil and filter. ¹
	Inspect the wheels and related components for abnormal noise, wear, looseness or drag.
	Rotate tires, inspect tires for wear and measure tread depth.

¹Reset your Intelligent Oil-Life Monitor after each engine oil and filter change.

Exceptions

There are several exceptions to the Normal Schedule.

Axle and Transfer Case Maintenance

Axle(s) and transfer case (Four-wheel drive vehicles) fluid changes or level checks are not required unless a leak is suspected or the assembly has been submerged in water. Contact an authorized dealer for service.

California Fuel Filter Replacement

If you register your vehicle in California, the California Air Resources Board has determined that the failure to perform this maintenance item does not nullify the emission warranty or limit recall liability before the completion of your vehicle's useful life. Ford Motor Company, however, urges you to have all recommended maintenance services performed at the specified intervals and to record all vehicle service.

Scheduled Maintenance

Hot Climate Oil Change Intervals

Vehicles operating in the Middle East, North Africa, Sub-Saharan Africa or locations with similar climates using an American Petroleum Institute (API) Certified for Gasoline Engines (Certification mark) oil of SM or SN quality, the normal oil change interval is 3,000 mi (4,800 km).

If the available API SM or SN oils are not available, then the oil change interval is 1,800 mi (2,900 km).

Engine Air Filter Replacement

The life of the engine air filter is dependent on exposure to dusty and dirty conditions. Vehicles operated in these conditions require frequent inspection and replacement of the engine air filter.

Customer Information

WARRANTY INFORMATION

The following warranties may apply to your vehicle:

- New vehicle limited warranties.
- Emissions warranties, if applicable. (Note: Fully-electric vehicles are not eligible for emissions warranties.)
- Other warranties, if applicable.

Detailed warranty information specific to your vehicle can be found in the Warranty Guide at www.owner.ford.com.

The following California Warranty Statement, required by California regulations, applies to vehicles certified to California emissions standards and registered in a state that requires California emissions warranty. If applicable, additional California Emissions Warranties can be found in the Warranty Guide at www.owner.ford.com.

CALIFORNIA EMISSION CONTROL WARRANTY STATEMENT

YOUR WARRANTY RIGHTS AND OBLIGATIONS

The California Air Resources Board and Ford Motor Company are pleased to explain the emission control system warranty on your (year) vehicle. In California, new motor vehicles must be designated, built and equipped to meet the State's stringent anti-smog standards. Ford Motor Company must warrant the emission control system on your vehicle for the periods of time listed below provided there has been no abuse, neglect or improper maintenance of your vehicle.

Your emission control system may include parts such as the carburetor or fuel-injection system, the ignition system, catalytic converter and engine computer. Also included may be hoses, belts, connectors and other emission-related assemblies. Where a warrantable condition exists, Ford Motor Company will repair your vehicle at no cost to you including diagnosis, parts and labor.

MANUFACTURER'S WARRANTY COVERAGE:

(For 1990 and subsequent model passenger cars, light-duty trucks, and medium-duty vehicles.)

- For 3 years or 50,000 miles (whichever occurs first);

1) If your vehicle fails a Smog Check inspection, all necessary repairs and adjustments will be made by Ford Motor Company to ensure that your emission control system PERFORMANCE WARRANTY.

2) If any emission-related part on your vehicle is defective, the part will be repaired or replaced by Ford Motor Company. This is your short-term emission control system DEFECTS WARRANTY.

- For 7 years or 70,000 miles (whichever occurs first);

1) If an emission-related part listed in this warranty booklet specially noted with coverage for 7 years or 70,000 miles is defective, the part will be repaired or replaced by Ford Motor Company. This is your long-term emission control system DEFECTS WARRANTY.

Customer Information

OWNER'S WARRANTY RESPONSIBILITIES:

- As the vehicle owner, you are responsible for the performance of the required maintenance listed in your owner's manual. Ford Motor Company recommends that you retain all receipts covering maintenance on your vehicle, but Ford Motor Company cannot deny warranty solely for the lack of receipts or for your failure to ensure the performance of all scheduled maintenance.

- You are responsible for presenting your vehicle to a Ford or Lincoln dealer as soon as a problem exists. The warranty repairs should be completed in a reasonable amount of time, not to exceed 30 days.

- As the vehicle owner, you should also be aware that Ford Motor Company may deny you warranty coverage if your vehicle or a part has failed due to abuse, neglect, improper maintenance or unapproved modifications.

If you have any questions regarding your warranty rights and responsibilities, you should contact Ford Customer Service at 1-800-392-3673 or the California Air Resource Board at 9528 Telstar Avenue, El Monte, CA 91731.

Appendices

ELECTROMAGNETIC COMPATIBILITY



WARNING: Do not place objects or mount equipment on or near the airbag cover, on the side of the front or rear seatbacks, or in areas that may come into contact with a deploying airbag. Failure to follow these instructions may increase the risk of personal injury in the event of a crash.



WARNING: Do not fasten antenna cables to vehicle wiring, fuel pipes and brake pipes.



WARNING: Keep antenna and power cables at least 4 in (10 cm) from any electronic modules and airbags.

Note: We test and certify your vehicle to meet electromagnetic compatibility legislation. It is your responsibility to make sure that any equipment an authorized dealer installs on your vehicle complies with applicable local legislation and other requirements. Installation of some aftermarket electronic devices could degrade the performance of vehicle functions, which use radio frequency signals such as broadcast radio receiver, tire pressure monitoring system, push button start, **Bluetooth®** connectivity or satellite navigation.

Note: Any radio frequency transmitter equipment in your vehicle (such as cellular telephones and amateur radio transmitters) must keep to the parameters in the following illustrations and table. We do not provide any other special provisions or conditions for installations or use.

Car/SUV

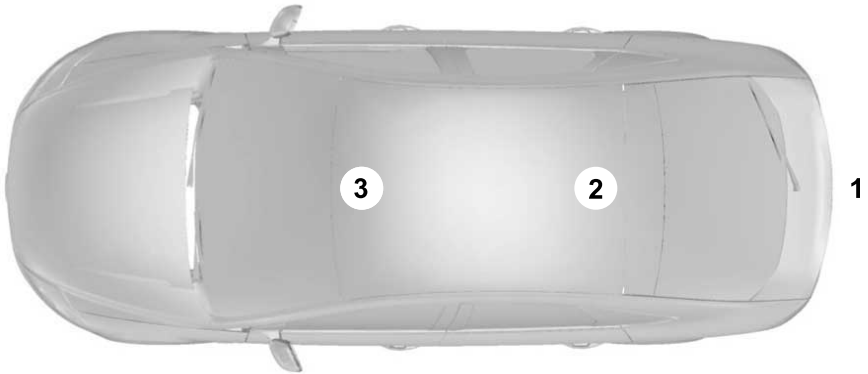

Appendices

Van

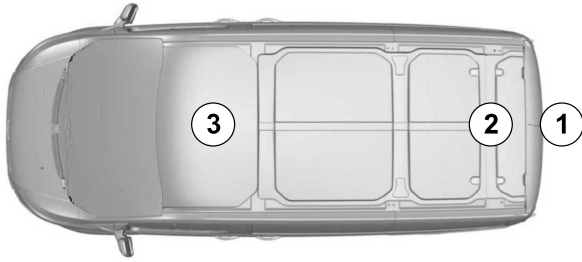

Truck

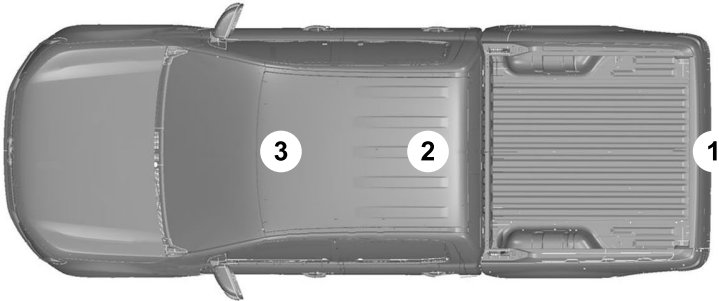

Appendices

Frequency Band MHz	Maximum Output Power Watt (Peak RMS)	Antenna Positions
1-30	50	1
50-54	50	2, 3
68-87	50	2, 3
142-176	50	2, 3
380-512	50	2, 3
806-870	10	2, 3

Appendices

END USER LICENSE AGREEMENT

VEHICLE SOFTWARE END USER LICENSE AGREEMENT (EULA) (if Equipped)

- You ("You" or "Your" as applicable) have acquired a vehicle having several devices, including SYNC ® and various control modules, ("DEVICES") that include software licensed or owned by Ford Motor Company and its affiliates ("FORD MOTOR COMPANY"). Those software products of FORD MOTOR COMPANY origin, as well as associated media, printed materials, and "online" or electronic documentation ("SOFTWARE") are protected by international intellectual property laws and treaties. The SOFTWARE is licensed, not sold. All rights reserved.
- The SOFTWARE may interface with and/or communicate with, or may be later upgraded to interface with and/or communicate with additional software and/or systems provided by FORD MOTOR COMPANY.

IF YOU DO NOT AGREE TO THIS END USER LICENSE AGREEMENT ("EULA") DO NOT USE THE DEVICES OR COPY THE SOFTWARE. ANY USE OF THE SOFTWARE, INCLUDING BUT NOT LIMITED TO USE ON THE DEVICES, WILL CONSTITUTE YOUR AGREEMENT TO THIS EULA (OR RATIFICATION OF ANY PREVIOUS CONSENT).

GRANT OF SOFTWARE LICENSE: This EULA grants you the following license:

- You may use the SOFTWARE as installed on the DEVICES and as otherwise interfacing with systems and/or services provide by or through FORD MOTOR COMPANY or its third party software and service providers.

Description of Other Rights and Limitations

- **Speech Recognition:** If the SOFTWARE includes speech recognition component(s), you should understand that speech recognition is an inherently statistical process and that recognition errors are inherent in the process. Neither FORD MOTOR COMPANY nor its suppliers shall be liable for any damages arising out of errors in the speech recognition process. It is your responsibility to monitor any speech recognition functions included in the system.
- **Limitations on Reverse Engineering, Decompilation and Disassembly:** You may not reverse engineer, decompile, translate, disassemble or attempt to discover any source code or underlying ideas or algorithms of the SOFTWARE nor permit others to reverse engineer, decompile or disassemble the SOFTWARE, except and only to the extent that such activity is expressly permitted by applicable law notwithstanding this limitation or to the extent as may be permitted by the licensing terms governing use of any open source components included with the SOFTWARE.
- **Limitations on Distributing, Copying, Modifying and Creating Derivative Works:** You may not distribute, copy, make modifications to or create derivative works based on the SOFTWARE, except and only to the extent that such activity is expressly permitted by applicable law notwithstanding this limitation or to the extent as may be permitted by the licensing terms governing use of any open source components included with the SOFTWARE.

Appendices

- **Single EULA:** The end user documentation for the DEVICES and related systems and services may contain multiple EULAs, such as multiple translations and/or multiple media versions (e.g., in the user documentation and in the software). Even if you receive multiple EULAs, you are licensed to use only one (1) copy of the SOFTWARE.
- **SOFTWARE Transfer:** You may permanently transfer your rights under this EULA only as part of a sale or transfer of the DEVICES, provided you retain no copies, you transfer all of the SOFTWARE (including all component parts, the media and printed materials, any upgrades, and, if applicable, the Certificate(s) of Authenticity), and the recipient agrees to the terms of this EULA. If the SOFTWARE is an upgrade, any transfer must include all prior versions of the SOFTWARE.
- **Termination:** Without prejudice to any other rights, FORD MOTOR COMPANY may terminate this EULA if you fail to comply with the terms and conditions of this EULA.
- **Internet-Based Services Components:** The SOFTWARE may contain components that enable and facilitate the use of certain Internet-based services. You acknowledge and agree that FORD MOTOR COMPANY, third party software and service suppliers, its affiliates and/or its designated agent may automatically check the version of the SOFTWARE and/or its components that you are utilizing and may provide upgrades or supplements to the SOFTWARE that may be automatically downloaded to your DEVICES.
- **Additional Software/Services:** The SOFTWARE may permit FORD MOTOR COMPANY, third party software and service suppliers, its affiliates and/or its designated agent to provide or make available to you SOFTWARE updates, supplements, add-on components, or Internet-based services components of the SOFTWARE after the date you obtain your initial copy of the SOFTWARE ("Supplemental Components".) SOFTWARE updates may cause you to incur additional charges from your wireless service provider. If FORD MOTOR COMPANY or third party software and services suppliers provide or make available to you Supplemental Components and no other EULA terms are provided along with the Supplemental Components, then the terms of this EULA shall apply. FORD MOTOR COMPANY, its affiliates and/or its designated agent reserve the right to discontinue without liability any Internet-based services provided to you or made available to you through the use of the SOFTWARE.

Appendices

- **Links to Third Party Sites:** The SOFTWARE may provide you with the ability to link to third party sites. The third party sites are not under the control of FORD MOTOR COMPANY, its affiliates and/or its designated agent. Neither FORD MOTOR COMPANY nor its affiliates nor its designated agent are responsible for (i) the contents of any third party sites, any links contained in third party sites, or any changes or updates to third party sites, or (ii) webcasting or any other form of transmission received from any third party sites. If the SOFTWARE provides links to third party sites, those links are provided to you only as a convenience, and the inclusion of any link does not imply an endorsement of the third party site by FORD MOTOR COMPANY, its affiliates and/or its designated agent.
- **Obligation to Drive Responsibly:** You recognize your obligation to drive responsibly and keep attention on the road. You will read and abide with the DEVICES operating instructions particularly as they pertain to safety and you agree to assume any risk associated with the use of the DEVICES.

UPGRADES AND RECOVERY MEDIA:

If the SOFTWARE is provided by FORD MOTOR COMPANY separate from the DEVICES on media such as a ROM chip, CD ROM disk(s) or via web download or other means, and is labeled "For Upgrade Purposes Only" or "For Recovery Purposes Only" you may install one (1) copy of such SOFTWARE onto the DEVICES as a replacement copy for the existing SOFTWARE, and use it in accordance with this EULA, including any additional EULA terms accompanying the upgrade SOFTWARE.

INTELLECTUAL PROPERTY RIGHTS:

All title and intellectual property rights in and to the SOFTWARE (including but not limited to any images, photographs, animations, video, audio, music, text and "applets" incorporated into the SOFTWARE), the accompanying printed materials, and any copies of the SOFTWARE, are owned by FORD MOTOR COMPANY, or its affiliates or suppliers. The SOFTWARE is licensed, not sold. You may not copy the printed materials accompanying the SOFTWARE. All title and intellectual property rights in and to the content which may be accessed through use of the SOFTWARE is the property of the respective content owner and may be protected by applicable copyright or other intellectual property laws and treaties. This EULA grants you no rights to use such content outside its intended use. All rights not specifically granted under this EULA are reserved by FORD MOTOR COMPANY, its affiliates, and third party software and service providers and suppliers. Use of any on-line services which may be accessed through the SOFTWARE may be governed by the respective terms of use relating to such services. If this SOFTWARE contains documentation that is provided only in electronic form, you may print one copy of such electronic documentation.

EXPORT RESTRICTIONS: You acknowledge that the SOFTWARE is subject to U.S. and European Union export jurisdiction. You agree to comply with all applicable international and national laws that apply to the SOFTWARE, including the U.S. Export Administration Regulations, as well as end-user, end-use and destination restrictions issued by U.S. and other governments.

Appendices

TRADEMARKS: This EULA does not grant you any rights in connection with any trademarks or service marks of FORD MOTOR COMPANY, its affiliates, and third party software and service providers.

The **Bluetooth®** word mark and logos are registered trademarks owned by **Bluetooth SIG, Inc.** and any use of such marks by Ford Motor Company is under license. Other trademarks and trade names are those of their respective owners.

PRODUCT SUPPORT: Please refer to FORD MOTOR COMPANY instructions provided in the documentation for the DEVICES product support, such as the vehicle owner guide.

Should you have any questions concerning this EULA, or if you desire to contact FORD MOTOR COMPANY for any other reason, please refer to the address provided in the documentation for the DEVICES.

No Liability for Certain Damages: EXCEPT AS PROHIBITED BY LAW, FORD MOTOR COMPANY, ANY THIRD PARTY SOFTWARE OR SERVICES SUPPLIERS, AND THEIR AFFILIATES SHALL HAVE NO LIABILITY FOR ANY INDIRECT, SPECIAL, CONSEQUENTIAL OR INCIDENTAL DAMAGES ARISING FROM OR IN CONNECTION WITH THE USE OR PERFORMANCE OF THE SOFTWARE. THIS LIMITATION SHALL APPLY EVEN IF ANY REMEDY FAILS OF ITS ESSENTIAL PURPOSE. THERE ARE NO WARRANTIES OTHER THAN THOSE THAT MAY BE EXPRESSLY PROVIDED FOR YOUR NEW VEHICLE.

SYNC® Automotive Important Safety Information Read and follow instructions:

- Before using your SYNC® system, read and follow all instructions and safety information provided in this end user manual ("Owner Guide".) Not following precautions found in the Owner Guide can lead to an accident or other serious injuries.

General Operation

- **Voice Command Control:** Certain functions within the SYNC® system may be accomplished using voice commands. Using voice commands while driving helps you to operate the system without removing your hands from the wheel or eyes from the road.
- **Prolonged Views of Screen:** Do not access any function requiring a prolonged view of the screen while you are driving. Pull over in a safe and legal manner before attempting to access a function of the system requiring prolonged attention.
- **Volume Setting:** Do not raise the volume excessively. Keep the volume at a level where you can still hear outside traffic and emergency signals while driving. Driving while unable to hear these sounds could cause an accident.
- **Navigation Features:** Any navigation features included in the system are intended to provide turn by turn instructions to get you to a desired destination. Please make certain all persons using this system carefully read and follow instructions and safety information fully.

Appendices

- **Distraction Hazard:** Any navigation features may require manual (non-verbal) setup. Attempting to perform such set-up or insert data while driving can distract your attention and could cause an accident or other serious injury. Stop the vehicle in a safe and legal manner before attempting these operations.
 - **Let Your Judgment Prevail:** Any navigation features are provided only as an aid. Make your driving decisions based on your observations of local conditions and existing traffic regulations. Any such feature is not a substitute for your personal judgment. Any route suggestions made by this system should never replace any local traffic regulations or your personal judgment or knowledge of safe driving practices.
 - **Route Safety:** Do not follow the route suggestions if doing so would result in an unsafe or illegal maneuver, if you would be placed in an unsafe situation, or if you would be directed into an area that you consider unsafe. The driver is ultimately responsible for the safe operation of the vehicle and therefore, must evaluate whether it is safe to follow the suggested directions.
 - **Potential Map Inaccuracy:** Maps used by this system may be inaccurate because of changes in roads, traffic controls or driving conditions. Always use good judgment and common sense when following the suggested routes.
 - **Emergency Services:** Do not rely on any navigation features included in the system to route you to emergency services. Ask local authorities or an emergency services operator for these locations. Not all emergency services such as police, fire stations, hospitals and clinics are likely to be contained in the map database for such navigation features.
- Your Responsibilities and Assumptions of Risk
- You agree to each of the following:(a) Any use of the SOFTWARE while driving an automobile or other vehicle in violation of applicable law or otherwise driving in an unsafe manner presents a significant risk of distracted driving and should not be attempted under any circumstances;(b) Use of the SOFTWARE at excessive volume poses a significant risk of hearing damage and should not be attempted under any circumstances;(c) The SOFTWARE may not be compatible with new or different versions of an operating system, third party software, or third party services, and the SOFTWARE may potentially cause a critical failure of an operating system, third party software, or third party service.(d) Any third party service accessed by or third party software used with the SOFTWARE (i) may charge an additional fee for access, (ii) may not work correctly, on an uninterrupted basis, or error free, (iii) may change streaming formats or discontinue operation, (iv) may contain adult, profane or offensive content; and (v) may contain inaccurate, false or misleading traffic, weather, financial or safety information or other content; and (e) Use of the SOFTWARE may cause you to incur additional charges from your wireless service provider (WSP) and any data or minute calculators that may be included in the software program are for reference only, are not warranted in any way and should not be relied upon in anyway.
 - When using the SOFTWARE, you agree to be responsible for and assume the entire risk to the items set forth in Section (a) – (e) above.

Appendices

Disclaimer of Warranty

YOU EXPRESSLY ACKNOWLEDGE AND AGREE THAT USE OF THE DEVICES AND SOFTWARE IS AT YOUR SOLE RISK AND THAT THE ENTIRE RISK AS TO SATISFACTORY QUALITY, PERFORMANCE, COMPATIBILITY, ACCURACY AND EFFORT IS WITH YOU. TO THE MAXIMUM EXTENT PERMITTED BY APPLICABLE LAW, THE SOFTWARE AND ANY THIRD PARTY SOFTWARE OR THIRD-PARTY SERVICES ARE PROVIDED "AS IS" AND "AS AVAILABLE", WITH ALL FAULTS AND WITHOUT WARRANTY OF ANY KIND, AND FORD MOTOR COMPANY HEREBY DISCLAIMS ALL WARRANTIES AND CONDITIONS WITH RESPECT TO THE SOFTWARE, THIRD PARTY SOFTWARE, AND THIRD-PARTY SERVICES, EITHER EXPRESS, IMPLIED OR STATUTORY, INCLUDING, BUT NOT LIMITED TO, THE IMPLIED WARRANTIES AND/OR CONDITIONS OF MERCHANTABILITY, OF SATISFACTORY QUALITY, OF FITNESS FOR AN PARTICULAR PURPOSE, OF ACCURACY, OF QUIET ENJOYMENT, AND NON-INFRINGEMENT OF THIRD-PARTY RIGHTS. FORD MOTOR COMPANY DOES NOT WARRANT (a) AGAINST INTERFERENCE WITH YOUR ENJOYMENT OF THE SOFTWARE, THIRD PARTY SOFTWARE, OR THIRD-PARTY SERVICES, (b) THAT THE SOFTWARE, THIRD PARTY SOFTWARE, OR THIRD-PARTY SERVICES WILL MEET YOUR REQUIREMENTS, (c) THAT THE OPERATION OF THE SOFTWARE, THIRD PARTY SOFTWARE, OR THIRD-PARTY SERVICES WILL BE UNINTERRUPTED OR ERROR-FREE, (d) OR THAT DEFECTS IN THE SOFTWARE, THIRD PARTY SOFTWARE, OR THIRD-PARTY SERVICES WILL BE CORRECTED. NO ORAL OR WRITTEN INFORMATION OR ADVICE GIVEN BY FORD MOTOR COMPANY OR ITS AUTHORIZED REPRESENTATIVE SHALL

CREATE A WARRANTY. SHOULD THE SOFTWARE, THIRD PARTY SOFTWARE, OR THIRD-PARTY SERVICES PROVE DEFECTIVE, YOU ASSUME THE ENTIRE COST OF ALL NECESSARY SERVICING, REPAIR OR CORRECTION. SOME JURISDICTIONS DO NOT ALLOW THE DISCLAIMER OF IMPLIED WARRANTIES OR LIMITATIONS ON APPLICABLE STATUTORY RIGHTS OF A CONSUMER, SO THE ABOVE DISCLAIMER MAY NOT FULLY APPLY TO YOU. THE SOLE WARRANTY PROVIDED BY FORD MOTOR COMPANY SHALL BE FOUND IN THE WARRANTY INFORMATION INCLUDING WITH YOUR OWNER GUIDE. TO THE EXTENT THAT THERE IS ANY CONFLICT BETWEEN THE TERMS OF THIS SECTION AND THE WARRANTY BOOKLET, THE WARRANTY BOOKLET SHALL CONTROL.

Applicable Law, Venue, Jurisdiction

- The laws of the State of Michigan govern this EULA and Your use of the SOFTWARE. Your use of the SOFTWARE may also be subject to other local, state, national, or international laws. Any litigation arising out of or related to this EULA shall be brought and maintained exclusively in a court of the State of Michigan located in Wayne County or in the United States District Court for the Eastern District of Michigan. You hereby consent to submit to the personal jurisdiction of a court in the State of Michigan located in Wayne County and the United States District Court for the Eastern District of Michigan for any dispute arising out of or relating to this EULA.

Appendices

Binding Arbitration and Class Action Waiver

(a) Application. This Section applies to any dispute EXCEPT IT DOES NOT INCLUDE A DISPUTE RELATING TO COPYRIGHT INFRINGEMENT, OR TO THE ENFORCEMENT OR VALIDITY OF YOUR, FORD MOTOR COMPANY, OR ANY OF FORD MOTOR COMPANY'S LICENSORS' INTELLECTUAL PROPERTY RIGHTS. Dispute means any dispute, action, or other controversy between You and FORD MOTOR COMPANY, other than the exceptions listed above, concerning the SOFTWARE (including its price) or this EULA, whether in contract, warranty, tort, statute, regulation, ordinance, or any other legal or equitable basis.

(b) Notice of Dispute. In the event of a Dispute, You or FORD MOTOR COMPANY must give the other a "Notice of Dispute", which is a written statement of the name, address, and contact information of the party giving it, the facts giving rise to the dispute, and the relief requested. You and FORD MOTOR COMPANY will attempt to resolve any dispute through informal negotiation within 60 days from the date the Notice of Dispute is sent. After 60 days, You or FORD MOTOR COMPANY may commence arbitration.

(c) Small claims court. You may also litigate any dispute in small claims court in your county of residence or FORD MOTOR COMPANY'S principal place of business, if the dispute meets all requirements to be heard in the small claims court. You may litigate in small claims court whether or not You negotiated informally first.

(d) Binding arbitration. If You and FORD MOTOR COMPANY, do not resolve any dispute by informal negotiation or in small claims court, any other effort to resolve the dispute will be conducted exclusively by binding arbitration. You are giving up

the right to litigate (or participate in as a party or class member) all disputes in court before a judge or jury. Instead, all disputes will be resolved before a neutral arbitrator, whose decision will be final except for a limited right of appeal under the Federal Arbitration Act. Any court with jurisdiction over the parties may enforce the arbitrator's award.

(e) Class action waiver. Any proceedings to resolve or litigate any dispute in any forum will be conducted solely on an individual basis. Neither you nor FORD MOTOR COMPANY, will seek to have any dispute heard as a class action, as a private attorney general action, or in any other proceeding in which any party acts or proposes to act in a representative capacity. No arbitration or proceeding will be combined with another without the prior written consent of all parties to all affected arbitrations or proceedings.

(f) Arbitration procedure. Any arbitration will be conducted by the American Arbitration Association (the "AAA"), under its Commercial Arbitration Rules. If You are an individual and use the SOFTWARE for personal or vehicle use, or if the value of the dispute is \$75,000 or less whether or not You are an individual or how You use the SOFTWARE, the AAA Supplementary Procedures for Consumer-Related Disputes will also apply. To commence arbitration, submit a Commercial Arbitration Rules Demand for Arbitration form to the AAA. You may request a telephonic or in-person hearing by following the AAA rules. In a dispute involving \$10,000 or less, any hearing will be telephonic unless the arbitrator finds good cause to hold an in-person hearing instead. For more information, see adr.org or call 1-800-778-7879. You agree to commence arbitration only in your county of residence or FORD MOTOR COMPANY'S principal place of business. The arbitrator

Appendices

may award the same damages to You individually as a court could. The arbitrator may award declaratory or injunctive relief only to You individually, and only to the extent required to satisfy Your individual claim.

(g) Arbitration fees and incentives.

- i. Disputes involving \$75,000 or less. FORD MOTOR COMPANY will promptly reimburse your filing fees and pay the AAA's and arbitrator's fees and expenses. If you reject FORD MOTOR COMPANY'S last written settlement offer made before the arbitrator was appointed ("last written offer"), your dispute goes all the way to an arbitrator's decision (called an "award"), and the arbitrator awards you more than the last written offer, FORD MOTOR COMPANY will give you three incentives: (1) pay the greater of the award or \$1,000; (2) pay twice your reasonable attorney's fees, if any; and (3) reimburse any expenses (including expert witness fees and costs) that your attorney reasonably accrues for investigating, preparing, and pursuing your claim in arbitration. The arbitrator will determine the amounts.
- ii. Disputes involving more than \$75,000. The AAA rules will govern payment of filing fees and the AAA's and arbitrator's fees and expenses.
- iii. Disputes involving any amount. In any arbitration you commence, FORD MOTOR COMPANY will seek its AAA or arbitrator's fees and expenses, or Your filing fees it reimbursed, only if the arbitrator finds the arbitration frivolous or brought for an improper purpose. In any arbitration FORD MOTOR COMPANY commences, it will pay all

filing, AAA, and arbitrator's fees and expenses. It will not seek its attorney's fees or expenses from you in any arbitration. Fees and expenses are not counted in determining how much a dispute involves.

(h) Claims or disputes must be filed within one year. To the extent permitted by law, any claim or dispute under this EULA to which this Section applies must be filed within one year in small claims court (Section c) or in arbitration (Section d). The one-year period begins when the claim or dispute first could be filed. If such a claim or dispute is not filed within one year, it is permanently barred.

(i) Severability. If the class action waiver (Section e) is found to be illegal or unenforceable as to all or some parts of a dispute, then that portion of Section e will not apply to those parts. Instead, those parts will be severed and proceed in a court of law, with the remaining parts proceeding in arbitration. If any other provision of that portion Section e is found to be illegal or unenforceable, that provision will be severed with the remainder of Section e remaining in full force and effect.

Telenav Software End User License Agreement

Please read these terms and conditions carefully before you use the TeleNav Software. Your use of the TeleNav Software indicates that you accept these terms and conditions. If you do not accept these terms and conditions, do not break the seal of the package, launch, or otherwise use the TeleNav Software. TeleNav may revise this Agreement and the privacy policy at any time, with or without notice to you. You agree to visit <http://www.telenav.com> from time to time to review the then current version of this Agreement and of the privacy policy.

Appendices

1. Safe and Lawful Use

You acknowledge that devoting attention to the TeleNav Software may pose a risk of injury or death to you and others in situations that otherwise require your undivided attention, and you therefore agree to comply with the following when using the TeleNav Software:

- (a) observe all traffic laws and otherwise drive safely;
- (b) use your own personal judgment while driving. If you feel that a route suggested by the TeleNav Software instructs you to perform an unsafe or illegal maneuver, places you in an unsafe situation, or directs you into an area that you consider to be unsafe, do not follow such instructions;
- (c) do not input destinations, or otherwise manipulate the TeleNav Software, unless your vehicle is stationary and parked;
- (d) do not use the TeleNav Software for any illegal, unauthorized, unintended, unsafe, hazardous, or unlawful purposes, or in any manner inconsistent with this Agreement;
- (e) arrange all GPS and wireless devices and cables necessary for use of the TeleNav Software in a secure manner in your vehicle so that they will not interfere with your driving and will not prevent the operation of any safety device (such as an airbag).

You agree to indemnify and hold TeleNav harmless against all claims resulting from any dangerous or otherwise inappropriate use of the TeleNav Software in any moving vehicle, including as a result of your failure to comply with the directions above.

2. Account Information

You agree: (a) when registering the TeleNav Software, to provide TeleNav with true, accurate, current, and complete information about yourself, and (b) to inform TeleNav promptly of any changes to such information, and to keep it true, accurate, current and complete.

3. Software License

- Subject to your compliance with the terms of this Agreement, TeleNav hereby grants to you a personal, non-exclusive, non-transferable license (except as expressly permitted below in connection with your permanent transfer of the TeleNav Software license), without the right to sublicense, to use the TeleNav Software (in object code form only) in order to access and use the TeleNav Software. This license shall terminate upon any termination or expiration of this Agreement. You agree that you will use the TeleNav Software only for your personal business or leisure purposes, and not to provide commercial navigation services to other parties.

3.1 License Limitations

- **(a)** reverse engineer, decompile, disassemble, translate, modify, alter or otherwise change the TeleNav Software or any part thereof; **(b)** attempt to derive the source code, audio library or structure of the TeleNav Software without the prior express written consent of TeleNav; **(c)** remove from the TeleNav Software, or alter, any of TeleNav's or its suppliers' trademarks, trade names, logos, patent or copyright notices, or other notices or markings; **(d)**

Appendices

distribute, sublicense or otherwise transfer the TeleNav Software to others, except as part of your permanent transfer of the TeleNav Software; or **(e)** use the TeleNav Software in any manner that

- i. infringes the intellectual property or proprietary rights, rights of publicity or privacy or other rights of any party,
- ii. violates any law, statute, ordinance or regulation, including but not limited to laws and regulations related to spamming, privacy, consumer and child protection, obscenity or defamation, or
- iii. is harmful, threatening, abusive, harassing, tortuous, defamatory, vulgar, obscene, libelous, or otherwise objectionable; and (f) lease, rent out, or otherwise permit unauthorized access by third parties to the TeleNav Software without advanced written permission of TeleNav.

4. Disclaimers

- To the fullest extent permissible pursuant to applicable law, in no event will TeleNav, its licensors and suppliers, or agents or employees of any of the foregoing, be liable for any decision made or action taken by you or anyone else in reliance on the information provided by the TeleNav Software. TeleNav also does not warrant the accuracy of the map or other data used for the TeleNav Software. Such data may not always reflect reality due to, among other things, road closures, construction, weather, new roads and other changing conditions. You are responsible for the entire risk arising out of your use of the TeleNav Software. For example but without limitation, you agree not to rely on the TeleNav Software for critical navigation in areas where the well-being or survival of you or others

is dependent on the accuracy of navigation, as the maps or functionality of the TeleNav Software are not intended to support such high risk applications, especially in more remote geographical areas.

- TELENAV EXPRESSLY DISCLAIMS AND EXCLUDES ALL WARRANTIES IN CONNECTION WITH THE TELENAV SOFTWARE, WHETHER STATUTORY, EXPRESS OR IMPLIED, INCLUDING ALL WARRANTIES WHICH MAY ARISE FROM COURSE OF DEALING, CUSTOM OR TRADE AND INCLUDING, BUT NOT LIMITED TO, THE IMPLIED WARRANTIES OF MERCHANTABILITY, FITNESS FOR A PARTICULAR PURPOSE AND NON-INFRINGEMENT OF THIRD PARTY RIGHTS WITH RESPECT TO THE TELENAV SOFTWARE.
- Certain jurisdictions do not permit the disclaimer of certain warranties, so this limitation may not apply to you.

5. Limitation of Liability

- TO THE EXTENT PERMITTED UNDER APPLICABLE LAW, UNDER NO CIRCUMSTANCES SHALL TELENAV OR ITS LICENSORS AND SUPPLIERS BE LIABLE TO YOU OR TO ANY THIRD PARTY FOR ANY INDIRECT, INCIDENTAL, CONSEQUENTIAL, SPECIAL OR EXEMPLARY DAMAGES (INCLUDING IN EACH CASE, BUT NOT LIMITED TO, DAMAGES FOR THE INABILITY TO USE THE EQUIPMENT OR ACCESS DATA, LOSS OF DATA, LOSS OF BUSINESS, LOSS OF PROFITS, BUSINESS INTERRUPTION OR THE LIKE) ARISING OUT OF THE USE OF OR INABILITY TO USE THE TELENAV SOFTWARE, EVEN IF TELENAV HAS BEEN ADVISED OF THE POSSIBILITY OF SUCH DAMAGES. NOTWITHSTANDING ANY DAMAGES THAT YOU MIGHT INCUR FOR ANY

Appendices

REASON WHATSOEVER (INCLUDING, WITHOUT LIMITATION, ALL DAMAGES REFERENCED HEREIN AND ALL DIRECT OR GENERAL DAMAGES IN CONTRACT, TORT (INCLUDING NEGLIGENCE) OR OTHERWISE), THE ENTIRE LIABILITY OF TELENAV AND OF ALL OF TELENAV'S SUPPLIERS SHALL BE LIMITED TO THE AMOUNT ACTUALLY PAID BY YOU FOR THE TELENAV SOFTWARE. SOME STATES AND/OR JURISDICTIONS DO NOT ALLOW THE EXCLUSION OR LIMITATION OF INCIDENTAL OR CONSEQUENTIAL DAMAGES, SO THE ABOVE LIMITATIONS OR EXCLUSIONS MAY NOT APPLY TO YOU.

6. Arbitration and Governing Law

- You agree that any dispute, claim or controversy arising out of or relating to this Agreement or the TeleNav Software shall be settled by independent arbitration involving a neutral arbitrator and administered by the American Arbitration Association in the County of Santa Clara, California. The arbitrator shall apply the Commercial Arbitration Rules of the American Arbitration Association, and the judgment upon the award rendered by the arbitrator may be entered by any court having jurisdiction. Note that there is no judge or jury in an arbitration proceeding and the decision of the arbitrator shall be binding upon both parties. You expressly agree to waive your right to a jury trial. This Agreement and performance hereunder will be governed by and construed in accordance with the laws of the State of California, without giving effect to its conflict of law provisions. To the extent judicial action is necessary in connection with the binding arbitration, both TeleNav and you agree to submit

to the exclusive jurisdiction of the courts of the County of Santa Clara, California. The United Nations Convention on Contracts for the International Sale of Goods shall not apply.

7. Assignment

- You may not resell, assign, or transfer this Agreement or any of your rights or obligations, except in totality, in connection with your permanent transfer of the TeleNav Software, and expressly conditioned upon the new user of the TeleNav Software agreeing to be bound by the terms and conditions of this Agreement. Any such sale, assignment or transfer that is not expressly permitted under this paragraph will result in immediate termination of this Agreement, without liability to TeleNav, in which case you and all other parties shall immediately cease all use of the TeleNav Software. Notwithstanding the foregoing, TeleNav may assign this Agreement to any other party at any time without notice, provided the assignee remains bound by this Agreement.

8. Miscellaneous

8.1

This Agreement constitutes the entire agreement between TeleNav and you with respect to the subject matter hereof.

8.2

Except for the limited licenses expressly granted in this Agreement, TeleNav retains all right, title and interest in and to the TeleNav Software, including without limitation all related intellectual property rights. No licenses or other rights which are not expressly granted in this Agreement are intended to, or shall be, granted or

Appendices

conferred by implication, statute, inducement, estoppel or otherwise, and TeleNav and its suppliers and licensors hereby reserve all of their respective rights other than the licenses explicitly granted in this Agreement.

8.3

By using the TeleNav Software, you consent to receive from TeleNav all communications, including notices, agreements, legally required disclosures or other information in connection with the TeleNav Software (collectively, "Notices") electronically. TeleNav may provide such Notices by posting them on TeleNav's Website or by downloading such Notices to your wireless device. If you desire to withdraw your consent to receive Notices electronically, you must discontinue your use of the TeleNav Software.

8.4

TeleNav's or your failure to require performance of any provision shall not affect that party's right to require performance at any time thereafter, nor shall a waiver of any breach or default of this Agreement constitute a waiver of any subsequent breach or default or a waiver of the provision itself.

8.5

If any provision herein is held unenforceable, then such provision will be modified to reflect the intention of the parties, and the remaining provisions of this Agreement will remain in full force and effect.

8.6

The headings in this Agreement are for convenience of reference only, will not be deemed to be a part of this Agreement, and will not be referred to in connection with the construction or interpretation of this Agreement. As used in this Agreement, the words "include" and "including" and variations thereof, will not be deemed to be terms of limitation, but rather will be deemed to be followed by the words "without limitation".

9. Other Vendors Terms and Conditions

- The Telenav Software utilizes map and other data licensed to Telenav by third party vendors for the benefit of you and other end users. This Agreement includes end-user terms applicable to these companies (included at the end of this Agreement), and thus your use of the Telenav Software is also subject to such terms. You agree to comply with the following additional terms and conditions, which are applicable to Telenav's third party vendor licensors:

9.1 End User Terms Required by HERE North America, LLC

The data ("Data") is provided for your personal, internal use only and not for resale. It is protected by copyright, and is subject to the following terms and conditions which are agreed to by you, on the one hand, and Telenav ("Telenav") and its licensors (including their licensors and suppliers) on the other hand.

© 2013 HERE. All rights reserved.

The Data for areas of Canada includes information taken with permission from Canadian authorities, including: © Her Majesty the Queen in Right of Canada, © Queen's Printer for Ontario, © Canada Post Corporation, GeoBase®, © Department of Natural Resources Canada.

Appendices

HERE holds a non-exclusive license from the United States Postal Service® to publish and sell ZIP+4® information.

©United States Postal Service® 2014. Prices are not established, controlled or approved by the United States Postal Service®. The following trademarks and registrations are owned by the USPS: United States Postal Service, USPS, and ZIP+4

The Data for Mexico includes certain data from Instituto Nacional de Estadística y Geografía.

9.2 End User Terms Required by NAV2 (Shanghai) Co., Ltd

The data (“Data”) is provided for your personal, internal use only and not for resale. It is protected by copyright, and is subject to the following terms and conditions which are agreed to by you, on the one hand, and NAV2 (Shanghai) Co., Ltd (“NAV2”) and its licensors (including their licensors and suppliers) on the other hand. 20xx. All rights reserved

Terms and Conditions

Permitted Use. You agree to use this Data together with the Telenav Software solely for the internal business and personal purposes for which you were licensed, and not for service bureau, time-sharing or other similar purposes. Accordingly, but subject to the restrictions set forth in the following paragraphs, you agree not to otherwise reproduce, copy, modify, decompile, disassemble, create any derivative works of, or reverse engineer any portion of this Data, and may not transfer or distribute it in any form, for any purpose, except to the extent permitted by mandatory laws.

Restrictions. Except where you have been specifically licensed to do so by Telenav, and without limiting the preceding paragraph, you may not use this Data (a) with any products, systems, or applications installed or otherwise connected to or in communication with vehicles, capable of vehicle navigation, positioning, dispatch, real time route guidance, fleet management or similar applications; or (b) with or in communication with any positioning devices or any mobile or wireless-connected electronic or computer devices, including without limitation cellular phones, palmtop and handheld computers, pagers, and personal digital assistants or PDAs.

Warning. The Data may contain inaccurate or incomplete information due to the passage of time, changing circumstances, sources used and the nature of collecting comprehensive geographic data, any of which may lead to incorrect results.

No Warranty. This Data is provided to you “as is,” and you agree to use it at your own risk. Telenav and its licensors (and their licensors and suppliers) make no guarantees, representations or warranties of any kind, express or implied, arising by law or otherwise, including but not limited to, content, quality, accuracy, completeness, effectiveness, reliability, fitness for a particular purpose, usefulness, use or results to be obtained from this Data, or that the Data or server will be uninterrupted or error-free.

Disclaimer of Warranty: TELENAV AND ITS LICENSORS (INCLUDING THEIR LICENSORS AND SUPPLIERS) DISCLAIM ANY WARRANTIES, EXPRESS OR IMPLIED, OF QUALITY, PERFORMANCE, MERCHANTABILITY, FITNESS FOR A

Appendices

PARTICULAR PURPOSE OR NON-INFRINGEMENT. Some States, Territories and Countries do not allow certain warranty exclusions, so to that extent the above exclusion may not apply to you.

Disclaimer of Liability: TELENAV AND ITS LICENSORS (INCLUDING THEIR LICENSORS AND SUPPLIERS) SHALL NOT BE LIABLE TO YOU: IN RESPECT OF ANY CLAIM, DEMAND OR ACTION, IRRESPECTIVE OF THE NATURE OF THE CAUSE OF THE CLAIM, DEMAND OR ACTION ALLEGING ANY LOSS, INJURY OR DAMAGES, DIRECT OR INDIRECT, WHICH MAY RESULT FROM THE USE OR POSSESSION OF THE INFORMATION; OR FOR ANY LOSS OF PROFIT, REVENUE, CONTRACTS OR SAVINGS, OR ANY OTHER DIRECT, INDIRECT, INCIDENTAL, SPECIAL OR CONSEQUENTIAL DAMAGES ARISING OUT OF YOUR USE OF OR INABILITY TO USE THIS INFORMATION, ANY DEFECT IN THE INFORMATION, OR THE BREACH OF THESE TERMS OR CONDITIONS, WHETHER IN AN ACTION IN CONTRACT OR TORT OR BASED ON A WARRANTY, EVEN IF TELENAV OR ITS LICENSORS HAVE BEEN ADVISED OF THE POSSIBILITY OF SUCH DAMAGES. Some States, Territories and Countries do not allow certain liability exclusions or damages limitations, so to that extent the above may not apply to you.

Export Control. You shall not export from anywhere any part of the Data or any direct product thereof except in compliance with, and with all licenses and approvals required under, applicable export laws, rules and regulations, including but not limited to the laws, rules and regulations administered by the Office of Foreign Assets Control of the U.S. Department of Commerce and the Bureau of Industry and Security of the U.S. Department of Commerce. To the extent that any such

export laws, rules or regulations prohibit HERE from complying with any of its obligations hereunder to deliver or distribute Data, such failure shall be excused and shall not constitute a breach of this Agreement.

Entire Agreement. These terms and conditions constitute the entire agreement between Telenav (and its licensors, including their licensors and suppliers) and you pertaining to the subject matter hereof, and supersedes in their entirety any and all written or oral agreements previously existing between us with respect to such subject matter.

Governing Law. The above terms and conditions shall be governed by the laws of the State of Illinois [insert "Netherlands" where European HERE Data is used], without giving effect to (i) its conflict of laws provisions, or (ii) the United Nations Convention for Contracts for the International Sale of Goods, which is explicitly excluded. You agree to submit to the jurisdiction of the State of Illinois [insert "The Netherlands" where European HERE Data is used] for any and all disputes, claims and actions arising from or in connection with the Data provided to you hereunder.

Government End Users. If the Data is being acquired by or on behalf of the United States government or any other entity seeking or applying rights similar to those customarily claimed by the United States government, this Data is a "commercial item" as that term is defined at 48 C.F.R. ("FAR") 2.101, is licensed in accordance with these End-User Terms, and each copy of Data delivered or otherwise furnished shall be marked and embedded as appropriate with the following "Notice of Use," and shall be treated in accordance with such Notice:

Appendices

NOTICE OF USE

CONTRACTOR (MANUFACTURER/
SUPPLIER) NAME: HERE

CONTRACTOR (MANUFACTURER/
SUPPLIER) ADDRESS: c/o Nokia, 425
West Randolph Street, Chicago, Illinois
60606

This Data is a commercial item as
defined in FAR 2.101 and is subject to
these End-User Terms under which this
Data was provided.

© 1987 – 2014 HERE – All rights reserved.

If the Contracting Officer, federal government agency, or any federal official refuses to use the legend provided herein, the Contracting Officer, federal government agency, or any federal official must notify HERE prior to seeking additional or alternative rights in the Data.

I. US/Canada Territory

A. United States Data. The End-User Terms for any Application containing Data for the United States shall contain the following notices:

“HERE holds a non-exclusive license from the United States Postal Service® to publish and sell ZIP+4® information.”

“©United States Postal Service® 20XX. Prices are not established, controlled or approved by the United States Postal Service®. The following trademarks and registrations are owned by the USPS: United States Postal Service, USPS, and ZIP+4.”

B. Canada Data. The following provisions apply to the Data for Canada, which may include or reflect data from third party licensors (“Third Party Data”), including Her Majesty the Queen in Right of Canada (“Her Majesty”), Canada Post Corporation (“Canada Post”) and the Department of Natural Resources of Canada (“NRCan”):

1. Disclaimer and Limitation: Client agrees that its use of the Third Party Data is subject to the following provisions:

a. Disclaimer: The Third Party Data is licensed on an “as is” basis. The licensors of such data, including Her Majesty, Canada Post and NRCan, make no guarantees, representations or warranties respecting such data, either express or implied, arising by law or otherwise, including but not limited to, effectiveness, completeness, accuracy or fitness for a particular purpose.

b. Limitation on Liability: The Third Party Data licensors, including Her Majesty, Canada Post and NRCan, shall not be liable: (i) in respect of any claim, demand or action, irrespective of the nature of the cause of the claim, demand or action alleging any loss, injury or damages, direct or indirect, which may result from the use or possession of such Data; or (ii) in any way for loss of revenues or contracts, or any other consequential loss of any kind resulting from any defect in the Data.

Appendices

2. Copyright Notice: In connection with each copy of all or any portion of the Data for the Territory of Canada, Client shall affix in a conspicuous manner the following copyright notice on at least one of: (i) the label for the storage media of the copy; (ii) the packaging for the copy; or (iii) other materials packaged with the copy, such as user manuals or end user license agreements: "This data includes information taken with permission from Canadian authorities, including © Her Majesty the Queen in Right of Canada, © Queen's Printer for Ontario, © Canada Post Corporation, GeoBase®, © The Department of Natural Resources Canada. All rights reserved."

3. End-User Terms: Except as otherwise agreed by the parties, in connection with the provision of any portion of the Data for the Territory of Canada to End-Users as may be authorized under the Agreement, Client shall provide such End-Users, in a reasonably conspicuous manner, with terms (set forth with other end user terms required to be provided under the Agreement, or as otherwise may be provided, by Client) which shall include the following provisions on behalf of the Third Party Data licensors, including Her Majesty, Canada Post and NRCan:

The Data may include or reflect data of licensors, including Her Majesty the Queen in the Right of Canada ("Her Majesty"), Canada Post Corporation ("Canada Post") and the Department of Natural Resources Canada ("NRCan"). Such data is licensed on an "as is" basis. The licensors, including Her Majesty, Canada Post and NRCan, make no guarantees, representations or warranties respecting such data,

either express or implied, arising by law or otherwise, including but not limited to, effectiveness, completeness, accuracy or fitness for a particular purpose. The licensors, including Her Majesty, Canada Post and NRCan, shall not be liable in respect of any claim, demand or action, irrespective of the nature of the cause of the claim, demand or action alleging any loss, injury or damages, direct or indirect, which may result from the use or possession of the data or the Data. The licensors, including Her Majesty, Canada Post and NRCan, shall not be liable in any way for loss of revenues or contracts, or any other consequential loss of any kind resulting from any defect in the data or the Data.

End User shall indemnify and save harmless the licensors, including Her Majesty, Canada Post and NRCan, and their officers, employees and agents from and against any claim, demand or action, irrespective of the nature of the cause of the claim, demand or action, alleging loss, costs, expenses, damages or injuries (including injuries resulting in death) arising out of the use or possession of the data or the Data.

4. Additional Provisions: The terms contained in this Section are in addition to all of the rights and obligations of the parties under the Agreement. To the extent that any of the provisions of this Section are inconsistent with, or conflict with, any other provisions of the Agreement, the provisions of this Section shall prevail.

Appendices

II. Mexico. The following provision applies to the Data for Mexico, which includes certain data from the Instituto Nacional de Estadística y Geografía (“INEGI”):

A. Any and all copies of the Data and/or packaging containing Data for Mexico shall contain the following notice: “Fuente: INEGI (Instituto Nacional de Estadística y Geografía)”

III. Latin America Territory

A. Third Party Notices. Any and all copies of the Data and/or packaging relating thereto shall include the respective Third Party Notices set forth below and used as described below corresponding to the Territory (or portion thereof) included in such copy:

Territory Notice

Argentina	IGN “INSTITUTO GEOGRAFICO NACIONAL ARGENTINO”
Ecuador	“INSTITUTO GEOGRAFICO MILITAR DEL ECUADOR AUTORIZACION N° IGM-2011-01- PCO-01 DEL 25 DE ENERO DE 2011” “source: © IGN 2009 - BD TOPO ®”
Guadeloupe, French Guiana and Martinique Mexico	“Fuente: INEGI (Instituto Nacional de Estadística y Geografía)”

IV. Middle East Territory

A. Third Party Notices. Any and all copies of the Data and/or packaging relating thereto shall include the respective Third Party Notices set forth below and used as described below corresponding to the Territory (or portion thereof) included in such copy:

Country Notice

Jordan “© Royal Jordanian Geographic Centre”. The foregoing notice requirement for Jordan Data is a material term of the Agreement. If Client or any of its permitted sublicensees (if any) fail to meet such requirement, HERE shall have the right to terminate Client’s license with respect to the Jordan Data.

B. Jordan Data. Client and its permitted sublicensees (if any) are restricted from licensing and/or otherwise distributing HERE’s database for the country of Jordan (“Jordan Data”) for use in Enterprise Applications to (i) non-Jordanian entities for use of the Jordan Data solely in Jordan or (ii) Jordan-based customers. In addition, Client, its permitted sublicensees (if any) and End-Users are restricted from using the Jordan Data in Enterprise Applications if such party is (i) a non-Jordanian entity using the Jordan Data solely in Jordan or (ii) a Jordan-based customer. For purposes of the foregoing, “Enterprise Applications” shall mean Geomarketing applications, GIS applications, mobile business asset management applications, call center applications, telematics applications, public organization Internet applications or for providing geocoding services.

Appendices

V. Europe Territory

A. Use of Certain Traffic Codes in Europe

1. General Restrictions Applicable to Traffic Codes. Client acknowledges and agrees that in certain countries of the Europe Territory, Client will need to obtain rights directly from third party RDS-TMC code providers to receive and use the Traffic Codes in the Data and to deliver to End-Users Transactions in any way derived from or based on such Traffic Codes. For such countries, HERE shall deliver the Data incorporating Traffic Codes to Client only after receiving certification from Client of its having obtained such rights.

2. Display of Third Party Rights Legends for Belgium. Client shall, for each Transaction that uses Traffic Codes for Belgium, provide the following notice to the End-User: "Traffic Codes for Belgium are provided by the Ministerie van de Vlaamse Gemeenschap and the Ministère de l'Équipement et des Transports."

B. Paper Maps. With respect to any license granted to Client relating to making, selling or distributing paper maps (i.e., a map fixed on a paper or paper-like medium): (a) such license with respect to Data for the Territory of Great Britain is conditioned on Client's entering into and complying with a separate written agreement with the Ordnance Survey ("OS") to create and sell paper maps, Client's paying to the OS any and all applicable paper map royalties, and Client's complying with the OS copyright notice requirements; (b) such license for selling or otherwise distributing for charge with respect to Data for the Territory of Czech Republic

is conditioned on Client's obtaining prior written consent from Kartografie a.s.; (c) such license for selling or distributing with respect to Data for the Territory of Switzerland is conditioned on Client's obtaining a permit from Bundesamt für Landestopografie of Switzerland; (d) Client is restricted from using Data for the Territory of France to create paper maps with a scale between 1:5,000 and 1:250,000; and (e) Client is restricted from using any Data to create, sell or distribute paper maps that are the same or substantially similar, in terms of data content and specific use of color, symbols and scale, to paper maps published by the European national mapping agencies, including without limitation, Landvermessungämter of Germany, Topografische Dienst of the Netherlands, Nationaal Geografisch Instituut of Belgium, Bundesamt für Landestopografie of Switzerland, Bundesamt für Eich-und Vermessungswesen of Austria, and the National Land Survey of Sweden.

C. OS Enforcement. Without limiting Section IV(B) above, with respect to Data for the Territory of Great Britain, Client acknowledges and agrees that the Ordnance Survey ("OS") may bring a direct action against Client to enforce compliance with the OS copyright notice (see Section IV(D) below) and paper map requirements (see Section IV(B) above) contained in this Agreement.

D. Third Party Notices. Any and all copies of the Data and/or packaging relating thereto shall include the respective Third Party Notices set forth below and used as described below corresponding to the Territory (or portion thereof) included in such copy:

Country(ies) Notice

Appendices

Austria	“© Bundesamt für Eich- und Vermessungswesen”	Spain	“Información geográfica propiedad del CNIG”
Croatia Cyprus, Estonia, Latvia, Lithuania, Moldova, Poland, Slovenia and/or Ukraine	“© EuroGeographics”	Sweden	“Based upon electronic data © National Land Survey Sweden.”
France	“source: © IGN 2009 – BD TOPO ®”	Switzerland	“Topografische Grundlage: © Bundesamt für Landestopographie.
Germany	“Die Grundlagendaten wurden mit Genehmigung der zuständigen Behörden entnommen”	E. Respective Country Distribution. Client acknowledges that HERE has not received approvals to distribute map data for the following countries in such respective countries: Albania, Belarus, Kyrgyzstan, Moldova and Uzbekistan. HERE may update such list from time to time. The license rights granted to Client under this TL with respect to the Data for such countries are contingent upon Client’s compliance with all applicable laws and regulations, including, without limitation, any required licenses or approvals to distribute the Application incorporating such Data in such respective countries.	
Great Britain	“Contains Ordnance Survey data © Crown copyright and database right 2010 Contains Royal Mail data © Royal Mail copyright and database right 2010”	VI. Australia Territory	
Greece	“Copyright Geomatics Ltd.”	A. Third Party Notices. Any and all copies of the Data and/or packaging relating thereto shall include the respective Third Party Notices set forth below and used as described below corresponding to the Territory (or portion thereof) included in such copy:	
Hungary	“Copyright © 2003; Top-Map Ltd.”	Copyright. Based on data provided under license from PSMA Australia Limited (www.pasma.com.au).	
Italy	“La Banca Dati Italiana è stata prodotta usando quale riferimento anche cartografia numerica ed al tratto prodotta e fornita dalla Regione Toscana.”		
Norway	“Copyright © 2000; Norwegian Mapping Authority”		
Portugal	“Source: IgeoE – Portugal”		

Appendices

Product incorporates data which is © 20XX Telstra Corporation Limited, GM Holden Limited, Intelomatics Australia Pty Ltd and Continental Pty Ltd.

B. Third Party Notices for Australia. In addition to the foregoing, the End-User Terms for any Application containing RDS-TMC Traffic Codes for Australia shall contain the following notice: “Product incorporates traffic location codes which is © 20XX Telstra Corporation Limited and its licensors.”

AT&T Vehicle Network Carrier Telematics Disclosure

END USER FOR PURPOSES OF THIS SECTION MEANS YOU AND YOUR HEIRS, EXECUTORS, LEGAL PERSONAL REPRESENTATIVES AND PERMITTED ASSIGNS. FOR PURPOSES OF THIS SECTION “UNDERLYING WIRELESS SERVICE CARRIER” INCLUDES ITS AFFILIATES AND CONTRACTORS AND THEIR RESPECTIVE OFFICERS, DIRECTORS, EMPLOYEES, SUCCESSORS AND ASSIGNS. END USER HAS NO CONTRACTUAL RELATIONSHIP WITH THE UNDERLYING WIRELESS SERVICE CARRIER AND END USER IS NOT A THIRD PARTY BENEFICIARY OF ANY AGREEMENT BETWEEN FORD AND UNDERLYING CARRIER. END USER UNDERSTANDS AND AGREES THAT THE UNDERLYING CARRIER HAS NO LEGAL, EQUITABLE, OR OTHER LIABILITY OF ANY KIND TO END USER. IN ANY EVENT, REGARDLESS OF THE FORM OF THE ACTION, WHETHER FOR BREACH OF CONTRACT, WARRANTY, NEGLIGENCE, STRICT LIABILITY IN TORT OR OTHERWISE, END USER’S EXCLUSIVE REMEDY FOR CLAIMS ARISING IN ANY WAY IN CONNECTION WITH THIS AGREEMENT, FOR ANY CAUSE WHATSOEVER, INCLUDING BUT NOT LIMITED TO ANY FAILURE OR

DISRUPTION OF SERVICE PROVIDED HEREUNDER, IS LIMITED TO PAYMENT OF DAMAGES IN AN AMOUNT NOT TO EXCEED THE AMOUNT PAID BY END USER FOR THE SERVICES DURING THE TWO-MONTH PERIOD PRECEDING THE DATE THE CLAIM AROSE.

(ii) END USER AGREES TO INDEMNIFY AND HOLD HARMLESS THE UNDERLYING WIRELESS SERVICE CARRIER AND ITS OFFICERS, EMPLOYEES, AND AGENTS AGAINST ANY AND ALL CLAIMS, INCLUDING WITHOUT LIMITATION CLAIMS FOR LIBEL, SLANDER, OR ANY PROPERTY DAMAGE, PERSONAL INJURY OR DEATH, ARISING IN ANY WAY, DIRECTLY OR INDIRECTLY, IN CONNECTION WITH THIS AGREEMENT OR THE USE, FAILURE TO USE, OR INABILITY TO USE THE DEVICE EXCEPT WHERE THE CLAIMS RESULT FROM THE UNDERLYING CARRIER’S GROSS NEGLIGENCE OR WILLFUL MISCONDUCT. THIS INDEMNITY WILL SURVIVE THE TERMINATION OF THE AGREEMENT.

(iii) END USER HAS NO PROPERTY RIGHT IN ANY NUMBER ASSIGNED TO THE DEVICE.

(iv) END USER UNDERSTANDS THAT FORD AND THE UNDERLYING CARRIER CANNOT GUARANTEE THE SECURITY OF WIRELESS TRANSMISSIONS, AND WILL NOT BE LIABLE FOR ANY LACK OF SECURITY RELATING TO THE USE OF THE SERVICES

THE SERVICE IS FOR [END USER’S] USE ONLY AND END USER MAY NOT RESELL THE SERVICE TO ANY OTHER PARTY. END USER UNDERSTANDS THAT THE UNDERLYING CARRIER DOES NOT GUARANTEE ANY END USER UNINTERRUPTED SERVICE OR COVERAGE. THE UNDERLYING CARRIER DOES NOT WARRANT THAT END USERS CAN OR WILL BE LOCATED USING THE SERVICE. THE UNDERLYING CARRIER

Appendices

MAKES NO WARRANTY, EXPRESS OR IMPLIED, OF MERCHANTABILITY OR FITNESS FOR A PARTICULAR PURPOSE, SUITABILITY, OR PERFORMANCE REGARDING ANY SERVICES OR GOODS, AND IN NO EVENT SHALL AT&T BE LIABLE, WHETHER OR NOT DUE TO ITS OWN NEGLIGENCE, FOR ANY: (A) ACT OR OMISSION OF A THIRD PARTY; (B) MISTAKES, OMISSIONS, INTERRUPTIONS, ERRORS, FAILURES TO TRANSMIT, DELAYS, OR DEFECTS IN THE SERVICE PROVIDED BY OR THROUGH THE UNDERLYING CARRIER; (C) DAMAGE OR INJURY CAUSED BY SUSPENSION OR TERMINATION BY THE UNDERLYING CARRIER; OR (D) DAMAGE OR INJURY CAUSED BY A FAILURE OR DELAY IN CONNECTING A CALL TO ANY ENTITY, INCLUDING 911 OR ANY OTHER EMERGENCY SERVICE. TO THE FULL EXTENT ALLOWED BY LAW, THE END USER RELEASES, INDEMNIFIES AND HOLDS THE UNDERLYING CARRIER HARMLESS FROM AND AGAINST ANY AND ALL CLAIMS OF ANY PERSON OR ENTITY FOR DAMAGES OF ANY NATURE ARISING IN ANY WAY FROM OR RELATING TO, DIRECTLY OR INDIRECTLY, SERVICES PROVIDED BY THE UNDERLYING CARRIER OR ANY PERSON'S USE THEREOF, INCLUDING CLAIMS ARISING IN WHOLE OR IN PART FROM THE ALLEGED NEGLIGENCE OF THE UNDERLYING CARRIER.

VII. China Territory

Personal Use Only

You agree to use this Data together with [insert name of Client Application] for the solely personal, non-commercial purposes for which you were licensed, and not for service bureau, time-sharing or other similar purposes. Accordingly, but subject to the restrictions set forth in the following paragraphs, you may copy this Data only as necessary for your personal use to (i)

view it, and (ii) save it, provided that you do not remove any copyright notices that appear and do not modify the Data in any way. You agree not to otherwise reproduce, copy, modify, decompile, disassemble or reverse engineer any portion of this Data, and may not transfer or distribute it in any form, for any purpose, except to the extent permitted by mandatory laws.

Restrictions

Except where you have been specifically licensed to do so by NAV2, and without limiting the preceding paragraph, you may not (a) use this Data with any products, systems, or applications installed or otherwise connected to or in communication with vehicles, capable of vehicle navigation, positioning, dispatch, real time route guidance, fleet management or similar applications; or (b) with or in communication with any positioning devices or any mobile or wireless-connected electronic or computer devices, including without limitation cellular phones, palmtop and handheld computers, pagers, and personal digital assistants or PDAs. You agree to cease using this Data if you fail to comply with these terms and conditions.

Limited Warranty

NAV2 warrants that (a) the Data will perform substantially in accordance with the accompanying written materials for a period of ninety (90) days from the date of receipt, and (b) any support services provided by NAV2 shall be substantially as described in applicable written materials provided to you by NAV2, and NAV2's support engineers will make commercially reasonable efforts to solve any problem issues.

Appendices

Customer Remedies

NAV2 and its suppliers' entire liability and your exclusive remedy shall be, at NAV2's sole discretion, either (a) return of the price paid, if any, or (b) repair or replacement of the Data that do not meet NAV2's Limited Warranty and that are returned to NAV2 with a copy of your receipt. This Limited Warranty is void if failure of the Data has resulted from accident, abuse, or misapplication. Any replacement Data will be warranted for the remainder of the original warranty period or thirty (30) days, whichever is longer. Neither these remedies nor any product support services offered by NAV2 are available without proof of purchase from an authorized international source.

No Other Warranty:

EXCEPT FOR THE LIMITED WARRANTY SET FORTH ABOVE AND TO THE EXTENT PERMITTED BY APPLICABLE LAW, NAV2 AND ITS LICENSORS (INCLUDING THEIR LICENSORS AND SUPPLIERS) DISCLAIM ANY WARRANTIES, EXPRESS OR IMPLIED, OF QUALITY, PERFORMANCE, MERCHANTABILITY, FITNESS FOR A PARTICULAR PURPOSE, OWNERSHIP OR NON-INFRINGEMENT. Certain warranty exclusions may not be permitted under applicable law, so to that extent the above exclusion may not apply to you.

Limited Liability:

TO THE EXTENT PERMITTED BY APPLICABLE LAW, NAV2 AND ITS LICENSORS (INCLUDING THEIR LICENSORS AND SUPPLIERS) SHALL NOT BE LIABLE TO YOU: IN RESPECT OF ANY CLAIM, DEMAND OR ACTION, IRRESPECTIVE OF THE NATURE OF THE CAUSE OF THE CLAIM, DEMAND OR ACTION ALLEGING ANY LOSS, INJURY OR DAMAGES, DIRECT OR INDIRECT, WHICH MAY RESULT FROM THE USE OR POSSESSION OF THE INFORMATION; OR

FOR ANY LOSS OF PROFIT, REVENUE, CONTRACTS OR SAVINGS, OR ANY OTHER DIRECT, INDIRECT, INCIDENTAL, SPECIAL OR CONSEQUENTIAL DAMAGES ARISING OUT OF YOUR USE OF OR INABILITY TO USE THIS INFORMATION, ANY DEFECT IN THE INFORMATION, OR THE BREACH OF THESE TERMS OR CONDITIONS, WHETHER IN AN ACTION IN CONTRACT OR TORT OR BASED ON A WARRANTY, EVEN IF NAV2 OR ITS LICENSORS HAVE BEEN ADVISED OF THE POSSIBILITY OF SUCH DAMAGES. UNDER NO CIRCUMSTANCES SHALL NAV2'S OR ITS SUPPLIERS' LIABILITY HEREUNDER EXCEED THE PRICE PAID. Certain liability exclusions may not be permitted under applicable law, so to that extent the above exclusion may not apply to you.

Export Control

You agree not to export to anywhere any part of the Data provided to you or any direct product thereof except in compliance with, and with all licenses and approvals required under, applicable export laws, rules and regulations.

IP Protection

The Data are owned by NAV2 or its suppliers and are protected by applicable copyright and other intellectual property law and treaties. The Data are provided solely on the basis of a license to use, not sale.

Entire Agreement

These terms and conditions constitute the entire agreement between NAV2 (and its licensors, including their licensors and suppliers) and you pertaining to the subject matter hereof, and supersedes in their entirety any and all written or oral agreements previously existing between us with respect to such subject matter.

Appendices

Governing Law.

The above terms and conditions shall be governed by the laws of the People's Republic of China, without giving effect to (i) its conflict of laws provisions, or (ii) the United Nations Convention for Contracts for the International Sale of Goods, which is explicitly excluded. Any dispute arising from or in connection with the Data provided to you hereunder shall be submitted to the Shanghai International Economic and Trade Arbitration Commission for arbitration.

Gracenote® Copyright

CD and music-related data from Gracenote, Inc., copyright©

2000-2007 Gracenote. Gracenote Software, copyright © 2000-2007 Gracenote. This product and service may practice one or more of the following U.S. Patents 5,987,525; 6,061,680; 6,154,773; 6,161,132; 6,230,192; 6,230,207; 6,240,459; 6,330,593 and other patents issued or pending. Some services supplied under license from Open Globe, Inc. for U.S. Patent 6,304,523.

Gracenote and CDDb are registered trademarks of Gracenote. The Gracenote logo and logotype, and the "Powered by Gracenote™" logo are trademarks of Gracenote.

Gracenote® End User License Agreement (EULA)

This device contains software from Gracenote, Inc. of 2000 Powell Street Emeryville, California 94608 ("Gracenote").

The software from Gracenote (the "Gracenote Software") enables this device to do disc and music file identification and obtain music-related information, including name, artist, track, and title information ("Gracenote Data") from online servers

("Gracenote Servers"), and to perform other functions. You may use Gracenote Data only by means of the intended End User functions of this device. This device may contain content belonging to Gracenote's providers. If so, all of the restrictions set forth herein with respect to Gracenote Data shall also apply to such content and such content providers shall be entitled to all of the benefits and protections set forth herein that are available to Gracenote. You agree that you will use the content from Gracenote ("Gracenote Content"), Gracenote Data, the Gracenote Software, and Gracenote Servers for your own personal, non-commercial use only. You agree not to assign, copy, transfer or transmit the Gracenote Content, Gracenote Software or any Gracenote Data (except in a Tag associated with a music file) to any third party. YOU AGREE NOT TO USE OR EXPLOIT GRACENOTE CONTENT, GRACENOTE DATA, THE GRACENOTE SOFTWARE, OR GRACENOTE SERVERS, EXCEPT AS EXPRESSLY PERMITTED HEREIN.

You agree that your non-exclusive licenses to use the Gracenote Content, Gracenote Data, the Gracenote Software, and Gracenote Servers will terminate if you violate these restrictions. If your licenses terminate, you agree to cease any and all use of the Gracenote Content, Gracenote Data, the Gracenote Software, and Gracenote Servers.

Gracenote, respectively, reserve all rights in Gracenote Data, the Gracenote Software, and the Gracenote Servers and Gracenote Content, including all ownership rights. Under no circumstances will either Gracenote become liable for any payment to you for any information that you provide,

Appendices

including any copyrighted material or music file information. You agree that Gracenote may enforce its respective rights, collectively or separately, under this agreement against you, directly in each company's own name.

Gracenote uses a unique identifier to track queries for statistical purposes. The purpose of a randomly assigned numeric identifier is to allow Gracenote to count queries without knowing anything about who you are. For more information, see the web page at www.gracenote.com for the Gracenote Privacy Policy.

THE GRACENOTE SOFTWARE, EACH ITEM OF GRACENOTE DATA AND THE GRACENOTE CONTENT ARE LICENSED TO YOU "AS IS". NEITHER GRACENOTE MAKES ANY REPRESENTATIONS OR WARRANTIES, EXPRESS OR IMPLIED, REGARDING THE ACCURACY OF ANY GRACENOTE DATA FROM THE GRACENOTE SERVERS OR GRACENOTE CONTENT. GRACENOTE COLLECTIVELY AND SEPARATELY RESERVE THE RIGHT TO DELETE DATA AND/OR CONTENT FROM THE COMPANIES' RESPECTIVE SERVERS OR, IN THE CASE OF GRACENOTE, CHANGE DATA CATEGORIES FOR ANY CAUSE THAT GRACENOTE DEEMS SUFFICIENT. NO WARRANTY IS MADE THAT EITHER GRACENOTE CONTENT OR THE GRACENOTE SOFTWARE OR GRACENOTE SERVERS ARE ERROR-FREE OR THAT THE FUNCTIONING OF THE GRACENOTE SOFTWARE OR GRACENOTE SERVERS WILL BE UNINTERRUPTED. GRACENOTE IS NOT OBLIGATED TO PROVIDE YOU WITH ANY ENHANCED OR ADDITIONAL DATA TYPES THAT GRACENOTE MAY CHOOSE TO PROVIDE IN THE FUTURE AND IS FREE TO DISCONTINUE ITS ONLINE SERVICES AT ANY TIME. GRACENOTE DISCLAIM ALL WARRANTIES EXPRESS OR IMPLIED, INCLUDING, BUT NOT LIMITED TO,

IMPLIED WARRANTIES OF MERCHANTABILITY, FITNESS FOR A PARTICULAR PURPOSE, TITLE, AND NON-INFRINGEMENT. NEITHER GRACENOTE WARRANTS THE RESULTS THAT WILL BE OBTAINED BY YOUR USE OF THE GRACENOTE SOFTWARE OR ANY GRACENOTE SERVER. IN NO CASE WILL GRACENOTE BE LIABLE FOR ANY CONSEQUENTIAL OR INCIDENTAL DAMAGES OR FOR ANY LOST PROFITS OR LOST REVENUES FOR ANY REASON WHATSOEVER. © Gracenote 2007.

Radio Frequency Statement

FCC ID: ACJ-SYNCG3-L

IC: 216B-SYNCG3-L

This device complies with Part 15 of the FCC Rules and with RSS-210 of Industry Canada. Operation is subject to the following two conditions:

- (1)** This device may not cause harmful interference, and
- (2)** this device must accept any interference received, including interference that may cause undesired operation.



WARNING: Changes or modifications not expressly approved by the party responsible for compliance could void the user's authority to operate the equipment. The term "IC:" before the radio certification number only signifies that Industry Canada technical specifications were met.

The antenna used for this transmitter must not be co-located or operating in conjunction with any other antenna or transmitter.

Appendices

Taiwan Territory

According to the "Technical Specifications for Low Power Radio Frequency Equipment" formulated by the National Communications and Communication Committee of the Executive Yuan: 3.8.2. For the low-power radio frequency equipment that has obtained the verification certificate, the company, firm or user shall not change the frequency, increase the power or change the characteristics and functions of the original design without authorization.

The use of low-power radio frequency equipment must not affect flight safety and interfere with legal communications: when the system detects interference, immediately stop using it until there is no interference.

The aforementioned legal communication refers to the wireless communication operated in accordance with the provisions of the Telecommunications Management Law. Low-power radio frequency equipment needs to endure the interference of legal communication or industrial, scientific and medical radio wave radiation electrical equipment.

SUNA TRAFFIC CHANNEL – TERMS AND CONDITIONS

By activating, using and/or accessing the SUNA Traffic Channel, SUNA Predictive or other content or material provided by Intelomatics (together, **SUNA Products and/or Services**), you must accept certain terms and conditions. The following is a brief summary of the terms and conditions that apply to you. To view the full terms and conditions relevant to your use of the SUNA Products and/or Services, please consult:

Website
www.sunatrafic.com.au/termsandconditions/

1. Acceptance

By using SUNA Products and/or Services, you will be deemed to have accepted and agreed to be bound by the terms and conditions fully detailed at:

Website
www.sunatrafic.com.au/termsandconditions/

2. Intellectual Property

SUNA Products and/or Services are for your personal use. You may not record, or retransmit the content, nor use the content in association with any other traffic information or route guidance service or device not approved by Intelomatics. You obtain no right of ownership in any Intellectual Property Rights (including copyright) in the data that is used to provide SUNA Products and/or Services.

3. Appropriate Use

SUNA Products and/or Services are intended as an aid to personal motoring and travel planning, and do not provide comprehensive or accurate information on all occasions. On occasions, you may experience additional delay as a result of using SUNA Products and/or Services. You acknowledge that it is not intended, or suitable, for use in applications where time of arrival or driving directions may impact the safety of the public or yourself.

4. Use of SUNA Products and Services while driving

Appendices

You, and other authorised drivers of the vehicle in which SUNA Products and/or Services are available or installed and active, remain at all times responsible for observing all relevant laws and codes of safe driving. In particular, you agree to only actively operate SUNA Products and/or Services when the Vehicle is at a complete stop and it is safe to do so.

5. Service Continuity and Reception of the SUNA Traffic Channel

We will use reasonable endeavours to provide the SUNA Traffic Channel 24 hours a day, 365 days a year. The SUNA Traffic Channel may occasionally be unavailable for technical reasons or for planned maintenance. We will try to perform maintenance at times when congestion is light. We reserve the right to withdraw SUNA Products and/or Services at any time.

Also, we cannot assure the uninterrupted reception of the SUNA Traffic Channel RDS-TMC signal at any particular location.

6. Limitation of Liability

Neither Intelematics (nor its suppliers or the manufacturer of your device (the “**Suppliers**”)) shall be liable to you or to any third party for any damages either direct, indirect, incidental, consequential or otherwise arising out of the use of or inability to use SUNA Products and/or Services even if Intelematics or a Supplier has been advised of the possibility of such damages. You also acknowledge that the neither Intelematics nor any Supplier guarantees nor make any warranties that relate to the availability, accuracy or completeness of SUNA Products and/or Services, and to the extent which it is lawful to do so, both Intelematics and each Supplier excludes any warranties which might otherwise be implied by any State or Federal legislation in relation to SUNA Products and/or Services.

7. Please Note

Great care has been taken in preparing this manual. Constant product development may mean that some information is not entirely up-to-date. The information in this document is subject to change without notice.

DECLARATION OF CONFORMITY

Your vehicle could have components that transmit and receive radio waves and are therefore subject to government regulation.

These components must accept any interference received, including interference that could cause undesired operation. For certification labels and declarations of conformity, visit www.wirelessconformity.ford.com.

TYPE APPROVALS

Radio Frequency Certifications for Tire Pressure Monitoring Sensor(s)

Canada

IC: 850K-11545917

IC: 2546A-FP3

United States of America

FCC ID: OUC11545917

FCC ID: MRXFP3

Appendices

Radio Frequency Certifications for Sync 2.5

Canada

IC: 12339A-CTR

This device complies with Part 15 of the FCC Rules and with industry Canada's license-exempt RSSs. Operation is subject to the following two conditions: (1) This device may not cause harmful interference, and (2) This device must accept any interference received, including interference that may cause undesired operation.

Cet appareil est conforme aux CNR D d'Industrie Canada applicables aux appareils radio exempts de licence. L'exploitation est autorisée à condition que l'appareil ne produise pas de brouillage préjudiciable et qu'il accepte tout brouillage, même celui susceptible d'en compromettre le fonctionnement.

United States of America

FCC ID: 2ACRLCTR

This device complies with Part 15 of the FCC Rules and with industry Canada's license-exempt RSSs. Operation is subject to the following two conditions: (1) This device may not cause harmful interference, and (2) This device must accept any interference received, including interference that may cause undesired operation.

Cet appareil est conforme aux CNR D d'Industrie Canada applicables aux appareils radio exempts de licence. L'exploitation est autorisée à condition que l'appareil ne produise pas de brouillage préjudiciable et qu'il accepte tout brouillage, même celui susceptible d'en compromettre le fonctionnement.

Radio Frequency Certifications for Passive Anti-Theft System

Canada

IC: 850K-11545917

United States of America

FCC ID: OUC11545917

Radio Frequency Certifications for Radio Transceiver Module

Canada

IC: 3659A-F03AM315RX

IC: 3659A-F04AM902TRX

This device complies with Part 15 of the FCC Rules and with Industry Canada's license-exempt RSSs. Operation is subject to the following two conditions: (1) This device may not cause harmful interference, and (2) This device must accept any interference received, including interference that may cause undesired operation.

Cet appareil est conforme aux CNR d'Industrie Canada applicables aux appareils radio exempts de licence. L'exploitation est autorisée à condition que l'appareil ne produise pas de brouillage préjudiciable et qu'il accepte tout brouillage, même celui susceptible d'en compromettre le fonctionnement.

Appendices

United States of America

FCC ID : LTQF03AM315RX,
FCC ID : L2C0062TR

This device complies with Part 15 of the FCC Rules and with industry Canada's license- exempt RSSs. Operation is subject to the following two conditions: (1) This device may not cause harmful interference, and (2) This device must accept any interference received, including interference that may cause undesired operation.

Cet appareil est conforme aux CNR D d'Industrie Canada applicables aux appareils radio exempts de licence. L'exploitation est autorisée à condition que l'appareil ne produise pas de brouillage préjudiciable et qu'il accepte tout brouillage, même celui susceptible d'en compromettre le fonctionnement.

Radio Frequency Certifications for Telematic Control Unit

Canada

IC -2807E-BL28NA003
IC -2807E-FB40ND1

This device complies with Part 15 of the FCC Rules and with industry Canada's license- exempt RSSs. Operation is subject to the following two conditions: (1) This device may not cause harmful interference, and (2) This device must accept any interference received, including interference that may cause undesired operation.

Cet appareil est conforme aux CNR D d'Industrie Canada applicables aux appareils radio exempts de licence. L'exploitation est autorisée à condition que l'appareil ne produise pas de brouillage préjudiciable et qu'il accepte tout brouillage, même celui susceptible d'en compromettre le fonctionnement.

Radio Frequency Certifications for Blind Spot Information System

Canada

RSS-310 compliant, per FCC Test report no.: 1-8707/14-01-03

IC : 4135A - SRR3B compliant, per FCC Test report no.: 1-8707/14-01-03

United States of America

FCC ID: OAYSRR3B

United States of America

FCC- LHJ-BL28NA003
FCC- LHJ-FB40ND1

This device complies with Part 15 of the FCC Rules and with industry Canada's license- exempt RSSs. Operation is subject to the following two conditions: (1) This device may not cause harmful interference, and (2) This device must accept any interference received, including interference that may cause undesired operation.

Cet appareil est conforme aux CNR D d'Industrie Canada applicables aux appareils radio exempts de licence. L'exploitation est autorisée à condition que l'appareil ne produise pas de brouillage préjudiciable et qu'il accepte tout brouillage, même celui susceptible d'en compromettre le fonctionnement.

Appendices

Radio Frequency Certifications for SYNC 3

Canada

IC ID: 216B-FG185SG32MH

This device complies with Part 15 of the FCC Rules and with industry Canada's license-exempt RSSs. Operation is subject to the following two conditions: (1) This device may not cause harmful interference, and (2) This device must accept any interference received, including interference that may cause undesired operation.

Cet appareil est conforme aux CNR D d'Industrie Canada applicables aux appareils radio exempts de licence. L'exploitation est autorisée à condition que l'appareil ne produise pas de brouillage préjudiciable et qu'il accepte tout brouillage, même celui susceptible d'en compromettre le fonctionnement.

United States of America

FCC ID: ACJ-FG-185-SG32MH

This device complies with Part 15 of the FCC Rules and with industry Canada's license-exempt RSSs. Operation is subject to the following two conditions: (1) This device may not cause harmful interference, and (2) This device must accept any interference received, including interference that may cause undesired operation.

Cet appareil est conforme aux CNR D d'Industrie Canada applicables aux appareils radio exempts de licence. L'exploitation est autorisée à condition que l'appareil ne produise pas de brouillage préjudiciable et qu'il accepte tout brouillage, même celui susceptible d'en compromettre le fonctionnement.

Radio Frequency Certifications for Cruise Control Module

Canada

IC: 3432A-0065TR

United States of America

FCC ID: L2C0065TR

Radio Frequency Certifications for Body Control Module

Canada

IC: 7812A-A2C738448

Model # : M : A2C750526

Model # : M : A2C750561

United States of America

FCC ID: M3NA2C738448

Model # : M : A2C750526

Model # : M : A2C750561

Radio Frequency Certification for Keys and Remote Controls

Canada

IC : 7812A-A2C931423

IC : 7812A-A2C931426

IC : 3248A-A08TAA

IC : 3248A-A08TDA

United States of America

FCC ID : M3N-A2C931423

FCC ID : M3N-A2C931426

FCC ID : N5F-A08TAA

FCC ID : N5F-A08TDA

Appendices

Radio Frequency Statement for Audio Unit

Canada

IC: 3043A-UP375AHU

This device complies with Part 15 of the FCC Rules and with industry Canada's license- exempt RSSs. Operation is subject to the following two conditions: (1) This device may not cause harmful interference, and (2) This device must accept any interference received, including interference that may cause undesired operation.

Cet appareil est conforme aux CNR D d'Industrie Canada applicables aux appareils radio exempts de licence. L'exploitation est autorisée à condition que l'appareil ne produise pas de brouillage préjudiciable et qu'il accepte toute brouillage, même celui susceptible d'en compromettre le fonctionnement.

United States

FCC ID: NT8-16UP375AHU
FCC ID - FS180823N001

This device complies with Part 15 of the FCC Rules and with Industry Canada's license- exempt RSSs. Operation is subject to the following two conditions: (1) This device may not cause harmful interference, and (2) This device must accept any interference received, including interference that may cause undesired operation.

Cet appareil est conforme aux CNR d'Industrie Canada applicables aux appareils radio exempts de licence. L'exploitation est autorisée à condition que l'appareil ne produise pas de brouillage préjudiciable et qu'il accepte tout brouillage, même celui susceptible d'en compromettre le fonctionnement.

Index

4

- 4WD
See: Four-Wheel Drive.....165

9

- 911 Assist.....50

A

- A/C
See: Climate Control.....117
- About This Manual.....7
- ABS
See: Brakes.....175
- ABS driving hints
See: Hints on Driving With Anti-Lock
Brakes.....175
- Accessories.....408
- Accessories
See: Replacement Parts
Recommendation.....10
- ACC
See: Using Adaptive Cruise Control.....193
- Adjusting the Headlamps.....278
- Adjusting the Steering Wheel.....72
- Airbag Disposal.....49
- Air Conditioning
See: Climate Control.....117
- Air Filter
See: Changing the Engine Air Filter.....267
- Alarm
See: Anti-Theft Alarm.....70
- Ambient Lighting.....82
- Anti-Theft Alarm.....70
- Appendices.....428
- Apps.....392
- At a Glance.....18
- Audible Warnings and Indicators.....95
- Audio Control.....72
- Audio Input Jack.....353
- Audio System.....343
General Information.....343
- Audio Unit - Vehicles With: SYNC
3.....347
- Audio Unit - Vehicles With: SYNC.....345

- Audio Unit - Vehicles Without:
SYNC.....343
- Autolamps.....78
- Automatic Climate Control.....118
- Automatic Crash Shutoff.....241
Automatic Crash Shutoff
Precautions.....241
Re-Enabling Your Vehicle.....241
What Is Automatic Crash Shutoff.....241
- Automatic High Beam Control.....79
- Automatic Transmission.....161
- Automatic Transmission Fluid
Check.....273
- Auto-Start-Stop.....148
- Autowipers.....75
- Auxiliary Power Points.....138
- Auxiliary Switches.....409

B

- Battery
See: Changing the 12V Battery.....275
- Battery Charging
See: Changing the 12V Battery.....274
- Blind Spot Information System.....206
- BLIS
See: Blind Spot Information System.....206
- Bonnet Lock
See: Opening and Closing the Hood.....264
- Booster Seats.....29
- Brake Fluid Check.....273
- Brakes.....175
General Information.....175
- Breaking-In.....231
- Bulb Specification Chart.....335

C

- Cabin Air Filter.....122
- Canceling the Set Speed.....184
- Capacities and Specifications.....329
- Cargo Lamps.....82
- Car Wash
See: Cleaning the Exterior.....285
- Catalytic Converter.....158
- Center Console.....140
- Changing a Bulb.....279
- Changing a Fuse.....261

Index

Changing a Road Wheel.....	313
Changing the 12V Battery.....	275
Changing the Engine Air Filter.....	267
Changing the Vehicle Wi-Fi Hotspot Name or Password.....	342
Changing the Wiper Blades.....	277
Charging the 12V Battery.....	274
Checking MyKey System Status.....	61
Checking the Wiper Blades.....	277
Child Restraint and Seatbelt Maintenance.....	39
Child Restraint Positioning.....	31
Child Safety.....	20
General Information.....	20
Child Safety Locks.....	32
Cleaning Leather Seats.....	288
Cleaning Products.....	284
Cleaning the Engine.....	286
Cleaning the Exterior.....	285
Cleaning the Instrument Panel and Instrument Cluster Lens.....	288
Cleaning the Interior.....	287
Cleaning the Wheels.....	289
Cleaning the Windows and Wiper Blades.....	287
Clearing All MyKeys.....	61
Climate.....	382
Climate Control.....	117
Cold Weather Precautions.....	232
Connected Vehicle.....	337
Connecting the Vehicle to a Mobile Network.....	337
Connected Vehicle Data.....	16
Connected Vehicle Limitations.....	337
Connected Vehicle Requirements.....	337
Connected Vehicle – Troubleshooting - Vehicles With: Modem.....	338
Connected Vehicle – Troubleshooting - Vehicles With: SYNC 3.....	339
Connecting a Bluetooth® Device - Vehicles With: AM/FM/USB/Bluetooth, Vehicles Without: SYNC.....	348
Connecting the Vehicle to a Mobile Network.....	337
Connecting FordPass to the Modem.....	337
Enabling and Disabling the Modem.....	337
What Is the Modem.....	337
Connecting the Vehicle to a Wi-Fi Network - Vehicles With: SYNC 3.....	337
Coolant Check See: Engine Coolant Check.....	269
Crash and Breakdown Information.....	241
Automatic Crash Shutoff.....	241
Crash Sensors and Airbag Indicator.....	48
Creating a MyKey.....	60
Creating a Vehicle Wi-Fi Hotspot - Vehicles With: SYNC 3.....	341
Creating a Vehicle Wi-Fi Hotspot - Vehicles Without: SYNC.....	341
Cross Traffic Alert.....	209
Cruise Control.....	73
Principle of Operation.....	192
Cruise control See: Using Cruise Control.....	192
Customer Assistance.....	242
Customer Information.....	426
D	
Data Privacy.....	14
Daytime Running Lamps.....	79
Declaration of Conformity.....	456
Digital Radio.....	351
Direction Indicators.....	81
Doors and Locks.....	64
Driver Alert.....	200
Driver and Passenger Airbags.....	42
Driving Aids.....	200
Driving Hints.....	231
Driving Through Water.....	233
DRL See: Daytime Running Lamps.....	79
E	
Economical Driving.....	231
Electromagnetic Compatibility.....	428
Electronic Locking Differential.....	173
Emergency Call Limitations.....	51
Emergency Call Requirements.....	50
Emergency Call System Data.....	17
Emission Law.....	157
End User License Agreement.....	431
Engine Block Heater.....	146
Engine Coolant Check.....	269

Index

Engine Emission Control.....	157	Getting the Services You Need.....	242
Engine Immobilizer		Glove Compartment.....	140
See: Passive Anti-Theft System.....	70	H	
Engine Oil Check.....	266	Handbrake	
Engine Oil Dipstick.....	266	See: Parking Brake.....	176
Engine Specifications.....	325	Hazard Flashers.....	236
Entertainment.....	380	Headlamp Adjusting	
Environment.....	13	See: Adjusting the Headlamps.....	278
Essential Towing Checks.....	226	Headlamp Removal	
Event Data.....	15	See: Removing a Headlamp.....	279
Exterior Mirrors.....	86	Headrest	
F		See: Head Restraints.....	124
Fastening the Seatbelts.....	35	Head Restraints.....	124
Flat Tire		Heated Exterior Mirrors.....	122
See: Changing a Road Wheel.....	313	Heated Rear Window.....	122
Floor Mats.....	234	Heated Seats.....	130
Fog Lamps - Front		Heating	
See: Front Fog Lamps.....	80	See: Climate Control.....	117
Ford Protect.....	414	Hill Start Assist.....	176
Four-Wheel Drive.....	165	Hints on Controlling the Interior	
Principle of Operation.....	165	Climate.....	120
Front Fog Lamps.....	80	Hints on Driving With Anti-Lock	
Front Parking Aid.....	187	Brakes.....	175
Front Passenger Sensing System.....	43	Hood Lock	
Fuel and Refueling.....	150	See: Opening and Closing the Hood.....	264
Fuel Consumption.....	155	Horn.....	74
Fuel Filler Funnel Location.....	151	How Does the Rear Occupant Alert	
Fuel Filter.....	274	System Work.....	132
Fuel Quality.....	150	I	
Fuse Box Locations.....	249	Ignition Switch.....	142
Fuses.....	249	In California (U.S. Only).....	243
Fuse Specification Chart.....	250	Information Display Control.....	74
G		Information Displays.....	96
Garage Door Opener.....	134	General Information.....	96
Garage Door Opener		Information Messages.....	104
See: Universal Garage Door Opener.....	134	Installing Child Restraints.....	22
Gauges.....	89	Instrument Cluster.....	89
Gearbox		Instrument Lighting Dimmer.....	78
See: Transmission.....	161	Instrument Panel.....	18
General Information on Radio		Interior Lamps.....	81
Frequencies.....	52	Interior Mirror.....	87
General Maintenance Information.....	416	Introduction.....	7
Getting Assistance Outside the U.S. and			
Canada.....	245		

Index

J

Jump Starting the Vehicle.....236

K

Keyless Starting.....143

Keys and Remote Controls.....52

L

Lane Keeping System.....201

Lighting Control.....77

Lighting.....77

 General Information.....77

Load Carrying.....218

Load Limit.....218

Load Retaining Fixtures.....222

Locking and Unlocking.....64

Lug Nuts

 See: Changing a Road Wheel.....313

M

Maintenance.....263

 General Information.....263

Manual Climate Control.....117

Manual Seats.....126

Media Hub.....355

Message Center

 See: Information Displays.....96

Mirrors

 See: Windows and Mirrors.....83

Mobile Communications Equipment.....11

Mobile Device Data.....17

Motorcraft Parts.....326

MyKey – Troubleshooting.....62

MyKey™.....59

 Principle of Operation.....59

N

Navigation.....387

Normal Scheduled Maintenance.....419

O

Off-Road Driving.....232

Oil Change Indicator Reset.....268

Oil Check

 See: Engine Oil Check.....266

Opening and Closing the Hood.....264

Ordering Additional Owner's

 Literature.....247

Overhead Console.....140

P

Parking Aids.....186

 Principle of Operation.....186

Parking Brake.....176

Passive Anti-Theft System.....70

Passive Key Backup Position.....58

PATS

 See: Passive Anti-Theft System.....70

Perchlorate.....10

Personal Safety System™.....40

Phone.....385

Power Door Locks

 See: Locking and Unlocking.....64

Power Seats.....127

Power Steering Fluid Check.....274

Power Windows.....83

Pre-Collision Assist.....213

Protecting the Environment.....13

Puncture

 See: Changing a Road Wheel.....313

R

Radio.....349

Rear Axle.....173

Rear Occupant Alert System Audible

 Warnings.....133

Rear Occupant Alert System

 Indicators.....133

Rear Occupant Alert System

 Limitations.....132

Rear Occupant Alert System

 Precautions.....132

Rear Occupant Alert System.....132

Rear Parking Aid.....187

Rear Seat Armrest.....141

Rear Seats.....129

Rear View Camera.....188

Index

Rear View Camera	
See: Rear View Camera.....	188
Recommended Towing Weights.....	225
Refueling.....	153
Remote Control.....	52
Remote Start.....	123
Removing a Headlamp.....	279
Removing the Tailgate.....	68
Repairing Minor Paint Damage.....	289
Replacement Parts	
Recommendation.....	10
Replacing a Lost Key or Remote Control.....	58
Reporting Safety Defects (Canada Only).....	247
Reporting Safety Defects (U.S. Only).....	247
Roadside Assistance.....	235
Roadside Emergencies.....	235
Running-In	
See: Breaking-In.....	231
Running Out of Fuel.....	151
S	
Safety Canopy™.....	46
Safety Precautions.....	150
Satellite Radio.....	349
Scheduled Maintenance.....	416
Seatbelt Extensions.....	39
Seatbelt Height Adjustment.....	37
Seatbelt Reminder.....	37
Seatbelts.....	34
Principle of Operation.....	34
Seats.....	124
Security.....	70
Service Data.....	15
Settings Data.....	16
Settings.....	393
Setting the Trail Control Speed.....	184
Side Airbags.....	45
Sitting in the Correct Position.....	124
Snow Chains	
See: Using Snow Chains.....	308
Spare Wheel	
See: Changing a Road Wheel.....	313
Special Notices.....	10
Special Operating Conditions Scheduled Maintenance.....	422
Speed Control	
See: Cruise Control.....	192
Stability Control.....	179
Principle of Operation.....	179
Starter Switch	
See: Ignition Switch.....	142
Starting a Gasoline Engine.....	143
Starting and Stopping the Engine.....	142
General Information.....	142
Steering.....	213
Steering Wheel.....	72
Storage Compartments.....	140
Sun Visors.....	88
Supplementary Restraints System.....	41
Principle of Operation.....	41
Switching Rear Occupant Alert System On and Off.....	132
Switching Trail Control On and Off.....	184
Symbols Glossary.....	7
SYNC™ 3.....	372
General Information.....	372
SYNC™ 3 Troubleshooting.....	395
SYNC™ Applications and Services.....	360
SYNC™.....	356
General Information.....	356
SYNC™ Troubleshooting.....	362
T	
Tailgate Lock.....	68
Tailgate.....	68
Technical Specifications	
See: Capacities and Specifications.....	325
Terrain Control.....	182
Principle of Operation.....	182
The Better Business Bureau (BBB) Auto Line Program (U.S. Only).....	244
Tire Care.....	293
Tire Pressure Monitoring System.....	309
Tires	
See: Wheels and Tires.....	292
Towing a Trailer.....	224
Towing Points.....	239
Towing the Vehicle on Four Wheels.....	229

Index

Towing.....	224
Traction Control.....	178
Principle of Operation.....	178
Trail Control Indicators.....	185
Trail Control.....	184
Trail Control – Troubleshooting.....	185
Trail Control – Troubleshooting.....	185
Trail Control – Information Messages.....	185
Trailer Sway Control.....	225
Transmission Code Designation.....	328
Transmission.....	161
Transporting the Vehicle.....	238
Type Approvals.....	456

U

Under Hood Overview.....	265
Under Seat Storage.....	141
Unique Driving Characteristics.....	148
Universal Garage Door Opener.....	134
USB Port.....	354
Using Adaptive Cruise Control.....	193
Using a Slide-In Camper.....	223
Using Cruise Control.....	192
Using Four-Wheel Drive.....	165
Using MyKey With Remote Start Systems.....	62
Using Snow Chains.....	308
Using Stability Control.....	180
Using SYNC™ With Your Media Player.....	362
Using SYNC™ With Your Phone.....	359
Using Traction Control.....	178
Using Voice Recognition.....	357
Using Voice Recognition – Vehicles Without: SYNC.....	355
Utilizing the Mediation/Arbitration Program (Canada Only).....	245

V

Vehicle Care.....	284
General Information.....	284
Vehicle Certification Label.....	328
Vehicle Identification Number.....	327
Vehicle Storage.....	289
Vehicle Wi-Fi Hotspot.....	341

Ventilation See: Climate Control.....	117
VIN See: Vehicle Identification Number.....	327
Voice Control.....	73

W

Warning Lamps and Indicators.....	92
Warranty Information.....	426
Washer Fluid Check.....	277
Washers See: Cleaning the Exterior.....	285
See: Wipers and Washers.....	75
Waxing.....	286
What Is 911 Assist.....	50
What Is a Connected Vehicle.....	337
What is the Rear Occupant Alert System.....	132
What Is Trail Control.....	184
Wheel Nuts See: Changing a Road Wheel.....	313
Wheels and Tires.....	292
General Information.....	292
Technical Specifications.....	324
Wi-Fi See: Changing the Vehicle Wi-Fi Hotspot Name or Password.....	342
See: Connecting the Vehicle to a Wi-Fi Network - Vehicles With: SYNC 3.....	337
See: Creating a Vehicle Wi-Fi Hotspot - Vehicles With: SYNC 3.....	341
See: Creating a Vehicle Wi-Fi Hotspot - Vehicles Without: SYNC.....	341
See: Vehicle Wi-Fi Hotspot.....	341
Windows and Mirrors.....	83
Windshield Washers.....	76
Windshield Wipers.....	75
Wiper Blades See: Checking the Wiper Blades.....	277
Wipers and Washers.....	75