



2023

NX450h+

OWNER'S MANUAL



WARNING: Operating, servicing and maintaining a passenger vehicle or off-highway motor vehicle can expose you to chemicals including engine exhaust, carbon monoxide, phthalates, and lead, which are known to the State of California to cause cancer and birth defects or other reproductive harm. To minimize exposure, avoid breathing exhaust, do not idle the engine except as necessary, service your vehicle in a well-ventilated area and wear gloves or wash your hands frequently when servicing your vehicle. For more information go to www.P65Warnings.ca.gov/passenger-vehicle.

Your Lexus Dealer

Your Lexus dealer will provide quality maintenance and any other assistance you may require.

If there is not a Lexus dealer near you, please call the following number:

■ U.S. OWNERS

● In the U.S. mainland or Canada:

Lexus Roadside Assistance

1-800-25-LEXUS or 1-800-255-3987 (Toll-Free)

● In Hawaii:

Servco Automotive Roadside Assistance/Customer Services

1-800-25-LEXUS or 1-800-255-3987 (Toll-Free)

■ CANADIAN OWNERS

● In Canada or the U.S. mainland:

Lexus Roadside Assistance/Customer Service

1-800-26-LEXUS or 1-800-265-3987 (Toll-Free)

Please access our **websites** for further information.

● The U.S. mainland: www.lexus.com

● Hawaii: www.servcolexus.com

● Canada: www.lexus.ca

©2022 TOYOTA MOTOR CORPORATION

All rights reserved. This material may not be reproduced or copied, in whole or in part, without the written permission of Toyota Motor Corporation.

Before driving	Important points to know before driving the vehicle	1
Driving the vehicle	Basic operations for when driving the vehicle	2
Driving according to the conditions	Using the air conditioning system and interior convenience features	3
Interior features	Using the air conditioning system and interior convenience features	4
Vehicle status information and indicators	Reading driving-related information	5
Driving support system	Safe driving support function and SRS airbag settings	6
Wireless communication	Wireless communication services which support safety, comfort and convenience	7
Maintenance and care	Caring for your vehicle and maintenance procedures	8
When trouble arises	What to do in case of malfunction and emergency	9
Vehicle specifications	Vehicle specifications, customizable features	10
For owners	Reporting safety defects for U.S. owners, and seat belt, SRS airbag and headlight aim instructions for Canadian owners	11
Index	Search alphabetically	

For your information

For your information..... 9
 Pictorial index.....13

1 Before driving

1-1. Using the dedicated floor mats

Using the dedicated floor mats correctly.....24

1-2. Important points for the plug-in hybrid system

Plug-in hybrid system features26
 Plug-in Hybrid system precautions.....37
 Plug-in hybrid electric vehicle driving tips41
 EV driving range43

1-3. Charging with the plug-in hybrid system

Important points for charging the hybrid battery (traction battery) of the plug-in hybrid system..... 46
 Plug-in hybrid system charging equipment..... 50
 Charging the hybrid battery (traction battery) of the plug-in hybrid system..... 63
 Useful plug-in hybrid system charging functions.....78

1-4. Vehicle load limits

Vehicle load limits 89

1-5. Preparations for safe driving with children in the vehicle

Riding with children 90
 Child restraint system.....93

Child restraint system installation method..... 94
 Installing a child restraint system to the front passenger's seat..... 103

1-6. Entering/exiting the vehicle and loading luggage

Key types..... 104
 Smart access system with push-button start.....108
 Digital Key113
 Opening/closing the doors115
 Locking/unlocking the doors....119
 Theft deterrent system125
 Loading the vehicle with luggage.....128
 Trailer towing (vehicles with towing package).....145
 Trailer towing (vehicles without towing package).....155
 Dinghy towing.....156
 Opening and closing the windows157

1-7. Obtaining the correct driving posture

Adjusting the seats.....160
 Adjusting the rear seats.....164
 Using the seat belts.....165
 Adjusting the position of the steering wheel and mirrors...169

2 Driving the vehicle

2-1. Starting and stopping the hybrid system

Starting the hybrid system.....182
 Stopping the hybrid system186

2-2. Driving procedures

Driving procedure..... **188**
 Breaking in your new Lexus **191**
 Intended use of each shift position **192**
 Changing the shift position..... **194**
 Starting off..... **199**
 Operations when turning left or right or changing lanes **200**
 Changing the shift range **201**

2-3. Parking the vehicle

When parking the vehicle **203**
 Stopping **205**
 Parking the vehicle..... **207**

2-4. Refueling

Refueling **218**

3

Driving according to the conditions

3-1. Driving when the surrounding area is dark

Using the headlights..... **222**
 Automatically changing between the low beam headlights and high beam headlights..... **227**

3-2. Driving when the sun or headlights of other vehicles are bright

Using the sun visors..... **235**
 Inside rear view mirror anti-glare function (vehicles with auto anti-glare inside rear view mirror) **236**
 Digital Rearview Mirror anti-glare function (optical mirror mode)..... **237**

3-3. Driving in the rain

Precautions for driving in the rain..... **238**
 Ensuring visibility in the rain **239**

3-4. Driving when the windows or mirrors are fogged up

Defog the windshield **246**
 Defog the rear window **248**
 Defog the outside rear view mirrors **249**

3-5. Driving when it is cold

Preparing for cold weather..... **250**
 Cold weather driving tips **253**

3-6. Driving when in the fog or on a mountain road and visibility is poor

Fog light illumination **255**
 Sounding the horn..... **256**

3-7. Utility vehicle precautions

Utility vehicle precautions..... **257**

3-8. Changing the driving characteristics

Driving modes **260**
 Changing the driving mode **262**
 Trail Mode (AWD vehicles)..... **264**

3-9. Brake hold system

Brake hold system **266**

4

Interior features

4-1. Favorite settings

My Settings **270**

4-2. Adjusting the preferred driving position

Enabling easier driver entry and exit (Power easy access system)272

Driving position registration/recall/deletion..... 273

4-3. Adjusting the temperature/environment inside the vehicle

Comfortable condition to be maintained without adjusting each system (Lexus Climate Concierge) 277

Air conditioning controls 279

Heated steering wheel.....289

Seat heaters290

Seat ventilators.....292

Using the moon roof 293

4-4. Illuminating the interior

Using the interior lights..... 296

4-5. Using the interior features

Location of the storage features..... 300

Convenient interior features...306

4-6. Using the luggage compartment

Using the cargo hooks..... 317

Using the cargo net hooks.....318

Using the grocery bag hooks..319

Deck board320

Stowing the luggage cover..... 322

5

Vehicle status information and indicators

5-1. Functions and displays of the meter

Warning lights and indicators. 326

Gauges and meters (except F SPORT models) 333

Gauges and meters (F SPORT models).....340

5-2. Functions of the displays

Multi-information display (vehicles without a head-up display) 345

Multi-information display (vehicles with a head-up display) 347

Head-up display349

Displayed content.....352

5-3. Changing the settings of the displays

Changing the instrument panel light brightness.....365

Changing settings for the head-up display366

6

Driving support system

6-1. Features of the safe driving support functions

Lexus Safety System + 3 software update..... 370

Lexus Safety System + 3 373

Driving assist systems 381

6-2. Using the safe driving support functions

Pre-Collision System 388

Lane Tracing Assist 400

Lane Change Assist405

Lane Departure Alert.....409

Front cross traffic alert 415

Assistance in detecting vehicles behind when changing lanes.....418

Supporting safe exit by detecting detectable objects at the rear of the vehicle by outputting sounds, displaying screens as a warning or cancelling opening of the doors **424**

Buzzer and screen notifications when approaching an object at low speed **431**

Buzzer and screen notifications when traveling at a low speed and an approaching vehicle is detected at the rear **443**

Buzzer and screen notifications when traveling at a low speed and a pedestrian is detected at the rear **450**

Brake operation when an object is detected while approaching at low speed **455**

Parking assistance through the Advanced Park main switch operation **469**

Road Sign Assist **512**

Dynamic radar cruise control.. **516**

Cruise Control **526**

Emergency Driving Stop System **531**

Hybrid system output restriction when the accelerator pedal and brake pedal are depressed at the same time.. **534**

Sudden start restraint control. **535**

6-3. Reducing impact to the occupants in a collision

Reducing impact to passengers in a collision **536**

Front passenger occupant classification system **547**

7 Wireless communication

7.1. Connected Services

Safety Connect **552**

Remote Connect **556**

Service Connect **557**

8 Maintenance and care

8-1. Exterior maintenance and care

Washing the vehicle..... **560**

8-2. Cleaning and protecting the vehicle interior

Cleaning the vehicle interior .. **566**

Cleaning the areas with satin-finish metal accents..... **568**

Cleaning the leather areas..... **569**

Cleaning the synthetic leather areas **570**

Cleaning DC/DC converter air intake vent..... **571**

8-3. Maintenance

Maintenance requirements **575**

Scheduled maintenance outline **576**

Do-it-yourself maintenance.... **577**

General maintenance **578**

Engine compartment maintenance items list..... **579**

Luggage compartment maintenance item list..... **580**

Vehicle interior maintenance items list **581**

Vehicle exterior maintenance items list **582**

Emission inspection and maintenance (I/M) programs **583**

8-4. Inspection of consumables

Do-it-yourself service precautions..... **584**

Opening the hood..... **586**

Engine compartment..... **587**

Adding washer fluid..... **594**

12-volt battery..... **595**

Air conditioning filter maintenance..... **598**

8-5. Tire maintenance

Tire maintenance..... **600**

Tire inspection items..... **601**

Run-flat tire features..... **604**

Operation of the tire pressure warning system **605**

Checking tire inflation pressure..... **616**

Lifting the vehicle with a floor jack..... **618**

Rotating the tires **619**

Wheels **620**

Replacing the tire..... **622**

Headlight aim..... **631**

9 When trouble arises

9-1. What to do if a problem occurs while driving

What to do if a problem occurs while driving..... **635**

9-2. If a warning light illuminates/ flashes or a warning message is displayed on the meter

If a warning light turns on/ flashes **638**

If a warning message is displayed **651**

9-3. If the hybrid system will not start

When the hybrid system cannot be started even though the correct starting procedure is being followed **672**

When the interior lights or headlights are dim and the hybrid system cannot be started..... **675**

When the interior lights or headlights do not illuminate and the hybrid system cannot be started..... **682**

When the horn sounds at a low volume and the hybrid system cannot be started..... **683**

When the horn does not sound and the hybrid system cannot be started..... **684**

9-4. If a tire is flat

Precautions for when you have a flat tire **685**

9-5. If a door cannot be opened or locked

If a key has been lost..... **686**

When the doors/windows/ moon roof cannot be operated using an electronic key. **687**

If a door cannot be opened using the door opener switch **696**

If the rear doors cannot be opened from the inside **699**

If the back door cannot be opened..... **700**

9-6. If the moon roof or electronic sunshade does not operate correctly

If the moon roof does not operate correctly **701**

9-7. If refueling cannot be performed

If the fuel filler door cannot be opened **702**

9-8. If the plug-in hybrid system cannot be used normally

If the hybrid battery (traction battery) of the plug-in hybrid system cannot be charged.... **703**

If the charging connector cannot be disconnected from the AC charging inlet **707**

When a malfunction occurs during charging **709**

If the charging schedule function does not operate normally..... **711**

9-9. If an indicator on an interior feature illuminates or flashes

When the wireless charger operation indicator light (on the charging tray) flashes..... **713**

9-10. If the vehicle cannot move

When a hybrid system warning message is displayed and the vehicle does not move..... **714**

If the hybrid transmission makes abnormal sounds **715**

Towing with a tow truck **716**

Using a flatbed truck..... **718**

Towing with another vehicle..... **719**

Getting unstuck from mud, sand, or snow **722**

9-11. If you think something is wrong

If a vehicle abnormality is found **723**

If abnormal sounds are emitted from the vehicle **724**

If the vehicle behaves abnormally..... **725**

9-12. Items to check before contacting a dealership

The steering wheel cannot be turned after the hybrid system is stopped **726**

If the windows do not open or close by operating the power window switches..... **727**

The power switch is turned off automatically..... **729**

If your vehicle overheats **730**

If electrical components cannot be used or do not operate when a switch is operated **733**

If a light does not illuminate **734**

10 Vehicle specifications**10-1. Specifications**

Maintenance data (fuel, oil level, etc.) **742**

Fuel information..... **750**

Tire information **753**

10-2. Customizable features

User customization function outline **763**

Method to change settings..... **764**

Customizable features..... **765**

10-3. Initialization

Items to initialize 783

11 For owners

11-1. For owners

Reporting safety defects for
U.S. owners 786

Reporting safety defects for
Canadian owners 787

Seat belt instructions for
Canadian owners (in
French) 788

SRS airbag instructions for
Canadian owners (in
French) 789

Headlight aim instructions for
Canadian owners (in
French) 795

Supplement 797

Index 802

Certification 814

For your information

Information contained in this Owner's Manual

Please note that this manual applies to all models and explains all equipment, including options. Therefore, you may find explanations for equipment not installed on your vehicle and the illustrations used may differ from your vehicle.

All specifications provided in this manual are current at the time of printing. Over time, your vehicle may receive updates that modify the vehicle and make material in this manual incomplete and/or inaccurate. Because of Lexus' interest in continual product improvement, Lexus reserves the right to make changes to this manual at any time without notice.

If Lexus chooses to update the manual, updated versions can be viewed by selecting your vehicle by model and year at the following URL or on your mobile device if you have access to the Lexus app.

<https://drivers.lexus.com>

Reading this manual

This section explains symbols used in this manual.

■ Meanings of symbols in the text

The names and meanings of symbols are as follows:

-  WARNING

Explains something that, if not obeyed, could cause death or serious injury to people.

-  NOTICE

Explains something that, if not obeyed, could cause damage to or a malfunction in the vehicle or its equipment.

-  Step number

Indicates operating or working procedures. Follow the steps in numerical order.



● Info

Explains important points other than functions and operating methods.

■ **Meanings of symbols in illustrations**

The names and meanings of symbols are as follows:

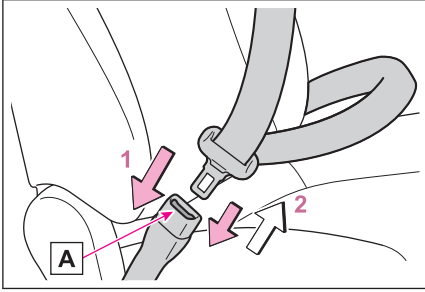

- Indicates the action (pushing, turning, etc.) used to operate switches and other devices.



- Indicates the outcome of an operation (e.g. a lid opens).

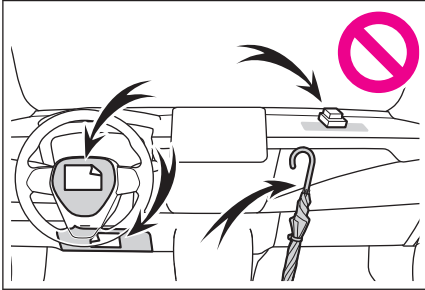

- Indicates the component or position being explained.



- Means Do not, Do not do this, or Do not let this happen.

Precautions for safe driving

WARNING

- Driving under the influence: Never drive your vehicle when under the influence of alcohol or drugs that have impaired your ability to operate your vehicle. Alcohol and certain drugs delay reaction time, impair judgment and reduce coordination, which could lead to an accident that could result in death or serious injury.
- Driver distraction: Always give your full attention to driving. Anything that distracts the driver, such as adjusting controls, talking on a cellular phone or reading can result in a collision with resulting death or serious injury to you, your occupants or others.
- Always observe the legal speed limit when driving on public roads.
- Defensive driving: Always drive defensively. Anticipate mistakes that other drivers or pedestrians might make and be ready to avoid accidents.
- When driving over long distances, take regular breaks before you start to feel tired. Also, if you feel tired or sleepy while driving, do not force yourself to continue driving and take a break immediately.

Noise from under vehicle after turning off the hybrid system

Approximately five hours after the hybrid system is turned off, you may hear sound coming from under the vehicle for several minutes. This is the sound of a fuel evaporation leakage check and, it does not indicate a malfunction.

Usage of data collected through Connected service (U.S. mainland only)

If your Lexus has Connected service and if you have subscribed to those services, please refer to the Connected service Telematics Subscription Service Agreement for information on data collected and its usage.

- To learn more about the vehicle data collected, used and shared by Lexus, please visit <http://www.lexus.com/privacyvts/>.

General precaution regarding children's safety

WARNING

Never leave children unattended in the vehicle, and never allow children to have or use the key.

Children may be able to start the vehicle or shift the vehicle into neutral.

⚠ WARNING

There is also a danger that children may injure themselves by playing with the windows, the moon roof, or other features of the vehicle. In addition, heat build-up or extremely cold temperatures inside the vehicle can be fatal to children.

Perchlorate Material

Special handling may apply, See www.dtsc.ca.gov/hazardouswaste/perchlorate.

Your vehicle has components that may contain perchlorate. These components may include the airbags, seat belt pretensioners, wireless remote control batteries, and the batteries in the tire pressure warning valve and transmitters.

Pictorial index

Exterior

 INFORMATION

Light bulbs of the exterior lights for driving (Replacing method: → P.738)

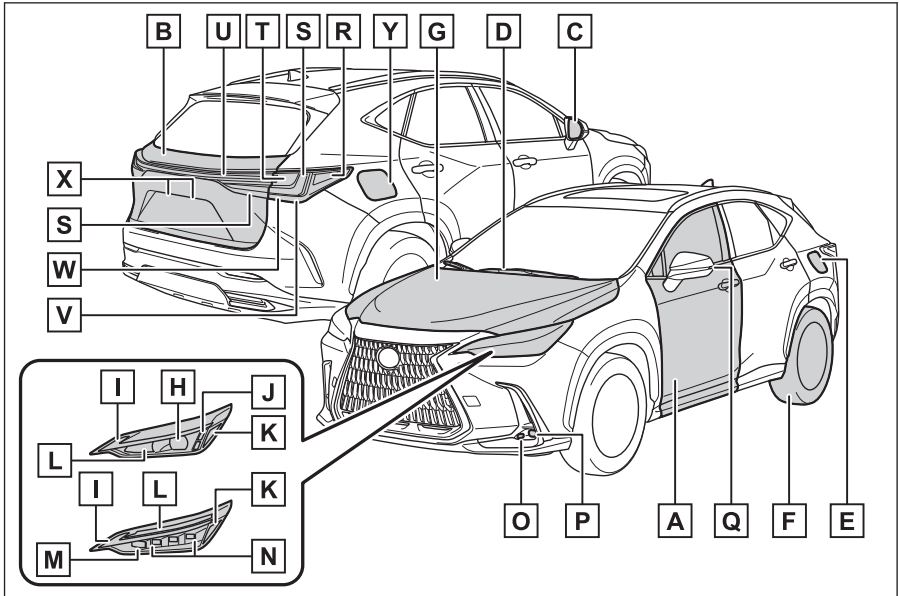

A	Side doors	P.115
	Locking/unlocking	P.119
	Opening/closing the side doors.....	P.115
	Opening/closing the side windows.....	P.157,158
	Locking/unlocking by using the mechanical key	P.690
	Warning messages.....	P.651
B	Back door	P.130
	Opening from inside the cabin.....	P.130
	Opening from outside.....	P.130
	Warning messages.....	P.651
C	Outside rear view mirrors	P.177
	Adjusting the mirror angle.....	P.177
	Folding the mirrors.....	P.179

	Driving position memory	P.273
	Defogging the mirrors.....	P.249
D	Windshield wipers	P.239,242
	Precautions for winter season.....	P.250
	Precautions for car wash.....	P.564
E	Fuel filler door	P.218
	Refueling method	P.218
	Fuel type/fuel tank capacity	P.744
F	Tires	P.600
	Tire size/inflation pressure	P.617,748
	Winter tires/tire chains.....	P.250
	Checking/rotation/tire pressure warning system.....	P.600,601,605,619
	Coping with flat tires	P.685
G	Hood	P.586
	Opening.....	P.586
	Engine oil	P.745
	Coping with overheating	P.730
	Warning messages.....	P.651
H	Headlights	P.222
I	Parking lights/daytime running lights	P.222
J	Daytime running lights	P.222
K	Front side marker lights	P.222
L	Turn signal lights	P.222
M	Headlight high beams (for Canada)	P.222
N	Headlights (except for Canada)/Headlight low beams (for Canada)	P.222
O	Cornering lights *	P.225
P	Front fog lights	P.255
Q	Turn signal lights	P.200
R	Rear side marker lights	P.222
S	Stop/tail lights	P.222
T	Turn signal lights	P.200

*: If equipped

U	Tail light	P.222
V	Back-up light	
	Changing the shift position to R	P.194
W	Stop lights	
X	License plate lights	P.222
Y	Charging port	P.50
	Charging method	P.63

Instrument panel

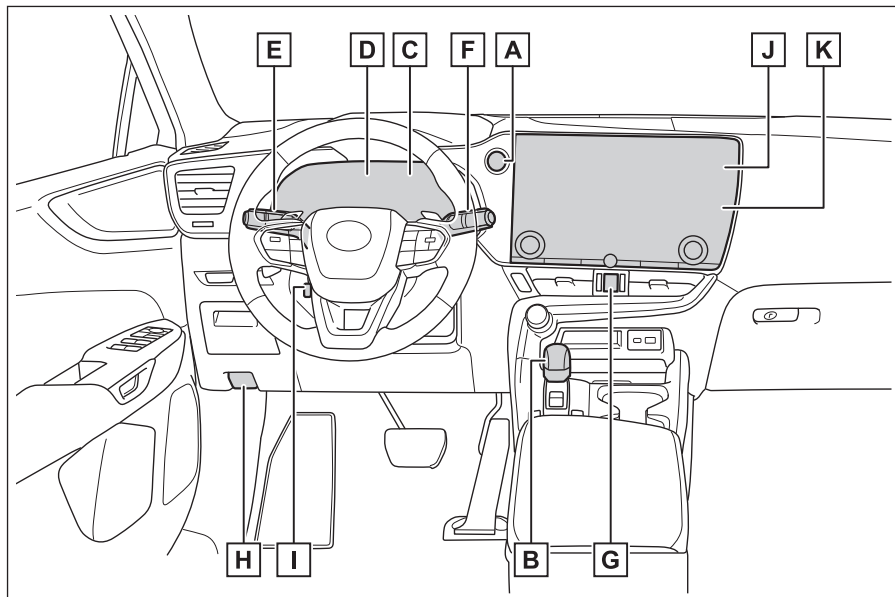

A	Power switch	P.182
	Starting the hybrid system/changing the modes	P.182,184
	Emergency stop of the hybrid system.....	P.635
	When the hybrid system will not start.....	P.672
	Warning messages.....	P.651
B	Shift lever	P.192
	Changing the shift position	P.194
	Precautions for towing	P.716,718,719
C	Meters	P.333,340
	Reading the meters/adjusting the instrument panel light	P.333,340,365
	Warning lights/indicator lights.....	P.326
	When a warning light turns on.....	P.638
D	Multi-information display	P.345,347
	Display	P.345,347
	Energy monitor.....	P.357
	When a warning message is displayed	P.651
E	Turn signal lever/Headlight switch	P.200,222

Headlights/parking lights/tail lights/license plate lights/daytime running lights	P.222
Front fog lights	P.255
F Windshield wiper and washer switch	P.239,242
Usage	P.239,242
Adding washer fluid.....	P.594
Warning messages.....	P.651
G Emergency flasher switch	P.635
H Hood lock release lever	P.586
I Tilt and telescopic steering control switch	P.169
Adjustment.....	P.169
Driving position memory	P.273
J Air conditioning system	P.279
Usage	P.282
Rear window defogger	P.248
K Audio system *1	

*1: Refer to "MULTIMEDIA OWNER'S MANUAL".

Switches

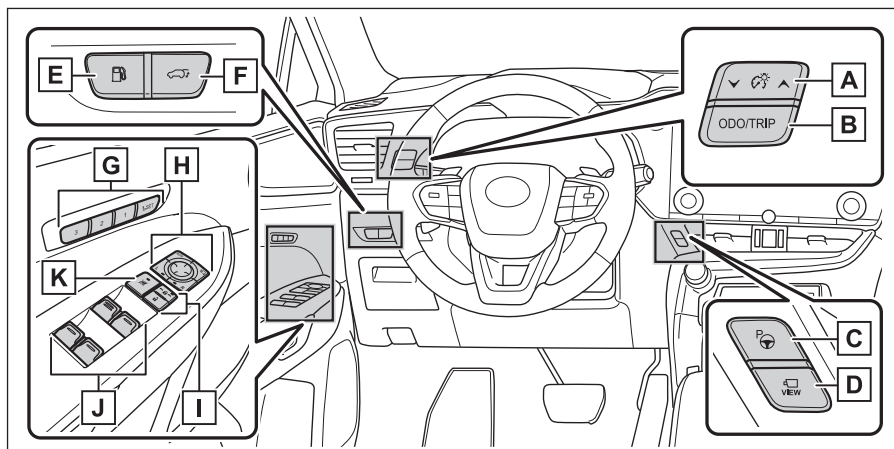

A	Instrument panel light control switches.....	P.365
B	ODO/TRIP switch	P.339
C	Advanced Park (parking assist system) main switch *	P.469
D	Camera switch **2	
E	Fuel filler door opener switch	P.218
F	Power back door switch.....	P.137
G	Driving position memory switches.....	P.273
H	Outside rear view mirror switches.....	P.177
I	Door lock switches	P.121
J	Power window switches	P.157,158
K	Window lock switch	P.159

*: If equipped

**2: Refer to "MULTIMEDIA OWNER'S MANUAL".

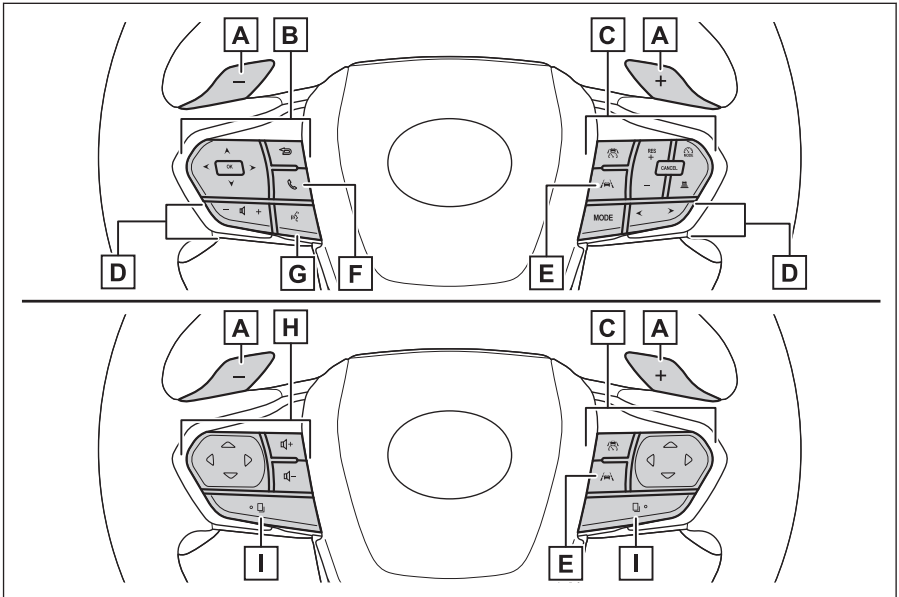

- A** Paddle shift switchesP.201
- B** Meter control switches.....P.352
- C** Cruise control switch
Dynamic radar cruise controlP.516,526
- D** Audio remote control switches ^{*3}
- E** LTA (Lane Tracing Assist) switch P.400,405
- F** Telephone switch ^{*4}
- G** Talk switch ^{*5}
- H** Audio remote control switches/telephone switch/talk switch ^{*6}P.352
- I** Switch function change switchP.352

*3: Refer to "MULTIMEDIA OWNER'S MANUAL".

*4: Refer to "MULTIMEDIA OWNER'S MANUAL".

*5: Refer to "MULTIMEDIA OWNER'S MANUAL".

*6: Refer to "MULTIMEDIA OWNER'S MANUAL".

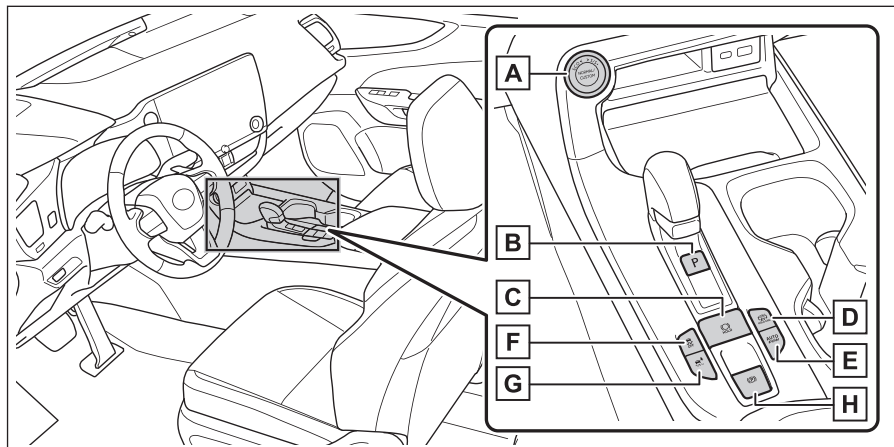

A Driving mode select switch.....	P.262
B P position switch.....	P.194
C Brake hold switch.....	P.266
D EV/HV mode selection switch.....	P.34
E AUTO EV/HV mode switch.....	P.34
F VSC OFF switch.....	P.381
G Trail Mode switch.....	P.264
H Parking brake switch.....	P.194,207,266
Applying/releasing the parking brake.....	P.194,207,266
Precautions for winter season.....	P.253
Warning buzzer/messages.....	P.651

Interior

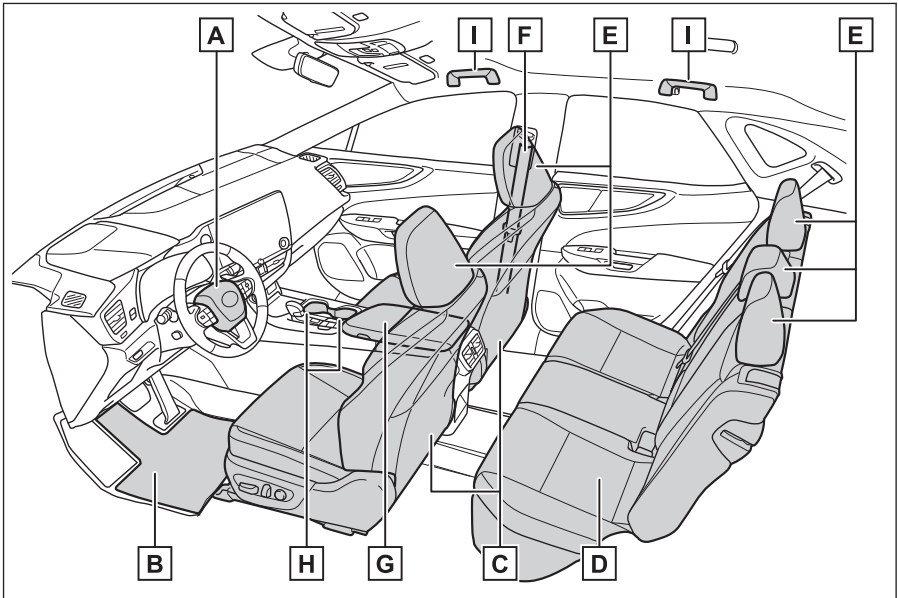

A	SRS airbags	P.536
B	Floor mats	P.24
C	Front seats	P.160
D	Rear seats	P.164
E	Head restraints	P.161
F	Seat belts	P.165
G	Console box	P.304
H	Cup holders	P.302
I	Assist grips	P.315

Ceiling

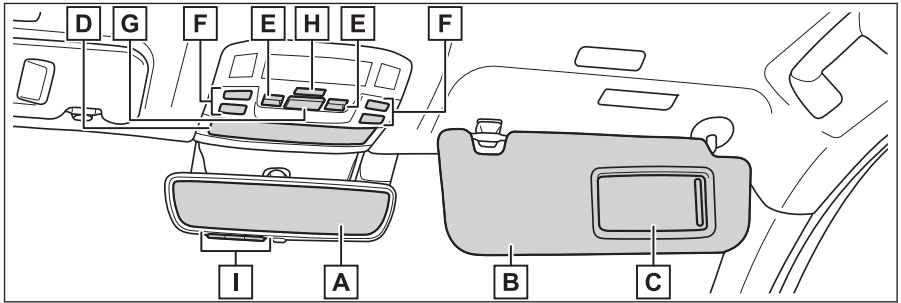

- A** Inside rear view mirror P.169,170,236,237
- B** Sun visors P.235
- C** Vanity mirrors P.316
- D** Auxiliary box P.301
- E** Moon roof switches P.293
- F** Interior light/Personal lights P.297,298
- G** [SOS] button P.552
- H** Door-linked interior light switch P.298
- I** Garage door opener switches P.210

1-1. Using the dedicated floor mats

Using the dedicated floor mats correctly **24**

1-2. Important points for the plug-in hybrid system

Plug-in hybrid system features **26**

Plug-in Hybrid system precautions **37**

Plug-in hybrid electric vehicle driving tips **41**

EV driving range **43**

1-3. Charging with the plug-in hybrid system

Important points for charging the hybrid battery (traction battery) of the plug-in hybrid system **46**

Plug-in hybrid system charging equipment **50**

Charging the hybrid battery (traction battery) of the plug-in hybrid system **63**

Useful plug-in hybrid system charging functions **78**

1-4. Vehicle load limits

Vehicle load limits **89**

1-5. Preparations for safe driving with children in the vehicle

Riding with children **90**

Child restraint system **93**

Child restraint system installation method **94**

Installing a child restraint system to the front passenger's seat **103**

1-6. Entering/exiting the vehicle and loading luggage

Key types **104**

Smart access system with push-button start **108**

Digital Key **113**

Opening/closing the doors... **115**

Locking/unlocking the doors **119**

Theft deterrent system **125**

Loading the vehicle with luggage **128**

Trailer towing (vehicles with towing package) **145**

Trailer towing (vehicles without towing package) ... **155**

Dinghy towing **156**

Opening and closing the windows **157**

1-7. Obtaining the correct driving posture

Adjusting the seats **160**

Adjusting the rear seats **164**

Using the seat belts **165**

Adjusting the position of the steering wheel and mirrors **169**

1-1. Using the dedicated floor mats

Using the dedicated floor mats correctly

Use only floor mats designed specifically for vehicles of the same model and model year as your vehicle. Fix them securely in place onto the carpet.

⚠ WARNING

- When installing a driver's side floor mat, do not use floor mats designed for other models or different model year vehicles, even if they are Lexus Genuine floor mats.
- Only use floor mats designed for the driver's seat.
- Do not use two or more floor mats on top of each other.
- Do not place the floor mat bottomsides up or upside-down.

Securing the floor mats

⚠ WARNING

Check the following before driving.

- Check that the floor mat is securely fixed in the correct place with all the provided retaining hooks (clips). Be especially careful to perform this check after cleaning the floor.

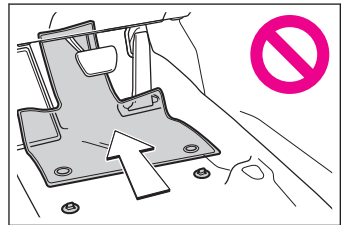

- With the hybrid system stopped and the shift position in P, fully depress each pedal to the floor to make sure it does not interfere with the floor mat.

- 1 Insert the retaining hooks (clips) into the floor mat eyelets.

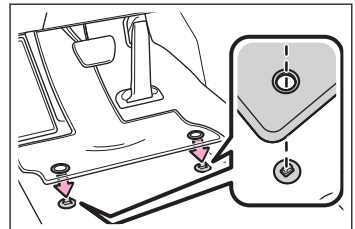

⚠ WARNING

Always install the floor mat securely using the retaining hooks (clips) provided.

- 2 Turn the upper knob of each retaining hook (clip) to secure the floor mats in place.

Always align the \triangle marks **A**.

The shape of the retaining hooks (clips) may differ from that shown in the illustration.

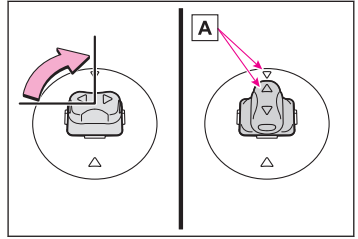

Plug-in hybrid system features

The plug-in hybrid system is a system excellent in both economical efficiency of electric vehicles and practicality of hybrid electric vehicles. EV driving can be performed using electricity charged from an external power source. If the amount of electricity remaining in the hybrid battery (traction battery) becomes low, the vehicle is automatically controlled in such a way that it can be driven as a hybrid electric vehicle through the joint use of the gasoline engine.^{*1}

▲ WARNING

The driver should pay extra attention to pedestrians when the vehicle is powered only by the electric motor (traction motor). As there is no engine noise, the pedestrians may misjudge the vehicle's movement. Even though the vehicle is equipped with the acoustic vehicle alerting system, drive with care as pedestrians in the vicinity may still not notice the vehicle if the surrounding area is noisy.

□ INFORMATION

■ EV indicator

The EV indicator comes on when the vehicle is driven using only the electric motor (traction motor) or the gasoline engine is stopped.

Through a customization setting, the on/off operation of the EV indicator can be changed.

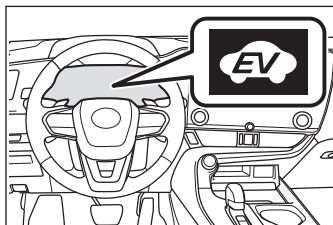

■ Sounds and vibrations specific to a hybrid electric vehicle

Because there is no engine sound or vibration, it is easy to mistake the hybrid electric vehicle for being off when it is actually still running, as indicated by the "READY" indicator being illuminated. For safety, make sure to always shift the shift position to P and apply the parking brake when parked.

The following sounds or vibrations may occur when the hybrid system is operating and are not a malfunction:

^{*1}: The EV driving range will vary in accordance with conditions such as vehicle speed, the amount of charge remaining in the hybrid battery (traction battery) and the usage of the air conditioning system. The gasoline engine may also be used simultaneously in accordance with driving conditions.

- Motor sounds may be heard from the engine compartment.
- Sounds may be heard from the hybrid battery (traction battery) behind the rear seats when the hybrid system starts or stops.
- Click or clunk sounds that may be heard from under of the floor or the rear when the hybrid system is started or stopped, which are sounds of high voltage relay
- Sounds from the hybrid system may be heard when the back door is open.
- Sounds may be heard from the transmission when the gasoline engine starts or stops, when driving at low speeds, or during idling.
- Engine sounds may be heard when accelerating sharply.
- Sounds may be heard due to regenerative braking when the brake pedal is depressed or as the accelerator pedal is released.
- Vibration may be felt when the gasoline engine starts or stops.
- Cooling fan sounds may be heard from the air intake vents under the rear seats.
- Sounds may be heard from near the hybrid battery (traction battery) in accordance with the operation of the air conditioning system or Traction battery cooler.

■ Maintenance, repair, recycling, and disposal

Contact your Lexus dealer regarding maintenance, repair, recycling and disposal. Do not dispose of the vehicle yourself.

System components

▲ WARNING

Check the following regarding handling of the hybrid battery (traction battery).

- Never resell, hand over or modify the hybrid battery. To prevent accidents, hybrid batteries that have been removed from a disposed vehicle are collected through Lexus dealers. Do not dispose of the battery yourself.

If the hybrid battery (traction battery) is not properly collected, the following may occur.

- The hybrid battery may be illegally disposed of or dumped, and it is hazardous to the environment or someone may touch a high voltage part, resulting in an electric shock.
- The hybrid battery is intended to be used exclusively with your hybrid electric vehicle. If the hybrid battery is used outside of your vehicle or modified in any way, accidents such as electric shock, heat generation, smoke generation, an explosion and electrolyte leakage may occur.

1-2. Important points for the plug-in hybrid system

⚠ WARNING

When reselling or handing over your vehicle, the possibility of an accident is extremely high because the person receiving the vehicle may not be aware of these dangers.

- In the event that your vehicle must be disposed of, the hybrid battery must be disposed of by your Lexus dealer or a qualified service shop. If your vehicle is disposed of without the hybrid battery having been removed, there is a danger of serious electric shock if high voltage parts, cables and their connectors are touched.

If the hybrid battery is not disposed of properly, it may lead to electric shock.

- If the vehicle under floor area receives strong shock or impact while driving, stop the vehicle in a safe area and check around the bottom of the vehicle.

If there is damage to the hybrid battery (traction battery) or liquid leakage, it may lead to a vehicle fire, etc. Do not touch the vehicle and immediately contact your Lexus dealer.

- Do not modify the vehicle to make the height lower. It is easier for the hybrid battery (traction battery) in the under floor area to come in contact with the ground when the vehicle is lowered. If the hybrid battery (traction battery) is damaged, a vehicle fire may occur which could lead to death or serious injury.

⚠ NOTICE

Do not carry large amounts of water such as water cooler bottles in the vehicle.

If water spills onto the DC/DC converter, the converter may be damaged.

Have the vehicle inspected by your Lexus dealer.

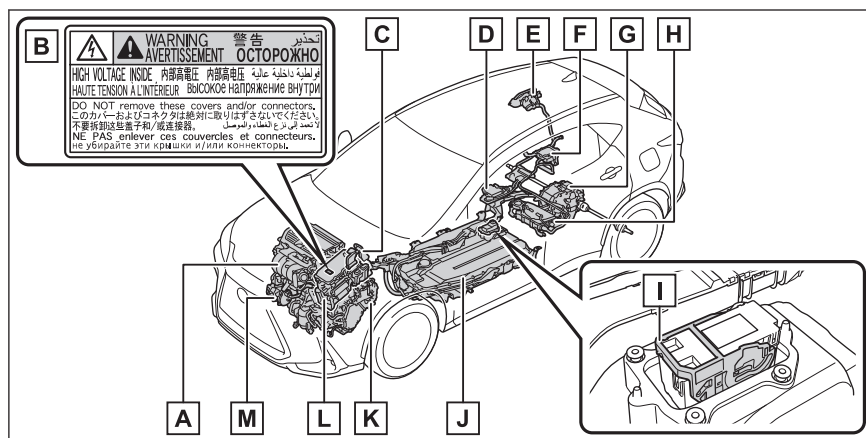

The illustration is an example for explanation and may differ from the actual item.

A Gasoline engine

- B Warning label
- C High voltage cables (orange)
- D DC/DC converter
- E AC charging inlet
- F Junction box
- G Rear electric motor (traction motor)
- H Onboard traction battery charger
- I Service plug
- J Hybrid battery (traction battery)
- K Front electric motor (traction motor)
- L Power control unit
- M Air conditioning compressor

INFORMATION

■ Hybrid battery (traction battery) lifespan (lithium-ion battery)

The hybrid battery (traction battery) has a limited service life.

The hybrid battery (traction battery) capacity (the ability to hold a charge) reduces with time and use in the same way as other rechargeable batteries. The extent at which capacity reduces changes drastically depending on the environment (ambient temperature, etc.) and usage conditions, such as how the vehicle is driven and how the hybrid battery (traction battery) is charged. This is a natural characteristic of lithium-ion batteries, and is not a malfunction. Also, even though the EV driving range becomes shorter when the hybrid battery (traction battery) capacity reduces, vehicle performance does not significantly become worse.

■ Starting the hybrid system in an extremely cold environment

When the hybrid battery (traction battery) is extremely cold (below approximately -22°F [-30°C]) under the influence of the outside temperature, it may not be possible to start the hybrid system. In this case, try to start the hybrid system again after the temperature of the hybrid battery increases due to the outside temperature increase etc.

Plug-in hybrid system operation mode

The plug-in hybrid system operates in the following modes.

The multi-information display can be used to check which mode the plug-in hybrid system is currently being driven in.

1-2. Important points for the plug-in hybrid system

■ EV mode

When a sufficient amount of electricity is remaining after charging^{*2}, EV driving is performed using electricity stored in the hybrid battery (traction battery).^{*3}

When in EV mode, the EV drive mode indicator illuminates.

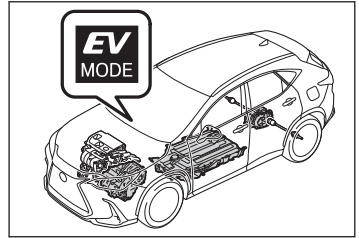

■ AUTO EV/HV mode

Normally, the electricity stored in the hybrid battery (traction battery) is used for EV driving. However, when more power is required, such as for driving uphill or accelerating suddenly, the gasoline engine starts and provides powerful acceleration by strongly depressing the accelerator pedal.

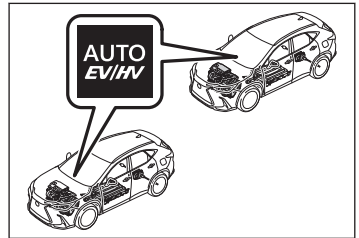

When the vehicle is in a condition where EV driving is possible, EV mode and AUTO EV/HV mode can be switched by operating the switch.

When in AUTO EV/HV mode, the AUTO EV/HV mode indicator illuminates.

■ HV mode

When in HV mode, the vehicle is driven using both the gasoline engine and electric motor.

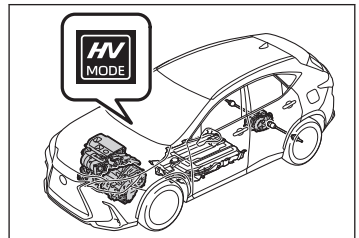

- If electricity needed for EV driving in EV mode or AUTO EV/HV mode is not remaining, the operation mode will be automatically switched to HV mode.
- The operation mode can be switched to HV mode at any timing by operating the switch to keep electricity for EV driving etc.^{*4} Switching to HV mode when driving on a highway or when driving uphill is recommended in order to conserve battery power.

^{*2}: The amount of remaining charge can be checked on the SOC (State of Charge) gauge.

^{*3}: Depending on the situation, EV driving may be canceled and both gasoline engine and electric motor are used.

When in HV mode, the HV drive mode indicator illuminates.

■ Hybrid battery (traction battery) charge mode

Electricity generated in the gasoline engine can be charged in the hybrid battery (traction battery) by switching to the hybrid battery (traction battery) charge mode when electricity needed for EV driving is not remaining.*5

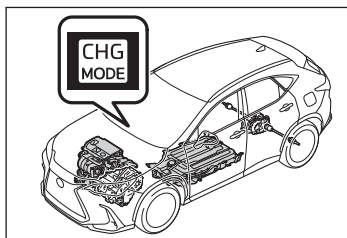

- The system may not be able to switch to the hybrid battery (traction battery) charge mode due to the state of the plug-in hybrid system.
- Charging time differs depending on the driving state of the vehicle when driving in hybrid battery (traction battery) charge mode.

When in the hybrid battery (traction battery) charge mode, the hybrid battery charge mode indicator illuminates.

□ INFORMATION

■ Hybrid battery (traction battery) charge mode

- The following may occur to protect the system, etc.
 - Cannot switch to hybrid battery (traction battery) charge mode or cannot cancel it
 - Gasoline engine does not start or stops even after switching to hybrid battery (traction battery) charge mode
- If a load to the system is large, such as when the power consumption of the air conditioning system is large or when the temperature of the engine coolant is high, it may take longer time than usual to charge using the hybrid battery (traction battery) charge mode, or charging to the hybrid battery (traction battery) may not be performed.

■ If the plug-in hybrid system operation mode cannot be changed

In the following situations, the plug-in hybrid system operation mode cannot be changed even if the AUTO EV/HV mode switch or EV/HV mode selection switch is pressed. When either switch is pressed, a warning message will be displayed on the multi-information display.

- When the charge of the hybrid battery (traction battery) is insufficient for EV driving:
The operation mode will not be changed to EV mode or AUTO EV/HV mode.

*4: The EV driving range may reduce even after switching to HV mode.

*5: When in the hybrid battery (traction battery) charge mode, the hybrid battery can be charged while driving. However, the gasoline engine runs to charge the battery and fuel consumption becomes higher compared with driving in HV mode.

1-2. Important points for the plug-in hybrid system

- When the hybrid battery (traction battery) is nearly fully charged:

The operation mode will not be changed to hybrid battery (traction battery) charge mode.

■ When switching from EV mode to another mode using the switch

If the power switch is turned off while in HV mode or hybrid battery (traction battery) charge mode, the operation mode will be EV mode the next time the hybrid system is started.*6

■ After EV mode has switched to HV mode due to low hybrid battery (traction battery) charge

If the hybrid battery (traction battery) is regenerated by driving continuously down a long slope, the EV driving range etc. will be displayed on the multi-information display and EV mode will be automatically switched to.

If EV mode is not switched to even though EV driving range is being displayed, EV mode can be switched to by pressing the EV/HV mode selection switch.

Control when driving in each mode

■ When in EV mode

In EV mode, EV driving (driving using only the electric motor)*7 is possible. However, depending on the situation, EV driving may be canceled and both gasoline engine and electric motor are used. Also, if a little electricity is remaining in the hybrid battery (traction battery), HV mode is automatically selected. To drive in EV mode long, observe the followings.

- Avoid sudden acceleration and sudden deceleration, and be sure to drive smoothly. If you repeatedly accelerate, the hybrid battery (traction battery) charge will deplete quickly. Also, EV driving may be canceled by rapid acceleration or vehicle speed.
- Restrain your speed as much as possible. The distance that can be driven in EV mode will reduce considerably at high speeds.

■ When in AUTO EV/HV mode

Only the electric motor is used for EV driving*7 during normal driving, but when the accelerator pedal is strongly depressed, the gasoline engine starts.

Also, when the hybrid battery (traction battery) level is low, the mode switches to HV mode automatically the same as in EV mode.

*6: If there is not enough charge remaining in the hybrid battery (traction battery) to allow EV driving, the system switches to HV mode.

*7: The EV driving range can be checked using the multi-information display.

■ When in HV mode

The vehicle can be used in the same way as a standard hybrid electric vehicle.

When in HV mode the vehicle will normally operate as follows, according to the driving conditions.

- The gasoline engine stops^{*8} when the vehicle is stopped.
- During start off, the electric motor (traction motor) drives the vehicle.
- During normal driving, the gasoline engine and electric motor (traction motor) are controlled effectively, and the vehicle is driven with optimum fuel efficiency. Also, when necessary, the electric motor (traction motor) operates as an electrical generator to charge the hybrid battery (traction battery).
- When the accelerator pedal is depressed heavily, drive force from both the gasoline engine and the electric motor (traction motor) is used to accelerate.

■ When braking (regenerative braking)

The electric motor (traction motor) charges the hybrid battery (traction battery).

The EV driving range can be extended by actively using this regenerative braking to store electricity in the hybrid battery (traction battery).

Moreover, as fuel consumption is also reduced when in HV mode, the regenerative braking system can be used effectively.

INFORMATION

■ Gasoline engine operation in EV mode or AUTO EV/HV mode

Even if there is a sufficient amount of electricity remaining in the hybrid battery (traction battery) and EV driving range is being displayed on the multi-information display, EV driving (driving using only the electric motor) may be canceled and both gasoline engine and electric motor are used depending on the situation.

EV driving will be returned to automatically after EV driving becomes possible again.

EV driving may be canceled automatically in the following circumstances^{*9}:

- When vehicle speed is more than approximately 84 mph (135 km/h).
- When in AUTO EV/HV mode:
When power is temporarily needed, such as when the accelerator pedal is fully depressed or when accelerating suddenly.^{*10}

*8: When the hybrid battery (traction battery) requires charging or the engine is warming up, etc., the gasoline engine will not automatically stop.

*9: The gasoline engine may also operate in circumstances other than those listed above, depending on conditions.

*10: When driving in AUTO EV/HV mode. Even in EV mode, the gasoline engine may start, depending on the condition of the hybrid battery (traction battery).

1-2. Important points for the plug-in hybrid system

- When the temperature of the hybrid system is high, such as after the vehicle has been parked in an extremely hot environment, or is driven at high speeds or up a slope, etc.
- When the temperature of the hybrid system is low.
- When the heater is switched on when the outside temperature is below about 14°F (-10°C).
- When the windshield defogger switch is pressed.
- When the system determines that the gasoline engine needs to be started.

■ Conditions in which the gasoline engine may not stop

Although the gasoline engine stops and starts automatically according to the vehicle condition, it may not stop automatically in the following situations:^{*11}

- During gasoline engine warm-up
- During hybrid battery (traction battery) charging
- When the temperature of the hybrid battery (traction battery) is high or low
- When the heater is switched on

■ Regenerative braking

In the following situations, kinetic energy is converted to electric energy and deceleration force can be obtained in conjunction with the recharging of the hybrid battery (traction battery).

- The accelerator pedal is released while driving with the shift position in D or S.
- The brake pedal is depressed while driving with the shift position in D or S.

Switching the plug-in hybrid system operation modes

Press the AUTO EV/HV mode switch or EV/HV mode selection switch to change modes as the following table shows.

When the operation mode is changed, the illuminated indicator will also change.

In order to make EV mode or AUTO EV/HV mode available, charge the hybrid battery (traction battery) from an external power source before using the vehicle.

Even if charging the hybrid battery (traction battery) has not been completed, the vehicle can be driven. However, if there is not enough charge remaining, it is possible that the vehicle cannot be driven in EV mode or AUTO EV/HV mode or the EV driving range will become shorter.

*11: Depending on the circumstances, the gasoline engine may also not stop automatically in other situations.

Current mode	Mode after switching
EV mode	AUTO EV/HV mode
AUTO EV/HV mode	EV mode
HV mode	AUTO EV/HV mode ^{*12}

Current mode	Mode after switching
EV mode	HV mode
AUTO EV/HV mode	HV mode
HV mode	EV mode ^{*13}

▶ AUTO EV/HV mode switch

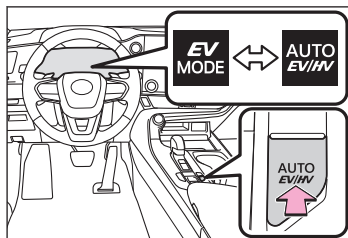

▶ EV/HV mode selection switch

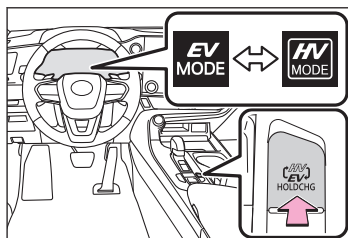

Switching to the hybrid battery (traction battery) charge mode

⚠ WARNING

Observe the following precautions when the vehicle is parked while in hybrid battery (traction battery) charge mode, as the gasoline engine will operate.

- Do not stop the vehicle near flammable materials.
- Do not use the hybrid battery (traction battery) charge mode in a closed area where ventilation is insufficient, such as in a garage or area with snow buildup.

Press and hold the EV/HV mode selection switch.

Take your hand off the switch once the hybrid battery charge mode indicator starts to blink.

The hybrid battery charge mode indicator illuminates when the switch to hybrid battery (traction battery) charge mode is complete.

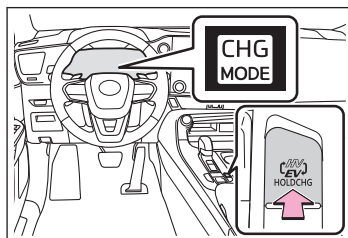

*12: If there is not enough charge remaining in the hybrid battery (traction battery) to allow EV driving, AUTO EV/HV mode will not be selectable.

*13: If there is not enough charge remaining in the hybrid battery (traction battery) to allow EV driving, EV mode will not be selectable.

1-2. Important points for the plug-in hybrid system

When the charge of the hybrid battery (traction battery) reaches the specified level^{*14}, hybrid battery (traction battery) charge mode is canceled automatically to change to hybrid mode.

The hybrid battery (traction battery) charge mode will be canceled by pressing AUTO EV/HV mode switch or EV/HV mode selection switch.

Acoustic vehicle alerting system

When driving with the gasoline engine stopped, a sound, which changes in accordance with the driving speed, will be played in order to warn people nearby of the vehicle's approach. The sound will stop when the vehicle speed exceeds approximately 22 mph (35 km/h).

INFORMATION

■ Acoustic vehicle alerting system operating sounds

In the following cases, the acoustic vehicle alerting system may be difficult for surrounding people to hear.

- In very noisy areas
- In the wind or the rain

Predictive efficient drive (predictive deceleration support)^{*15}

This function operates based on the driving situation and traffic information of the road being driven on, helping to ensure excellent fuel economy. For details about Predictive efficient drive, refer to "MULTIMEDIA OWNER'S MANUAL".

When the vehicle approaches to predictive deceleration support points registered in the navigation system, the engine braking force will be increased according to the driving conditions to more efficiently charge the hybrid battery (traction battery) after the accelerator pedal is released.

^{*14}: The specified charge level in hybrid battery (traction battery) charge mode is approximately 80% of the fully charged level.

^{*15}: This function can only be used in the mainland U.S.A. It cannot be used in other states and territories, including Alaska and Hawaii.

Plug-in Hybrid system precautions

Take care when handling the hybrid system, as it is a high voltage system (about 650 V at maximum) as well as contains parts that become extremely hot when the hybrid system is operating. Obey the warning labels attached to the vehicle.

⚠ WARNING

■ High voltage precautions

This vehicle has high voltage DC and AC systems as well as a 12-volt system.

Observe the following, otherwise you may suffer burns or electric shock.

- Never touch, disassemble, remove or replace the high voltage parts, cables or their connectors.
- The hybrid system will become hot after starting as the system uses high voltage. Be careful of both the high voltage and the high temperature, and always obey the warning labels attached to the vehicle.
- Never try to open the service plug access hole located underneath the rear seats. The service plug is used only when the vehicle is serviced and is subject to high voltage.

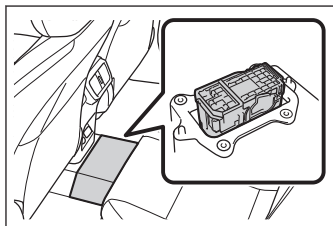

■ If the vehicle is involved in a collision

Observe the following.

- Stop the vehicle in a safe place to prevent subsequent accidents. While depressing the brake pedal, apply the parking brake and shift the shift position to P to stop the hybrid system. Then, slowly release the brake pedal.
- Do not touch the high voltage parts, cables and connectors.
- Never touch exposed electric wires. If electric wires are exposed inside or outside your vehicle, an electric shock may occur.
- Do not touch fluid, if attached to or leaking, as the fluid may be electrolyte of the hybrid battery (traction battery), which is organic electrolyte mainly consisting of carbonate ester.

If the electrolyte of the hybrid battery (traction battery), which is organic electrolyte mainly consisting of carbonate ester, comes into contact with your eyes or skin, it may cause blindness or injury to the skin. If it comes into contact with your eyes or skin, wash it off immediately with a large amount of water, and seek immediate medical attention.

WARNING

- If electrolyte is leaking from the hybrid battery (traction battery), do not approach the vehicle.
Even in the unlikely event that the hybrid battery (traction battery) is damaged, the internal construction of the battery will prevent a large amount of electrolyte from leaking out. However, any electrolyte that does leak out will give off a vapor. This vapor is an irritant to skin and eyes and could cause acute poisoning if inhaled.
- Do not bring burning or high-temperature items close to the electrolyte.
The electrolyte may ignite and cause a fire.
- If a fire occurs in the hybrid electric vehicle, leave the vehicle as soon as possible. Never use a fire extinguisher that is not meant for electric fires. Using even a small amount of water may be dangerous.
- If your vehicle needs to be towed, do so with the four wheels raised.
If the wheels connected to the electric motor (traction motor) are on the ground when towing, the motor may continue to generate electricity. This may cause a fire.
- Check the ground under the vehicle. If a liquid other than water from the air conditioning system is found, the fuel system may have been damaged.
Do not start the hybrid system. If it is started as is, the leaked fuel may ignite.
Leave the vehicle as soon as possible, and contact your Lexus dealer.

INFORMATION

Electromagnetic waves

- High voltage parts and cables on hybrid electric vehicles incorporate electromagnetic shielding, and therefore emit approximately the same amount of electromagnetic waves as conventional gasoline powered vehicles or home electronic appliances.
- Your vehicle may cause sound interference in some third party-produced radio parts.

Effect of magnetic forces

If objects that generate strong magnetic forces, such as large speakers, are placed inside the luggage compartment or installed nearby, the generated magnetic forces may negatively affect the hybrid system.

Refilling fuel

Plug-in hybrid electric vehicles can be driven using electricity charged from an external power source. However, as the gasoline engine is used depending on the situation even if in EV mode or AUTO EV/HV mode, and the gasoline engine is provided on board as a power source for driving in HV mode, it is needed to refueling the vehicle.

■ If the vehicle is not used for a long time

- The 12-volt battery may discharge. In this event, charge the 12-volt battery.

In order to prevent the hybrid battery (traction battery) from becoming extremely low in charge, charge the hybrid battery (traction battery) from external power source or start the hybrid system at least once every 2 or 3 months, and turn the power switch off after the gasoline engine has stopped automatically.

If the gasoline engine does not start up even after approximately 10 seconds have passed since the "READY" indicator came on, the power switch can be turned to off without any further action.

- When the vehicle is left with the AC charging cable connected, the electricity consumption amount of the 12-volt battery increases due to controls, such as the system checking, operating. When the AC charging cable is not needed, immediately remove it from the vehicle.

DC/DC converter air intake vent

There is an air intake vent under the rear seat for cooling the DC/DC converter. Blocking the air intake vent may prevent the plug-in hybrid system from operating properly.

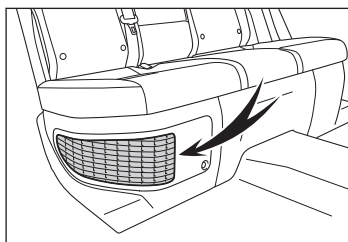

⚠ NOTICE

Observe the following precautions regarding the DC/DC converter air intake vent.

- Make sure not to block the air intake vent with anything, such as a seat cover, plastic cover, or luggage.

Blocking the air intake vent may prevent the plug-in hybrid system from operating properly.

- When dust etc. has accumulated in the air intake vent, periodically clean it with a vacuum cleaner to prevent the vent from clogging.
- Do not wet or allow foreign substances to enter the air vent as this may cause a short circuit and damage the DC/DC converter.
- A filter is installed to the air intake vent.

When the filter remains noticeably dirty even after cleaning the air intake vent, filter cleaning or replacement is recommended.

1-2. Important points for the plug-in hybrid system

— Related Links —

[Cleaning DC/DC converter air intake vent\(P. 571\)](#)

Plug-in hybrid electric vehicle driving tips

For economical and ecological driving, pay attention to the following points:

■ Using EV mode, AUTO EV/HV mode and HV mode effectively

Primarily using EV mode and AUTO EV/HV mode when driving in cities and using HV mode when driving on highways (or freeways) can help conserve fuel and electricity.

■ Using Eco drive mode

When using Eco drive mode, the torque corresponding to the accelerator pedal depression amount can be generated more smoothly than it is in normal conditions. In addition, the operation of the air conditioning system (heating/cooling) will be minimized, improving fuel and electricity economy.

■ Use of Hybrid System Indicator

The Eco-friendly driving is possible by keeping the indicate of Hybrid System Indicator within Eco area.

■ Changing the shift position

Shift the shift position to D when stopped at a traffic light, or driving in heavy traffic etc. Shift the shift position to P when parking. When using the N position, there is no positive effect on fuel consumption. In the N position, the gasoline engine operates but electricity cannot be generated. Also, when using the air conditioning system, etc., the hybrid battery (traction battery) power is consumed.

■ Accelerator pedal/brake pedal operation

- Drive your vehicle smoothly. Avoid abrupt acceleration and deceleration. Gradual acceleration and deceleration will make more effective use of the electric motor (traction motor) without having to use gasoline engine power.
- Avoid repeated acceleration. Repeated acceleration consumes hybrid battery (traction battery) power, resulting in poor fuel consumption. Battery power can be restored by driving with the accelerator pedal slightly released.

■ When braking

Make sure to operate the brakes gently and in a timely manner.

A greater amount of electrical energy can be regenerated when slowing down.

■ Delays

Repeated acceleration and deceleration, as well as long waits at traffic lights, will lead to high fuel and electricity consumption. Check traffic reports before leaving and avoid delays as much as possible. When driving in a traffic jam, gently release the brake pedal to allow the vehicle to move forward slightly while avoiding

1-2. Important points for the plug-in hybrid system

overuse of the accelerator pedal. Doing so can help control excessive electricity and fuel consumption.

■ Highway driving

- Control and maintain the vehicle at a constant speed. Before stopping at a toll booth or similar, allow plenty of time to release the accelerator and gently apply the brakes. A greater amount of electrical energy can be regenerated when slowing down.
- Electricity consumption will increase significantly when driving at high speeds in EV mode or AUTO EV/HV mode. If there will be a long distance to the next external charging point after leaving a freeway, it is recommended to drive in HV mode while on the freeway and change to EV mode or AUTO EV/HV mode after leaving the freeway.

■ Air conditioning

Turn the [A/C] switch off when it is not needed. Doing so can help reduce excessive electricity and fuel consumption.

In summer: When the ambient temperature is high, use the recirculated air mode. Doing so will help to reduce the burden on the air conditioning system and reduce electricity and fuel consumption as well.

In winter: Avoid excessive and unnecessary use of the heater. Usage of the heated steering wheel and seat heaters are effective.

■ Checking tire inflation pressure

Make sure to check the tire inflation pressure frequently. If there is improper tire inflation pressure in the tires, the EV driving range will become shorter, and fuel consumption when in HV mode will increase.

Also, as snow tires can cause large amounts of friction, their use on dry roads can lead to increased fuel and electricity consumption.

■ Luggage

Carrying heavy luggage will lead to poor fuel economy. Avoid carrying unnecessary luggage. Installing a large roof rack will also cause poor fuel economy.

■ Warming up before driving

Since the gasoline engine starts up and cuts out automatically, warming up is not necessary.

EV driving range

The EV driving range displayed on the multi-information display shows the reference distance that EV driving (driving using only the electric motor) is possible, and the actual distance that can be driven may differ from that displayed. Even if the EV driving range is displayed, EV driving may be canceled and both gasoline engine and electric motor are used depending on the situation.

The value displayed on EV driving range is estimated from the following information.

- The amount of hybrid battery (traction battery) charge currently remaining
- The electricity consumption (the estimated distance that EV driving is possible per unit of electrical energy) based on the recorded value
- Past air conditioning system electricity consumption amount

The electricity consumption varies depending on how the vehicle is driven. The vehicle automatically records the electricity consumption when being charged and uses the electricity consumption for estimating the EV driving range. Therefore, the EV driving range displayed when the hybrid battery (traction battery) is fully charged may differ from the previous EV driving range depending on how the vehicle was driven.

The EV driving range may change significantly with each charging until the electricity consumption based on the recorded value is stable (for approximately the first month or two). However, this does not indicate a malfunction.

As the power consumption becomes high when the air conditioning system is on, based on previous air conditioning system power consumption data, the EV driving range when the air conditioning system is operating will be estimated.

Tips for extending the EV driving range

The distance that EV driving is possible varies significantly depending on how the vehicle is driven, road conditions, the weather, the outside temperature, usage conditions of electrical components and the number of occupants.

The distance that EV driving is possible can be extended if the following is performed:

■ When starting off, accelerate using gradual accelerator pedal operation

As a guide, accelerate up to approximately 12 mph (20 km/h) in the first 5 seconds.

Electrical and fuel efficiency can be improved just by taking care to start off gently.

1-2. Important points for the plug-in hybrid system

When the driving mode is set to Eco drive mode, depressing the accelerator pedal generates smooth torque that makes it easier to operate the accelerator gently.

At the same time the air conditioning system will change to Eco air conditioning mode and the air conditioning system operation will become moderate.

■ **Maintain sufficient vehicle-to-vehicle distance to prevent unnecessary acceleration/deceleration**

Try to maintain a fixed speed while driving. Driving at a short vehicle-to-vehicle distance will result in repeating wasteful acceleration and deceleration, which will worsen the electrical and fuel efficiency.

■ **Release the accelerator pedal well before stopping**

The regenerative brake will operate to convert the kinetic energy of the vehicle into electrical energy, which will charge the hybrid battery (traction battery).

The regeneration status can be checked from the Hybrid System Indicator.

When the brake pedal is depressed lightly during deceleration, the regeneration amount increases, enabling more electrical energy to be recovered.

If the brake pedal is depressed too strongly, the recovered amount indicator will reach the maximum level and the upper limit of the recoverable energy will be exceeded. Therefore, be sure to operate the brake pedal early.

■ **Use the air conditioning system appropriately, and also utilize the heated steering wheel and seat heaters**

In EV mode, the vehicle is cooled and heated by electrical energy.*1

Preventing excessive cooling or heating of the vehicle will reduce power consumption and improve electrical efficiency.

The heated steering wheel and seat heaters are efficient heating device that directly warm the body using less electric power.

When used together with the air conditioning system, a low temperature setting can be used to improve electrical and fuel efficiency.

■ **Checking tire inflation pressure**

If the tire pressure is lower than the specified value, it will worsen the electrical and fuel efficiency.

A pressure level 7 psi (50 kPa, 0.5 kgf/cm² or bar) lower than the specified value will cause a worsening of several percentage points.

■ **Use HV mode when driving on highways**

The power consumption will increase significantly if the vehicle is driven in EV mode on highways.

*1: Except in extremely cold temperatures of approximately 14°F (-10°C) or less.

HV mode can be entered by operating the EV/HV mode selection switch.

■ Carry only necessary items

Driving with objects weighing 220 lb. (100 kg) in the vehicle will worsen the electrical and fuel efficiency by approximately 3%.

Air resistance also greatly affects electrical and fuel efficiency. Remove any exterior accessories such as a roof luggage carrier when they are not being used.

The running resistance of snow tires is high and they will worsen electrical and fuel efficiency. Replace them with standard tires as soon as they are no longer needed.

■ Understand power/fuel consumption

If you know your vehicle's daily electrical and fuel efficiency, you will understand the benefits of Eco drive.

Use the Power Consumption/Fuel Economy and other data displayed on the multi-information display.

Important points for charging the hybrid battery (traction battery) of the plug-in hybrid system

Make sure to read the following precautions before connecting the AC charging cable to the vehicle and charging the hybrid battery (traction battery).

INFORMATION

■ Safety functions

- The hybrid system will not start while the AC charging cable is attached to the vehicle, even if the power switch is operated.
- If the AC charging cable is connected while the "READY" indicator is illuminated, the hybrid system will stop automatically and driving will not be possible.

WARNING

■ Caution when charging

People with implantable cardiac pacemakers or cardiac resynchronization therapy-pacemakers should not carry out the charging procedure. Ask someone else to do it.

- Do not approach the charger and AC charging cable while charging. Charging procedure may affect the operation of such devices.
- Do not remain in the vehicle during charging. Charging procedure may affect the operation of such devices.
- Do not enter the vehicle even to take something out of the luggage compartment. Charging procedure may affect the operation of such devices.

■ When the AC charging cable is connected to the vehicle

Do not operate the shift lever. In the unlikely event that the AC charging cable has been damaged, the shift position may change from P to another position and the vehicle could move, possibly leading to an accident.

This vehicle can be connected to a standard household AC outlet in order to charge the hybrid battery (traction battery). However, it differs greatly from normal electric appliances as follows.

- When charging using a 240 V power source, a large amount of current will flow for a long time.
- Charging can be conducted outdoors.

Improper use may result in fire or electrocution. Read carefully and follow the correct charging procedure described in this manual.

Pay particular attention to the following:

- Do not allow children to use the AC charging cable without supervision. Also, keep the AC charging cable out of reach of infants.
- When charging with a charger, follow the procedures for using each charger.
- When charging using a public charging station, check the setting of the charging schedule function.
 - When the charging schedule is registered, temporarily turn off the function or turn [Charge now] on.
 - When the charging schedule is set to on, charging will not start even if the AC charging cable is connected. Also, charging fee may occur due to connection of the AC charging cable.

Related Links

[How to charge\(P.69\)](#)

Confirm the following before charging

Before charging, always check the following items.

- The parking brake is applied.
- Lights such as the headlights, emergency flashers and interior lights etc. are turned off.

If these light switches are turned on, then these features will consume electricity, and charging time will increase.

- The power switch is turned to OFF.
- Each part of the AC charging cable is in good condition.

INFORMATION

■ During charging

- The charging starting time may differ depending on the state of the vehicle, but this does not indicate a malfunction.
- Cooling fan sounds may be heard from near the rear seat.
- During charging, sounds may be heard from near the hybrid battery (traction battery) in accordance with the operation of the air conditioning system or traction battery cooler.
- During and after charging, the rear seat and its surrounding area in which the onboard traction battery charger is installed may get warm.
- The surface of the CCID (Charging Circuit Interrupting Device) may become hot, but this does not indicate a malfunction.
- Depending on radio wave conditions, interference may be heard on the radio.

1-3. Charging with the plug-in hybrid system

- The current charging condition and the estimated time until charging will complete can be checked on the multi-information display.

■ Capacity reduction of the hybrid battery (traction battery)

The capacity of the hybrid battery (traction battery) will decline gradually when the hybrid battery (traction battery) is in use. The rate at which it declines will differ in accordance with environmental conditions and the way in which the vehicle is used. Observing the following can help suppress battery capacity decline.

- Avoid parking the vehicle in areas with a high temperature under direct sunlight when the hybrid battery (traction battery) is fully charged.
- Avoid accelerating and decelerating frequently and suddenly when EV driving.
- Avoid frequent driving near the top speed for EV driving.
- Leave a low level of charge in the hybrid battery (traction battery) when leaving the vehicle undriven for a long period of time.

After confirming that EV mode or AUTO EV/HV mode has switched to HV mode, turn the power switch off.

- Use the charging schedule function as much as possible in order to fully charge the hybrid battery (traction battery) immediately before starting off.

Also, if the hybrid battery (traction battery) capacity reduces, the distance that can be driven in EV mode or AUTO EV/HV mode decreases. However, vehicle performance does not significantly become worse.

■ When the remaining charge of the hybrid battery (traction battery) is low after charging

In the following situations, the remaining charge of the hybrid battery (traction battery) after charging completes may be less than normal in order to protect the system (the EV driving range after the battery is fully charged may be shorter).^{*1}

- Charging is carried out when the outside temperature is low or high.
- Charging is carried out immediately after high-load driving or in extreme heat.

When none of the above situations apply and there is a drastic drop in the remaining charge of the hybrid battery (traction battery) after charging completes, have the vehicle inspected by your Lexus dealer.

■ When the charging amount sent to the hybrid battery (traction battery) decreases

When the amount of power supplied by the charger is low or operation of traction battery heater, etc., reduces the charging power sent to the hybrid battery (traction battery), the charging amount sent to the hybrid battery (traction battery) may decrease.

*1: When this occurs, even if the remaining charge display of the hybrid battery (traction battery) shows that it is fully charged, the remaining charge rapidly decreases faster than normal.

■ Certification

This device complies with Part 15 of the FCC Rules. Operation is subject to the following two conditions:

- (1) this device may not cause harmful interference, and
- (2) this device must accept any interference received, including interference that may cause undesired operation.

Plug-in hybrid system charging equipment

This vehicle features equipment for connecting to an external power source.

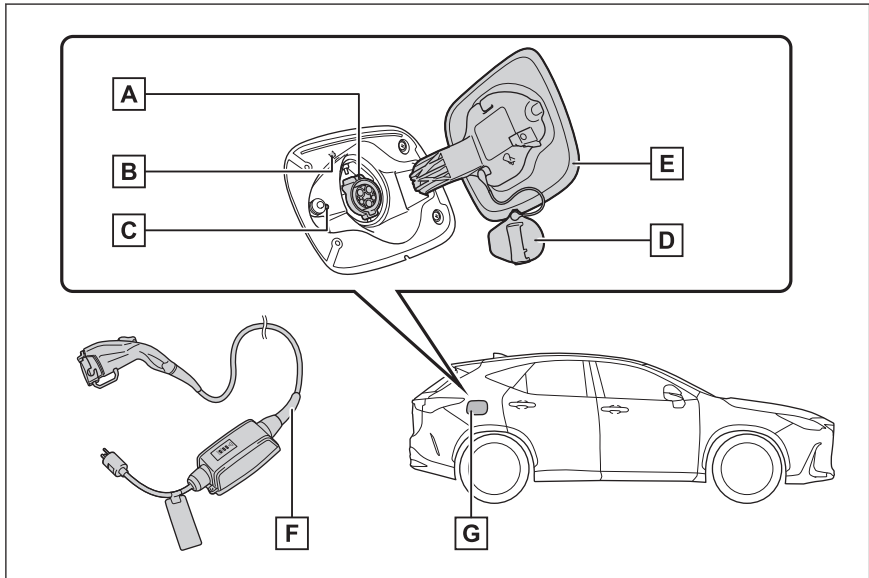

- A AC charging inlet
- B AC charging inlet light
- C Charging indicator
- D AC charging inlet cap
- E Charging port lid
- F AC charging cable
- G Charging port

Locking and unlocking the charging port lid and charging connector

The charging lid/connector can be locked, in order to prevent the inside of the charging lid from unwanted access, the charging connector from being removed, or the charging cable from being taken away. If the smart access system with push-button start or the wireless remote control does not operate properly, use the mechanical key.

Locking the charging port lid

Close the charging port lid and lock the doors using the smart access system with push-button start or wireless remote control.

The charging port lid will be locked.

INFORMATION

If the charging port lid is closed after the doors are locked, the lid will not be locked. In this case, close the lid and then lock the doors again.

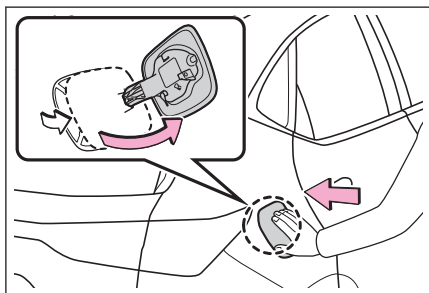
Unlocking the charging port lid

- 1 Unlock the doors using the smart access system with push-button start or wireless remote control.
- 2 Press the central rear edge of the charging port lid (the location shown in the illustration) and open it.

INFORMATION

If the charging port lid is closed when the doors are locked by the security function, the charging port lid will also be locked.

Locking the charging connector**NOTICE**

Observe the following when locking the charging connector. Failure to do so may cause the charging connector lock system to malfunction.

- Check that the charging connector is compatible with this vehicle.
A charging connector of the different type or a charging connector with damaged or deformed insertion part may not be locked.
- Do not apply excessive force to the charging connector after the charging connector is inserted.
When removing the charging connector, make sure to unlock the charging connector.

Insert the charging connector into the AC charging inlet.

When the charging connector is inserted, it will be locked automatically.

⚠ WARNING

Observe the following when connecting the charging connector to the AC charging inlet.

- Do not insert hand into the connector lock portion. A hand may be caught in the connector lock pin, resulting in an injury.

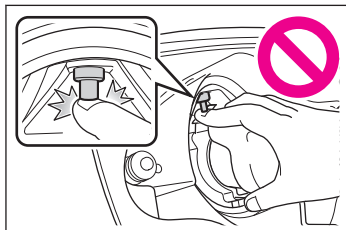

- Be careful not to touch the charging port lid lock portion. When the connector lock operates, the charging port lid lock will also operate. The charging port lid lock pin may hit a hand, resulting in an injury.

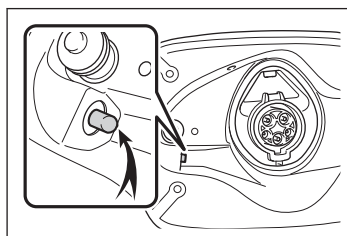

□ INFORMATION

■ Charging connector lock function

- The charging connector lock function does not guarantee that theft of the AC charging cable will be prevented, and is not necessarily effective for all mischiefs.
- If the AC charging connector is connected and disconnected repeatedly, the AC charging connector lock function may temporarily not work to protect the system. In this case, wait a short time before connecting the AC charging connector to the AC charging inlet again.

Unlocking the charging connector

Unlock the doors using the smart access system with push-button start or wireless remote control.

The charging connector will be unlocked

INFORMATION

■ Unlocking the charging connector using the smart access system with push-button start

If the charging connector is locked while the doors are unlocked, lock and then unlock the doors to unlock the charging connector.

■ Security function for unlocking

If a door or charging port lid is not opened within approximately 60 seconds after the vehicle is unlocked, the security feature automatically locks the lid again when the doors are automatically locked.

■ When the charging connector cannot be inserted into the AC charging inlet

Check that the connector lock pin is not lowered.

If the connector lock pin is lowered, the connector lock is operating. Unlock the doors using the smart access system with push-button start or wireless remote control and unlock the charging connector lock and check that the connector lock pin is not lowered.

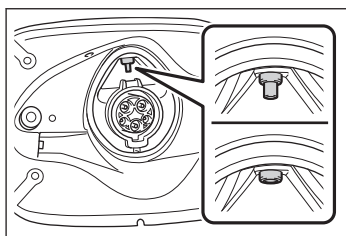

Changing the charging connector lock settings

The method for locking and unlocking the charging connector can be changed on the  screen on the center display.

- 1 Select .
- 2 Select [Vehicle customize].
- 3 Select [Charging].
- 4 Select [Connector lock] and then change the lock/unlock method to your preferred setting.

The charging connector lock/unlock method can be changed as follows.

Setting	Operation description
"Auto Lock" (Default setting)	The charging connector is automatically locked when the charging connector is connected.

1-3. Charging with the plug-in hybrid system

Setting	Operation description
"Auto Lock & Unlock"	The charging connector is automatically locked when the charging connector is connected and automatically unlocked when charging is completed.*1*2
"OFF"	The charging connector lock system does not operate.

INFORMATION

■ Changing the charging connector lock settings

The charging connector lock settings cannot be changed when the AC charging cable is connected to the vehicle.

— Related Links —

[Customizable features\(P. 765\)](#)

Opening the charging port lid

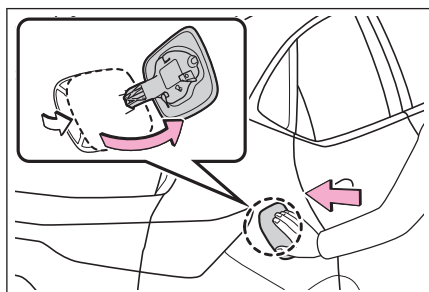

Unlock the charging port lid by unlocking the doors.

Press the central rear edge of the charging port lid (the location shown in the illustration) and open it.

Push and take your hand away to slightly open the charging port lid. Then open the lid fully by hand.

*1: The charging connector will be unlocked if power supply is interrupted due to a power outage etc. after the charging connector is automatically locked.

*2: The charging connector can be unlocked by similar operations to that of "Auto Lock" (Default setting).

Closing the charging port lid

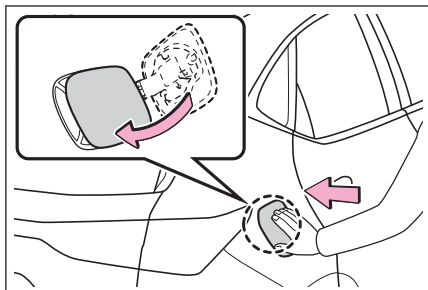

Close the charging port lid and press the central rear edge of the charging port lid (the location shown in the illustration).

When the doors are locked, the charging port lid is also locked.

Charging indicator

The illumination/flashing pattern changes to inform the user of the charging status in the following ways.

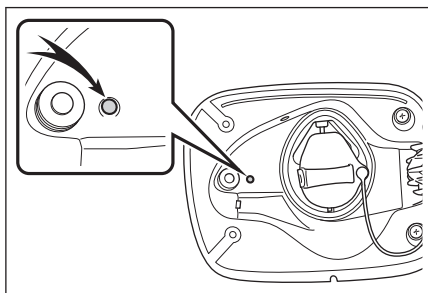

Illumination/flash- ing pattern	Vehicle condition
Illuminated	<ul style="list-style-type: none"> ● Charging is in progress ● Charging is possible ● Traction battery heater is operating ● Traction battery cooler is operating
Flashing (normal- ly) ^{*3}	When charging schedule is registered and AC charging cable is connected to vehicle
Rapidly flashing ^{*3}	When charging cannot be carried out due to malfunction in a power source or the vehicle etc.
Not illuminated	● Charging connector is not inserted into AC charging inlet

1-3. Charging with the plug-in hybrid system

Illumination/flash- ing pattern	Vehicle condition
Not illuminated	<ul style="list-style-type: none">● When the charging schedule is on standby● When charging is completed

INFORMATION

■ Charging indicator of the charging port

When a system malfunction occurs while charging, the charging indicator rapidly flashes for a certain period of time, and then turns off.

If this occurs, when a door is opened with the power switch off, a message is displayed on the multi-information display. When a message is displayed, follow the instructions displayed on the screen.

AC charging cable

The function, correct operating procedure, etc. of the AC charging cable are explained.

WARNING

Observe the following precautions when using the AC charging cable and CCID (Charging Circuit Interrupting Device).

- Do not attempt to disassemble or repair the AC charging cable, charging connector, plug or CCID (Charging Circuit Interrupting Device).

If a problem arises with the AC charging cable or the CCID (Charging Circuit Interrupting Device), stop charging immediately and contact your Lexus dealer.

- Do not subject the AC charging cable, charging connector, plug or CCID (Charging Circuit Interrupting Device) to strong force or impact.
- Do not apply excessive force to the AC charging cable by forcefully folding, twisting, pulling or dragging the AC charging cable.
- Do not damage the AC charging cable with sharp objects.
- Do not fold the charging connector or plug or insert foreign objects into them.
- Do not put the charging connector and plug into water.
- Do not bring the AC charging cable to a high-temperature item such as a heating device.

*3: Flashes for a certain period of time, and then turns off.

⚠ WARNING

- Do not apply a load to the AC charging cable and plug-cord (such as wrapping the AC charging cable around the CCID (Charging Circuit Interrupting Device) and the charging connector).
- Do not use or leave the AC charging cable in situations where a load is applied to the outlet and the plug (such as when the CCID (Charging Circuit Interrupting Device) is hanging in the air without contacting the ground).

⚠ NOTICE**■ Precautions when handling AC charging cable**

Make sure to observe the following precautions. Failure to observe these precautions may result in damage to the AC charging cable and AC charging inlet.

- Insert the charging connector straight into the AC charging inlet.
- After inserting the charging connector, do not apply excessive force to or twist the connector. Also, do not lean on the connector or hang any objects from it.
- Do not step on or trip over the AC charging cable.
- Before removing the charging connector, make sure that it is unlocked.
- After removing the AC charging cable, promptly return it to its proper location.
- After removing the charging connector, securely install the AC charging inlet cap.

■ Precautions for low temperatures

In low temperatures, the AC charging cable and plug-cord may become hard. Therefore, make sure to not apply excessive force when they are hard. If excessive force is applied to the hardened AC charging cable and plug-cord, they may be damaged.

■ The names of each part of the AC charging cable

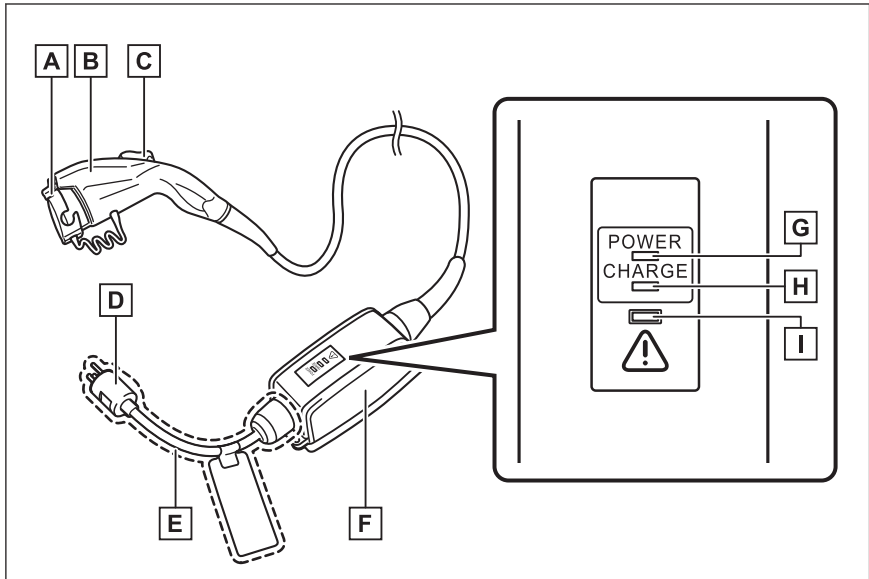

- A Charging connector cap
- B Charging connector
- C Latch release button
- D Plug
- E Plug-cord
- F CCID (Charging Circuit Interrupting Device)
- G Power indicator
- H Charging indicator
- I Error warning indicator

Inspecting and maintaining the AC charging cable

▲ WARNING

■ Routine inspection

Check the following points regularly.

Failure to do so may lead to an accident.

- The AC charging cable, plug, charging connector, CCID (Charging Circuit Interrupting Device) etc. have not been damaged.
- The outlet has not been damaged.
- The plug can be securely inserted into the outlet.

⚠ WARNING

- The plug does not get extremely hot during use.
- The tip of the plug has not been deformed.
- The plug is not dirtied by dust etc.

Remove the plug from the outlet before inspecting it. If any abnormalities are found in the AC charging cable as a result of the inspection, immediately stop use and consult your Lexus dealer.

■ Maintaining the AC charging cable

When the AC charging cable is dirty, first remove the dirt with a hard, wringed cloth, and then wipe the cable with a dry cloth.

However, never wash it with water. If the AC charging cable is washed with water, fire or electric shock may occur during charging.

■ When not using the AC charging cable for a long time

Remove the plug from the outlet. Dust could accumulate on the plug or in the outlet, possibly causing overheating which could lead to a fire.

Also, keep the cable in a place free from moisture.

Safety functions

The CCID (Charging Circuit Interrupting Device) has the following safety features.

■ Electrical leakage detection function

If an electrical leakage is detected during charging, the power source will be automatically interrupted, thus preventing fires or electrical shocks caused by electrical leakage.

If the power source is interrupted, the error warning indicator flashes.

■ Automatic check function

This is an automatic system check that is run before charging begins to check for problems in the operation of the electrical leakage detection function.

If a malfunction is found in the electrical leakage detection function as a result of the check, the error warning indicator flashes to inform the user.

■ Temperature detection function

A temperature detection function is equipped to the plug. While charging, if heat is generated due to looseness on the outlet side etc., this function suppresses heat by controlling the charging current.

■ Conditions for supplying current to the vehicle

The CCID (Charging Circuit Interrupting Device) is designed to prevent electrical current from being supplied to the charging connector when it is not connected to the vehicle, even if the plug is inserted into the outlet.

Operation of CCID (Charging Circuit Interrupting Device) indicators

■ Indicator operation

3 indicators are used to indicate the following conditions.

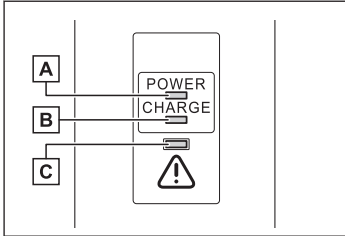

A Power indicator

Illuminates when electricity is flowing to the CCID (Charging Circuit Interrupting Device).

B Charging indicator

Illuminates when charging is in progress.

C Error warning indicator

Flashes when there is an electrical leakage or when a malfunction occurs in the CCID (Charging Circuit Interrupting Device).

Power sources that can be used

An external power source that fulfills the following criteria is necessary for charging this vehicle. Confirm this before charging.

▲ WARNING

■ Warnings for electrical faults

Make sure to observe the precautions in this Owner's Manual when charging the vehicle.

Failure to use a power source that fulfills the requirements, or failure to observe regulations while charging could lead to an accident.

■ Power sources precautions

Make sure to observe the following precautions regarding the use of an external power source.

- Connect to an AC 120 V outlet (NEMA 5-15R) with a Ground-Fault Circuit-Interrupter (GFCI) and supplied by a circuit breaker per your local code. Use of a 15 A individual circuit is strongly recommended.
- Do not connect the AC charging cable to a multi-socket adaptor, multi-plugs, or conversion plug.
- Connecting the AC charging cable to an extension cord is strictly prohibited.

⚠ WARNING

The extension cord may overheat and does not contain a Ground-Fault Circuit-Interrupter (GFCI). The leakage detection function of the CCID (Charging Circuit Interrupting Device) may not operate correctly.

- Do not connect to a branch electrical socket.

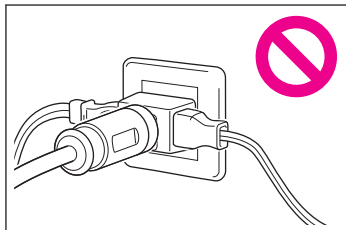

- Make sure to connect the charging connector and AC charging inlet directly.

Do not connect a converting adaptor or extension cord between the charging connector and AC charging inlet.

- Connect to an AC 120 V outlet (NEMA 5-15R) with a Ground-Fault Circuit-Interrupter (GFCI) and a circuit breaker. Use of a 15 A individual circuit is strongly recommended to ensure AC charging cable will operate properly.
- When charging outdoors, make sure to connect to a weatherproof outlet that is certified for outdoor use. Checking Ground-Fault Circuit- Interrupter (GFCI) operation before its use is recommended.

□ INFORMATION**■ The charging environment**

For safe charging, the following charging equipment and settings are recommended.

- Weatherproof outlet

When charging outdoors, connect the plug to a weatherproof outlet, and ensure that the plug remains waterproof while the plug is connected.

- Dedicated circuit

- To reduce the risk of fire, connect only to an at least 15 A branch circuit with an over-current protection in accordance with the National Electric Code, ANSI/NFPA 70.
- To reduce the risk of electric shock when working with the plug, connect to a outlet with a Ground-Fault Circuit-Interrupter (GFCI) or that has an Earth Leakage Circuit Breaker installed.

Sockets that can be connected

The plug is designed to be connected to a NEMA 5-15R outlet.

The illustration is an example shown for demonstration purposes, and may differ from the actual configuration.

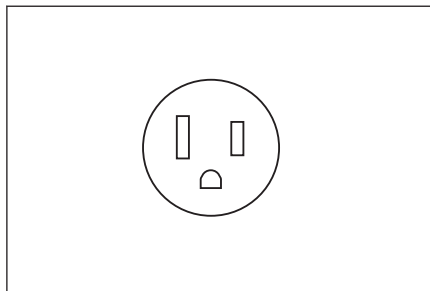

Preventing the circuit breaker from tripping during charging

When your circuit breaker trips during charging, the upper limit of the charging current can be changed in [Vehicle customize] on the center display.^{*4*5}

- 1 Select  on the center display.
- 2 Select [Vehicle customize].
- 3 Select [Charging].
- 4 Select [Charging current].
- 5 Select [16A]^{*6} or [8A] on the charging current screen, and then press [OK].

During charging, the maximum charging current will be restricted to the set current or lower.^{*7}

If the breaker still trips while charging, even after changing the upper limit of the charging current, check if the connected power source meets the specified charging conditions.

Related Links

[Customizable features\(P. 765\)](#)

*4: The maximum charging current cannot be changed when the power switch is in ACC.

*5: If the power supply of the AC charging stand being used has been adjusted or depending on the AC charging cable being used, the supplied current may be lower than the set maximum charging current.

*6: Vehicles with 7 kW onboard traction battery charger only

*7: Restricting the charging current will lengthen the charging time.

Charging the hybrid battery (traction battery) of the plug-in hybrid system

This section explains the procedure for charging the hybrid battery (traction battery) with the equipped AC charging cable. When using a charging station, make sure to check the operation instructions on the AC charger. When the charging schedule is registered, make sure [Charge now] is turned on before charging.

Charging methods

The following methods can be used to charge the hybrid battery (traction battery).

■ Charging from an external power source

This is a charging method used when charging from an AC outlet (120 V) with the AC charging cable equipped to the vehicle or charging at a public charging station.

The charging start time (or departure time) and day can be set to carry out charging using the charging schedule at the desired date and time.

■ Using the hybrid battery (traction battery) charge mode

The plug-in hybrid system can be switched to hybrid battery (traction battery) charge mode to charge the hybrid battery (traction battery) using electricity generated by gasoline engine operation.

The maximum charge amount in the hybrid battery (traction battery) charge mode is approximately 80% of the fully charged capacity for the charging from an external power source.

INFORMATION

■ Using a DC Charger

DC Chargers cannot be used with this vehicle.

■ Charging electricity

This vehicle can be charged up to approximately 3.5 kW or 7 kW*1.

However, depending on the used charger or AC charging cable, charging electricity may be limited.

Estimated charging time

The time required to charge the hybrid battery (traction battery) differs according to the charging voltage and charging current.

*1: Vehicles with 7 kW onboard traction battery charger only

1-3. Charging with the plug-in hybrid system

- Home power source
 - Charging voltage: AC 120 V
 - Charging current^{*2}: 12 A
 - Estimated charging time^{*3*4}: Approximately 12 hours
- AC charger (vehicles with 3.5 kW onboard traction battery charger)
 - Charging voltage: AC 240 V
 - Charging current^{*2}: 16 A
 - Estimated charging time^{*3*4}: Approximately 4 hours 30 minutes
- AC charger (vehicles with 7 kW onboard traction battery charger^{*})
 - Charging voltage: AC 240 V
 - Charging current^{*2}: 32 A
 - Estimated charging time^{*3*4}: Approximately 2 hours 30 minutes

INFORMATION

■ Charging time may increase

In the following situations, charging time may become longer than normal:

- In very hot or very cold temperatures.
- When the hybrid battery (traction battery) becomes hot, such as immediately after high-load driving.
- The vehicle is consuming a lot of electricity, for example, when the headlights are on etc.
- When using My Room Mode.
- There is a power outage during charging.
- There is an interruption in the electrical supply.
- There is a drop in the voltage of external power source.
- The charge in the 12-volt battery is low, for example due to the vehicle being left unused for a long period of time.

*: If equipped

*2: This is the maximum value. Furthermore, the upper limit of the charging current can be changed in [**Vehicle customize**].

*3: The time required to complete charging depends on conditions such as the remaining charge of the hybrid battery (traction battery), the outside temperature and specifications of a charger (charging station).

*4: When using My Room Mode, the time required for charging to complete may be longer or the charging may not be completed.

- The maximum charging current is set to 8 A or 16 A*⁵ through [Vehicle customize].
- When the traction battery heater operates.
- When the traction battery cooler is operated before charging.
- When the plug generates heat due to a loose socket connection etc.

Charging-linked functions

This vehicle is equipped with several functions that are linked with charging.

■ My Room Mode

When the AC charging cable is connected to the vehicle, electrical components such as the air conditioning system or audio system can be used using the external power source*⁶.

■ Traction battery heater

When the outside temperature is low and the AC charging cable is connected to the vehicle, this function automatically warms the hybrid battery (traction battery) until it reaches or exceeds a certain temperature.

Traction battery heater will operate when the [Battery warming] of the [Charging] on the center display is on.

■ Traction battery warming control (Alaska and Canada only)

This control operates after the AC charging cable remains connected to the vehicle for 3 days and traction battery heater automatically stops. It automatically insulates the hybrid battery (traction battery) in extremely low temperatures.

■ Traction battery cooler

When the hybrid battery (traction battery) is hot and the AC charging cable is connected to the vehicle, this function cools the hybrid battery (traction battery) before charging is carried out.

- Traction battery cooler will operate when the [Battery cooling] of the [Charging] on the center display is on.
- When the charging voltage is 120 V, the function does not operate.

*⁵: Vehicles with 7 kW onboard traction battery charger only

*⁶: The power of the hybrid battery (traction battery) may be used depending on the situation.

INFORMATION

■ **Traction battery heating and cooling system (traction battery heater and traction battery cooler)**

- The system operates when the hybrid battery (traction battery) is below or above a certain temperature.
- The system may operate when charging is not being performed.
- When the charging schedule is used, this function will operate according to the charging schedule.

■ **Traction battery heater**

- When traction battery heater is operating, the charging indicator illuminates.
- When the AC charging cable is removed from the vehicle or remains connected to the vehicle for approximately 3 days, the system automatically stops.
- When traction battery heater is operating during charging, the charging time may be longer than normal.
- If the outside temperature becomes high while traction battery heater is operating, charging may complete earlier than the [**Departure time**] set.
- When the following operations are performed while traction battery heater is operating, the heating operation stops.
 - The shift position is changed to any position other than P
- Traction battery heater may operate even when the hybrid battery (traction battery) is fully charged depending on the temperature of the hybrid battery (traction battery).
 - The remaining charge of the hybrid battery (traction battery) decreases when traction battery heater operates. The charging operation may start again to charge the hybrid battery (traction battery).
 - "**Charging Stopped Due to Pulled Charging Connector**" may be shown when the charging connector is removed while recharging.

■ **Traction battery cooler**

- The charging indicator is illuminated while traction battery cooler is on standby or operating.
- Traction battery cooler is implemented for a maximum of approximately 30 minutes. However, when the [**Departure time**] is set and there is not sufficient time between the current time and the time that charging will complete, traction battery cooler operation time may become shorter.
- When there is a small amount of remaining charge in the hybrid battery (traction battery), even if the hybrid battery (traction battery) is hot, traction battery cooler may not be implemented.

- When the traction battery is almost completely charged, traction battery cooler may not be implemented.
- When the following operations are performed while traction battery cooler is operating, the hybrid battery (traction battery) cooling operation stops.
 - The hood is opened
 - The power switch is turned to any mode other than off
 - [Charge now] is implemented
- Traction battery cooler uses the power of the hybrid battery (traction battery) and external power source.
 - While traction battery cooler is operating, the amount of the remaining charge of the hybrid battery (traction battery) increases and decreases in a certain range, and does not increase as in normal charging.
 - The operation of traction battery cooler is recognized as charging by a charger. The charger that calculates the fee according to charging time causes a charging fee.

Related Links

[My Room Mode mode function and operation\(P. 86\)](#)

[Customizable features\(P. 765\)](#)

Charging tips

This section explains methods for using the charging function for this vehicle and checking information related to charging.

To enable the use of EV mode or AUTO EV/HV mode, we recommend systematically charging the vehicle.

■ Before leaving home

In order to use EV mode or AUTO EV/HV mode, charge the hybrid battery (traction battery) at home before leaving.

The charging schedule function can be used to set the system to automatically fully charge the hybrid battery (traction battery) before your desired departure time.

■ At your destination

Use a public charging station to charge the hybrid battery (traction battery). If there are no public charging stations at your destination, the hybrid battery (traction battery) can be charged using the hybrid battery (traction battery) charge mode.*7

■ After returning home

In order to drive the next time, charge the hybrid battery (traction battery).

Setting the charging schedule allows you to charge the hybrid battery (traction battery) at the desired time such as late at night or early in the morning. Furthermore, the charging schedule can be set to automatically charge the hybrid battery (traction battery) every day or at the same time on certain days.

Checking information related to charging

Information related to charging is displayed and can be checked on the multi-information display.*8

■ While charging

When any door is opened with the power switch off, the current charging condition and approximate time remaining until charging is complete are displayed for a certain period of time.



□ INFORMATION

■ Multi-information display during charging

If approximately 100 seconds elapse after the power switch is turned to ON during charging, the power switch will automatically turn off and the display will disappear.

■ After charging is complete

When any door is opened with the power switch off after charging is complete, a message detailing the results of the charging is displayed for a while. Also, a message is displayed if an operation that stops charging is performed or a situation where charging cannot be performed occurs.

When a message is displayed, follow the instructions displayed on the screen.

*7: When using the hybrid battery (traction battery) charge mode while parked, make sure that no flammable objects are near the vehicle and the vehicle is parked in a well-ventilated area.

*8: Various information related to charging can also be checked remotely.

 INFORMATION**■ The following indicate that charging has been carried out properly.**

The following indicate that charging has been carried out properly.

- The charging indicator of the charging port turns off
- **"Charging Complete"** is displayed on the multi-information display when a door is opened with the power switch off.

Regardless of the type of power source or whether the charging schedule function is used, charging is completed if the above can be confirmed.

How to charge**▲ WARNING****■ When charging**

Failure to do so may cause an unexpected accident.

- Connect to a power source suitable for charging.
- Check that the AC charging cable, plug and socket are free of foreign matter.
- Before charging, check that the AC charging inlet is not deformed, damaged or corroded, and check that the inlet is free of foreign matter such as dirt, snow and ice.
If there is dirt or dust in these areas, remove completely before inserting the charging connector.
- Do not get the terminals of the AC charging inlet wet.
- Only use sockets where the plug can be securely inserted.
- Do not bundle or wind the AC charging cable while charging, as doing so may result in overheating.
- Do not touch the terminals of the charging connector or AC charging inlet with your hands or sharp metal objects, such as wire, or short them with anything.
- When charging outdoors, make sure to connect to a rain-tight socket for outdoor use.
Ensure the rain-tight cover closes completely. If the rain-tight cover cannot be closed, install a rain-tight cover that will close.
- In order to stop charging at the charging station, follow the instructions of the charger.
- If any heat, smoke, odors, noise or other abnormalities are noticed during charging, stop charging immediately.
- Do not insert the plug if the socket is submerged in water or snow.
- When charging while it is raining or snowing, do not connect or disconnect the plug if your hands are wet. Also, do not get the plug or outlet wet.
- Do not charge the vehicle during a lightning storm.

WARNING

- Prevent the AC charging cable from being caught in the door or back door.
- Do not let the wheels on the AC charging cable, plug, charging connector and CCID (Charging Circuit Interrupting Device).
- Firmly insert the plug into the socket.
- Do not use an extension cord and converting adaptor.
- Close the hood before using the charging system.

The cooling fan may start operating suddenly. Touching or getting close to rotating parts such as the fan may cause your hands or clothes (especially a necktie or scarf) to become caught and result in a serious injury.

- If the power indicator on the CCID (Charging Circuit Interrupting Device) does not illuminate after plugging the AC charging cable into the socket outlet, unplug it immediately.
- After connecting the charging cable, confirm that it is not wound around anything.

If the error warning indicator on the CCID (Charging Circuit Interrupting Device) illuminates or flashes during charging

There may be an electrical leakage in the power source path, or there may be a malfunction in the AC charging cable or CCID (Charging Circuit Interrupting Device).

Refer to → P.709 and follow the correction procedure. If the error warning indicator does not turn off even after performing the correction procedure, immediately stop charging, remove the AC charging cable and contact your Lexus dealer. Continuing to charge the vehicle in that condition may lead to unforeseen accidents or serious injury.

Onboard traction battery charger

The onboard traction battery charger is located under the rear seats. Make sure to observe the following precautions regarding the onboard traction battery charger. Failure to observe these precautions may result in death or serious injury such as burns and electric shocks.

- The onboard traction battery charger is hot during charging. Do not touch the onboard traction battery charger, as doing so may result in burns.
- Do not disassemble, repair or modify the onboard traction battery charger. When the onboard traction battery charger needs to be repaired, consult your Lexus dealer.

NOTICE

When using the AC charging cable and related parts

To prevent damage to the AC charging cable and related parts, observe the following precautions.

⚠ NOTICE

- When interrupting or canceling charging, remove the charging connector before removing the plug.
- When removing the AC charging cable, check that the charging connector is unlocked.
- Do not forcefully pull the charging connector cap and AC charging inlet cap.
- Do not apply a vibration to the charging connector while charging.
Charging may be stopped.
- Do not insert anything but the charging connector into the AC charging inlet.
- When inserting the plug into or removing the plug from the socket, make sure to hold the body of the plug.
- Do not damage the AC charging inlet cap with a sharp object.
- Do not forcefully pull the AC charging cable that is caught or entangled.
If the cable is entangled, disentangle it before using.
- Do not disassemble, repair or modify the AC charging inlet.
When the AC charging inlet needs to be repaired, consult your Lexus dealer.

■ When charging

Do not insert the plug into the AC charging inlet.

The AC charging inlet may be damaged.

■ Using private power generator

Do not use private power generators as a power source for charging.

Doing so may make charging unstable, the voltage may be insufficient, and the error warning indicator on the CCID (Charging Circuit Interrupting Device) of the AC charging cable may flash.

■ Charging station

Due to the environment in which the power equipment is located, charging may be unstable due to noise, the voltage may be insufficient, and the error warning indicator on the CCID (Charging Circuit Interrupting Device) of the AC charging cable may flash.

■ Onboard traction battery charger cooling air intake vent

Cooling air intake vent for the onboard traction battery charger is installed under the rear seats. Make sure to observe the following precautions regarding the cooling air intake vent. Failure to observe these precautions may result in a charging system malfunction.

NOTICE

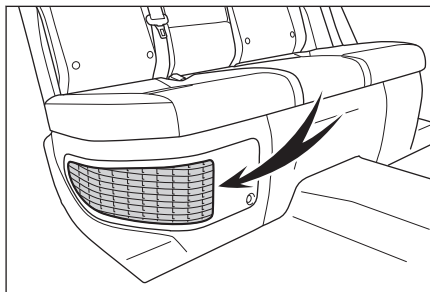

- Do not block the air intake vent with seat covers or luggage
- If the air intake vent is clogged with dust, clean it with a vacuum cleaner
- Do not allow water or foreign matter to enter the air intake vent
- Do not spill large amounts of water near the air intake vent

If water is spilled, have the vehicle inspected by your Lexus dealer and do not charge the hybrid battery (traction battery) before the inspection.

INFORMATION

■ Safety function

If the latch release button is pressed, charging will not begin even if the AC charging cable is connected.

Also, charging will be stopped if the latch release button is pressed and held for several seconds during charging. When restarting charging, reinsert the charging connector after pulling it out, and check that the charging indicator of the charging port illuminates.

■ Protection function of AC charging inlet overheating (vehicles with 7 kW onboard traction battery charger)

By installing a temperature sensor to the AC charging inlet, prevents parts from melting when the temperature rises due to foreign matter entering the AC charging connector. When a certain temperature increase is detected, charging is stopped immediately and a message is displayed on the multi-information display. After the temperature has decreased, charging resumes by performing the operation to start charging again.

■ When the outside temperature is low or high

The level shown on the SOC (State of Charge) gauge may drop slightly when the power switch is turned to ON, even if charging has been completed and the hybrid battery (traction battery) is fully charged. However, this does not indicate a malfunction.

Starting charging

- 1 Prepare the AC charging cable.

2 Insert the AC charging cable into the outlet of the external power source.

Make sure to hold the body of the plug and insert it firmly into the outlet.

Check that the power indicator on the CCID (Charging Circuit Interrupting Device) is illuminated.

In order to reduce the load on the electrical socket and plug, when inserting the plug, use a string, etc., to hang the CCID (Charging Circuit Interrupting Device) on a hook or equivalent.

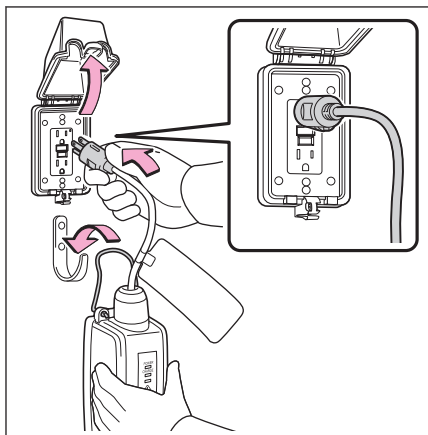
**3 Unlock the doors and push the charging port lid to open it.**

The AC charging inlet light **A** will illuminate.

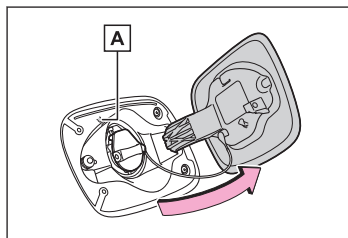
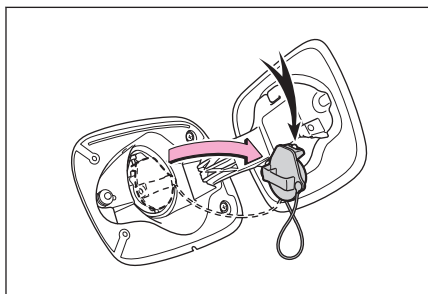
**4 Remove the AC charging inlet cap and secure it into the holder on the charging port lid.****5 Remove the AC charging connector cap and secure it to the cable.**

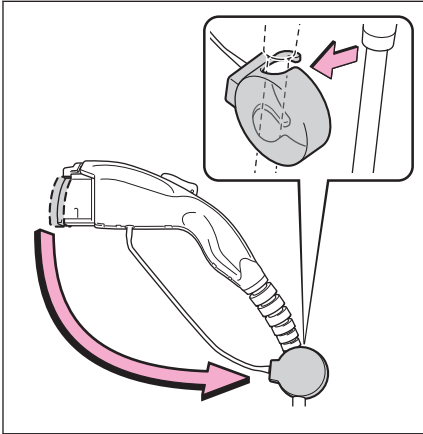

6 Insert the charging connector into the AC charging inlet.

Align the guide position on the bottom of the charging connector, and push the charging connector straight into the AC charging inlet as far as possible.

Once a click sound is heard, check that the charging connector is securely locked.

When the charging connector is inserted straight as far as possible, it will automatically lock.

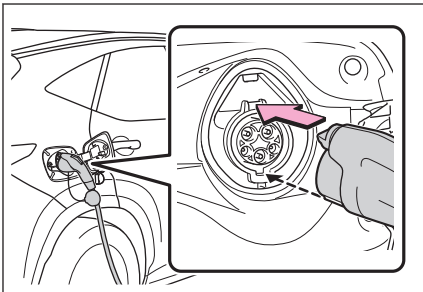

7 Confirm that the charging indicator of the charging port is illuminated.

Charging will not start if the charging indicator does not illuminate when the charging connector is inserted.

If the charging indicator is flashing, the charging schedule is registered.

The charging indicator will turn off when charging is completed.

The charging indicator will also turn off when charging is interrupted.

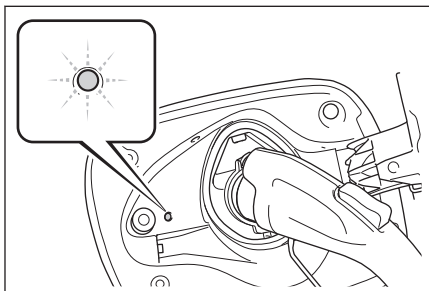

INFORMATION

■ If the charging indicator of the charging port flashes after connecting the AC charging cable

The charging schedule is registered and charging cannot be performed. To cancel charging using the charging schedule and start charging, perform any of the following procedures.

- Turn [Charge now] ON
- When the connected charging connector is removed then reconnected within approximately 5 seconds

■ While charging

When the power switch is turned to ON and the energy monitor is displayed on the center display, the AC charging connector is displayed on the energy monitor and the flow of electricity during charging is displayed.

Handling the charging cable after charging has completed

1 Unlock the doors to unlock the charging connector.

The charging connector will be unlocked and the AC charging inlet light will illuminate when the doors are unlocked.

2 Pull the charging connector towards you while pressing the latch release button.

If the latch release button is pressed during charging (while the charging indicator is illuminated), charging will be interrupted.

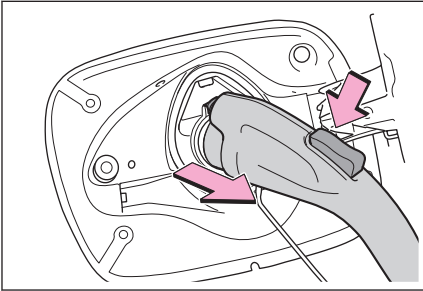

INFORMATION

■ When removing the charging connector

Press the latch release button, check that the lever raises up, and then pull the charging connector towards you.

If the lever does not raise up even after the latch release button is pressed, the charging connector is locked. If this occurs, unlock the doors using the smart access system with push-button start or wireless remote control to unlock the charging connector.

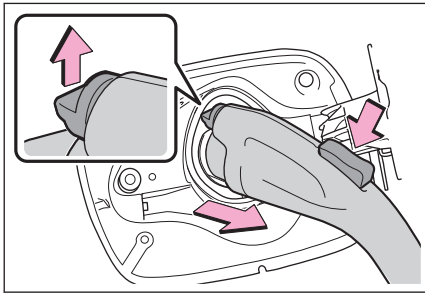

3 Attach the charging connector cap.

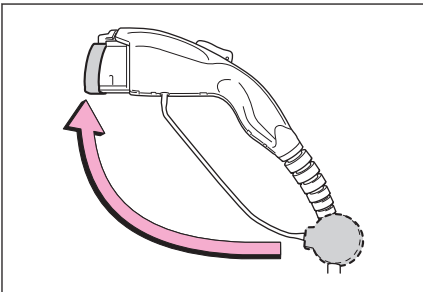

4 Attach the AC charging inlet cap and close the charging port lid.

Lock the doors to lock the charging port lid.

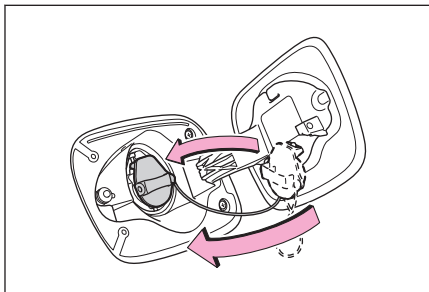

5 Remove the plug from the outlet when the charging equipment will not be used for a prolonged period of time.

Hold the body of the plug when removing.

Make sure to put the cable away immediately after disconnecting.

When leaving the plug inserted, inspect the plug and connector once a month to check if dirt or dust has accumulated.

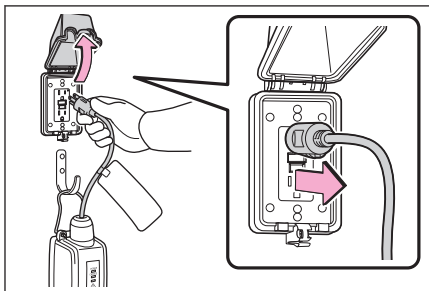

⚠ WARNING

Remove the plug if it will not be used for a long time. Dirt and dust may accumulate plug or outlet, which could cause a malfunction or fire, possibly leading to death or serious injury.

⚠ NOTICE

- Store the AC charging cable out of reach from infants and children.
- After disconnecting the charging connector from the AC charging inlet, make sure to put on the AC charging inlet cap and close the charging port lid. If the AC charging inlet cap is not put on, water or foreign objects may enter the AC charging inlet, which could lead to vehicle damage.
- After removing the plug from the outlet, keep it in a safe place free from moisture and dust. The AC charging cable or plug may be damaged if the cable is stepped on or ridden over by the vehicle.

Useful plug-in hybrid system charging functions

Charging schedule function and operation

Charging can be carried out at the desired time by registering the charging schedule on the center display^{*1}. Also, it is possible to set the charging schedule to one's preferences, such as having charging complete by a certain departure time or be carried out at the same time on certain days.

When registering the charging schedule, the following settings can be changed.

■ Select the charging mode

Charging modes can be selected.

● [Start at set time]

Starts charging at the set time^{*2*3} and finishes charging when fully charged.

● [Departure time]

Starts charging to finish at the set time.^{*4*5}

■ [Repeat] setting

The periodic charging schedule can be set by selecting your desired day of the week.

If no days are selected, charging is only carried out once.

■ Turning [Charge now] on and off

If even one charging schedule is registered, charging does not start until the set time, even if the AC charging cable is connected to the vehicle. To start charging without changing the charging schedule setting, turn [Charge now] on

*1: For details on how to operate the center display screen, refer to "MULTIMEDIA OWNER'S MANUAL".

*2: There might be a slight error in the timing when charging starts due to the state of the hybrid battery (traction battery).

*3: Charging schedule function is performed in accordance with the clock in the multi-information display. Before registering the charging schedule, check the clock settings to the proper time.

Before registering a charging time to the charge schedule, make sure that [Set time automatically] on the center display is turned on.

*4: When the system determines that there is no time to finish charging by the set scheduled departure time, it starts charging. Check the charging schedules.

*5: If sudden changes in temperature or changes in the condition of the power source occur while charging, charging may not end exactly at the time estimated by the system.

to temporarily cancel the charging schedule and enable charging after connecting the AC charging cable.*6*7

WARNING

When performing the setting operation while the hybrid system is operated, ensure that the vehicle is parked in a place with adequate ventilation. In a closed area such as a garage, exhaust gases including harmful carbon monoxide (CO) may collect and enter the vehicle. This may lead to a serious health hazard.

NOTICE

To prevent 12-volt battery discharge, ensure that the hybrid system is operating while setting up the display features.

INFORMATION

Calendar settings

The current date and time is automatically set using GPS. However, if the automatic setting of the clock is turned off on the center display, it will be necessary to manually set the date and time. For details, refer to the "MULTIMEDIA OWNER'S MANUAL".

If the calendar information is wrong, the charging schedule function will not operate normally.

Charging schedule

- The charging schedule cannot be set while driving.
- A maximum of 15 charging schedules can be registered.

To make sure that the charging schedule function operates correctly

Check the following items.

- Adjust the clock to the correct time *8
- The calendar is set to the correct date *8
- Check that the power switch is turned off
- After registering the charging schedule, connect the AC charging cable

The charging start time is determined based on the charging schedule at the time that the AC charging cable was connected.

*6: [Charge now] can also be turned on/off on the multi-information display.

*7: If the charging connector is disconnected when the charging schedule is set and [Charge now] is on, [Charge now] will turn off.

*8: For the setting procedure for the clock and calendar, refer to the "MULTIMEDIA OWNER'S MANUAL".

1-3. Charging with the plug-in hybrid system

- After connecting the AC charging cable, check that the charging indicator of the charging port flashes
- Do not use a socket that has a power cut off function (including a timer function)

Use a socket that constantly supplies electricity. For sockets where the power is cut off due to a timer function, etc., charging may not be carried out according to plan if the power is cut off during the set time.

■ When the AC charging cable remains connected to the vehicle

Even if multiple consecutive charging schedules are registered, the next charge will not be carried out according to the charging schedule until the AC charging cable is removed and reconnected after charging completes. Also, when the hybrid battery (traction battery) is fully charged, charging according to the charging schedule will not be carried out.

■ Smartphone link

It may be necessary to use a smartphone with a dedicated app to change the next charging schedule.

■ When charging schedule setting operations are canceled

When the vehicle is in the following conditions, charging schedule setting operations are canceled.

- The power switch is turned off before the settings are confirmed
- The vehicle starts off
- A display with a higher priority than that of the charging schedule setting is shown

■ When charging schedules are ignored

When the following operations are performed while the charging schedule is on standby, charging schedule is temporarily canceled and charging is started.

- When turning My Room Mode on
- When turning [Charge now] on
- When an operation that temporarily cancel charging using the charging schedule

■ Effects of outside temperature

When the charging mode is set to [Departure time], charging schedule may be ignored due to the outside temperature and charging may start.

■ Traction battery heater/Traction battery cooler

When charging is carried out using the charging schedule, the hybrid battery (traction battery) heating or cooling function may operate according to the temperature of the hybrid battery (traction battery).

- When the charging mode is set to [Start at set time], the function starts at the set charging start time.

- Traction battery heater: When the charging mode is set to [Departure time], the function starts automatically to complete heating by the desired departure time.
- Traction battery cooler: When the charging mode is set to [Departure time], cooling starts approximately 30 minutes before the charging start time. However, if there is no time to finish charging by the charging schedule, the hybrid battery (traction battery) cooling time may be shortened and traction battery cooler may not operate.

Displaying the charging schedule screen on the center display

Setting operations related to the charging schedule are performed on the charging schedule screen.

- 1 With the power switch in ON, select  on the center display.*9
- 2 Select [Charging schedule].

The charging schedule screen will be displayed.



How to read the charging schedule screen on the center display

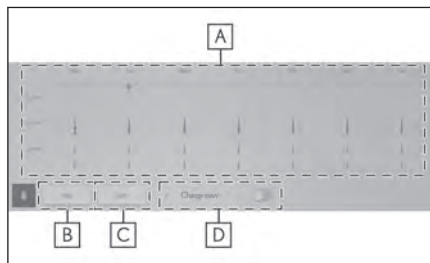

- A** Charging schedules

Displays the week-long registered charging schedule in a list using icons.

- B** [Add] switch

Select to add a new item to the charging schedule.

- C** [Edit] switch

Select to change or delete registered items on the charging schedule.

*9: Charging schedule settings cannot be changed when the power switch is in ACC.

D [Charge now] switch

Select to [Charge now] to on.

The following content is displayed on the calendar.

Display	Content
Gray line *10	Current time
Green icon	The charging mode is set to [Departure time].
Blue icon	The charging mode is set to [Start at set time].

It may be necessary to use a smartphone with a dedicated app to change the next charging schedule.

When [Charge now] is set to on, the icon moves to the position of the gray line.

Registering the charging schedule on the center display

1 Display the charging schedule screen.

2 Select [Add].

The edit charging event screen will be displayed on the screen.

3 Change the schedule to the desired time.

► Charging mode

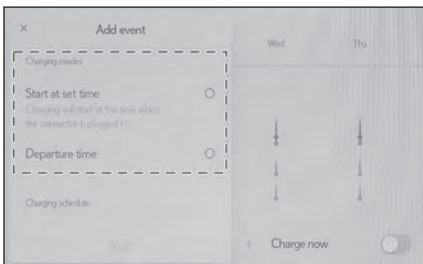

Select [Start at set time] or [Departure time] to set the desired charging mode.

When [Start at set time] is selected:

Set the time to start charging (start time) and then select [OK].

[Departure time] is selected:

Set the time which you would like charging to end (departure time) and then select [OK].

*10: A row with a ash line indicates the current time.

► [Repeat] setting

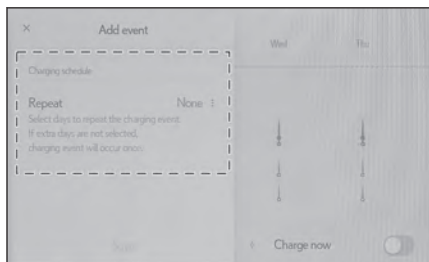

Charging will be repeated for the set day(s) on the charging schedule. It is possible to turn more than one day on.

If no days are selected, charging is only carried out once according to the charging schedule for the next 24 hours.

4 After setting operations are complete, select [Save].

The charging schedule is registered and an icon is added to the calendar.

To cancel registration of the charging schedule, select **X**.

After setting operations are complete, when the power switch is turned off and the AC charging cable is connected to the vehicle, charging is carried out according to the charging schedule settings.

INFORMATION

■ When a charging schedule has been registered

When all the items in the charging schedule are turned off, icons are not displayed on the charging schedule screen. The icons will be displayed when they are set to on using the scheduled events screen.

Switching charging schedules between on and off on the center display

1 Display the charging schedule screen.

2 Select [Edit].

The scheduled events screen will be displayed on the screen.

3 From the items displayed on the screen, select or in the row of the charging schedule you wish to change.

If the charging schedule you wish to change is not displayed on the screen, scroll the list up and down to display it.

Each time the switch is selected, Charging Schedule will turn on/off.

Changing the registered charging schedules on the center display

- 1 Display the charging schedule screen.
- 2 Select [Edit].
The scheduled events screen will be displayed on the screen.
- 3 Select [Edit].
- 4 From the items displayed on the screen, select the charging schedule you wish to change.
- 5 Set the desired time/day.

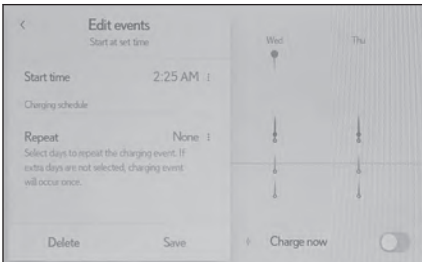

When changing the [Start at set time] of the charging schedule:

Set the time (start time)/day to start charging and then select [OK].

When changing the [Departure time] of the charging schedule:

Set the time which you would like charging to end (departure time) and then select [OK].

[Repeat]setting:

Charging will be repeated for the set day(s) on the charging schedule. It is possible to turn more than one day on.

If no days are selected, charging is only carried out once according to the charging schedule for the next 24 hours.

- 6 After setting operations are complete, select [Save].

When a setting is changed, its icon on the calendar also changes.

To cancel changes made to the charging schedule, select **X**.

After setting operations are complete, when the power switch is turned off and the AC charging cable is connected to the vehicle, charging is carried out according to the charging schedule settings.

Deleting a registered charging schedule on the center display

- 1 Display the charging schedule screen.
- 2 Select [Edit].

The scheduled events screen will be displayed on the screen.

- 3 Select [Edit].
- 4 From the items displayed on the screen, select the charging schedule you wish to delete.
- 5 Select [Delete].

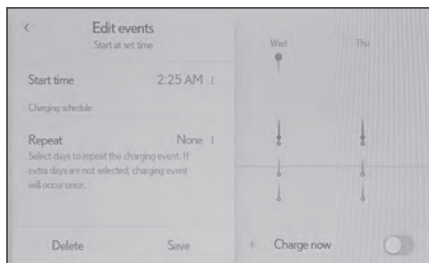

A deletion confirmation message will be displayed.

- 6 Select [Delete] to delete the selected charging schedule.

To cancel deletion, select [Cancel].

When a charging schedule is deleted, its icon is also deleted from the calendar.

Displaying the [Next charging event] on the center display

- Turn the power switch off.

According to the set charging schedule, the [Next charging event] will be displayed.

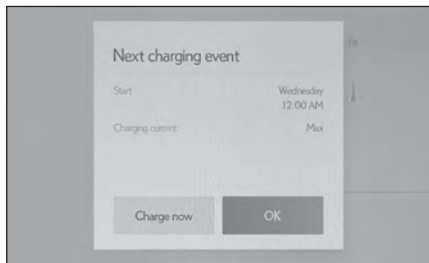

When [OK] is selected: The next scheduled charging screen will be closed.

When [Charge now] is selected: [Charge now] will be turned on.

INFORMATION

■ [Next charging event]

After charging completes, the [Next charging event] on the display will not change until the AC charging cable is removed, after charging is performed according to the [Next charging event].

Turning on [Charge now] on the center display

1 Display the charging schedule screen.

2 Select  of [Charge now].

Each time the switch is selected, [Charge now] will turn on/off.

After setting operations are complete, charging starts when the AC charging cable is connected.

Turning on [Charge now] on the multi-information display

1 Turn the power switch off.

The closing display screen is displayed on the multi-information display.

2 **Vehicles without a head-up display:** Press  of the meter control switch. ^{*11}**Vehicles with a head-up display:** Press the steering wheel switch at the position where [YES] is displayed on the multi-information display.

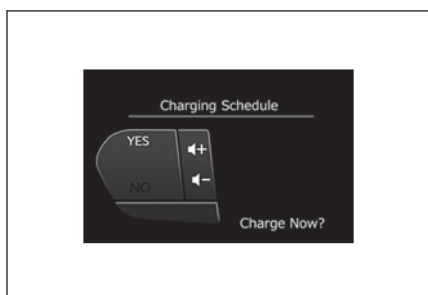

After setting operations are complete, charging starts when the AC charging cable is connected.

INFORMATION

When the power switch is turned off

When the power switch is turned off, the charging schedule (next scheduled charging) will be displayed on the closing display and the registered details can be checked. ^{*12}

My Room Mode mode function and operation

When the AC charging cable is connected to the vehicle, electrical components such as the air conditioning system or audio system can be used using the external power source.

^{*11}: Each time  is pressed, [Charge now] will turn on/off.

^{*12}: The closing display screen may not be displayed during charging.

 **INFORMATION****■ While using My Room Mode**

Any of the following may occur.

- When the remaining charge of the hybrid battery (traction battery) reaches the lower limit, the air conditioning system automatically turns off.

In this situation, the air conditioning system cannot be used until the remaining charge of the hybrid battery (traction battery) increases. Turn the power switch off and use My Room Mode after the remaining charge of the hybrid battery (traction battery) is restored.

- When the outside temperature is low, the heater output may be limited due to the air conditioning system operation being restricted.
- Warning lights and indicators such as electric power steering system warning light (yellow) and malfunction indicator lamp may turn on, but this is not a malfunction.

■ When a charging schedule is registered

When My Room Mode starts while the charging schedule is on standby, charging schedules are ignored and charging starts.

■ Meter display during charging

If My Room Mode is not turned on for approximately 100 seconds after the power switch is turned on during charging, the power switch will automatically turn off.

Starting My Room Mode**⚠ WARNING**

When using My Room Mode, make sure to observe the following precautions.

- Do not leave children, people who need assistance, or pets inside the vehicle.

The system may turn off automatically and the interior temperature may become high or low, resulting in heat stroke, dehydration or hypothermia. Devices such as the wipers can also be used, which may lead to mistaken operation and an accident.

- Check the safety around the vehicle carefully before use.

1 Connect the AC charging cable to the vehicle and start charging.**2 Turn the power switch on during charging.**

The setting screen of My Room Mode is displayed automatically on the center display.

3 Select [Yes].

My Room Mode starts and systems such as the air conditioning system and audio system can be used inside the vehicle.

When not using My Room Mode, select [No].

1-3. Charging with the plug-in hybrid system

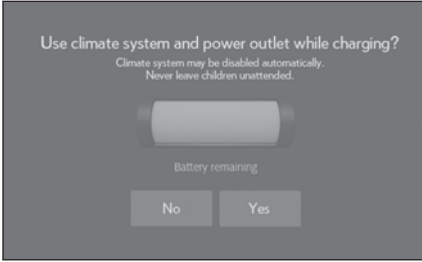

To stop My Room Mode, turn the power switch off.

Vehicle load limits

Vehicle load limits include total load capacity, seating capacity, towing capacity and cargo capacity.

Vehicle load limit terminology and definitions

WARNING

Do not overload the vehicle. It may not only cause damage to the tires, but also degrade steering and braking ability, resulting in an accident.

■ **Total load capacity (vehicle capacity weight)**

Total load capacity means the combined weight of occupants, cargo and luggage.

■ **Seating capacity**

Seating capacity means the maximum number of occupants whose estimated average weight is 150 lb. (68 kg) per person.

■ **TWR (Trailer Weight Rating) (vehicles with towing package)**

TWR means the maximum gross trailer weight (trailer weight plus its cargo weight) that your vehicle is able to tow.

■ **TWR (Trailer Weight Rating) (vehicles without towing package)**

Lexus does not recommend towing a trailer with your vehicle.

■ **Cargo capacity**

Cargo capacity may increase or decrease depending on the weight and the number of occupants.

INFORMATION

■ **Total load capacity and seating capacity**

These details are also described on the tire and loading information label.

Related Links

[Dimensions and weight\(P. 742\)](#)

[Seating capacity\(P. 742\)](#)

Riding with children

If a child which is not large enough to correctly wear a seat belt intended for adults is to ride in the vehicle, use a child restraint system. Child restraint systems are designed to keep children safe.

To ensure safety, observe the following when children are in the vehicle.

- Make sure that children always wear a seat belt.

If a child is not wearing a seat belt, in a collision, they may collide with a window, other passenger, or the interior of the vehicle. Also, if a child is riding on the lap of another passenger, in a collision, they may collide with a window, other passenger, or the interior of the vehicle.

- Seat children in the rear seats.

It is recommended that children sit in the rear seats to avoid accidental contact with the driver's controls.

- Do not allow children to operate equipment such as the doors, windows, etc.

Do not let children operate equipment such as the doors, power windows, seats, etc. as a part of their body may become pinched.

To prevent children from opening and closing the doors and power windows, use the child-protector locks and window lock switch.

WARNING

- Never leave children unattended in the vehicle, and never allow children to have or use the key.

Children may be able to start the vehicle or shift the vehicle into neutral.

- Do not leave children unattended in the vehicle.

Children may accidentally cause the vehicle to move, leading to an accident, or start a fire.

- Do not leave people or animals in the vehicle.

The temperature inside the vehicle can become extremely high during the daytime, possibly leading to heat stroke or death.

- Do not allow children to ride on the lap of a passenger.

If a child is riding on the lap of another passenger, in a collision, they may collide with a window, another passenger, or the interior of the vehicle. Make sure that children wear a seat belt or use a child restraint system.

- Use a child restraint system for small children.

⚠ WARNING

If a child which is not large enough to correctly wear a seat belt is to ride in the vehicle, use a child restraint system.

- Use child restraint systems correctly.

Child restraint systems are designed to protect children in a collision or sudden stop. Make sure to securely install child restraint systems and use them correctly.

- Replace child restraint systems which have been involved in a collision.

If the vehicle has been involved in a collision, it is possible that an installed child restraint system has been damaged and will not be able to deliver the same level of impact absorption performance, even if the outside of it looks normal.

- When a child restraint system is not in use, secure it so that it does not interfere with driving.

When removing a child restraint system, store it outside of the vehicle or securely in the luggage compartment.

Seating positions for children

It is recommended that children sit in the rear seats to avoid accidental contact with the driver's controls. In the event of an accident, the force of deployment of the SRS front passenger airbag can cause death or serious injury to a child seated on the front passenger's seat. Do not allow a child to ride on the front passenger's seat unless it is unavoidable.

⚠ WARNING

- When installing a child restraint system to the front passenger's seat is unavoidable, move the seat as far back as possible, and install the child restraint system so that it faces forward. If the child restraint system is not installed correctly, in the event of an accident, the force of deployment of the SRS front passenger airbag can cause death or serious injury.
- Never install a rear-facing child restraint system on the front passenger seat even if the "AIR BAG OFF" indicator light is illuminated. In the event of an accident, the force of the rapid inflation of the front passenger airbag can cause death or serious injury to the child if the rear-facing child restraint system is installed on the front passenger seat.
- A forward-facing child restraint system may be installed on the front passenger seat only when it is unavoidable. A child restraint system that requires a top tether strap should not be used in the front passenger seat since there is no top tether strap anchor for the front passenger seat.
- A forward-facing child restraint system may be installed on the front passenger seat only when it is unavoidable. When installing a forward-facing child restraint system on

⚠ WARNING

the front passenger seat, move the seat as far back as possible, and raise the seat to the upper most position, even if the "AIR BAG OFF" indicator light is illuminated. If the head restraint interferes with the child restraint system installation and the head restraint can be removed, remove the head restraint.

- Do not allow children to lean against the doors, roof side rails, or pillars. In the event of an accident, the force of deployment of an SRS airbag can cause death or serious injury to a child.
- When adjusting the driver's seat, if it contacts a child or child restraint system, install the child restraint system to the rear seat behind the front passenger's seat.
- Adjust the front passenger seat so that it does not interfere with the child or child restraint system.
- If a child which is over 3.3 ft. (100 cm) tall is to ride in the vehicle, use a booster seat. When using a booster seat, make sure that the seat belt is worn correctly.

Preventing the rear doors from being opened from the inside of the vehicle (child-protector lock)

The door cannot be opened from inside the vehicle when the lock is set.

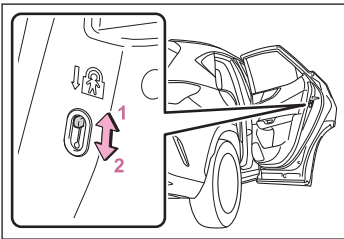

- 1 Unlock
- 2 Lock

These locks can be set to prevent children from opening the rear doors. Push down on each rear door switch to lock both rear doors.

□ INFORMATION

■ Door opening method when using a child-protector lock

Unlock the door and pull the exterior door handle to open the door. If it is necessary to open the door from inside the vehicle, open the rear door window and pull the exterior door handle.

Child restraint system

Points to remember

The laws of all 50 states of the U.S.A. as well as Canada now require the use of child restraint systems.

- Prioritize and observe the warnings, as well as the laws and regulations for child restraint systems.
- Use a child restraint system until the child becomes large enough to properly wear the vehicle's seat belt.
- Choose a child restraint system that suits your vehicle and is appropriate to the age and size of the child.

WARNING

■ When a child is riding

Observe the following precautions. Failure to do so may result in death or serious injury.

- For effective protection in automobile accidents and sudden stops, a child must be properly restrained, using a seat belt or child restraint system which is correctly installed. For installation details, refer to the operation manual enclosed with the child restraint system. General installation instruction is provided in this manual.
- Lexus strongly urges the use of a proper child restraint system that conforms to the weight and size of the child, installed on the rear seat. According to accident statistics, the child is safer when properly restrained in the rear seat than in the front seat.
- Holding a child in your or someone else's arms is not a substitute for a child restraint system. In an accident, the child can be crushed against the windshield or between the holder and the interior of the vehicle.

■ Handling the child restraint system

If the child restraint system is not properly fixed in place, the child or other passengers may be seriously injured or even killed in the event of sudden braking, sudden swerving, or an accident.

- If the vehicle were to receive a strong impact from an accident, etc., it is possible that the child restraint system has damage that is not readily visible. In such cases, do not reuse the restraint system.
- Make sure you have complied with all installation instructions provided with the child restraint system manufacturer and that the system is properly secured.
- Keep the child restraint system properly secured on the seat even if it is not in use. Do not store the child restraint system unsecured in the passenger compartment.
- If it is necessary to detach the child restraint system, remove it from the vehicle.





Child restraint system installation method

Child restraint system fixed with a child restraint LATCH anchor

WARNING

When installing a child restraint system

Observe the following precautions. Failure to do so may result in death or serious injury.

-  When using LATCH anchors, make sure that the area around the anchors is free of objects and that the seat belt will not be caught behind the child restraint system.
-  Follow all installation instructions provided by the child restraint system manufacturer.
-  Never attach two child restraint system attachments to the same anchor. In a collision, one anchor may not be strong enough to hold two child restraint system attachments and may break. If the LATCH anchors are already in use, use the seat belt to install a child restraint system in the center seat.
-  When securing some types of child restraint systems in rear seats, it may not be possible to properly use the seat belts in positions next to the child restraint without interfering with it or affecting seat belt effectiveness. Be sure your seat belt fits snugly across your shoulder and low on your hips. If it does not, or if it interferes with the child restraint, move to a different position. Failure to do so may result in death or serious injury.
-  If the seat is adjusted, reconfirm the security of the child restraint system.

Laws and regulations pertaining to anchors

The LATCH system conforms to FMVSS225 or CMVSS210.2.

Child restraint systems conforming to FMVSS213 or CMVSS213 specifications can be used.

This vehicle is designed to conform to SAE J1819.

With rigid lower attachments

LATCH anchors are provided for the each rear seat. (Buttons displaying the location of the anchors are attached to the seats.)

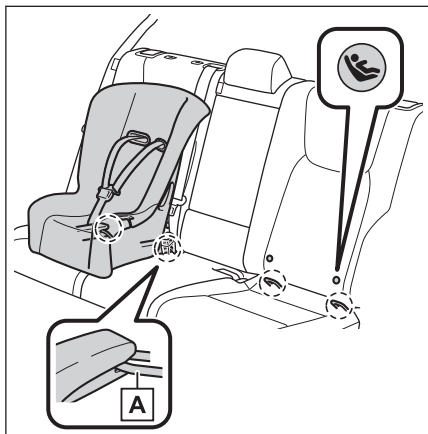

A LATCH anchor

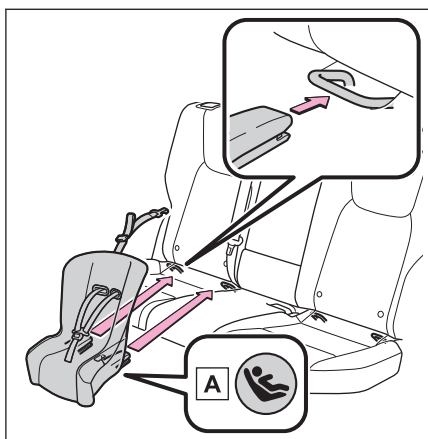

A Canada only

1 Latch the buckles onto the LATCH anchors.

- For owners in Canada:

The symbol on a child restraint system indicates the presence of a lower connector system.

- 2 If the child restraint has a top tether strap, follow the child restraint manufacturer's operation manual regarding the installation, using the top tether strap to latch onto the top tether strap anchor.
- 3 After installing the child restraint system, rock it back and forth to ensure that it is installed securely.

With flexible lower attachments

LATCH anchors are provided for the each rear seat. (Buttons displaying the location of the anchors are attached to the seats.)

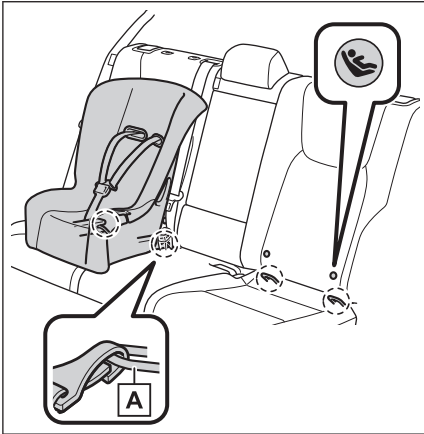

A LATCH anchor

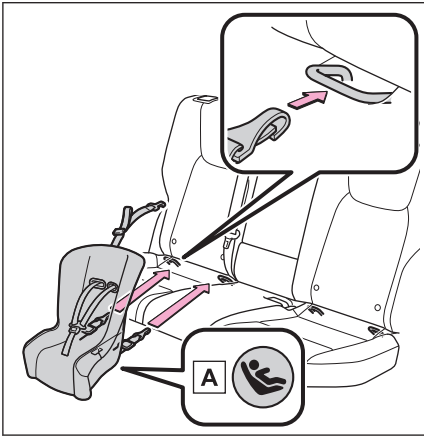

A Canada only

1 Latch the hooks onto the LATCH anchors.

- For owners in Canada:

The symbol on a child restraint system indicates the presence of a lower connector system.

2 If the child restraint has a top tether strap, follow the child restraint manufacturer's operation manual regarding the installation, using the top tether strap to latch onto the top tether strap anchor.

- 3 After installing the child restraint system, rock it back and forth to ensure that it is installed securely.

Using an anchor bracket (for top tether strap)

⚠ WARNING

■ When installing a child restraint system

Observe the following precautions. Failure to do so may result in death or serious injury.

- Firmly attach the top tether strap and make sure that the belt is not twisted.
- Do not attach the top tether strap to anything other than the anchor bracket.
- After securing a child restraint system, never adjust the seat.
- Follow all installation instructions provided by the child restraint system manufacturer.
- Outboard rear seats: When installing the child restraint system with the head restraint being raised, after the head restraint has been raised and then the anchor bracket has been fixed, do not lower the head restraint.
- Rear center seat: When installing the child restraint system with the head restraint being lowered, be sure to have the top tether strap pass over the top of the head restraint. If the belt passes below the head restraint, it is possible that the child restraint system may not be securely fixed.

Laws and regulations pertaining to anchors

The LATCH system conforms to FMVSS225 or CMVSS210.2.

Child restraint systems conforming to FMVSS213 or CMVSS213 specifications can be used.

This vehicle is designed to conform to SAE J1819.

Fixing the top tether strap to the anchor bracket

Anchor brackets are provided for each rear seat.

Use anchor brackets when fixing the top tether strap.

Install the child restraint system in accordance to the operation manual enclosed with the child restraint system.

Latch the hook onto the anchor bracket and tighten the top tether strap.

Make sure the top tether strap is securely latched.

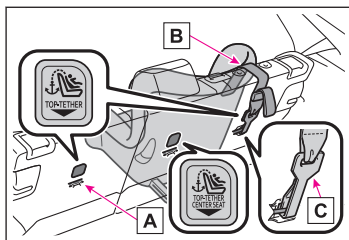

- A Anchor brackets
- B Top tether strap
- C Hook

Child restraint system fixed with a seat belt

⚠ WARNING

■ When installing a child restraint system

Observe the following precautions. Failure to do so may result in death or serious injury.

- Do not allow children to play with the seat belt. If the seat belt becomes twisted around a child's neck, it may lead to choking or other serious injuries that could result in death. If this occurs and the buckle cannot be unfastened, scissors should be used to cut the belt.
- Ensure that the belt and plate are securely locked and the seat belt is not twisted.
- Shake the child restraint system left and right, and forward and backward to ensure that it has been securely installed.
- After securing a child restraint system, never adjust the seat.
- Follow all installation instructions provided by the child restraint system manufacturer.
- When securing some types of child restraint systems in rear seats, it may not be possible to properly use the seat belts in positions next to the child restraint without interfering with it or affecting seat belt effectiveness. Be sure your seat belt fits snugly across your shoulder and low on your hips. If it does not, or if it interferes with the child restraint, move to a different position. Failure to do so may result in death or serious injury.
- When installing a child restraint system in the rear center seat, adjust both seatbacks at the same angle. Otherwise, the child restraint system cannot be securely restrained and this may cause death or serious injuries in the event of sudden braking, sudden swerving or an accident.

■ Do not use a seat belt extender

If a seat belt extender is used when installing a child restraint system, the seat belt will not securely hold the child restraint system, which could cause death or serious injury to the child or other passengers in the event of sudden braking, sudden swerving or an accident.

Installing child restraint system using a seat belt (child restraint lock function belt)

A child restraint system for a small child or baby must itself be properly restrained on the seat with the lap portion of the lap/shoulder belt.

Install the child restraint system in accordance to the operation manual enclosed with the child restraint system.

Rear-facing - Infant seat/convertible

1 Adjust the rear seat

If there is a gap between the child seat and the seatback, adjust the seatback until good contact is achieved.

2 Place the child restraint system on the rear seat facing the rear of the vehicle.

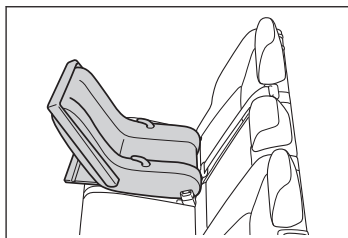

3 Run the seat belt through the child restraint system and insert the plate into the buckle. Make sure that the belt is not twisted.

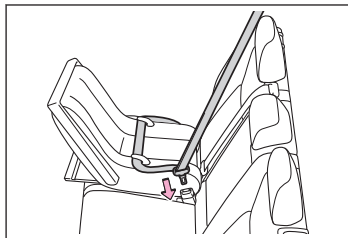

4 Fully extend the shoulder belt and allow it to retract to put it in lock mode. In lock mode, the belt cannot be extended.

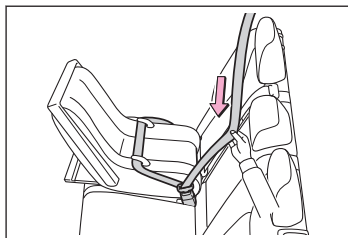

1-5. Preparations for safe driving with children in the vehicle

- 5 While pushing the child restraint system down into the rear seat, allow the shoulder belt to retract until the child restraint system is securely in place.

After the shoulder belt has retracted to a point where there is no slack in the belt, pull the belt to check that it cannot be extended.

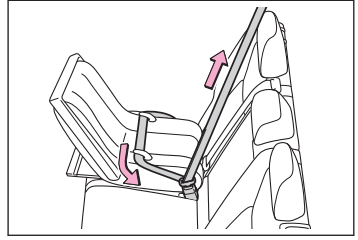

- 6 After installing the child restraint system, rock it back and forth to ensure that it is installed securely.

Forward-facing - Convertible

1 Adjust the seat

- When using the front passenger seat

If installing the child restraint system to the front passenger seat is unavoidable, refer to → P.103.

- When using the rear seat

If there is a gap between the child seat and the seatback, adjust the seatback angle until good contact is achieved.

- 2 If the head restraint interferes with the child restraint system installation and the head restraint can be removed, remove the head restraint. Otherwise, put the head restraint in the upper most position.
- 3 Place the child restraint system on the seat facing the front of the vehicle.



- 4 Run the seat belt through the child restraint system and insert the plate into the buckle. Make sure that the belt is not twisted.

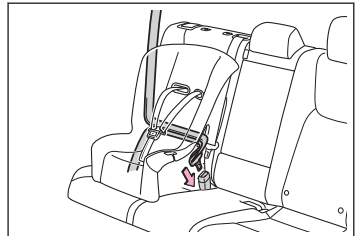

- 5 Fully extend the shoulder belt and allow it to retract to put it in lock mode. In lock mode, the belt cannot be extended.

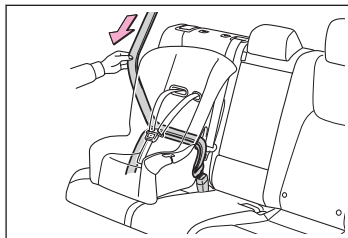

- 6 While pushing the child restraint system into the rear seat, allow the shoulder belt to retract until the child restraint system is securely in place.

After the shoulder belt has retracted to a point where there is no slack in the belt, pull the belt to check that it cannot be extended.

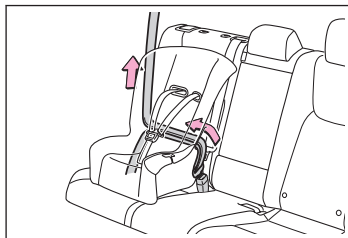

- 7 If the child restraint has a top tether strap, follow the child restraint manufacturer's operation manual regarding the installation, using the top tether strap to latch onto the top tether strap anchor.
- 8 After installing the child restraint system, rock it back and forth to ensure that it is installed securely.

Booster seat

- 1 If installing the child restraint system to the front passenger seat is unavoidable, refer to → P.103.
- 2 High back type: If the head restraint interferes with your child restraint system, and the head restraint can be removed, remove the head restraint. Otherwise, put the head restraint in the upper most position.
- 3 Place the child restraint system on the seat facing the front of the vehicle.

Booster type

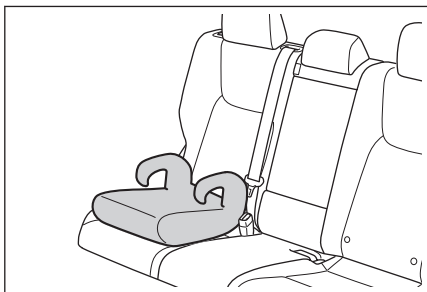

High back type

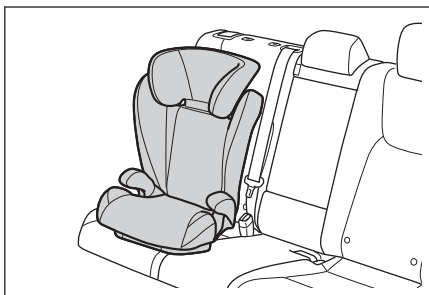

- 4 Sit the child in the child restraint system. Fit the seat belt to the child restraint system according to the manufacturer's instructions and insert the plate into the buckle. Make sure that the belt is not twisted.

Check that the shoulder belt is correctly positioned over the child's shoulder and that the lap belt is as low as possible.



▲ WARNING

■ When installing a child restraint system

Observe the following precautions. Failure to do so may result in death or serious injury.

When a booster seat is installed, always ensure that the shoulder belt is positioned across the center of the child's shoulder. The belt should be kept away from the child's neck, but not so that it could fall off the child's shoulder.

■ When installing a booster seat

To prevent the belt from going into ALR lock mode, do not fully extend the shoulder belt. ALR mode causes the belt to tighten only. This could cause injury or discomfort to the child.

Removing a child restraint system

- Press the buckle release button and fully retract the seat belt.

When releasing the buckle, the child restraint system may spring up due to the rebound of the seat cushion. Release the buckle while holding down the child restraint system.

Since the seat belt automatically reels itself, slowly return it to the stowing position.

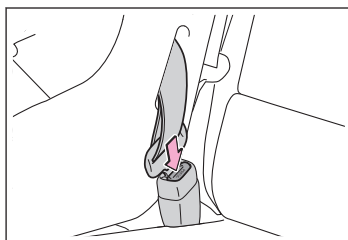

Installing a child restraint system to the front passenger's seat

Do not install a child restraint system to the front passenger's seat unless it is unavoidable. In the event of an accident, the force of deployment of an SRS airbag can cause death or serious injury to a child.

If installation of a child restraint system to the front passenger's seat is unavoidable, adjust the front passenger's seat as follows:

- Move the seat to the rearmost position
- Move the seat to the uppermost position
- Adjust the seatback angle to the most upright position.

Adjust the seatback angle of the front passenger's seat until good contact is achieved.

- Remove the head restraint

If the head restraint cannot be removed, move it to the uppermost position.

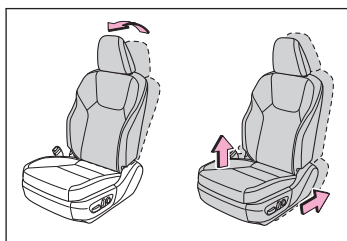

⚠ WARNING

- When installing a child restraint system to the front passenger's seat, move the seat as far back as possible. In the event of an accident, the force of deployment of an SRS airbag can cause death or serious injury to a child.
- Make sure that the child's body will not contact the doors, roof side rails, or pillars. In the event of an accident, the force of deployment of an SRS airbag can cause death or serious injury to a child.
- When using a booster seat, make sure that the seat belt is worn correctly.
- Choose a child restraint system appropriate to the age and size of the child.

Installing a child restraint system to the front passenger's seat

- Make sure to appropriately adjust the front passenger's seat before installing the child restraint system.

Install the child restraint system according to the user's manual included with it.

Key types

The following keys are provided with the vehicle.

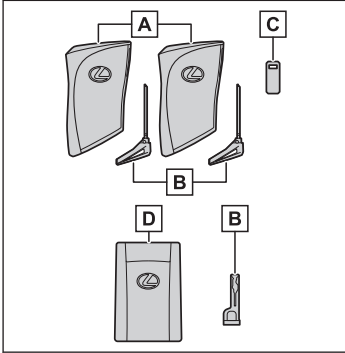

A Electronic keys

- Operating the smart access system with push-button start
- Operating the wireless remote control function

B Mechanical keys

C Key number plate

D Card key (electronic key)*

- Operating the smart access system with push-button start

⚠ NOTICE

■ To prevent key damage

Observe the following precautions

- Do not drop the keys, subject them to strong shocks or bend them.
- Do not expose the keys to high temperatures for long periods of time.
- Do not get the keys wet or wash them in an ultrasonic washer, etc.
- Do not attach metallic or magnetic materials to the keys or place the keys close to such materials.
- Do not disassemble the keys.
- Do not attach a sticker or anything else to the surface of the electronic key.
- Do not place the keys near objects that produce magnetic fields, such as TVs, audio systems and induction cookers, or medical electrical equipment, such as low-frequency therapy equipment.

■ Carrying the electronic key on your person

Carry the electronic key 3.9 in. (10 cm) or more away from electric appliances that are turned on. Radio waves emitted from electric appliances within 3.9 in. (10 cm) of the electronic key may interfere with the key, causing the key to not function properly.

■ Handling the card key

- If the battery or card key terminals get wet, the battery may corrode and the card key may stop working. If the key is dropped into water, or if drinking water, etc., is spilled on the key, immediately remove the battery cover and wipe the battery and terminals. (To remove the battery cover, lightly grasp and pull it.) If the battery is corroded, have your Lexus dealer replace the battery.

*: If equipped

⚠ NOTICE

- Do not crush the battery cover or use a screwdriver to remove the battery cover. Forcibly removing the battery cover may bend or damage the key.
- If the battery cover is frequently removed, the battery cover may become loose.
- When installing the battery, make sure to check the direction of the battery. Installing the battery in the wrong direction may cause the battery to deplete rapidly.
- The surface of the card key may be damaged, or its coating may peel off in the following situations:
 - The card key is carried together with hard objects, such as coins and keys.
 - The card key is scraped with a sharp object, such as the tip of a mechanical pencil.
 - The surface of the card key is wiped with thinner or benzene.

📄 INFORMATION

■ Handling the card key

- The mechanical key that is stored inside the card key should be used only if a problem arises, such as when the card key does not operate properly.
- If the battery cover is not installed and the battery falls out or if the battery was removed because the key got wet, reinstall the battery with the positive terminal facing the Lexus emblem.

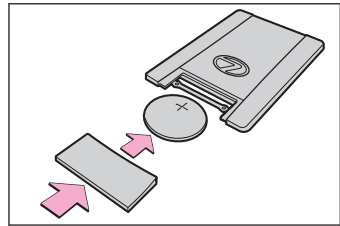

- The card key is not waterproof.

■ When riding in an aircraft

When bringing an electronic key onto an aircraft, make sure you do not press any buttons on the electronic key while inside the aircraft cabin. If you are carrying an electronic key in your bag, etc., ensure that the buttons are not likely to be pressed accidentally. Pressing a button may cause the electronic key to emit radio waves that could interfere with the operation of the aircraft.

■ Electronic key battery depletion

- The standard battery life is 1 to 2 years (The card key battery life is about 1 year.).
- If the battery becomes low, an alarm will sound in the cabin when the hybrid system stops.

1-6. Entering/exiting the vehicle and loading luggage

- As the electronic key always receives radio waves, the battery will become depleted even if the electronic key is not used. The following symptoms indicate that the electronic key battery may be depleted. Replace the battery when necessary.
 - The smart access system with push-button start or the wireless remote control does not operate.
 - The detection area becomes smaller.
 - The LED indicator on the key surface does not turn on.
- To avoid serious deterioration, do not leave the electronic key within 3 ft. (1 m) of the following electrical appliances that produce a magnetic field:
 - TVs
 - Personal computers
 - Cellular phones, cordless phones and battery chargers
 - Table lamps
 - Induction cookers



■ Battery-saving function

The battery-saving function will be activated in order to prevent the electronic key battery and the 12-volt battery from being discharged while the vehicle is not in operation for a long time.

- In the following situations, the smart access system with push-button start may take some time to unlock the doors.
 - The electronic key has been left in an area of approximately 11 ft. (3.5 m) of the outside of the vehicle for 2 minutes or longer.
 - The smart access system with push-button start has not been used for 5 days or longer.
- If the smart access system with push-button start has not been used for 14 days or longer, the doors cannot be unlocked at any doors except the driver's door. In this case, take hold of the driver's door handle, or use the wireless remote control or the mechanical key, to unlock the doors.

■ Electronic key battery-saving mode

When battery-saving mode is set, battery depletion is minimized by stopping the electronic key from receiving radio waves.

While pressing and holding  on the electronic key, press  twice. The indicator on the electronic key will flash 4 times and battery-saving mode will be entered.

The smart access system with push-button start cannot be used while the electronic key is in battery-saving mode. Battery saving mode can be cancelled by pressing any switch on the electronic key.

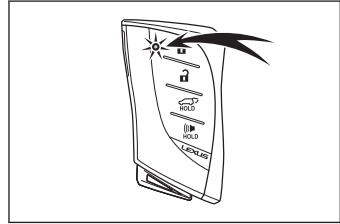

■ Confirmation of the registered key number

The number of keys already registered to the vehicle can be confirmed. Ask your Lexus dealer for details.

■ When required to leave the vehicle's key with a parking attendant

Lock the glove box as circumstances demand. Remove the mechanical key for your own use and provide the attendant with the electronic key only.

Smart access system with push-button start

⚠ WARNING

■ Affects influenced by the radio wave (Affect from the Smart access system with push-button start antennas)

- People with implantable cardiac pacemakers, cardiac resynchronization therapy-pacemakers or implantable cardioverter defibrillators should keep away from the smart access system with push-button start antennas. The radio waves may affect the operation of such devices. If necessary, the entry function can be disabled. Ask your Lexus dealer for details, such as the frequency of radio waves and timing of the emitted radio waves. Then, consult your doctor to see if you should disable the entry function.
- Users of any electrical medical device other than implantable cardiac pacemakers, cardiac resynchronization therapy-pacemakers or implantable cardioverter defibrillators should consult the manufacturer of the device for information about its operation under the influence of radio waves. Radio waves could have unexpected effects on the operation of such medical devices.

Ask your Lexus dealer for details on disabling the entry function.

□ INFORMATION

■ Antenna location

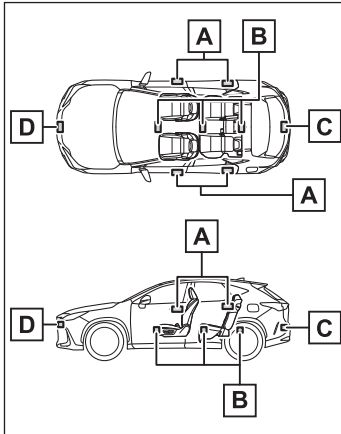

- A Antennas outside the cabin
- B Antennas inside the cabin
- C Antenna outside the luggage compartment
- D Antennas outside the cabin (Vehicles with Lexus Teammate Advanced Park system)

■ Effective range (areas within which the electronic key is detected)

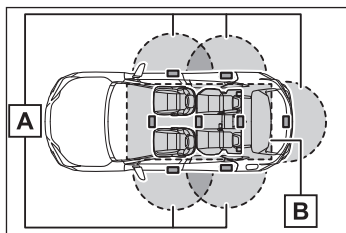

A When locking or unlocking the doors

The system can be operated when the electronic key is within about 2.3 ft. (0.7 m) of an outside door handle. (Only the doors detecting the key can be operated.)

B When starting the hybrid system or changing power switch modes

The system can be operated when the electronic key is inside the vehicle.

■ If an alarm sounds or a warning message is displayed

A combination of exterior and interior alarms as well as warning messages shown on the multi-information display are used to prevent theft of the vehicle and accidents resulting from erroneous operation. Take appropriate measures in response to any warning message on the multi-information display.

The following table describes situations and correction procedures when only an alarm sounds.

- When an exterior alarm sounds once for 5 seconds

Situation: An attempt was made to lock the vehicle while a door was open.

Correction procedure: Close all of the doors and lock the doors again.

- When an interior alarm pings repeatedly

Situation: The power switch was turned to ACC while the driver's door was open (The driver's door was opened when the power switch was in ACC).

Correction procedure: Turn the power switch off and close the driver's door.

■ Conditions affecting operation

The smart access system with push-button start, wireless remote control and immobilizer system use weak radio waves. In the following situations, the communication between the electronic key and the vehicle may be affected, preventing the smart access system with push-button start, wireless remote control and immobilizer system from operating properly.

- When the electronic key battery is depleted
- Near a TV tower, electric power plant, gas station, radio station, large display, airport or other facility that generates strong radio waves or electrical noise
- When the electronic key is in contact with, or is covered by the following metallic objects
 - Cards to which aluminum foil is attached
 - Cigarette boxes that have aluminum foil inside

1-6. Entering/exiting the vehicle and loading luggage

- Metallic wallets or bags
- Coins
- Hand warmers made of metal
- Media such as CDs and DVDs
- When other wireless keys (that emit radio waves) are being used nearby
- When carrying the electronic key together with the following devices that emit radio waves
 - Portable radio, cellular phone, cordless phone or other wireless communication devices
 - Another vehicle's electronic key or a wireless key that emits radio waves
 - Personal computers or personal digital assistants (PDAs)
 - Digital audio players
 - Portable game systems
- If window tint with a metallic content or metallic objects are attached to the rear window
- When the electronic key is placed near a battery charger or electronic devices
- When the vehicle is parked in a pay parking spot where radio waves are emitted

Even when the electronic key is within the effective range (detection areas), the system may not operate properly in the following cases:

- The electronic key is too close to the window or outside door handle, near the ground, or in a high place when the doors are locked or unlocked.
- The electronic key is near the ground or in a high place, or too close to the rear bumper center when the back door is opened.
- The electronic key is on the instrument panel, luggage cover or floor, or in the door pockets or glove box when the hybrid system is started or power switch modes are changed.

■ Note for the entry function

- Do not leave the electronic key on top of the instrument panel or near the door pockets when exiting the vehicle. Depending on the radio wave reception conditions, it may be detected by the antenna outside the cabin and the door will become lockable from the outside, possibly trapping the electronic key inside the vehicle.
- As long as the electronic key is within the effective range, the doors may be locked or unlocked by anyone.
- Even if the electronic key is not inside the vehicle, it may be possible to start the hybrid system if the electronic key is near the window.

- The doors may unlock if a large amount of water splashes on the door handle, such as in the rain or in a car wash when the electronic key is within the effective range. (The door will automatically be locked after approximately 60 seconds if the doors are not opened and closed.)
- If the wireless remote control is used to lock the doors when the electronic key is near the vehicle, there is a possibility that the door may not be unlocked by the entry function. (Use the wireless remote control to unlock the doors.)
- Touching the door lock sensor while wearing gloves may delay or prevent lock operation. Remove the gloves and touch the lock sensor again.
- When the lock operation is performed using the lock sensor, recognition signals will be shown up to two consecutive times. After this, no recognition signals will be given.
- If the door handle becomes wet while the electronic key is within the effective range, the door may lock and unlock repeatedly. In that case, follow the following correction procedures to wash the vehicle:
 - Place the electronic key in a location 6 ft. (2 m) or more away from the vehicle. (Take care to ensure that the key is not stolen.)
 - Set the electronic key to battery-saving mode to disable the smart access system with push-button start.
- If the electronic key is inside the vehicle and a door handle becomes wet during a car wash, a message may be shown on the multi-information display and a buzzer will sound outside the vehicle. To turn off the alarm, lock all the doors.
- The lock sensor may not work properly if it comes into contact with ice, snow, mud. Clean the lock sensor and attempt to operate it again.
- A sudden approach to the effective range or door handle may prevent the doors from being unlocked. In this case, return the door handle to the original position and check that the doors unlock before pulling the door handle again.
- If there is another electronic key in the detection area, it may take slightly longer to unlock the doors after the door handle is gripped.

■ When the vehicle is not driven for extended periods

- To prevent theft of the vehicle, do not leave the electronic key within 6 ft. (2 m) of the vehicle.
- The smart access system with push-button start can be deactivated in advance.
- Setting the electronic key to battery-saving mode helps to reduce key battery depletion.

■ To operate the system properly

Make sure to carry the electronic key when operating the system. Do not get the electronic key too close to the vehicle when operating the system from the outside of the vehicle.

1-6. Entering/exiting the vehicle and loading luggage

Depending on the position and holding condition of the electronic key, the key may not be detected correctly and the system may not operate properly. (The alarm may go off accidentally, or the door lock prevention may not operate.)

Related Links

[Customizable features\(P. 765\)](#)

Digital Key*

A smartphone can be used instead of the electronic key of the vehicle by installing the dedicated Digital Key App on a smartphone. Also, Digital Key can be shared with your family or friends using the Digital Key App.

INFORMATION**Free/open source software information**

This product contains Free/open source software (FOSS).

License information and/or the source code of this FOSS can be obtained at the following URL:

<https://www.denso.com/global/en/opensource/dkey/toyota/>

Digital key usage conditions

In order to use the Digital Key, you need to install the Lexus App, Register the Vehicle to the customer's Lexus App profile, and subscribe to Remote Services, and enroll in Digital Key

Digital key precautions

- A Digital Key can be used when the smartphone and server can communicate. The Digital Key may become unusable if the smartphone is not connected to the Internet. Be sure to carry the electronic key of the vehicle if traveling to a location with unreliable communications.
- If the smartphone battery is depleted, the smartphone cannot be used as Digital Key. If the battery level is low, be sure to charge the smartphone prior to going out.
- The Digital Key system is related to the smart access system with push-button start. If the smart access system with push-button start has been deactivated in the vehicle customization setting, the Digital Key will also be disabled.
- Depending on the radio wave environment, the Digital Key may not be able to be used. → P.108
- When transferring vehicle ownership, make sure to delete the Digital Keys.
- If the vehicle is not operated for 14 days or more, the Digital Key will not connect automatically. Therefore, it may take some time before the system operates after a door handle is touched.

*: If equipped

1-6. Entering/exiting the vehicle and loading luggage



- A part of the services may be stopped for a certain period of time due to server maintenance. However, registered Digital Keys can be used during the maintenance.
- A smartphone with the Digital Key App enabled will be able to lock and unlock the doors, start the hybrid system and perform any other operations as same as the electronic key of the vehicle. Be especially careful not to lose the smartphone or allow it to be stolen.
If the smartphone is lost or stolen, contact your Lexus dealer immediately.
- When taking your vehicle to a Lexus dealer for an inspection or repairs, make sure to bring an electronic key.

Opening/closing the doors

WARNING

Precautions for when driving

Observe the following precautions while driving.

-  Make sure that all of the doors are closed and locked.
-  Do not press an inside door opener switch while driving.



Be especially careful with the driver's door, as it can be opened even when the doors are locked.

-  When a child is riding in a rear seat, set the child protector locks to prevent the rear doors from being opened from inside the vehicle.

Precautions for when opening or closing a door

When closing a door, swing it closed with slight force applied to it. If you press on the door by hand to close it, it may not be closed completely.

When opening or closing a door, check the surrounding area and hold the door handle tightly.

-  When on a slope
-  When the space between a door and a wall, etc. is small
-  When in an area with strong winds

INFORMATION

Door lock buzzer

If an attempt to lock the doors using the smart key system is made when a door is not fully closed, a buzzer will sound continuously for 5 seconds. Fully close the door to stop the buzzer, and lock the doors again.

Open door warning buzzer

If the vehicle speed reaches 3 mph (5 km/h), the master warning light flashes and a buzzer sounds to indicate that door(s) or the hood is not fully closed. The open door(s) or hood is displayed on the multi-information display.

Rear seat reminder function

As the first rear seat reminder so as not to forget luggage, etc. in the rear seat, when the power switch is turned off after any of the following conditions are met, a buzzer will sound and a message will be displayed on the multi-information display for approximately 6 seconds.

Also, as the second rear seat reminder, when the doors are locked, a buzzer will sound and the emergency flashers will flash for a few seconds, and a message will be displayed on the multi-information display.

1-6. Entering/exiting the vehicle and loading luggage

The second rear seat reminder will not be activated if a rear door was opened before the doors are locked.

- The hybrid system is started within 10 minutes after opening and closing a rear door.
- A rear door has been opened and closed after the hybrid system was started.

However, if a rear door is opened and then closed within approximately 2 seconds, the rear seat reminder function may not operate.

The rear seat reminder function determines that luggage, etc. has been placed in a rear seat based on opening and closing of a rear door. Therefore, depending on the situation, the rear seat reminder function may not operate and you may still forget luggage, etc. in the rear seat, or it may operate unnecessarily.

- The rear seat reminder function can be enabled/disabled.

Related Links

[Key types\(P. 104\)](#)

[Locking/unlocking the doors\(P. 119\)](#)

[Using the mechanical key\(P. 690\)](#)

[If a door cannot be opened using the door opener switch\(P. 696\)](#)

[Customizable features\(P. 765\)](#)

Opening the doors

► Outside the vehicle

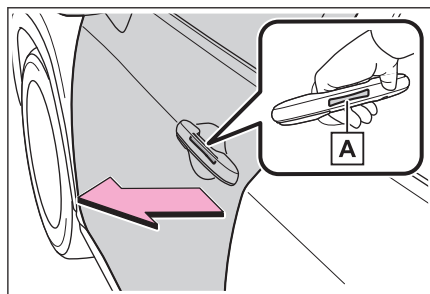

When the doors are locked:

While carrying an electronic key, press the door opener switch **A** of the door handle and open the door.

Make sure to securely press the door opener switch **A** on the inner side of the door handle with the electronic key within the detection area.

When the doors are unlocked:

Press the door opener switch **A** of the door handle to open the door.

Make sure to securely press the door opener switch **A** on the inner side of the door handle.

► Inside the vehicle

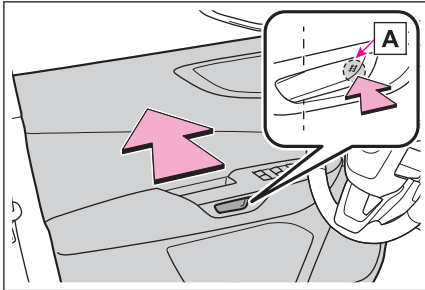

Driver's door:

Even if the door is locked, pressing the front side of the door opener switch **A** will open the door.

The door will unlock and the door lock indicator will turn off.

Passenger doors:

Press the door lock switch to unlock the door, and then pressing the front side of the door opener switch **A** to open the door.

The door will unlock and the door lock indicator will turn off.

INFORMATION

■ Inside door opener switch operating conditions

When any of the following conditions are met:

- The vehicle speed is less than 2 mph (4 km/h) and the parking brake is engaged
- The vehicle speed is less than 2 mph (4 km/h) and the brake pedal is depressed
- The shift position is in P

■ When opening a door from inside the vehicle

Open the door pressing the door opener switch.

If the door is not fully unlatched, press the door opener switch twice to open the door.

■ Manual release handles inside the vehicle

The door opener switches inside the vehicle can also be used to manually open the doors.

1-6. Entering/exiting the vehicle and loading luggage

A door can be opened through electronic operation by pressing a the door opener switch, or it can be opened using the door opener switch as a manual release handle and pulling it twice.

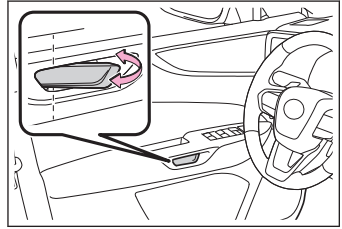

Locking/unlocking the doors

INFORMATION

■ Impact detection door lock release system

If the vehicle is involved in a severe frontal or rear collision, manual release handle operation will be enabled for all of the doors.

■ Operation signals

Unlocking is indicated by a buzzer sounding and the emergency flashers flashing. (twice)

Locking is indicated by a buzzer sounding and the emergency flashers flashing. (Once)

■ Security feature

If a door is not opened within approximately 60 seconds after the vehicle is unlocked, the security feature automatically locks the vehicle again.

Using the smart access system with push-button start

Locking/unlocking the doors using smart access system with push-button start

The driver should always carry an electronic key (or the card key) on their person, for example in their pocket.

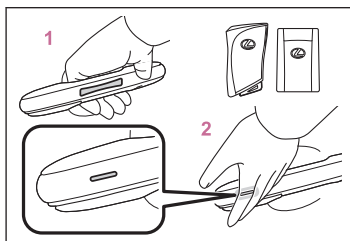

- 1 Grip the driver's door handle to unlock the door. Holding the driver's door handle for approximately 2 seconds unlocks all the doors. Grip any passenger door handle to unlock all the doors.*¹

Make sure to touch the sensor on the back of the handle.

The doors cannot be unlocked for 3 seconds after the doors are locked.

- 2 Touch the lock sensor (the indentation on the surface of the door handle) to lock the doors.

Check that the door is securely locked.

Locking the doors will set the alarm system.

*1: The door unlock settings can be changed.

 **INFORMATION**

■ When the door cannot be locked even though the lock sensor has been touched with a finger



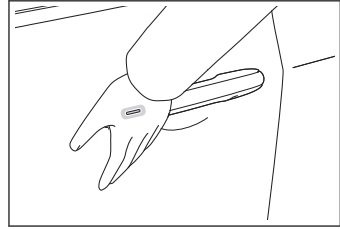

Touch the lock sensor with the palm of your hand.

When gloves are being worn, remove the gloves.





Switching the door unlock function

It is possible to set which doors the entry function unlocks using the wireless remote control.

- 1 Turn the power switch off.
- 2 When the indicator light on the key surface is not on, press and hold  ,  or  for approximately 5 seconds while pressing and holding  .

The setting changes each time an operation is performed, as shown below. (When changing the setting continuously, release the buttons, wait for at least 5 seconds, and repeat step 2.)

Multi-information display/Beep	Unlocking function
 Exterior: Beeps 3 times Interior: Pings once	Holding the driver's door handle unlocks only the driver's door. Holding any of the passenger door handles unlocks all the doors.
 Exterior: Beeps twice Interior: Pings once	Holding a door handle unlocks all the doors.

To prevent unintended triggering of the alarm, unlock the doors using the wireless remote control and open and close a door once after the settings have been changed.

(If a door is not opened within 60 seconds after is  pressed, the doors will be locked again and the alarm will automatically be set.) In a case that the alarm is triggered, immediately stop the alarm.

Operations using the wireless remote control

Lock/unlock the doors using wireless remote control

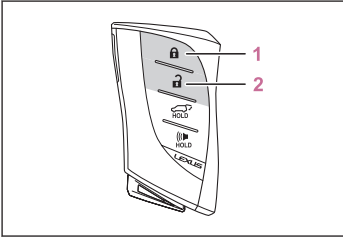

1 Locks all the doors

Check that the door is securely locked.

2 Unlocks all the doors

Pressing the button unlocks the driver's door.

Pressing the button again within 3 seconds unlocks the other doors.

INFORMATION

■ Theft deterrent panic mode

When  is pressed for longer than about 1 second, an alarm will sound intermittently and the vehicle lights will flash to deter any person from trying to break into or damage your vehicle.

To stop the alarm, press any button on the electronic key.

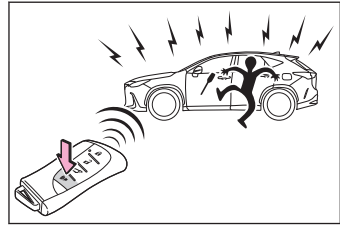

Using the door lock switches

Locking/unlocking the doors with the door lock switches

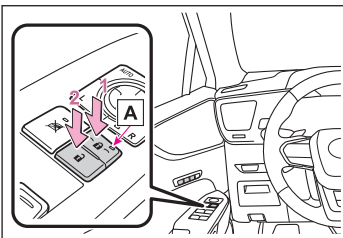

1 Press the switch.

All of the doors will lock.

The indicator  **A** comes on.

2 Press the switch.

All of the doors will unlock.

The indicator  **A** turns off.

Close & lock (walk away) function^{*2}

When the power back door is open, all of the doors will be locked when the power back door is closed.

INFORMATION

■ **Close & lock (walk away) function operating conditions**

This function can be operated when all of the following conditions are met:

- An electronic key is not detected within the vehicle.
- All of the doors other than the power back door are closed.
- The brake pedal is not depressed.
- The power switch is off.



■ **Hands free close & lock (walk away) function* operating conditions**

This function can be operated when all of the following conditions are met:

- The hands free close & lock function setting is on.
- The Hands Free Power Back Door operating conditions are met.
- An electronic key is not detected within the vehicle.
- All of the doors other than the power back door are closed.
- The brake pedal is not depressed.
- The power switch is off.

■ **Situations in which the close & lock (walk away) function may not operate properly**

In the following situations, the close & lock function may not operate properly:

- If the  switch on the lower part of the power back door is pressed by a hand which is holding an electronic key
- If the  switch on the lower part of the power back door is pressed when the electronic key is in a bag, etc. that is placed on the ground
- If the  switch on the lower part of the power back door is pressed with the electronic key not near the vehicle

*2: For the initial setting, the close and lock function cannot be used with the digital key alone.

*: If equipped

Closing the back door and lock all of the doors

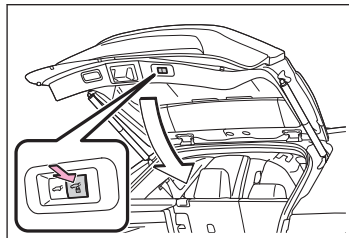

- 1 Perform the following procedure with no electronic keys for this vehicle inside the vehicle. When the power back door is closed, all of the doors will lock.

Using the switch:

- 2 While carrying an electronic key, press the  switch on the lower part of the power back door.

When you move away from the power back door, it will automatically fully close.

If the power back door is approached while carrying an electronic key, the closing operation will stop.

A different buzzer than normal will sound. When the power back door is closed, door lock operation signals will indicate that all of the doors have been locked.

Vehicles with Hands Free Power Back Door:^{*3}

- 3 If the power back door is closed using a hands free power back door close operation while carrying an electronic key, all of the doors will be locked at the same time.

When you move away from the power back door, it will automatically fully close.

If the power back door is approached while carrying an electronic key, the closing operation will stop.

A different buzzer than normal will sound. When the power back door is closed, door lock operation signals will indicate that all of the doors have been locked.

WARNING

When closing the power back door using the close & lock function, a different buzzer than the normal one will sound before the operation begins.

To check that the operation has started correctly, check that a different buzzer than the normal one has sounded.

Additionally, when the power back door is fully closed and locked, operation signals will indicate that all of the doors have been locked.

^{*3}: This setting can be customized by your Lexus dealer.

⚠ WARNING

Before leaving the vehicle, make sure that the operational signals have operated and that all of the doors are locked.

Theft deterrent system

This vehicle is equipped with an immobilizer system and alarm system to help prevent vehicle theft. The immobilizer is a system which helps prevent intrusion into the vehicle and starting of the hybrid system using keys other than a key registered to this vehicle. Through a transponder chip built into the keys, registered keys can be recognized over unauthorized copies. The alarm uses light and sound to give an alert when an intruder is detected.

INFORMATION

■ Note for the entry function

The immobilizer system is designed to help prevent vehicle theft but does not guarantee absolute security against all vehicle thefts.

■ System maintenance

The immobilizer system and alarm system are maintenance-free.

■ Triggering of the alarm

The alarm may be triggered in the following situations:

- The doors are unlocked using the mechanical key.

If a door is unlocked using the mechanical key while the alarm is set, a warning will sound intermittently for approximately 10 seconds. If the alarm is not canceled or stopped during this time, the warning pattern changes and the warning sounds for a certain period of time.

- A person inside the vehicle opens a door or the hood, or unlocks the vehicle using the lock lever on an inside door handle.
- The 12-volt battery is recharged or replaced when the vehicle is locked.
- A locked door is unlocked or opened in any way other than using the entry function, wireless remote control or mechanical key. (The doors will lock again automatically.)
- The hood is opened from outside of the vehicle.

■ Alarm-operated door lock function operating conditions

In the following cases, depending on the situation, the door may automatically lock to prevent improper entry into the vehicle:

- When a person remaining in the vehicle unlocks the door and the alarm is activated.
- While the alarm is activated, a person remaining in the vehicle unlocks the door.
- When recharging or replacing the 12-volt battery.

Enable the immobilizer system

NOTICE

Do not modify or remove the system. If modified or removed, the proper operation of the system cannot be guaranteed.

Turn the power switch off.

When the immobilizer system is enabled, the security indicator flashes to indicate that the system is operating.

Never leave the keys inside the vehicle when you leave the vehicle.

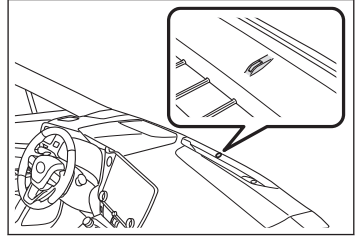

INFORMATION

■ Cancel the immobilizer system

While carrying a key registered to the vehicle, change the power switch to ACC or ON. The immobilizer system will be cancelled and the security indicator will turn off.

Setting the alarm system

Make sure of the following before setting the alarm:

- Nobody is in the vehicle.
- The windows and moon roof are closed before the alarm is set.
- No valuables or other personal items are left in the vehicle.

NOTICE

Do not modify or remove the system. If modified or removed, the proper operation of the system cannot be guaranteed.

Close the doors and hood, and lock all the doors. The system will be set automatically after 30 seconds.

The indicator light changes from being on to flashing when the system is set.

If all doors are closed with hood open, alarm system can be set.

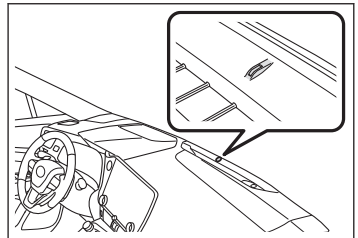

Canceling/stopping the alarm system

Do one of the following to deactivate or stop the alarms:

- Except for Canada: Unlock the doors.
- For Canada: Unlock the doors using the entry function or wireless remote control.
- Turn the power switch to ACC or ON, or start the hybrid system.

The alarm will be deactivated or stopped after a few seconds.

Loading the vehicle with luggage

Precautions for loading luggage into the luggage compartment

WARNING

■ Storage precautions

Observe the following precautions.

Failure to do so may prevent the pedals from being depressed properly, may block the driver's vision, or may result in items hitting the driver or passengers, possibly causing an accident.

- The following things may cause a fire if loaded in the luggage compartment:
 - Receptacles containing gasoline
 - Aerosol cans
- Stow cargo and luggage in the luggage compartment whenever possible.
- Do not stack cargo and luggage in the luggage compartment higher than the seat-backs.
- When you fold down the rear seats, long items should not be placed directly behind the front seats.
- Never allow anyone to ride in the luggage compartment.
It is not designed for passengers.
They should ride in their seats with their seat belts properly fastened.
- Do not place cargo or luggage in or on the following locations.
 - At the feet of the driver
 - On the front passenger or rear seats (when stacking items)
 - Luggage cover
 - On the instrument panel
 - On the dashboard
- Secure all items in the occupant compartment.

■ Precautions regarding weight capacity and distribution

- Do not exceed the maximum axle weight rating or the total vehicle weight rating.
- Even if the total load of occupant's weight and the cargo load is less than the total load capacity, do not apply the load unevenly. Improper loading may cause deterioration of steering or braking control which may cause death or serious injury.

■ When using a roof luggage carrier (vehicles with roof rails)

Observe the following precautions:

⚠ WARNING

- Place the cargo so that its weight is distributed evenly between the front and rear axles.
- If loading long or wide cargo, never exceed the vehicle overall length or width.
- Before driving, make sure the cargo is securely fastened on the roof luggage carrier.
- Loading cargo on the roof luggage carrier will make the center of gravity of the vehicle higher.
Avoid high speeds, sudden starts, sharp turns, sudden braking, or abrupt maneuvers. The vehicle may not be able to be controlled correctly and may rollover.
- If driving for a long distance, on rough roads, or at high speeds, stop the vehicle now and then during the trip to make sure the cargo remains in its place.
- Do not exceed 176.3 lb. (80 kg) cargo weight on the roof luggage carrier.

⚠ NOTICE

Do not set luggage on the moon roof. Failure to observe so may lead to cause damage.

Calculating cargo capacity

The cargo capacity can be calculated using the following formula.

$$(\text{Cargo capacity}) = (\text{Total load capacity}) - (\text{Total weight of occupants})$$

Steps for Determining Correct Load Limit—

- 1 Locate the statement “The combined weight of occupants and cargo should never exceed XXX kg or XXX lbs.” on your vehicle’s placard.
- 2 Determine the combined weight of the driver and passengers that will be riding in your vehicle.
- 3 Subtract the combined weight of the driver and passengers from XXX kg or XXX lbs.
- 4 The resulting figure equals the available amount of cargo and luggage load capacity. For example, if the “XXX” amount equals 1400 lbs. and there will be five 150 lb passengers in your vehicle, the amount of available cargo and luggage load capacity is 650 lbs. $(1400 - 750 (5 \times 150) = 650 \text{ lbs.})$
- 5 Determine the combined weight of luggage and cargo being loaded on the vehicle. That weight may not safely exceed the available cargo and luggage load capacity calculated in Step 4.

- 6 If your vehicle will be towing a trailer, load from your trailer will be transferred to your vehicle. Consult this manual to determine how this reduces the available cargo and luggage load capacity of your vehicle.

Vehicles without towing package: Lexus does not recommend towing a trailer with your vehicle. Your vehicle is not designed for trailer towing.

Calculation formula for your vehicle

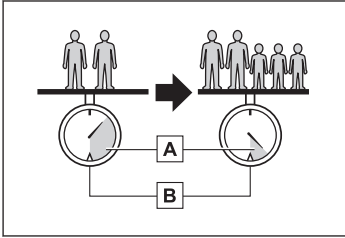

A Cargo capacity

B Total load capacity (vehicle capacity weight)

When 2 people with the combined weight of A lb. (kg) are riding in your vehicle, which has a total load capacity (vehicle capacity weight) of B lb. (kg), the available amount of cargo and luggage load capacity will be C lb. (kg) as follows:

$$B^{*2} \text{ lb. (kg)} - A^{*1} \text{ lb. (kg)} = C^{*3} \text{ lb. (kg)}$$

In this condition, if 3 more passengers with the combined weight of D lb. (kg) get on, the available cargo and luggage load will be reduced E lb. (kg) as follows:

$$C \text{ lb. (kg)} - D^{*4} \text{ lb. (kg)} = E^{*5} \text{ lb. (kg)}$$

As shown in the example above, if the number of occupants increases, the cargo and luggage load will be reduced by an amount that equals the increased weight due to the additional occupants.

In other words, if an increase in the number of occupants causes an excess of the total load capacity (combined weight of occupants plus cargo and luggage load), you must reduce the cargo and luggage on your vehicle.

Back door functions and operation

The back door can be locked/unlocked and opened/closed by the following procedures.

*1: A = Weight of people

*2: B = Total load capacity

*3: C = Available cargo and luggage load

*4: D = Additional weight of people

*5: E = Available cargo and luggage load

⚠ WARNING**■ Before driving the vehicle**

Observe the following precautions.

Before driving the vehicle, make sure that the power back door is fully closed. If the power back door is not fully closed, it may open unexpectedly while driving, causing an accident.

■ Caution while driving

- Keep the power back door closed while driving.

If the power back door is left open, it may hit nearby objects while driving or luggage may be unexpectedly thrown out, causing an accident.

In addition, exhaust gases may enter the vehicle, causing death or a serious health hazard. Make sure to close the power back door before driving.

- Never let anyone sit in the luggage compartment.

In the event of sudden braking, sudden swerving or a collision, they are susceptible to death or serious injury.

■ When children are in the vehicle

Observe the following precautions.

- Do not allow children to play in the luggage compartment.

If a child is accidentally locked in the luggage compartment, they could have heat exhaustion or other injuries.

- Do not allow a child to open or close the power back door.

Doing so may cause the power back door to move unexpectedly, or cause the child's hands, arms, head, or neck to be caught by the closing power back door.

■ Operating the power back door

Observe the following precautions.

- Remove any heavy loads, such as snow and ice, from the power back door before opening it. Failure to do so may cause the power back door to suddenly shut again after it is opened.

- When opening or closing the power back door, thoroughly check to make sure the surrounding area is safe.

- If anyone is in the vicinity, make sure they are safe and let them know that the power back door is about to open or close.

- Use caution when opening or closing the power back door in windy weather as it may move abruptly in strong wind.

- The power back door may suddenly shut if it is not opened fully. It is more difficult to open or close the back door on an incline than on a level surface, so beware of the

▲ WARNING

back door unexpectedly opening or closing by itself. Make sure that the back door is fully open and secure before using the luggage compartment.

- When closing the power back door, take extra care to prevent your fingers, etc., from being caught.
- When closing the power back door, make sure to press it lightly on its outer surface. If the back door handle is used to fully close the power back door, it may result in hands or arms being caught.
- Do not pull on the back door spindle to close the power back door, and do not hang on the back door spindle.

Doing so may cause hands to be caught or the back door spindle to break, causing an accident.

- If a bicycle carrier or similar heavy object is attached to the power back door, it may suddenly shut again after being opened, causing someone's hands, arms, head or neck to be caught and injured. When installing an accessory part to the power back door, using a genuine Lexus part is recommended.

■ Back door closer

- In the event that the power back door is left slightly open, the back door closer will automatically close it to the fully closed position. It takes several seconds before the back door closer begins to operate. Be careful not to get fingers caught or anything else in the power back door, as this may cause bone fractures or other serious injuries.
- Use caution when using the back door closer as it still operates when the power back door system is disabled.

■ Power back door

Observe the following precautions.

- Check the safety of the surrounding area to make sure there are no obstacles or anything that could cause any of your belongings to get caught.
- If anyone is in the vicinity, make sure they are safe and let them know that the power back door is about to open or close.
- If the power back door system is disabled while the power back door is operating, the power back door will stop operating. The power back door must then be operated manually. Take extra care in this situation, as the power back door may open or close suddenly.
- If the operating conditions of the power back door are no longer met, a buzzer may sound and the power back door may stop opening or closing. The power back door must then be operated manually. Take extra care on an incline in this situation, as the power back door may move suddenly.

⚠ WARNING

- On an incline, the power back door may suddenly shut after it opens. Make sure the power back door is fully open and secure.
- In the following situations, the power back door may detect an abnormality and automatic operation may be stopped. In this case, the power back door must then be operated manually. Take extra care in this situation, as the stopped power back door may suddenly open or close, causing an accident.
 - When the power back door contacts an obstacle
 - When the 12-volt battery voltage suddenly drops, such as when the power switch is turned to ON or the hybrid system is started during automatic operation
- If a bicycle carrier or similar heavy object is attached to the power back door, the power back door may not operate, causing a malfunction, or the power back door may suddenly shut again after being opened, causing someone's hands, arms, head or neck to be caught and injured. When installing an accessory part to the power back door, using a genuine Lexus part is recommended.

■ Jam protection function

Observe the following precautions.

- Never use any part of your body to intentionally activate the jam protection function.
- The jam protection function may not work if something gets caught just before the power back door fully closes. Be careful not to get fingers caught or anything else.
- The jam protection function may not work depending on the shape of the object that is caught. Be careful not to catch fingers or anything else.

⚠ NOTICE**■ Precautions for the back door spindles**

The back door is equipped with spindles **A** that hold the back door in place.

Observe the following precautions. Failure to do so may cause damage to the back door spindle **A**, resulting in malfunction.

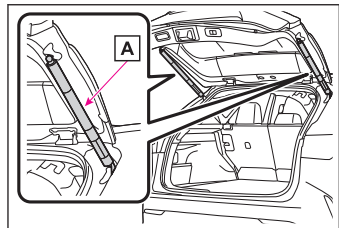

- Do not attach any foreign objects, such as stickers, plastic sheets, or adhesives to the spindle rod.
- Do not touch the spindle rod with gloves or other fabric items.
- Do not attach heavy accessories to the back door.

When attaching, ask your Lexus dealer for details.

NOTICE

- Do not place your hand on the spindle or apply lateral forces to it.

To prevent malfunction of the power back door and back door closer

Observe the following precautions. Failure to do so may lead to malfunction of the power back door or back door closer.

- Do not apply excessive force to the back door while the back door closer is operating.
- Make sure that there is no ice between the back door and frame that would prevent movement of the back door.
- Take care not to damage the sensors (installed on the right and left edges of the power back door) with a knife or other sharp object.

If the sensor is disconnected, the power back door will not close automatically.

INFORMATION

Luggage compartment light

- The luggage compartment light turns on when the back door is opened.
- If the luggage compartment light is left on when the power switch is turned off, the light will go off automatically after 20 minutes.

Power back door operating conditions

With the power back door operations set to ON, it can automatically open and close for the following conditions:

- When the electronic key is being carried and the power back door switch is pushed*⁶
- When the wireless remote control is used*⁶
- When the power switch is in ON, the back door will operate if any of the following conditions are met, in addition to the above conditions:
 - Parking brake is engaged
 - The brake pedal is depressed
 - The shift position is in P

Back door closer

In the event that the back door is left slightly open, the back door closer will automatically close it to the fully closed position.

Whatever the state of the power switch, the back door closer operates.

*⁶: When configured with the customization function so that it can be operated after being unlocked, operate the back door after it has been unlocked.

■ Operation of the power back door

- A buzzer sounds and the emergency flashers flash twice to indicate that the back door is opening/closing.
- When the power back door operations are OFF, the power back door does not operate but it can be opened and closed by hand.
- When the power back door automatically opens, if an abnormality due to people or objects is detected, operation will stop.

■ When reconnecting the 12-volt battery

To operate the power back door properly, close the back door completely by hand then operate for unlocking.

■ Jam protection function

Sensors are installed in the right and left sides of the power back door.

When the door is automatically closing and the sensors are pushed due to an object being clamped, the jam protection function operates. When the function operates, the door will automatically move slightly in the opposite direction then stop.

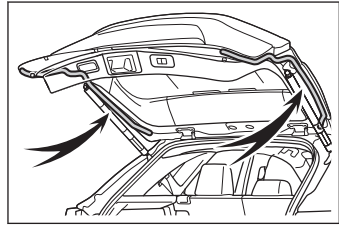

— Related Links —

[Customizable features\(P. 765\)](#)

Operating the back door using the smart access system with push-button start

The back door can be locked/unlocked while carrying an electronic key or the card key. The driver should always carry the electronic key or the card key.

Lock/unlock the back door using smart access system with push-button start

Perform the following while carrying an electronic key.

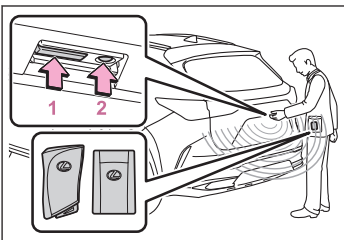

1 Press 1.

All of the doors will unlock. However, the doors cannot be unlocked within 3 seconds after they were locked.



2 Press 2.

All of the doors will lock. Make sure that the doors are securely locked.

Locking/unlocking the back door using the door lock switches

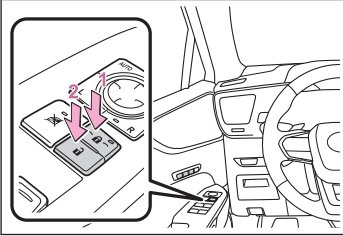
Locking/unlocking the back door using the door lock switches



- 1 Press the  switch.
All of the doors, including the back door, will lock.
- 2 Press the  switch.
All of the doors, including the back door, will unlock.

Back door operations using the wireless remote control

Opening/closing the back door using the wireless remote control

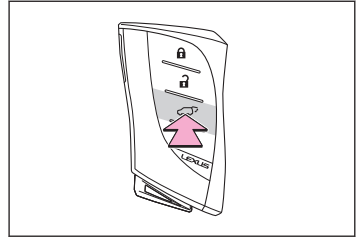



- Press  for 1 second.

The back door will open.

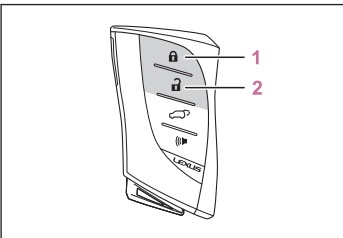
Lock/unlock the back door using wireless remote control



- 1 Press .
All of the doors, including the back door, will lock.
Make sure that the doors are securely locked.
- 2 Press .
Pressing the button unlocks the driver's door.
Pressing the button again within 3 seconds unlocks all of the other doors, including the back door.
All of the doors, including the back door, will unlock.

Back door operations using the back door operation switch inside the vehicle

Opening/closing the back door from the inside

Press the  for 1 second.

A buzzer sounds and the back door automatically opens and closes.

Pressing the  while the back door is opening/closing stops the operation.

When the  is pressed again during the halted operation, the back door will perform the reverse operation.

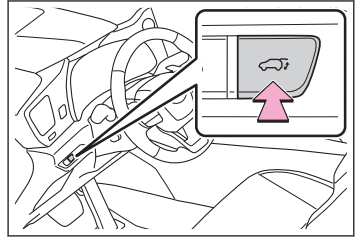



Back door operations using the back door switch

Opening/closing the back door using the back door switch

Press the  .

A buzzer sounds and the back door automatically closes.

Pressing the  while the back door is closing stops the operation.

Pressing the  again will reverse the operation.

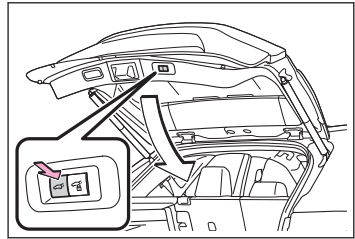

Back door operations using the back door opener switch

Open the back door automatically using the back door opener switch

Press the back door opener switch with the back door unlocked.

A buzzer sounds and the back door automatically opens.

Pressing the switch while the back door is opening stops the operation.

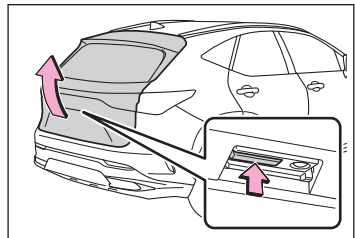

INFORMATION

Open the back door with the back door opener switch when the back door is locked

While carrying the electronic key on your person, press the back door opener switch.

1-6. Entering/exiting the vehicle and loading luggage

A buzzer sounds and the back door automatically opens.

Back door operations using the back door handle

Closing the back door automatically using the back door handle

▲ WARNING

Observe the following when closing the back door.

- When closing the back door, take extra care to prevent your fingers, etc., from being caught.
- When closing the back door, make sure to press it lightly on its outer surface.

If the back door handle is used to fully close the back door, it may result in hands or arms being caught.

- Do not pull on the back door spindle to close the back door, and do not hang on the back door spindle.

Doing so may cause hands to be caught or the back door spindle to break, causing an accident.

Pull the back door downward using the back door handle.

A buzzer sounds and the back door automatically closes.

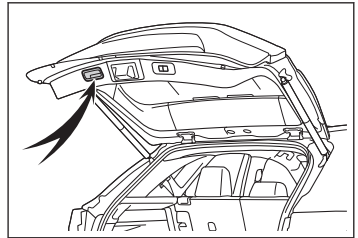

Back door operations using the kick sensor (vehicles with Hands Free Power Back Door)

▲ NOTICE

The kick sensor is located behind lower center part of the rear bumper.

Observe the following to ensure that the power back door operates properly:

- Keep the lower center part of the rear bumper clean at all times.

If the lower center part of the rear bumper is dirty or covered with snow, the kick sensor may not operate.

In this situation, clean off the dirt or snow, move the vehicle from the current position and then check if the kick sensor operates.

If it does not operate, have the vehicle inspected by your Lexus dealer.

⚠ NOTICE

- Do not apply coatings that have a rain clearing (hydrophilic) effect, or other coatings, to the lower center part of the rear bumper.
- Do not park the vehicle near objects that may move and contact the lower center part of the rear bumper, such as grass or trees.

If the vehicle has been parked for a while near objects that may move and contact the lower center part of the rear bumper, such as grass or trees, the kick sensor may not operate.

In this situation, move the vehicle from the current position and then check if the kick sensor operates.

If it does not operate, have the vehicle inspected by your Lexus dealer.

- Do not subject the kick sensor or its surrounding area to a strong impact.

If the kick sensor or its surrounding area has been subjected to a strong impact, the kick sensor may not operate properly.

If the kick sensor does not operate in the following situations, have the vehicle inspected by your Lexus dealer.

- The kick sensor or its surrounding area has been subjected to a strong impact.
- The lower center part of the rear bumper is scratched or damaged.

- Do not disassemble the rear bumper.
- Do not attach stickers to the rear bumper.
- Do not paint the rear bumper.
- If a bicycle carrier or similar heavy object is attached to the power back door, disable the kick sensor.

📖 INFORMATION**■ Kick sensor operating conditions**

- When the kick sensor operation setting is turned on
- The electronic key is within the operational range

■ Situations in which the kick sensor does not operate properly

In the following situations, the kick sensor may not operate properly:

- When a foot remains under the rear bumper
- If the rear bumper is strongly hit with a foot or is touched for a while

If the rear bumper has been touched for a while, wait for a short time before attempting to operate the back door again.

- When operated while a person is too close to the rear bumper

1-6. Entering/exiting the vehicle and loading luggage

- When an external radio wave source interferes with the communication between the vehicle and electronic key
 - When the vehicle is parked near an electrical noise source which affects the sensitivity of the kick sensor, such as a pay parking spot, gas station, electrically heated road, or fluorescent light
 - When the vehicle is near a TV tower, electric power plant, radio station, large display, airport or other facility that generates strong radio waves or electrical noise
 - When a large amount of water is applied to the rear bumper, such as when the vehicle is being washed or in heavy rain
 - When mud, snow or ice is attached to the rear bumper
 - When the vehicle has been parked for a while near objects that may move and contact the rear bumper, such as plants
 - When an accessory is installed to the rear bumper
- If an accessory has been installed, turn the kick sensor operation setting off.

■ Situations in which the kick sensor may operate unintentionally

When an electronic key is in the operation range, the kick sensor may operate unintentionally, so be careful in the following situations.

- When a large amount of water is applied to the rear bumper, such as when the vehicle is being washed or in heavy rain
- When dirt is wiped off the rear bumper
- When a small animal or small object, such as a ball, moves under the rear bumper
- When an object is moved from under the rear bumper
- If someone is swinging their legs while sitting on the rear bumper
- If the legs or another part of someone's body contacts the rear bumper while passing by the vehicle
- When the vehicle is parked near an electrical noise source which affects the sensitivity of the kick sensor, such as a pay parking spot, gas station, electrically heated road, or fluorescent light
- When the vehicle is near a TV tower, electric power plant, radio station, large display, airport or other facility that generates strong radio waves or electrical noise
- When the vehicle is parked in a place where objects such as plants are near the rear bumper
- If luggage is set near the rear bumper
- If accessories or a vehicle cover is installed/removed near the rear bumper
- When the vehicle is being towed

To prevent unintentional operation, turn the kick sensor operation setting off.

Open/close the back door using the kick sensor (vehicles with Hands Free Power Back Door)

⚠ WARNING

Observe the following precautions when operating the power back door.

- Check the safety of the surrounding area to make sure there are no obstacles or anything that could cause any of your belongings to get caught.
- When putting your foot near the lower center part of the rear bumper and moving it from the rear bumper, be careful not to touch the exhaust pipes until they have cooled down sufficiently.
If the exhaust pipes are hot, they can cause burns.
- Do not operate the Hands Free Power Back Door if there is little space under the rear bumper.

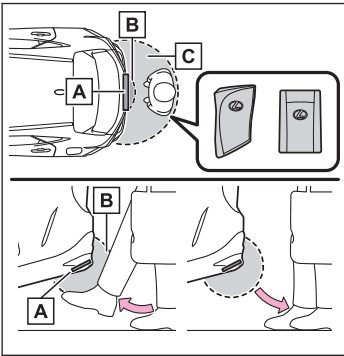

- A Kick sensor
- B Kick sensor detection area
- C Smart access system with push-button start operation detection area

1 While carrying an electronic key, stand within the smart access system with push-button start operation range, approximately 19.7 to 27.6 in. (50 to 70 cm) from the rear bumper.

2 Move your foot to approximately 3.9 in. (10 cm) from the rear bumper.

Operate the back door without contacting the rear bumper with your foot.

- 3** When a buzzer sounds, move your foot back. A buzzer will sound and the back door will automatically fully open or close.
- Perform the entire kick operation within 1 second.
 - The back door will not start operating while a foot is detected under the rear bumper.
 - If another electronic key is in the cabin or luggage compartment, it may take slightly longer than normal for the operation to occur.
 - If the buzzer sounds twice, perform a kick operation again.

If a kick operation is performed while the power back door is operating, the power back door will stop.

1-6. Entering/exiting the vehicle and loading luggage

INFORMATION

When all of the doors are locked, if a kick operation is detected by the kick sensor, all of the doors will unlock.

Adjusting the open position of the back door

The open position of the power back door can be adjusted.

- 1 Stop the back door in the desirable position.
- 2 Press and hold the  switch on the lower part of the back door for approximately 2 seconds.

When the settings are completed, the buzzer sounds 4 times.

When opening the back door the next time, the back door will stop at that position.

Canceling the adjusted open position of the back door

- Press and hold the  switch on the lower part of the back door for approximately 7 seconds.

After the buzzer sounds 4 times, it sounds twice more.

When the power back door does the opening operation the next time, the door will open to the initial settings position.

Rear seat seatbacks

Folding the seat backs can be done with their lever operations.

WARNING

When operating the rear seatback

Observe the following precautions.

- Do not operate the rear seat if it is occupied.
- After adjusting the seat, make sure that the seat is locked in position. If the seatback is not securely locked, the red marking will be visible. Make sure that the red marking is not visible.

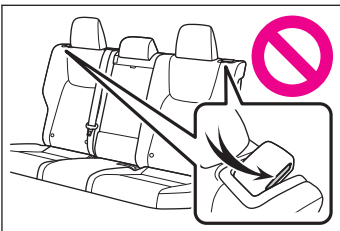

⚠ WARNING**■ When a rear seatback is folded**

Observe the following precautions.

- Do not fold down the rear seatbacks while driving.
- Stop the vehicle on level ground, apply the parking brake and change the shift position to P.
- Do not allow anyone to sit on a folded rear seatback or in the luggage compartment while driving.
- Do not allow children to enter the luggage compartment.

■ After adjusting the rear seats

Observe the following precautions.

- Make sure that the rear seatback is securely locked in position by lightly pushing it back and forth.

If the seatback is not securely locked, the red marking will be visible. Make sure that the red marking is not visible.

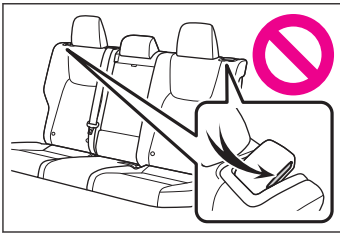

- Check that the seat belts are not twisted or caught between or behind in the rear seatback.

⚠ NOTICE

The seat belt for the rear center seat, seat belt buckles and armrest must be stowed before you fold down the rear seatbacks.

Fold the rear seatbacks

- 1 Stow the rear center seat belt, seat belt buckles and armrest.
- 2 Lower the head restraint of the rear seat.

1-6. Entering/exiting the vehicle and loading luggage

- 3 Pull the seatback angle adjustment lever and fold down the seatback.

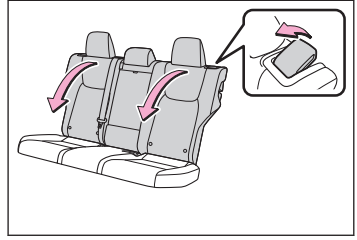

Return the rear seatbacks

- 1 Raise the rear seatback until it locks.

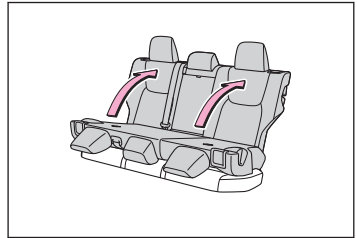

- 2 Check that the plate for each seat belt is on the front side of the seat.

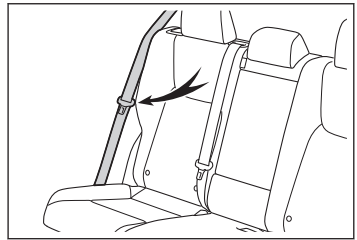

Trailer towing (vehicles with towing package)

Trailer towing

Your vehicle is designed primarily as a passenger-and-load-carrying vehicle. Towing a trailer can have an adverse impact on handling, performance, braking, durability, and fuel consumption. For your safety and the safety of others, you must not overload your vehicle or trailer. You must also ensure that you are using appropriate towing equipment, that the towing equipment has been installed correctly and used properly, and that you employ the requisite driving habits. Vehicle-trailer stability and braking performance are affected by trailer stability, brake performance and setting, trailer brakes, the hitch and hitch systems (if equipped). To tow a trailer safely, use extreme care and drive the vehicle in accordance with your trailer's characteristics and operating conditions. Lexus warranties do not apply to damage or malfunction caused by towing a trailer for commercial purposes.

Contact your Lexus dealer for further information about additional requirements such as a towing kit, etc.

INFORMATION

■ Matching trailer ball height to trailer coupler height

No matter which class of tow hitch applies, for a more safe trailer hookup, the trailer ball setup must be the proper height for the coupler on the trailer.

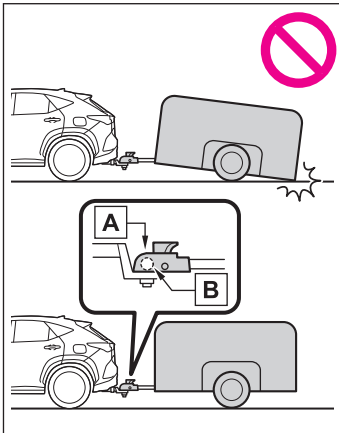

-  Coupler
-  Trailer ball

■ Before towing

Check that the following conditions are met:

- Ensure that your vehicle's tires are properly inflated.
- Trailer tires are inflated according to the trailer manufacturer's recommendation.

1-6. Entering/exiting the vehicle and loading luggage

- All trailer lights work as required by law.
- All lights work each time you connect them.
- The trailer ball is set at the proper height for the coupler on the trailer.
- The trailer is level when it is hitched.

Do not drive if the trailer is not level, and check for improper tongue weight, overloading, worn suspension, or other possible causes.

- The trailer cargo is securely loaded.
- The rear view mirrors conform to all applicable federal, state/provincial or local regulations. If they do not, install rear view mirrors appropriate for towing purposes.

■ **Adaptive Variable Suspension System (if equipped)**

The suspension can be switched for improvement in driveability.

■ **Break-in schedule**

If your vehicle is new or equipped with any new power train components (such as an engine, transmission, differential or wheel bearing), Lexus recommends that you do not tow a trailer until the vehicle has been driven for over 500 miles (800 km).

After the vehicle has been driven for over 500 miles (800 km), you can start towing. However, for the next 500 miles (800 km), drive the vehicle at a speed of less than 50 mph (80 km/h) when towing a trailer, and avoid full throttle acceleration.

■ **Maintenance**

- If you tow a trailer, your vehicle will require more frequent maintenance due to the additional load. (See "Warranty and Services Guide", "Owner's Manual Supplement" or "Scheduled Maintenance".)
- Retighten the fixing bolts of the towing ball and bracket after approximately 600 miles (1000 km) of trailer towing.

■ **If trailer sway occurs**

One or more factors (crosswinds, passing vehicles, rough roads, etc.) can adversely affect handling of your vehicle and trailer, causing instability.

- If trailer swaying occurs:
 - Firmly grip the steering wheel. Steer straight ahead.
Do not try to control trailer swaying by turning the steering wheel.
 - Begin releasing the accelerator pedal immediately but very gradually to reduce speed.
Do not increase speed. Do not apply vehicle brakes.

If you make no extreme correction with the steering or brakes, your vehicle and trailer should stabilize. (if enabled, Trailer Sway Control can also help to stabilize the vehicle and trailer.)

- After the trailer swaying has stopped:

- Stop in a safe place. Get all occupants out of the vehicle.
- Check the tires of the vehicle and the trailer.
- Check the load in the trailer.

Make sure the load has not shifted. Make sure the tongue weight is appropriate, if possible.

- Check the load in the vehicle.

Make sure the vehicle is not overloaded after occupants get in.

If you cannot find any problems, the speed at which trailer swaying occurred is beyond the limit of your particular vehicle-trailer combination. Drive at a lower speed to prevent instability. Remember that swaying of the towing vehicle-trailer increases as speed increases.

▲ WARNING

■ Trailer towing precautions

To tow a trailer safely, use extreme care and drive the vehicle in accordance with the trailer's characteristics and operating conditions. Failure to do so could cause an accident resulting in death or serious injury. Vehicle stability and braking performance are affected by trailer stability, brake setting and performance, and the hitch. Your vehicle will handle differently when towing a trailer.

■ To avoid accident or injury

- Do not exceed the TWR, unbraked TWR, GCWR, GVWR or GAWR.
- Adjust the tongue weight within the appropriate range. Place heavier loads as close to the trailer axle as possible.
- Do not exceed 65 mph (104 km/h), the posted towing speed limit or the speed limit for your trailer as set forth in your trailer owner's manual, whichever is lowest. Slow down sufficiently before making a turn, in cross winds, on wet or slippery surface, etc. to help avoid an accident. If you experience a vehicle-trailer instability from reducing a certain speed, slow down and make sure you keep your vehicle speed under the speed of which you experience the instability.
- Do not make jerky, abrupt or sharp turns.
- Do not apply the brakes suddenly as you may skid, resulting in jackknifing and loss of vehicle control. This is especially true on wet or slippery surfaces.
- Do not exceed the trailer hitch assembly weight, gross vehicle weight, gross axle weight and trailer tongue weight capacities.
- Do not use the following systems when trailer towing.
 - Dynamic radar cruise control

⚠ WARNING

- LTA (Lane Tracing Assist)
 - LDA (Lane Departure Alert)
 - PCS (Pre-Collision System)
 - BSM (Blind Spot Monitor)
- Slow down and downshift before descending steep or long downhill grades. Do not make sudden downshifts while descending steep or long downhill grades.
 - Vehicle-trailer instability is more likely on steep long downhill grades. Before descending steep or long downhill grades, slow down and downshift. Do not make sudden downshifts when descending steep or long downhill grades. Avoid holding the brake pedal down too long or applying the brakes too frequently. This could cause the brakes to overheat and result in reduced braking efficiency.

■ When towing a trailer

Lexus recommends trailers with brakes that conform to any applicable federal and state/provincial regulations.

- If the gross trailer weight exceeds unbraked TWR, trailer brakes are required. Lexus recommends trailers with brakes that conform to all applicable federal and state/provincial regulations.
- Never tap into your vehicle's hydraulic system, as this will lower the vehicle's braking effectiveness.
- Never tow a trailer without using a safety chain securely attached to both the trailer and the vehicle. If damage occurs to the coupling unit or hitch ball, there is danger of the trailer wandering into another lane.

Towing related terms

■ GCWR (Gross Combination Weight Rating)

The maximum allowable gross combination weight. The gross combination weight is the sum of the total vehicle weight (including the occupants, cargo and any optional equipment installed on the vehicle) and the weight of the trailer being towed (including the cargo in the trailer).

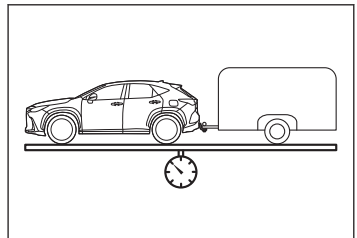

■ GVWR (Gross Vehicle Weight Rating)

The maximum allowable gross vehicle weight. The gross vehicle weight is the total weight of the vehicle. When towing a trailer, it is the sum of the vehicle weight (including the occupants, cargo and any optional equipment installed on the vehicle) and the tongue weight.

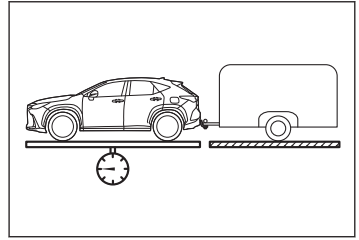

■ GAWR (Gross Axle Weight Rating)

The maximum allowable gross axle weight. The gross axle weight is the load placed on each axle (front and rear).

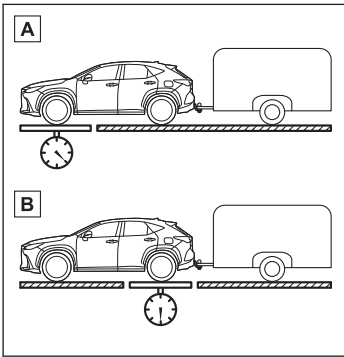

- A Front GAWR
- B Rear GAWR

■ TWR (Trailer Weight Rating)

The maximum allowable gross trailer weight. The gross trailer weight is the sum of the trailer weight and the weight of the cargo in the trailer.

TWR is calculated assuming base vehicle with one driver, one front passenger, towing package (if available), hitch and hitch systems (if required).

Additional optional equipment, passengers and cargo in the vehicle will reduce the trailer weight rating so as not to exceed GCWR, GVWR and GAWR.

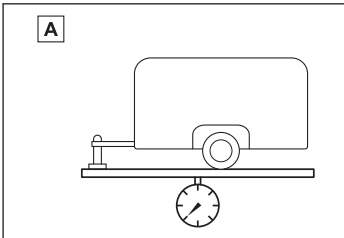

- A With brakes

■ Unbraked TWR (Unbraked Trailer Weight Rating)

The trailer weight rating for towing a trailer without a trailer service brake system.

1-6. Entering/exiting the vehicle and loading luggage

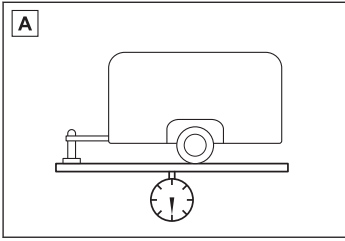

A Without brakes

■ Tongue Weight

The load placed on the trailer hitch ball.

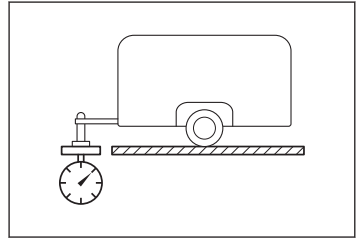

Weight limits

- The gross trailer weight must never exceed 2000 lb. (910 kg).
- The gross combination weight must never exceed 6600 lb. (2995 kg)

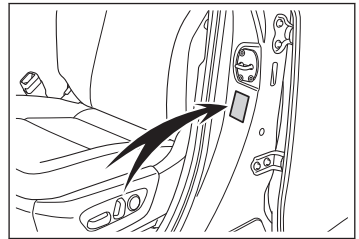

- The gross vehicle weight must never exceed the GVWR indicated on the Certification Label.
- The gross axle weight on each axle must never exceed the GAWR indicated on the Certification Label.
- If the gross trailer weight is over the unbraked TWR, trailer service brakes are required.

GCWR, TWR and Unbraked TWR

Confirm that the gross trailer weight, gross combination weight, gross vehicle weight, gross axle weight and tongue weight are all within the limits.

■ GCWR*1

6600 lb. (2995 kg)

■ TWR*¹

2000 lb. (910 kg)

■ Unbraked TWR*¹

1000 lb. (450 kg)

Trailer Tongue Weight

- A recommended tongue weight varies in accordance with the types of trailers or towing as described below.
- To ensure the recommended values shown below, the trailer must be loaded by referring to the following instructions.

- Tongue Weight

The gross trailer weight should be distributed so that the tongue weight is 9% to 11%.
(Tongue weight /Gross trailer weight x 100 = 9% to 11%)

The gross trailer weight, gross axle weight and tongue weight can be measured with platform scales found at a highway weighing station, building supply company, trucking company, junk yard, etc.

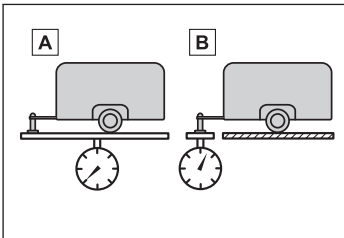

A Gross trailer weight

B Tongue weight

Hitch

Trailer hitch assemblies have different weight capacities. Lexus recommends the use of Lexus hitch/bracket for your vehicle. For details, contact your Lexus dealer.

- If you wish to install a trailer hitch, contact your Lexus dealer.
- Use only a hitch that conforms to the gross trailer weight requirement of your vehicle.
- Follow the directions supplied by the hitch manufacturer.
- Lubricate the hitch ball with a light coating of grease.
- Remove the hitch ball whenever you are not towing a trailer. Remove the trailer hitch if you do not need it. After removing the hitch, seal any mounting hole in the vehicle body to prevent entry of any substances into the vehicle.

*1: These models meet the tow-vehicle trailering requirement of SAE International per SAE J2807.

⚠ WARNING

Trailer hitch assemblies have different weight capacities established by the hitch manufacturer. Even though the vehicle may be physically capable of towing a higher weight, the operator must determine the maximum weight rating of the particular hitch assembly and never exceed the maximum weight rating specified for the trailer-hitch. Exceeding the maximum weight rating set by the trailer-hitch manufacturer can cause an accident resulting in death or serious personal injuries.

⚠ NOTICE

When installing a trailer hitch, use only the position recommended by your Lexus dealer. Do not install the trailer hitch on the bumper; this may cause body damage.

Positions for towing hitch receiver and hitch ball

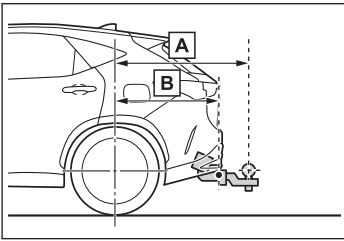

- A** Weight carrying ball position: 43.0 in. (1093.0 mm)
- B** Hitch receiver pin hole position: 34.6 in. (880.0 mm)

Connecting trailer lights

Please consult your dealer when installing trailer lights, as incorrect installation may cause damage to the vehicle's lights. Please take care to comply with your state's laws when installing trailer lights.

⚠ NOTICE

Do not directly splice trailer lights. Directly splicing trailer lights may damage your vehicle's electrical system and cause a malfunction.

Trailer towing tips

Your vehicle will handle differently when towing a trailer. Help to avoid an accident, death or serious injury, keep the following in mind when towing:

- Speed limits for towing a trailer vary by state or province. Do not exceed the posted towing speed limit.
- Lexus recommends that the vehicle-trailer speed limit is 65 mph (104 km/h) on a flat, straight, dry road. Do not exceed this limit, the posted towing speed limit or the speed limit for your trailer as set forth in your trailer owner's manual,

whichever is lowest. Instability of the towing vehicle-trailer combination (trailer sway) increases as speed increases. Exceeding speed limits may cause loss of control.

- Before starting out, check the trailer lights, tires and the vehicle-trailer connections. Recheck after driving a short distance.
- Practice turning, stopping and reversing with the trailer attached in an area away from traffic until you become accustomed to the feel of the vehicle-trailer combination.
- Reversing with a trailer attached is difficult and requires practice. Grip the bottom of the steering wheel and move your hand to the left to move the trailer to the left. Move your hand to the right to move the trailer to right. (This is generally opposite to reversing without a trailer attached.) Avoid sharp or prolonged turning. Have someone guide you when reversing to reduce the risk of an accident.
- As stopping distance is increased when towing a trailer, vehicle-to-vehicle distance should be increased. For each 10 mph (16 km/h) of speed, allow at least one vehicle and trailer length.
- Avoid sudden braking as you may skid, resulting in the trailer jackknifing and a loss of vehicle control. This is especially true on wet or slippery surfaces.
- Avoid jerky starts or sudden acceleration.
- Avoid jerky steering and sharp turns, and slow down before making turn.
- Note that when making a turn, the trailer wheels will be closer than the vehicle wheels to the inside of the turn. Compensate by making a wider than normal turning radius.
- Slow down before making a turn, in cross winds, on wet or slippery surfaces, etc. Increasing vehicle speed can destabilize the trailer.
- Take care when passing other vehicles. Passing requires considerable distance. After passing a vehicle, do not forget the length of your trailer, and be sure you have plenty of room before changing lanes.
- To maintain engine braking efficiency and charging system performance when using engine braking, do not put the transmission in D. If in the S mode, the hybrid transmission shift range position must be in 5 or lower.
- Instability happens more frequently when descending steep or long downhill grades. Before descending, slow down and downshift. Do not make sudden downshifts while descending steep or long downhill grades.

1-6. Entering/exiting the vehicle and loading luggage

- Avoid holding the brake pedal down too long or applying the brakes too frequently. This could cause the brakes to overheat and result in reduced braking efficiency.
- Due to the added load of the trailer, your vehicle's engine may overheat on hot days (at temperatures over 85°F [30°C]) when driving up a long or steep grade. If the high coolant temperature warning light comes on, it indicates that the engine is overheating. Immediately turn off the air conditioning (if in use), pull your vehicle off the road and stop in a safe spot.

Parking on a slope when towing a trailer

Always place wheel blocks under both the vehicle's and the trailer's wheels when parking. Put the transmission in P and apply the parking brake. Avoid parking on a slope, but if unavoidable, do so only after performing the following:

- 1 Apply the brakes and keep them applied.
- 2 Have someone place wheel blocks under both the vehicle's and trailer's wheels.
- 3 When the wheel blocks are in place, release the brakes slowly until the blocks absorb the load.
- 4 Shift into P and apply the parking brake.
- 5 Turn off the hybrid system.

Starting off on a slope when towing a trailer

- 1 With the transmission in the P, start the hybrid system.
- 2 Be sure to keep the brake pedal depressed.
- 3 Shift into a forward gear.
If reversing, shift into R.
- 4 If the parking brake is in manual mode, release the parking brake.
- 5 Release the brake pedal, and slowly pull or back away from the wheel blocks. Stop and apply the brakes.
- 6 Have someone retrieve the blocks.

Trailer towing (vehicles without towing package)

Lexus does not recommend towing a trailer with your vehicle. Lexus also does not recommend the installation of a tow hitch or the use of a tow hitch carrier for a wheelchair, scooter, bicycle, etc. Your vehicle is not designed for trailer towing or for the use of tow hitch mounted carriers.



Dinghy towing

Your vehicle is not designed to be dinghy towed (with 4 wheels on the ground) behind a motor home.

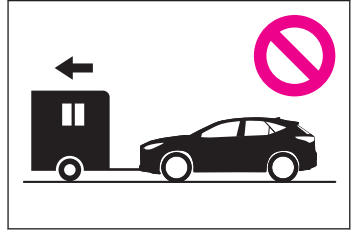

NOTICE

■ To avoid serious damage to your vehicle

Do not tow your vehicle with the four wheels on the ground.

■ To prevent causing serious damage to the hybrid transmission and AWD system

Never tow this vehicle with any of the wheels on the ground. This may cause serious damage to the hybrid transmission and AWD system.

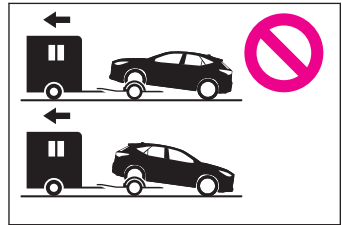

Opening and closing the windows

▲ WARNING

Observe the following precautions. The driver is responsible for all power window operations, including the operation for the passengers.

- Do not let a child operate the power windows. Operation by a child may cause a child or other passengers to have a body part caught in a power window. Also, when riding with a child, it is recommended to turn the window lock switch on.
- Check to make sure that all passengers do not have any part of their body in a position where it could be caught when a window is being operated.
- When exiting the vehicle, turn the power switch off, carry the key and exit the vehicle along with the child. There may be accidental operation, due to mischief, etc., that may possibly lead to an accident.

□ INFORMATION

■ Operating conditions of the power windows

The power switch is in ON.

■ Operating the power windows after turning the hybrid system off

The power windows can be operated for approximately 45 seconds after the power switch is turned to ACC or OFF.

They cannot, however, be operated once either front door is opened.

Functions which aid in safe opening and closing of the windows

The following functions aid in safe opening and closing of the windows.

● Jam protection function

If an object becomes jammed between the window and the window frame while the window is closing, window movement is stopped and the window is opened slightly.

● Catch protection function

If an object becomes caught between the door and window while the window is opening, window movement is stopped.

● Power windows open warning buzzer

A buzzer sounds and a message is shown on the multi-information display in the instrument cluster when the power switch is turned off and the driver's door is opened with the power windows open.

⚠ WARNING

■ Jam protection function

- Never use any part of your body to intentionally activate the jam protection function.
- The jam protection function may not work if something gets jammed just before the window is fully closed.

Be careful not to get any part of your body jammed in the window.

■ Catch protection function

- Never use any part of your body or clothing to intentionally activate the catch protection function.
- Be careful not to get any part of your body or clothing caught in the window. The catch protection function may not work if something gets caught just before the window is fully opened.

Operations using the power window switches

Opening/closing the windows using the power window switch

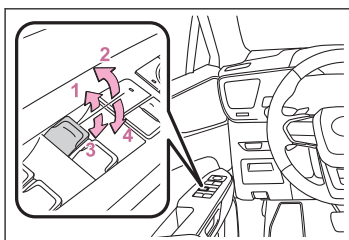

- 1** Lift the power window switch partway.
The window will close while the switch is lifted.
- 2** Fully lift the power window switch.
The window will fully close automatically.
To stop the window partway, operate the switch in the opposite direction.
- 3** Push the power window switch partway.
The window will open while the switch is pushed.
- 4** Fully push the power window switch.
The window will fully open automatically.
To stop the window partway, operate the switch in the opposite direction.

Operations using the wireless remote control

The power windows can be opened using the wireless remote control.*¹

*1: These settings must be customized at your Lexus dealer.

⚠ WARNING

When using the wireless remote control to operate the power windows, operate the power windows after making sure that there is no possibility of any passenger having any of their body parts caught in a power window. Also do not let a child operate the windows using the wireless remote control. Children and other passengers may get caught in the power window.

Related Links

[Customizable features\(P. 765\)](#)

Open the windows using the wireless remote control

Using the wireless remote control, the doors can be unlocked and all of the windows opened at the same time.*²

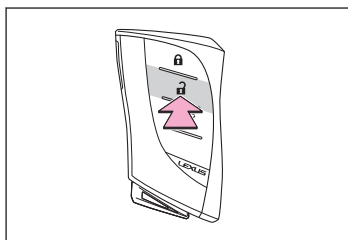

- **Push and hold the unlock switch on the wireless remote control.**

The doors will unlock and the windows and moon roof will open.

A buzzer sounds to indicate that all of the windows and the moon roof are opening.

Prevent accidental operation of the windows

The window lock switch is designed to prevent children from accidentally opening or closing a window.

Press the window lock switch.

The indicator **A** will come on and the passenger windows will be locked.

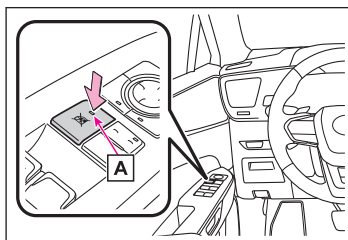

*2: This setting must be customized at your Lexus dealer.

Adjusting the seats

Adjusting the front seats

Adjust the seat forward/backward and up/down as necessary to obtain a correct posture.

- Adjust the angle of the seatback so that you are sitting straight up and so that you do not have to lean forward to steer.
- Adjust the seat so that you can depress the pedals fully and so that your arms bend slightly at the elbow when gripping the steering wheel.

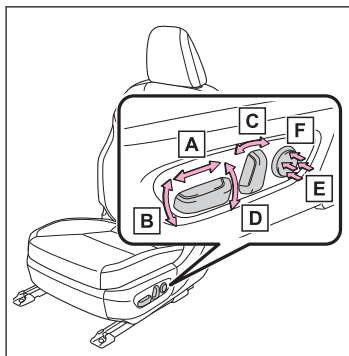

- A Seat position adjustment switch
- B Seat cushion (front) angle adjustment switch
- C Seatback angle adjustment switch
- D Vertical height adjustment switch
- E Lumbar support firmness adjustment switch (for driver's side)
- F Lumbar support height adjustment switch (for driver's side)*

INFORMATION

When adjusting the seats

Take care so that a head restraint does not contact the ceiling or a sun visor.

WARNING

Observe the following when adjusting the seats.

- Do not adjust the position of the driver's seat while driving.
Doing so could cause the driver to lose control of the vehicle.
- Be careful so that the seat does not contact and injure a passenger.
- Do not place anything under the front seats.
Objects placed under the front seats may become jammed in the seat tracks and stop the seat from locking in place. This may lead to an accident and the adjustment mechanism may also be damaged.
- Do not put your hands under the seat or near the moving parts to avoid injury.
Fingers or hands may become jammed in the seat mechanism.

*: If equipped

⚠ WARNING

- To reduce the risk of sliding under the lap belt during a collision, do not recline the seat more than necessary.
If the seat is reclined excessively, in a collision, one may slide under the lap belt and it may apply restraint forces directly to the abdomen, etc., or their neck may contact the shoulder belt.
- Do not place a cushion between the driver or passenger and the seatback.
A cushion may prevent correct posture from being achieved, and reduce the effectiveness of the seat belt and head restraint.

Adjusting the head restraints

Head restraints are provided for all seats.

⚠ WARNING

Observe the following precautions regarding the head restraints. Failure to do so may result in death or serious injury.

- Use the head restraints designed for each respective seat.
- Adjust the head restraints to the correct position at all times.
- After adjusting the head restraints, push down on them and make sure they are locked in position.
- Do not drive with the head restraints removed.

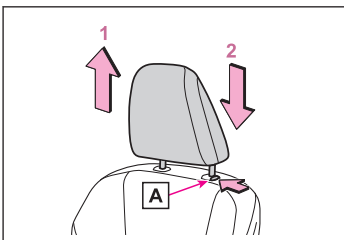
■ Adjusting the front seat head restraints vertically

1 Up

Pull the head restraints up.

2 Down

Push the head restraint down while pressing the lock release button **A**.

■ Adjusting the rear seat head restraints vertically

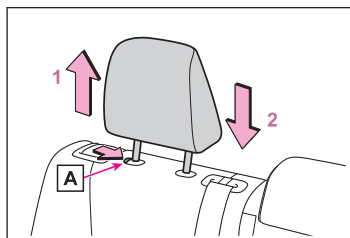

1 Up

Pull the head restraints up.

2 Down

Push the head restraint down while pressing the lock release button **A**.

□ INFORMATION

■ Adjusting the height of the head restraints

Make sure that the head restraints are adjusted so that the center of the head restraint is closest to the top of your ears

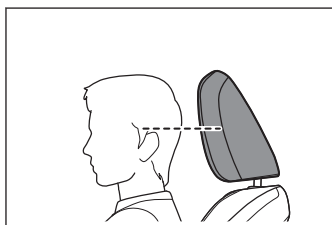

■ Adjusting the center rear seat head restraint

When the rear seat is to be used, make sure the head restraint is at least one step above the storage position.

■ Adjusting the front seat head restraints horizontally (F SPORT)

Adjustment can be performed in 4 steps.

If the head restraint is pulled forward from the foremost position, it will return to the rearmost position.

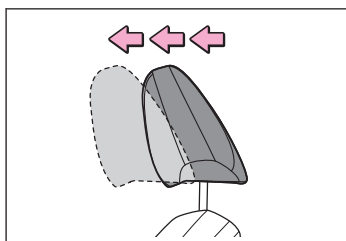

Removing the head restraints

► Front seats

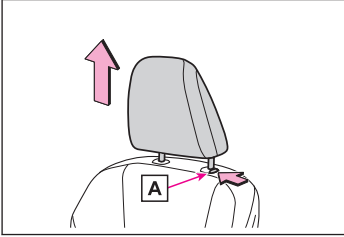

Pull the head restraint up while pressing the lock release button **A**.

If the head restraint touches the ceiling, making the removal difficult, change the seat height or angle.

► Rear seats

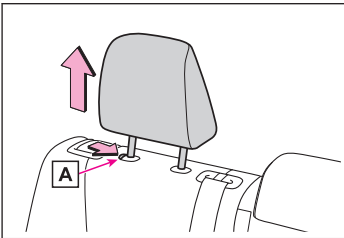

Pull the head restraint up while pressing the lock release button **A**.

Installing the head restraints

► Front seats

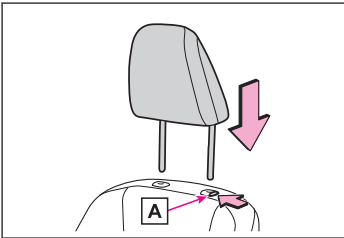

Align the head restraint with the installation holes and push it down to the lock position.

Press and hold the lock release button **A** when lowering the head restraint.

► Rear seats

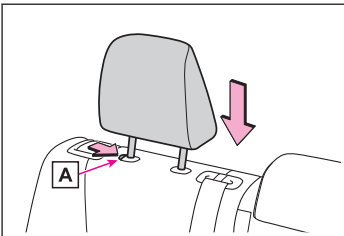

Align the head restraint with the installation holes and push it down to the lock position.

Press and hold the lock release button **A** when lowering the head restraint.

Adjusting the rear seats

Reclining adjustments and folding the seat backs can be done with the levers.

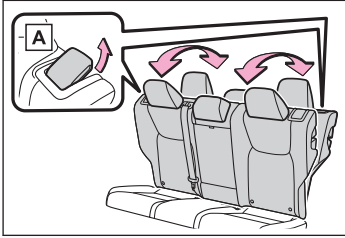

A Reclining adjustment

▲ WARNING

Observe the following when adjusting the seatbacks.

- Keep other passengers from being hit with the seatback.
- Do not bring your hands close to the moving parts or between the seats, as well as do not let any part of your body get caught.
- To reduce the risk of sliding under the lap belt during a collision, do not recline the seat more than necessary.

If the seat is reclined excessively, in a collision, one may slide under the lap belt and it may apply restraint forces directly to the abdomen, etc., or their neck may contact the shoulder belt.

Using the seat belts

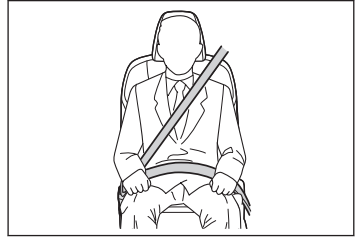

- Extend the shoulder belt so that it comes fully over the shoulder, but does not come into contact with the neck or slide off the shoulder.
- Position the lap belt as low as possible over the hips.
- Adjust the position of the seatback. Sit up straight and well back in the seat.
- Do not twist the seat belt.

⚠ WARNING

Observe the following precautions to reduce the risk of injury in the event of sudden braking, sudden swerving or an accident. Failing to do so may cause death or serious injury.

- Ensure that all passengers wear a seat belt.
- Always wear a seat belt properly.
- Each seat belt should be used by one person only.
Do not use a seat belt for more than one person at once, including children.
- Lexus recommends that children be seated in the rear seat and always use a seat belt and/or an appropriate child restraint system.
- To achieve a proper seating position, do not recline the seat more than necessary. The seat belt is most effective when the occupants are sitting up straight and well back in the seats.
- Do not wear the shoulder belt under your arm.
- Always wear your seat belt low and snug across your hips.

⚠ WARNING

- Women who are pregnant should consult their doctor for any precautions for wearing the seat belt correctly.

Position the lap belt as low as possible over the hips in the same manner as other occupants, extending the shoulder belt completely over the shoulder and avoiding belt contact with the rounding of the abdominal area.

If the seat belt is not worn properly, not only the pregnant woman, but also the fetus could suffer death or serious injury as a result of sudden braking or a collision.

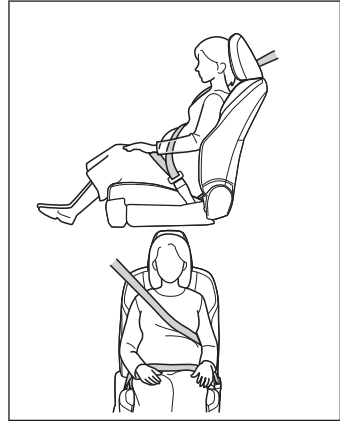

- Persons with a medical condition should consult their doctor for any precautions for wearing the seat belt correctly.
- Inspect the seat belt system periodically. Check for cuts, fraying, and loose parts. Do not use a damaged seat belt until it is replaced. Damaged seat belts cannot protect an occupant from death or serious injury.
- Replace the seat assembly, including the belts, if your vehicle has been involved in a serious accident, even if there's no obvious damage.
- Do not attempt to install, remove, modify, disassemble or dispose of the seat belts. Have any necessary repairs carried out by your Lexus dealer. Inappropriate handling may lead to incorrect operation.
- Do not allow children to play with the seat belt.

If the seat belt becomes twisted around a child's neck, it may lead to choking or other serious injuries that could result in death.

If this occurs and the buckle cannot be unfastened, scissors should be used to cut the belt.

📖 INFORMATION

■ Child seat belt usage

The seat belts of your vehicle were principally designed for persons of adult size.

- Use a child restraint system appropriate for the child, until the child becomes large enough to properly wear the vehicle's seat belt.
- When the child becomes large enough to properly wear the vehicle's seat belt, follow the instructions regarding seat belt usage.

■ Seat belt extender

If your seat belts cannot be fastened securely because they are not long enough, a personalized seat belt extender is available from your Lexus dealer free of charge.

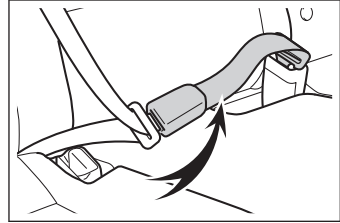

⚠ WARNING

- Do not wear the seat belt extender if you can fasten the seat belt without the extender.
- Do not use the seat belt extender when installing a child restraint system because the belt will not securely hold the child restraint system, increasing the risk of death or serious injury in the event of an accident.
- The personalized extender may not be safe on another vehicle, when used by another person, or at a different seating position other than the one originally intended.

⚠ NOTICE

When removing a seat belt extender, press the buckle release button on the extender, not on the seat belt buckle. Then, remove the extender from the seat belt buckle.

This helps prevent damage to the vehicle interior and the extender itself.

Fastening and releasing the seat belts

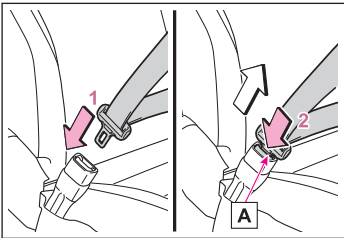

- 1 To fasten the seat belt, push the plate into the buckle until a click sound is heard.
- 2 To release the seat belt, press the release button **A**.

□ INFORMATION

■ Emergency locking retractor (ELR)

The retractor will lock the belt during a sudden stop or on impact. It may also lock if you lean forward too quickly. When the seat belt locks, pull the belt strongly and then release the belt, then a slow and easy pulling will allow the belt to extend.

1-7. Obtaining the correct driving posture

■ Automatic locking retractor (ALR)

When a passenger's shoulder belt is completely extended and then retracted even slightly, the belt is locked in that position and cannot be extended. This feature is used to hold the child restraint system (CRS) firmly. To free the belt again, fully retract the belt and then pull the belt out once more.

▲ WARNING

- Do not damage the seat belts by allowing the belt, plate, or buckle to be jammed in the door.
- Ensure that the belt and plate are locked and the belt is not twisted.

If the seat belt does not function correctly, immediately contact your Lexus dealer.

Adjusting the height of the front seat belts

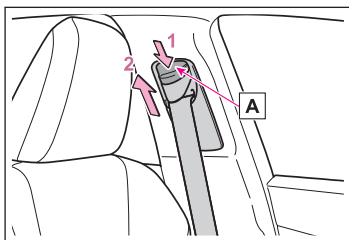

- 1 Push the seat belt shoulder anchor down while pressing the release button **A**.
- 2 Push the seat belt shoulder anchor up while pressing the release button **A**.

Move the height adjuster up and down as needed until you hear a click.

▲ WARNING

■ Adjustable shoulder anchor

Always make sure the shoulder belt is positioned across the center of your shoulder. The belt should be kept away from your neck, but not falling off your shoulder. Failure to do so could reduce the amount of protection in an accident and cause death or serious injuries in the event of a sudden stop, sudden swerve or accident.

Adjusting the position of the steering wheel and mirrors

Adjusting the position of the steering wheel horizontally/vertically

INFORMATION

The steering wheel can be adjusted when

The power switch is in ACC or ON.*1

WARNING

Do not adjust the steering wheel while driving.

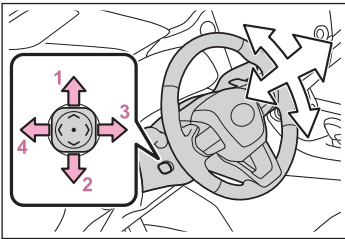

Operating the switch moves the steering wheel in the following directions:

- 1 Up
- 2 Down
- 3 Toward the driver
- 4 Away from the driver

INFORMATION

Automatic adjustment of the steering position

A desired steering position can be entered to memory and recalled automatically by the driving position memory system.

Power easy access system

The steering wheel and driver's seat move in accordance with power switch mode and the driver's seat belt condition.

Adjusting the position of the inside rear view mirror

WARNING

Do not adjust the position of the mirror while driving.

Adjust the position of the inside rear view mirror so that the correct driving posture can be achieved.

*1: If the driver's seat belt is fastened, the steering wheel can be adjusted regardless of power switch mode.

1-7. Obtaining the correct driving posture

Adjust the inside rear view mirror vertically by grasping and moving it.

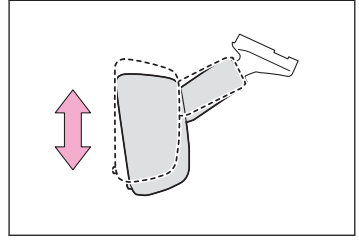

Digital Rear-view mirror effort and caution*

The Digital Rear-view Mirror is a system that uses the camera on the rear of the vehicle and displays its image on the display of the Digital Rear-view Mirror.

The Digital Rear-view Mirror can be changed between optical mirror mode and digital mirror mode by operating the lever.

The Digital Rear-view Mirror allows the driver to see the rear view despite obstructions, such as the head restraints or luggage, ensuring rear visibility. Also, the rear seats are not displayed and privacy of the passengers is enhanced.

⚠ WARNING

Observe the following precautions. Failure to do so may result in death or serious injury.

■ Before using the Digital Rear-view Mirror

- Make sure to adjust the mirror before driving.
 - Change to optical mirror mode and adjust the position of the Digital Rear-view Mirror so that the area behind your vehicle can be viewed properly.
 - Change to digital mirror mode and adjust the display settings.
- As the range of the image displayed by the Digital Rear-view Mirror is different from that of the optical mirror, make sure to check this difference before driving.

System components of the Digital Rear-view Mirror

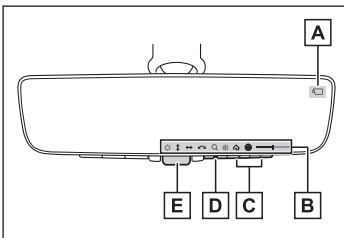

A Camera indicator

Indicates that the camera is operating normally.

B Icon display area

Displays icons, adjusting gauge, etc.

C Select/adjust button

Press to change the setting of the item you want to adjust.

*: If equipped

D Menu button

Press to display the icon display area and select the item you want to adjust.

E Lever

Operate to change between digital mirror mode and optical mirror mode.

Related Links

[Adjusting the Digital Rear-view Mirror\(P.172\)](#)

Changing modes of the Digital Rear-view Mirror

Operate the lever to change between digital mirror mode and optical mirror mode.

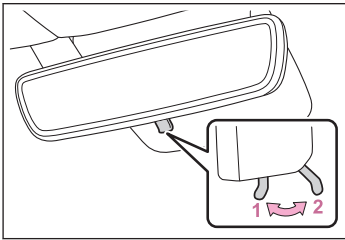
**1** Digital mirror mode

Displays an image of the area behind the vehicle.

[] will illuminate in this mode.

2 Optical mirror mode

Turns off the display of the Digital Rearview Mirror allows it to be used as an optical mirror.

Digital mirror mode operating condition

The power switch is turned to ON.

When the power switch is changed from ON to OFF or ACC, the image will disappear after several seconds.

Precautions about digital mirror mode

If it is difficult to see the displayed image due to light reflected off the Digital Rear-view Mirror, the camera being dirty or covered with water droplets, dust, etc., or if lights of a vehicle behind your vehicle or the displayed image are bothering you, change to optical mirror mode.

When it is raining, if the image is unclear due to water on the rear window, operate the rear wiper.

- When the back door is open, the Digital Rear-view Mirror image may not display properly. Before driving, make sure the back door is closed.
- If the display is difficult to see due to reflected light, close the sunshade.

1-7. Obtaining the correct driving posture

- Any of the following conditions may occur when driving in the dark, such as at night. None of them indicates that a malfunction has occurred.
 - Colors of objects in the displayed image may differ from their actual color.
 - Depending on the height of the lights of the vehicle behind, the area around the vehicle may appear white and blurry.
 - Automatic image adjustment for brighter surrounding image may cause flickering.
If it is difficult to see the displayed image or flickering bothers you, change to optical mirror mode.
- The Digital Rear-view Mirror may become hot while it is in digital mirror mode. This is not a malfunction.
- Depending on your physical condition or age, it may take longer than usual to focus on the displayed image. In this case, change to optical mirror mode.
- Do not let passengers stare at the displayed image when the vehicle is being driven, as doing so may cause motion sickness.

■ When the system malfunctions

If the symbol shown in the illustration is displayed when using the Digital Rear-view Mirror in digital mirror mode, the system may be malfunctioning. The symbol will disappear in a few seconds.

Operate the lever, change to optical mirror mode and have the vehicle inspected by your Lexus dealer.

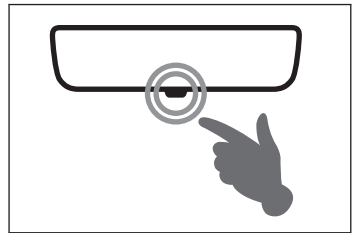

Adjusting the Digital Rear-view Mirror

Settings of the display in the digital mirror mode, on/off operation of the automatic anti-glare function, etc. can be changed.

1 Press the menu button.



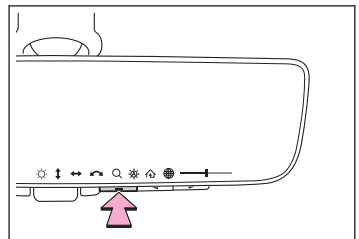





The icons will be displayed.



2 Press the menu button repeatedly and select the item you want to adjust.

3 Press [] or [] to change the setting.

The icons will disappear if a button is not operated for approximately 5 seconds or more.

Icons	Settings
	Select to adjust the brightness of the display.
	Select to adjust the area displayed up/down.
	Select to adjust the area displayed to the left/right.
	Select to adjust the angle of the displayed image.
	Select to zoom in/out the displayed image.
	Select to enable/disable the automatic anti-glare function.* ² Responding to the brightness of the headlights of vehicles behind, the reflected light is automatically adjusted. The automatic anti-glare function is enabled each time the power switch is changed to ON.
	Select to display HomeLink® Training Tutorial to assist customers to train their Garage Door Opener System.
	Select to change the language of the HomeLink® Training Tutorial.

Precautions when adjusting the Digital Rear-view Mirror

■ Display settings (digital mirror mode)

- The icons will disappear if a button is not operated for approximately 5 seconds or more.
- If the displayed image is adjusted, it may appear distorted. This is not a malfunction.

*2: This is a function for the optical mirror mode, however, the setting can also be changed while using the digital mirror mode.

1-7. Obtaining the correct driving posture

- If the brightness of the Digital Rear-view Mirror is set too high, it may cause eye strain. Adjust the Digital Rear-view Mirror to an appropriate brightness. If your eyes become tired, change to optical mirror mode.
- The brightness of the Digital Rear-view Mirror will change automatically according to the brightness of the area in front of your vehicle.

■ To prevent the light sensors from malfunctioning

To prevent the light sensors from malfunctioning, do not touch or cover them.

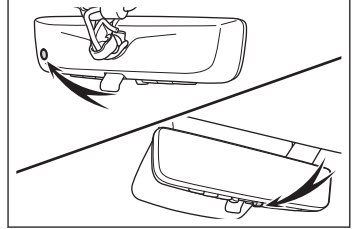

⚠ WARNING

Observe the following precautions. Failure to do so may result in death or serious injury.

■ While driving

- Do not adjust the position of the Digital Rear-view Mirror or adjust the display settings while driving.

Stop the vehicle and operate the Digital Rear-view Mirror control switches. Failure to do so may cause a steering wheel operation error, resulting in an unexpected accident.

- Always pay attention to the vehicle's surroundings.

The size of the vehicles and other objects may look different when in digital mirror mode and optical mirror mode. When backing up, make sure to directly check the safety of the area around your vehicle, especially behind the vehicle. Additionally, if a vehicle approaches from the rear in the dark, such as at night, the surrounding area may appear dim.

Cleaning the Digital Rear-view Mirror

■ Cleaning the mirror surface

If the mirror surface is dirty, the image on the display may be difficult to see. Wipe the mirror surface gently using a soft dry cloth.

INFORMATION

The camera

The camera for the Digital Rear-view Mirror is located as shown.

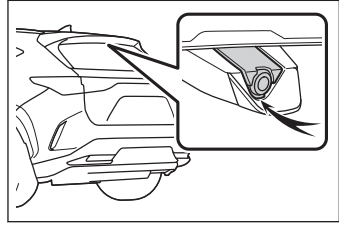

NOTICE

To prevent the camera from malfunctioning

- Observe the following precautions, otherwise the Digital Rear-view Mirror may not operate properly.
 - Do not strike or hit the camera or subject it to a strong impact, as the camera installation position and angle may be changed.
 - Do not remove, disassemble or modify the camera.
 - Do not allow an organic solvent, car wax, window cleaner or glass coating to adhere to the camera. If this happens, wipe it off as soon as possible.
 - When applying colored film (including transparent film) to the rear window glass, do not apply it to the area in front of the camera. If film is applied to the area in front of the camera, the image from the camera may not display properly.
- Do not subject the camera to a strong impact as this could cause a malfunction. If this happens, have the vehicle inspected by your Lexus dealer as soon as possible.
- Do not block the vent holes of the mirror. Otherwise, the mirror may be hot, leading to a malfunction or a fire.

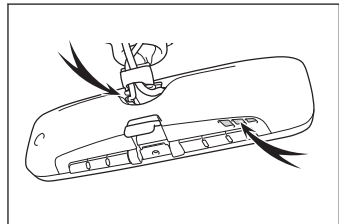





If you notice any symptoms about the Digital Rear-view Mirror

If you notice any of the following symptoms, refer to the following table for the likely cause and the solution.

If the symptom is not resolved by the solution, have the vehicle inspected by your Lexus dealer.

1-7. Obtaining the correct driving posture

Symptom	Likely cause	Solution
The image is difficult to see.	The mirror surface is dirty.	Clean the mirror surface gently, using a soft dry cloth.
	Sunlight or headlights are shining directly into the Digital Rear-view Mirror.	Change to optical mirror mode. (If the light is coming through the moon roof or panoramic moon roof, close the sunshade or electronic sunshade.)
	<ul style="list-style-type: none"> ● The vehicle is in a dark area. ● The vehicle is near a TV tower, broadcasting station, electric power plant, or other location where strong radio waves or electrical noise may be present. ● The temperature around the camera is extremely high/low. ● The ambient temperature is extremely low. ● It is raining or humid. ● Sunlight or headlights are shining directly into the camera lens. ● The vehicle is under fluorescent lights, sodium lights, mercury lights, etc. ● Exhaust gas is obstructing the camera. 	Change to optical mirror mode. (Change back to digital mirror mode when the conditions have improved.)
	Foreign matters such as water droplets or dust is on the camera lens.	Have the vehicle inspected by your Lexus dealer.
	The luggage in the luggage compartment is reflected off the rear window glass and obstructing the camera.	<ul style="list-style-type: none"> ● Change to optical mirror mode. ● Move the luggage to a position where it does not obstruct the camera or cover it with a black cloth to reduce the amount it is reflected off the rear window glass.

Symptom	Likely cause	Solution
The image is difficult to see.	The rear window glass is fogged up.	Change to optical mirror mode. After defogging the rear window using the rear window defogger, use the digital mirror mode again.
	The outside of the rear window glass is dirty.	Use the rear window wiper to remove dirt.
	The inside of the rear window glass is dirty.	Have the vehicle inspected by your Lexus dealer.
The image is out of alignment.	The back door is not fully closed.	Fully close the back door.
	The camera or its surrounding area has received a strong impact.	Change to optical mirror mode and have the vehicle inspected by your Lexus dealer.
The display is dim and  is displayed.	The system may be malfunctioning.	Change to optical mirror mode and have the vehicle inspected by your Lexus dealer.
 goes off.		
 is displayed.	The Digital Rear-view Mirror is extremely hot. (The display will gradually become more dim. If the temperature continues to increase, the Digital Rear-view Mirror will turn off.)	Reducing the cabin temperature is recommended to reduce the temperature of the mirror. ( will disappear when the mirror becomes cool.) If  does not disappear even though the mirror is cool, have the vehicle inspected by your Lexus dealer.
The lever cannot be operated properly.	The lever may be malfunctioning.	Change to optical mirror mode and have the vehicle inspected by your Lexus dealer. To change to optical mirror mode, press and hold the menu button for approximately 10 seconds.

Adjusting the angle of the outside rear view mirrors

WARNING

Do not adjust the position of the mirror while driving.

1 To select a mirror to adjust, press the switch.

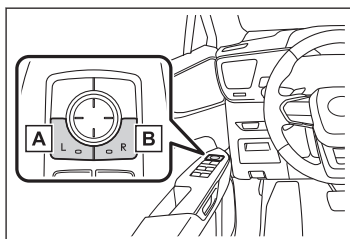

- A Select the left mirror
- B Select the right mirror

2 To adjust the mirror, press the switch.

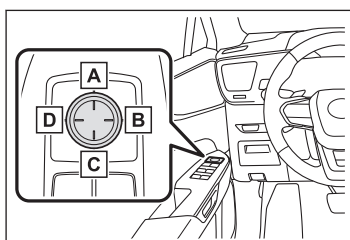

- A Adjust the mirror surface up
- B Adjust the mirror surface right
- C Adjust the mirror surface down
- D Adjust the mirror surface left

INFORMATION

■ **Mirror angle can be adjusted when**

The power switch is in ACC or ON.

■ **Automatic adjustment of the mirror angle**

A desired mirror face angle can be entered to memory and recalled automatically by the driving position memory.

■ **Linked mirror function when reversing (vehicles with driving position memory)**

When the mirror select switch is in the "L" or "R" position, the outside rear view mirrors will automatically angle downwards when the vehicle is reversing in order to give a better view of the ground.

To disable this function, move the mirror select switch to the neutral position (between "L" and "R")

With the shift position in R, adjust the mirror angle at a desired position to set the mirror angle used when the vehicle is reversing.

The adjusted angle will be memorized and the mirror will automatically tilt to the memorized angle whenever the shift position is shifted to R from next time.

The memorized downward tilt position of the mirror is linked to the normal position (angle adjusted with the shift position in other than R). Therefore, if the normal position is changed after adjustment, the tilt position will also change.

When the normal position is changed, readjust the angle in reversing.

■ Using the reverse-linked function when it is cold

When reverse-linked function used in cold weather, the door mirror could be frozen and may not automatically point the mirror surface downward. In this event, remove any ice and snow from the mirror surface.

— Related Links —

[Customizable features\(P. 765\)](#)

Folding/extending the outside rear view mirrors

▶ Using the switch

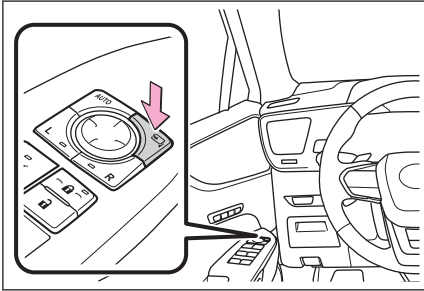

Press the switch to fold the mirrors.

Press it again to extend them to the original position.

▶ Setting automatic mode

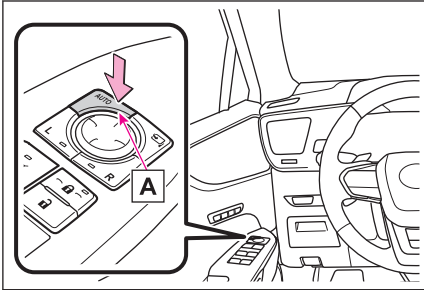

Automatic mode allows the folding or extending of the mirrors to be linked to locking/unlocking of the doors.

Press the switch to set automatic mode.

The indicator **A** will come on.

Pressing the switch once more will return to manual mode.

INFORMATION

■ Using automatic mode when it is cold

When automatic mode is used in cold weather, the door mirror could freeze up and automatic stowing and return may not be possible. In this event, after removing any ice and snow from the door mirror, operate the mirror using manual mode or move it by hand.

WARNING

Observe the following precautions.

- Do not drive with the mirrors folded.
- Do not touch an outside rear view mirror when it is moving. Failure to do so may lead to your finger being pinched or the mirror being damaged.
- As the mirror surface will be hot, do not touch an outside rear view mirror when the mirror heater is operating.
- Both the driver and passenger side mirrors must be extended and properly adjusted before driving.

2-1. Starting and stopping the hybrid system

Starting the hybrid system **182**

Stopping the hybrid system. **186**

2-2. Driving procedures

Driving procedure **188**

Breaking in your new Lexus.. **191**

Intended use of each shift position **192**

Changing the shift position .. **194**

Starting off..... **199**

Operations when turning left or right or changing lanes..... **200**

Changing the shift range..... **201**

2-3. Parking the vehicle

When parking the vehicle.... **203**

Stopping **205**

Parking the vehicle..... **207**

2-4. Refueling

Refueling **218**

2.1. Starting and stopping the hybrid system

Starting the hybrid system

Starting the hybrid system

⚠ WARNING

Always start the hybrid system while sitting in the driver's seat. Do not depress the accelerator pedal while starting the hybrid system under any circumstances.

⚠ NOTICE

■ When starting the hybrid system

If the hybrid system becomes difficult to start, have your vehicle checked by your Lexus dealer immediately.

■ Operation of the power switch

If the power switch seems to be operating somewhat differently than usual, such as the switch sticking slightly, there may be a malfunction. Contact your Lexus dealer immediately.

1 Check that the parking brake is set.

The parking brake indicator will come on.

2 Firmly depress the brake pedal.



and a message will be displayed on the multi-information display. If it is not displayed, the hybrid system cannot be started.

When the shift position is N, the hybrid system cannot start. Shift the shift position to P when starting the hybrid system.

3 Press the power switch shortly and firmly.

When operating the power switch, one short, firm press is enough. It is not necessary to press and hold the switch.

If the "READY" indicator turns on, the hybrid system will operate normally.

Continue depressing the brake pedal until the "READY" indicator is illuminated.

The hybrid system can be started from any power switch mode.

4 Check that the "READY" indicator is illuminated.

The vehicle will not move when the "READY" indicator is off.

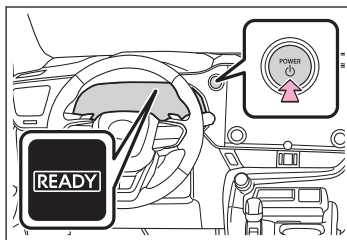

INFORMATION

■ Power switch illumination

According to the situation, the power switch illumination operates as follows.

- If a door is open or the power switch is turned from ACC or ON to OFF, the engine switch light will illuminate dimly.
- If the brake pedal is depressed while carrying an electronic key, the power switch light will illuminate brightly.
- When the power switch is in ACC or ON, the power switch illumination

■ If the hybrid system does not start

- If a message related to start-up is shown on the multi-information display, read the message and follow the instructions.

■ When the ambient temperature is low, such as during winter driving conditions

- When starting the hybrid system, the flashing time of the "READY" indicator may be long. Leave the vehicle as it is until the "READY" indicator is steady on, as steady means the vehicle is able to move.
- When the hybrid battery (traction battery) is extremely cold (below approximately -22°F [-30°C]) under the influence of the outside temperature, it may not be possible to start the hybrid system. In this case, try to start the hybrid system again after the temperature of the hybrid battery increases due to the outside temperature increase etc.

■ Steering lock function

After turning the power switch off and opening and closing the doors, the steering wheel will be locked due to the steering lock function. Operating the power switch again automatically cancels the steering lock.

■ If the "READY" indicator does not come on

In the event that the "READY" indicator does not come on even after performing the proper procedures for starting the vehicle, contact your Lexus dealer immediately.

■ Operation of the power switch

- If the switch is not pressed shortly and firmly, the power switch mode may not change or the hybrid system may not start.
- If attempting to restart the hybrid system immediately after turning the power switch off, the hybrid system may not start in some cases. After turning the power switch off, please wait a few seconds before restarting the hybrid system.

Related Links

[Manual applying/releasing of the parking brake \(manual mode\)\(P. 209\)](#)

[Shift position display and how to change the shift position\(P. 194\)](#)

Changing the power switch mode

Modes can be changed by pressing the power switch with brake pedal released. (The mode changes each time the switch is pressed.)

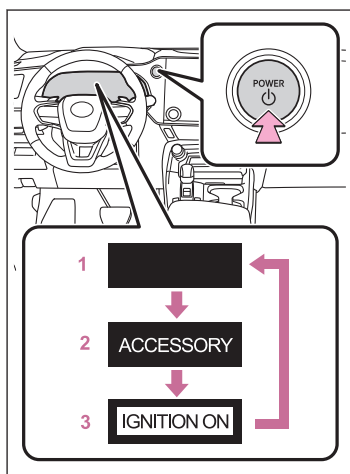

1 OFF*1

The emergency flashers can be used.

2 ACC (when customized setting is enabled)*2

Some electrical components such as the audio system can be used. "ACCESSORY" will be displayed on the multi-information display.

3 ON

All electrical components can be used.

"IGNITION ON" will be displayed on the multi-information display.

INFORMATION

■ Auto power off function

- If the vehicle is left in ACC or ON (the hybrid system is not operating) for more than 20 minutes with the shift position in P, the power switch will automatically turn to OFF.
- If the 12-volt battery is low with the shift position is in P and the power switch is in ACC or ON (the hybrid system is not operating). The power switch is automatically turn to OFF.

However, this function cannot entirely prevent the 12-volt battery discharge. Do not leave the vehicle with the power switch in ACC or ON for long periods of time when the hybrid system is not operating.

■ When the shift control system malfunctions

If the shift control system is malfunctioning, when attempting to turn the power switch off, it may not be able to be turned off. In this situation, it may be possible to turn the power switch off by applying the parking brake and then operating the power switch.

If there is a malfunction in the system, have the vehicle inspected by your Lexus dealer immediately.

*1: The engine position will remain ON when a shift position other than P is selected.

*2: This can be enabled/disabled through a customize setting.

NOTICE

Do not leave the vehicle with the power switch in ACC or ON for long periods of time when the hybrid system is not operating.

If "ACCESSORY" or "IGNITION ON" is displayed on the meters while the hybrid system is not operating, the power switch is not off. Exit the vehicle after turning the power switch off.

Related Links

[Customizable features\(P. 765\)](#)

Stopping the hybrid system

Stopping the hybrid system

WARNING

If you want to stop the hybrid system in an emergency while driving the vehicle, press and hold the power switch for more than 2 seconds, or press it briefly 3 times or more in succession.

However, do not touch the power switch while driving, except in an emergency. Turning the hybrid system off while driving will not cause loss of steering or braking control, however power assist to the steering will be lost. This will make it more difficult to steer. Pull over and stop the vehicle as soon as it is safe to do so.

1 Stop the vehicle completely.

2 Press the P position switch.

Check that the shift position indicator shows P and the parking brake indicator is illuminated.

3 Press the power switch.

The hybrid system will stop, and the meter display will be extinguished (the shift position indicator will be extinguished a few seconds after the meter display).

4 Release the brake pedal and check that the display on the instrument cluster is off.

INFORMATION

Automatic hybrid system shut off feature

- The vehicle is equipped with a feature that automatically shuts off the hybrid system when the shift position is in P with the hybrid system operating for an extended period.
- The hybrid system will automatically shut off after approximately 1 hour if it has been left running while the shift position is in P.
- The timer for the automatic hybrid system shut off feature will reset if the brake pedal is depressed or if the shift position is in a position other than P.
- After the vehicle is parked, if the door is locked with the door lock switch from the inside or the mechanical key from the outside, the automatic hybrid system shut off feature will be disabled. The timer for the automatic hybrid system shut off feature will be re-enabled if the driver's door is opened.

Related Links

[Manual applying/releasing of the parking brake \(manual mode\)\(P. 209\)](#)

Shift position display and how to change the shift position(P. 194)

Driving procedure

▲ WARNING

■ When driving the vehicle

- If the vehicle is coasting due to the hybrid system being stopped, etc., do not operate the door locks or open a door until the vehicle has been safely stopped. Doing so may cause the steering lock function to operate, possibly leading to an accident.
- When backing up, you may twist your body around, leading to difficulty in operating the pedals.
Make sure to operate the pedals properly.
- Make sure to keep a correct driving posture even when moving the vehicle only slightly. This allows you to depress the brake and accelerator pedals properly.
- Depress the brake pedal using your right foot.
Depressing the brake pedal using your left foot may delay response in an emergency, resulting in an accident.
- Do not drive the vehicle over or stop the vehicle near flammable materials. The exhaust system and exhaust gases can be extremely hot. These hot parts may cause a fire if there is any flammable material nearby.
- Never turn the power switch off during normal driving. If the hybrid system is stopped while driving, steering and brake operations will still be possible, however, power assist will no longer be provided and the steering wheel will become difficult to operate. After checking the safety of the area around your vehicle, stop the vehicle on the side of the road. In an emergency, if the vehicle cannot be stopped normally, perform an emergency stop.
- Use engine braking (downshift) to maintain a safe speed when driving down a steep hill. Using the brakes continuously may cause the brakes to overheat and lose effectiveness.
- Do not adjust the positions of the steering wheel, the seat, or the inside or outside rear view mirrors while driving. Doing so may result in a loss of vehicle control.
- Always check that all passengers' arms, heads or other parts of their body are not outside the vehicle.
- This vehicle is not designed for extreme off-roading.
 - When driving in sand or mud is unavoidable, drive carefully and avoid continuous driving on sand or mud.
 - Do not drive on extremely rocky roads or extremely uneven roads.
- Do not drive across a river or through other bodies of water. This may cause electric/electronic components to short circuit, damage the hybrid system or cause other serious damage to the vehicle.

⚠ WARNING

- Do not drive in excess of the speed limit. Even if the legal speed limit permits it, do not drive over 85 mph (140 km/h) unless your vehicle has high-speed capability tires. Driving over 85 mph (140 km/h) may result in tire failure, loss of control and possible injury. Be sure to consult a tire dealer to determine whether the tires on your vehicle are high-speed capability tires or not before driving at such speeds.
- Avoid sudden braking, acceleration, and steering inputs when driving on slick road surfaces. Doing so may cause the tires to lose traction, leading to loss of control of the vehicle.
- Avoid sudden accelerator pedal operations and shift operations when driving on slick road surfaces. Doing so may cause engine braking or changes in engine speed may cause the vehicle to slide sideways.
- After driving through a puddle, lightly depress the brake pedal to make sure that the brakes are functioning properly. Wet brake pads may prevent the brakes from functioning properly. If the brakes on only one side are wet and not functioning properly, steering control may be affected.
- When driving in sand or mud is unavoidable, drive carefully and avoid continuous driving on sand or mud.

Do not drive on extremely rocky roads or extremely uneven roads.

■ If you hear a squealing or scraping noise (brake pad wear limit indicators)

Have the brake pads checked and replaced by your Lexus dealer as soon as possible.

Rotor damage may result if the pads are not replaced when needed.

It is dangerous to drive the vehicle when the wear limits of the brake pads and/or those of the brake discs are exceeded.

⚠ NOTICE**■ Avoiding damage to vehicle parts**

- Do not turn and hold the steering wheel at either fully turned position for an extended period of time. Doing so may damage the power steering motor.
- When driving over bumps or areas where the road height changes, drive as slowly as possible. Otherwise the wheels, etc. may be damaged.

■ If you get a flat tire while driving

In the following situations, firmly hold the steering wheel and gradually apply the brakes to decrease the vehicle's speed, as a tire may be flat or damaged:

- When the steering wheel pulls either direction
- When there are abnormal sounds or vibrations
- When the vehicle leans abnormally

NOTICE

■ When encountering flooded roads

Do not drive on roads which have become flooded due to heavy rain, etc. Doing so may cause serious damage to the vehicle, such as the following:

- Engine stalling
- Shorts in electrical components
- Engine damage caused by water immersion

In the event that you drive on a flooded road and the vehicle is flooded, be sure to have your Lexus dealer check the following:

- Brake function
- Changes in quantity and quality of oil and fluid used for the engine, hybrid transmission, etc.
- Lubricant condition for the bearings and suspension joints (where possible), and the function of all joints, bearings, etc.

If the shift control system is damaged by flooding, it may not be possible to change the shift position to P, or from P to other positions.

In this case, contact your Lexus dealer.

■ Operating your vehicle in a foreign country

Comply with the relevant vehicle registration laws and confirm the availability of the correct fuel.

Breaking in your new Lexus

To extend the life of the vehicle, observing the following precautions is recommended:

- For the first 200 miles (300 km):
Avoid sudden stops.
- For the first 1000 miles (1600 km):
 - Do not drive at extremely high speeds.
 - Avoid sudden acceleration.
 - Do not drive continuously in low gears.
 - Do not drive at a constant speed for extended periods.
- For the first 500 miles (800 km):
Do not tow a trailer. (vehicles with towing package)

Intended use of each shift position

Select the shift position depending on your purpose and situation.

Shift position	Objective or function
P	Parking the vehicle/starting the hybrid system
R	Reversing
N	Neutral
D	Normal driving ⁽¹⁾
S	S mode driving ⁽²⁾

- (1) To improve fuel efficiency and reduce noise, set the shift position in D for normal driving. You can choose gear range suitable for your driving situation by operating the paddle shift switches.
- (2) By selecting shift ranges using S mode, you can control accelerating force and engine braking force.

INFORMATION

When engine braking is not performed

When the vehicle is being driven with the dynamic radar cruise control operating, engine braking will not be performed even if the following operations are performed.

- While driving in D or S position, downshifting to 5 or 4.
- When Sport mode is selected while driving in D position.

If a message about a shift operation is shown

To prevent the shift position from being selected incorrectly or the vehicle from moving unexpectedly, the shift position may be changed automatically or operating the shift lever may be required. In this case, change the shift position following the messages on the multi-information display.

WARNING

Avoid sudden accelerator pedal operations and shift operations when driving on slick road surfaces. Engine braking or changes in engine speed may cause the vehicle to slide sideways.

NOTICE

Situations where shift control system malfunctions are possible

If any of the following situations occurs, shift control system malfunctions are possible.

 **NOTICE**

Immediately stop the vehicle in a safe place on level ground, apply the parking brake, and then contact your Lexus dealer.

- When the warning message indicating the shift control system appears on the multi-information display.
- The display indicates that no shift position is selected for more than a few seconds.

■ **Hybrid battery (traction battery) charge**

If the shift position is in N, the hybrid battery (traction battery) will not be charging, even when the engine is running. Therefore, if the vehicle is left with the shift position in N, the hybrid battery (traction battery) will discharge, and this may result in the vehicle not being able to start.

Changing the shift position

⚠ WARNING

- Do not let the vehicle roll backward while a forward driving position is selected, or roll forward while the shift position is in R.
Doing so may result in an accident or damage to the vehicle.
- Do not shift the shift position to P while the vehicle is moving. Doing so can damage the transmission and may result in a loss of vehicle control.
- Do not shift the shift position to R while the vehicle is moving forward. Doing so can damage the transmission and may result in a loss of vehicle control.
- Do not shift the shift position to a driving position while the vehicle is moving backward. Doing so can damage the transmission and may result in a loss of vehicle control.
- Changing the shift position to N while the vehicle is moving will disengage the hybrid system. Regenerative braking is not available with the hybrid system disengaged.
- Be careful not to change the shift position with the accelerator pedal depressed. Changing the shift position to any positions other than P or N may lead to unexpected rapid acceleration of the vehicle that may cause an accident and result in death or serious injury. After changing the shift position, make sure to confirm the current shift position displayed on the shift position indicator inside the meter.

Related Links

If a warning message is displayed (P. 651)

Shift position display and how to change the shift position

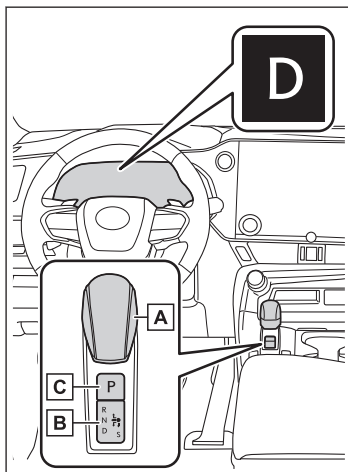

A Shift lever

Operate the shift lever gently and securely in the direction of the arrow on the shift position indicator.

To shift to N, slide the shift lever in the direction of the arrow and hold it.

Release the shift lever after each shifting operation to allow it to return to its regular position (●).

Shifting to S is only possible when the shift position is in D.

When shifting from P to N, D or R, from N, D, S or R to P, from D or M to R, or from R to D, ensure that the brake pedal is being depressed and the vehicle is stationary.

B Shift position indicator

Meter display:

The current shift position is illuminated.

Shift lever display:

The current shift position is illuminated.

When selecting the shift position, make sure that the shift position has been changed to the desired position by checking the shift position indicator provided on the instrument cluster.

C P position switch

Fully stop the vehicle and set the parking brake, and then press the P position switch.

When the shift position is changed to P, the switch illuminates.

Check that the shift position indicator shows P.

INFORMATION

Changing the shift position in each power switch mode

- The shift position cannot be changed when the power switch is in ACC or off.
- When the power switch is in ON, if the "READY" indicator is not illuminated, the shift position can only be changed to N.
- When the "READY" indicator is illuminated, the shift position can be changed from P to D, N, or R.
- When the "READY" indicator is flashing, the shift position cannot be changed from P to any other position, even if the shift lever is operated. Operate the shift lever again after the "READY" indicator changes from flashing to illuminated.

Shifting the shift position from P to other positions

- While depressing the brake pedal firmly, operate the shift lever. If the shift lever is operated without depressing the brake pedal, the buzzer will sound and the shifting operation will be disabled.
- When selecting the shift position, make sure that the shift position has been changed to the desired position by checking the shift position indicator provided on the instrument cluster.

- The shift position cannot be changed from P to S directly.

■ The shift position cannot be changed when

In the following situations, a buzzer will sound to inform you that the shift position cannot be changed. Use the appropriate operation to attempt to change the shift position again.

- When attempting to change the shift position from P with the brake pedal not depressed
- When attempting to change the shift position from P with the accelerator pedal depressed
- When attempting to change the shift position from N while stopped or driving at an extremely low speed with the brake pedal not depressed
- When attempting to change the shift position from N while stopped or driving at an extremely low speed with the accelerator pedal depressed
- When attempting to change the shift position from P or N to S
- When the P position switch is pressed while driving

When driving at an extremely low speed, the shift position may change to P.

■ The shift position automatically changes to N when

In the following situations, a buzzer will sound to inform you that the shift position has been changed to N. Use the appropriate operation to attempt to change the shift position again.

- When attempting to change the shift position to R while the vehicle is moving forward
When driving at a low speed, the shift position may change to R.
- When attempting to change the shift position to D while the vehicle is moving backward
When driving at a low speed, the shift position may change to D.
- When attempting to change the shift position from R to S

■ If the N shift position is selected while driving

If the shift lever is moved to N while driving above a certain speed, the shift position will change to N without holding the shift lever in the N position. In this situation, a buzzer will sound and a message will be displayed on the multi-information display to inform you that the shift position has been changed to N.

■ Automatic P position selection function

In the following situations, the shift position is automatically changed to P.

- When pressing the power switch with the vehicle stopped while the power switch is in ON and the shift position is in a position other than P (after the shift position has changed to P, the power switch will turn off) *1

- If the driver's door is opened and all of the following conditions are met, while the shift position is in a position other than P
 - The power switch is in ON.
 - The driver is not wearing the seat belt.
 - The brake pedal is not depressed.

To start off the vehicle after the shift position is changed to P, operate the shift lever again.

- When the vehicle is stopped after the hybrid system has been stopped in an emergency while driving.
- When voltage of the 12-volt battery drops while the shift position is in a position other than P.

■ If the shift position cannot be shifted from P

There is a possibility that the 12-volt battery is discharged. Check the 12-volt battery in this situation. (→ P.675)

▲ WARNING

■ For the shift lever

- Do not remove the shift lever knob or use anything but a genuine Lexus shift lever knob. Also, do not hang anything on the shift lever. Doing so could prevent the shift lever from returning to position, causing unexpected accidents to occur when the vehicle is in motion.
- In order to prevent the shift position from accidentally being changed, do not touch the shift lever when not using them.

■ P position switch

- Do not press the P position switch while the vehicle is moving.

If the P position switch is pressed when driving at very low speeds (for example, directly before stopping the vehicle), the vehicle may stop suddenly when the shift position switches to P, which could lead to an accident.

- In order to prevent the shift position from accidentally being changed, do not touch the P position switch when not using them.

*1: When the power switch is pressed while driving at extremely slow speeds, such as immediately before stopping the vehicle, the shift position may automatically change to P. Make sure that the vehicle is completely stopped before pressing the power switch.

NOTICE

When exiting the vehicle(driver's seat only)

Check that the shift position indicator shows P and that the parking brake indicator is illuminated before opening the door and exiting the vehicle.

When the power switch is changed to ACC with the shift position held in N

Performing the following operations allows the power switch to be set to ACC with the shift position held in N.

- 1 Operate the shift lever and change the shift position to N when the hybrid system is operating.
- 2 Return the shift lever to its regular position (●).
- 3 Operate the shift lever to N and hold it there until the buzzer sounds.
- 4 Press the power switch within 5 seconds after the buzzer sounds.

The power switch will be set to ACC with the shift position in N.*²

Make sure to check that the buzzer sounds and "Holding N Push P Switch When Done" is displayed on the multi-information display.

- To change to a shift position other than N, press the P position switch. The shift position will be changed to P.
- Even if the hybrid system is not operating, by operating the shift lever and the power switch, the power switch may be changed to ACC with the shift position held in N. Make sure that the hybrid system is operating before performing the operation.

*2: To keep this state, do not operate the power switch. If the power switch is operated repeatedly, the power switch will turn off after the shift position has automatically changed to P.

Starting off

- 1 **With the brake pedal depressed, shift the shift position to D.**

Check that the shift position indicator shows D.

▲ WARNING

Always keep your foot on the brake pedal while stopped with the "READY" indicator is illuminated. This prevents the vehicle from creeping.

- 2 **If the parking brake is set, release the parking brake.**
- 3 **Gradually release the brake pedal and gently depress the accelerator pedal to accelerate the vehicle.**

Related Links

[Manual applying/releasing of the parking brake \(manual mode\)\(P. 209\)](#)

Starting off on an incline

- 1 **Firmly depress the brake pedal and shift the shift position to D.**

The hill-start assist control will be activated.

▲ WARNING

Always keep your foot on the brake pedal while stopped with the "READY" indicator is illuminated. This prevents the vehicle from creeping.

- 2 **Set the parking brake.**
- 3 **Release the brake pedal and gently depress the accelerator pedal to accelerate the vehicle.**
- 4 **Release the parking brake.**

Related Links

[Manual applying/releasing of the parking brake \(manual mode\)\(P. 209\)](#)

Operations when turning left or right or changing lanes

By operating the turn signal lever, the intent of the driver can be shown as follows.

INFORMATION

- The turn signal lights can be operated when the power switch is in ON.
- If the indicator flashes faster than usual, check that a light bulb in the front or rear turn signal lights has not burned out.

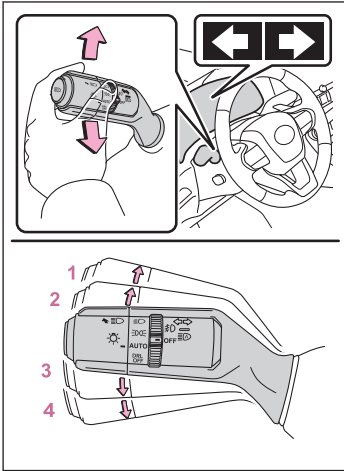

- 1 Move the lever to position 1.
The right turn signal lights will blink.
- 2 Move the lever to position 2 and release it.
The right hand signals will flash 3 times.
- 3 Move the lever to position 3 and release it.
The left hand signals will flash 3 times.
- 4 Move the lever to position 4.
The left turn signal lights will blink.

Changing the shift range

The shift range can be changed by operating the paddle shift switches. Changing the shift range enables the level of engine braking force to be selected.

Selecting shift ranges in the D position

To drive using temporary shift range selection, operate the [-] paddle shift switch with the shift position in D.

The shift range can then be selected by operating the [-] and [+] paddle shift switches.

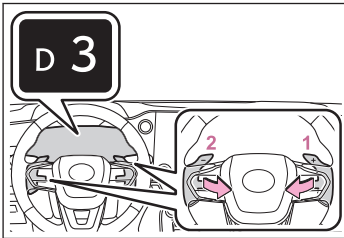

- 1 Upshift
- 2 Downshift

Selected range between D1 and D5 will be displayed on the multi-information display.

To return to normal D position driving, hold the [+] paddle shift switch for a period of time or operate the [+] paddle shift switch in the D5 range.

● Shift ranges and their functions

- You can choose from 5 levels of engine braking force.
- A lower shift range will provide greater engine braking force than a shift range. As a result, the engine speed will increase.

□ INFORMATION

■ Automatic deactivation of shift range selection in the D position

Shift range selection in the D position will be deactivated in the following situations:

- When the vehicle comes to a stop
- If the accelerator pedal is depressed for more than a certain period of time
- When the shift position is shifted to a position other than D

■ Downshifting restriction warning buzzer

To help ensure safety and driving performance, downshift operations may be restricted. In some circumstances, downshifting may not be possible even when the paddle shift switch is operated. (A buzzer will sound twice.)

Selecting shift ranges in the S position

To enter S mode, change the shift position to S.

The shift range can be selected by operating the [-] and [+] paddle shift switches.

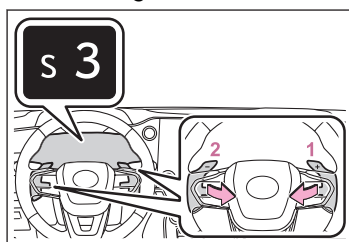

- 1 Upshift
- 2 Downshift

The selected shift range, from S1 to S6, will be displayed on the multi-information display.

The initial shift range in S mode is set automatically to S4.*1

● Shift ranges and their functions

- You can choose from 6 levels of accelerating force and engine braking force.
- A lower shift range will provide greater accelerating force and engine braking force than a higher shift range, and the engine revolutions will also increase.

INFORMATION

■ S mode

- To prevent the engine from over-revving, upshifting may automatically occur when the shift range is S2 or lower.
- When in S4 or lower, if the paddle shift switch is held toward [+] the shift range will be set to S6.

■ Downshifting restriction warning buzzer

To help ensure safety and driving performance, downshift operations may be restricted. In some circumstances, downshifting may not be possible even when the paddle shift switch is operated. (A buzzer will sound twice.)

■ If the "S" indicator does not come on or the "D" indicator is displayed even after changing the shift position to S position

This may indicate a malfunction in the hybrid transmission system. Have the vehicle inspected by your Lexus dealer immediately. (In this situation, the hybrid transmission will operate in the same manner as when the shift position is in D.)

*1: It is set to S3 when the driving mode is set to sport mode.

When parking the vehicle

Precautions for when the vehicle is stopped or parked

⚠ WARNING

■ When the vehicle is parked

- Always apply the parking brake, shift the shift position to P, stop the hybrid system and lock the vehicle. Do not leave the vehicle unattended while the "READY" indicator is illuminated.

If the vehicle is parked with the shift position in P but the parking brake is not set, the vehicle may start to move, possibly leading to an accident.

- Never leave a child unattended in the vehicle. A child may accidentally release the parking brake and the vehicle may move, possibly leading to an accident.
- Do not leave glasses, cigarette lighters, spray cans or carbonated drink cans in the vehicle when it is parked in the sun. If left in the vehicle, the following may occur:
 - Gas may leak from a cigarette lighter or spray can, and may lead to a fire.
 - The temperature inside the vehicle may cause the plastic lenses and plastic material of glasses to deform or crack.
 - Soft drink cans may explode, dirtying the interior and possibly causing a short in electronic components.
- Do not store cigarette lighters in the vehicle storage features or leave them inside the vehicle.

When luggage is loaded or a seat is adjusted, a lighter may be unintentionally lit, possibly leading to a fire.

- Do not attach suction cups to the glass parts of the vehicle. Also, do not place air fresheners or other clear containers on the instrument panel or dashboard. Suction cups and clear containers may act as a lens, possibly leading to a fire inside the vehicle.
- Do not leave a door or window open if the curved glass is coated with a metallized film such as a silver-colored one.

Reflected sunlight may cause the glass to act as a lens, causing a fire.

- Do not touch the exhaust pipes while the "READY" indicator is illuminated or immediately after turning the hybrid system off. Doing so may cause burns.

■ When taking a nap in the vehicle

Always turn the hybrid system off. If the "READY" indicator remains illuminated while taking a nap, you may unintentionally operate the shift lever or accelerator pedal, possibly leading to an accident or a fire from the hybrid system overheating. Additionally, if the vehicle is parked in a poorly ventilated area, exhaust gases may accumulate and enter the vehicle.

Exhaust gas precautions

Harmful substance to the human body is contained in exhaust gases if inhaled.

▲ WARNING

Exhaust gases contain harmful carbon monoxide (CO), which is colorless and odorless. Observe the following precautions.

Failure to do so may cause exhaust gases to enter the vehicle. This may cause light-headedness, possibly leading to an accident, death or a serious health hazard.

- Keep the back door closed while driving.

If you smell exhaust gases in the vehicle even when the back door is closed, open the windows and have the vehicle inspected by your Lexus dealer as soon as possible.

- If the vehicle is in a poorly ventilated area or a closed area, such as a garage, stop the hybrid system.
- Do not leave the vehicle with the hybrid system on for a long time. If such a situation cannot be avoided, park the vehicle in an open space and ensure that exhaust fumes do not enter the vehicle interior.
- Do not leave the hybrid system operating in an area with snow build-up, or where it is snowing. If snowbanks build up around the vehicle while the hybrid system is operating, exhaust gases may collect and enter the vehicle.
- The exhaust system needs to be checked periodically. Check for the following. If any are found, have the vehicle inspected by your Lexus dealer.
 - Holes or cracks in the exhaust pipes due to corrosion
 - Damage at the joining parts of the exhaust pipes
 - Abnormal noise from the exhaust

Stopping

1 Depress the brake pedal.

WARNING

- Drive more carefully than normal when the brakes are wet. When the brakes are wet, the braking distance will increase. Also, the brakes will be difficult to apply and, depending on the situation, braking performance may differ between the left and right sides. Additionally, the parking brake may not be able to be securely applied.
- If the electronically controlled brake system does not operate, do not follow other vehicles closely and avoid hills or sharp turns that require braking. In this case, braking is still possible, but the brake pedal should be depressed more firmly than usual. Also, the braking distance will increase. Have your brakes fixed immediately.
- If the brake hydraulic system malfunctions, have it repaired immediately. The brake system consists of 2 or more independent systems and if 1 hydraulic system fails, the other systems will operate. In this situation, it will be necessary to depress the brake pedal more than normal and braking distance will be increased.

NOTICE

Do not use the accelerator pedal or depress the accelerator and brake pedals at the same time to hold the vehicle on a hill.

2 If necessary, set the parking brake.

If the vehicle is to be stopped for an extended period of time, shift the shift position to P.

WARNING

When the vehicle is stopped

- Do not depress the accelerator pedal unnecessarily.
If the vehicle is in any gear other than P or N, the vehicle may accelerate suddenly and unexpectedly, causing an accident.
- In order to prevent accidents due to the vehicle rolling away, always keep depressing the brake pedal while stopped with the "READY" indicator is illuminated, and apply the parking brake as necessary.
- If the vehicle is stopped on an incline, in order to prevent accidents caused by the vehicle rolling forward or backward, always depress the brake pedal and securely apply the parking brake as needed.
- Avoid revving or racing the engine. Running the engine at high speed while the vehicle is stopped may cause the exhaust system to overheat, which could result in a fire if combustible material is nearby.

2-3. Parking the vehicle

— Related Links —

[Shift position display and how to change the shift position\(P. 194\)](#)

Parking the vehicle

- 1 Depress the brake pedal to stop the vehicle completely.
- 2 If the parking brake is released, set the parking brake.
- 3 Shift the shift position to P.

Check that the shift position indicator shows P and the parking brake indicator is illuminated.

WARNING

Always set the parking brake, and shift the shift position to P. Failure to do so may cause the vehicle to move or the vehicle may accelerate suddenly if the accelerator pedal is accidentally depressed.

- 4 Press the power switch to stop the hybrid system.
- 5 Slowly release the brake pedal.
- 6 Lock the door, making sure that you have the electronic key on your person.
If parking on a hill, block the wheels as needed.

Related Links

[Manual applying/releasing of the parking brake \(manual mode\)\(P. 209\)](#)

[Changing the shift position\(P. 194\)](#)

Parking brake operation

The parking brake can be applied or released automatically (automatic mode) or manually (manual mode). In automatic mode, the parking brake is applied or released automatically according to the operation of the shift lever. Also, in automatic mode the parking brake can be applied or released manually.

WARNING

When parking the vehicle

Do not leave a child in the vehicle alone. The parking brake may be released unintentionally by a child and there is the danger of the vehicle moving that may lead to an accident resulting in death or serious injury.

Parking brake switch

Do not set any objects near the parking brake switch. Objects may interfere with the switch and may lead the parking brake to unexpectedly operate.

NOTICE

When the vehicle is parked

- Always apply the parking brake, shift the shift position to P, stop the hybrid system and lock the vehicle. Do not leave the vehicle unattended while the "READY" indicator is illuminated.

If the vehicle is parked with the shift position in P but the parking brake is not set, the vehicle may start to move, possibly leading to an accident.

When the system malfunctions

Stop the vehicle in a safe place and check the warning messages.

When the vehicle 12-volt battery is discharged

The parking brake system cannot be activated.

When the parking brake cannot be released due to a malfunction

Driving the vehicle with the parking brake set will lead to brake components overheating, which may affect braking performance and increase brake wear. Have the vehicle inspected by your Lexus dealer immediately if this occurs.

INFORMATION

Parking brake automatic release function

When all of the following conditions are met, the parking brake can be released by depressing the accelerator pedal.

- The driver's door is closed
- The driver is wearing the seat belt
- The shift lever is in a forward driving position or reverse driving position
- The malfunction indicator lamp or brake system warning light is not illuminated

When depressing the accelerator pedal, depress it slowly. If the parking brake is not released when the accelerator pedal is depressed, release the parking brake manually.

Automatic mode: When the shift position is shifted from P, the parking brake will be released automatically.

Parking brake operation sound

When the parking brake operates, a motor sound (whirring sound) may be heard. This does not indicate a malfunction.

Parking brake indicator light

- Depending on the power switch mode, the parking brake indicator light will turn on and stay on as described below:

ON: Comes on until the parking brake is released.

Not in ON: Stays on for approximately 15 seconds.

- When the power switch is turned off with the parking brake set, the parking brake indicator light will stay on for about 15 seconds. This does not indicate a malfunction.

■ When the parking brake switch malfunctions

Automatic mode (automatic brake setting and releasing) will be turned on automatically.

■ Parking brake engaged warning buzzer

A buzzer will sound if the vehicle is driven with the parking brake engaged. "Parking Brake ON" is displayed on the multi-information display (with the vehicle reaching a speed of 3 mph [5 km/h]).

Automatic applying/releasing of the parking brake (auto mode)

While the vehicle is stopped, pull and hold the parking brake switch until "EPB Shift Interlock Function Activated" will be displayed on the multi-information display.

When the automatic mode is turned on, the parking brake operates as follows.

- When the shift position is shifted from P: The parking brake will be released, and the parking brake indicator light will turn off.
- When the shift position is shifted to P: The parking brake will be set, and the parking brake indicator light will turn on.

Operate the shift lever with the brake pedal depressed.

The auto function may not operate if the shift lever is moved extremely quickly. In this situation, apply the parking brake manually.

With the vehicle stopped, press and hold the parking brake switch until a buzzer sounds and "EPB Shift Interlock Function Deactivated" is displayed. Automatic mode will be turned off.

INFORMATION

■ Parking brake operation

- When the power switch is not in ON, the parking brake cannot be released using the parking brake switch.
- When the power switch is not in ON, automatic mode (automatic brake setting and releasing) is not available.

Manual applying/releasing of the parking brake (manual mode)

The parking brake can be set and released manually.

2-3. Parking the vehicle



- A Parking brake indicator (U.S.A.)
- B Parking brake indicator (Canada)

1 Pull the switch to set the parking brake.

The parking brake indicator light will turn on.

Pull and hold the parking brake switch if an emergency occurs and it is necessary to operate the parking brake while driving.

2 Press the switch to release the parking brake.

- Operate the parking brake switch while depressing the brake pedal.
- The parking brake can be released by depressing the accelerator pedal, through the parking brake automatic release function.

Make sure that the parking brake indicator light and the parking brake switch indicator turn off.

If the parking brake indicator light flash, operate the switch again.

Garage door opener and its performance

The garage door opener can be programmed using the HomeLink[®] to operate garage doors, gates, entry doors, door locks, home lighting systems, security systems, and other devices.

INFORMATION

HomeLink[®] programming procedure

The programming procedures can also be found at the following URL.

Website: www.homelink.com/lexus

For support, contact customer support at the following.

Help Line: 1-800-355-3515



System components

The HomeLink[®] wireless control system in your vehicle has 3 buttons which can be programmed to operate 3 different devices.

► Vehicles with auto anti-glare inside rear view mirror

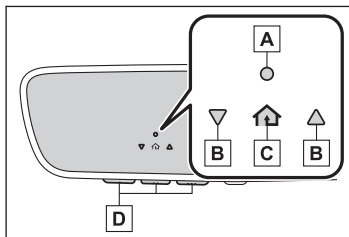

- A HomeLink[®] indicator light
 - B Garage door operation indicators
 - C HomeLink[®] icon
 - D Buttons
- Illuminates while HomeLink[®] is operating.

► Vehicles with Digital Rearview Mirror

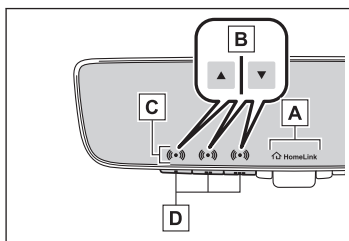

- A HomeLink[®] logo
 - B Garage door operation indicators
 - C HomeLink[®] indicator lights
 - D Buttons
- Appears while HomeLink[®] is operating. When the menu button is pressed, the logo disappears even while the HomeLink[®] is operating.
- Illuminates above each button selected.

⚠ WARNING

Do not use the HomeLink[®] compatible transceiver with any garage door opener or device that lacks safety stop and reverse features as required by federal safety standards. This includes any garage door that cannot detect an interfering object. A door or device without these features increases the risk of death or serious injury.

ℹ INFORMATION

■ Codes stored in the HomeLink[®] memory

- The registered codes are not erased even if the 12-volt battery cable is disconnected.
- If learning fails when registering a code to a previously registered HomeLink[®] button, the registered code will not be erased.

Program the HomeLink[®]

Before programming the HomeLink[®], perform the following:

2-3. Parking the vehicle

- During programming, it is possible that garage doors, gates, or other devices may operate. For this reason, make sure that people and objects are clear of the garage door or other devices to prevent injury or other potential harm.
- It is recommended that a new battery be placed in the remote control transmitter for more accurate programming.

The battery side of the transmitter must be pointed away from the HomeLink® buttons.

- Garage door opener motors manufactured after 1995 may be equipped with rolling code protection. If this is the case, you may need a stepladder or other sturdy, safe device to reach the “learn” or “smart” button on the garage door opener motor.

⚠ WARNING

- The garage door or other device may operate, so ensure people and objects are out of danger to prevent potential harm.
- Never allow a child to operate or play with the HomeLink® buttons.

Steps 1 through 3 must be performed within 60 seconds. Otherwise the indicator light will stop flashing and programming will not be able to be completed.

- 1 Press and release the HomeLink® button you want to program and check that the HomeLink® indicator light flashes orange.
- 2 Point the remote control transmitter for the device at the rear view mirror, 1 to 3 in. (25 to 75 mm) from the HomeLink® buttons.

Keep the HomeLink® indicator light in view while programming.

► Vehicles with auto anti-glare inside rear view mirror

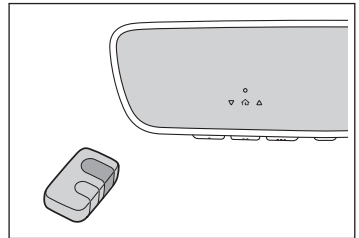

3 Program a device.

▶ Vehicles with Digital Rearview Mirror

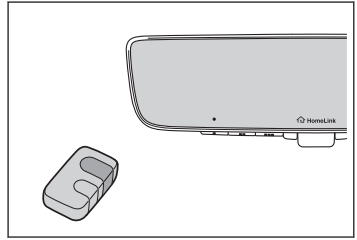

▶ Vehicles with auto anti-glare inside rear view mirror

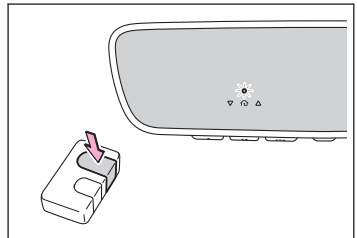

▶ Vehicles with Digital Rearview Mirror

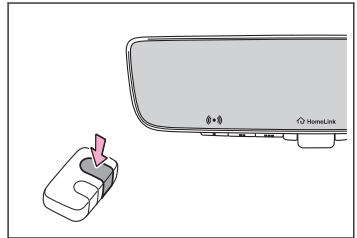

- Programming a device other than an entry gate (for U.S.A. owners):

Press and hold the remote control transmitter button until the HomeLink[®] indicator light changes from slowly flashing orange to rapidly flashing green (rolling code) or continuously lit green (fixed code), then release the button.

- Programming an entry gate (for U.S.A. owners)/Programming a device in the Canadian market:

Press and release the remote control transmitter button at 2 second intervals, repeatedly, until the HomeLink[®] indicator light changes from slowly flashing (orange) to rapidly flashing (green) (rolling code) or continuously lit (green) (fixed code).

4 Test the HomeLink[®] operation by pressing the newly programmed button and observing the indicator light:

2-3. Parking the vehicle

- HomeLink[®] indicator light illuminates: Programming of a fixed code device has completed. The garage door or other device should operate when a HomeLink[®] button is pressed and released.
 - HomeLink[®] indicator light flashes rapidly: The garage door opener motor or other device is equipped with a rolling code. To complete programming, firmly press and hold the HomeLink[®] button for 2 seconds then release it.
 - If the garage door or other device does not operate, proceed to [Programming a rolling code system](#)(→ P.214).
- 5 Repeat the steps above to program another device for any of the remaining HomeLink[®] buttons.

Programming a rolling code system

Two or more people may be necessary to complete rolling code programming.

- 1 Locate the “Learn” or “Smart” button on the garage door opener motor in the garage.

This button can usually be found where the hanging antenna wire is attached to the unit. The name and color of the button may vary by manufacturer. Refer to the owner's manual supplied with the garage door opener motor for details.

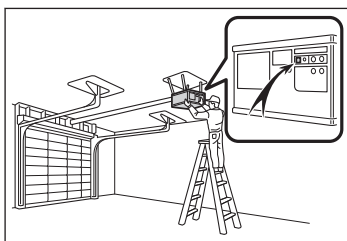

- 2 Press and release the “Learn” or “Smart” button.

Perform 3 within 30 seconds after performing 2.

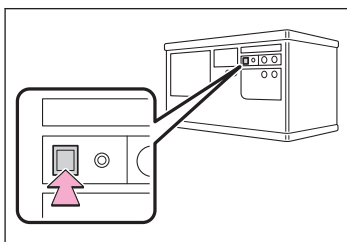

- 3 Press and hold the desired HomeLink[®] button (inside the vehicle) for 2 seconds and release it. Repeat this sequence (press/hold/release) up to 3 times to complete programming.

If the garage door opener motor operates when the HomeLink[®] button is pressed, the garage door opener motor recognizes the HomeLink[®] signal.

► Vehicles with auto anti-glare inside rear view mirror

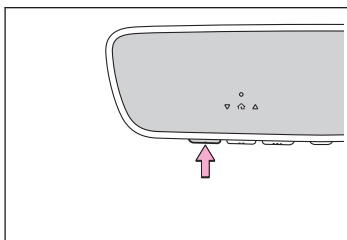

► Vehicles with Digital Rearview Mirror

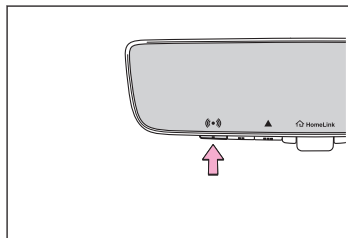

2-way communication with a garage door and its performance

When enabled, 2-way communication allows you to check the status of the opening and closing of a garage door through indicators in your vehicle.

2-way communication is only available if the garage door opener motor used is a compatible device.

To check device compatibility, refer to www.HomeLink.com.

Enable 2-way communication with a garage door

- 1 Within 5 seconds after programming the garage door opener has been completed, if the garage door opener motor is trained to HomeLink[®], both garage door operation indicators will flash rapidly green and the light on the garage door opener motor will blink twice, indicating that 2-way communication is enabled.

If the indicators do not flash, perform 2 and 3 within the first 10 presses of the HomeLink[®] button after programming has been completed.

- 2 Press a programmed HomeLink[®] button to operate a garage door.
- 3 Within 1 minute of pressing the HomeLink[®] button, after the garage door operation has stopped, press the “Learn” or “Smart” button on the garage door opener motor.

Within 5 seconds of the establishment of 2-way communication, both garage door operation indicators will flash rapidly in green. Additionally, the light on the garage door opener motor will blink twice, indicating that 2-way communication is enabled.

Operate the HomeLink[®]

This function is only available if the garage door opener motor used is a compatible device. To check device compatibility, refer to www.HomeLink.com.

► Vehicles with auto anti-glare inside rear view mirror

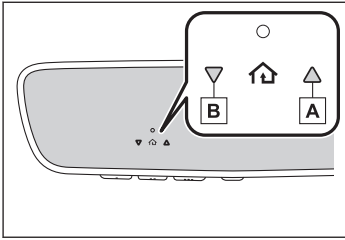

- A Opening
- B Closing

► Vehicles with Digital Rearview Mirror

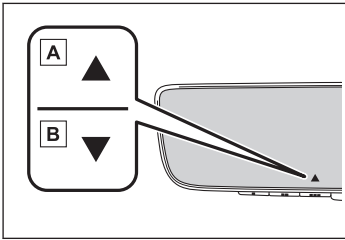









- A Opening
- B Closing

Press the appropriate HomeLink[®] button.

The HomeLink[®] indicator light will turn on. The status of the opening and closing of a garage door is shown by the indicators as follows.

- Orange (flashing): Currently opening/closing
- Green: Opening/closing has completed
- Red (flashing): Feedback signals cannot be received

INFORMATION

- The indicators can operate within approximately 820 ft. (250 m) of the garage door. However, if there are obstructions between the garage door and the vehicle, such as houses and trees, feedback signals from the garage door may not be received.
- To recall the previous door operation status, press and release either HomeLink[®] buttons  and  or  and  (vehicles with auto anti-glare inside rear view mirror),  and  or  and  (vehicles with Digital Rearview Mirror), simultaneously.

The last recorded status will be displayed for 3 seconds.

Reprogram the HomeLink[®]

When the following procedure is performed, buttons which already have devices registered to them can be overwritten:

- 1 Press and hold the desired HomeLink[®] button.
- 2 When the HomeLink[®] indicator starts flashing orange, release the HomeLink[®] button.

- 3 Press and release the HomeLink[®] button you want to program and check that the HomeLink[®] indicator light flashes orange.

It takes 20 seconds for the HomeLink[®] indicator to start flashing.

Erase the entire HomeLink[®] memory

When selling your vehicle, be sure to erase the registered codes from the HomeLink[®] memory.

Press and hold the 2 outer HomeLink[®] buttons for 10 seconds. Check that the HomeLink[®] indicator light changes from continuously lit in orange to rapidly flashing in green.

All codes registered to memory will be erased.

► Vehicles with auto anti-glare inside rear view mirror

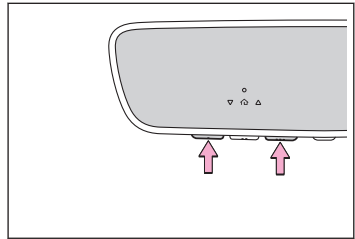

► Vehicles with Digital Rear-view Mirror

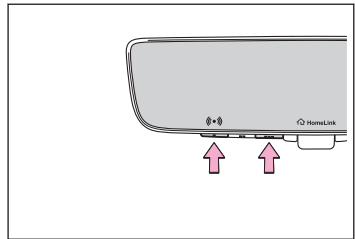

Refueling

NOTICE

For plug-in hybrid electric vehicles, fuel may remain in the tank for a long time and undergo changes in quality depending on the how the vehicle is used. Refuel at least 20 L (5.3 gal., 4.4 Imp.gal.) of fuel every 12 months (refuel a total of at least 20 L [5.3 gal., 4.4 Imp.gal.] over a 12-month period), as this may affect components of the fuel system or the gasoline engine.

INFORMATION

Running out of fuel

When the vehicle has run out of fuel and the hybrid system cannot be started, refuel the vehicle with at least enough gasoline to make the low fuel level warning light go off.*¹ If there is only a small amount of fuel, the hybrid system may not be able to start.

Opening the fuel tank cap

The fuel tank of your vehicle has a special structure, which requires a reduction in fuel tank pressure before refueling. After the opener has been pressed, it will take several seconds until the vehicle is ready for refueling.

1 Press the opener to open the fuel filler door.

The fuel filler door will open within about 10 seconds of the switch being pressed. Before refueling is possible, a message will be shown on the multi-information display in the instrument cluster to indicate the progress of the fuel filler door opener.

The fuel filler door will open.

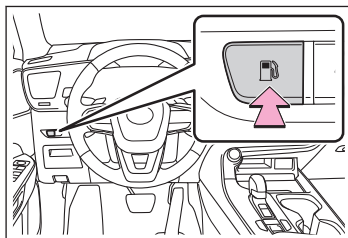

2 Turn the fuel tank cap slowly and remove it, then put it into the holder on the fuel filler door.

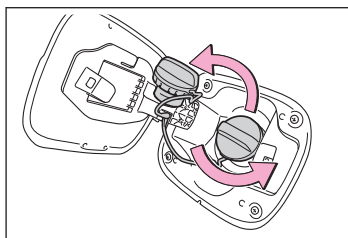

*1: The specified refueling volume to cause the warning light to turn off when the vehicle is level is approximately 2.6 gal. [10.0 L, 2.2 Imp.gal.]. This value may vary when the vehicle is on a slope. Add extra fuel when the vehicle is inclined.

⚠ WARNING

Always hold the grips on the fuel tank cap and turn it slowly to remove it. A whooshing sound may be heard when the fuel tank cap is loosened. Wait until the sound cannot be heard before fully removing the cap. In hot weather, pressurized fuel may spray out the filler neck and cause injury.

Precautions for refueling

Make sure to select a compatible type of fuel and refuel safely.

⚠ WARNING

Observe the following precautions while refueling the vehicle.

- After exiting the vehicle and before opening the fuel door, touch an unpainted metal surface to discharge any static electricity.

Also, do not allow anyone that has not discharged static electricity from their body to come close to the fuel filler door.

Sparks resulting from static electricity discharge may cause fuel vapors to ignite while refueling.

- Do not inhale vaporized fuel. Fuel contains substances that are harmful if inhaled.
- Do not smoke while refueling the vehicle. Doing so may cause the fuel to ignite and cause a fire.
- Do not return to the vehicle or touch any person or object that is statically charged. This may cause static electricity to build up, resulting in a possible ignition hazard.
- Securely insert the fuel nozzle into the fuel filler neck.
- Stop filling the tank after the fuel nozzle automatically clicks off.
- Do not top off the fuel tank.

⚠ NOTICE

- Make sure that the fuel filler door lock is not pushed by the fuel nozzle boot, etc. If the lock is held, the internal valve closes and fuel may overflow.

To prevent it, operate the fuel filler door opener switch in the vehicle again.

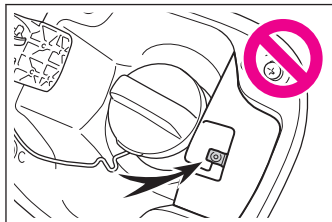

- Finish refueling within 30 minutes. If more than 30 minutes passes, the internal valve closes. In this condition, fuel may overflow during the refueling process. Press the fuel filler door opener switch again.

2-4. Refueling

NOTICE

- Do not spill fuel during refueling. Doing so may damage the vehicle, such as causing the emission control system to operate abnormally or damaging fuel system components or the vehicle's painted surface.

INFORMATION

■ Fuel tank opening for unleaded gasoline

To help prevent refueling with the incorrect fuel, your vehicle has a fuel tank opening designed to only accommodate the special nozzle on unleaded fuel pumps.

Close the fuel tank cap

After refueling, turn the fuel tank cap until you hear a click.

Once the cap is released, it will turn slightly in the opposite direction.

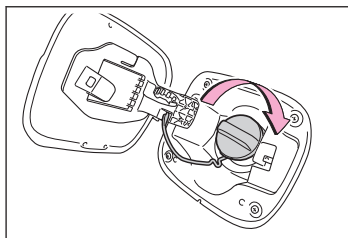

WARNING

If replacing the fuel tank cap, do not use anything but a genuine Lexus fuel tank cap designed for your vehicle. Doing so may cause a fire.

INFORMATION

■ When "Check Fuel Cap" is displayed on the multi-information display

The fuel tank cap may be unfastened or loose. Turn the power switch off, check the cap and tighten it securely. If the message remains, wait a few seconds and then turn the power switch off once again.

3-1. Driving when the surrounding area is darkUsing the headlights.....**222**Automatically changing between the low beam headlights and high beam headlights**227****3-2. Driving when the sun or headlights of other vehicles are bright**Using the sun visors.....**235**Inside rear view mirror anti-glare function (vehicles with auto anti-glare inside rear view mirror).....**236**Digital Rearview Mirror anti-glare function (optical mirror mode).....**237****3-3. Driving in the rain**Precautions for driving in the rain**238**Ensuring visibility in the rain **239****3-4. Driving when the windows or mirrors are fogged up**Defog the windshield.....**246**Defog the rear window**248**Defog the outside rear view mirrors.....**249****3-5. Driving when it is cold**Preparing for cold weather **250**Cold weather driving tips.....**253****3-6. Driving when in the fog or on a mountain road and visibility is poor**Fog light illumination**255**Sounding the horn.....**256****3-7. Utility vehicle precautions**Utility vehicle precautions ... **257****3-8. Changing the driving characteristics**Driving modes **260**Changing the driving mode **262**Trail Mode (AWD vehicles) **264****3-9. Brake hold system**Brake hold system **266**

Using the headlights

The headlights can be operated manually or automatically.

— Related Links —

[Customizable features\(P. 765\)](#)



Turning the headlights on/off

Do not leave the lights on longer than necessary with the hybrid system off. Doing so may lead to discharge of the 12-volt battery.

Operating the  switch turns on the lights as follows:

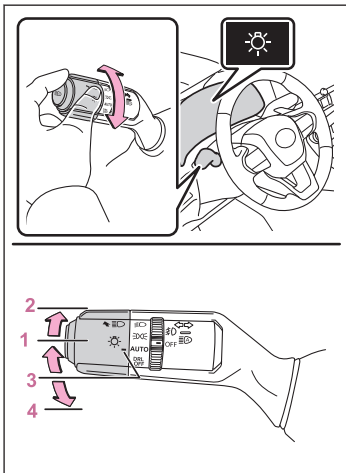

► Type A

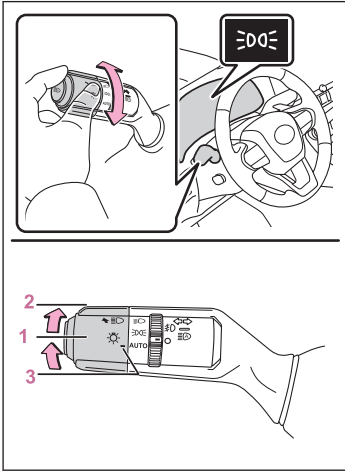

- 1  The side marker, parking, tail, license plate, instrument panel lights, and daytime running lights turn on.
- 2  The headlights and all the lights listed above (except daytime running lights) turn on.
- 3 **AUTO** The headlights, daytime running lights and all the lights listed above turn on and off automatically.
- 4  The daytime running lights turn off.

► Type B



- 1  The side marker, parking, tail, license plate, instrument panel lights, and daytime running lights turn on.
- 2  The headlights and all the lights listed above (except daytime running lights) turn on.
- 3 **AUTO** The headlights, daytime running lights and all the lights listed above turn on and off automatically.

 **INFORMATION**
■ AUTO mode can be used when

The power switch is in ON.

■ Daytime running light system

- The daytime running lights illuminate using the same lights as the parking lights and illuminate brighter than the parking lights.
- To make your vehicle more visible to other drivers during daytime driving, the daytime running lights turn on automatically when all of the following conditions are met. (The daytime running lights are not designed for use at night.)
 - The hybrid system is started
 - The parking brake is released
 - The headlight switch is in the  or **AUTO*1** position

The daytime running lights remain on after they illuminate, even if the parking brake is set again.

- For U.S.A.: The daytime running lights can be turned off by turning the headlight switch to the  position.
- Compared to turning on the headlights, the daytime running light system offers greater durability and consumes less electricity, so it can help improve fuel economy.
- If a turn signal light is in use, the daytime running light, on the same side, is turned off. For emergency flashers, both are turned off.

*1: When the surroundings are bright

3.1. Driving when the surrounding area is dark

■ Headlight control sensor

The sensor may not function properly if an object is placed on the sensor, or anything that blocks the sensor is affixed to the windshield. Doing so interferes with the sensor detecting the level of ambient light and may cause the automatic headlight system to malfunction.

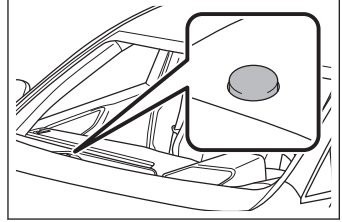



■ Automatic light off system

- When the headlights come on:

The lights turn off 30 seconds after a door is opened and closed if the power switch is turned off. (The lights turn off immediately if  on the key is pressed after all the doors are locked.)

- When only the tail lights come on:

The tail lights turn off automatically if the power switch is turned off and the driver's door is opened.

To turn the lights on again, turn the power switch to ON, or turn the light switch off once and then back to  or .

■ Light reminder buzzer

A buzzer sounds when the power switch is turned off or turned to ACC and the driver's door is opened while the lights are turned on.

■ 12-volt battery-saving function

In order to prevent the 12-volt battery of the vehicle from discharging, if the headlights and/or tail lights are on when the power switch is turned off the 12-volt battery saving function will operate and automatically turn off all the lights after approximately 20 minutes. When the power switch is turned to ON, the 12-volt battery-saving function will be disabled.

When any of the following are performed, the 12-volt battery-saving function is canceled once and then reactivated. All the lights will turn off automatically 20 minutes after the 12-volt battery-saving function has been reactivated:

- When the headlight switch is operated
- When a door or the back door is opened or closed

Turning on the high beam headlights

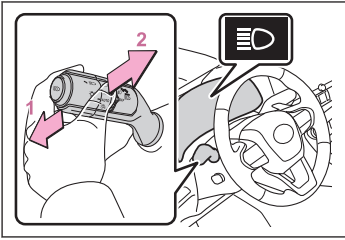

- 1 With the headlights on, push the lever forward.
The high beam headlights will turn on.
Pull the lever to its original position to turn the high beam headlights off.
- 2 Pull the lever rearward and release it.
The high beams will flash once.
The high beam headlights can be illuminated this way even with the headlights off.

Operation of the cornering lights*

When any of the following conditions are met, while the headlights (low beam) are on, the cornering lights will turn on and light up the direction of movement of the vehicle. The cornering lights are designed to ensure excellent visibility when turning at intersections or parking at night.

- The steering wheel is being operated
- The turn signal lever is being operated
- The shift position is in R

INFORMATION

■ Cornering light control

- When vehicle speed is approximately 22 mph (35 km/h) or higher, the cornering lights will not turn on.
- The lights will automatically turn off if they remain illuminated for 30 minutes.

Operation of the AFS (Adaptive Front-lighting System)*

The AFS (Adaptive Front-lighting System) ensures excellent visibility when turning at intersections and on curves by automatically adjusting the angle of the headlights according to vehicle speed and the angle of the tires as controlled by steering input.

The AFS operates at speeds of 6 mph (11 km/h) or higher.

*: If equipped

Operation of the automatic headlight leveling system*

The level of the headlights is automatically adjusted according to the number of passengers and the loading condition of the vehicle to ensure that the headlights do not interfere with other road users.

*: If equipped

Automatically changing between the low beam headlights and high beam headlights

AHS (Adaptive High-beam System)*

The Adaptive High-beam System uses a front camera located on the upper portion of the windshield to detect the brightness of the lights of vehicles ahead, streetlights, etc., and automatically controls the light distribution of the headlights.

⚠ WARNING

■ For safe use

Do not overly rely on the Adaptive High-beam System. Always drive safely, taking care to observe your surroundings and turning the high beams on or off manually if necessary.

■ To prevent unintentional operation of the Adaptive High-beam System

When it is necessary to disable the system: → P.373

System controls

- According to the vehicle speed, the brightness and illuminated area of the high beams are adjusted.
- The high beams are illuminated so that the area around a vehicle ahead is shaded. (Shaded high beam)

The shaded high beam helps ensure forward visibility while reducing the dazzling effect on the drivers of vehicles ahead.

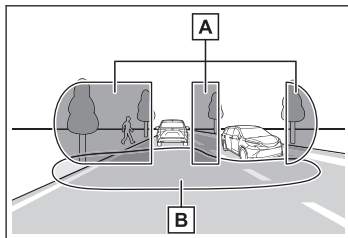

- A Area illuminated by the high beams
- B Area illuminated by the low beams

- According to the distance to a preceding vehicle, the illuminated area of the low beams is adjusted.

*: If equipped

Using the Adaptive High-beam System

- 1 Press the Adaptive High-beam System switch.

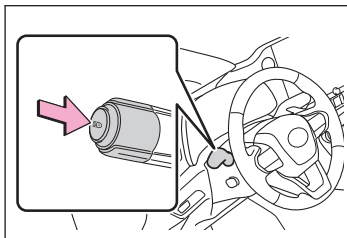

- 2 Turn the headlight switch to the [AUTO] or  position.

When the headlight switch lever is in the low beam position, the AHS system will be enabled and the AHS indicator will illuminate.

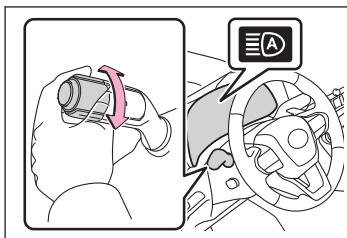

INFORMATION

■ System operating conditions

- When all of the following conditions are met, the high beams will illuminate and the system will operate:
 - The vehicle speed is approximately 19 mph (30 km/h) or more
 - The area ahead of the vehicle is dark.
- When all of the following conditions are met, the headlights will change to the shaded high beams according to the position of vehicles ahead:
 - The vehicle speed is approximately 19 mph (30 km/h) or more
 - The area ahead of the vehicle is dark.
 - There is a vehicle ahead with lights on.
 - There are few streetlights or other lights on the road ahead.
- If any of the following conditions are met, the system will change to the low beams:
 - The vehicle speed is approximately 16 mph (25 km/h) or lower.
 - The area ahead of the vehicle is not dark.
 - There are many vehicles ahead.
 - There are many streetlights or other lights on the road ahead.

■ Front camera detection

- In the following situations, the high beams may not be automatically changed to the shaded high beams:
 - When a vehicle cuts in front of your vehicle
 - When another vehicle crosses in front of the vehicle
 - When vehicles ahead are repeatedly detected and then hidden due to repeated curves, road dividers or roadside trees
 - When a vehicle ahead approaches from a far lane
 - When a vehicle ahead is far away
 - When a vehicle ahead has no lights
 - When the lights of a vehicle ahead are dim
 - When a vehicle ahead is reflecting strong light, such as the headlights of your vehicle
 - Situations in which the sensors may not operate properly: → P.378
- The high beams may change to the shaded high beams if a vehicle ahead that is using fog lights without its headlights turned on is detected.
- House lights, street lights, traffic signals, and illuminated billboards or signs and other reflective objects may cause the high beams to change to the shaded high beams, cause the high beams not to change to the shaded high beams, or change the area that is not illuminated.
- The following may change the speed at which the shaded areas change or the timing at which the headlights change to the low beams:
 - The brightness of lights of vehicles ahead
 - The movement and direction of vehicles ahead
 - The distance between the vehicle and a vehicle ahead
 - When a vehicle ahead only has lights illuminated on one side
 - When a vehicle ahead is a two-wheeled vehicle
 - The condition of the road (gradient, curve, condition of the road surface, etc.)
 - The number of passengers and amount of luggage
- The light distribution control of the headlights may not match the driver's expectations
- Bicycles and other small vehicles may not be detected.
- In the following situations, the system may not be able to correctly detect the brightness of the surroundings. This may cause the low beams to remain on or the high beams to flash or dazzle pedestrians or vehicles ahead. In such a case, it is necessary to manually change between the high beams and low beams.
 - When there are lights similar to headlights or tail lights in the surrounding area

3.1. Driving when the surrounding area is dark

- When headlights or tail lights of vehicles ahead are turned off, dirty, changing color, or not aimed properly
- When the headlights are repeatedly changing between the high beams and low beams.
- When use of the high beams is inappropriate or when the high beams may be flashing or dazzling pedestrians or other drivers.
- When the vehicle is used in an area in which vehicles travel on the opposite side of the road of the country for which the vehicle was designed, for example using a vehicle designed for right-hand traffic in a left-hand traffic area, or vice versa
- When it is necessary to disable the system: → P.373
- Situations in which the sensors may not operate properly: → P.378

■ Customization

The settings of some functions can be changed. → P.773

Turning the high beams on/off manually

■ Changing to the high beams

- Push the lever forward.

The AHS indicator will turn off and the high beam indicator will turn on.

Pull the lever to its original position to enable the Adaptive High-beam System again.

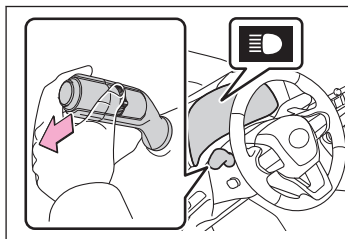

■ Changing to the low beams

- Press the Adaptive High-beam System switch.

The AHS indicator will turn off.

Press the switch to enable the Adaptive High-beam System again.

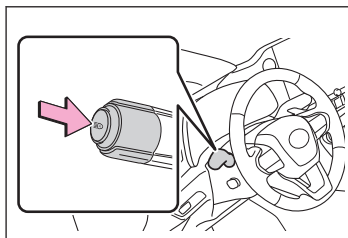

Temporarily changing to the low beams

It is recommended to switch to the low beams when use of the high beams is inappropriate or when the high beams may cause problems or distress to other drivers or pedestrians nearby.

- Pull the lever rearward and then return it to its original position.

The high beams will illuminate while the lever is pulled, however, after the lever is returned to its original position, the low beams will remain on for a certain amount of time. After this, the Adaptive High-beam System will operate.

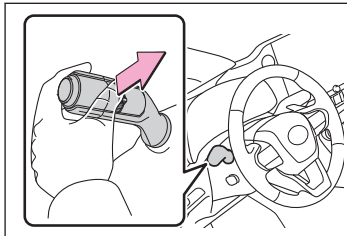

AHB (Automatic High Beam)*

The Automatic High Beam uses a front camera located on the upper portion of the windshield to detect the brightness of the lights of vehicles ahead, streetlights, etc., and automatically changes the head lights between the high beams and low beams.

▲ WARNING

■ For safe use

Do not overly rely on the Automatic High Beam. Always drive safely, taking care to observe your surroundings and turning the high beams on or off manually if necessary.

■ To prevent unintentional operation of the Automatic High Beam

When it is necessary to disable the system: → P.373

Using the Automatic High Beam system

- 1 Press the Automatic High Beam switch.

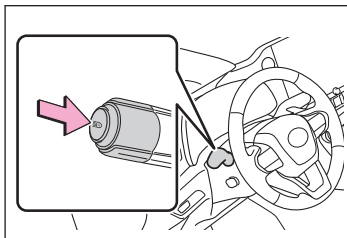

- 2 Turn the headlight switch to the [AUTO] or  position.

When the headlight switch lever is in the low beam position, the AHB system will be enabled and the AHB indicator will illuminate.

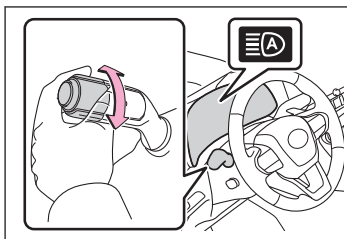

*: If equipped

INFORMATION

■ Automatic operating conditions of the high beams

- When all of the following conditions are met, the high beams will illuminate automatically:
 - The vehicle speed is approximately 21 mph (34 km/h) or more.
 - The area ahead of the vehicle is dark.
 - There are no vehicles ahead with lights on.
 - There are few streetlights or other lights on the road ahead.
- If any of the following conditions are met, the headlights will change to the low beams:
 - Vehicle speed drops below approximately 17 mph (27 km/h).
 - The area ahead of the vehicle is not dark.
 - There is a vehicle ahead with lights on.
 - There are many streetlights or other lights on the road ahead.

■ Front camera detection

- In the following situations, the high beams may not be automatically changed to the low beams:
 - When a vehicle cuts in front of your vehicle
 - When another vehicle crosses in front of the vehicle
 - When vehicles ahead are repeatedly detected and then hidden due to repeated curves, road dividers or roadside trees
 - When a vehicle ahead approaches from a far lane
 - When a vehicle ahead is far away
 - When a vehicle ahead has no lights
 - When the lights of a vehicle ahead are dim
 - When a vehicle ahead is reflecting strong light, such as own headlights
 - Situations in which the sensors may not operate properly: → [P.378](#)
- The headlights may change to the low beams if a vehicle ahead that is using fog lights without its headlights turned on is detected.
- House lights, street lights, traffic signals, and illuminated billboards or signs may cause the high beams to change to the low beams, or the low beams to remain on.
- The following may change the the timing at which the headlights change to the low beams:
 - The brightness of lights of vehicles ahead
 - The movement and direction of vehicles ahead

- The distance between the vehicle and a vehicle ahead
- When a vehicle ahead only has lights illuminated on one side
- When a vehicle ahead is a two-wheeled vehicle
- The condition of the road (gradient, curve, condition of the road surface, etc.)
- The number of passengers and amount of luggage
- The headlights may change between the high beams and low beams unexpectedly.
- Bicycles and other small vehicles may not be detected.
- In the following situations, the system may not be able to correctly detect the brightness of the surroundings. This may cause the low beams to remain on or the high beams to flash or dazzle pedestrians or vehicles ahead. In such a case, it is necessary to manually change between the high beams and low beams.
 - When there are lights similar to headlights or tail lights in the surrounding area
 - When headlights or tail lights of vehicles ahead are turned off, dirty, changing color, or not aimed properly
 - When the headlights are repeatedly changing between the high beams and low beams.
 - When use of the high beams is inappropriate or when the high beams may be flashing or dazzling pedestrians or other drivers.
 - When the vehicle is used in an area in which vehicles travel on the opposite side of the road of the country for which the vehicle was designed, for example using a vehicle designed for right-hand traffic in a left-hand traffic area, or vice versa
 - When it is necessary to disable the system: → P.373
 - Situations in which the sensors may not operate properly: → P.378

■ Temporarily reducing front camera sensitivity

The sensitivity of the front camera can be temporarily reduced.

1. Turn the power switch off with the following conditions met.
 - The headlight switch is in the  or [AUTO] position.
 - The headlight switch lever is in the low beam position.
 - The Automatic High Beam switch is on.
2. Turn the power switch to ON.
3. Within 60 seconds after performing step 2, push the headlight switch lever to the high beam position then pull it to the original position quickly 10 times, then leave the lever in its original position.
4. If the sensitivity is changed, the Automatic High Beam indicator will blink 3 times.

Turning the high beams on/off manually

■ Changing to the high beams

- Push the lever forward.

The Automatic High Beam indicator will turn off and the high beam indicator will turn on.

Pull the lever to its original position to enable the Automatic High Beam system again.

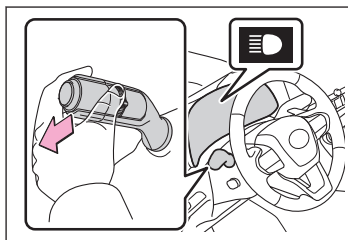

■ Changing to the low beams

- Press the Automatic High Beam switch.

The Automatic High Beam indicator will turn off.

Press the switch to enable the Automatic High Beam system again.

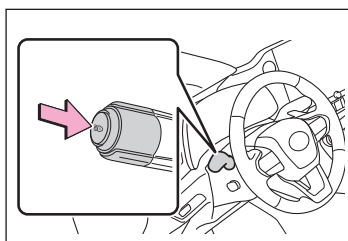

Temporarily changing to the low beams

It is recommended to switch to the low beams when use of the high beams is inappropriate or when the high beams may cause problems or distress to other drivers or pedestrians nearby.

- Pull the lever rearward and then return it to its original position.

The high beams will illuminate while the lever is pulled, however, after the lever is returned to its original position, the low beams will remain on for a certain amount of time. After this, the Automatic High Beam system will operate.

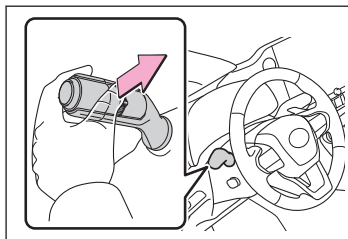

Using the sun visors

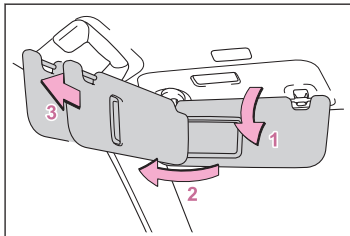

- 1 To set the visor in the forward position, flip it down.
- 2 To set the visor in the side position, flip down, unhook, and swing it to the side.
- 3 To use the side extender, place the visor in the side position, then slide it backward.

3-2. Driving when the sun or headlights of other vehicles are bright

Inside rear view mirror anti-glare function (vehicles with auto anti-glare inside rear view mirror)

Responding to the level of brightness of the headlights of vehicles behind, the reflected light is automatically reduced.

This function turns on each time the power switch is turned to ON.

INFORMATION

When the anti-glare function of the inside rear view mirror is set to automatic mode, the outside rear view mirrors will activate in conjunction with the anti-glare inside rear view mirror to reduce reflected light.

Push the switch to turn the automatic anti-glare function on/off

When the automatic anti-glare function is on, the indicator **A** will be illuminated.

Pressing the switch again will turn the function off.
(The indicator **A** will also turn off.)

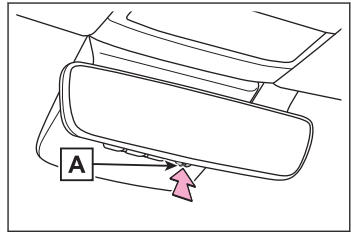

INFORMATION

■ To prevent sensor malfunction

Do not touch or cover the sensors. Doing so may cause the sensor to malfunction.

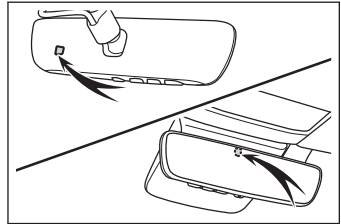

Digital Rearview Mirror anti-glare function (optical mirror mode)

The automatic anti-glare function in the optical mirror mode can be enabled/disabled.

The automatic anti-glare function is enabled each time the power switch is changed to ON.

1 Press the menu button.

The setting display will be displayed.

2 Press the menu button repeatedly and select



The setting display will be displayed.

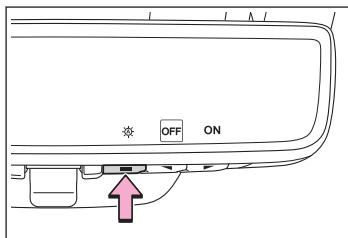

3 Press [] or [] to enable (ON)/disable (OFF) the automatic anti-glare function.

The icons will disappear if a button is not operated for approximately 5 seconds or more.

Precautions for driving in the rain

Observe the following precautions when driving in the rain.

- Drive carefully when it is raining, because visibility will be reduced, the windows may become fogged-up, and the road will be slippery.
- Drive carefully when it starts to rain, because the road surface will be especially slippery.
- Refrain from high speeds when driving on an expressway in the rain, as there is a risk of a layer of water forming between the tires and the road surface, preventing the steering and brakes from operating properly.

Ensuring visibility in the rain

Operate the wiper lever to change the operation of wipers between manual and automatic operation or to operate the washers.

Using the front wipers

⚠ WARNING

Take care that your fingers, etc. do not become caught in the windshield wipers.

The windshield wipers may operate unexpectedly in AUTO mode if the sensor is touched or the windshield is subject to vibration.

⚠ NOTICE

Observe the following precautions when using the front wipers.

- Do not leave the front wipers on longer than necessary with the hybrid system off. Doing so may lead to discharge of the 12-volt battery.
- Do not use the front wipers when the windshield is dry, as they may damage the windshield.

Operating the  lever operates the wipers or washer as follows.

► Type A

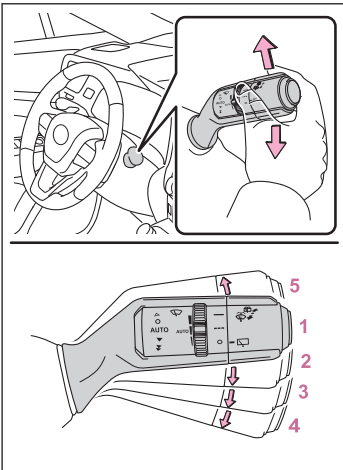

- 1 ○ Off
- 2 AUTO Rain-sensing operation
The wipers operate automatically if the sensor detects rain. The system automatically adjusts the speed of the wipers in accordance with rain volume and vehicle speed.
- 3 ▼ Low speed operation
- 4 ▼ High speed operation
- 5 △ Temporary operation

3-3. Driving in the rain

► Type B

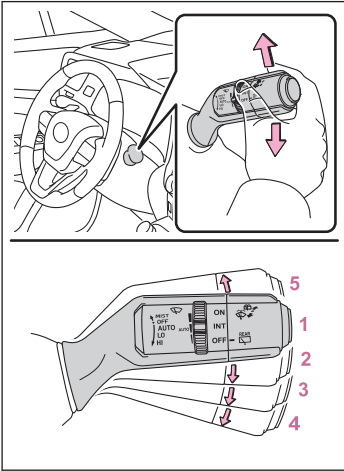

- 1 OFF Off
- 2 AUTO Rain-sensing operation
The wipers operate automatically if the sensor detects rain. The system automatically adjusts the speed of the wipers in accordance with rain volume and vehicle speed.
- 3 LO Low speed operation
- 4 HI High speed operation
- 5 MIST Temporary operation

□ INFORMATION

■ The front window wiper and washer can be operated when

The power switch is in ON.

■ Using the voice control system*

The front wipers can be operated one sweep using the voice control system.
For details, refer to the "MULTIMEDIA OWNER'S MANUAL".

Changing the speed of the wipers

When **AUTO** is selected, the wipers will operate automatically when the sensor detects falling rain. The system automatically adjusts wiper timing in accordance with rain volume and vehicle speed.

► Type A

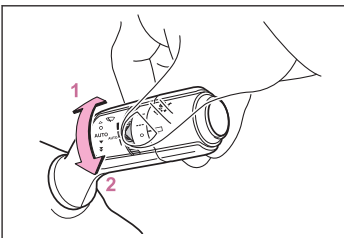

- 1 Increases the sensitivity
- 2 Decreases the sensitivity

*: If equipped

► Type B

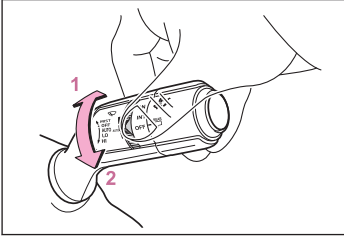

- 1 Increases the sensitivity
- 2 Decreases the sensitivity

 INFORMATION

■ Effects of vehicle speed on wiper operation

Vehicle speed affects the intermittent wiper speed.

■ Raindrop sensor

- The raindrop sensor determines the amount of raindrops that contact the windshield. As an optical sensor is used, it may not operate properly when sunlight from the rising or setting of the sun intermittently strikes the windshield, or if bugs, etc. are present on the windshield.

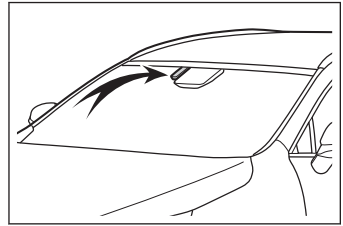

- If the temperature of the raindrop sensor is 194°F (90°C) or higher, or 5°F (-15°C) or lower, automatic operation may not occur.

In this case, operate the wipers in any mode other than AUTO mode.

Using the front washers
▲ WARNING

When it is cold, do not use the washer fluid until the windshield is warm.

The fluid may freeze on the windshield, decreasing visibility, possibly leading to an accident.

▲ NOTICE

If a washer nozzle is blocked, contact your Lexus dealer.

3-3. Driving in the rain

NOTICE

Do not try to clear it with a pin or other object. The nozzle will be damaged.



Pull the lever.

The front wipers and washers will operate.

The front wipers will automatically operate a couple of times after the front washers operate.

Vehicles with headlight cleaners: When the headlights are on and the lever is pulled and held, the headlight cleaners will operate once. After this, the headlight cleaners will operate every 5th time the lever is pulled.

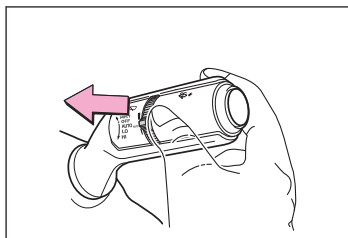

NOTICE

If washer fluid does not spray, do not operate the switch continuously as doing so may damage the washer fluid pump.

INFORMATION

■ The windshield wipers and washer can be operated when

The power switch is in ON.

■ Drip prevention wiper sweep

After the washers have operated and the wipers operate several times, they will operate one more time after a short delay to prevent drips.

However, this function will not operate while driving.

■ If no windshield washer fluid sprays

If there is washer fluid in the washer fluid tank, check if the washer nozzles are blocked.

■ Using the voice control system*

The front washer can be operated using the voice control system. (Operation is possible only when the vehicle is stopped.)

For details, refer to the "MULTIMEDIA OWNER'S MANUAL".

Using the rear wipers

NOTICE

Observe the following precautions when using the rear wipers.

*: If equipped

⚠ NOTICE

- Do not leave the rear wiper on longer than necessary with the hybrid system off. Doing so may lead to discharge of the 12-volt battery.
- When the rear window is dry, do not use the wiper, as it may damage the rear window.

📄 INFORMATION**■ The rear window wiper and washer can be operated when**

The power switch is in ON.

■ Using the voice control system*

The rear wiper can be operated one sweep using the voice control system.

For details, refer to the "MULTIMEDIA OWNER'S MANUAL".

Operating the  switch operates the rear wiper as follows:

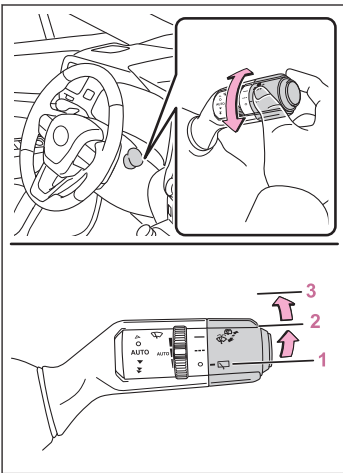
▶ Type A

- 1 ○ Off
- 2 --- Intermittent operation
- 3 — Normal operation

*: If equipped

3-3. Driving in the rain

► Type B

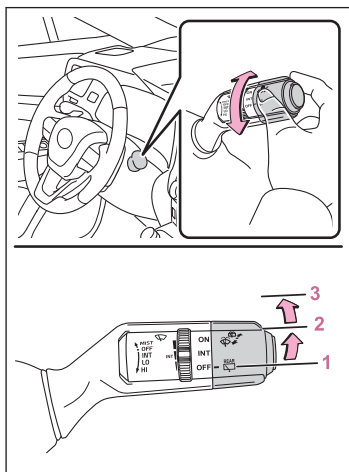

- 1 OFF Off
- 2 INT Intermittent operation
- 3 ON Normal operation

Using the rear washer

⚠ NOTICE

If a washer nozzle is blocked, contact your Lexus dealer.

Do not try to clear it with a pin or other object. The nozzle will be damaged.



Push the lever.

The rear wiper and washer will operate.

The washer will automatically operate and clean the camera for Lexus parking assist monitor.

The rear wiper will automatically operate a couple of times after the rear washer operates.

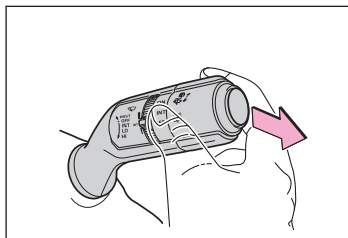

⚠ NOTICE

If washer fluid does not spray, do not operate the switch continuously as doing so may damage the rear washer fluid pump.

□ INFORMATION

■ The rear window wiper and washer can be operated when

The power switch is in ON.

■ If no windshield washer fluid sprays

If there is washer fluid in the washer fluid tank, check if the washer nozzles are blocked.

■ Using the voice control system*

The rear washer can be operated using the voice control system. (Operation is possible only when the vehicle is stopped.)

For details, refer to the "MULTIMEDIA OWNER'S MANUAL".

*: If equipped

3-4. Driving when the windows or mirrors are fogged up

Defog the windshield

Defoggers are used to defog the windshield and front side windows.

⚠ WARNING

- Do not use the windshield defogger in extremely humid areas when the air conditioning system is set to a low temperature.

The difference between the temperature of the outside air and that of the windshield can cause the outer surface of the windshield to fog up, blocking your vision.

- Do not place anything on the instrument panel which may cover the air outlets.

Otherwise, air flow may be obstructed, preventing the windshield defoggers from defogging.

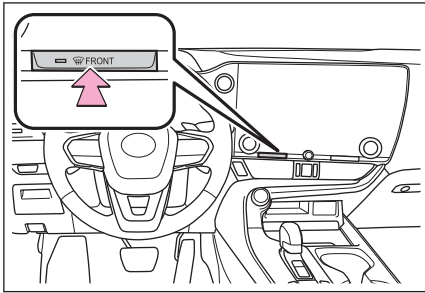
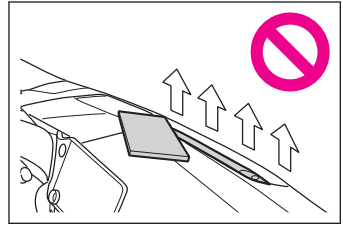

Press the windshield defogger switch.

The dehumidification function will operate and the air flow will increase.

Set the outside/recirculated air mode switch to outside air mode if the recirculated air mode is used. (It may switch automatically.)

To defog the windshield and the side windows quickly, turn the air flow and temperature up.

To return to the previous mode, press the windshield defogger switch again when the windshield is defogged.

INFORMATION

■ Fogging up of the windows

- The windows will easily fog up when the humidity in the vehicle is high.

Pressing "A/C" button or selecting "A/C" will dehumidify the air from the outlets and defog the windshield effectively.

- If you turn "A/C" off, the windows may fog up more easily.
- The windows may fog up if the recirculated air mode is used.

Defog the rear window

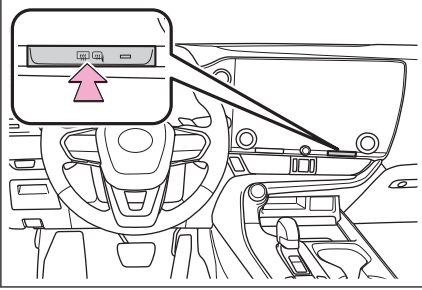

Press the rear windshield and outside rear view mirror defogger switch.

The rear window defogger and outside rear view mirror defoggers will operate and defog the rear window and outside rear view mirrors.

The defoggers will automatically turn off after a period of time.

▲ WARNING

Do not touch the surface of the outside rear view mirrors when the rear window defogger and outside rear view mirror defoggers are operating, as the surface of the mirrors will become extremely hot and may cause burns.

Defog the outside rear view mirrors

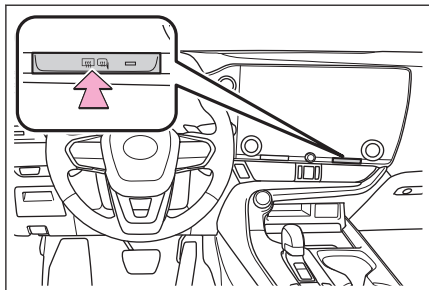

Press the rear windshield and outside rear view mirror defogger switch.

The rear window defogger and outside rear view mirror defoggers will operate and defog the rear window and outside rear view mirrors.

The defoggers will automatically turn off after a period of time.

▲ WARNING

Do not touch the surface of the outside rear view mirrors when the rear window defogger and outside rear view mirror defoggers are operating, as the surface of the mirrors will become extremely hot and may cause burns.

3-5. Driving when it is cold

Preparing for cold weather

Carry out the necessary preparations and inspections before driving the vehicle in cold weather. Always drive the vehicle in a manner appropriate to the prevailing weather conditions.

Necessary inspection items

- Use fluids that are appropriate to the prevailing outside temperatures.
 - Engine oil
 - Engine/power control unit coolant
 - Washer fluid
- Have a service technician inspect the condition of the 12-volt battery.

Mounting winter tires

Have the vehicle fitted with four winter tires.

Ensure that all of the tires are the same size and brand.

WARNING

Observe the following precautions when winter tires are mounted to the vehicle.

Failure to do so may lead to loss of control of the vehicle.

- Use tires of the specified size.
- Maintain the recommended level of air pressure.
- Do not drive in excess of 75 mph (120 km/h), regardless of the type of winter tires mounted.
- When using winter tires, mount them to all four wheels.

NOTICE

When having winter tires repaired or replaced, contact your Lexus dealer or a legitimate tire retailer.

This is because the removal and mounting of winter tires affects the operation of the tire pressure warning valves and transmitters.

When using tire chains

Install the tire chains to the front two tires.*1

Make sure to use tire chains which match the tire size.

*1: Tire chains cannot be mounted on 235/50R20 tires.

INFORMATION

Observe the following precautions when installing, removing, and handling tire chains:

- Install and remove tire chains in a safe location.
- Install tire chains to the front tires only.
Do not install tire chains to the rear tires.
- Install tire chains following the instructions provided with the tire chains.
- Install tire chains to the front tires as tightly as possible. Retighten the chains after driving 1/4 - 1/2 mile (0.5 - 1.0 km).

WARNING

Observe the following precautions when tire chains are installed to the vehicle.

Failure to do so may lead to the vehicle not being able to be driven safely.

- Do not drive in excess of the speed limit specified for the tire chains being used, or 30 mph (50 km/h), whichever is lower.
- Avoid driving on bumpy road surfaces or over potholes.
- Avoid sudden acceleration, abrupt steering, sudden braking and shifting operations that cause sudden engine braking.
- Slow down sufficiently before entering a curve to ensure that vehicle control is maintained.
- Do not use LTA (Lane Tracing Assist).
- Do not use LDA (Lane Departure Alert).

NOTICE**Fitting tire chains**

The tire pressure warning valves and transmitters may not function correctly when tire chains are fitted.

Selecting tire chains

Use the correct tire chain size when mounting the tire chains. Chain size is regulated for each tire size.

- Vehicles with 235/60R18 tires

3-5. Driving when it is cold

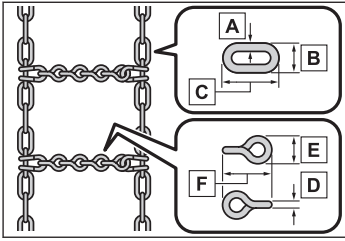

- A Side chain (0.12 in. [3 mm] in diameter)
- B Side chain (0.39 in. [10 mm] in width)
- C Side chain (0.98 in. [25 mm] in length)
- D Cross chain (0.16 in. [4 mm] in diameter)
- E Cross chain (0.55 in. [14 mm] in width)
- F Cross chain (0.98 in. [25 mm] in length)

● Vehicles with 235/50R20 tires

Tire chains cannot be mounted on the 235/50R20 tires.

Snow tires should be used instead.

■ **Regulations on the use of tire chains**

Regulations regarding the use of tire chains vary depending on location and type of road. Always check local regulations before installing chains.

Cold weather driving tips

Things to check before driving in cold weather

Perform the following according to the driving conditions:

- Do not try to forcibly open a window or move a wiper that is frozen. Pour warm water over the frozen area to melt the ice. Wipe away the water immediately to prevent it from freezing.
- To ensure proper operation of the climate control system fan, remove any snow that has accumulated on the air inlet vents in front of the windshield.
- Check for and remove any excess ice or snow that may have accumulated on the exterior lights, vehicle's roof, chassis, around the tires or on the brakes.
- Remove any snow or mud from the bottom of your shoes before getting in the vehicle.
- When the outside door opener switch becomes stiff, it may be difficult to press on it. Open the door while pressing the door opener switch slightly harder.

Precautions for driving in cold weather

Accelerate the vehicle slowly, keep a safe distance between you and the vehicle ahead, and drive at a reduced speed suitable to road conditions.

Precautions for parking in cold weather

- Turn automatic mode of the parking brake off. Otherwise, the parking brake may freeze and not be able to be released automatically.

Also, avoid using the following as the parking brake may operate automatically, even if automatic mode is off.

- Brake hold system
- Advanced Park (Remote Controlled)*

- Park the vehicle and shift the shift position to P without setting the parking brake. The parking brake may freeze up, preventing it from being released. If the vehicle is parked without setting the parking brake, make sure to block the wheels.

Failure to do so may be dangerous because it may cause the vehicle to move unexpectedly, possibly leading to an accident.

- When the parking brake is in automatic mode, release the parking brake after change the shift position to P.

*: If equipped

3-5. Driving when it is cold

- If the vehicle is parked without setting the parking brake, confirm that the shift lever cannot be moved out of P.
- If the vehicle is left parked with the brakes damp in cold temperatures, there is a possibility of the brakes freezing.

INFORMATION

■ **Linked mirror function when reversing**

When used in cold weather during reverse driving, the door mirror could be frozen and may not automatically point the mirror surface downward. In this event, remove any ice and snow from the mirror surface.

Warming the windshield to allow frozen wipers to be moved*

Use the windshield wiper de-icer to help prevent the windshield wiper blades from freezing to the windshield.

Select the [Deicer] switch on the option screen.

The windshield wiper de-icer will automatically turn off after a period of time.

WARNING

Do not touch the lower part of the windshield or parts along the front pillars when the windshield wiper de-icer is on, as they will be hot and may cause burns.

*: If equipped

Fog light illumination

When driving in inclement weather, such as in rain and fog, turn on the front fog lights to ensure forward visibility.

Using the fog lights

⚠ NOTICE

To prevent 12-volt battery discharge, do not leave the lights on longer than necessary when the hybrid system is off.

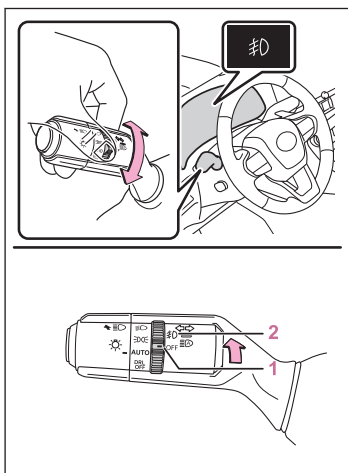

- 1 OFF (U.S.A.) or ○ (Canada) Turns the front fog lights off
- 2 ~~OFF~~ Turns the front fog lights on

□ INFORMATION

■ Fog lights can be used when

The low beam headlights are on.

Sounding the horn

Press on or close to the  mark.

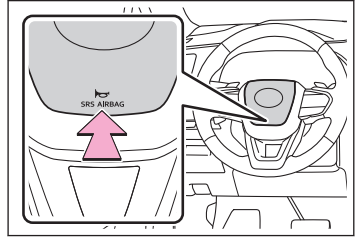

Utility vehicle precautions

This vehicle belongs to the utility vehicle class, which has higher ground clearance and narrower tread in relation to the height of its center of gravity.

Utility vehicle feature

- Specific design characteristics give it a higher center of gravity than ordinary passenger cars. This vehicle design feature causes this type of vehicle to be more likely to rollover. Utility vehicles have a significantly higher rollover rate than other types of vehicles.
- An advantage of the higher ground clearance is a better view of the road allowing you to anticipate problems.
- It is not designed for cornering at the same speeds as ordinary passenger cars any more than low-slung sports cars designed to perform satisfactorily under off-road conditions. Therefore, sharp turns at excessive speeds may cause rollover.

▲ WARNING

■ Utility vehicle precautions

Always observe the following precautions to minimize the risk of death or serious injury or damage to your vehicle:

- In a rollover crash, an unbelted person is significantly more likely to die than a person wearing a seat belt. Therefore, the driver and all passengers should always fasten their seat belts.
- Avoid sharp turns or abrupt maneuvers, if at all possible. Failure to operate this vehicle correctly may result in loss of control or vehicle rollover causing death or serious injury.
- Loading cargo on the roof luggage carrier (if equipped) will make the center of the vehicle gravity higher. Avoid high speeds, sudden starts, sharp turns, sudden braking or abrupt maneuvers, otherwise it may result in loss of control or vehicle rollover due to failure to operate this vehicle correctly.
- Always slow down in gusty crosswinds. Because of its profile and higher center of gravity, your vehicle is more sensitive to side winds than an ordinary passenger car. Slowing down will allow you to have better control.
- Do not drive horizontally across steep slopes. Driving straight up or straight down is preferred. Your vehicle (or any similar off-road vehicle) can tip over sideways much more easily than forward or backward.

Off-road driving

Your vehicle is not designed to be driven off-road. However, in the event that off-road driving cannot be avoided, please observe the following precautions to help avoid the areas prohibited to vehicles.

- Drive your vehicle only in areas where off-road vehicles are permitted to travel.
- Respect private property. Get owner's permission before entering private property.
- Do not enter areas that are closed. Honor gates, barriers and signs that restrict travel.
- Stay on established roads. When conditions are wet, driving techniques should be changed or travel delayed to prevent damage to roads.
- Avoid driving on very steep, slippery roads and other surfaces, such as sand, where the tires are liable to lose traction. Your vehicle may not perform as well as conventional AWD on-road vehicles on these surfaces.

INFORMATION

Additional information for off-road driving

For owners in U.S. mainland, Hawaii and Puerto Rico:

To obtain additional information pertaining to driving your vehicle off-road, consult the following organizations.

- State and Local Parks and Recreation Departments
- State Motor Vehicle Bureau
- Recreational Vehicle Clubs
- U.S. Forest Service and Bureau of Land Management

WARNING

Off-road driving precautions

Always observe the following precautions to minimize the risk of death or serious injury or damage to your vehicle:

- Drive carefully when off the road. Do not take unnecessary risks by driving in dangerous places.
- Do not grip the steering wheel spokes when driving off-road. A bad bump could jerk the wheel and injure your hands. Keep both hands and especially your thumbs on the outside of the rim.
- Always check your brakes for effectiveness immediately after driving in sand, mud, water or snow.

⚠ WARNING

- After driving through tall grass, mud, rock, sand, water, etc., check that there is no grass, bush, paper, rags, stone, sand, etc. adhering or trapped to the underbody. Clear off any such matter from the underbody. If the vehicle is used with these materials trapped or adhering to the underbody, a breakdown or fire could occur.
- When driving off-road or in rugged terrain, do not drive at excessive speeds, jump, make sharp turns, strike objects, etc. This may cause loss of control or vehicle rollover causing death or serious injury. You are also risking expensive damage to your vehicle's suspension and chassis.

⚠ NOTICE**■ To prevent water damage**

Take all necessary safety measures to ensure that water damage to the hybrid battery (traction battery), hybrid system or other components does not occur.

- Water entering the engine compartment may cause severe damage to the hybrid system. Water entering the interior may cause the hybrid battery stowed under the rear seats to short circuit.
- Water entering the hybrid transmission and rear electric motor (traction motor) will cause deterioration in transmission quality. The malfunction indicator may come on, and the vehicle may not be drivable.
- Water can wash the grease from wheel bearings, causing rusting and premature failure, and may also enter the hybrid transmission case, reducing the gear oil's lubricating qualities.

■ When you drive through water

If driving through water, such as when crossing shallow streams, first check the depth of the water and the bottom of the riverbed for firmness. Drive slowly and avoid deep water.

■ Inspection after off-road driving

- Sand and mud that has accumulated around brake discs may affect braking efficiency and may damage brake system components.
- Always perform a maintenance inspection after each day of off-road driving that has taken you through rough terrain, sand, mud, or water. For scheduled maintenance information, refer to the "Warranty and Services Guide/Owner's Manual Supplement/Scheduled Maintenance".

Driving modes

The following driving modes can be used according to the driving/usage conditions.

Characteristics of each driving mode

Vehicles without Adaptive Variable Suspension System:

■ Normal mode

Suitable when driving in the city, for good fuel consumption efficiency, silence, and drive-ability.

■ Eco mode

In contrast with Normal mode, torque generation is slower when stepping on the accelerator pedal, air conditioning operations (heating/cooling) are restrained, and driving becomes suited for improved fuel consumption.

■ Sport mode

Helps to ensure steering feel and accelerator response by controlling the hybrid system and transmission. Suitable for sporty, fun driving, such as when driving on mountain roads.

Vehicles with Adaptive Variable Suspension System:

■ Normal/Custom mode

● Normal mode

Suitable when driving in the city, for good fuel consumption efficiency, silence, and drive-ability.

● Custom mode

Driving is possible by setting the desired function for power train control, chassis control or air conditioning operations. Custom mode settings can only be changed on the drive mode customization display of the center display.

■ Eco mode

In contrast to Normal mode when stepping on the accelerator pedal, torque generation becomes slower, air conditioning operations (heating/cooling) are restrained, and driving is suited for improved fuel consumption.

■ Sport mode

● Sport S mode

Through control of the hybrid system and transmission, the generated torque when the accelerator pedal is depressed is increased. Making this mode suitable for when powerful acceleration is desired.

● Sport S+ mode

Through control of the hybrid system and transmission, the generated torque when the accelerator pedal is depressed is further increased, and excellent stability is provided through comprehensive control of the steering and suspension. Making this mode suitable for sporty driving.

 **INFORMATION**

■ **Operation of the air conditioning system in Eco mode**

- In the Eco mode, the air conditioning system is controlled as follows to prioritize fuel efficiency.
 - Engine speed and compressor operation controlled to restrict heating/cooling capacity
 - Fan speed restricted when automatic mode is selected
- To improve air conditioning performance, perform the following operations:
 - Adjust the fan speed
 - Adjust the temperature setting
 - Turn off Eco mode
- When the driving mode is set to Eco mode, the air conditioning system may automatically change to Eco mode. To cancel eco mode, press [Eco heat/cool].

Changing the driving mode

► Vehicles without Adaptive Variable Suspension System

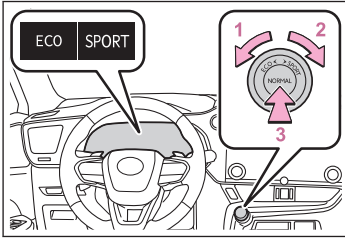

1 Eco mode

When not in Eco mode, turn the driving mode select switch to the left to change the driving mode to Eco mode. The Eco drive mode indicator will be displayed on the multi-information display.

2 Sport mode

When not in Sport mode, turn the driving mode select switch to the right to change the driving mode to Sport mode. The Sport mode indicator will be displayed on the multi-information display.

3 Normal mode

Press the driving mode select switch to change the driving mode to Normal mode when Eco mode or Sport mode is selected.

► Vehicles with Adaptive Variable Suspension System

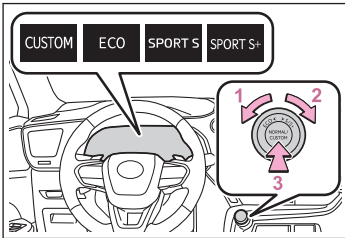

1 Eco mode

When not in Eco mode, turn the driving mode select switch to the left to change the driving mode to Eco mode. The Eco drive mode indicator will be displayed on the multi-information display.

2 Sport mode

● Sport S mode

When not in Sport S mode, turn the driving mode select switch to the right to change the driving mode to Sport S mode. The Sport S mode indicator will be displayed on the multi-information display.

● Sport S+ mode

When Sport S mode, turn the driving mode select switch to the right to change the driving mode to Sport S+ mode.

The Sport S+ mode indicator will be displayed on the multi-information display.

3 Normal/Custom mode

Press the switch to select Normal mode or Custom mode. Each time the switch is pressed, the system changes between Normal mode and Custom mode.

When Custom mode is selected, the Custom mode indicator will be displayed on the multi-information display.

If the switch is pressed when in Eco mode or Sport mode, the system will return to Normal mode.

INFORMATION

■ Canceling Sport/Custom mode

- Select another driving mode. Sport mode and Custom mode will be canceled automatically when the power switch is turned off.
- Normal mode and Eco mode will not be canceled automatically until another driving mode is selected, even if the power switch is turned off.

■ Display of the multi-information display according to selected driving mode

According to the driving mode selected, the gauges displayed on the multi-information display may change.

Related Links

[Customizable features\(P. 765\)](#)

Trail Mode (AWD vehicles)

Trail Mode is designed to control the spinning of the drive wheels by integrately controlling 4WD, brake and drive force control systems. Use the Trail Mode when driving bumpy roads, etc.

● Press the Trail Mode switch.

Press the Trail Mode switch, to turn the Trail Mode on. The Trail Mode indicator light will come on the multi-information display. To turn the system off, press the Trail Mode switch again.

If the tires are spinning, the slip indicator flashes to indicate that the Trail Mode is controlling the spinning of the tires.

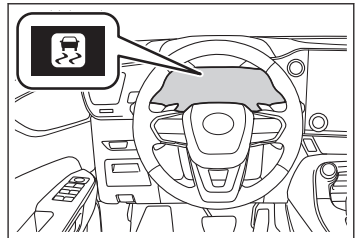
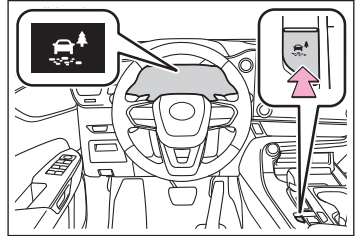

☐ INFORMATION

■ Trail Mode

- Trail Mode controls the vehicle so that it can use the maximum amount of drive force when driving on rough roads. As a result, fuel efficiency may diminish when compared to driving with Trail Mode off.
- If Trail Mode is continuously used for a long period of time, depending on the driving conditions, the load on related parts increases and the system may not function correctly. In this case, "**Traction Control Turned OFF**" will be shown on the multi-information display but the vehicle can be driven normally. The "**Traction Control Turned OFF**" on the multi-information display will turn off after a short while and the system will operate properly.

■ When Trail Mode is canceled

In the following situations, Trail Mode is automatically canceled even if it is selected:

- When the driving mode is changed.
- When the hybrid system is restarted.

■ Sounds and vibrations when driving in Trail Mode

Any of the following conditions may occur when Trail Mode is operating. None of these indicates that a malfunction has occurred:

- Vibrations may be felt throughout the vehicle or steering
- Sounds may be heard from the engine compartment

■ **When the Trail Mode indicator does not illuminate**

When the Trail Mode indicator does not illuminate even though the Trail Mode switch is pressed, the system may be malfunctioning.

Have the vehicle checked by your Lexus dealer immediately.

▲ WARNING

■ **Before using Trail Mode**

Make sure to observe the following precautions. Failure to observe these precautions may result in an unexpected accident.

- Trail mode is intended for use when driving on rough roads.
- Check that the Trail Mode indicator is illuminated before driving.
- Trail Mode is not intended to expand the limits of the vehicle. Thoroughly check the road conditions and drive with caution.

▲ NOTICE

■ **In order to ensure that Trail Mode operates properly**

Do not continuously use the Trail Mode for a long period of time. Depending on the driving conditions, the load on related parts increases and the system may not operate properly.

Related Links

[Changing the driving mode\(P. 262\)](#)

Brake hold system

⚠ WARNING

■ When the vehicle is on a steep incline

When using the brake hold system on a steep incline, exercise caution. The brake hold function may not hold the vehicle in such a situation.

■ When stopped on a slippery road

The system cannot stop the vehicle when the gripping ability of the tires has been exceeded. Do not use the system when stopped on a slippery road.

⚠ NOTICE

■ When parking the vehicle

The brake hold system is not designed for use when parking the vehicle for a long period of time. Turning the power switch off while the system is holding the brake may release the brake, which would cause the vehicle to move. When operating the power switch, depress the brake pedal, shift the shift position to P and set the parking brake.

— Related Links —

[Parking brake operation\(P. 207\)](#)

[Brake hold operated indicator \(warning buzzer\)\(P. 650\)](#)

Turns the brake hold system on

The brake hold system keeps the brake applied when the shift position is in D, S or N with the system on and the brake pedal has been depressed to stop the vehicle. The system releases the brake when the accelerator pedal is depressed with the shift position in D or S to allow smooth start off.

Turns the brake hold system on

The brake hold standby indicator (green) comes on. While the system is holding the brake, the brake hold operated indicator (yellow) comes on.

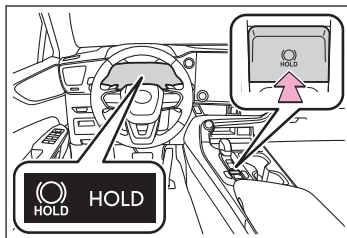

□ INFORMATION

■ Brake hold system operating conditions

The brake hold system cannot be turned on in the following conditions:

- The driver's door is not closed.
- The driver is not wearing the seat belt.
- The parking brake is engaged.

If any of the conditions above are detected when the brake hold system is enabled, the system will turn off and the brake hold standby indicator light will go off. In addition, if any of the conditions are detected while the system is holding the brake, a warning buzzer will sound and a message will be shown on the multi-information display. The parking brake will then be set automatically.

■ Brake hold function

- If the brake pedal is left released for a period of about 3 minutes after the system has started holding the brake, the parking brake will be set automatically. In this case, a warning buzzer sounds and a message is shown on the multi-information display.
- The brake hold function may not hold the vehicle when the vehicle is on a steep incline. In this situation, it may be necessary for the driver to apply the brakes. A warning buzzer will sound and the multi-information display will inform the driver of this situation. If a warning message is shown on the multi-information display, read the message and follow the instructions.
- To turn the system off while the system is holding the brake, firmly depress the brake pedal and press the button again.
- When do not wish for the parking brake to operate automatically, press and hold the brake hold switch until the standby indicator (green) turns off, and then turn the power switch off.

■ When the parking brake is set automatically while the system is holding the brakes

Perform any of the following operations to release the parking brake.

- Depress the accelerator pedal. (The parking brake will not be released automatically if the seat belt is not fastened.)
- Operate the parking brake switch with the brake pedal depressed.

Make sure that the parking brake indicator light goes off.

■ When an inspection at your Lexus dealer is necessary

When the brake hold standby indicator (green) does not illuminate even when the brake hold switch is pressed with the brake hold system operating conditions met, the system may be malfunctioning.

Have the vehicle checked by your Lexus dealer immediately.

■ If "Brake Hold Malfunction" is displayed on the multi-information display

The system may be malfunctioning.

Have the vehicle checked by your Lexus dealer immediately.

■ **Warning messages and buzzers**

Warning messages and buzzers are used to indicate a system malfunction or to inform the driver of the need for caution. If a warning message is shown on the multi-information display, read the message and follow the instructions.

4-1. Favorite settingsMy Settings **270****4-2. Adjusting the preferred driving position**Enabling easier driver entry and exit (Power easy access system)..... **272**Driving position registration/recall/deletion..... **273****4-3. Adjusting the temperature/environment inside the vehicle**Comfortable condition to be maintained without adjusting each system (Lexus Climate Concierge)..... **277**Air conditioning controls **279**Heated steering wheel..... **289**Seat heaters **290**Seat ventilators **292**Using the moon roof **293****4-4. Illuminating the interior**Using the interior lights..... **296****4-5. Using the interior features**Location of the storage features **300**Convenient interior features **306****4-6. Using the luggage compartment**Using the cargo hooks **317**Using the cargo net hooks .. **318**Using the grocery bag hooks **319**Deck board..... **320**Stowing the luggage cover . **322**

My Settings*

By recognizing an individual through a device, such as an electronic key, the driving position and vehicle settings recorded for that driver can be recalled when the vehicle is entered. By assigning an authentication device to a driver in advance, the driver can enter the vehicle with their preferred settings. Settings for up to 3 drivers can be recorded by My Settings. For details on how to assign/delete electronic keys, set driver names, perform initialization, change drivers manually, or delete a driver, refer to the "MULTIMEDIA OWNER'S MANUAL".

■ Types of assigned authentication devices

An individual can be identified using the following authentication devices.

● Electronic key

or Digital key*

An individual is identified when the smart access system with push-button start detects their electronic key or digital keys*.

● Bluetooth devices

An individual can be detected if the same Bluetooth device that was used as a hands-free phone the last time the vehicle was entered is connected to the audio system.

■ Recalled functions

When an individual is identified from an authentication device, settings for the following functions are recalled.

● Driving position (memory recall function)*

After an individual is identified, the driving position that was set when driving was last completed is recalled when the following operation is performed.

The door is unlocked and opened using the smart access system with push-button start or wireless remote control.

● Meter displays, head-up display* and multimedia information*¹

When an individual is identified, the vehicle settings used when the power switch was last turned off are recalled.

● Vehicle settings that can be set using the center display*¹

When an individual is identified, the vehicle settings used when the power switch was last turned off are recalled.

● Safe driving support function*¹

*: If equipped

*1: Some settings are excluded

When an individual is identified, the vehicle settings used when the power switch was last turned off are recalled.

Enabling easier driver entry and exit (Power easy access system)

▲ WARNING

Never use any part of your body to intentionally activate the jam protection function.

When all of the following have been performed, the driver's seat and steering wheel are automatically adjusted to a position that allows driver to enter and exit the vehicle easily.

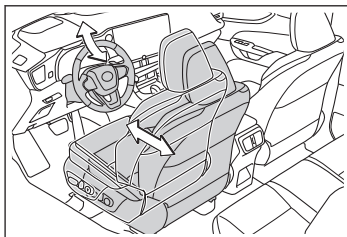

- The shift position has been shifted to P.
- The power switch has been turned to ACC or ON.
- The driver's seat belt has been unfastened.

When any of the following has been performed, the driver's seat and steering wheel automatically return to their original positions.

- The power switch has been turned to ACC mode or ON.
- The driver's seat belt has been fastened.

□ INFORMATION

■ Operation of the power easy access system

When exiting the vehicle, the power easy access system may not operate if the seat is already close to the rearmost position, etc.

■ Jam protection function

While the power easy access system is operating, if an object is stuck behind the front seat, the front seat will stop and then slightly move forward. When the jam protection function operates, the seat stops at a position other than the set seat position. Check the seat position.

— Related Links —

[Customizable features\(P. 765\)](#)

Driving position registration/recall/deletion

This feature automatically adjusts the positions of the driver's seat, steering wheel, outside rear view mirrors and head-up display* to make entering and exiting the vehicle easier or to suit your preferences.

Vehicle with the My Settings:

Up to 3 different driving positions can be recorded for each the driver and guest that have been registered for My Settings. When electronic key (including a card key) assignment is registered for My Settings, the driving position for each driver can be recalled (memory recall function).

Vehicle without the My Settings:

Up to 3 different driving positions can be recorded.

INFORMATION

■ Using the voice control system*

The following operations can be performed using the voice control system:

- Driving position registration
- Driving position recall (only when the shift position is in P)

For details, refer to the "MULTIMEDIA OWNER'S MANUAL".

Registering a driving position into memory (position memory function)

- 1 Check that the shift position is in P.
- 2 Turn the power switch to ON.
- 3 Adjust the driver's seat, steering wheel, outside rear view mirrors and head-up display* to the desired positions.
- 4 While pressing the "SET" button, or within 3 seconds after the "SET" button is pressed, press button "1", "2" or "3" until the buzzer sounds.

If a driving position has already been registered to the selected button, the previously registered position will be overwritten.

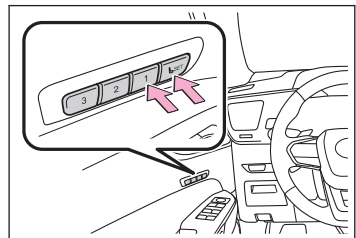

*: If equipped

4-2. Adjusting the preferred driving position

INFORMATION

■ Seat positions that can be memorized

The adjusted positions other than the position adjusted by lumbar support switch can be recorded.

■ In order to correctly use the driving position memory function

If a seat position is already in the furthest possible position and the seat is operated in the same direction, the registered position may be slightly different when it is recalled.

WARNING

Take care during seat adjustment so that the seat does not contact a rear passenger or squeeze your body against the steering wheel.

Recalling a driving position (position memory function)

WARNING

Never use any part of your body to intentionally activate the jam protection function.

- 1 Check that the shift position is in P.
- 2 Turn the power switch to ON.
- 3 Press one of the buttons for the driving position you want to recall until the buzzer sounds.

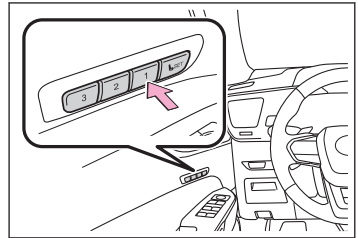

INFORMATION

■ To stop the position recall operation part-way through

Perform any of the following:

- Press the "SET" button.
- Press button "1", "2" or "3".
- Operate any of the seat adjustment switches (only cancels seat position recall).
- Operate the tilt and telescopic steering control switch (only cancels steering wheel position recall).

■ Operating the driving position memory after turning the power switch off

Registered seat positions can be recalled up to 180 seconds after the driver's door is opened and another 61 seconds after it is closed again.

■ When the recorded seat position cannot be recalled

The seat position may not be recalled in some situations when the seat position is recorded in a certain range.

For details, contact your Lexus dealer.

■ Jam protection function

While the driving position is recalled or the power easy access system is operating, if an object is stuck behind the front seat, the front seat will stop and then slightly move forward. When the jam protection function operates, the seat stops at a position other than the set seat position. Check the seat position.

■ Recalling a driving position

Take care so that a head restraint does not contact the ceiling or a sun visor.

Registering a driving position to My Settings (memory recall function)

The driving positions can be automatically recalled for each registered driver by registering electronic key assignments in My Settings.

When the shift position is changed to P after driving the vehicle, the current driving position will be recorded.

Clearing the registered driving position from an electronic key (memory recall function)

The driving positions can be automatically recalled for each registered driver by registering electronic key assignments in My Settings.

Initialize the driver registered settings in My Settings.

Recalling a driving position registered to My Settings (memory recall function)

The driving positions can be automatically recalled for each registered driver by registering electronic key assignments in My Settings.

⚠ WARNING

Never use any part of your body to intentionally activate the jam protection function.

- 1 Carry only the key that has been assigned and registered in My Settings, and then unlock and open the driver's door using the smart access system with push-button start or wireless remote control.

4-2. Adjusting the preferred driving position

The driving position other than the steering wheel will move to the recorded position. However, the seat will move to a position slightly behind the recorded position in order to make entering the vehicle easier.

If the driving position is in a position that has already been recorded, the driving position will not move.

2 Turn the power switch to ACC or ON.

The seat and steering wheel (only when the power switch is in ON) will move to the recorded position.

INFORMATION

■ Jam protection function

While the driving position is recalled or the power easy access system is operating, if an object is stuck behind the front seat, the front seat will stop and then slightly move forward. When the jam protection function operates, the seat stops at a position other than the set seat position. Check the seat position.

■ Recalling a driving position

Take care so that a head restraint does not contact the ceiling or a sun visor.

Comfortable condition to be maintained without adjusting each system (Lexus Climate Concierge)

Operation of the seat heaters and seat ventilators of the front seats and the heated steering wheel is performed automatically according to the temperature setting of the air conditioning system, outside temperature, temperature inside the vehicle, etc.*

Lexus Climate Concierge

Lexus Climate Concierge operates in conjunction with [AUTO] of the air conditioning system.

- 1 Select the option screen switch. → P.282
- 2 Select the [Climate concierge] switch.
- 3 Turn the [AUTO] switch on.

Automatically controllable functions

- Automatic air conditioning system → P.279

Operation of the air conditioning system is performed automatically according to the temperature setting for the driver's side/front passenger's side.

- Seat heaters → P.290

Operation of the seat heaters is performed automatically according to the temperature setting for the driver's side/front passenger's side.

Operation will automatically change between the seat heaters and seat ventilators according to the temperature setting of the air conditioning system, outside temperature, etc.

- Seat ventilators → P.292

Operation of the seat ventilators is performed automatically according to the temperature setting for the driver's side/front passenger's side.

Operation will automatically change between the seat heaters and seat ventilators according to the temperature setting of the air conditioning system, outside temperature, etc.

- Heated steering wheel → P.289

Operation of the heated steering wheel is performed automatically according to the temperature setting of the air conditioning system, outside temperature, etc.

*: If equipped

INFORMATION

■ Passenger detection functions

- When a passenger is detected in the front passenger seat, the seat heater and ventilator will operate automatically.
- When the seat heater/seat ventilator switch is set to AUTO, the passenger detection function will not operate.

■ Rear seat heater operation (vehicles with rear seat heaters)

The rear seat heaters are not controlled by the Lexus Climate Concierge.

Air conditioning controls

When the [AUTO] switch is on, the air outlets and fan speed will automatically be changed according to the set temperature.

⚠ NOTICE

- Do not leave the air conditioning system on longer than necessary when the hybrid system is off.
- When repairing/replacing parts of the air conditioning system, have repair/replacement performed by your Lexus dealer. When a part of the air conditioning system, such as the evaporator, is to be replaced, it must be replaced with a new one.

📖 INFORMATION

■ Heating

- In HV mode, the gasoline engine may operate in order to extract heat from the engine coolant via the heater.
- In EV mode or Auto EV/HV mode, heating is done by a heat pump system.
 - When the outside temperature is low or it is snowing, compared to conventional vehicles, heating may be less effective and warm air may not come out.
 - When the outside heat exchanger is frosted over, fan speed declines and it may become harder to heat the interior. However, it is not a malfunction. In this situation, the air temperature from the outlets may not change even though the set temperature is raised.
 - When [AUTO] switch is turned on, the heating is controlled optimally. Therefore, the set heating performance may not be achieved even if the fan speed setting is increased.

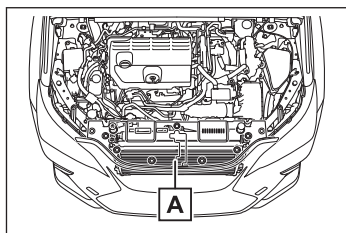

A Outside heat exchanger

- In the following situations the gasoline engine may operate in order to extract heat from the engine coolant via the heater even in EV mode.
 - The outside temperature is approximately -10°C (14°F) or low
 - Windshield defogger switch is operating

■ Water droplets during air conditioning operation

The outside heat exchanger, accumulator and air conditioning piping may incur condensation or frost may form.

During or after the air conditioning operation, water droplets may fall from the vehicle. However, it is not a malfunction.

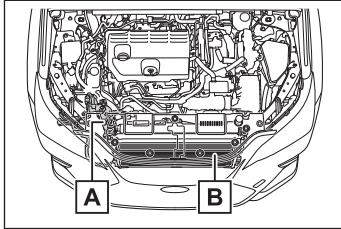

- A Accumulator
- B Outside heat exchanger

■ When the outside temperature exceeds 75°F (24°C) and the air conditioning system is on

- In order to reduce the air conditioning power consumption, the air conditioning system may switch to recirculated air mode automatically. This may also reduce fuel consumption.
- Recirculated air mode is selected as a default mode when the power switch is turned to ON mode.
- It is possible to switch to outside air mode at any time by select the outside/recirculated air mode switch.

■ When driving on dusty roads

Close all windows. If dust thrown up by the vehicle is still drawn into the vehicle after closing the windows, it is recommended that the air intake mode be set to outside air mode and the fan speed to any setting except off.

■ When the outside temperature is low

The dehumidification function may not operate even when [A/C] is selected.

■ Ventilation and air conditioning odors

- To let fresh air in, set the air conditioning system to the outside air mode.
- During use, various odors from inside and outside the vehicle may enter into and accumulate in the air conditioning system. This may then cause odor to be emitted from the vents.
- To reduce potential odors from occurring:
 - It is recommended that the air conditioning system be set to outside air mode prior to turning the vehicle off.
 - The start timing of the blower may be delayed for a short period of time immediately after the air conditioning system is started in automatic mode.

- When parking, the system automatically switches to outside air mode to encourage better air circulation throughout the vehicle, helping to reduce odors that occur when starting the vehicle.

■ Air conditioning system refrigerant

- A label regarding the refrigerant of the air conditioning system is attached to the hood at the location shown in the following illustration.

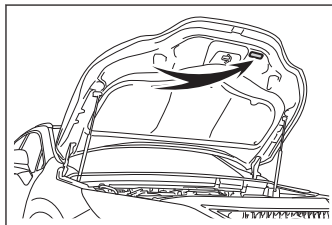

- The meaning of each symbol on the label are as follows.

	Caution
	Air conditioning system
	Air conditioning system lubricant type
	Requires registered technician to service air conditioning system
	Flammable refrigerant

■ Changing of the air outlets while in automatic mode

When in automatic mode, if the humidity sensor detects fog on the inside of the windshield, the air outlets will automatically be controlled to defog the windshield.

■ Using the voice command system

Air conditioning system can be operated using voice commands. For details, refer to "MULTIMEDIA OWNER'S MANUAL"

■ Customization

Functions that are linked to automatic mode (when the [AUTO] switch is on) can be set through [Vehicle customize] on the center display.

⚠ NOTICE

■ Humidity sensor

- In order to detect fog on the windshield, a sensor which monitors the temperature of the windshield, the surround humidity, etc., is installed.

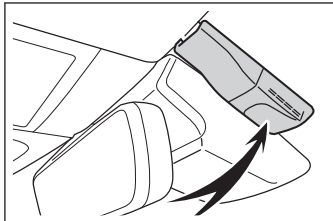

- Follow these points to avoid damaging the sensor:
 - Do not disassemble the sensor
 - Do not spray the glass cleaner on the sensor or subject it to strong impacts
 - Do not stick anything on the sensor

— Related Links —

[Customizable features\(P. 765\)](#)

Option screen switch

▶ 14-inch center display model

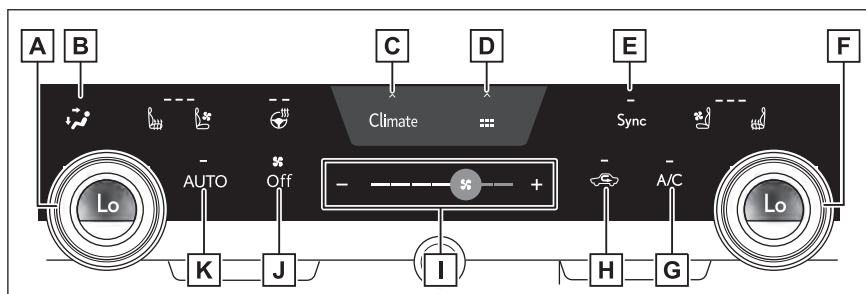

A Left-hand side temperature control switch

B Airflow mode control switch

C Option screen switch

D Shortcut screen switch

Select to display shortcut icons for various functions.

E [Sync] switch

F Right-hand side temperature control switch

G [A/C] switch

- H** Outside/recirculated air mode switch
- I** Fan speed control switch
- J** [Off] switch
- K** [AUTO] switch

Adjusting the temperature

Turn temperature control dial clockwise to increase the temperature and turn the dial counterclockwise to decrease the temperature.

When the indicator on the [Sync] switch is illuminated, the temperature setting for the front passenger's side will match the setting for the driver's side.

When the indicator on the [Sync] switch is off, turning the [Sync] switch on will illuminate the [Sync] switch indicator and the temperature setting for the front passenger's side will become the same as that for the driver's side.

When the front passenger's side temperature adjustment switch is operated, the indicator on the [Sync] switch will turn off and the temperature setting for the front passenger's side will be able to be adjusted.

When the indicator on the [A/C] switch is off, the blower and heater can be used.

Setting the fan speed

To increase the fan speed, select the [+] fan speed adjustment switch or slide the icon of the fan speed adjustment switch right. To decrease the fan speed, select the [-] fan speed adjustment switch or slide the icon of the fan speed adjustment switch left.

Select the [Off] switch to turn the fan off.

Changing the air flow mode

Select the airflow mode control switch

The airflow mode changes each time the switch is selected.

The air outlets and air volume changes according to the selected air flow mode.



: Air flows to the upper body



: Air flows to the upper body and feet



: Air flows to the feet



: Air flows to the feet and the windshield defogger operates

INFORMATION

Location of air outlets

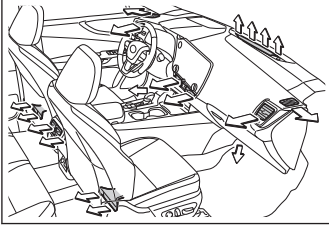

Switching between outside air mode and recirculated air mode

Temporarily changing the air mode to recirculated air mode is recommended to prevent dirty air from entering the vehicle, such as when in a tunnel or heavy traffic, and to help cool the interior when the outside air temperature is high.

Select the outside/recirculated air mode switch.

The air mode changes between outside air mode and recirculated air mode each time the switch is selected. When recirculated air mode is selected, the indicator will illuminate.

The air mode may change automatically depending on the temperature setting, temperature inside the vehicle, etc.

Front seat concentrated airflow mode (S-FLOW)

This function automatically controls the airflow of the air conditioning system to prioritize airflow to the front seats. Fuel economy can be enhanced by reducing unnecessary cooling.

Front seat concentrated airflow mode operates in the following situations.

- No passengers are detected in the rear seats
- The windshield defogger is not operating

While operating, the indicator illuminates.

In front seat concentrated airflow mode, directing airflow to the front seats only and to all seats can be switched via switch operation. When the mode has been switched manually, automatic airflow control stops operating.

- 1 Select the option screen switch.
- 2 Select the [S-Flow] switch.

- Indicator illuminated: Airflow to the front seats only
- Indicator off: Airflow to all the seats

INFORMATION

■ Operation of automatic airflow control

- In order to maintain a comfortable interior, airflow may be directed to seats without passengers immediately after the hybrid system is started and at other times depending on the outside temperature.
- After the hybrid system is started, if passengers move around inside or enter/exit the vehicle, the system cannot accurately detect the presence of passengers and automatic airflow control will not operate.

■ Operation of manual airflow control

Even if the function is manually switched to directing airflow to only the front seats, when a rear seat is occupied, it may automatically direct airflow to all seats.

■ To return to automatic airflow control

1. With the indicator off, turn the power switch off.
2. After 60 minutes or more elapse, turn the power switch to ON.

Eco air conditioning mode

The air conditioning is controlled with low fuel consumption prioritized such as reducing fan speed, etc.

- 1 Select the option screen switch.
- 2 Select the [Eco heat/cool].

- In Eco drive mode, the air conditioning system is controlled as follows to prioritize fuel efficiency. To improve air conditioning performance, turn off Eco air conditioning mode.
 - Engine speed and compressor operation controlled to restrict heating/cooling capacity.
 - Fan speed restricted when automatic mode is selected.
- When the driving mode is set to Eco driving mode, the Eco air conditioning mode will be turned on automatically. Even in this case, the Eco air conditioning mode can be turned off by selecting the [Eco heat/cool].

Warming the interior quickly (Max heat)

When [Max heat] is turned on, in order to warm the interior quickly, the settings of the air conditioning system will be changed immediately.

- 1 Select the shortcut screen switch.

2 Select the [Max heat] switch.

- The temperature setting of the air conditioning system will be set to [Hi] and the [AUTO] switch will be turned on.
- Seat heaters will be set to Hi.
- Heated steering wheel will be set to Hi.
- In the following situations, the front passenger's side seat heater will be set to [AUTO].
 - When [Climate concierge] is on
 - When the system determines that a passenger is in the front passenger seat
- When the indicator on the [Sync] switch is illuminated, the temperature setting for the front passenger's side will also be set to [Hi].

INFORMATION

[Max heat]

- The [Max heat] switch cannot be used to turn the setting off.
- After the [Max heat] switch has been operated, the temperature setting can be adjusted using the temperature control switches of the air conditioning system.
- When [Climate concierge] is on, if the [AUTO] switch is turned on, the seat heaters and seat ventilators of the front seats, and the heated steering wheel will be operated automatically according to the temperature setting.*
- Each function can also be adjusted to the desired setting.

Cooling the interior quickly (Max cool)

When [Max cool] is turned on, in order to cool the interior quickly, the settings of the air conditioning system will be changed immediately.

1 Select the shortcut screen switch.

2 Select the [Max cool] switch.

- The temperature setting of the air conditioning system will be set to [Lo] and the [AUTO] switch will be turned on.
- Seat ventilators will be set to Hi.
- In the following situations, the front passenger's side seat heater will be set to [AUTO].
 - When [Climate concierge] is on
- In the following situations, the front passenger's side seat heater will be set to [AUTO].

*: If equipped

- When [**Climate concierge**] is on
- When the system determines that a passenger is in the front passenger seat
- When the indicator on the [**Sync**] switch is illuminated, the temperature setting for the front passenger's side will also be set to [**Lo**].

INFORMATION

■ [**Max cool**]

- The [**Max cool**] switch cannot be used to turn the setting off.
- After the [**Max cool**] switch has been operated, the temperature setting can be adjusted using the temperature control switches of the air conditioning system.
- When [**Climate concierge**] is on, if the [**AUTO**] switch is turned on, the seat heaters and seat ventilators of the front seats, and the heated steering wheel will be operated automatically according to the temperature setting.*
- Each function can also be adjusted to the desired setting.

Adjusting the position of and opening and closing the air outlets

To adjust the position of and opening and closing the air outlets, perform the following operations:

► Front center

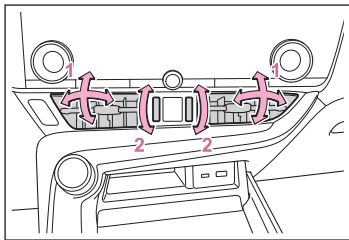

- 1 Direct air flow to the left or right, up or down
- 2 Turn the knob to open or close the vent

► Front side

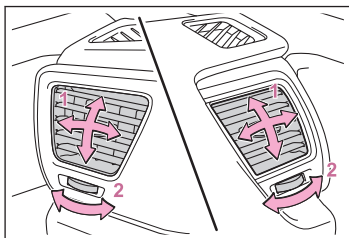

- 1 Direct air flow to the left or right, up or down
- 2 Turn the knob to open or close the vent

*: If equipped

4-3. Adjusting the temperature/environment inside the vehicle

► Rear

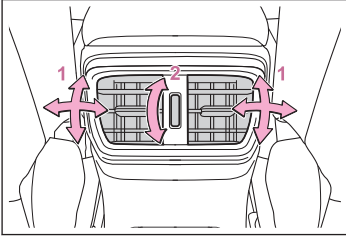

- 1 Direct air flow to the left or right, up or down
- 2 Turn the knob to open or close the vent

Heated steering wheel

Warm up the grip of the steering wheel.

WARNING

Care should be taken if anyone in the following categories comes in contact with the steering wheel when the heater is on:

- Babies, small children, the elderly, the sick and the physically challenged
- Persons with sensitive skin
- Persons who are fatigued
- Persons who have taken alcohol or drugs that induce sleep (sleeping drugs, cold remedies, etc.)

NOTICE

Do not use the functions when the hybrid system is off.

INFORMATION

Operating conditions

When the power switch is ON.

Turn the steering heater ON/OFF

Select  on the center display.

Each time the switch is selected, the operation condition changes as follows.

AUTO→Hi (2 segments lit)→Lo (1 segment lit)→Off

The level indicator (red) lights up during operation. [AUTO] indicator lights up during automatic operation.

INFORMATION

Customization

The temperature setting of the heated steering wheel can be set through [Vehicle customize] on the center display.





Seat heaters

Warm up the seat upholstery.

WARNING



To prevent minor burn injuries

Care should be taken if anyone in the following categories comes in contact with the seats when the heater is on:

-  Babies, small children, the elderly, the sick and the physically challenged
-  Persons with sensitive skin
-  Persons who are fatigued
-  Persons who have taken alcohol or drugs that induce sleep (sleeping drugs, cold remedies, etc.)

To prevent causes of overheating and minor burn injuries

Observe the following precautions when using a seat heater:

-  Do not cover the seat with a blanket or cushion when using the seat heater.
-  Do not use seat heater more than necessary.

NOTICE

To prevent damage to the seat heaters

Do not put heavy objects that have an uneven surface on the seat and do not stick sharp objects (needles, nails, etc.) into the seat.

To prevent 12-volt battery discharge

Do not use the functions when the hybrid system is off.

INFORMATION

Operating conditions

The power switch is in ON.

Turn the front seat heaters ON/OFF

Select  or  on the center display.

Each time the switch is selected, the operation condition changes as follows.

AUTO → Hi (3 segments lit) → Mid (2 segments lit) → Lo (1 segment lit) → Off

The level indicator (red) lights up during operation. [AUTO] indicator lights up during automatic operation.

INFORMATION

■ Customization

The temperature setting of the seat heaters of the front seats can be set through [Vehicle customize] on the center display.

Turns the rear seat heaters on/off*

Press the switch.

Each time the switch is pressed, the operation condition changes as follows.

Hi (3 segments lit) → Mid (2 segments lit) → Lo (1 segment lit) → Off

The level indicators (yellow) light up during operation.

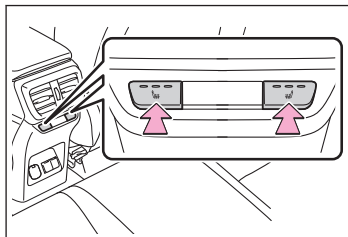

*: If equipped

Seat ventilators

Using fans inside the seats, improved ventilation can be provided at the surface of the seats.

NOTICE

To prevent damage to the seat ventilators

Do not put heavy objects that have an uneven surface on the seat and do not stick sharp objects (needles, nails, etc.) into the seat.

To prevent 12-volt battery discharge

Do not use the functions when the hybrid system is off.

INFORMATION

Operating conditions

The power switch is in ON.

Turn the seat ventilators (front) ON/OFF

Select  or  on the center display.

Each time the switch is selected, the operation condition changes as follows.

Hi (3 segments lit) → Mid (2 segments lit) → Lo (1 segment lit) → Off

The level indicator (blue) lights up during operation. [AUTO] indicator lights up during automatic operation.

INFORMATION

Air conditioning system-linked control mode

When a seat ventilator is set to Hi, the fan speed of the seat ventilator may increase according to the fan speed of the air conditioning system.

Customization

The fan speed setting of the seat ventilators can be set through [Vehicle customize] on the center display.

Using the moon roof

For comfortable cabin experience, the moon roof can be opened or tilted up.

WARNING

Observe the following precautions.

- Do not allow any passengers to put their hands or heads outside the vehicle while it is moving.
- Do not sit on top of the moon roof.
- The driver is responsible for moon roof opening and closing operations. In order to prevent accidental operation, especially by a child, do not let a child operate the moon roof. It is possible for children and other passengers to have body parts caught in the moon roof.
- Make sure that all passengers do not have any part of their body in a position where it could be caught when the moon roof is being operated.
- When using the wireless remote control or mechanical key to operate the moon roof, operate the moon roof after making sure that there is no possibility of any passenger having any of their body parts caught in the moon roof.

Also, do not let a child operate moon roof with the wireless remote control or mechanical key. It is possible for children and other passengers to get caught in the moon roof.

- If a child is riding in the vehicle, when exiting the vehicle, turn the power switch off, carry the key and exit the vehicle along with the child. If a child is left in the vehicle, they may accidentally operate the moon roof, due to mischief, etc., possibly leading to an accident.

INFORMATION

Operating conditions of the moon roof

The power switch is in ON.

Operating the moon roof after turning the hybrid system off

The moon roof can be operated for approximately 45 seconds after the power switch is turned to ACC or OFF.

They cannot, however, be operated once either front door is opened.

Sunshade

The sunshade can be opened and closed manually. However, the sunshade will open automatically when the moon roof is opened.

— Related Links —

[Customizable features\(P. 765\)](#)

Functions which aid in safe opening and closing of the moon roof

The following functions aid in safe opening and closing of the moon roof.

● Jam protection function

If an object is detected between the moon roof and the frame while the moon roof is closing or tilting down, travel is stopped and the moon roof opens slightly.

● Moon roof open warning buzzer

The buzzer sounds and a message is shown on the multi-information display in the instrument cluster when the power switch is turned off and the driver's door is opened with the moon roof open.

▲ WARNING

■ Jam protection function

- Never use any part of your body to intentionally activate the jam protection function.
- The jam protection function may not operate if something gets caught just before the moon roof is fully closed.

Also, the jam protection function is not designed to operate while the moon roof switch is being pressed.

Take care so that your fingers, etc. do not get caught.

Opening the moon roof

Press the  switch.*¹

The moon roof stops slightly before the fully open position to reduce wind noise.

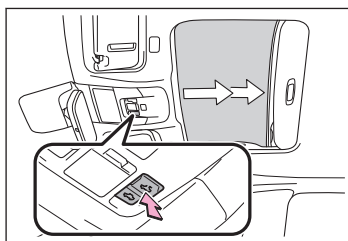

*¹: Lightly press either end of the moon roof  switch to stop the moon roof while it is operating.

Closing the moon roof

Press the ☁️ switch.*²

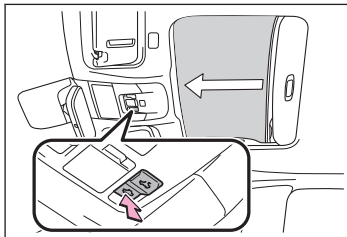

Tilting up the moon roof

Press the ☁️ switch.*³

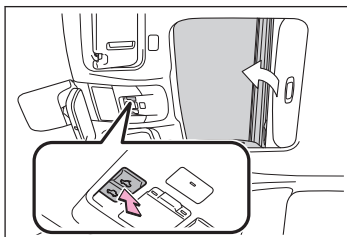

Tilting down the moon roof

Press the ☁️ switch.*⁴

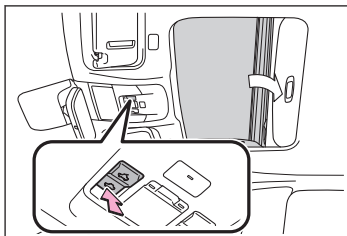

*²: Lightly press either end of the moon roof ☁️ switch to stop the moon roof while it is operating.

*³: Lightly press either end of the moon roof ☁️ switch to stop the moon roof while it is operating.

*⁴: Lightly press either end of the moon roof ☁️ switch to stop the moon roof while it is operating.

4-4. Illuminating the interior

Using the interior lights

Location of the interior lights

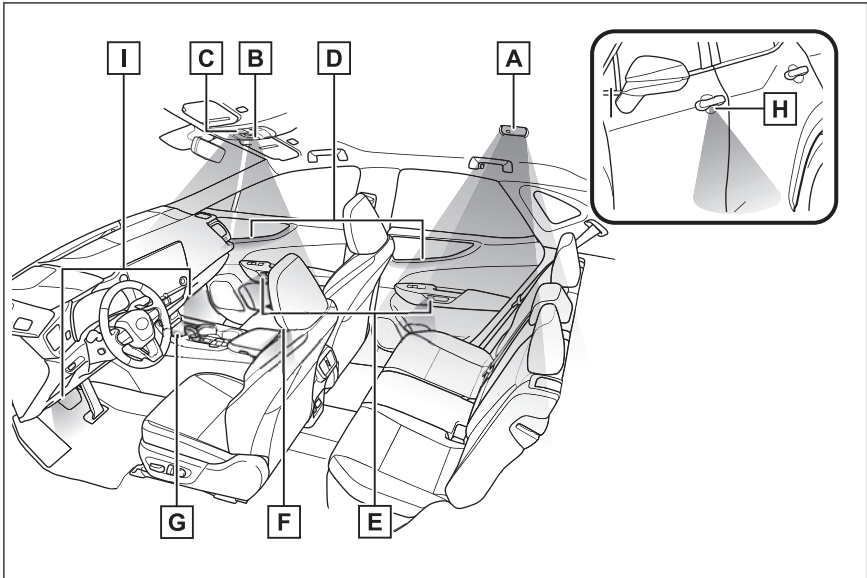

- A Rear interior light
- B Front interior light
- C Personal lights
- D Door trim ornament lights *
- E Inside door handle lights *¹
- F Door courtesy lights *
- G Center console light **¹
- H Outer foot lights
- I Footwell lights *¹

When the power switch is in ON, the door trim ornament lights, inside door handle lights, center console light, footwell lights will turn on. However, if the instrument panel light control switch is turned to minimum, the footwell lights will turn off.

*: If equipped

¹: The illumination color can also be changed.

 INFORMATION**■ Each lights automatic on/off**

- Illuminated entry system: The lights automatically turn on/off according to power switch mode, the presence of the electronic key, whether the doors are locked/unlocked, and whether the doors are opened/closed.
- If the interior lights remain on when the power switch is turned off, the lights will go off automatically after 20 minutes.

■ Automatic illumination of the interior lights

If any of the SRS airbags deploy (inflate) or in the event of a strong rear impact, the interior lights will turn on automatically. The interior lights will turn off automatically after approximately 20 minutes.

The interior lights can be turned off manually. However, in order to help prevent further collisions, it is recommended that they be left on until safety can be ensured. (The interior lights may not turn on automatically depending on the force of the impact and conditions of the collision.)

 NOTICE**■ Removing light lenses**

Never remove the lens for the front interior light and personal lights. Otherwise, the lights will be damaged. If the lens need to remove, contact your Lexus dealer.

■ To prevent 12-volt battery discharge

Do not leave the lights on longer than necessary when the hybrid system is off.

Related Links

[Customizable features\(P. 765\)](#)

Interior lights INFORMATION**■ The front interior lights may not operate normally when**

The front interior lights may not operate normally in the following situations:

- When water, dirt, etc., have adhered to the lens surface
- When operated with a wet hand
- When wearing gloves, etc.

Turning the interior lights on/off

Touch the light.

The front interior light will turn on/off each time it is touched.

The rear interior light will also turn on/off.

However, when the rear interior light has already been turned on, it will not be controlled by front interior light operations.

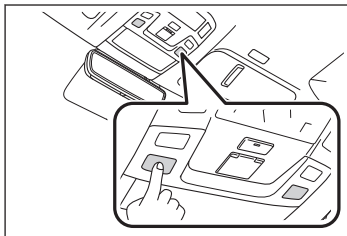

Linking the opening/closing of the doors to the front interior light operation

Press the ^{DOOR} switch.

The link between the front interior light operation and doors will change between ON/OFF each time the ^{DOOR} switch is pressed.

The operation of the rear interior lights will also be linked to the opening/closing of the doors.

When the door link is turned on, the indicator **A** will illuminate.

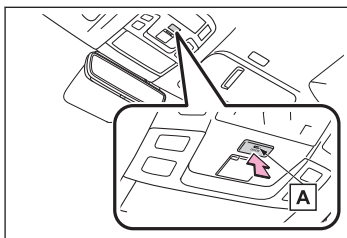

Turning the rear interior light on/off

Press the  switch.

The rear interior light will turn on/off each time the  switch is pressed.

Operation of the rear interior light is linked to the turning on/off of the front interior light.

When the rear interior light has been turned on by front interior light operation, the rear interior light cannot be turned off by pressing the switch.

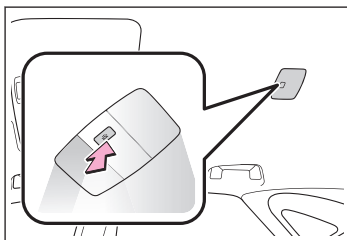

Personal lights

INFORMATION

The personal lights may not operate normally when

The personal lights may not operate normally in the following situations:

- When water, dirt, etc., have adhered to the lens surface
- When operated with a wet hand
- When wearing gloves, etc.

Using the personal lights

Touch the light.

The personal lights will turn on/off each time they are touched.

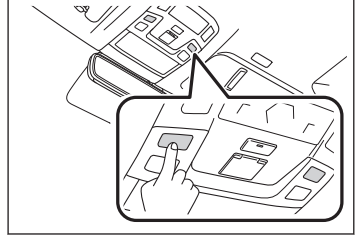

Location of the storage features

▲ WARNING

Do not leave eyeglasses, lighters or spray cans in the storage spaces, as the following may occur when cabin temperature becomes high:

- Eyeglasses may be deformed by heat or cracked if they come into contact with other stored items.
- Lighters or spray cans may explode. If they come into contact with other stored items, a lighter may catch fire or a spray can may release gas, causing a fire hazard.

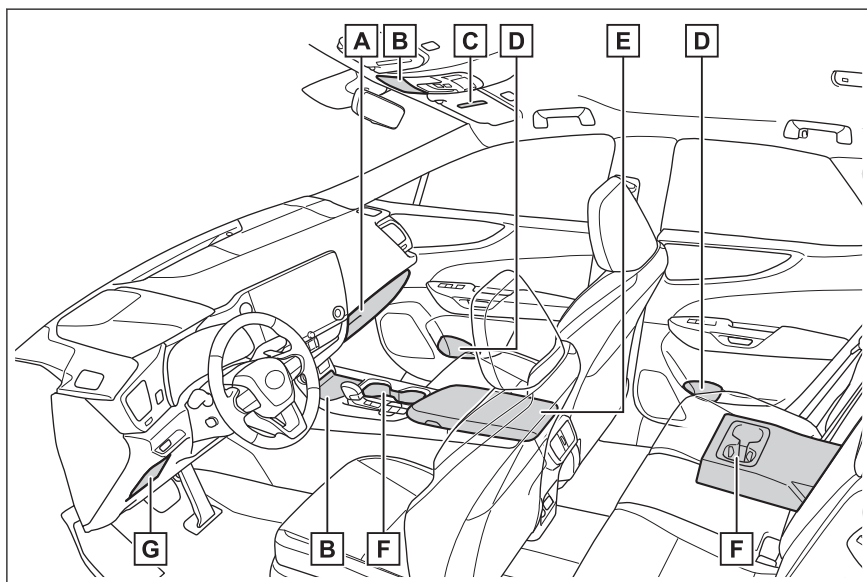

- A Glove box
- B Auxiliary boxes
- C Card holders
- D Bottle holders
- E Console box
- F Cup holders
- G Coin box

□ INFORMATION

■ Glove box light and console box light

The glove box light and the console box light turn on when the tail lights are on.

Using the auxiliary boxes

Press in the lid.

► Type A

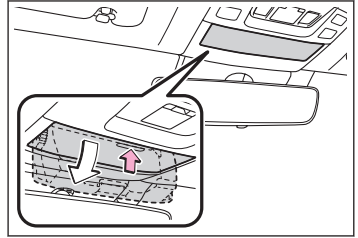

▲ WARNING

- Do not store items heavier than 0.44 lb. (200 g). Doing so may cause the auxiliary box to open and the items inside may fall out, resulting in an accident.
- When driving or when the auxiliary box is not in use, keep the lid closed. In the event of sudden braking or sudden swerving, an accident may occur due to an occupant being struck by the items stored inside.

Push the lid.

To close, press in and release the lid.

► Type B

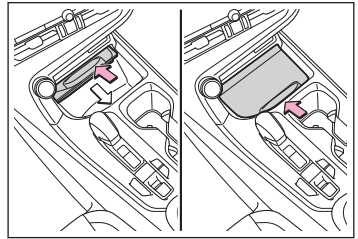

▲ WARNING

When driving or when the auxiliary box is not in use, keep the lid closed. In the event of sudden braking or sudden swerving, an accident may occur due to an occupant being struck by the items stored inside.

Location of the card holders

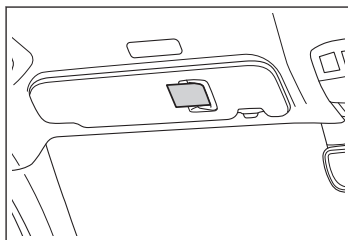

Using the glove box

⚠ WARNING

When driving or when the glove box is not in use, keep it closed.

If left open, in the event of sudden braking or swerving, the front passenger may strike the glove box lid or stowed items may fly out, possibly leading to an accident.

To open the glove box, pull the lever. The glove box can be locked and unlocked using the mechanical key.

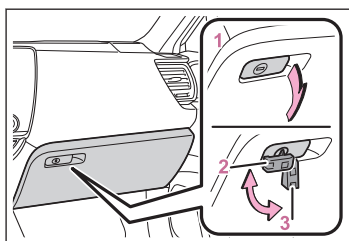

- 1 To open the glove box, pull the lever.
- 2 Lock with the mechanical key.
- 3 Unlock with the mechanical key.

□ INFORMATION

■ Glove box light

The glove box light turns on when the tail lights are on.

Use the cup holders

⚠ WARNING

Do not place anything other than cups or aluminum cans in the cup holders.

Other items may be thrown out of the holders in the event of an accident or sudden braking, causing injury.

If possible, cover hot drinks to prevent burns.

► Front

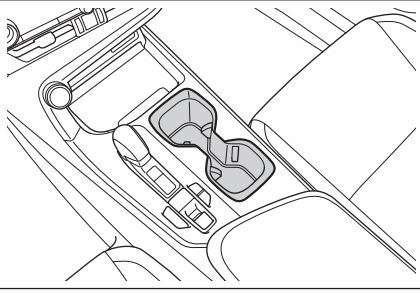

► Rear

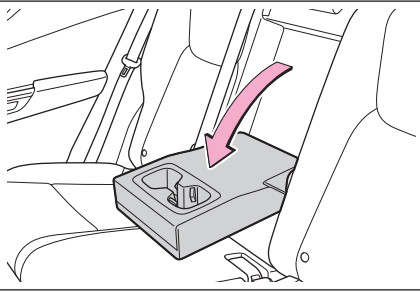

Pull down the armrest.

Locations of the bottle holders

⚠ NOTICE

When using a bottle holder, observe the following precautions.

- Do not place open bottles, glass cups, or paper cups containing liquid in the bottle holders.
The liquid may spill out and glass cups may break.
- When storing a bottle, close the cap.

► Front

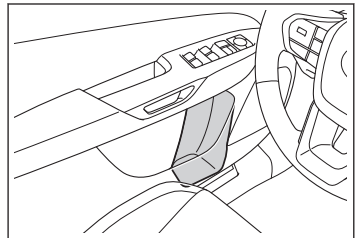

► Rear

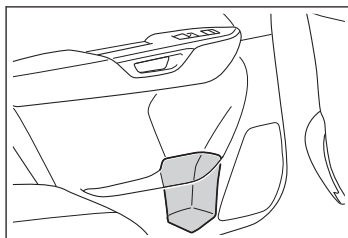

INFORMATION

■ Bottle holders

A bottle may not be able to be stored depending on its size or shape.

Using the console box

WARNING

When driving or when the console box is not in use, keep it closed.

If left open, in the event of sudden braking or swerving, an occupant may strike the console box lid or stowed items may fly out, possibly leading to an accident.

To open the console box, press the button and lift the lid.

The console box can be opened from either side.

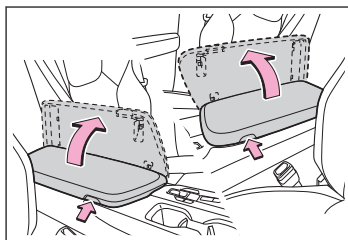

INFORMATION

■ Console box light

The console box light turns on when the tail lights are on.

Using the coin box

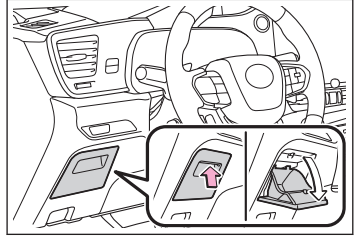

Push the knob up to open the lid.

▲ WARNING

When driving or when the coin box is not in use, keep it closed.





If left open, in the event of sudden braking or sudden swerving, the driver may strike the coin box lid or stowed items may fly out, possibly leading to an accident.

Convenient interior features



Function and operation of the USB charging port

NOTICE

To prevent damage to the USB charging ports

-  Do not insert foreign objects into the ports.
-  Do not spill water or other liquids into the ports.
-  Rear console: When the USB charging ports are not in use, close the lids. If a foreign object or liquid enters a port may cause a short circuit.
-  Do not apply excessive force to or impact the USB charging ports.
-  Do not disassemble or modify the USB charging ports.

To prevent damage to external devices

-  Do not leave external devices in the vehicle. The temperature inside the vehicle may become high, resulting in damage to an external device.
-  Do not push down on or apply unnecessary force to an external device or the cable of an external device while it is connected.

To prevent 12-volt battery discharge

Do not use the USB charging ports for a long period of time with the hybrid system stopped.

The USB charging ports are used to supply 3.0 A of electricity at 5 V to external devices.

The USB charging ports are for charging only. They are not designed for data transfer or other purposes.



Depending on the external device, it may not charge properly. Refer to the manual included with the device before using a USB charging port.

INFORMATION

The USB charging ports can be used when

The power switch is in ACC or ON.

Situations in which the USB charging ports may not operate correctly

-  If a device which consumes more than 3.0 A at 5 V is connected.
-  If a device designed to communicate with a personal computer, such as a USB memory device, is connected
-  If the connected external device is turned off (depending on device)

- If the temperature inside the vehicle is high, such as after the vehicle has been parked in the sun

■ About connected external devices

Depending on the connected external device, charging may occasionally be suspended and then start again. This is not a malfunction.

Use the USB charging port

► Instrument panel

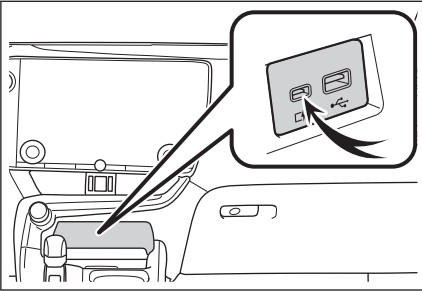

► On the rear console

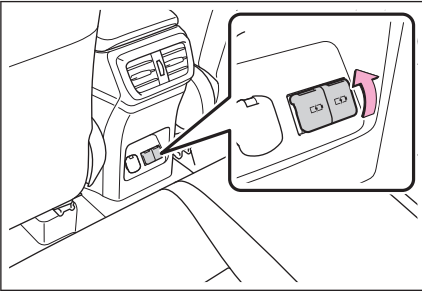

Open the lid.

Function and operation of the power outlet (12 VDC)

⚠ NOTICE

■ To prevent damage to the power outlet (12 VDC)

- Do not insert foreign objects into the ports.
- Do not spill water or other liquids into the ports.
- When the power outlets (12 VDC) are not in use, close the lids. If a foreign object or liquid enters a port may cause a short circuit.
- Do not apply excessive force to or impact the power outlets (12 VDC) ports.

NOTICE

To prevent 12-volt battery discharge

Do not use the power outlets (12 VDC) for a long period of time with the hybrid system stopped.

The power outlet can be used to supply power for devices which operate on 12 VDC at less than 10A (power consumption of 120 W).

When connecting multiple devices, make sure that the total power consumption of all the connected devices is less than 120 W.

INFORMATION

The power outlet can be used when

The power switch is in ACC or ON.

When stopping the hybrid system

Disconnect electrical devices with charging functions, such as mobile battery packs.

If such devices are left connected, the hybrid system may not stop normally.

Using the accessory sockets (12 VDC)

► Instrument panel

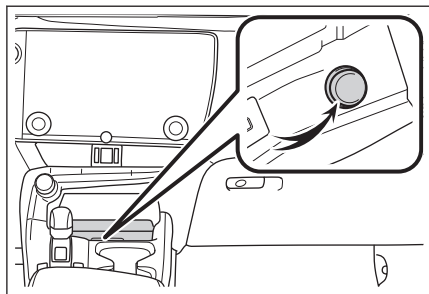

Remove the cap.

► On the rear console

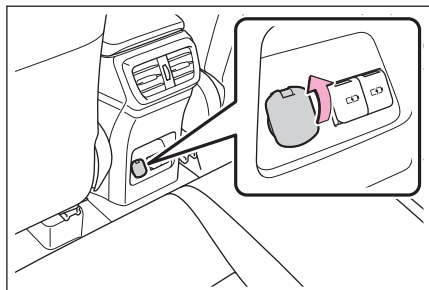

Open the lid.

► **In the luggage compartment**

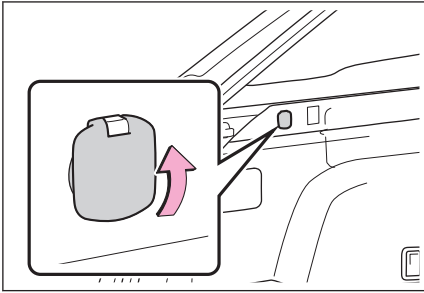

Open the lid.

Function and operation of the wireless charger

A portable device, such as a smartphone or mobile battery, can be charged by just placing it on the charging area, provided the device is compatible with the Qi wireless charging standard created by the Wireless Power Consortium.

▲ WARNING

■ Caution while driving

When charging a portable device while driving, for safety reasons, the driver should not operate the portable device.

■ Precautions for when driving

Do not charge small, lightweight portable devices, such as wireless earbuds, while driving. Lightweight devices may fly off of the charging tray, possibly leading to an accident.

■ Caution regarding interference with electronic devices

People with implantable cardiac pacemakers, cardiac resynchronization therapy pacemakers or implantable cardioverter defibrillators, as well as any other electrical medical device, should consult their physician about the usage of the wireless charger.

Operations of the wireless charger may have an affect on medical devices.

■ To prevent damage or burns

Observe the following precautions.

Failure to do so may result in the possibility of fire, equipment failure or damage, or burns due to heat.

- Do not put any metallic objects between the charging area and the portable device while charging.
- Do not attach metallic objects, such as aluminum stickers, to the charging area.

WARNING

- Do not charge portable devices with aluminum stickers or other metallic objects attached to the side which touches the charging area.
- Do not store items on the wireless charger instead of in an auxiliary box.
- Do not apply force or impact to the wireless charger.
- Do not disassemble, modify or remove the wireless charger.
- Do not attempt to charge portable devices which are not compatible with the Qi wireless charging standard.
- Do not allow magnetic objects to come near the wireless charge
- Do not perform charging if the charging area is dirty
- Do not cover the wireless charger with a cloth or other object while charging.

NOTICE

Preventing malfunction and corruption of data

- Do not bring magnetic cards, such as credit cards, or magnetic recording media, etc., close to the charger while charging, otherwise, data may be erased.

Additionally, do not bring precision instruments such as wrist watches, close to the wireless charger, as such objects may malfunction.

- Do not perform charging with a contactless smart card, such as a credit card, between the charging surface of a portable device and the charging area. The IC chip in the card may become extremely hot, possibly damaging the portable device or smart card. Failure to do so may result in the possibility of fire, equipment failure or damage, or burns due to heat.

Be extra careful to not charge a portable device with a case or cover which a contactless smart card can be inserted.

- Do not leave portable devices in the vehicle. The temperature inside the vehicle may become high, when in direct sunlight, possibly damaging the device.

To prevent 12-volt battery discharge

When the hybrid system is stopped, do not use the wireless charger for longer than necessary.

INFORMATION

The wireless charger can be operated when

The power switch is in ACC or ON.

■ About connected portable devices

- Portable devices compatible with the Qi wireless charging standard can be charged by the wireless charger. However, compatibility with all devices which meet the Qi wireless charging standard is not guaranteed.
- The wireless charger is designed to supply low power electricity (5 W or less) to a cellular phone, smartphone, or other portable device.
- Failure to do so may result in the possibility of fire. However, portable devices, such as the following, can be charged with more than 5 W.
 - 7.5 W charging compatible iPhones can be charged at 7.5 W or less.
 - Portable devices which conform to WPC Ver 1.2.4 (Extended Power profile) can be charged at 10 W or less.

■ Using the smart access system with push-button start

During charging, when the smart access system with push-button start searches for an electronic key, charging may be temporarily suspended.

■ If a cover or accessory is attached to the portable device

Do not charge a portable device if a cover or accessory which is not Qi compatible is attached.

Even if a device is “Qi” compatible, charging may not be possible if a cover or accessories are attached. (→ P.313)

■ Charging precautions

While charging, the wireless charger and the portable device will become warm. This is not a malfunction.

If a portable device becomes warm while charging and charging stops due to the protection function of the portable device, wait until the portable device cools down and charge it again.

Also, to decrease the temperature inside the wireless charger, a fan may operate. This does not indicate a malfunction.

■ Sound generated during operation

Operation sounds may be heard when the power switch is pressed to change to ACC or ON, or when a portable device is being detected. This does not indicate a malfunction.

■ “Qi” symbol

The “Qi” logo is a trademark of the Wireless Power Consortium.



Names of the parts of the wireless charger

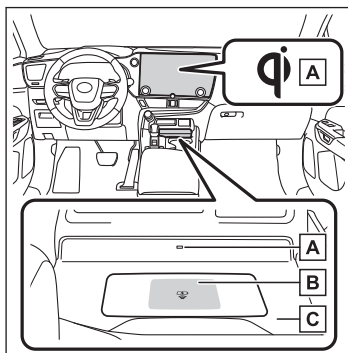

- A Operation indicator light
- B Charging area
- C Charging tray

Use the wireless charger

● Place a portable device on the charging tray.

Depending on the portable device, its charging coil may not be in the center of the device. In this case, place the portable device so that its charging coil is centered in the charging area.

While charging, the operation indicator light on the charging tray (orange) will be illuminated.

If charging does not begin, move the portable device as close to the center of the charging area as possible.

When charging is complete, the operation indicator light on the charging tray (green) will illuminate.

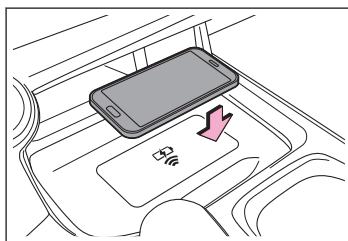

☐ INFORMATION

■ AM radio broadcast linked function during charging

- During charging, if noise occurs when listening to the AM radio, the charging frequency is automatically changed to reduce the noise.
- When automatically seeking AM radio stations, charging will be suspended to prevent charging noise from being detected as a radio station. Charging will resume automatically when seek tuning is stopped.

■ Recharging function

- If a certain amount of time has elapsed since charging completed and the portable device has not been moved, the wireless charger will restart charging.
- If a portable device is moved significantly within the charging area, the charging coil may disconnect and charging may temporarily be stopped. However, if a charging

coil is detected within the charging area, the charging coil inside the wireless charger will move near the other coil and charging will resume.

■ Rapid charging function

Portable devices, such as the following, can be rapidly charged.

- Rapid charging capable devices which conform to WPC Ver1.2.4 EPP (Extended Power profile)
- 7.5 W charging capable iPhones (iPhone 8 and later)

■ Situations in which the wireless charger may not operate correctly

In the following situations, the wireless charger may not operate correctly:

- When a portable device is fully charged
- When a portable device is being charged by a wired connection.
- When there is foreign matter between the charging area and portable device
- When the temperature of a portable device becomes high while charging
- When the temperature near the charging tray is 95 °F (35 °C) or more due to being in direct sunlight, etc.
- When a portable device is placed with its charging surface facing up
- When a portable device is not centered on the charging area
- When a portable device is larger than the charging tray
- When a foldable portable device is placed outside of the charging area
- When the vehicle is near a TV tower, electric power plant, fuel station, radio station, large display, airport, or other facility that generates strong radio waves or electrical noise
- When the any of the following objects are between or attached to a portable device and cause a gap of 0.08 in. (2 mm) or more between the charging surface of a portable device and the charging area:
 - Thick cases or covers
 - Thick decorations
 - Cases or covers which the charging surface is not flat, but is grooved or changes in thickness
 - Accessories, such as finger rings, straps, etc.
- When the portable device is in contact with, or is covered by any of the following metallic objects:
 - Cards covered with metal, such as aluminum foil
 - Cigarette boxes that have aluminum foil inside
 - Metallic wallets or bags

4-5. Using the interior features

- Coins
- Heat packs
- Recorded media such as CDs and DVDs
- Metallic decorations
- Metallic cases or covers
- When wireless keys (that emit radio waves) other than those of your vehicle are being used nearby
- When 2 or more portable devices are placed on the charging tray at the same time

In situations other than above, if the wireless charger does not operate properly or the operation indicator light blinks continuously, the wireless charger may be malfunctioning.

Contact your Lexus dealer.

Wireless charger operation indicator light status

The operation indicator light of the wireless charger indicates the operating state of the wireless charger as follows:

Operation indicator light		State
Charging tray	Center display	
Off	Off	The Wireless charger is off
Green (illuminated)	Gray	Standby (charging is possible) ⁽¹⁾
		Charging is complete ⁽²⁾
Orange (illuminated)	Blue	A portable device has been placed on the charging area (identifying the portable device)
		A portable device, such as the following, is being rapidly charged <ul style="list-style-type: none"> ● Rapid charging capable devices which conform to WPC Ver 1.2.4. ● 7.5 W charging capable iPhone (iPhone 8 and later)

(1) While in standby, charging power is not output. If a metal object is placed on the charging tray in this state, the object will not heat up.

(2) Depending on the portable device, the operation indicator light may stay illuminated (orange) after charging has completed.

Using the armrest

⚠ NOTICE

Do not apply excessive load to the armrest. Doing so may damage the armrest.

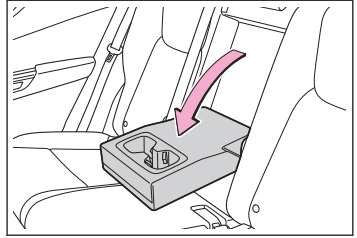

- Fold down the armrest for use.

Assist grip functions and operation

⚠ WARNING

Do not use the assist grip when getting in or out of the vehicle or rising from your seat.

⚠ NOTICE

Do not hang any heavy object or put a heavy load on the assist grip.

An assist grip installed on the ceiling can be used to support your body while sitting on the seat.

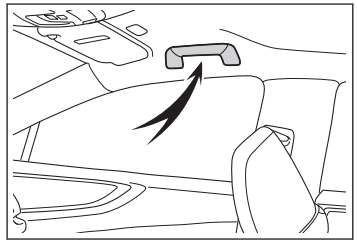

Locations of coat hooks

⚠ WARNING

Do not hang coat hangers or other hard or sharp objects on the hook. If the SRS curtain shield airbags deploy, these items may become projectiles, causing death or serious injury.

4-5. Using the interior features

The coat hooks are provided with the rear assist grips.

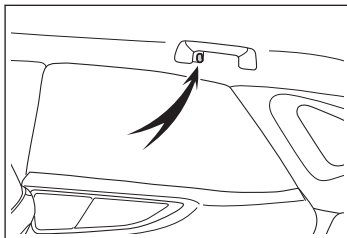

Using the vanity mirrors

● Slide the cover to open.

The vanity light turns on when the cover is opened.

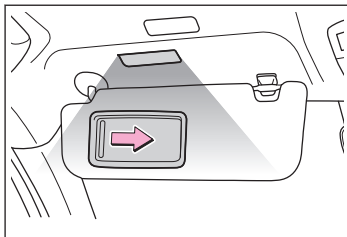

⚠ NOTICE

Do not leave the vanity lights on longer than necessary with the hybrid system stopped. Doing so may lead to the 12-volt battery becoming discharged.

📄 INFORMATION

■ Automatic light off function

When the power switch is off, if the vanity lights are turned on, they will be turned off automatically after 20 minutes.

Using the cargo hooks

The cargo hooks are provided for securing loose items.

- Raise the hook to use.

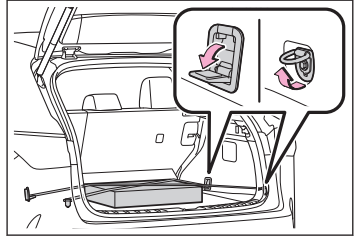

⚠ WARNING

To avoid injury, when the cargo hooks are not in use, make sure to return them to their stowed position.

Using the cargo net hooks

The cargo net can be hung using the cargo net hooks.

- Raise the hook to use.

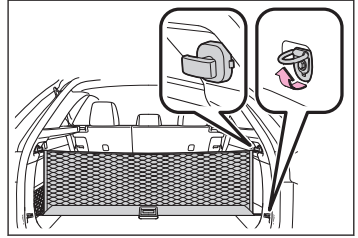

⚠ WARNING

To avoid injury, when the cargo net hooks are not in use, make sure to return them to their stowed position.

Using the grocery bag hooks

- Push the grocery back hook to use.

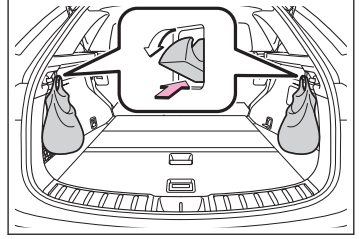

NOTICE

Do not hang objects heavier than 8.8 lb. (4 kg) on the grocery bag hooks.
Doing so may damage the grocery bag hook.

4-6. Using the luggage compartment

Deck board

Opening the deck board

⚠ WARNING

If a deck board has been opened or removed, return it to its original position before driving. Otherwise, in the event of sudden braking or an accident, a deck board or stored items may fly out and strike an occupant.

1 Open the back door.

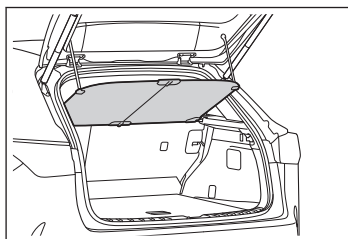

2 Open the deck board.

► Pattern A

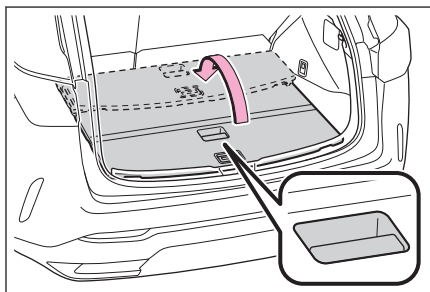

► Pattern B

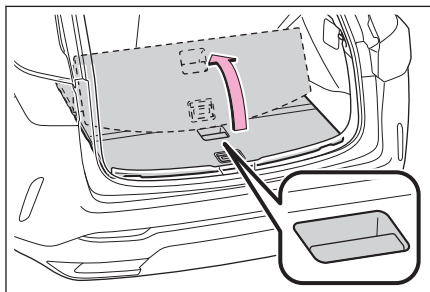

▶ Pattern C

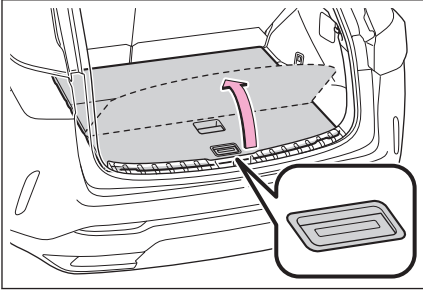

Storing items in the deck under tray

The following items can be stowed.

- Accessories

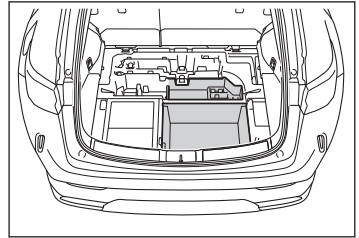

- Warning reflector*1

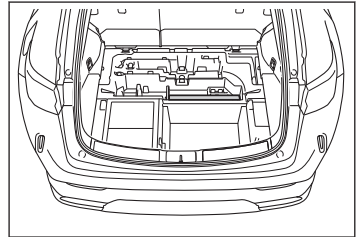

*1: A warning reflector itself is not included as an original equipment.

Stowing the luggage cover

1 Unhook each cord.

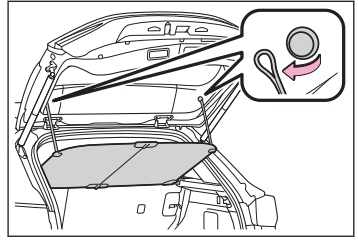

2 Pull the lever upwards and fold the deck board.

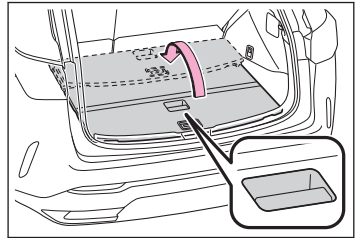

3 Remove the luggage cover.

If a rear seat seatback is reclined, remove the luggage cover after moving the seatback to the upright position.

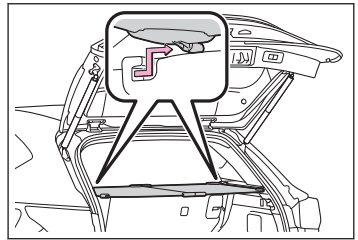

4 Fold the luggage cover

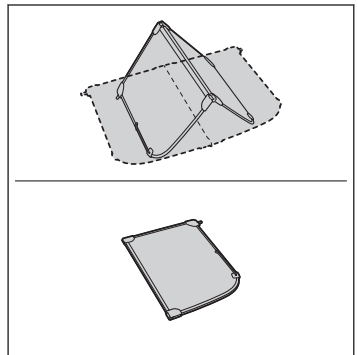

- 5 Lift the deck board and stow the luggage cover in the deck under tray.

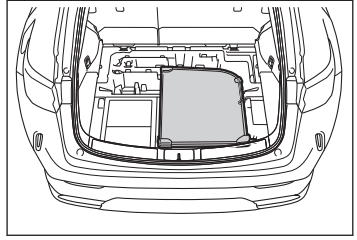

⚠ WARNING

- Do not stow items on the luggage cover. In the event of sudden braking or swerving, the items may fly about and strike an occupant.
- Do not allow children to climb on the luggage cover. Doing so may damage the luggage cover.

5-1. Functions and displays of the meter

- Warning lights and indicators.....**326**
- Gauges and meters (except F SPORT models).....**333**
- Gauges and meters (F SPORT models).....**340**

5-2. Functions of the displays

- Multi-information display (vehicles without a head-up display)**345**
- Multi-information display (vehicles with a head-up display).....**347**
- Head-up display.....**349**
- Displayed content**352**

5-3. Changing the settings of the displays

- Changing the instrument panel light brightness.....**365**
- Changing settings for the head-up display.....**366**

Warning lights and indicators

The warning lights and indicators on the instrument cluster and outside rear view mirrors inform the driver of the status of the vehicle's various systems.

For the purpose of explanation, the following illustrations display all warning lights and indicators illuminated.

► Vehicles without a head-up display

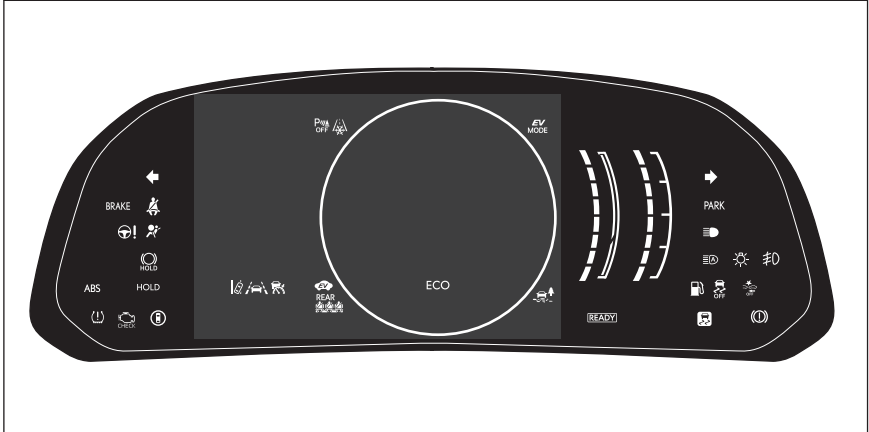











► Vehicles with a head-up display















List of warning lights



Warning lights inform the driver of malfunctions in the indicated vehicle's systems.

<p>BRAKE</p> <p>(U.S.A.)</p>  <p>(Canada)</p> <p>(red)</p>	Brake system warning light ⁽¹⁾
 <p>(yellow)</p>	Brake system warning light ⁽¹⁾
	High coolant temperature warning light ⁽²⁾
	Hybrid system overheat warning light ⁽²⁾
	Charging system warning light ⁽²⁾
	Low engine oil pressure warning light ⁽²⁾
 <p>(U.S.A.)</p>  <p>(Canada)</p>	Malfunction indicator lamp ⁽¹⁾
	SRS warning light ⁽¹⁾
<p>ABS</p> <p>(U.S.A.)</p>  <p>(Canada)</p>	ABS warning light ⁽¹⁾
	Inappropriate pedal operation warning light ⁽²⁾

5.1. Functions and displays of the meter

 (red)	Electric power steering system warning light ⁽¹⁾
 (yellow)	Electric power steering system warning light ⁽¹⁾
	Low fuel level warning light
	Driver's and front passenger's seat belt reminder light
	Rear passengers' seat belt reminder light (vehicles without a head-up display)
	Rear passengers' seat belt reminder light (vehicles with a head-up display)
	Tire pressure warning light ⁽¹⁾
 (orange)	LDA indicator
 (orange)	LTA indicator
	Intuitive parking assist OFF indicator ^{*(1)}
 (orange)	Cruise control indicator
 (orange)	Dynamic radar cruise control indicator
	Driving assist information indicator ⁽¹⁾

*: If equipped

	PCS warning light ⁽¹⁾
	Slip indicator ⁽¹⁾
PARK (U.S.A.) (flashes)  (Canada) (flashes)	Parking brake indicator
HOLD (flashes)	Brake hold operated indicator ⁽¹⁾

(1) These lights come on when the power switch is turned to ON to indicate that a system check is being performed. They will turn off after the hybrid system is on, or after a few seconds. There may be a malfunction in a system if the lights do not come on, or turn off. Have the vehicle inspected by your Lexus dealer.

(2) This light illuminates on the multi-information display.

WARNING

Should a safety system light such as the ABS and SRS warning light not come on when you start the hybrid system, this could mean that these systems are not available to help protect you in an accident, which could result in death or serious injury. Have the vehicle inspected by your Lexus dealer immediately if this occurs.

Related Links













If a warning light turns on/flashes(P. 638)

List of indicators

















The indicators inform the driver of the operating state of the vehicle's various systems.

	Turn signal indicator
--	-----------------------





5-1. Functions and displays of the meter

 (U.S.A.)	Headlight indicator
 (Canada)	Tail light indicator
	Headlight high beam indicator
	AHS indicator ^{*(1)} AHB indicator ^{*(1)}
	Front fog light indicator
	PCS warning light ⁽¹⁾⁽³⁾
 (green/white)	Cruise control indicator
 (green/white)	Dynamic radar cruise control indicator
 (green/white)	LDA indicator
 (green/white)	LTA indicator
	BSM outside rear view mirror indicators ⁽²⁾
	Intuitive parking assist OFF indicator ^{*(1)(3)}
	Driving assist information indicator ⁽¹⁾⁽³⁾

*: If equipped

 (flashes)	Slip indicator ⁽¹⁾
	VSC OFF indicator ⁽¹⁾⁽³⁾
	"READY" indicator
 (U.S.A.)  (Canada)	Parking brake indicator
	Brake hold standby indicator ⁽¹⁾
	Brake hold operated indicator ⁽¹⁾
	EV indicator
	Low outside temperature indicator ⁽⁴⁾
	[AIR BAG ON/OFF] indicator ⁽⁵⁾
	AUTO EV/HV mode indicator
	EV drive mode indicator
	HV drive mode indicator
	Hybrid battery charge mode indicator
	Eco drive mode indicator
	Sport mode indicator ⁽⁶⁾

5-1. Functions and displays of the meter

	Sport S mode indicator ⁽⁷⁾
	Sport S+ mode indicator ⁽⁷⁾
	Custom mode indicator ⁽⁷⁾
	Trail Mode indicator

- (1) These lights come on when the power switch is turned to ON to indicate that a system check is being performed. They will turn off after the hybrid system is on, or after a few seconds. There may be a malfunction in a system if the lights do not come on, or turn off. Have the vehicle inspected by your Lexus dealer.
- (2) This light illuminates on the outside rear view mirrors.
- (3) This light comes on when the system is turned off.
- (4) When the outside temperature is approximately 37°F (3°C) or lower, this indicator will flash for approximately 10 seconds, then stay on.
- (5) This light illuminates on the front interior/personal lights.
- (6) Except F SPORT models
- (7) F SPORT models

Related Links

[Customizable features\(P. 765\)](#)

Gauges and meters (except F SPORT models)

► Vehicles without a head-up display

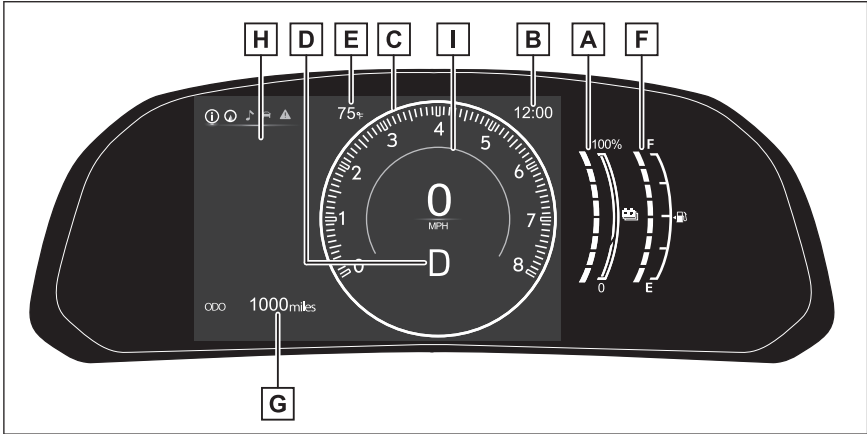
**A** SOC (State of Charge) gauge

Displays the amount of charge remaining in the traction battery.

When the gauge is in the green zone, EV driving is possible. When the gauge is in the blue zone, EV driving is no longer possible (in this situation, the vehicle switches to HV mode). Charge the hybrid battery (traction battery) to allow EV driving.

B Clock

Automatically adjusts the time by using the GPS time information (GPS clock). For details, refer to "MULTIMEDIA OWNER'S MANUAL".

C Tachometer

Displays the engine speed in revolutions per minute

Hybrid System Indicator

Displays hybrid system output or regeneration level.

Speedometer

Depending on the selected drive mode or certain settings, the display will change.

D Shift position/shift range**E** Outside temperature

Displays the ambient temperature within the range of -40°F (-40°C) to 140°F (60°C).

F Fuel gauge

Displays the quantity of fuel remaining in the tank.

G Odometer and trip meter display**H** Multi-information display

5.1. Functions and displays of the meter

Presents the driver with a variety of vehicle data and displays warning messages if a malfunction occurs .

I Background color of driving mode

Background color changes according to the driving mode.

► Vehicles with a head-up display

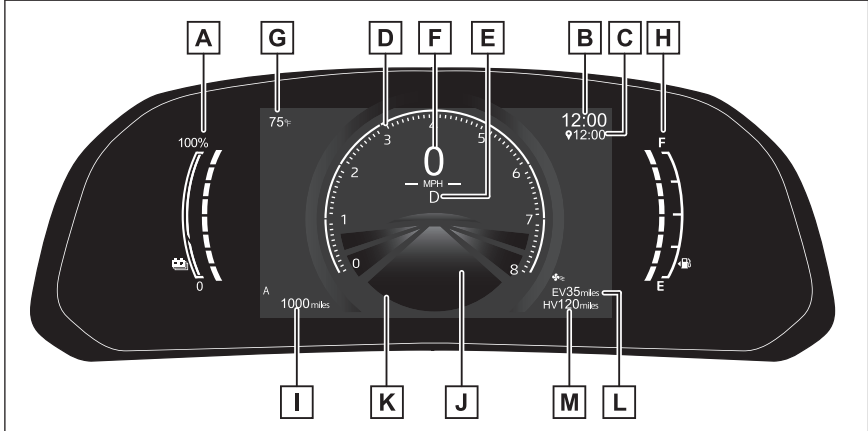

A SOC (State of Charge) gauge

Displays the amount of charge remaining in the traction battery.

When the gauge is in the green zone, EV driving is possible. When the gauge is in the blue zone, EV driving is no longer possible (in this situation, the vehicle switches to HV mode). Charge the hybrid battery (traction battery) to allow EV driving.

B Clock

Automatically adjusts the time by using the GPS time information (GPS clock). For details, refer to "MULTIMEDIA OWNER'S MANUAL".

C Navigation system estimated time of arrival display

Displays the estimated time of arrival according to the navigation system.

D Tachometer

Displays the engine speed in revolutions per minute

Hybrid System Indicator

Displays hybrid system output or regeneration level.

Analog speedometer

Depending on the selected drive mode or certain settings, the display will change.

E Shift position/shift range

F Digital speedometer

G Outside temperature

Displays the ambient temperature within the range of -40°F (-40°C) to 140°F (60°C).

H Fuel gauge

Displays the quantity of fuel remaining in the tank.

I Odometer and trip meter display

J Multi-information display

Presents the driver with a variety of vehicle data and displays warning messages if a malfunction occurs.

K Background color of driving mode

Background color changes according to the driving mode.

L EV driving range

Displays the EV driving range with charge remaining in the hybrid battery (traction battery).

M Distance to empty

Displays the driving range with remaining fuel.

 **INFORMATION**

■ The meters and display illuminate when

The power switch is in ON.

■ Engine speed

On hybrid electric vehicles, engine speed is precisely controlled in order to help improve fuel efficiency and reduce exhaust emissions etc.

There are times when the engine speed that is displayed may differ even when vehicle operation and driving conditions are the same.

■ Outside temperature display

● In the following situations, the correct outside temperature may not be displayed, or the display may take longer than normal to change:

- When stopped, or driving at low speeds (less than 16 mph [25 km/h])
- When the outside temperature has changed suddenly (at the entrance/exit of a garage, tunnel, etc.)

● When "--" or "E" is displayed, the system may be malfunctioning.

Take your vehicle to your Lexus dealer.

■ EV driving range*

● When the air conditioning system is operating,  is displayed next to the EV driving range and the EV driving range with the air conditioning system on is displayed.

5.1. Functions and displays of the meter

- The EV driving range may shorten even when not driving due to power consumption by the system.

■ Distance to empty *

- This distance is computed based on your average fuel consumption. As a result, the actual distance that can be driven may differ from that displayed.
- When only a small amount of fuel is added to the tank, the display may not be updated. When refueling, turn the power switch off. If the vehicle is refueled without turning the power switch off, the display may not be updated.

■ Liquid crystal display

Small spots or light spots may appear on the display.

This phenomenon is characteristic of liquid crystal displays, and there is no problem continuing to use the display.

■ Free/Open Source Software Information

This product contains Free/Open Source Software (FOSS). The license information and/or the source code of such FOSS can be found at the following URL.

<https://www.denso.com/global/en/opensource/meter/toyota/>

▲ WARNING

Allow the interior of the vehicle to warm up before using the liquid crystal information display. At extremely low temperatures, the information display monitor may respond slowly, and display changes may be delayed.

For example, there is a lag between the driver's shifting and the new gear number appearing on the display. This lag could cause the driver to downshift again, causing rapid and excessive engine braking and possibly an accident resulting in death or injury.

▲ NOTICE

To prevent the engine or components from being damaged, observe the following precautions.

- Do not let the indicator needle of the tachometer enter the red zone, which indicates the maximum engine speed.
- The engine may be overheating if "Engine Coolant Temp High Stop in a Safe Place See Owner's Manual" is shown on the multi-information display. In this case, immediately stop the vehicle in a safe place, and check the engine after it has cooled completely.

— Related Links —

[Customizable features\(P. 765\)](#)

*: If equipped

Hybrid system indicator

The hybrid system indicator displays the hybrid system output or regeneration level.

The displayed content of the hybrid system indicator are different in EV mode or AUTO EV/HV mode and HV mode.

This illustration is for explanation only and may differ depending on the specifications of the vehicle.

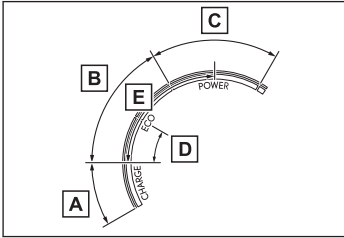

A Charge area

Shows regeneration status.

Regenerated energy will be used to charge the hybrid battery (traction battery).

When used in this manual, "regeneration" refers to the conversion of energy created by the movement of the vehicle into electrical energy.

B Eco area

Shows that the vehicle is being driven in an Eco-friendly manner.

By keeping the indicator needle within Eco area, more Eco-friendly driving can be achieved.

C Power area

Shows that an Eco-friendly driving range is being exceeded (during full power driving etc.)

D Hybrid Eco area (HV mode)

Shows that gasoline engine power is not being used very often.

The gasoline engine will automatically stop and restart under various conditions.

E EV driving area (EV mode or AUTO EV/HV mode)

Shows that the vehicle is driven using only the electric motor (traction motor).

Changing between the tachometer/hybrid system indicator/speedometer displays

Depending on the current drive mode or settings, the displays will change as follows. Settings can be changed on the center display.

■ Vehicles without a head-up display

● Tachometer

The tachometer will be displayed in the following situations when the meter display type setting is set to display type 1 or display type 3.

- When the tachometer setting is set to always display the tachometer
- When the tachometer setting is set to change according to the driving mode and sport mode is selected

● Hybrid System Indicator

The hybrid system indicator will be displayed in the following situations when the meter display type setting is set to display type 1 or display type 3.

- When the tachometer setting is set to always display the hybrid system indicator
- When the tachometer setting is set to change according to the driving mode and a driving mode other than sport mode is selected

● Speedometer

Always displayed.

The display will change between a digital speedometer and/or analog speedometer depending on the meter display type setting.

■ Vehicles with a head-up display

● Tachometer

Displayed when the meter display type setting is set to display type 1.

F SPORT models: Also displayed in the following situations when the setting is set to display type 3.

- When the tachometer setting is set to always display the tachometer
- When the tachometer setting is set to change according to the driving mode and sport mode is selected

● Hybrid System Indicator

Displayed when the meter display type setting is set to display type 1.

F SPORT models: Also displayed in the following situations when the setting is set to display type 3.

- When the tachometer setting is set to always display the hybrid system indicator
- When the tachometer setting is set to change according to the driving mode and a driving mode other than sport mode is selected

● Speedometer

A digital speedometer is always displayed.

When the meter display type setting is set to display type 2, an analog speedometer will also be displayed.

Related Links

[Customizable features\(P. 765\)](#)

Changing the distance driven display/resetting the distance driven

The display can be changed between the following items.

- Odometer

Displays the total distance the vehicle has been driven.

- Trip meter A/trip meter B

Displays the distance the vehicle has been driven since the meter was last reset. Trip meters A and B can be used to record and display different distances independently.

- Distance until next engine oil change

Displays the distance the vehicle can be driven until an oil change is necessary.

Each time the switch is pressed, the displayed item will be changed.

When the trip meter is displayed, pressing and holding the switch will reset the trip meter.

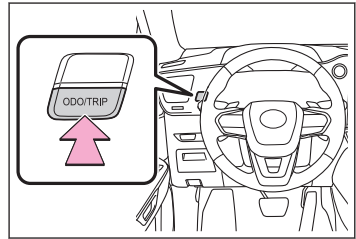

Gauges and meters (F SPORT models)

Depending on the shift position or current drive mode, the meter displays or position of some gauges will change.

► Ring display state

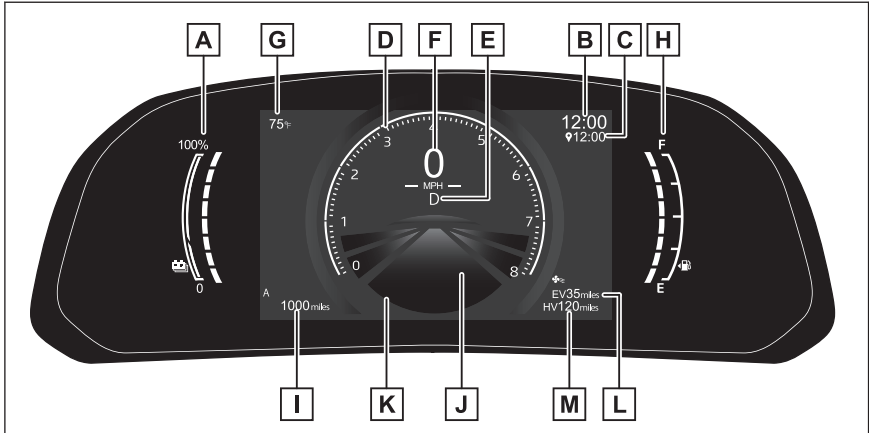

A SOC (State of Charge) gauge

Displays the amount of charge remaining in the traction battery.

When the gauge is in the green zone, EV driving is possible. When the gauge is in the blue zone, EV driving is no longer possible (in this situation, the vehicle switches to HV mode). Charge the hybrid battery (traction battery) to allow EV driving.

B Clock

Automatically adjusts the time by using the GPS time information (GPS clock). For details, refer to "MULTIMEDIA OWNER'S MANUAL".

C Navigation system estimated time of arrival display

Displays the estimated time of arrival according to the navigation system.

D Tachometer

Displays the engine speed in revolutions per minute

- Rev indicator
- Rev peak

Hybrid System Indicator

Displays hybrid system output or regeneration level.

Analog speedometer

Depending on the selected drive mode or certain settings, the display will change.

E Shift position/shift range

F Digital speedometer

G Outside temperature

Displays the ambient temperature within the range of -40°F (-40°C) to 140°F (60°C).

H Fuel gauge

Displays the quantity of fuel remaining in the tank.

I Odometer and trip meter display**J** Multi-information display

Presents the driver with a variety of vehicle data and displays warning messages if a malfunction occurs.

K Background color of driving mode

Background color changes according to the driving mode.

L EV driving range

Displays the EV driving range with charge remaining in the hybrid battery (traction battery).

M Distance to empty

Displays the driving range with remaining fuel.

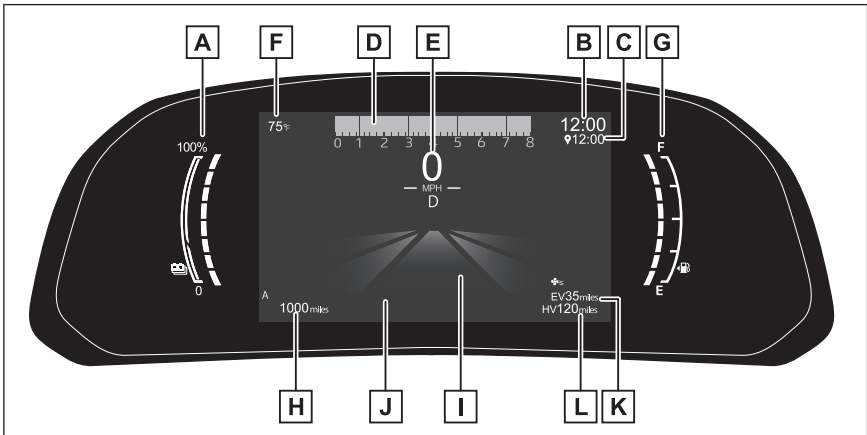
► **Bar display state****A** SOC (State of Charge) gauge

Displays the amount of charge remaining in the traction battery.

When the gauge is in the green zone, EV driving is possible. When the gauge is in the blue zone, EV driving is no longer possible (in this situation, the vehicle switches to HV mode). Charge the hybrid battery (traction battery) to allow EV driving.

B Clock

Automatically adjusts the time by using the GPS time information (GPS clock). For details, refer to "MULTIMEDIA OWNER'S MANUAL".

5.1. Functions and displays of the meter

- C** Navigation system estimated time of arrival display
Displays the estimated time of arrival according to the navigation system.
- D** Tachometer
Displays the engine speed in revolutions per minute
- Rev indicator
 - Rev peak
- Hybrid System Indicator
Displays hybrid system output or regeneration level.
Depending on the selected drive mode or certain settings, the display will change.
- E** Shift position/shift range/digital speedometer
- F** Outside temperature
Displays the outside temperature within the range of -40°F (-40°C) to 140°F (60°C).
- G** Fuel gauge
Displays the quantity of fuel remaining in the tank.
- H** Odometer and trip meter display
- I** Multi-information display
Presents the driver with a variety of vehicle data and displays warning messages if a malfunction occurs .
- J** Background color of driving mode
Background color changes according to the driving mode.
- K** EV driving range
Displays the EV driving range with charge remaining in the hybrid battery (traction battery).
- L** Distance to empty
Displays the driving range with remaining fuel.

INFORMATION

■ The meters and display illuminate when

The power switch is in ON.

■ Engine speed

On hybrid electric vehicles, engine speed is precisely controlled in order to help improve fuel efficiency and reduce exhaust emissions etc.

There are times when the engine speed that is displayed may differ even when vehicle operation and driving conditions are the same.

■ Outside temperature display

- In the following situations, the correct outside temperature may not be displayed, or the display may take longer than normal to change:
 - When stopped, or driving at low speeds (less than 16 mph [25 km/h])
 - When the outside temperature has changed suddenly (at the entrance/exit of a garage, tunnel, etc.)
- When "--" or "E" is displayed, the system may be malfunctioning.

Take your vehicle to your Lexus dealer.

■ EV driving range

- When the air conditioning system is operating,  is displayed next to the EV driving range and the EV driving range with the air conditioning system on is displayed.
- The EV driving range may shorten even when not driving due to power consumption by the system.

■ Distance to empty

- This distance is computed based on your average fuel consumption. As a result, the actual distance that can be driven may differ from that displayed.
- When only a small amount of fuel is added to the tank, the display may not be updated. When refueling, turn the power switch off. If the vehicle is refueled without turning the power switch off, the display may not be updated.

■ Liquid crystal display

Small spots or light spots may appear on the display.

This phenomenon is characteristic of liquid crystal displays, and there is no problem continuing to use the display.

■ Free/Open Source Software Information

This product contains Free/Open Source Software (FOSS). The license information and/or the source code of such FOSS can be found at the following URL.

<https://www.denso.com/global/en/opensource/meter/toyota/>

▲ WARNING

Allow the interior of the vehicle to warm up before using the liquid crystal information display. At extremely low temperatures, the information display monitor may respond slowly, and display changes may be delayed.

For example, there is a lag between the driver's shifting and the new gear number appearing on the display. This lag could cause the driver to downshift again, causing rapid and excessive engine braking and possibly an accident resulting in death or injury.

NOTICE

To prevent the engine or components from being damaged, observe the following precautions.

- Do not let the indicator needle of the tachometer enter the red zone, which indicates the maximum engine speed.
- The engine may be overheating if **"Engine Coolant Temp High Stop in a Safe Place See Owner's Manual"** is shown on the multi-information display. In this case, immediately stop the vehicle in a safe place, and check the engine after it has cooled completely.

Related Links

[Hybrid system indicator\(P. 337\)](#)

[Changing between the tachometer/hybrid system indicator/speedometer displays\(P. 337\)](#)

[Changing the distance driven display/resetting the distance driven\(P. 339\)](#)

[Customizable features\(P. 765\)](#)

Rev indicator/Rev peak display

■ Rev indicator

When the engine speed reaches a set speed or the red zone, the tachometer will be highlighted.

The indicators will be displayed in amber when the engine speed reaches a set speed, and in red when the engine speed reaches the red zone.

The engine speed at which the Rev indicator is displayed can be changed on the center display.

■ Rev peak

When the engine speed reaches or exceeds 4000 rpm, an afterimage of the tachometer will be displayed at the highest engine speed for approximately 1 second.

Related Links

[Customizable features\(P. 765\)](#)

Multi-information display (vehicles without a head-up display)

A variety of driving-related information can be displayed. Depending on the situation, warning or advice pop-up displays will also be displayed.

■ Display area

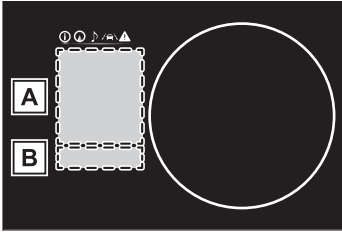

A Content display area

B Driving support system information display area

When a menu icon other than  is selected, if the driving support system operates, the system operating state will be displayed.

■ Items displayed in the content display area

By selecting menu icons on the multi-information display, the following items can be displayed.



Driving information display



Navigation system-linked display



Audio system-linked display



Driving support system information display



Warning message



INFORMATION

■ Liquid crystal display

Small spots or light spots may appear on the display. This phenomenon is characteristic of liquid crystal displays, and there is no problem continuing to use the display.

WARNING

Caution for use while driving

-  When operating the multi-information display while driving, pay extra attention to the safety of the area around the vehicle.
-  Do not look continuously at the multi-information display while driving as you may fail to see pedestrians, objects on the road, etc. ahead of the vehicle.

The information display at low temperatures

Allow the interior of the vehicle to warm up before using the liquid crystal information display. At extremely low temperatures, the information display monitor may respond slowly, and display changes may be delayed.

For example, there is a lag between the driver's shifting and the new gear number appearing on the display. This lag could cause the driver to downshift again, causing rapid and excessive engine braking and possibly an accident resulting in death or injury.

Cautions during setting up the display

As the hybrid system needs to be operating during setting up the display, ensure that the vehicle is parked in a place with adequate ventilation. In a closed area such as a garage, exhaust gases including harmful carbon monoxide (CO) may collect and enter the vehicle. This may lead to death or a serious health hazard.

NOTICE

To prevent 12-volt battery discharge, ensure that the hybrid system is operating while setting up the display features.

Related Links

[Displayed content\(P. 352\)](#)

[Changing the instrument panel light brightness\(P. 365\)](#)

Multi-information display (vehicles with a head-up display)

A variety of driving-related information can be displayed. Depending on the situation, warning or advice pop-up displays will also be displayed.

■ Display area

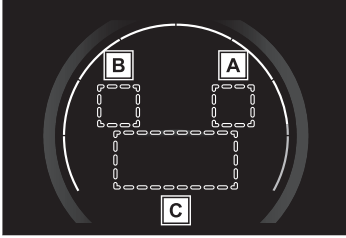

A Driving support system information display area

When driving support system information is not displayed in the content display area, if the driving support system operates, the system operating state will be displayed.

B Navigation system-linked display area

If the navigation system linked-display is not displayed in the content display area, route guidance will be displayed.

C Content display area

■ Items displayed in the content display area

The following items can be displayed.

- Drive information 1
- Drive information 2
- Energy monitor/EV driving ratio
- Audio system-linked display
- Navigation system-linked display*¹
- G-force
- Driving support system information display*¹
- Blank (No items)

INFORMATION



■ Liquid crystal display

Small spots or light spots may appear on the display. This phenomenon is characteristic of liquid crystal displays, and there is no problem continuing to use the display.

*1: Displayed on the head-up display when the display mode is set to display the maximum.

WARNING

Caution for use while driving

-  When operating the multi-information display while driving, pay extra attention to the safety of the area around the vehicle.
-  Do not look continuously at the multi-information display while driving as you may fail to see pedestrians, objects on the road, etc. ahead of the vehicle.

The information display at low temperatures

Allow the interior of the vehicle to warm up before using the liquid crystal information display. At extremely low temperatures, the information display monitor may respond slowly, and display changes may be delayed.

For example, there is a lag between the driver's shifting and the new gear number appearing on the display. This lag could cause the driver to downshift again, causing rapid and excessive engine braking and possibly an accident resulting in death or injury.

Cautions during setting up the display

As the hybrid system needs to be operating during setting up the display, ensure that the vehicle is parked in a place with adequate ventilation. In a closed area such as a garage, exhaust gases including harmful carbon monoxide (CO) may collect and enter the vehicle. This may lead to death or a serious health hazard.

NOTICE

To prevent 12-volt battery discharge, ensure that the hybrid system is operating while setting up the display features.

Related Links

[Displayed content\(P. 352\)](#)

[Changing the instrument panel light brightness\(P. 365\)](#)

Head-up display*

The head-up display projects a variety of driving-related information and the operating state of the driving support systems on the windshield.

The content displayed will differ according to the driving conditions and display mode of the head-up display. Depending on the situation, pop-up displays will also be displayed.

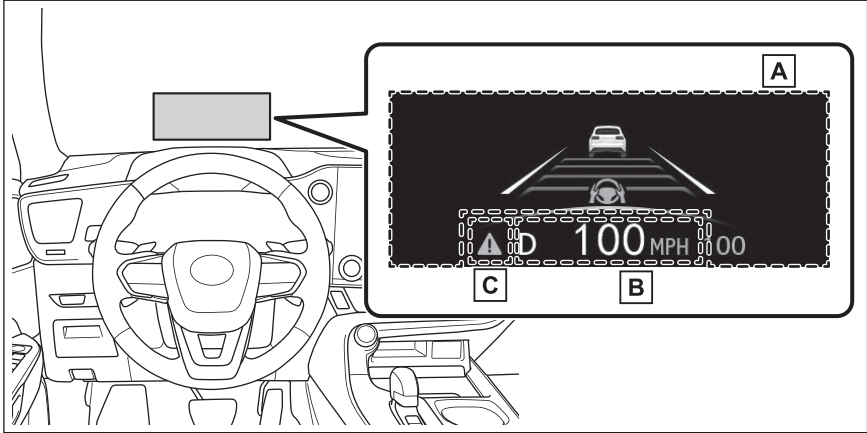

A Main display area

Displays the following items:

- Driving support system information display
- Hybrid System Indicator/tachometer
- Compass
- Speed limit of the current road (linked to the navigation system) (U.S.A. only)

B Driving information display area

Displays the following items:

- Speedometer
- Shift position/shift range

C : Master warning icon

Displayed when a warning message is displayed.

INFORMATION

Head-up display will operate when

The power switch is in ON.

*: If equipped

■ When using the head-up display

The head-up display may seem dark or hard to see when viewed through sunglasses, especially polarized sunglasses. Adjust the brightness of the head-up display or remove your sunglasses.

■ The tachometer/hybrid system indicator is displayed when

When the following conditions are met, the tachometer or hybrid system indicator will be displayed on the head-up display.

- The head-up display is set to display the maximum. (→ P.766)
- LTA (Lane Tracing Assist) is disabled. (→ P.403)
- LDA (Lane Departure Alert) is disabled. (→ P.774)
- The cruise control, selected by pressing the driving assist mode select switch, is canceled. (→ P.527,529)

⚠ WARNING

Do not continuously look at the head-up display while driving as you may fail to see pedestrians, objects on the road, etc. ahead of the vehicle.

⚠ NOTICE

Observe the following precautions.

- Do not place any drinks near the head-up display projector. If the projector gets wet, electrical malfunctions may result.

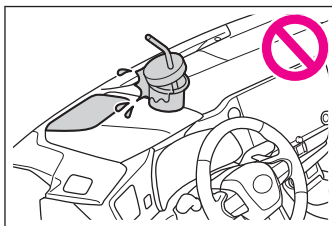

- Do not place anything on or put stickers onto the head-up display projector.
Doing so could interrupt head-up display indications.
- Do not touch the inside of the head-up display projector or thrust sharp edges or the like into the projector.
Doing so could cause mechanical malfunctions.

— Related Links —

[Hybrid system indicator\(P. 337\)](#)

[Changing between the tachometer/hybrid system indicator/speedometer displays\(P. 337\)](#)

[Displayed content\(P. 352\)](#)

Changing settings for the head-up display(P. 366)

Customizable features(P. 765)

Displayed content

Operating the meters/displays

▶ Vehicles without a head-up display

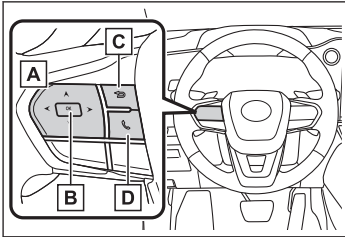

- A < / > : Select menu icons
 ^ / v : Change displayed content, scroll up/down the screen and move the cursor up/down
- B Enter/Set
- C Return to the previous screen
- D Start/receive call

Linked with the hands-free system, sending or receiving call is displayed. For details regarding the hands-free system, refer to the "MULTIMEDIA OWNER'S MANUAL".

▶ Vehicles with a head-up display

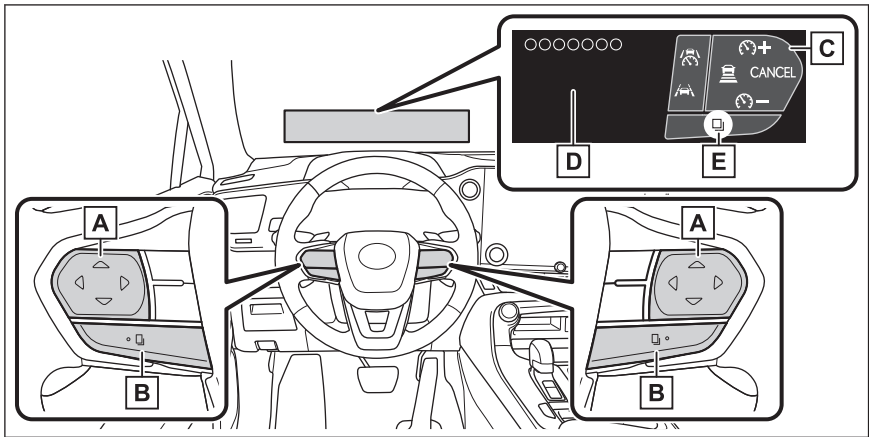

- A The function of each switch differs depending on the conditions and settings.
 When a switch is touched, the function of each switch is displayed on the head-up display. If the head-up display is off, the functions will be displayed on the multi-information display.
 Also, preferred functions for each switch can be set on the center display.
- B Each time this switch is pressed, the functions will change.
- C Switch icon display
 The icon of each switch will be displayed. The touched switch will be highlighted. (E)
- D Switch function guide display

The function guide for the touched switch will be displayed.

INFORMATION

■ If the steering wheel switches do not respond when touched

- It is easier to make the steering wheel switches respond by moving your thumb while touching them.
- If the surface of a steering wheel switch is dirty, turn the power switch off and then clean the switches.
- By turning winter glove mode on, the sensitivity of the switch sensors can be increased.

Related Links

[Customizable features\(P.765\)](#)

Switching the display of the multi-information display (vehicles without a head-up display)

- Press < or > of the meter control switch.





Switching driving information (vehicles without a head-up display)

- Press the < or > meter control switch to select . Then press ^ or v .

Switching the display of the multi-information display (vehicles with a head-up display)

INFORMATION

■ Switching with the steering wheel switches

If  /  is set as a favorite steering wheel switch function, the display can be switched by pushing  or .

- 1 Select  on the center display.
- 2 Select [Vehicle customize].
- 3 Select [Meter].
- 4 Select < or > of "Display switching".
The display changes each time the switch is selected.

Display of drive information

Driving related information is displayed on the following displays.

- Multi-information display
- Head-up display*
- Center display

The items displayed will differ depending on the display.

Drive information 1

The following items can be displayed on the multi-information display.

Use the displayed values as a reference only.

The display contents are different in EV mode or AUTO EV/HV mode, and HV mode.

■ EV mode or AUTO EV/HV mode

- Current electricity consumption
Displays the instantaneous current electricity consumption.

- Average electricity consumption

■ HV mode or hybrid battery (traction battery) charge mode

- Current fuel consumption
Displays instantaneous current fuel consumption
- Average fuel consumption

INFORMATION

■ Electricity consumption

- When the unit is set to "MPH":

Electricity consumption is the consumption rate of the electricity when EV driving is performed and equivalent to the fuel consumption for the gasoline vehicles. For this vehicle, driven distance per kWh of electricity consumed ("miles/kWh") is displayed as electricity consumption on each screen.

- When the unit is set to "km/h":

Electricity consumption is the consumption rate of the electricity when EV driving is performed and equivalent to the fuel consumption for the gasoline vehicles. For this vehicle, electricity consumed per 100 km ("kWh/100 km") is displayed as electricity consumption on each screen.

Drive information 2

The following items can be displayed on the multi-information display.

*: If equipped

- Average vehicle speed
- Total driving time

Drive information 3 (vehicles without a head-up display)

The following items can be displayed on the multi-information display.

■ EV mode or AUTO EV/HV mode

- EV driving range

Displays the EV driving range with charge remaining in the hybrid battery (traction battery).
- Distance to empty

Displays the driving range with remaining fuel.
- Average electricity consumption since starting

Displays the average electricity consumption since starting.

■ HV mode or hybrid battery (traction battery) charge mode

- EV driving range

Displays the EV driving range with charge remaining in the hybrid battery (traction battery).
- Distance to empty

Displays the driving range with remaining fuel.
- Average fuel consumption since starting

Displays the average fuel consumption since starting.

INFORMATION

■ EV driving range

- When the air conditioning system is operating,  is displayed next to the EV driving range and the EV driving range with the air conditioning system on is displayed.
- The EV driving range may shorten even when not driving due to power consumption by the system.

■ Distance to empty

- This distance is computed based on your average fuel consumption. As a result, the actual distance that can be driven may differ from that displayed.
- When only a small amount of fuel is added to the tank, the display may not be updated. When refueling, turn the power switch off. If the vehicle is refueled without turning the power switch off, the display may not be updated.

5-2. Functions of the displays

■ Electricity consumption

- When the unit is set to "MPH":

Electricity consumption is the consumption rate of the electricity when EV driving is performed and equivalent to the fuel consumption for the gasoline vehicles. For this vehicle, driven distance per kWh of electricity consumed ("miles/kWh") is displayed as electricity consumption on each screen.

- When the unit is set to "km/h":

Electricity consumption is the consumption rate of the electricity when EV driving is performed and equivalent to the fuel consumption for the gasoline vehicles. For this vehicle, electricity consumed per 100 km ("kWh/100 km") is displayed as electricity consumption on each screen.

G-force

Displays lateral G-forces on the vehicle on the multi-information display.

Displays around the periphery of the G-force display, the left and right steering amount, accelerator pedal input, and brake fluid pressure.

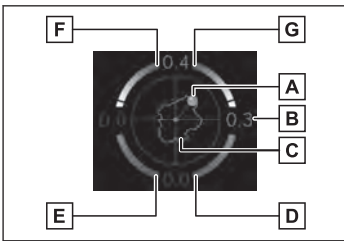

- A Acceleration G-force on the vehicle
- B Current G-force value (analyzed value of front/rear and left/right G-forces)
- C Record of the maximum G-forces

The display is reset each time the hybrid system is started.

- D Accelerator pedal input
- E Brake fluid pressure
- F Left steering amount
- G Right steering amount

If lateral G-forces of 0.5 G or greater are generated, the G-force value display will turn amber and be held for 2 seconds. (Peak hold function)

This display is intended for use as a guideline. Depending on factors such as the road surface condition, temperature and vehicle speed, the display may not show the actual condition of the vehicle.

□ INFORMATION

- The G-force values may not be zero even when the vehicle is parked, such as when it is parked on an incline.
- Depending on the vehicle usage conditions, the brake fluid pressure display may not reach its maximum reading even though the brake pedal is fully depressed.

- If a 12-volt battery terminal is disconnected and reconnected, the steering amount display may be disabled temporarily. After driving the vehicle for a while, the display will be enabled.

Energy monitor/EV driving ratio*

The energy monitor and EV can be displayed on the multi-information display.

The energy monitor screen can be displayed on the center display.

■ EV driving ratio since starting*

Displays the percentage of EV driving since starting.

It is reset each time the hybrid system stops.

■ Energy monitor

The energy monitor can be used to check the vehicle drive status, hybrid system operation status and energy regeneration status.

The arrows will appear in accordance with the energy flow. When there is no energy flow, arrows will not be displayed.

The color of the arrows will change as follows

- Blue: When the hybrid battery (traction battery) is regenerated or charged.
- Orange: When the hybrid battery (traction battery) is in use.
- Red: When the gasoline engine is in use.

► Multi-information display

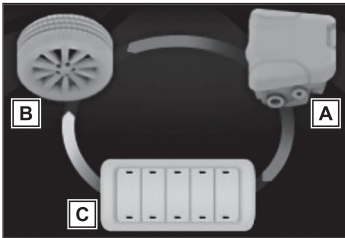

The image shows all the arrows as an example. The actual display will vary depending on conditions.

- A Gasoline engine
- B Tires
- C Hybrid battery (traction battery)

This illustration is for explanation only and may differ depending on the specifications of the vehicle.

*: If equipped

► **Center display (except when charging)**

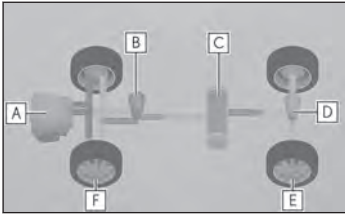

The image shows all the arrows as an example. The actual display will vary depending on conditions.

- A Gasoline engine
- B Front electric motor (traction motor)
- C Hybrid battery (traction battery)
- D Rear electric motor (traction motor)
- E Rear tires
- F Front tires

► **Center display (when charging)**

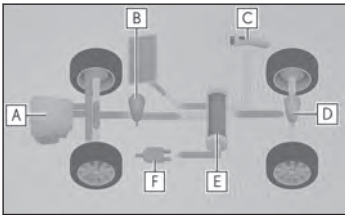

The image shows all the arrows as an example. The actual display will vary depending on conditions.

- A Gasoline engine
- B Front electric motor (traction motor)
- C Charging connector
- D Rear electric motor (traction motor)
- E Hybrid battery (traction battery)
- F Power outlet (120 VAC)

INFORMATION

■ **Color of the hybrid battery (traction battery) on the center display**

It will be green when the hybrid battery (traction battery) is being charged, and yellow when the hybrid battery (traction battery) is being used.

■ **Remaining charge amount warning of hybrid battery (traction battery)**

- The buzzer sounds intermittently when the hybrid battery (traction battery) remains without charging while the shift position is in N, or the remaining charge amount drops below a certain level. If the remaining charge amount drops further, the buzzer sounds continuously.
- When a warning message is shown on the multi-information display and the buzzer sounds, follow the instructions displayed on the screen to perform troubleshooting.

■ **Color of the gasoline engine on the center display**

It will be blue when the engine is warming up, and it will turn to red when the warming up is finished.

Displaying Energy monitor screen on the center display

- 1 Select  on the main menu.
- 2 Select [Energy flow].

Blank (No items)

Displays no drive information contents on the multi-information display.

Current fuel consumption/history screen

Fuel consumption information can be displayed on the center display.

■ Current fuel consumption screen

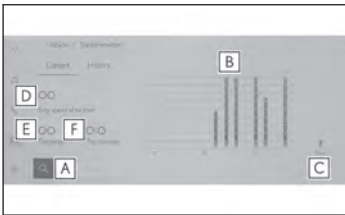

- A Resetting the history data
- B Fuel consumption in the past 15 minutes
- C Current fuel consumption
- D Average vehicle speed since the hybrid system was started.
- E Trip range
- F Elapsed time since the hybrid system was started.

Use the displayed average fuel consumption as a reference. The image is an example only, and may vary slightly from actual conditions.

■ History fuel consumption screen



- A Latest fuel consumption
- B Best recorded fuel consumption
- C Previous fuel consumption record
- D Resetting the history data
- E Updating the latest fuel consumption data

Use the displayed average fuel consumption as a reference. The image is an example only, and may vary slightly from actual conditions.

INFORMATION

■ Updating the history data

Update the latest fuel consumption by selecting [Update] to measure the current fuel consumption again.

■ Resetting the data

The fuel consumption data can be deleted by selecting [**Clear data**].

■ Trip range

Displays the estimated maximum distance that can be driven with the quantity of fuel remaining. This distance is computed based on your average fuel consumption. As a result, the actual distance that can be driven may differ from that displayed.

Displaying fuel consumption/history screen on the center display

- 1 Select  on the main menu.
- 2 Select [**Trip information**].
- 3 Select [**Current**] or [**History**].

AWD operation status display

AWD operation status display can be displayed on the center display.

The illustration used is intended as an example, and may differ from the image that is actually displayed on the center display.

Torque distribution display:

Displays the drive status of each wheel in 6 steps from 0 to 5.

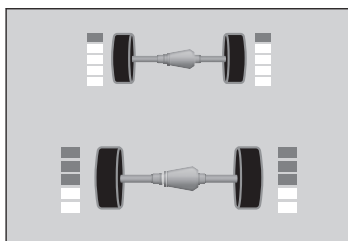

Displaying AWD operation status display on the center display

- 1 Select  on the main menu.
- 2 Select [**All wheel drive**].

Tire pressure

The tire pressure detected by the tire pressure warning system can be displayed on the center display.

INFORMATION

- It may take a few minutes to display the tire inflation pressure after the power switch is turned to ON.

It may also take a few minutes to display the tire inflation pressure after inflation pressure has been adjusted.

- "---" may be displayed if the tire position information cannot be determined due to unfavorable radio wave conditions.
- Tire inflation pressure changes with temperature. The displayed values may also be different from the values measured using a tire pressure gauge.

Related Links

[Operation of the tire pressure warning system\(P. 605\)](#)

Displaying the tire pressure on the center display

- 1 Select  on the main menu.
- 2 Select [Tire pressure].

Driving support system information display

The operating state of the following systems can be displayed on the multi-information display or head-up display*.

- Dynamic radar cruise control
- Cruise control
- LTA (Lane Tracing Assist)
- LDA (Lane Departure Alert)
- LCA (Lane Change Assist)*
- RSA (Road Sign Assist)
- PCS (Pre-Collision System)

INFORMATION

Display position (vehicles with a head-up display)

When the display mode of the head-up display is set to display the maximum, driving support system information will be displayed on the head-up display and not in the content display area of the multi-information display.

Audio system-linked display

The audio system-linked display displays the operating state of the audio system on the multi-information display.

Operations such as selecting the audio source or track, etc. can be performed.

*: If equipped

Navigation system-linked display

The following information is displayed on the multi-information display.

- Route guidance to destination
- Speed limit of the current road (linked to the navigation system) (U.S.A. only)
- Street name
- Compass

INFORMATION

Display position (vehicles with a head-up display)

Depending on the display settings of the head-up display, some content may be displayed on the head-up display and not in the content display area of the multi-information display.

Pop-up display information

Pop-up displays will be displayed on the multi-information display or the head-up display* when necessary.

When a pop-up display is displayed, a current display may no longer be displayed. In this case, the display will return after the pop-up display disappears.

Driving support systems

Displays a warning/suggestion/advice message or the operating state of a relevant system.

- Dynamic radar cruise control
- Cruise control
- LTA (Lane Tracing Assist)
- LDA (Lane Departure Alert)
- LCA (Lane Change Assist)*
- PCS (Pre-Collision System)
- RSA (Road Sign Assist)
- Safe Exit Assist (with door opening control)
- FCTA (Front Cross Traffic Alert)*

*: If equipped

Warning message

Some warning messages are displayed when necessary, according to certain conditions.

Hands-free system status

Displayed when the hands-free system is operated.

Suggestion function

Displays suggestions to the driver in the following situations. To select a response to a displayed suggestion, use the steering switches.

■ **Suggestion to enable the power back door**

If the power back door system is disabled (setting on the center display set to off) and the power back door switch on the instrument panel is operated, a suggestion message will be displayed asking if you wish to enable the power back door system.

To enable the power back door system, select [Yes].

After enabling the power back door system, press the power back door switch again to open or close the power back door.

Related Links

[Customizable features\(P. 765\)](#)

Steering wheel switch operation display

■ **Vehicles without a head-up display**

Displayed when an audio remote control switch on the steering wheel is operated.

■ **Vehicles with a head-up display**

When a steering wheel switch is touched, the icon of each switch and a function guide is displayed.

Related Links

[Operating the meters/displays\(P. 352\)](#)

Navigation system-linked information

In certain situations, the following items which are linked to the navigation system will be displayed:

- Route guidance to destination

Items displayed when the power switch is turned off

The following items will be displayed on the multi-information display when the power switch is turned off.

- Charging schedule
- Average fuel consumption since starting^{*1}
- Distance driven since starting^{*1}
- Driving time since starting^{*1}
- EV driving ratio since starting^{*1}

Displays the percentage of EV driving since starting.

*1: It is reset each time the hybrid system stops.

Changing the instrument panel light brightness

The brightness of the instrument panel lights can be adjusted.

INFORMATION

The instrument panel brightness levels when the tail lights are on and off can be adjusted individually.

However, when the surroundings are bright (daytime, etc.), turning on the tail lights will not change the instrument panel brightness.

At this time, any adjustments made to the instrument panel brightness levels will be applied to both settings at once.

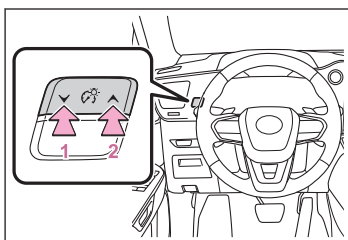

- 1 Darker
- 2 Brighter

Changing settings for the head-up display*

WARNING

- Check that the position and brightness of the head-up display image does not interfere with safe driving.
Incorrect adjustment of the image's position or brightness may obstruct the driver's view and lead to an accident, resulting in death or serious injury.
- As the hybrid system needs to be operating while changing the settings of the head-up display, ensure that the vehicle is parked in a place with adequate ventilation. In a closed area such as a garage, exhaust gases including harmful carbon monoxide (CO) may collect and enter the vehicle. This may lead to death or a serious health hazard.





NOTICE

To prevent 12-volt battery discharge, ensure that the hybrid system is operating while the changing the settings of the head-up display.

INFORMATION

■ Changing settings with the steering wheel switches

If any of the following items have been set as a favorite steering wheel switch function, settings of the head-up display can be changed using the steering wheel switches.

-  : Display on/off
-  : Display mode
-  : Height
-  : Brightness

■ Enabling/disabling of the head-up display

If the head-up display is disabled, it will remain disabled when the power switch is turned off then back to ON.

■ Display brightness

In addition to the brightness setting, the brightness of the display will change automatically according to the ambient brightness.

*: If equipped

■ Head-up display automatic position adjustment

If the display position is recorded into memory, the head-up display will be automatically adjusted to the desired position.

- 1 Select  on the center display.
- 2 Select [Vehicle customize].
- 3 Select [Head up display].

The following settings for the head-up display can be changed.

- Display on/off
- Display mode
- Height
- Brightness
- Angle

Related Links

[Customizable features\(P. 765\)](#)

6-1. Features of the safe driving support functions

- Lexus Safety System + 3 software update **370**
- Lexus Safety System + 3..... **373**
- Driving assist systems **381**

6-2. Using the safe driving support functions

- Pre-Collision System **388**
- Lane Tracing Assist **400**
- Lane Change Assist **405**
- Lane Departure Alert **409**
- Front cross traffic alert **415**
- Assistance in detecting vehicles behind when changing lanes **418**
- Supporting safe exit by detecting detectable objects at the rear of the vehicle by outputting sounds, displaying screens as a warning or cancelling opening of the doors **424**
- Buzzer and screen notifications when approaching an object at low speed **431**
- Buzzer and screen notifications when traveling at a low speed and an approaching vehicle is detected at the rear **443**
- Buzzer and screen notifications when traveling at a low speed and a

pedestrian is detected at the rear **450**

Brake operation when an object is detected while approaching at low speed **455**

Parking assistance through the Advanced Park main switch operation **469**

Road Sign Assist **512**

Dynamic radar cruise control **516**

Cruise Control **526**

Emergency Driving Stop System **531**

Hybrid system output restriction when the accelerator pedal and brake pedal are depressed at the same time **534**

Sudden start restraint control **535**

6-3. Reducing impact to the occupants in a collision

Reducing impact to passengers in a collision **536**

Front passenger occupant classification system **547**

Lexus Safety System + 3 software update *

It is necessary to enter a connected services contract, provided by Lexus, to use these functions. For details, contact your Lexus dealer.

WARNING

For safe use

When the Lexus Safety System + 3 software is updated, the operating methods of functions may change. Using this system without knowing the correct operating methods may lead to an accident resulting in death or serious injury.

Make sure to read the Digital Owner's Manual which corresponds to the software version of the system, available at the Owner's Manual website, before using this system.



Content of the Lexus Safety System + 3 Owner's Manual

This Owner's Manual contains information for Ver. 1. For the latest information about the controls, use, warnings/precautions, etc. of each function of Lexus Safety System + 3, refer to the Digital Owner's Manual at the Owner's Manual website.

If the software of this system has been updated after initial purchase of the vehicle, before using this system, be sure to read the Owner's Manual which corresponds to the software version of the system.

INFORMATION

Precautions for use

-  Be aware that some functions may temporarily be disabled if a legal or safety related issue occurs.
-  If a connected services contract has not been entered or has expired, software updates will not be able to be performed wirelessly.

Checking your vehicle's Lexus Safety System + 3 version

If the software of this system has been updated after initial purchase of the vehicle, to access the appropriate Digital Owner's Manual, it is necessary to check the software version of the system and then visit the Owner's Manual website.

Checking the version using Lexus App

-  The software version of the system can be checked using Lexus App.

Using your vehicle's Lexus Safety System + 3 version

- 1 Access the following URL using a computer or smartphone:

*: If equipped

► For U.S.A. owners

<https://drivers.lexus.com/lexusdrivers/resources/owners-manuals/manual?om=om78343u.nx.2023.2210,phv.vh>



► For Canadian owners

<https://www.lexus.ca/lexus/know-your-lexus/manual?om=om78343u.nx.2023.2210,phv.vh>



- 2 Select the file which includes the previously checked system version.

Updating the software

If a software update is available, a notification will be displayed by Lexus App. Follow the instructions displayed on the screen.

■ INFORMATION

■ Software update precautions

- After a software update has been performed, it will not be possible to revert to a previous version.
- Depending on the communication environment and the content of an update, a software update may take several hours. Although an update will be suspended when the power switch is turned off, it will resume when the power switch is changed back to ON mode.
- Lexus Safety System + 3 can still be used while a software update is being performed.

■ What can be checked using the Lexus App

The following items can be checked or performed.

- Software version, update details, precautions, use methods, etc.
- Software update

Lexus Safety System + 3

Lexus Safety System + 3 consists of the driving assist systems and contributes to a safe and comfortable driving experience.

⚠ WARNING

■ Lexus Safety System + 3

Lexus Safety System + 3 operates under the assumption that the driver will drive safely, and is designed to help reduce the impact to the occupants in a collision and assist the driver under normal driving conditions.

As there is a limit to the degree of recognition accuracy and control performance that this system can provide, do not overly rely on this system. The driver is solely responsible for paying attention to the vehicle's surroundings and driving safely.

■ For safe use

- Do not overly rely on this system. The driver is solely responsible for paying attention to the vehicle's surroundings and driving safely. This system may not operate in all situations and provided assistance is limited. Over-reliance on this system to drive the vehicle safely may lead to an accident resulting in death or serious injury.
- Do not attempt to test the operation of the system, as it may not operate properly, possibly leading to an accident.
- If attention is necessary while performing driving operations or a system malfunction occurs, a warning message or warning buzzer will be operated. If a warning message is displayed on the display, follow the instructions displayed.
- Depending on external noise, the volume of the audio system, etc. it may be difficult to hear the warning buzzer. Also, depending on the road conditions, it may be difficult to recognize the operation of the system.

■ When it is necessary to disable the system

In the following situations, make sure to disable the system.

Failure to do so may lead to the system not operating properly, possibly leading to an accident resulting in death or serious injury.

- When the vehicle is tilted due to being overloaded or having a flat tire
- When driving at extremely high speeds
- When towing another vehicle
- When the vehicle is being transported by a truck, ship, train, etc.
- When the vehicle is raised on a lift and the tires are allowed to rotate freely
- When inspecting the vehicle using a drum tester such as a chassis dynamometer or speedometer tester, or when using an on vehicle wheel balancer
- When the vehicle is driven in a sporty manner or off-road

⚠ WARNING

- When using an automatic car wash
- When a sensor is misaligned or deformed due to a strong impact being applied to the sensor or the area around the sensor
- When accessories which obstruct a sensor or light are temporarily installed to the vehicle
- When a compact spare tire or tire chains are installed to the vehicle or an emergency tire puncture repair kit has been used
- When the tires are excessively worn or the inflation pressure of the tires is low
- When tires other than the manufacturer specified size are installed
- When the vehicle cannot be driven stably, due to a collision, malfunction, etc.

■ Driving assist systems

- AHS (Adaptive High-beam System)*
→ P.227
- AHB (Automatic High Beam)*
→ P.231
- PCS (Pre-Collision System)
→ P.388
- LTA (Lane Tracing Assist)
→ P.400
- LCA (Lane Change Assist)*
→ P.405
- LDA (Lane Departure Alert)
→ P.409
- FCTA (Front cross traffic alert)*
→ P.415
- RSA (Road Sign Assist)
→ P.512
- Dynamic radar cruise control
→ P.516
- Emergency Driving Stop System

*: If equipped

→ P.531

Sensors used by Lexus Safety System +3

Various sensors are used to obtain the necessary information for system operation.

■ Front

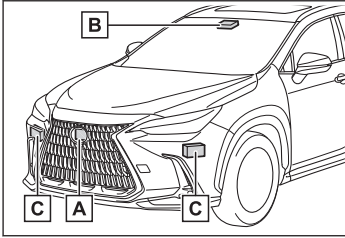

- A Front radar sensor
- B Front camera
- C Front side radar sensors *

■ Rear

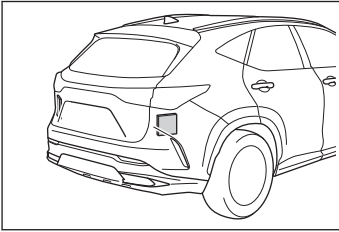

Rear side radar sensors

▲ WARNING

■ To prevent malfunction of the radar sensors

Observe the following precautions. Failure to do so may lead to a radar sensor not operating properly, possibly leading to an accident resulting in death or serious injury.

- Keep the radar sensors and radar sensor covers clean at all times.

Clean the front of a radar sensor or the front or back of a radar sensor cover if it is dirty or covered with water droplets, snow, etc.

Clean the radar sensor and radar sensor cover with a soft cloth so as to not mark or damage them.

*: If equipped

▲ WARNING

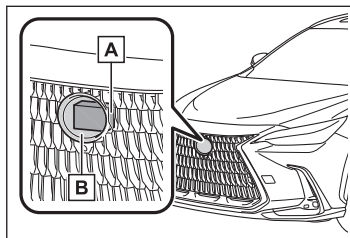

- A Radar sensor
- B Radar sensor cover

- Do not attach accessories, stickers (including transparent stickers), aluminum tape, etc. to a radar sensor or radar sensor cover and their surrounding area.
- Do not subject a radar sensor or its surrounding area to impact.
- If a radar sensor, the front grille, or front bumper has been subjected to an impact, have the vehicle inspected by your Lexus dealer.
- Do not disassemble the radar sensors.
- Do not modify or paint the radar sensors or radar sensor cover, or replace them with anything other than Lexus genuine parts.
- In the following situations, recalibration of the radar sensors will be necessary.

Contact your Lexus dealer for details.

- When a radar sensor is removed and installed, or replaced
- When the front bumper or the front grille has been replaced

■ To prevent malfunction of the front camera

Observe the following precautions. Failure to do so may lead to the front camera not operating properly, possibly leading to an accident resulting in death or serious injury.

- Always keep the windshield clean.
 - If the windshield is dirty or covered with an oily film, water droplets, snow, etc., clean the windshield.
 - Even if a glass coating agent is applied to the windshield, it will still be necessary to use the windshield wipers to remove water droplets, etc. from the area of the windshield in front of the front camera.
 - If the inner side of the windshield where the front camera is installed is dirty, contact your Lexus dealer.
- Do not attach stickers (including transparent stickers) or other items to the area of the windshield in front of the front camera (shaded area in the illustration).

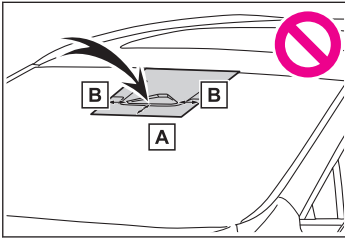
▲ WARNING

A Approximately 1.6 in. (4cm)

B Approximately 1.6 in. (4cm)

- If the part of the windshield in front of the front camera is fogged up or covered with condensation or ice, use the windshield defogger to remove the fog, condensation, or ice.
- If water droplets cannot be properly removed from the area of the windshield in front of the front camera by the windshield wipers, replace the wiper insert or wiper blade.
- Do not attach window tint to the windshield.
- Replace the windshield if it is damaged or cracked.

If the windshield has been replaced, recalibration of the front camera will be necessary.

Contact your Lexus dealer for details.

- Do not allow liquids to contact the front camera.
- Do not allow bright lights to shine into the front camera.
- Do not damage the lens of the front camera or allow it to become dirty.

When cleaning the inside of the windshield, do not allow glass cleaner to contact the lens of the front camera. Do not touch the lens of the front camera.

If the lens of the front camera is dirty or damaged, contact your Lexus dealer.

- Do not subject the front camera to a strong impact.
- Do not change the position or orientation of the front camera or remove it.
- Do not disassemble the front camera.
- Do not modify any parts around the front camera, such as the inside rear view mirror or ceiling.
- Do not attach accessories which may obstruct the front camera to the hood, front grille, or front bumper.

Contact your Lexus dealer for details.

- If a surfboard or other long object is to be mounted on the roof, make sure that it will not obstruct the front camera.
- Do not modify or change the headlights and other lights.

WARNING

Front camera installation area on the windshield

If the system determines that the windshield may be fogged up, it will automatically operate the heater to defog the part of the windshield around the front camera. When cleaning, etc., be careful not to touch the area around the front camera until the windshield has cooled sufficiently, as touching it may cause burns.

INFORMATION

Situations in which the sensors may not operate properly

- When the height or inclination of the vehicle has been changed due to modifications
- When the windshield is dirty, fogged up, cracked or damaged
- When a sensor is extremely hot
- When mud, water, snow, dead insects, foreign matter, etc., is attached to the front of the sensor
- When in inclement weather such as heavy rain, fog, snow, or a sandstorm
- When water, snow, dust, etc. is thrown up in front of the vehicle, or when driving through mist or smoke
- When the headlights are not illuminated while driving in the dark, such as at night or when in a tunnel
- When the lens of a headlight is dirty and illumination is weak
- When the headlights are misaligned
- When a headlight is malfunctioning
- When a the headlights of another vehicle, sunlight, or reflected light shines directly into the front camera
- When the brightness of the surrounding area changes suddenly
- When driving near a TV tower, broadcasting station, electric power plant, radar equipped vehicles, etc., or other location where strong radio waves or electrical noise may be present
- When a wiper blade is blocking the front camera
- When in a location or near objects which strongly reflect radio waves, such as the following:
 - Tunnels
 - Truss bridges
 - Gravel roads
 - Rutted, snow-covered roads

- Walls
 - Large trucks
 - Manhole covers
 - Metal plates
 - Guardrail
- When near a step or protrusion
 - When a detectable vehicle is narrow, such as a small mobility vehicle
 - When a detectable vehicle has a small front or rear end, such as an unloaded truck
 - When a detectable vehicle has a low front or rear end, such as a low bed trailer

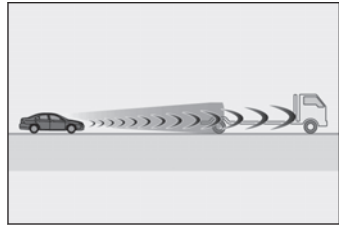

- When a detectable vehicle has extremely high ground clearance

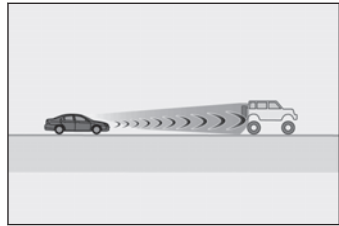

- When a detectable vehicle is carrying a load which protrudes from its cargo area
- When a detectable vehicle has little exposed metal, such as a vehicle which is partially covered with cloth, etc.
- When a detectable vehicle is irregularly shaped, such as a tractor, sidecar, etc.
- When the distance between the vehicle and a detectable vehicle has become extremely short
- When a detectable vehicle is at an angle
- When a large amount of snow, mud, etc. is attached to a detectable vehicle
- When driving on the following kinds of roads:
 - Roads with sharp curves or winding roads
 - Roads with changes in grade, such as sudden inclines or declines
 - Roads which is sloped to the left or right
 - Roads with deep ruts

6.1. Features of the safe driving support functions

- Roads which are rough and unmaintained
- Roads which frequently undulate or are bumpy
- When the steering wheel is being operated frequently or suddenly
- When the vehicle is not in a constant position within a lane
- When parts related to this system, the brakes, etc. are extremely hot or cold, wet, etc.
- When the wheels are misaligned
- When driving on slick road surfaces, such as when it is covered with ice, snow, gravel, etc.
- When the course of the vehicle differs from the shape of a curve
- When the vehicle speed is excessively high when entering a curve
- When entering/exiting a parking lot, garage, car elevator, etc.
- When driving in a parking lot
- When driving through an area where there are obstructions which may contact your vehicle, such as tall grass, tree branches, a curtain, etc.

■ Situations in which the lane may not be detected

- When the lane is extremely wide or narrow
- Immediately after changing lanes or passing through an intersection
- When driving in a temporary lane or lane regulated by construction
- When there are structures, patterns, shadows which are similar to lane lines in the surrounding
- When the lane lines are not clear or driving on a wet road surface
- When a lane line is on a curb
- When driving on a bright, reflective road surface, such as concrete

■ Situations in which some or all of the functions of the system cannot operate

- When a malfunction is detected in this system or a related system, such as the brakes, steering, etc.
- When the VSC, TRAC, or other safety related system is operating
- When the VSC, TRAC, or other safety related system is off

■ Changes in brake operation sound and pedal response

- When the brakes have been operated, brake operation sounds may be heard and the brake pedal response may change, but this does not indicate a malfunction.
- When the system is operating, the brake pedal may feel stiffer than expected or sink. In either situation the brake pedal can be depressed further. Further depress the brake pedal as necessary.

Driving assist systems

To keep driving safety and performance, the following systems operate automatically in response to various driving situations. Be aware, however, that these systems are supplementary and should not be relied upon too heavily when operating the vehicle.

■ **ECB (Electronically Controlled Brake System)**

The electronically controlled system generates braking force corresponding to the brake operation.

■ **ABS (Anti-lock Brake System)**

Helps to prevent wheel lock when the brakes are applied suddenly, or if the brakes are applied while driving on a slippery road surface.

■ **Brake assist**

Generates an increased level of braking force after the brake pedal is depressed when the system detects a panic stop situation.

■ **VSC (Vehicle Stability Control)**

Helps the driver to control skidding when swerving suddenly or turning on slippery road surfaces.

■ **Enhanced VSC (Enhanced Vehicle Stability Control)**

Provides cooperative control of the ABS, TRAC, VSC and EPS.

Helps to maintain directional stability when swerving on slippery road surfaces by controlling steering performance.

■ **Trailer Sway Control**

Helps the driver to control trailer sway by selectively applying brake pressure for individual wheels and reducing driving torque when trailer sway is detected.

■ **TRAC (Traction Control)**

Helps to maintain drive power and prevent the drive wheels from spinning when starting the vehicle or accelerating on slippery roads

■ **Active Cornering Assist (ACA)**

Helps to prevent the vehicle from drifting to the outer side by performing inner wheel brake control when attempting to accelerate while turning.

■ **Hill-start assist control**

Helps to reduce the backward movement of the vehicle when starting on an uphill.

■ EPS (Electric Power Steering)

Employs an electric motor to reduce the amount of effort needed to turn the steering wheel.

■ E-Four (Electronic On-Demand AWD system)

Automatically controls the drive system such as to front-wheel drive or AWD (all wheel drive) according to various running conditions including normal driving, during cornering, on a uphill, when starting off, during acceleration, on a slippery roads due to snow or rain, thus contributing to stable operability and driving stability.

■ Adaptive Variable Suspension System*

By independently controlling the damping force of the shock absorbers for each of the 4 wheels according to the road and driving conditions, this system helps riding comfort with superior vehicle stability, and helps good vehicle posture.

Also, the damping force changes depending on the selected driving mode.

■ The Secondary Collision Brake

When the SRS airbag sensor detects a collision and the system operates, the brakes and brake lights are automatically controlled to reduce the vehicle speed and help reduce the possibility of further damage due to a secondary collision.

INFORMATION

■ When the TRAC/VSC/ABS/Trailer Sway Control systems are operating

The slip indicator light will flash while the TRAC/VSC/ABS/Trailer Sway Control systems are operating.

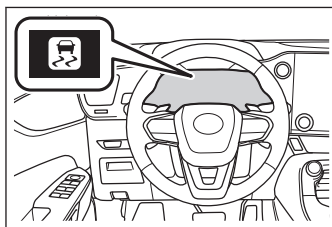

■ Disabling the TRAC system

If the vehicle gets stuck in mud, dirt or snow, the TRAC system may reduce power from



the hybrid system to the wheels. Pressing [OFF] to turn the system off may make it easier for you to rock the vehicle in order to free it.

*: If equipped



To turn the TRAC system off, quickly press and release [OFF].

The "Traction Control Turned OFF" will be shown on the multi-information display. Press



[OFF] again to turn the system back on.

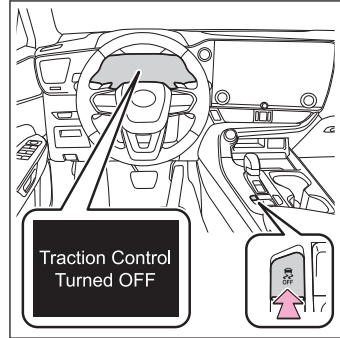

■ Turning off both TRAC, VSC and Trailer Sway Control systems



To turn the TRAC, VSC and Trailer Sway Control systems off, press and hold [OFF] for more than 3 seconds while the vehicle is stopped.

The VSC OFF indicator light will come on and the "Traction Control Turned OFF" will be

shown on the multi-information display. Press  again to turn the system back on.

■ When the message is displayed on the multi-information display showing that TRAC

has been disabled even if [] has not been pressed

TRAC is temporary deactivated.

If the information continues to show, contact your Lexus dealer.

■ Operating conditions of hill-start assist control

When the following four conditions are met, the hill-start assist control will operate:

- The shift position is in a position other than P or N (when starting off forward/backward on an upward incline)
- The vehicle is stopped
- The accelerator pedal is not depressed

6.1. Features of the safe driving support functions

- The parking brake is not engaged
- Power switch is turned to ON

■ Automatic system cancelation of hill-start assist control

The hill-start assist control will turn off in any of the following situations:

- The shift position is shifted to P or N
- The accelerator pedal is depressed
- The parking brake is engaged
- 2 seconds at maximum elapsed after the brake pedal is released
- Power switch is turned to OFF

■ Sounds and vibrations caused by the ABS, brake assist, VSC, Trailer Sway Control, TRAC and hill-start assist control systems

- A sound may be heard from the engine compartment when the brake pedal is depressed repeatedly, when the hybrid system is started or just after the vehicle begins to move. This sound does not indicate that a malfunction has occurred in any of these systems.
- Any of the following conditions may occur when the above systems are operating. None of these indicates that a malfunction has occurred.
 - Vibrations may be felt through the vehicle body and steering.
 - A motor sound may be heard also after the vehicle comes to a stop.

■ ECB operating sound

ECB operating sound may be heard in the following cases, but it does not indicate that a malfunction has occurred.

- Operating sound heard from the engine compartment when the brake pedal is operated.
- Motor sound of the brake system heard from the front part of the vehicle when the driver's door is opened.
- Operating sound heard from the engine compartment when one or two minutes passed after the stop of the hybrid system.

■ Active Cornering Assist operation sounds and vibrations

When the Active Cornering Assist is operated, operation sounds and vibrations may be generated from the brake system, but this is not a malfunction.

■ EPS operation sound

When the steering wheel is operated, a motor sound (whirring sound) may be heard. This does not indicate a malfunction.

■ Automatic reactivation of TRAC, Trailer Sway Control and VSC systems

After turning the TRAC, Trailer Sway Control and VSC systems off, the systems will be automatically re-enabled in the following situations:

- When the power switch is turned off
 - If only the TRAC system is turned off, the TRAC will turn on when vehicle speed increases
- If both the TRAC and VSC systems are turned off, automatic re-enabling will not occur when vehicle speed increases.

■ Operating conditions of Active Cornering Assist

The system operates when the following occurs.

- TRAC/VSC can operate
- The driver is attempting to accelerate while turning
- The system detects that the vehicle is drifting to the outer side
- The brake pedal is released

■ Reduced effectiveness of the EPS system

The effectiveness of the EPS system is reduced to prevent the system from overheating when there is frequent steering input over an extended period of time. The steering wheel may feel heavy as a result.

Should this occur, refrain from excessive steering input or stop the vehicle and turn the hybrid system off. The EPS system should return to normal within 10 minutes.

■ Secondary Collision Brake operating conditions

The system operates when the SRS airbag sensor detects a collision while the vehicle is in motion. However, the system does not operate in any of the following situations.

■ Secondary Collision Brake automatic cancelation

The system is automatically canceled in any of the following situations.

- The vehicle speed drops to approximately 0 mph (0 km/h).
- A certain amount of time elapses during operation
- The accelerator pedal is depressed a large amount

▲ WARNING

■ The ABS does not operate effectively when

- The limits of tire gripping performance have been exceeded (such as excessively worn tires on a snow covered road).
- The vehicle hydroplanes while driving at high speed on wet or slick roads.

⚠ WARNING

■ Stopping distance when the ABS is operating may exceed that of normal conditions

The ABS is not designed to shorten the vehicle's stopping distance. Always maintain a safe distance from the vehicle in front of you, especially in the following situations:

- When driving on dirt, gravel or snow-covered roads
- When driving with tire chains
- When driving over bumps in the road
- When driving over roads with potholes or uneven surfaces

■ TRAC/VSC may not operate effectively when

Directional control and power may not be achievable while driving on slippery road surfaces, even if the TRAC/VSC system is operating. Drive the vehicle carefully in conditions where stability and power may be lost.

■ Active Cornering Assist does not operate effectively when

- Do not overly rely on Active Cornering Assist. Active Cornering Assist may not operate effectively when accelerating down slopes or driving on slippery road surfaces.
- When Active Cornering Assist frequently operates, Active Cornering Assist may temporarily stop operating to ensure proper operation of the brakes, TRAC and VSC.

■ Hill-start assist control does not operate effectively when

- Do not overly rely on hill-start assist control. Hill-start assist control may not operate effectively on steep inclines and roads covered with ice.
- Unlike the parking brake, hill-start assist control is not intended to hold the vehicle stationary for an extended period of time. Do not attempt to use hill-start assist control to hold the vehicle on an incline, as doing so may lead to an accident.

■ When the TRAC/ABS/VSC/Trailer Sway Control is activated

The slip indicator light flashes. Always drive carefully. Reckless driving may cause an accident. Exercise particular care when the indicator light flashes.

■ When the TRAC/VSC/Trailer Sway Control systems are turned off

Be especially careful and drive at a speed appropriate to the road conditions.

As these are the systems to help ensure vehicle stability and driving force, do not turn the TRAC/VSC/Trailer Sway Control systems off unless necessary.

Trailer Sway Control is part of the VSC system and will not operate if VSC is turned off or experiences a malfunction.

■ Replacing tires

Make sure that all tires are of the specified size, brand, tread pattern and total load capacity. In addition, make sure that the tires are inflated to the recommended tire inflation pressure level.

▲ WARNING

The ABS, TRAC and VSC systems will not function correctly if different tires are installed on the vehicle.

Contact your Lexus dealer for further information when replacing tires or wheels.

■ Handling of tires and the suspension

Using tires with any kind of problem or modifying the suspension will affect the driving assist systems, and may cause a system to malfunction.

■ Trailer Sway Control precaution

The Trailer Sway Control system is not able to reduce trailer sway in all situations. Depending on many factors such as the conditions of the vehicle, trailer, road surface and driving environment, the Trailer Sway Control system may not be effective. Refer to your trailer owner's manual for information on how to tow your trailer properly.

■ If trailer sway occurs

Observe the following precautions. Failing to do so may cause death or serious injury.

- Firmly grip the steering wheel. Steer straight ahead. Do not try to control trailer sway by turning the steering wheel.
- Begin releasing the accelerator pedal immediately but very gradually to reduce speed. Do not increase speed. Do not apply vehicle brakes.

If you make no extreme correction with the steering or brakes, your vehicle and trailer should stabilize.

■ Secondary Collision Brake

Do not rely solely upon the Secondary Collision Brake. This system is designed to help reduce the possibility of further damage due to a secondary collision, however, that effect changes according to various conditions. Overly relying on the system may result in death or serious injury.

Related Links

[Trailer towing \(vehicles with towing package\)\(P.145\)](#)

[Tires and wheels\(P.748\)](#)

Pre-Collision System

PCS (Pre-Collision System)

The pre-collision system uses sensors to detect objects (→ P.388) in the path of the vehicle. When the system determines that the possibility of a frontal collision with a detectable object is high, a warning operates to urge the driver to take evasive action and the potential brake pressure is increased to help the driver avoid the collision. If the system determines that the possibility of a collision is extremely high, the brakes are automatically applied to help avoid the collision or help reduce the impact of the collision.

The pre-collision system can be disabled/enabled and the warning timing can be changed. (→ P.399)

⚠ WARNING

■ For safe use

- Driving safely is solely the responsibility of the driver. Pay careful attention to the surrounding conditions in order to ensure safe driving. Never use the pre-collision system in place of normal braking operations. This system cannot help avoid or reduce the impact of a collision in every situation. Over-reliance on this system to drive the vehicle safely may lead to an accident resulting in death or serious injury.
- Although the pre-collision system is designed to help avoid or help reduce the impact of a collision, its effectiveness may change according to various conditions. Therefore, it may not always be able to achieve the same level of performance. Read the following items carefully. Do not overly rely on this system and always drive carefully.
 - For safe use: → P.373

■ When to disable the pre-collision system

- When it is necessary to disable the system: → P.373

Detectable objects

The system can detect the following as detectable objects. (Detectable objects differ depending on the function.)

- Vehicles
- Bicycles *1
- Pedestrians
- Motorcycles *1

*1: Detected as a detectable object only when being ridden.

System functions

■ Pre-collision warning

When the system determines that the possibility of a collision is high, a buzzer will sound and an icon and warning message will be displayed on the multi-information display to urge the driver to take evasive action.

If the detectable object is a vehicle, moderate braking will be performed with the warning.

If the system determines that the accelerator pedal is strongly depressed, the following icon and message will be displayed on the multi-information display.

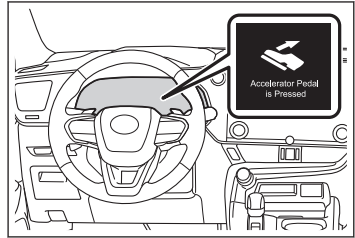
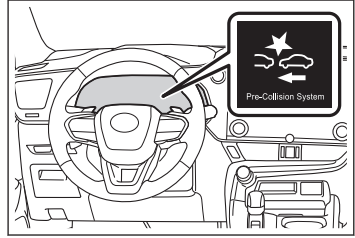

■ Pre-collision brake assist

If the system determines that the possibility of a collision is high and the brake operation by the driver is insufficient, the braking power will be increased.

■ Pre-collision brake control

If the system determines that the possibility of a collision is extremely high, the brakes are automatically applied to help avoid the collision or reduce the impact of the collision.

If the vehicle is stopped by pre-collision brake control, it will remain stopped until the brake pedal is depressed.

■ Emergency steering assist

If the system determines that the following conditions are met, assistance will be provided to help enhance vehicle stability and prevent lane departure. During assistance, in addition to the pre-collision warning, the following icon will be displayed on the multi-information display.

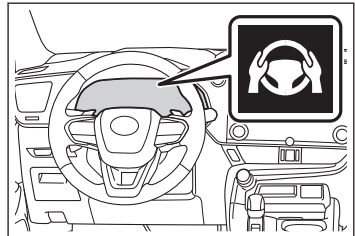

- The possibility of a collision is high
- There is sufficient space within the lane to perform evasive steering maneuvers
- The driver is operating the steering wheel

6-2. Using the safe driving support functions

Vehicles with active steering function: The brakes and steering are controlled to help avoid a collision or reduce the impact of a collision, regardless of the evasive steering maneuvers performed by the driver.

During assistance, the pre-collision warning will operate and a message will be displayed to warn the driver.

■ Intersection collision avoidance support (left/right turn)

In situations such as the following, if the system determines that the possibility of a collision is high, the pre-collision warning and pre-collision braking will operate. Depending on the intersection, assistance may not operate correctly.

- When turning left/right at an intersection and crossing the path of an oncoming vehicle

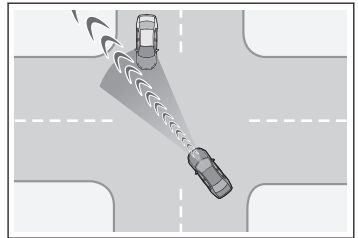

- When turning left/right and an oncoming pedestrian or bicycle is detected

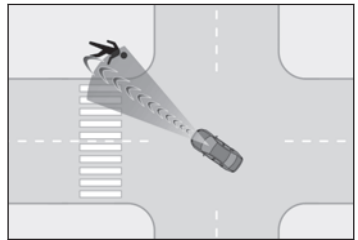

■ Intersection collision avoidance support (crossing vehicles)

At an intersection, etc., if the system determines that the possibility of a collision with an approaching vehicle or motorcycle is high, the pre-collision warning and pre-collision braking will operate. Depending on the intersection, assistance may not operate correctly.

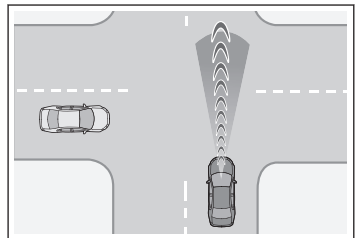

■ Acceleration Suppression at Low Speed

When driving at a low speed, if the accelerator pedal is strongly depressed and the system determines that there is a possibility of a collision, hybrid system output will be restrained or the brakes will be applied weakly to restrict acceleration. During operation, a buzzer will sound and a warning indicator and message will be displayed on the multi-information display.

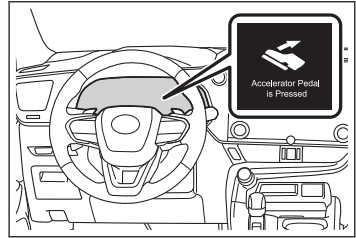

■ Suspension control

When the system determines that the possibility of a collision is high, the Adaptive Variable Suspension system (→ P.382) controls the damping force of the shock absorbers to help maintain an appropriate vehicle posture.

▲ WARNING

■ Pre-collision braking





- When the pre-collision braking function is operating, a large amount of braking force will be applied.
- If the vehicle is stopped by pre-collision braking function, the driver should operate the brakes as necessary.
- In the following situations, brake hold will not operate after the pre-collision braking function has operated. Depending on the situation, the driver should operate the brake pedal immediately.
 - When the accelerator pedal is depressed
 - When the vehicle is stopped by intersection collision avoidance support
 - When the vehicle is stopped on a steep slope
- The pre-collision braking function may not operate if certain operations are performed by the driver. If the accelerator pedal is being depressed strongly or the steering wheel is being turned, the system may determine that the driver is taking evasive action and possibly prevent the pre-collision braking function from operating.
- If the brake pedal is being depressed, the system may determine that the driver is taking evasive action and possibly delay the operation timing of the pre-collision brake control.

■ Acceleration Suppression at Low Speed function

If the steering wheel is being turned, the system may determine that the driver is taking evasive action and possibly prevent the Acceleration Suppression at Low Speed function from operating.

WARNING

Emergency steering assist



-  The emergency steering assist will be canceled when the system determines that lane departure prevention control has completed.
-  Depending on operations performed by the driver, emergency steering assist may not operate or operation may be canceled.
 -  If the accelerator pedal is depressed strongly, the steering wheel is turned heavily, the brake pedal is depressed, or the turn signal lever is operated, the system may determine that the driver is taking evasive action and the emergency steering assist may not operate.
 -  While the emergency steering assist is operating, if the accelerator pedal is depressed strongly, the steering wheel is turned heavily, or the brake pedal is depressed, the system may determine that the driver is taking evasive action and emergency steering assist operation may be canceled.
 -  While the emergency steering assist is operating, if the steering wheel is held or turned in the opposite direction of system operation, emergency steering assist operation will be canceled.

INFORMATION

Operating conditions of each function of the pre-collision system

The pre-collision system is enabled and the system determines that the possibility of a frontal collision with a detected object is high.

However, the system will not operate in the following situations:

-  When the vehicle has not been driven a certain amount after a terminal of the 12-volt battery has been disconnected and reconnected
-  When the shift position is in R
-  When the VSC OFF indicator is illuminated (only the pre-collision warning function will be operational)

The following are the operational speeds and cancelation conditions of each function:

-  Pre-collision warning

Detectable objects	Vehicle speed	Relative speed between your vehicle and object
Preceding vehicles, stopped vehicles	Approximately 3 to 110 mph (5 to 180 km/h)	Approximately 3 to 110 mph (5 to 180 km/h)
Oncoming vehicles	Approximately 20 to 110 mph (30 to 180 km/h)	Approximately 50 to 130 mph (80 to 220 km/h)

Detectable objects	Vehicle speed	Relative speed between your vehicle and object
Bicycles	Approximately 3 to 50 mph (5 to 80 km/h)	Approximately 3 to 50 mph (5 to 80 km/h)
Pedestrians	Approximately 3 to 50 mph (5 to 80 km/h)	Approximately 3 to 50 mph (5 to 80 km/h)
Preceding motorcycles, stopped motorcycles	Approximately 3 to 110 mph (5 to 180 km/h)	Approximately 3 to 50 mph (5 to 80 km/h)
Oncoming motorcycles	Approximately 20 to 110 mph (30 to 180 km/h)	Approximately 20 to 110 mph (30 to 180 km/h)

While the pre-collision warning is operating, if the steering wheel is operated heavily or suddenly, the pre-collision warning may be cancelled.

● Pre-collision brake assist

Detectable objects	Vehicle speed	Relative speed between your vehicle and object
Preceding vehicles, stopped vehicles	Approximately 20 to 110 mph (30 to 180 km/h)	Approximately 7 to 110 mph (10 to 180 km/h)
Bicycles	Approximately 20 to 50 mph (30 to 80 km/h)	Approximately 20 to 50 mph (30 to 80 km/h)
Pedestrians	Approximately 20 to 50 mph (30 to 80 km/h)	Approximately 20 to 50 mph (30 to 80 km/h)
Preceding motorcycles, stopped motorcycles	Approximately 20 to 110 mph (30 to 180 km/h)	Approximately 7 to 50 mph (10 to 80 km/h)

● Pre-collision braking

Detectable objects	Vehicle speed	Relative speed between your vehicle and object
Preceding vehicles, stopped vehicles	Approximately 3 to 110 mph (5 to 180 km/h)	Approximately 3 to 110 mph (5 to 180 km/h)
Oncoming vehicles	Approximately 20 to 110 mph (30 to 180 km/h)	Approximately 50 to 130 mph (80 to 220 km/h)

6-2. Using the safe driving support functions

Detectable objects	Vehicle speed	Relative speed between your vehicle and object
Bicycles	Approximately 3 to 50 mph (5 to 80 km/h)	Approximately 3 to 50 mph (5 to 80 km/h)
Pedestrians	Approximately 3 to 50 mph (5 to 80 km/h)	Approximately 3 to 50 mph (5 to 80 km/h)
Preceding motorcycles, stopped motorcycles	Approximately 3 to 110 mph (5 to 180 km/h)	Approximately 3 to 50 mph (5 to 80 km/h)
Oncoming motorcycles	Approximately 20 to 110 mph (30 to 180 km/h)	Approximately 20 to 110 mph (30 to 180 km/h)

If either of the following occur while the pre-collision braking function is operating, it will be canceled:

- The accelerator pedal is strongly depressed
 - The steering wheel is operated heavily or suddenly
- Emergency steering assist

The emergency steering assist will not operate when the turn signal lights are flashing.

Detectable objects	Vehicle speed	Relative speed between your vehicle and object
Preceding vehicles, stopped vehicles, bicycles, pedestrians, motorcycles	Approximately 25 to 50 mph (40 to 80 km/h) Active steering function: * to 50 mph (* to 80 km/h)	Approximately 25 to 50 mph (40 to 80 km/h) Active steering function: * to 50 mph (* to 80 km/h)
*Minimum vehicle speed: Vehicle speed at which evasion using pre-collision brake control is difficult		

While the emergency steering assist is operating, if any of the following are performed, emergency steering assist operation may be cancelled:

- The accelerator pedal is strongly depressed
 - The steering wheel is operated heavily or suddenly
 - The brake pedal is depressed
- Intersection collision avoidance support (left/right turn)

The intersection collision avoidance support (for left/right turning vehicles) will not operate when the turn signal lights are not flashing.

Detectable objects	Vehicle speed	Oncoming vehicle speed	Relative speed between your vehicle and object
Oncoming vehicles	Approximately 3 to 25 mph (5 to 40 km/h)	Approximately 3 to 45 mph (5 to 75 km/h)	Approximately 7 to 70 mph (10 to 115 km/h)
Pedestrians	Approximately 3 to 20 mph (5 to 30 km/h)	-	Approximately 3 to 25 mph (5 to 40 km/h)
Bicycles	Approximately 3 to 20 mph (5 to 30 km/h)	-	Approximately 3 to 30 mph (5 to 50 km/h)
Oncoming motorcycles	Approximately 3 to 25 mph (5 to 40 km/h)	Approximately 3 to 45 mph (5 to 75 km/h)	Approximately 7 to 70 mph (10 to 115 km/h)

● Intersection collision avoidance support (crossing vehicles)

Detectable objects	Vehicle speed	Crossing vehicle speed	Relative speed between your vehicle and object
Vehicles (side)	Approximately 3 to 38 mph (5 to 60 km/h)	<ul style="list-style-type: none"> ● Your vehicle speed or less ● Approximately 25 mph or less (40 km/h or less) 	Approximately 3 to 38 mph (5 to 60 km/h)
Motorcycles (side)	Approximately 3 to 38 mph (5 to 60 km/h)	<ul style="list-style-type: none"> ● Your vehicle speed or less ● Approximately 25 mph or less (40 km/h or less) 	Approximately 3 to 38 mph (5 to 60 km/h)

● Acceleration Suppression at Low Speed

The Acceleration Suppression at Low Speed function will not operate when the turn signal lights are flashing.

Detectable objects	Vehicle speed	Relative speed between your vehicle and object
Preceding vehicles, stopped vehicles	Approximately 0 to 9 mph (0 to 15 km/h)	Approximately 0 to 9 mph (0 to 15 km/h)
Bicycles	Approximately 0 to 9 mph (0 to 15 km/h)	Approximately 0 to 9 mph (0 to 15 km/h)

6-2. Using the safe driving support functions

Detectable objects	Vehicle speed	Relative speed between your vehicle and object
Pedestrians	Approximately 0 to 9 mph (0 to 15 km/h)	Approximately 0 to 9 mph (0 to 15 km/h)

While the Acceleration Suppression at Low Speed function is operating, if any of the following are performed, the low speed sudden acceleration suppression function operation will be cancelled:

- The accelerator pedal is released.
- The steering wheel is operated heavily or suddenly

■ Detection of detectable objects

Objects are detected based on their size, shape, and movement. Depending on the ambient brightness, movement, posture and direction of a detectable object, it may not be detected and the system may not operate properly. The system detects shapes, such as the following, as detectable objects.

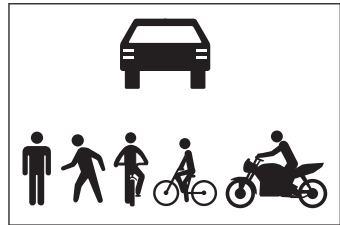

■ Situations in which the system may operate even though the possibility of a collision is not high

- In certain situations, such as the following, the system may determine that the possibility of a collision is high and operate:
 - When passing a detectable object
 - When changing lanes while overtaking a detectable object
 - When suddenly approaching a detectable object
 - When approaching a detectable object or other object on the roadside, such as guardrails, utility poles, trees, walls, etc.
 - When there is a detectable object or other object by the roadside at the entrance of a curve

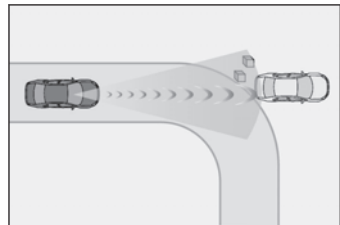

- When there are patterns or a painting ahead of the vehicle that may be mistaken for a detectable object

- When passing a detectable object that is changing lanes or turning left/right

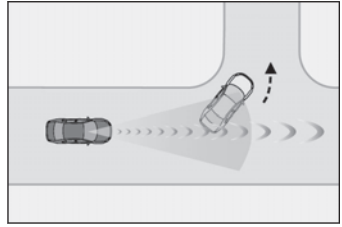

- When passing a detectable object which is stopped to make a left/right turn

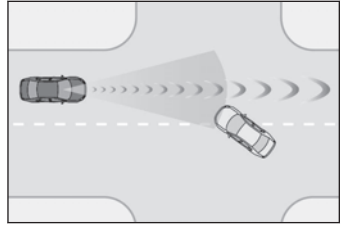

- When a detectable object stops immediately before entering the path of the vehicle
- When passing through a location with a structure above the road (traffic sign, billboard, etc.)

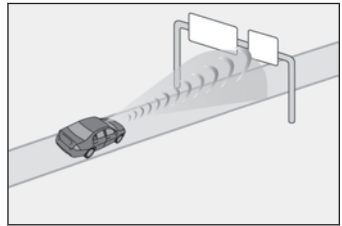

- When approaching an electric toll gate barrier, parking lot barrier, or other barrier that opens and closes
- When turning left/right and an oncoming vehicle or pedestrian crosses in front of the vehicle
- When attempting to turn left/right in front of an oncoming vehicle or pedestrian
- When turning left/right and an oncoming vehicle or pedestrian stops immediately before entering the path of the vehicle
- When turning left/right and an oncoming vehicle turns left/right in front of the vehicle

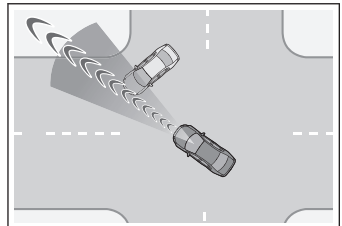

- When the steering wheel is operated toward the path of an oncoming vehicle

■ Situations in which the system may not operate properly

- In certain situations, such as the following, a detectable object may not be detected by the front sensors, and the system may not operate properly:
 - When a detectable object is approaching your vehicle
 - When your vehicle or a detectable object is wandering
 - When a detectable object makes an abrupt maneuver (such as sudden swerving, acceleration or deceleration)
 - When suddenly approaching a detectable object
 - When the detectable object is near a wall, fence, guardrail, manhole cover, steel plate on the road surface, or another vehicle
 - When there is a structure above a detectable object
 - When part of a detectable object is hidden by another object (large luggage, umbrella, guardrail, etc.)
 - When multiple detectable objects are overlapping
 - When a bright light, such as the sun, is reflecting off of a detectable object
 - When a detectable object is white and looks extremely bright
 - When the color or brightness of a detectable object causes it to blend in with its surroundings
 - When a detectable object cuts in front of or suddenly emerges in front of your vehicle
 - When approaching a vehicle which is diagonal
 - If a vehicle ahead is a child sized bicycle, is carrying a large load, is carrying an extra passenger, or has an unusual shape (bicycles equipped with a child seat, tandem bicycles, etc.)
 - If a pedestrian or bicycle is shorter than approximately 3.2 ft. (1 m) or taller than approximately 6.5 ft. (2 m).
 - When the silhouette of a pedestrian or bicycle is unclear (such as when they are wearing a raincoat, long skirt, etc.)
 - When a pedestrian or bicycle is bending forward or squatting
 - When a pedestrian or bicycle is moving at high speed
 - When a pedestrian is pushing a stroller, wheelchair, bicycle or other vehicle
 - When a detectable object blends in with the surrounding area, such as when it is dim (at dawn or dusk) or dark (at night or in a tunnel)
 - When the vehicle has not been driven for a certain amount of time after the hybrid system was started
 - While turning left/right or a few seconds after turning left/right

- While driving around a curve and a few seconds after driving around a curve
- When turning left/right and an oncoming vehicle is driving in a lane 3 or more lanes from the vehicle
- When turning left/right and the direction of the vehicle differs greatly from the direction traffic flows in the oncoming lane

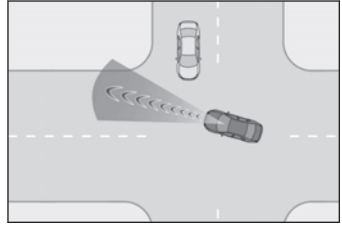

- When turning left/right and approaching a pedestrian which was traveling in the same direction as the vehicle and continues straight

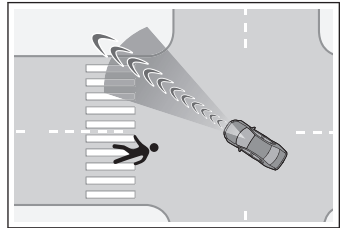

- In addition to the preceding, in certain situations, such as the following, the emergency steering assist may not operate properly:
 - When a detectable object is too close to the vehicle
 - When there is insufficient space to perform evasive steering maneuvers or an obstruction exists in the evasion direction
 - When there is an oncoming vehicle

Changing the pre-collision setting

- The pre-collision system can be enabled/disabled through a customize setting. → P.774
The system is enabled each time the power switch is turned to ON.
- When the system is disabled, the PCS warning light will illuminate and a message will be displayed on the multi-information display.
- The pre-collision settings can be changed on the customize settings. → P.774
- When the pre-collision warning timing is changed, the emergency steering assist (excluding the active steering function) timing will also be changed. When [Later] is selected, the emergency steering assist (excluding the active steering function) will not operate in most cases.

When the dynamic radar cruise control is operating, the pre-collision warning will operate at the [Earlier] timing, regardless of the user setting.

Lane Tracing Assist

LTA (Lane Tracing Assist)

LTA functions

- When driving on a road with clear lane lines with the dynamic radar cruise control operating, lane lines and preceding and surrounding vehicles are detected using the front camera and radar sensor, and the steering wheel is operated to maintain the vehicle's lane position.

Use the this function only on highways and expressways.

If the dynamic radar cruise control is not operating, the function will not operate.

In situations where the lane lines are difficult to see or are not visible, such as when in a traffic jam, support will be provided using the path of preceding and surrounding vehicles.

If the system determines that the steering wheel has not been operated for a certain amount of time or the steering wheel is not being firmly gripped, the driver will be alerted via a display and this function will be temporarily canceled.

If the steering wheel is firmly gripped, the function will begin operating again.

- When the function is operating, if the vehicle is likely to depart from its lane, the driver will be alerted via a display and buzzer.

When the buzzer sounds, check the area around the vehicle and carefully operate the steering wheel to move the vehicle back to the center of the lane.

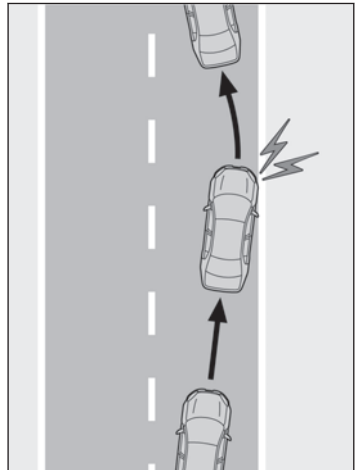
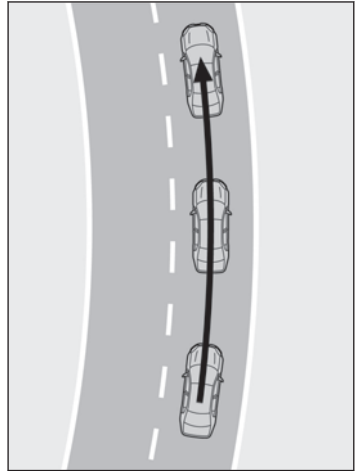

⚠ WARNING**■ Before using the LTA system**

- Do not overly rely on the LTA system. The LTA system is not a system which provides automated assistance in driving and it is not a system which reduces the amount of attention necessary for safe driving. The driver is solely responsible for paying attention to their surroundings and operating the steering wheel as necessary to ensure safety. Also, the driver is responsible for taking adequate breaks when fatigued, such as when driving for a long time.

Failure to perform appropriate driving operations and pay careful attention may lead to an accident.

- When not using the LTA system, turn it off using the LTA switch.

□ INFORMATION**■ Operating conditions of function**

- This function is operable when all of the following conditions are met:
 - The LTA system detects lane lines or the path of preceding or surrounding vehicles (except when the preceding vehicle is small, such as a motorcycle).
 - The dynamic radar cruise control is operating.
 - The lane width is approximately 10 to 13 ft. (3 to 4 m).
 - The turn signal lever is not being operated.
 - The vehicle is not being driven around a sharp curve.
 - The vehicle is not accelerating or decelerating more than a certain amount.
 - The steering wheel is not being turned with a large force.
 - The hands off steering wheel warning (→ P.402) is not operating.
 - The vehicle is being driven in the center of a lane.

■ Temporary cancelation of functions

- When the operating conditions are no longer met, a function may be temporarily canceled. However, when the operation conditions are met again, operation of the function will automatically be restored. (→ P.401)
- If the operating conditions of a function are no longer met while the function is operating, a buzzer may sound to indicate that the function has been temporarily canceled.
- The steering assist operation of the function can be overridden by the steering wheel operation of the driver.

■ Lane departure warning function when the LTA is operating

- Even if the LDA warning method is changed to vibration of the steering wheel, if the vehicle deviates from the lane while the LTA is operating, the warning buzzer will sound to alert the driver.
- If steering wheel operation equivalent to that necessary for a lane change is detected, the system will determine the vehicle is not deviating from the lane and the warning will not operate.

■ Hands off steering wheel warning operation

In the following situations, a message urging the driver to grip the steering wheel and the icon shown in the illustration will be displayed on the multi-information display to warn the driver. If the system detects that the steering wheel is held, the warning will be canceled. When using the system, make sure to grip the steering wheel firmly, regardless of whether the warning is operating or not.



- When the system determines the driver is not holding the steering wheel while the function is operating

If no operations are detected for a certain amount of time, a buzzer will sound, the warning will operate, and the function will be temporarily canceled. This warning may also operate if the driver only operates steering wheel a small amount continuously.

- Depending on the condition of the vehicle, handle control condition and road surface, the warning function may not operate.

Vehicles with LCA: In the following situations, the system may not be able to detect when the driver's hands are off the steering wheel.

- When a steering wheel cover is installed
- When the driver is wearing gloves
- When foreign matter is attached to the steering wheel
- When the driver is gripping the wood trim, seam of the leather, spokes, or other part of the steering wheel that does not have sensors

Vehicles with LCA: In the following situations, the hands off steering wheel warning may not operate and the LTA function may continue operating even though the driver's hands are off the steering wheel:

- When something other than a hand is contacting the steering wheel
- When a wide object or arms are held across the steering wheel

Enabling/disabling the system

The LTA will change between enabled/disabled each time the LTA switch is pressed.

When the LTA is enabled, the LTA indicator will illuminate.

► Vehicles without a head-up display

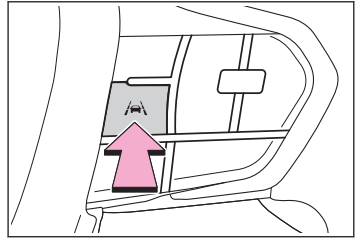

► Vehicles with a head-up display

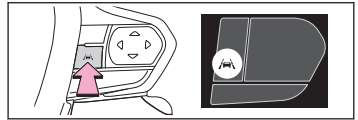

▲ WARNING

■ Situations in which the functions may not operate properly

In the following situations, the functions may not operate properly and the vehicle may depart from its lane. Do not overly rely on these functions. The driver is solely responsible for paying attention to their surroundings and operating the steering wheel as necessary to ensure safety.

- When a preceding or surrounding vehicle changes lanes (Your vehicle may follow the preceding or surrounding vehicle and also change lanes)
- When a preceding or surrounding vehicle is swaying (Your vehicle may sway accordingly and depart from the lane)
- When a preceding or surrounding vehicle departs from a lane (Your vehicle may follow the preceding or surrounding vehicle and also depart from the lane)
- When a preceding or surrounding vehicle is being driven extremely close to the left/right lane line (Your vehicle may follow the preceding or surrounding vehicle accordingly and depart from the lane)











⚠ WARNING

- When there are moving objects or structures in the surrounding area (Depending on the position of the moving object or structure relative to your vehicle, your vehicle may sway)
- When the vehicle is struck by a crosswind or the turbulence of other nearby vehicles
- Situations in which the sensors may not operate properly: → P.378
- Situations in which the lane may not be detected: → P.380
- When it is necessary to disable the system: → P.373

Operation display of steering wheel operation support

The operating state of the LTA system is indicated.

Indicator	Lane display	Steering icon	Situation
 White	 Gray	 Grey	LTA is on standby
 Green	 Green	 Green	LTA is operating
 Orange Flashing	 Orange Flashing	 Green	The vehicle is departing the lane toward the side which the lane display is flashing

Lane Change Assist*

LCA (Lane Change Assist)

LCA functions

This function is linked to the LTA and provides assistance in performing lane changes through steering wheel operations when the turn signal lever → P.200 is held partway.

When not using the LCA system, turn it off using the LCA switch.

Use the this function only on highways and expressways.

The steering assist operation can be overridden by the steering wheel operation of the driver.

The lane change assist function is not designed to operate when changing lanes at a junction.

WARNING

Before using the LCA system

- Do not overly rely on the LCA system.

The LCA system is a system which provides automated assistance in driving. However, as it is not a system which reduces the need for checking an adjacent lane for other vehicles, approaching vehicles, etc. when changing lanes. The driver is solely responsible for paying attention to their surroundings and operating the steering wheel as necessary to ensure safety.

Also, do not use the LCA to change lanes into which a lane change should not be performed (oncoming lanes, road shoulders, etc.).

- Failure to perform appropriate driving operations and pay careful attention may lead to an accident.

INFORMATION

Operating conditions of function

This function is operable when all of the following conditions are met:

- The LTA is operating.
- The lane change assist function is enabled by a customize setting.
- The vehicle speed is between approximately 55 and 85 mph (90 and 140 km/h).
- The system detects a broken white line on the side which the lane change is to be performed.

*: If equipped

6-2. Using the safe driving support functions

- A vehicle is not detected in the lane toward which the turn signal is operated.
- The steering wheel is not being turned with a large force.
- The hands off steering wheel warning(→ P.406) is not operating.

■ Cancellation of functions

If the operating conditions are no longer met while the LCA is operating, a message may be displayed and buzzer may sound to indicate that the LCA has been canceled.

- When the operating conditions are no longer met
- When the system can no longer detect lane lines
- When the turn signal lever is operated to the left/right turn position
- When the LTA system detects operation of the steering wheel, brake pedal or accelerator pedal by the driver
- When the system determines the driver is not holding the steering wheel while the function is operating

If the system detects that a vehicle is quickly approaching in the lane toward which the turn signal is operated, a buzzer will sound, the steering wheel will vibrate, and a message will be displayed to alert the driver. At the same time the steering wheel may be slightly operated to help keep the vehicle away from the approaching vehicle.

■ Hands off steering wheel warning operation

In the following situations, a message urging the driver to grip the steering wheel and the icon shown in the illustration will be displayed on the multi-information display to warn the driver. If the system detects that the steering wheel is held, the warning will be canceled. When using the system, make sure to grip the steering wheel firmly, regardless of whether the warning is operating or not.

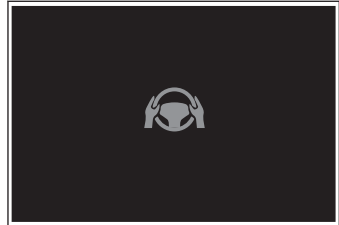

- When the system determines the driver is not holding the steering wheel while LCA is operating

Operating the LCA

If the turn signal lever is held in the lane change position, the lane change direction will be displayed and the function will operate.

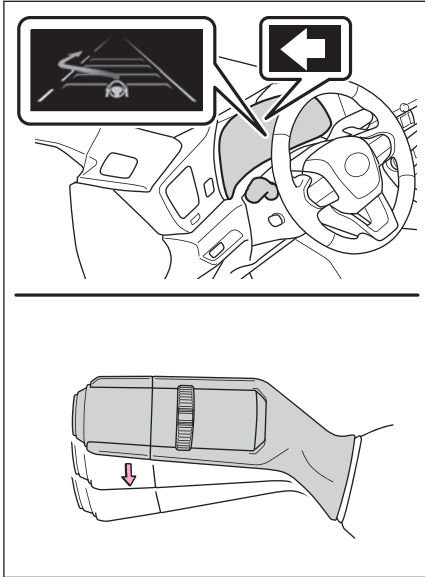

⚠ WARNING

■ Situations in which the LCA should not be used



- When driving on a one lane road
- When there is no broken white line between the current lane and the lane to be changed to

Enabling/disabling the system



- LCA can be enabled/disabled through a customize setting. → P.775

Displays and system operation

The operating state of the LCA system is indicated.

LCA display	Steering icon	Condition
 Blue arrow and white line	 Green	LCA is operating

6-2. Using the safe driving support functions

LCA display	Steering icon	Condition
	 Grey	Approaching vehicle detected while LCA is operating
Not displayed	 Grey	Lane line no longer detected while LCA is operating

Lane Departure Alert

LDA (Lane Departure Alert)

Basic functions

The LDA system warns the driver if the vehicle may deviate from the current lane or course^{*1}, and also can slightly operate the steering wheel to help avoid deviation from the lane or course^{*1}.

The front camera is used to detect lane lines or a course^{*1}.

■ Lane departure alert function

When the system determines that the vehicle might depart from its lane or course^{*1}, a warning is displayed on a display, and either a warning buzzer will sound or the steering wheel will vibrate to alert the driver.

Check the area around your vehicle and carefully operate the steering wheel to move the vehicle back to the center of the lane or course^{*1}.

If the system determines that the vehicle may collide with a vehicle in an adjacent lane, the lane departure alert will operate even if the turn signals are operating.

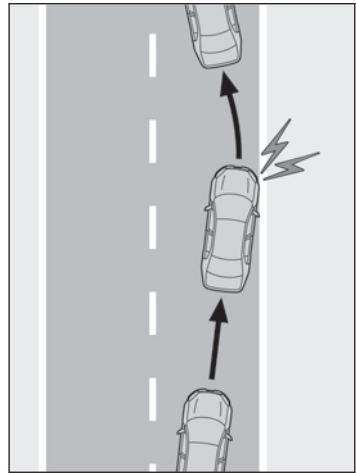

*1: Boundary between the asphalt and grass, soil, etc., or structures, such as a curb, guardrail, etc.

■ Lane departure prevention function

If the system determines that the vehicle is likely to depart from its lane or course*¹, it provides assistance through steering wheel operations to help avoid deviation from the lane or course.

If the system determines that the steering wheel has not been operated for a certain amount of time or the steering wheel is not being firmly gripped, a warning message may be displayed and a warning buzzer may sound to alert the driver.

If the system determines that the vehicle may collide with a vehicle in an adjacent lane, the lane departure prevention function will operate even if the turn signals are operating.

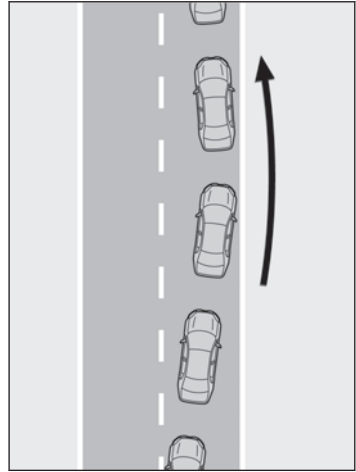

■ Break suggestion function

If the vehicle is swaying, a message will be displayed and a warning buzzer will sound to urge the driver to take a break.

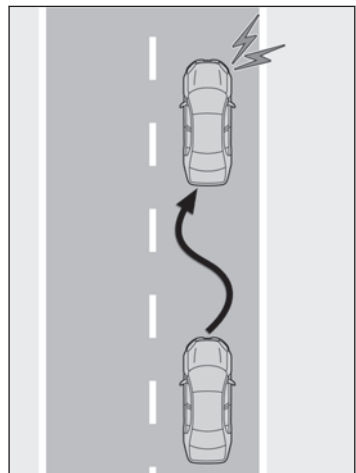

⚠ WARNING

■ Before using the LDA system

- Do not overly rely on the LDA system. The LDA system is a system which provides automated assistance in driving. However, as it is not a system which reduces the amount of attention necessary for safe driving. The driver is solely responsible for paying attention to their surroundings and operating the steering wheel as necessary to ensure safety. Also, the driver is responsible for taking adequate breaks when fatigued, such as when driving for a long time.

⚠ WARNING

- Failure to perform appropriate driving operations and pay careful attention may lead to an accident.

📖 INFORMATION**■ Operating conditions of each function**

- Lane departure alert/prevention function

This function is operable when all of the following conditions are met:

- The vehicle speed is approximately 30 mph (50 km/h) or more.

Operation may be possible when the vehicle speed is approximately 25 mph (40 km/h) or more if vehicles, motorcycles, bicycles, or pedestrians are detected near the lane.

- The system recognizes a lane or course^{*2}. (When recognized on only one side^{*2}, the system will operate only for the recognized side.)
- The lane width is approximately 9.8 ft. (3 m) or more.
- The turn signal lever is not being operated.

(Except when a vehicle is detected in the direction that the turn signal lever is operated.)

- The vehicle is not being driven around a sharp curve.
- The vehicle is not accelerating or decelerating more than a certain amount.
- The steering wheel is not being turned sufficiently to perform a lane change.

- Break suggestion function

This function is operable when all of the following conditions are met:

- The vehicle speed is approximately 30 mph (50 km/h) or more.
- The lane width is approximately 9.8 ft. (3 m) or more.

■ Temporary cancellation of functions

When the operating conditions are no longer met, a function may be temporarily canceled. However, when the operation conditions are met again, operation of the function will automatically be restored. (→ P.411)

■ Operation of the lane departure alert function/lane departure prevention function

- Depending on the vehicle speed, road conditions, lane departure angle, etc., operation of the lane departure prevention function may not be felt or the function may not operate.

*2: Boundary between the asphalt and grass, soil, etc., or structures, such as a curb, guardrail, etc.

6-2. Using the safe driving support functions

- Depending on the conditions, the warning buzzer may operate even if vibration is selected through a customize setting.
- If a course ^{*2} is not clear or straight, the lane departure alert function or lane departure prevention function may not operate.
- The lane departure alert function or lane departure prevention function may not operate if the system judges that the vehicle is intentionally being steered to avoid a pedestrian or parked vehicle.
- It may not be possible for the system to judge if there is danger of a collision with a vehicle in an adjacent lane.
- The steering assist operation of the lane departure prevention function can be overridden by the steering wheel operation of the driver.

■ Hands off steering wheel warning operation

In the following situations, a message urging the driver to operate the steering wheel and an icon will be displayed and a buzzer will sound to warn the driver. When using the system, make sure to grip the steering wheel firmly, regardless of whether the warning is operating or not.

- When the system determines that the driver is not securely holding the steering wheel, or the steering wheel is not being operated when the steering assist operation of the lane departure prevention function is operating

The length of time that the warning buzzer operates will become longer as the frequency of the steering assist operating increases. Even if the system judges that the steering wheel has been operated, the warning buzzer will sound for a certain amount of time.

■ Break suggestion function





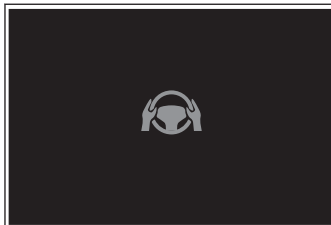







If the vehicle is swaying, a message will be displayed and a warning buzzer will sound to urge the driver to take a break.

Depending on the condition of the vehicle and road surface, the break suggestion function may not operate.



Displays and system operation

The operating state of the lane departure alert function and steering assist operation of the lane departure prevention function are indicated.

Indicator	Lane display	Steering icon	Situation
Not illuminated	Not illuminated	Not illuminated	System disabled
 White	 Gray	Not illuminated	Lane lines are not detected by the system
 White	 White	Not illuminated	Lane lines are detected by the system
 Orange Flashing	 Orange Flashing	Not illuminated	Lane departure alert function is operating for the side which the lane display is flashing
 Green	 Green	 Green	Lane departure prevention function is operating for the side which the lane display is illuminated
 Orange Flashing	 Orange Flashing	 Green	Lane departure alert function/lane departure prevention function is operating for the side which the lane display is flashing

Changing LDA settings

- The LDA system can be enabled/disabled through a customize setting. → P.774
- The following settings of the LDA can be changed through customize settings. → P.774

WARNING

■ Situations in which the LDA should not be used

In the following situations, disable the LDA system. Failure to do so may lead to an accident.

- When it is necessary to disable the system: → [P.373](#)

■ Situations in which the system may not operate properly

In the following situations, the system may not operate properly and the vehicle may depart from its lane. Do not overly rely on these functions. The driver is solely responsible for paying attention to their surroundings and operating the steering wheel as necessary to ensure safety.

- When the boundary between the asphalt and grass, soil, etc., or structures, such as a curb, guardrail, etc. is not clear or straight
- When the vehicle is struck by a crosswind or the turbulence of other nearby vehicles
- Situations in which the lane may not be detected: → [P.380](#)
- Situations in which the sensors may not operate properly: → [P.378](#)
- Situations in which some or all of the functions of the system cannot operate: → [P.380](#)

Front cross traffic alert*

FCTA(Front cross traffic alert)

When approaching an intersection, etc., at a low speed, vehicles approaching from the left and right of the front of the vehicle can be detected and the driver informed of these vehicles.

FCTA system control

- When the system detects a vehicle approaching from the left or right in front of your vehicle when approaching an intersection, a notification will be displayed.
- When the system determines that your vehicle may be about to enter an intersection even though a vehicle is approaching from the left or right in front of your vehicle, a buzzer will sound and a message will be displayed to urge you to depress the brake pedal.

▶ Head-up display



▶ Multi-information display



⚠ WARNING

■ For safe use

Driving safely is solely the responsibility of the driver. Pay careful attention to the surrounding conditions in order to ensure safe driving. The FCTA system is a supplementary system that informs the driver of vehicles approaching from the left and right of the front of the vehicle. Over-reliance on this system may lead to an accident resulting in death or serious injury. The details of the warning display may differ from the actual traffic conditions. Although the warning display will stop being displayed after a certain amount of time, this does not necessarily indicate that there are no longer any vehicles or pedestrians around your vehicle.

*: If equipped

INFORMATION

■ FCTA system operating conditions

The system will operate when all of the following conditions are met:

- A shift position other than P or R is selected
- The vehicle speed is approximately 10 mph (15 km/h) or less
- A vehicle is approaching from the left or right in front of your vehicle at a speed between approximately 7 to 37 mph (10 to 60 km/h)
- There are no vehicles in front of your vehicle
- The accelerator pedal is not being strongly depressed
- The brake pedal is not being strongly depressed

■ Situations in which the system may operate even though no vehicles are approaching

In certain situations, such as the following, the system may operate even though no vehicles are approaching:

- When approaching objects on the roadside, such as guardrails, traffic signs, utility poles, street lights, trees, tall grass, walls, etc.
- When passing an object on the side of the road, such as a parked vehicle
- When a vehicle or pedestrian is approaching from the left or right in front of your vehicle in the distance
- When a vehicle or pedestrian is moving within a parking spot, etc., next to the lane your vehicle is in
- When a pedestrian or bicyclist is approaching on a sidewalk
- When a vehicle or pedestrian is moving away from your vehicle
- When an approaching vehicle is decelerating or stops
- When an approaching vehicle makes a left/right turn immediately in front of your vehicle
- When a pedestrian is approaching your vehicle
- When an oncoming vehicle makes a right/left turn
- When your vehicle enters an intersection before a vehicle approaching from the left or right in front of your vehicle
- When stopped at traffic light and a vehicle approaches from the left or right in front of your vehicle

- When making a left/right turn in front of an approaching vehicle
- When an oncoming vehicle approaches and passes
- When being overtaken by another vehicle
- When driving next to another vehicle or a pedestrian
- When a vehicle or pedestrian approaches the side of your vehicle

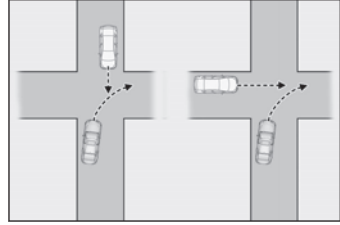

■ Situations in which the system may not operate properly

In situations such as the following, a vehicle may not be detected by a front side radar sensor and the system may not operate properly:

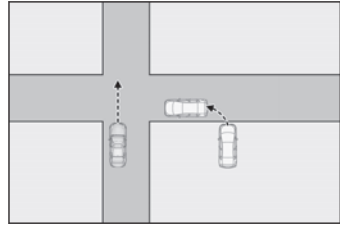

- If an approaching vehicle moves suddenly (sudden steering, acceleration, deceleration, etc.)
- If a vehicle is approaching from the left or right of the front of your vehicle diagonally
- When a vehicle is approaching from the left or right in front of your vehicle in the distance
- When there is an object between your vehicle and an approaching vehicle
- When several vehicles are approaching with little space between them
- Situations in which the sensors may not operate properly: → P.378
- Situations in which some or all of the functions of the system cannot operate: → P.380

Changing FCTA system settings

- The FCTA can be enabled/disabled through a customize setting. → P.774
- The following settings of the FCTA can be changed through customize settings. → P.774

Assistance in detecting vehicles behind when changing lanes

Related Links

[Customizable features\(P. 765\)](#)

Purpose of the Blind Spot Monitor

The Blind Spot Monitor is a system that uses rear side radar sensors installed on the inner side of the rear bumper on the left and right side to assist the driver in confirming safety when changing lanes.

WARNING

Cautions regarding the use of the system

The driver is solely responsible for safe driving. Always drive safely, taking care to observe your surroundings.

The Blind Spot Monitor is a supplementary function which alerts the driver that a vehicle is in a blind spot of the outside rear view mirrors or is approaching rapidly from behind into a blind spot. Do not overly rely on the Blind Spot Monitor. As the function cannot judge if it is safe to change lanes, over reliance could lead to an accident resulting in death or serious injury.

As the system may not function correctly under certain conditions, the driver's own visual confirmation of safety is necessary.

INFORMATION

Conditions under which the system will not detect a vehicle

The Blind Spot Monitor is not designed to detect the following types of vehicles and/or objects:

- Small motorcycles, bicycles, pedestrians, etc. *1
- Vehicles traveling in the opposite direction
- Guardrails, walls, signs, parked vehicles and similar stationary objects *1
- Following vehicles that are in the same lane *1
- Vehicles traveling 2 lanes away from your vehicle *1
- Vehicles which are being overtaken rapidly by your vehicle *1

*1: Depending on the conditions, detection of a vehicle and/or object may occur.

System components

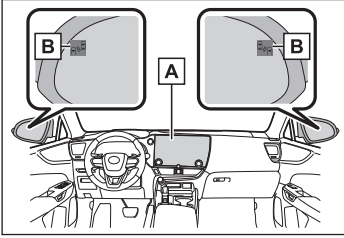

A Center display

Turning the Blind Spot Monitor on/off.

B Outside rear view mirror indicators

When a vehicle is detected in a blind spot of the outside rear view mirrors or approaching rapidly from behind into a blind spot, the outside rear view mirror indicator on the detected side will illuminate. If the turn signal lever is operated toward the detected side, the outside rear view mirror indicator flashes.

INFORMATION

Outside rear view mirror indicator visibility

In strong sunlight, the outside rear view mirror indicator may be difficult to see.

WARNING

To ensure the system can operate properly

Blind Spot Monitor sensors are installed behind the left and right sides of the rear bumper respectively. Observe the following to ensure the Blind Spot Monitor can operate correctly.

- Keep the sensors and the surrounding areas on the rear bumper clean at all times.

If a sensor or its surrounding area on the rear bumper is dirty or covered with snow, the Blind Spot Monitor may not operate and a warning message will be displayed. In this situation, clear off the dirt or snow and drive the vehicle with the operation conditions of the BSM function satisfied for approximately 10 minutes. If the warning message does not disappear, have the vehicle inspected by your Lexus dealer.

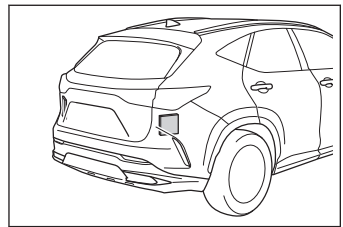

- Do not attach accessories, stickers (including transparent stickers), aluminum tape, etc., to a sensor or its surrounding area on the rear bumper.
- Do not subject a sensor or its surrounding area on the rear bumper to a strong impact.

If a sensor is moved even slightly off position, the system may malfunction and vehicles may not be detected correctly. In the following situations, have your vehicle inspected by your Lexus dealer.

⚠ WARNING

- A sensor or its surrounding area is subject to a strong impact.
- If the surrounding area of a sensor is scratched or dented, or part of them has become disconnected.
- Do not disassemble the sensor.
- Do not modify the sensor or surrounding area on the rear bumper.
- If a sensor or the rear bumper needs to be removed/installed or replaced, contact your Lexus dealer.
- Do not paint the rear bumper any color other than an official Lexus color.

Vehicles that can be detected by the Blind Spot Monitor

The Blind Spot Monitor uses rear side radar sensors to detect the following vehicles traveling in adjacent lanes and advises the driver of the presence of such vehicles via the indicators on the outside rear view mirrors.

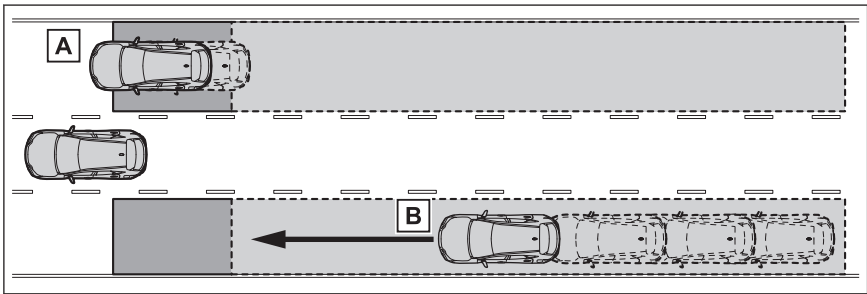

- A Vehicles that are traveling in areas that are not visible using the outside rear view mirrors (the blind spots)
- B Vehicles that are approaching rapidly from behind in areas that are not visible using the outside rear view mirrors (the blind spots)

The Blind Spot Monitor detection areas

The areas that vehicles can be detected in are outlined below.

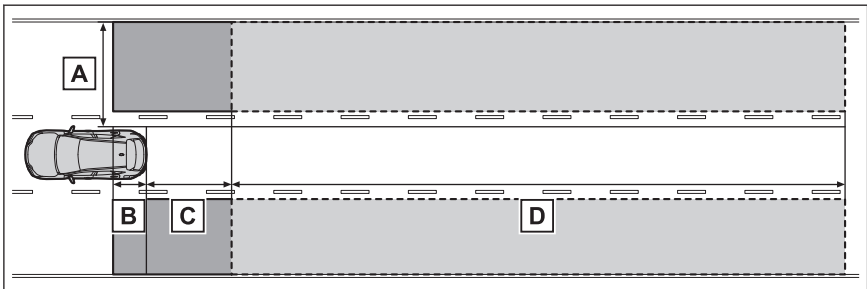

The range of each detection area is:

- A Approximately 1.6 ft. (0.5 m) to 11.5 ft. (3.5 m) from either side of the vehicle*²
- B Approximately 3.3 ft. (1 m) forward of the rear bumper
- C Approximately 9.8 ft. (3 m) from the rear bumper
- D Approximately 9.8 ft. (3 m) to 197 ft. (60 m) from the rear bumper*³

Turning the Blind Spot Monitor system ON/OFF

The Blind Spot Monitor system can be changed between ON and OFF on the center display.

- 1 Select .
- 2 Select [Driving assist].
- 3 Select [Blind spot monitor].

When the BSM function is disabled, the driving assist information indicator illuminates.

Each time the power switch is turned off then changed to ON, the Blind Spot Monitor will be enabled automatically.

INFORMATION

■ The Blind Spot Monitor is operational when

The Blind Spot Monitor is operational when all of the following conditions are met:

- The Blind Spot Monitor is on.
- The shift position is in a position other than R.
- The vehicle speed is greater than approximately 7 mph (10 km/h).

■ The Blind Spot Monitor will detect a vehicle when

The Blind Spot Monitor will detect a vehicle present in the detection area in the following situations:

- A vehicle in an adjacent lane overtakes your vehicle.
- You overtake a vehicle in an adjacent lane slowly.
- Another vehicle enters the detection area when it changes lanes.

■ Conditions under which the system may not function correctly

- The Blind Spot Monitor may not detect vehicles correctly in the following situations:

*2: The area between the side of the vehicle and 1.6 ft. (0.5 m) from the side of the vehicle cannot be detected.

*3: The greater the difference in speed between your vehicle and the detected vehicle is, the farther away the vehicle will be detected, causing the outside rear view mirror indicator to illuminate or flash.

6-2. Using the safe driving support functions

- When the sensor is misaligned due to a strong impact to the sensor or its surrounding area
- When mud, snow, ice, a sticker, etc., is covering the sensor or surrounding area on the rear bumper
- When driving on a road surface that is wet with standing water during bad weather, such as heavy rain, snow, or fog
- When multiple vehicles are approaching with only a small gap between each vehicle
- When the distance between your vehicle and a following vehicle is short
- When there is a significant difference in speed between your vehicle and the vehicle that enters the detection area
- When the difference in speed between your vehicle and another vehicle is changing
- When a vehicle enters a detection area traveling at about the same speed as your vehicle
- As your vehicle starts from a stop, a vehicle remains in the detection area
- When driving up and down consecutive steep inclines, such as hills, dips in the road, etc.
- When driving on roads with sharp bends, consecutive curves, or uneven surfaces
- When vehicle lanes are wide, or when driving on the edge of a lane, and the vehicle in an adjacent lane is far away from your vehicle
- When an accessory (such as a bicycle carrier) is installed to the rear of the vehicle
- When there is a significant difference in height between your vehicle and the vehicle that enters the detection area
- Immediately after the Blind Spot Monitor is turned on
- Instances of the Blind Spot Monitor unnecessarily detecting a vehicle and/or object may increase in the following situations:
 - When the sensor is misaligned due to a strong impact to the sensor or its surrounding area
 - When the distance between your vehicle and a guardrail, wall, etc., that enters the detection area is short
 - When driving up and down consecutive steep inclines, such as hills, dips in the road, etc.
 - When vehicle lanes are narrow, or when driving on the edge of a lane, and a vehicle traveling in a lane other than the adjacent lanes enters the detection area
 - When driving on roads with sharp bends, consecutive curves, or uneven surfaces
 - When the tires are slipping or spinning

- When the distance between your vehicle and a following vehicle is short
- When an accessory (such as a bicycle carrier) is installed to the rear of the vehicle

Supporting safe exit by detecting detectable objects at the rear of the vehicle by outputting sounds, displaying screens as a warning or cancelling opening of the doors

Related Links

[Customizable features\(P. 765\)](#)

Purpose of the Safe Exit Assist

The Safe Exit Assist (with door opening control) is a system that uses radar sensors installed on the inner side of the rear bumper to help occupants judge if an approaching vehicle or bicycle may collide with a door when opening it or cancel opening of a door, to reduce the possibility of a collision.

WARNING

Cautions regarding the use of the system

- The driver is solely responsible for safe driving. Always drive safely, taking care to observe your surroundings.
- Safe Exit Assist is a supplementary system that, when the vehicle is stopped, informs occupants of the existence of approaching vehicles and bicycles. As this system alone cannot be used to judge safety, over-reliance on this system may lead to an accident resulting in death or serious injury.

As the system may not function correctly under certain conditions, the driver's own visual confirmation of safety is necessary.

INFORMATION

Conditions under which the system will not detect a vehicle

- Safe Exit Assist does not detect the following objects, vehicles, and bicycles:
 - Vehicles or bicycles which are approaching slowly
 - Vehicles or bicycles which are determined to have a low possibility of colliding with a door (other than the back door) when opened
 - Vehicles or bicycles which are approaching from directly behind
 - Vehicles or bicycles which are approaching from the front
 - Guardrails, walls, signs, parked vehicles, and other stationary objects
 - Animals, etc.
- In situations such as the following, Safe Exit Assist will not operate:

- When 3 minutes or more have elapsed since the hybrid system was stopped (the time which operation is possible may be extended if a door is opened and closed)
- When your vehicle is not completely stopped

System components

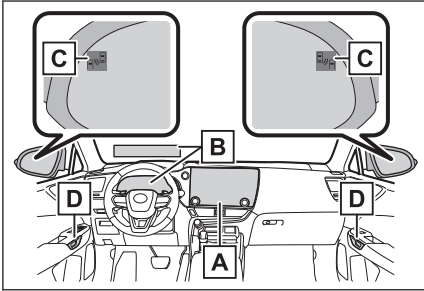

A Center display

Turning the Safe Exit Assist on/off. When opening of a door is canceled, the driver is informed through voice guidance that the system has operated.

B Multi-information display/Head-up display* /Buzzer

If collision with a door is likely and opening of the door is canceled, the door will be displayed on the multi-information display and head-up display. Also, if a door is opened when an outside rear view mirror indicator is illuminated, in addition to the above a buzzer will sound as a warning.

C Outside rear view mirror indicators

When a vehicle or bicycle which may collide with a door (other than the back door) when opened is detected, the outside rear view mirror indicator on the detected side will illuminate. If the door on the detected side is open, or opening of the door is canceled, the outside rear view mirror indicator will flash.

D Door opener switch (manual release handle)

If a door opener switch is operated to open a door while the outside rear view mirror indicator on that side is illuminated, opening of the door will be canceled.

INFORMATION

■ Outside rear view mirror indicator visibility

In strong sunlight, the outside rear view mirror indicator may be difficult to see.

■ Buzzer

If the volume setting of the audio system is high or the surrounding area is loud, it may be difficult to hear the buzzer.

*: If equipped

6-2. Using the safe driving support functions

■ Voice notifications

In the following situations, voice notifications will not be output:

- After opening a door and entering the vehicle, until the hybrid system is started
- When 3 minutes or more have elapsed since the hybrid system was stopped
- When the language setting of the center display has been set to a language that does not support voice notifications
- When all of the doors have been locked from outside the vehicle
- When a door remains open for 1 minute or more after the hybrid system is stopped
- When ACC mode has been enabled through a customize setting on the center display and the hybrid system has been stopped
- When the parking assist volume setting on the center display has been set to off

■ Opening of a door can be canceled when

Opening of a door can be canceled only when the inside door opener switch is pushed in. Opening of a door will not be able to be canceled when the outside door opener switch is used.

▲ WARNING

■ To ensure the system can operate properly

Safe Exit Assist sensors are installed behind the left and right sides of the rear bumper respectively. Observe the following to ensure the Safe Exit Assist can operate correctly.

- Keep the sensors and the surrounding areas on the rear bumper clean at all times.

If a sensor or its surrounding area on the rear bumper is dirty or covered with snow, the Safe Exit Assist may not operate and a warning message will be displayed. In this situation, clear off the dirt or snow and drive the vehicle with the operation conditions of the SEA function satisfied for approximately 10 minutes. If the warning message does not disappear, have the vehicle inspected by your Lexus dealer.

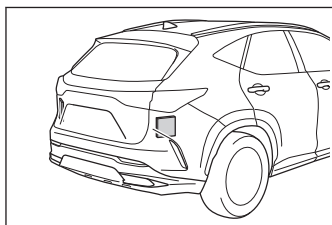

- Do not attach accessories, stickers (including transparent stickers), aluminum tape, etc., to a sensor or its surrounding area on the rear bumper.
- Do not subject a sensor or its surrounding area on the rear bumper to a strong impact.

⚠ WARNING

If a sensor is moved even slightly off position, the system may malfunction and vehicles may not be detected correctly. In the following situations, have your vehicle inspected by your Lexus dealer.

- A sensor or its surrounding area is subject to a strong impact.
- If the surrounding area of a sensor is scratched or dented, or part of them has become disconnected.
- Do not disassemble the sensor.
- Do not modify the sensor or surrounding area on the rear bumper.
- If a sensor or the rear bumper needs to be removed/installed or replaced, contact your Lexus dealer.
- Do not paint the rear bumper any color other than an official Lexus color.

Vehicles that can be detected by the Safe Exit Assist

When the Safe Exit Assist detects the following vehicles or bicycles using a rear side radar sensor, the occupants of the vehicle are informed through an outside rear view mirror indicator, buzzer, multi-information display, head-up display, and voice notification.

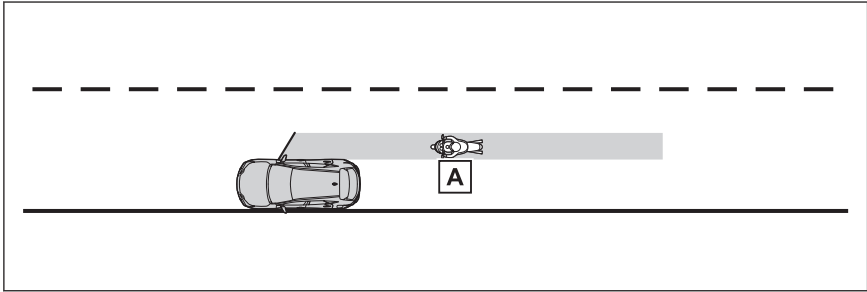

- A** A Vehicle or bicycle which has a high possibility of colliding with a door (other than the back door) when opened

The Safe Exit Assist detection areas

The areas that vehicles can be detected in are outlined below.

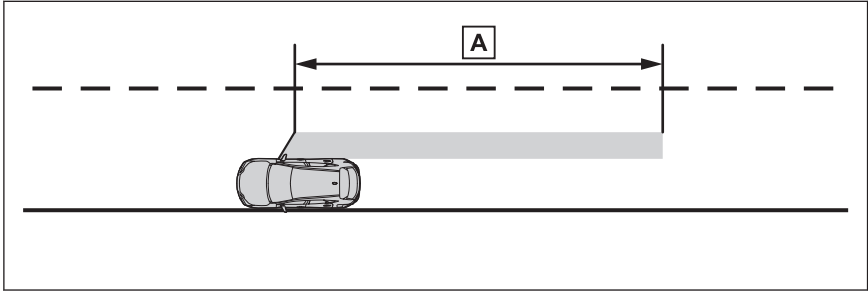

A Approximately 145 ft. (45 m) rearward from the front door*¹

Turning the Safe Exit Assist system ON/OFF

The Safe Exit Assist system can be changed between ON and OFF on the center display.

- 1 Select .
- 2 Select [Driving assist].
- 3 Select [Safe exit assist].

When the Safe Exit Assist function is disabled, the driving assist information indicator illuminates.

Each time the power switch is turned off then changed to ON, the Safe Exit Assist will be enabled automatically.

INFORMATION

■ The Safe Exit Assist is operational when

The Safe Exit Assist is operational when all of the following conditions are met:

- When the hybrid system is running, less than 3 minutes have elapsed since the hybrid system was stopped, or less than 3 minutes have elapsed since a door was opened and someone has entered the vehicle (the time which operation is possible may be extended if a door is opened and closed)
- Safe Exit Assist is on
- The vehicle is stopped.
- The shift position is in a position other than R.

■ The Safe Exit Assist will detect a vehicle when

The Safe Exit Assist will detect a vehicle present in the detection area in the following situations:

*1: The faster a vehicle or bicycle is approaching, the distance at which an outside rear view mirror indicator will illuminate or blink will become further.

When the vehicle is stopped and a vehicle or bicycle, which is traveling parallel to the vehicle, is approaching within the area that a door opens (other than the back door)

■ Opening the doors when opening is canceled by the system

Perform the following operation to open a door.

After the approaching vehicle or bicycle passes or changes direction, check the surrounding area and press the door opener switch again.

- Press and hold an inside door opener switch for approximately 3 seconds or more
→ P.425
- Press an inside door opener switch quickly 3 times or more
- Pull a manual release handle

■ Conditions under which the system may not function correctly

- The Safe Exit Assist may not detect vehicles correctly in the following situations:
 - When the sensor is misaligned due to a strong impact to the sensor or its surrounding area
 - When mud, snow, ice, a sticker, etc., is covering the sensor or surrounding area on the rear bumper
 - When driving on a road surface that is wet with standing water during bad weather, such as heavy rain, snow, or fog
 - When a vehicle or bicycle approaches from behind a nearby parked vehicle
 - When an approaching vehicle or bicycle suddenly changes direction
 - Immediately after a vehicle or bicycle starts moving
 - When the back door is open
 - When a bicycle carrier, ramp, or other accessory is installed to the back of the vehicle
 - When a parked vehicle, wall, sign, person or other stationary object is behind the vehicle
 - When the vehicle is stopped at an angle to the road
 - When a vehicle is traveling near an approaching vehicle or bicycle
 - When an approaching vehicle or bicycle is traveling along a stationary object, such as a wall or sign
 - When a vehicle or bicycle is approaching at high speed
 - When towing with the vehicle
 - When stopped on a steep slope
 - When stopped on a curve or at the exit of a curve

6-2. Using the safe driving support functions

- Instances of the Safe Exit Assist unnecessarily detecting a vehicle and/or object may increase in the following situations:
 - When the sensor is misaligned due to a strong impact to the sensor or its surrounding area
 - When a vehicle or bicycle approaches from behind your vehicle at an angle
 - When the vehicle is stopped at an angle to the road
 - When a vehicle or bicycle approaches from behind a parked vehicle at an angle
 - When a parked vehicle, wall, sign, person or other stationary object is behind the vehicle
 - When an approaching vehicle or bicycle suddenly changes direction
 - When an approaching vehicle or bicycle is traveling along a stationary object, such as a wall or sign
 - When the back door is open
 - When a bicycle carrier, ramp, or other accessory is installed to the back of the vehicle
 - When a vehicle or bicycle is approaching at high speed
 - When towing with the vehicle
 - When stopped on a steep slope
 - When stopped on a curve or at the exit of a curve

Buzzer and screen notifications when approaching an object at low speed*

Purpose of the intuitive parking assist

The distance from your vehicle to nearby obstacles when parallel parking or maneuvering into a garage is measured by the sensors and communicated via the displays and a buzzer. Always check the surrounding area when using this system.







WARNING

Cautions regarding the use of the system

There is a limit to the degree of recognition accuracy and control performance that this system can provide, do not overly rely on this system. The driver is always responsible for paying attention to the vehicle's surroundings and driving safely.



To ensure the system can operate properly

Observe the following precautions. Failing to do so may result in the vehicle being unable to be driven safely and possibly cause an accident.

-  Do not damage the sensors, and always keep them clean.
-  Do not attach a sticker or install an electronic component, such as a backlit license plate (especially fluorescent type), fog lights, fender pole or wireless antenna near a radar sensor.
-  Do not subject the surrounding area of the sensor to a strong impact. If subjected to an impact, have the vehicle inspected by your Lexus dealer. If the front or rear bumper needs to be removed/installed or replaced, contact your Lexus dealer.
-  Do not modify, disassemble or paint the sensors.
-  Do not attach a license plate cover.
-  Keep your tires properly inflated.

When to disable the function

In the following situations, disable the function as it may operate even though there is no possibility of a collision.

-  Failing to observe the warnings above.
-  A non-genuine Lexus suspension (lowered suspension, etc.) is installed.

INFORMATION

The intuitive parking assist can be operated when

-  The power switch is in ON.

*: If equipped

6-2. Using the safe driving support functions

- The intuitive parking assist is on.
- The vehicle speed is less than about 6 mph (10 km/h).
- A shift position other than P is selected.

■ Objects which the system may not be properly detected

The shape of the object may prevent the sensor from detecting it. Pay particular attention to the following objects:

- Wires, fences, ropes, etc.
 - Cotton, snow and other materials that absorb sound waves
 - Sharply-angled objects
 - Low objects
 - Tall objects with upper sections projecting outwards in the direction of your vehicle
- People may not be detected if they are wearing certain types of clothing.

■ Situations in which the system may not operate properly

Certain vehicle conditions and the surrounding environment may affect the ability of a sensor to correctly detect objects. Particular instances where this may occur are listed below.

- There is dirt, snow, water drops or ice on a sensor. (Cleaning the sensors will resolve this problem.)
- A sensor is frozen. (Thawing the area will resolve this problem.)

In especially cold weather, if a sensor is frozen the sensor display may be displayed abnormally, or objects, such as a wall, may not be detected.

- When a sensor or the area around a sensor is extremely hot or cold.

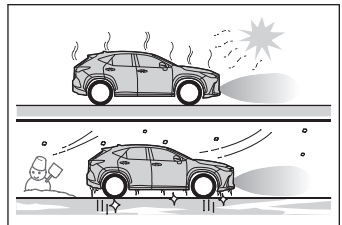

- On an extremely bumpy road, on an incline, on gravel, or on grass.
- When vehicle horns, vehicle detectors, motorcycle engines, air brakes of large vehicles, the clearance sonar of other vehicles or other devices which produce ultrasonic waves are near the vehicle
- A sensor is coated with a sheet of spray or heavy rain
- If objects draw too close to the sensor.
- When a pedestrian is wearing clothing that does not reflect ultrasonic waves (ex. skirts with gathers or frills).

- When objects that are not perpendicular to the ground, not perpendicular to the vehicle traveling direction, uneven, or waving are in the detection range.
- When strong winds are blowing
- When driving in inclement weather such as fog, snow or a sandstorm
- When an object that cannot be detected is between the vehicle and a detected object
- If an object such as a vehicle, motorcycle, bicycle or pedestrian cuts in front of the vehicle or runs out from the side of the vehicle
- If the orientation of a sensor has been changed due to a collision or other impact
- When equipment that may obstruct a sensor is installed, such as a towing eyelet, bumper protector (an additional trim strip, etc.), bicycle carrier, or snow plow
- If the front of the vehicle is raised or lowered due to the carried load
- If the vehicle cannot be driven in a stable manner, such as when the vehicle has been in an accident or is malfunctioning
- When a tire chains, compact spare tire or an emergency tire puncture repair kit is used

■ **Situations in which the system may operate even if there is no possibility of a collision**

In some situations, such as the following, the system may operate even though there is no possibility of a collision.

- When driving on a narrow road

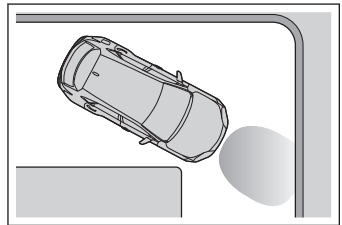

- When driving toward a banner, flag, low-hanging branch or boom barrier (such as those used at railroad crossings, toll gates and parking lots)
- When there is a rut or hole in the surface of the road
- When driving on a metal cover (grating), such as those used for drainage ditches
- When driving up or down a steep slope
- If a sensor is hit by a large amount of water, such as when driving on a flooded road
- There is dirt, snow, water drops or ice on a sensor. (Cleaning the sensors will resolve this problem.)
- A sensor is coated with a sheet of spray or heavy rain
- When driving in inclement weather such as fog, snow or a sandstorm

6-2. Using the safe driving support functions

- When strong winds are blowing

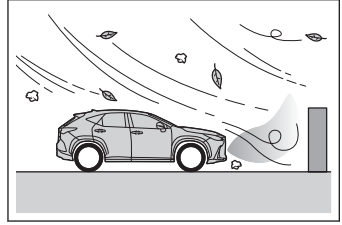

- When vehicle horns, vehicle detectors, motorcycle engines, air brakes of large vehicles, the clearance sonar of other vehicles or other devices which produce ultrasonic waves are near the vehicle
- If the front of the vehicle is raised or lowered due to the carried load
- If the orientation of a sensor has been changed due to a collision or other impact
- The vehicle is approaching a tall or curved curb
- Driving close to columns (H-shaped steel beams, etc.) in multi-story parking garages, construction sites, etc.
- If the vehicle cannot be driven in a stable manner, such as when the vehicle has been in an accident or is malfunctioning
- On an extremely bumpy road, on an incline, on gravel, or on grass

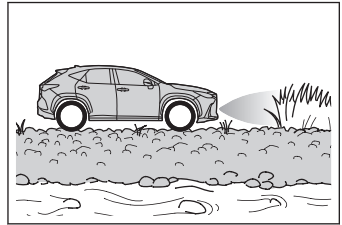

- When a tire chains, compact spare tire or an emergency tire puncture repair kit is used

■ Certification

► For vehicles sold in the U.S.A.

Product name : Intuitive parking assist

Compliance statement : This device complies with part 18 of the FCC Rules.

Responsible Party : DENSO International America, Inc.

24777 Denso Drive, P.O. Box 5047, Southfield,

Michigan 48033-5244, U.S.A.

<https://www.denso.com/us-ca/en/about-us/company-information/diam/>

► **For vehicles sold in Canada**

This ISM device complies with Canadian ICES-001.

Cet appareil ISM est conforme à la norme NMB-001 du Canada.

Intuitive parking assist display

When an object is detected by a sensor, the following displays inform the driver of the position and distance to the obstacle.

► **Lexus parking assist monitor ***

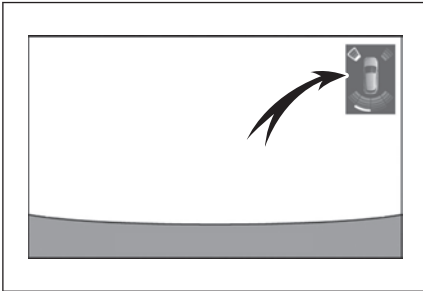

► **Panoramic view monitor ***



*: If equipped

Position of the sensors of the Intuitive assist sensor

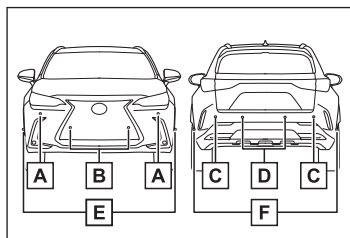

- A Front corner sensors
- B Front center sensors
- C Rear corner sensors
- D Rear center sensors
- E Front side sensors (vehicles with Advanced Park)
- F Rear side sensors (vehicles with Advanced Park)

▲ WARNING

■ Notes when washing the vehicle

Do not apply intensive bursts of water or steam to the sensor area.

Doing so may result in the sensor malfunctioning.

- When using a high pressure washer to wash the vehicle, do not spray the sensors directly, as doing so may cause a sensor to malfunction.
- When using steam to clean the vehicle, do not direct steam too close to the sensors, as doing so may cause a sensor to malfunction.

Turning the intuitive parking assist function ON/OFF

The intuitive parking assist can be enabled/disabled on the center display as follows:

- 1 Select .
- 2 Select [Driving assist].
- 3 Select [Intuitive parking assist] to change ON (enable)/OFF (disabled).

When ON (enable) is selected, the intuitive parking assist indicator comes on.

When turned OFF (disabled), the intuitive parking assist will be disabled and will not be enabled until the setting is changed to ON again in center display.

(The system will not be reenabled by operating the power switch.)

Detection range of the intuitive parking assist

■ Detection range of the sensors

▶ Vehicles without Advanced Park

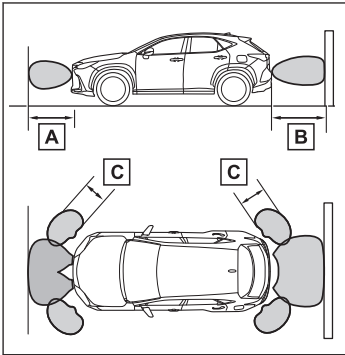

- A Approximately 3.3 ft. (100 cm)
- B Approximately 4.9 ft. (150 cm)
- C Approximately 2.0 ft. (60 cm)

▶ Vehicles with Advanced Park

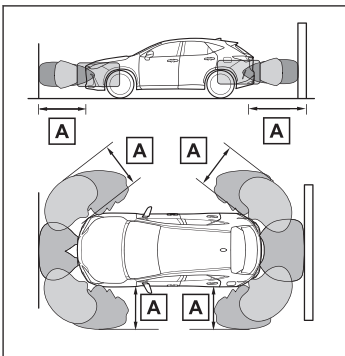

- A Approximately 6.6 ft. (200 cm)

The diagram shows the detection range of the sensors.

Note that the sensors cannot detect objects that are extremely close to the vehicle.

The range of the sensors may change depending on the shape of the object, etc.

□ INFORMATION

■ Sensor detection information

- The detection range of the sensors is limited to the areas around the vehicle's bumpers.
- Certain vehicle conditions and the surrounding environment may affect the ability of a sensor to correctly detect an object.
- Objects may not be detected if they are too close to the sensor.

6-2. Using the safe driving support functions

- There is a short delay between when an object is detected and when the display and buzzer operate. Even at slow speeds, there is a possibility that an object will come within the detection range before the display is shown and the buzzer sounds.
- It might be difficult to hear the buzzer due to the volume of the audio system or air flow noise of the air conditioning system.
- It may be difficult to hear the sound of this system due to the buzzers of other systems.

■ The distance and buzzer

▶ Vehicles without Advanced Park

Approximate distance to obstacle	Buzzer
Rear center sensor: Approximately 4.9 ft. (150 cm) to 2.0 ft. (60 cm) ⁽¹⁾ Front center sensor: Approximately 3.3 ft. (100 cm) to 2.0 ft. (60 cm) ⁽¹⁾	Slow
Approximately 2.0 ft. (60 cm) to 1.5 ft. (45 cm) ⁽¹⁾	Medium
Approximately 1.5 ft. (45 cm) to 1.0 ft. (30 cm) ⁽¹⁾	Fast
Less than approximately 1.0 ft. (30 cm), Less than approximately 0.5 ft. (15 cm) ⁽¹⁾	Continuous

(1) Automatic buzzer mute function is enabled.

▶ Vehicles with Advanced Park

Approximate distance to obstacle	Buzzer
Rear center sensor: Approximately 6.6 ft. (200 cm) to 4.9 ft. (150 cm) Front center sensor: Approximately 6.6 ft. (200 cm) to 3.3 ft. (100 cm) Side sensor: Approximately 6.6 ft. (200 cm) to 5.4 ft. (165 cm) Corner sensor: Approximately 6.6 ft. (200 cm) to 2.0 ft. (60 cm)	Does not sound (Display only)

Approximate distance to obstacle	Buzzer
Rear center sensor: Approximately 4.9 ft. (150 cm) to 2.0 ft. (60 cm) ⁽¹⁾ Front center sensor: Approximately 3.3 ft. (100 cm) to 2.0 ft. (60 cm) ⁽¹⁾ Side sensor: Approximately 5.4 ft. (165 cm) to 2.0 ft. (60 cm) ⁽¹⁾	Slow
Approximately 2.0 ft. (60 cm) to 1.5 ft. (45 cm) ⁽¹⁾ Side sensor: Approximately 2.0 ft. (60 cm) to 1.3 ft. (40 cm) ⁽¹⁾	Medium
Approximately 1.5 ft. (45 cm) to 1.0 ft. (30 cm) ⁽¹⁾ Side sensor: Approximately 1.3 ft. (40 cm) to 1.0 ft. (30 cm) ⁽¹⁾	Fast
Less than approximately 1.0 ft. (30 cm), Less than approximately 0.5 ft. (15 cm) ⁽¹⁾	Continuous

(1) Automatic buzzer mute function is enabled.

Intuitive parking assist buzzer operation and range

A buzzer sounds when objects are detected.

- A buzzer sounds when the sensors are operating.
- The buzzer beeps faster as the vehicle approaches an object. When the vehicle comes within the approximately 1.0 ft. (30 cm) of the object, the buzzer will sound continuously.
- When 2 or more sensors simultaneously detect a static object, the buzzer sounds for the nearest object.
- Even when the sensors are operating, the buzzer will be muted in some situations. (automatic buzzer mute function)

Changing the intuitive parking assist buzzer volume

The buzzer volume can be adjusted on the center display.

- 1 Select .
- 2 Select [Driving assist].

6-2. Using the safe driving support functions

3 Select [Collision mitigation].

4 Select [Parking assist volume].

Temporarily muting the intuitive parking assist buzzer

A mute button will be displayed on the center display when an object is detected.

To mute the buzzer, select .

To mute the buzzer, select . The buzzers for the intuitive parking assist sensor, RCTA and RCD function will be muted simultaneously.

Mute will be canceled automatically in the following situations:

- When the shift position is changed.
- When the vehicle speed exceeds a certain speed.
- When there is a malfunction in a sensor or the system is temporarily unavailable.
- When the operating function is disabled manually.
- When the power switch is turned off.

Intuitive parking assist object warning function (vehicles with Advanced Park)

The object warning function informs the driver of the existence of objects along the side of the vehicle, using a display and buzzer, if the objects are within the estimated path of the vehicle.

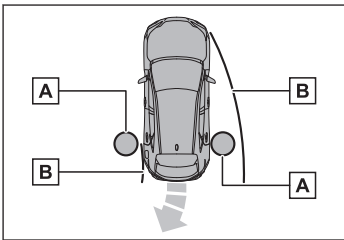

 Object

 Calculated vehicle route

When the vehicle is moving, the side sensors or side cameras can detect objects. While the vehicle is moving, if a detected object can no longer be detected by the side sensors or side cameras, the location of the object relative to the vehicle is estimated. If the object is determined to be in the estimated path of the vehicle, the object warning function will operate.

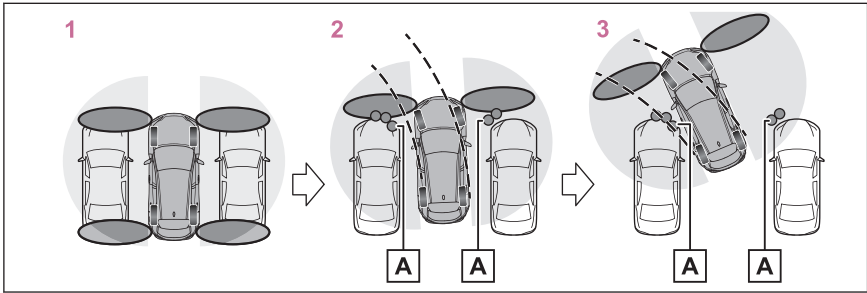

A Object detected by side sensors or side cameras

- 1 The vehicle is stopped and objects along the sides of the vehicle are not detected.
- 2 Objects are detected as the vehicle is moving.
- 3 Even though the objects are outside of the detection area of the side sensors or side cameras, a warning is displayed and a buzzer sounds.

INFORMATION

Object warning function operating conditions

- The vehicle moves about 23.0 ft. (7 m) after the hybrid system is started.
- The R shift position is selected.
- After the D shift position has been selected, the vehicle has moved 23.0 ft. (7 m) or less.
- Panoramic view main switch has been pressed and the center display is displayed.
- The front or rear sensor detects a stationary object.

Detection of objects along the sides of the vehicle

- Objects along the sides of the vehicle are not instantaneously detected. The location of objects in relation to the vehicle is estimated after they are first detected by the front or rear side sensors, or side cameras. Therefore, after the power switch is changed to ON, even if an object is along the side of the vehicle, it may not be detected until the vehicle has been driven a small amount and the side sensors or side cameras completely scan the areas along the sides of the vehicle.
- If a vehicle, person, animal, etc., is detected by a side sensors or side cameras, but then leaves the detection area of the side sensors or side cameras, the system will assume the object has not moved.

⚠ WARNING

■ Side sensors and side cameras

In situations such as the following, the function may not operate correctly, possibly leading to an accident. Proceed carefully.

- When starting off shortly after the power switch is turned to ON and a small vehicle or other object which cannot be detected by a front side sensor is next to the vehicle.

In the situation shown in the following illustration, even if the vehicle starts off, the vehicle on the left will not be detected and the object warning function will not operate.

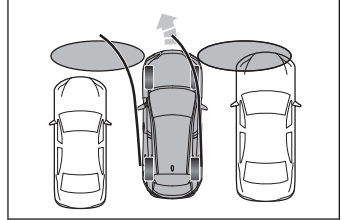

- When an object or person is in a position which cannot be detected by the side sensors or side cameras.
- When, after the side sensors have completed scanning the areas along the sides of the vehicle, a vehicle, person, or other object approaches the side of the vehicle and cannot be detected.
- When the outside rear view mirror is closed, the side sensors or side cameras cannot detect objects.
- If the 12-volt battery was discharged or has been removed and installed, fold and extend the outside rear view mirrors.

Buzzer and screen notifications when traveling at a low speed and an approaching vehicle is detected at the rear

Purpose of the RCTA (Rear cross traffic alert) function

The RCTA function uses the BSM rear side radar sensors installed behind the rear bumper. This function is intended to assist the driver in checking areas that are not easily visible when backing up.

⚠ WARNING

■ Cautions regarding the use of the system

There is a limit to the degree of recognition accuracy and control performance that this system can provide, do not overly rely on this system. The driver is always responsible for paying attention to the vehicle's surroundings and driving safely.

📄 INFORMATION

■ The RCTA function is operational when

The RCTA function operates when all of the following conditions are met:

- The power switch is in ON.
- The shift position is in R.
- The vehicle speed is approximately 9 mph (15 km/h) or less.
- The approaching vehicle speed is between approximately 5 mph (8 km/h) and 35 mph (56 km/h).

■ Conditions under which the system will not detect a vehicle

The RCTA function is not designed to detect the following types of vehicles and/or objects:

- Vehicles approaching from directly behind
- Vehicles backing up in a parking space next to your vehicle
- Vehicles that the sensors cannot detect due to obstructions

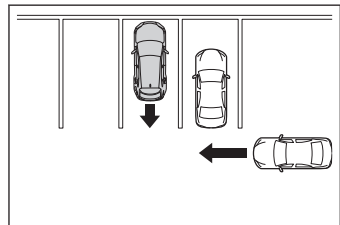

- Guardrails, walls, signs, parked vehicles and similar stationary objects^{*1}

6-2. Using the safe driving support functions

- Small motorcycles, bicycles, pedestrians, etc.*1
- Vehicles moving away from your vehicle
- Vehicles approaching from the parking spaces next to your vehicle*1
- The distance between the sensor and approaching vehicle gets too close

■ Situations in which the system may not operate properly

The RCTA function may not detect vehicles correctly in the following situations:

- When the sensor is misaligned due to a strong impact to the sensor or its surrounding area
- When mud, snow, ice, a sticker, etc., is covering the sensor or surrounding area on the position above the rear bumper
- When driving on a road surface that is wet with standing water during bad weather, such as heavy rain, snow, or fog
- When multiple vehicles are approaching with only a small gap between each vehicle
- When a vehicle is approaching at high speed
- When equipment that may obstruct a sensor is installed, such as a towing eyelet, bumper protector (an additional trim strip, etc.), bicycle carrier, or snow plow
- When backing up on a slope with a sharp change in grade

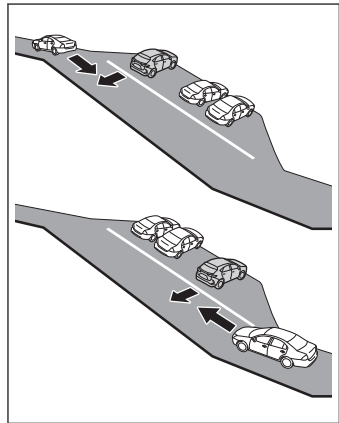

- When backing out of a sharp angle parking spot

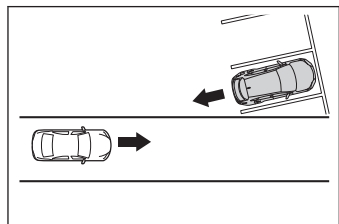

*1: Depending on the conditions, detection of a vehicle and/or object may occur.

- When towing a trailer
- When there is a significant difference in height between your vehicle and the vehicle that enters the detection area
- When a sensor or the area around a sensor is extremely hot or cold.
- If the suspension has been modified or tires of a size other than specified are installed
- If the front of the vehicle is raised or lowered due to the carried load
- When turning while backing up

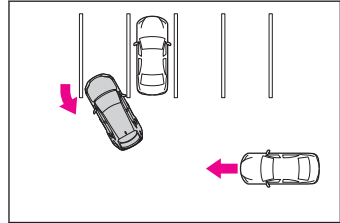

- When a vehicle turns into the detection area

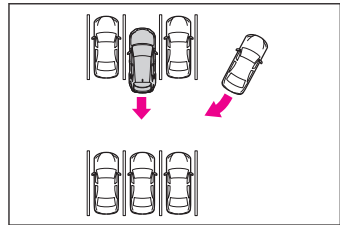

■ Situations in which the system may operate even if there is no possibility of a collision

Instances of the RCTA function unnecessary detecting a vehicle and/or object may increase in the following situations:

- When the parking space faces a street and vehicles are being driven on the street

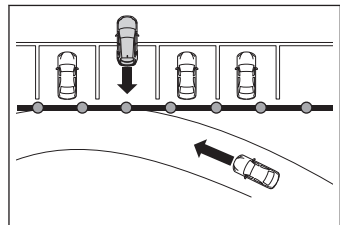

6-2. Using the safe driving support functions

- When the distance between your vehicle and metal objects, such as a guardrail, wall, sign, or parked vehicle, which may reflect electrical waves toward the rear of the vehicle, is short

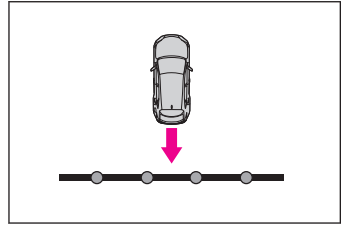

- When equipment that may obstruct a sensor is installed, such as a towing eyelet, bumper protector (an additional trim strip, etc.), bicycle carrier, or snow plow
- When a vehicle passes by the side of your vehicle

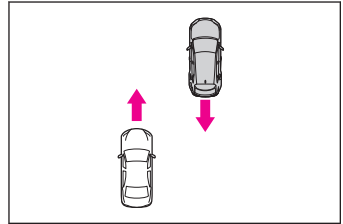

- When a detected vehicle turns while approaching the vehicle

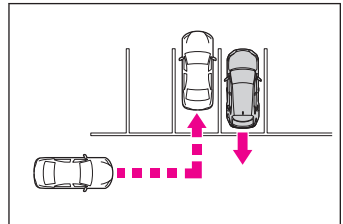

- When there are spinning objects near your vehicle such as the fan of an air conditioning unit
- When water is splashed or sprayed toward the rear bumper, such as from a sprinkler
- Moving objects (flags, exhaust fumes, large rain droplets or snowflakes, rain water on the road surface, etc.)
- When the distance between your vehicle and a guardrail, wall, etc., that enters the detection area is short
- Gratings and gutters
- When a sensor or the area around a sensor is extremely hot or cold.
- If the suspension has been modified or tires of a size other than specified are installed
- If the front of the vehicle is raised or lowered due to the carried load

System components

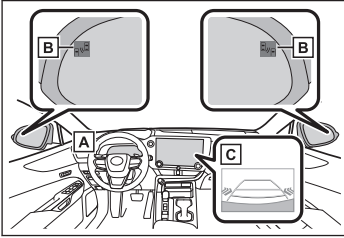

A Meter

If a vehicle approaching from the right or left at the rear of the vehicle is detected, a buzzer will sound.

B Outside rear view mirror indicators

When a vehicle approaching from the right or left at the rear of the vehicle is detected, both outside rear view mirror indicators will flash.

C Center display

If a vehicle approaching from the right or left at the rear of the vehicle is detected, the RCTA icon for the detected side will be displayed on the center display. Turning the RCTA function on/off on the center display.

This illustration shows an example of a vehicle approaching from both sides of the vehicle.

INFORMATION

■ Outside rear view mirror indicator visibility

In strong sunlight, the outside rear view mirror indicator may be difficult to see.

■ Hearing the RCTA buzzer

The RCTA buzzer may be difficult to hear over loud noises, such as if the audio system volume is high.

■ Rear side radar sensors

→ P.419

RCTA function

The RCTA function is operational when

The RCTA function uses rear side radar sensors to detect vehicles approaching from the right or left at the rear of the vehicle and alerts the driver of the presence of such vehicles by flashing the outside rear view mirror indicators and sounding a buzzer.

6-2. Using the safe driving support functions

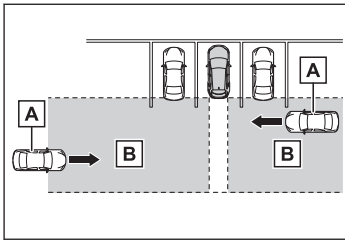

- A Approaching vehicles
- B Detection areas of approaching vehicles

RCTA icon display

When a vehicle approaching from the right or left at the rear of the vehicle is detected, the following will be displayed on the center display.

Example: Vehicles are approaching from both sides of the vehicle (Example: Vehicles with a Lexus parking assist monitor)

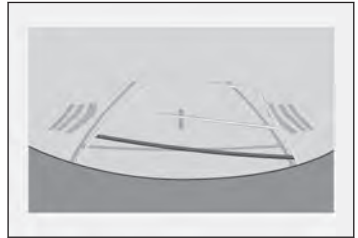

RCTA function detection areas

The areas that vehicles can be detected in are outlined below.

The buzzer can alert the driver of faster vehicles approaching from farther away.

Example:

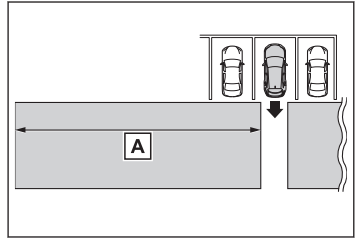

- Approaching vehicle speed: 35 mph (56 km/h) (fast)

A Approximate alert distance: 66 ft. (20 m)

- Approaching vehicle speed: 5 mph (8 km/h) (slow)

A Approximate alert distance: 18 ft. (5.5 m)

Changing the RCTA settings

Turning the RCTA function ON/OFF

The RCTA function can be enabled/disabled on the center display as follows:

- 1 Select .
- 2 Select [Driving assist].
- 3 Select [Rear cross traffic alert].

When the RCTA function is disabled, the driving assist information indicator illuminates on the multi-information display.

(Each time the power switch is turned off then changed to ON, the RCTA function will be enabled automatically.)



Changing the RCTA buzzer volume

The buzzer volume can be adjusted on the center display.

- 1 Select .
- 2 Select [Driving assist].
- 3 Select [Collision mitigation].
- 4 Select [Parking assist volume].

Temporarily muting the RCTA buzzer

A mute button will be displayed on the center display when an object is detected.

To mute the buzzer, select . To mute the buzzer, select . The buzzers for the intuitive parking assist sensor, RCTA and RCD function will be muted simultaneously.

INFORMATION

Mute will be canceled automatically in the following situations:

- When the shift position is changed.
- When the vehicle speed exceeds a certain speed.
- When there is a malfunction in a sensor or the system is temporarily unavailable.
- When the operating function is disabled manually.
- When the power switch is turned off.

Buzzer and screen notifications when traveling at a low speed and a pedestrian is detected at the rear*

Purpose of the RCD (Rear Camera Detection)

When the vehicle is backing up, the rear camera detection function can detect pedestrians in the detection area behind the vehicle. If a pedestrian is detected, a buzzer will sound and an icon will be displayed on the center display to inform the driver of the pedestrian.

WARNING









Cautions regarding the use of the system

The recognition and control capabilities for this system are limited.

The driver should always drive safely by always being responsible without over relying on the system and have a understanding of the surrounding situations.



To ensure the system can operate properly

Observe the following, otherwise there is the danger that could lead to an accident.

-  Always clean the camera with damaging it.
-  Do not install market electronic parts (such as illuminated license plate, fog lamps, etc.) in the camera vicinity.
-  Do not subject the camera vicinity to strong impacts. If the vicinity is subjected to a strong impact, have the vehicle inspected by your Lexus dealer.
-  Do not disassemble, remodel or paint the camera.
-  Do not attach accessories or stickers to the camera.
-  Do not install market protection parts (bumper trim, etc.) to the rear bumper.
-  Maintain suitable tire air pressure.
-  Make sure the back door is completely closed.

RCD function is turned off

In the following situations the system turns off. The RCD function may not operate properly and thus there is the danger that an accident may occur.

-  The contents mentioned above are not observed.
-  Suspensions other than Lexus genuine parts are installed.

*: If equipped

INFORMATION

■ The rear camera detection function is operational when

- The power switch is in ON.
- RCD function is on.
- The shift position is in R.
- Advanced Park is not operating

■ Situations in which the system may not operate properly

- Some pedestrians, such as the following, may not be detected by the rear camera detection function, preventing the function from operating properly:
 - Pedestrians who are bending forward or squatting
 - Pedestrians who are lying down
 - Pedestrians who are running
 - Pedestrians who suddenly enter the detection area
 - People riding a bicycle, skateboard, or other light vehicle
 - Pedestrians wearing oversized clothing such as a rain coat, long skirt, etc., making their silhouette obscure
 - Pedestrians whose body is partially hidden by an object, such as a cart or umbrella
 - Pedestrians which are obscured by darkness, such as at night
- In some situations, such as the following, pedestrians may not be detected by the rear camera detection function, preventing the function from operating properly:
 - When backing up in inclement weather (rain, snow, fog, etc.)
 - When the rear camera is obscured (dirt, snow, ice, etc. are attached) or scratched
 - When a very bright light, such as the sun, or the headlights of another vehicle, shines directly into the rear camera
 - When backing up in a place where the surrounding brightness changes suddenly, such as at the entrance or exit of a garage or underground parking lot
 - When backing up in a dim environment such as during dusk or in an underground parking lot
 - When the camera position and direction are deviated
 - When a towing hook is attached
 - When water droplets are flowing on the camera lens
 - When the rear washer is operating
 - When the vehicle height is extremely changed (nose up, nose down)
 - When tire chains or an emergency tire puncture repair kit is used

6-2. Using the safe driving support functions

- If the suspension has been modified or tires of a size other than specified are installed
- When install market electronic parts (such as illuminated license plate, fog lamps, etc.) in the camera vicinity
- When install market protection parts (bumper trim, etc.) to the rear bumper

■ Situations in which the system may operate unexpectedly

- Even though there are no pedestrians in the detection area, some objects, such as the following, may be detected, possibly causing the rear camera detection function to operate.
 - Three dimensional objects, such as a pole, traffic cone, fence, or parked vehicle
 - Moving objects, such as a car or motorcycle
 - Objects moving toward your vehicle when backing up, such as flags or puddles (or airborne matter, such as smoke, steam, rain, or snow)
 - Cobblestone or gravel roads, tram rails, road repairs, white lines, pedestrian crossings or fallen leaves on the road
 - Metal covers (gratings), such as those used for drainage ditches
 - Objects reflected in a puddle or on a wet road surface
 - Shadows on the road
- In some situations, such as the following, the rear camera detection function may operate even though there are no pedestrians in the detection area.
 - When backing up toward the roadside or a bump on the road
 - When backing up toward an incline/decline
 - If the rear of the vehicle is raised or lowered due to the carried load
 - If a bumper protector, such as an additional trim strip, is installed to the rear bumper
 - If the orientation of the rear camera has been changed
 - If a towing eyelet is installed to the rear of the vehicle
 - When water is flowing over the rear camera lens
 - When the rear camera is obscured (dirt, snow, ice, etc., are attached) or scratched
 - If there is a flashing light in the detection area, such as the emergency flashers of another vehicle
 - When a tire chains or an emergency tire puncture repair kit is used
- Situations in which the rear camera detection function may be difficult to notice
 - The buzzer may be difficult to hear if the surrounding area is noisy, the volume of the audio system volume is high, the air conditioning system is being used, etc.

- If the temperature in the cabin is extremely high or low, the audio system screen may not operate correctly.

RCD function

Center Display

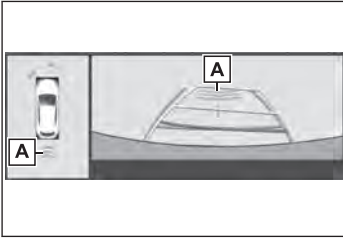

A Pedestrian detection icon

Displayed automatically when a pedestrian is detected.

(Each time the power switch is turned off then changed to ON, the RCD function will be enabled automatically.)

When a pedestrian is detected

If the rear camera detection function detects a pedestrian in the detection area, the buzzer and pedestrian detection will operate as follows:

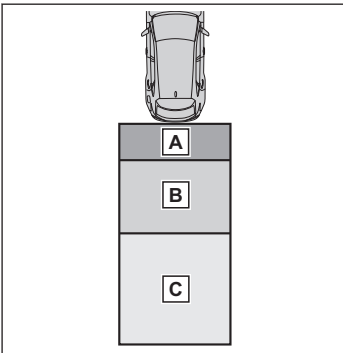

A If a pedestrian is detected in area **A**

Buzzer: Sounds repeatedly

Pedestrian detection icon: Blinks

B If a pedestrian is detected in area **B**

Buzzer (When the vehicle is stationary):
Sounds 3 times

Buzzer (When the vehicle is backing up,
when a pedestrian approaches the rear of
the vehicle): Sounds repeatedly

Pedestrian detection icon: Blinks

C If the system determines that your vehicle may collide with a pedestrian in area **C**

Buzzer: Sounds repeatedly

Pedestrian detection icon: Blinks

Changing the RCD settings

Turning the RCD function ON/OFF

The RCD function can be enabled/disabled on the center display as follows:

- 1 Select .
- 2 Select [Driving assist].
- 3 Select [Rear camera detection].

When the RCD function is disabled, the driving assist information indicator illuminates on the multi-information display.



Changing the RCD buzzer volume

The buzzer volume can be adjusted on the center display.

- 1 Select .
- 2 Select [Driving assist].
- 3 Select [Collision mitigation].
- 4 Select [Parking assist volume].

Temporarily muting the RCD buzzer

A mute button will be displayed on the center display when an object is detected.

To mute the buzzer, select . To mute the buzzer, select . The buzzers for the intuitive parking assist sensor, RCTA and RCD function will be muted simultaneously.

INFORMATION

Mute will be canceled automatically in the following situations:

- When the shift position is changed.
- When the vehicle speed exceeds a certain speed.
- When there is a malfunction in a sensor or the system is temporarily unavailable.
- When the operating function is disabled manually.
- When the power switch is turned off.

Brake operation when an object is detected while approaching at low speed*

Purpose of the PKSB (Parking Support Brake) system*

The PKSB (Parking Support Brake) system consists of the following functions that operate when driving at a low speed or backing up, such as when parking. When the system determines that the probability of a collision with a detected object is high, a warning operates to urge the driver to take evasive action.

■ Parking assist function

The system can detect the following as detectable objects. (Detectable objects differ depending on the function.)

- Static Objects Front and Rear of the vehicle
- Moving Vehicles Rear of the Vehicle
- Pedestrians Rear of the Vehicle
- Static Objects Around the vehicle (vehicles with Advanced Park)*

PKSB (Parking Support Brake) system

▲ WARNING

■ Cautions regarding the use of the system

Do not overly rely on the system, as doing so may lead to an accident. Always drive while checking the safety of the surroundings of the vehicle.

Depending on the vehicle and road conditions, weather, etc., the system may not operate. The detection capabilities of sensors and radars are limited. Always drive while checking the safety of the surroundings of the vehicle.

- The driver is solely responsible for safe driving. Always drive carefully, taking care to observe your surroundings. The PKSB (Parking Support Brake) system is designed to provide support to lessen the severity of collisions. However, it may not operate in some situations.
- The PKSB (Parking Support Brake) system is not designed to stop the vehicle completely. Additionally, even if the system has stopped the vehicle, it is necessary to depress the brake pedal immediately as brake control will be canceled after approximately 2 seconds.
- It is extremely dangerous to check the system operations by intentionally driving the vehicle into the direction of a wall, etc. Never attempt such actions.

*: If equipped

▲ WARNING

■ When to disable the PKSB (Parking Support Brake) system

In the following situations, disable the PKSB (Parking Support Brake) as the system may operate even though there is no possibility of a collision.

- When inspecting the vehicle using a chassis roller, chassis dynamo or free roller
- When loading the vehicle onto a boat, truck or other transport vessel
- If the suspension has been modified or tires of a size other than specified are installed
- If the front of the vehicle is raised or lowered due to the carried load
- When equipment that may obstruct a sensor is installed, such as a towing eyelet, bumper protector (an additional trim strip, etc.), bicycle carrier, or snow plow
- When using automatic car washing devices
- If the vehicle cannot be driven in a stable manner, such as when the vehicle has been in an accident or is malfunctioning
- When the vehicle is driven in a sporty manner or off-road
- When the tires are not properly inflated
- When the tires are very worn
- When a tire chains, compact spare tire or an emergency tire puncture repair kit is used

■ Precautions for the suspension

Do not modify the suspension of the vehicle. If the height or tilt of the vehicle is changed, the sensors may not be able to detect detectable objects and the system may not operate correctly, possibly leading to an accident.

■ System overview

If the PKSB (Parking Support Brake) determines that a collision with a detected object or pedestrian is possible, the hybrid system output will be restricted to restrain any increase in the vehicle speed. (Hybrid system output restriction control: See figure 2.) Additionally, if the accelerator pedal continues to be depressed, the brakes will be applied automatically to reduce the vehicle speed. (Brake control: See figure 3.)

- Figure 1 When the PKSB (Parking Support Brake) is not operating

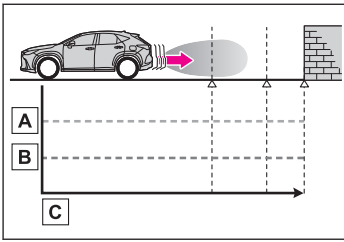

- A Hybrid system output
- B Braking force
- C Time

● Figure 2 When hybrid system output restriction control operates

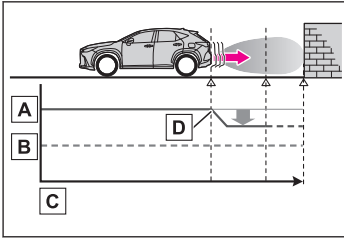

- A Hybrid system output
- B Braking force
- C Time
- D Hybrid system output restriction control begins operating (System determines that possibility of collision with detected object is high)

● Figure 3 When hybrid system restriction control and brake control operates

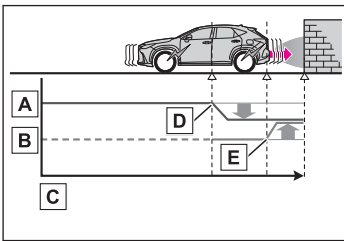

- A Hybrid system output
- B Braking force
- C Time
- D Hybrid system output restriction control begins operating (System determines that possibility of collision with detected object is high)
- E Brake control begins operating (System determines that possibility of collision with detected object is extremely high)

INFORMATION

■ If the PKSB (Parking Support Brake) system has operated

If the vehicle is stopped due to operation of the PKSB (Parking Support Brake), the PKSB (Parking Support Brake) will be disabled and the driving assist information indicator will illuminate.

If the PKSB (Parking Support Brake) system operates unnecessarily, brake control can be canceled by depressing the brake pedal or waiting approximately 2 seconds for it to automatically be canceled. Then, the vehicle can be operated by depressing the accelerator pedal.

■ Re-enabling the PKSB (Parking Support Brake) system

To re-enable the PKSB (Parking Support Brake) when it is disabled due to operation of the PKSB (Parking Support Brake), either enable the system again, or turn the power switch off and then back to ON.

Additionally, if any of the following conditions are met, the system will be re-enabled automatically and the driving assist information indicator will turn off:

- The P shift position is selected
- The object is no longer detected in the traveling direction of the vehicle
- The traveling direction of the vehicle changes*¹

■ Turning the PKSB (Parking Support Brake) system ON/OFF

The PKSB (Parking Support Brake) system can be changed between ON (enabled) and OFF (disabled) on the center display.

- 1 Select .
- 2 Select [Driving assist].
- 3 Select [Parking support brake] to change ON (enable)/OFF (disabled).

When the PKSB (Parking Support Brake) is disabled, the driving assist information indicator illuminates.

When turned OFF (disabled), the PKSB (Parking Support Brake) will be disabled and will not be enabled until the setting is changed to ON again in center display.

(The function will not be re-enabled by operating the power switch.)

■ PKSB (Parking Support Brake) function displays and buzzers

When the hybrid system output restriction control or brake control operates, a buzzer sounds and a message is displayed on the multi-information display, head-up display* and center display to alert the driver.

Depending on the situation, output restriction control operates to either limit acceleration or restrict output as much as possible.

■ Hybrid system output restriction control is operating (acceleration restriction)

- Acceleration greater than a certain amount is restricted by the system.
- Multi-information display: "Object Detected Acceleration Reduced"
- Head-up display*: "Object Detected Acceleration Reduced"

*1: Except when the Pedestrians Rear of the Vehicle operated.

*: If equipped

- Center display: No warning displayed
- Driving assist information indicator: Not illuminated
- Buzzer: Does not sound
- **Hybrid system output restriction control is operating (output restricted as much as possible)**
- The system has determined that stronger-than-normal brake operation is necessary.
- Multi-information display and head-up display*: "BRAKEI"
- Center display: "BRAKEI"
- Driving assist information indicator: Not illuminated
- Buzzer: Short beep
- **Brake control is operating**
- The system determined that emergency braking is necessary.
- Multi-information display and head-up display*: "BRAKEI"
- Center display: "BRAKEI"
- Driving assist information indicator: Not illuminated
- Buzzer: Short beep
- **Vehicle stopped by system operation**
- The vehicle has been stopped by brake control operation.
- Multi-information display: "Accelerator Pedal is Pressed Press Brake Pedal" (If the accelerator pedal is not depressed, "Press Brake Pedal" will be displayed.)
- Head-up display*: "Accelerator Pedal is Pressed Press Brake Pedal" (If the accelerator pedal is not depressed, "Press Brake Pedal" will be displayed.)
- Center display: "Press Brake Pedal"
- Driving assist information indicator: Illuminated
- Buzzer: Sounds repeatedly

Static Objects Front and Rear of the vehicle *

If the sensors detect a static object, such as a wall, in the travelling direction of the vehicle and the system determines that a collision may occur due to the vehicle suddenly moving forward due to an accidental accelerator pedal operation, the vehicle moving the unintended direction due to the wrong shift position, or while

*: If equipped

6-2. Using the safe driving support functions

parking or traveling at low speeds, the system will operate to lessen the impact with the detected static object and reduce the resulting damage.

INFORMATION

■ The system will operate when

The function will operate when the driving assist information indicator is not illuminated or flashing and all of the following conditions are met:

- Hybrid system output restriction control
 - PKSB (Parking Support Brake) system is enabled.
 - The vehicle speed is approximately 9 mph (15 km/h) or less.
 - There is a static object in the traveling direction of the vehicle (approximately 6 to 13 ft. [2 to 4 m] ahead).
 - The Parking Support Brake determines that a stronger-than-normal brake operation is necessary to avoid a collision.
- Brake control
 - Hybrid system output restriction control
 - The Parking Support Brake determines that an immediate brake operation is necessary to avoid a collision.

■ The system will stop operating when

The function will stop operating if any of the following conditions are met:

- Hybrid system output restriction control
 - PKSB (Parking Support Brake) system is disabled.
 - The system determines that the collision has become avoidable with normal brake operation.
 - The static object is no longer in the traveling direction of the vehicle or approximately 6 to 13 ft. (2 to 4 m) away from the vehicle.
- Brake control
 - PKSB (Parking Support Brake) system is disabled.
 - Approximately 2 seconds have elapsed since the vehicle was stopped by brake control.
 - The brake pedal is depressed after the vehicle is stopped by brake control.
 - The static object is no longer in the traveling direction of the vehicle or approximately 6 to 13 ft. (2 to 4 m) away from the vehicle.

■ Detection range

The detection range of the system differs from the detection range of the intuitive parking assist.

Therefore, even if the intuitive parking assist detects a static object and provides a warning, the PKSB (Parking Support Brake) system may not start operating.

■ Intuitive parking assist sensor buzzer

Regardless of whether the intuitive parking assist sensor buzzer is enabled or not, if the PKSB (Parking Support Brake) system is enabled, the front or rear sensors detect an object and brake control is performed, the intuitive parking assist buzzer will sound to notify the driver of the approximate distance to the object.

■ Situations in which the system may not operate properly

→ P.432

■ Situations in which the system may operate even if there is no possibility of a collision

→ P.431

▲ WARNING

■ If the PKSB (Parking Support Brake) system operates unnecessarily, such as at a railroad crossing

→ P.455

Static Objects Front and Rear of the vehicle sensors

→ P.436

▲ WARNING

■ To ensure the system can operate properly

→ P.431

■ Notes when washing the vehicle

→ P.436

Static Objects Front and Rear of the vehicle operation examples

The system operates in the following situations when a static object is detected in the traveling direction of the vehicle.

6-2. Using the safe driving support functions

- When the vehicle is traveling at a low speed and the brake pedal is not depressed, or is depressed late

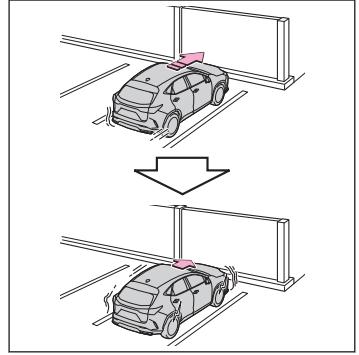

- When the accelerator pedal is depressed excessively

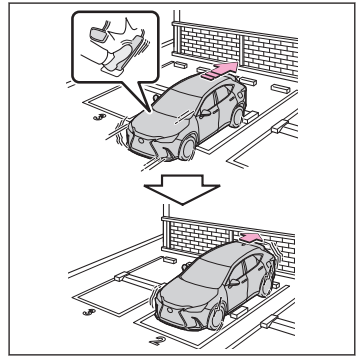

- When the vehicle moves forward due to the incorrect shift position being selected

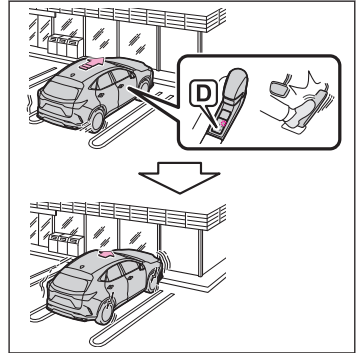

Moving Vehicles Rear of the Vehicle *

If a rear radar sensor detects a vehicle approaching from the right or left at the rear of the vehicle and the system determines that the possibility of a collision is high, this function will perform brake control to reduce the likelihood of an impact with the approaching vehicle.

*: If equipped

INFORMATION

■ The system will operate when

The function will operate when the driving assist information indicator is not illuminated or flashing and all of the following conditions are met:

- Hybrid system output restriction control
 - PKSB (Parking Support Brake) system is enabled.
 - The vehicle speed is 9 mph (15 km/h) or less.
 - Vehicles are approaching from the right or left at the rear of the vehicle at a traveling speed of approximately 5 mph (8 km/h) or more.
 - The shift position is in R.
 - The PKSB (Parking Support Brake) determines that a stronger than normal brake operation is necessary to avoid a collision with an approaching vehicle.
- Brake control
 - Hybrid system output restriction control is operating.
 - The PKSB (Parking Support Brake) determines that an emergency brake operation is necessary to avoid a collision with an approaching vehicle.

■ The system will stop operating when

The function will stop operating if any of the following conditions are met:

- Hybrid system output restriction control
 - PKSB (Parking Support Brake) system is disabled.
 - The collision becomes avoidable with normal brake operation.
 - A vehicle is no longer approaching from the right or left at the rear of the vehicle.
- Brake control
 - PKSB (Parking Support Brake) system is disabled.
 - Approximately 2 seconds have elapsed since the vehicle was stopped by brake control.
 - The brake pedal is depressed after the vehicle is stopped by brake control.
 - A vehicle is no longer approaching from the right or left at the rear of the vehicle.

■ Detection range

The detection range of the system differs from the detection area of the RCTA function. → P.448 Therefore, even if the RCTA function detects a vehicle and provides an alert, the PKSB (Parking Support Brake) system may not start operating.

6-2. Using the safe driving support functions

■ RCTA buzzer

Regardless of whether the RCTA function is on or off, if the PKSB (Parking Support Brake) system is not disabled, when the brake control operates, the buzzer will sound to alert the driver.

■ Situations in which the system may not operate properly

→ P.443

■ Situations in which the system may operate even if there is no possibility of a collision

→ P.443

Examples of the Moving Vehicles Rear of the Vehicle operation

This function will operate in situations such as the following if a vehicle is detected in the traveling direction of the vehicle.

■ When reversing, a vehicle is approaching and the brake pedal is not depressed, or is depressed late

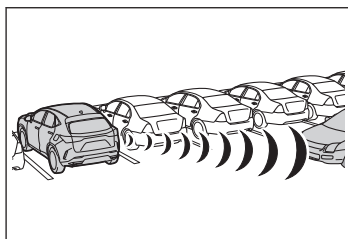

Moving Vehicles Rear of the Vehicle sensors

→ P.418

▲ WARNING

■ To ensure the system can operate properly

→ P.418

Pedestrians Rear of the Vehicle *

If the rear camera sensor detects a pedestrian behind the vehicle while backing up and the system determines that the possibility of colliding with the detected pedestrian is high, a buzzer will sound. If the system determines that the possibility of colliding with the detected pedestrian is extremely high, the brakes will be applied automatically to help reduce the impact of the collision.

*: If equipped

INFORMATION

■ The system will operate when

- The function will operate when the driving assist information indicator is not illuminated or flashing and all of the following conditions are met:
 - Hybrid system output restriction control
 - PKSB (Parking Support Brake) system is enabled.
 - The vehicle speed is approximately 9 mph (15 km/h) or less.
 - The shift position is in R.
 - The rear camera sensor detects a pedestrian behind the vehicle while backing up and the system determines that the possibility of colliding with the detected pedestrian is high.
 - The PKSB (Parking Support Brake) determines that a stronger-than-normal brake operation is necessary to avoid a collision.
- Brake control
 - Hybrid system output restriction control is operating.
 - The PKSB (Parking Support Brake) determines that an emergency brake operation is necessary to avoid a collision with a pedestrians.

■ The system will stop operating when

The function will stop operating if any of the following conditions are met:

- Hybrid system output restriction control
 - PKSB (Parking Support Brake) system is disabled.
 - The collision becomes avoidable with normal brake operation.
 - The pedestrian is no longer detected behind your vehicle.
- Brake control
 - PKSB (Parking Support Brake) system is disabled.
 - Approximately 2 seconds have elapsed since the vehicle was stopped by brake control.
 - The brake pedal is depressed after the vehicle is stopped by brake control.
- The pedestrian is no longer detected behind your vehicle.

■ Detection range

The detection range of the system differs from the detection area of the RCTA function. (→ P.453) Therefore, even if the RCTA function detects a vehicle and provides an alert, the PKSB (Parking Support Brake) system may not start operating.

■ Situations in which the system may not operate properly

→ P.450

6-2. Using the safe driving support functions

■ Situations in which the system may operate unexpectedly

→ P.450

When a vehicle is detected behind the vehicle

When a pedestrian is detected behind the vehicle while backing up, the brake pedal is not depressed or is depressed late.

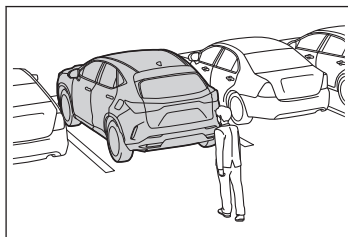

Pedestrians Rear of the Vehicle display

Displays a message to urge the driver to take evasive action when a pedestrian is detected in the detection area behind the vehicle. (A message will also be displayed on the center display.)

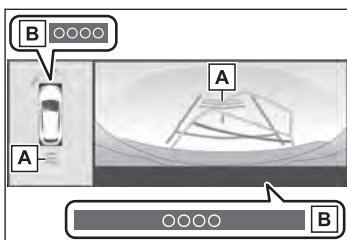

A Pedestrian detection icon

B Brake reminder

Static Objects Around the vehicle (Vehicles with Advanced Park)*

While parking, if a sensor detects a surrounding stationary object, such as a wall, with which a collision is likely, the system will operate to help avoid a collision or reduce the impact of the collision.

The system will operate in the following situations when a stationary object is detected in the surrounding area.

- When moving forward and a collision with a stationary object on the inner side of a turn is likely

*: If equipped

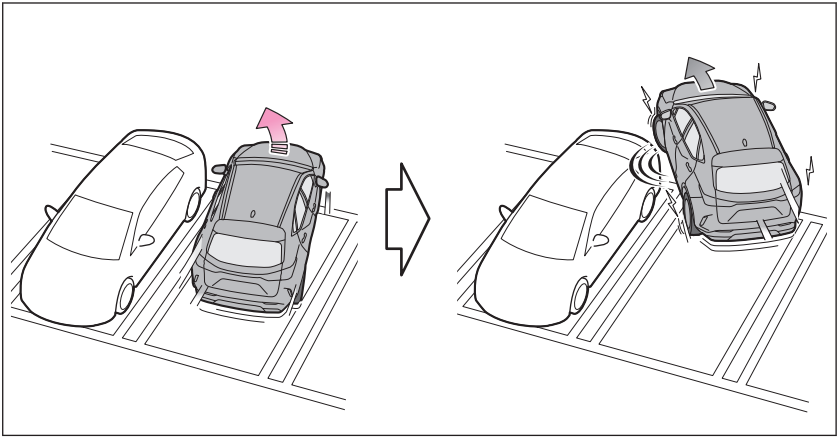

- When reversing and a collision with a stationary object on the outer side of a turn is likely

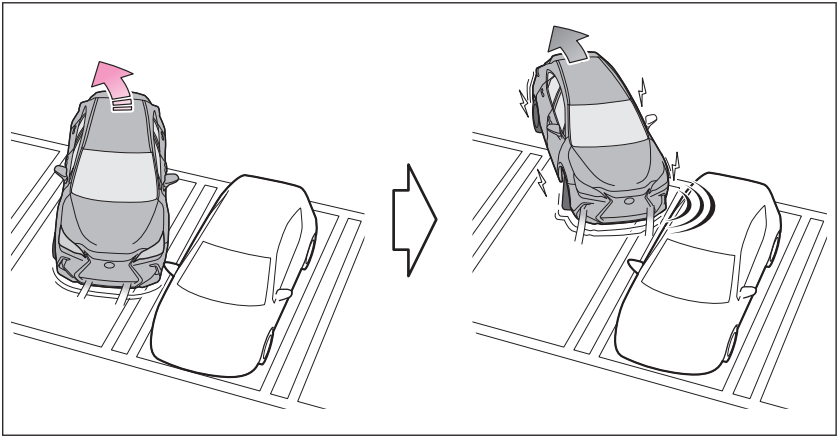

■ Operating conditions

This function is operable when any of the following conditions are met in addition to the operating conditions for stationary objects in around the vehicle.

- After the hybrid system has been started, the vehicle has moved approximately 23.0 ft. (7 m) or less
- The R shift position is selected
- After the shift position has been changed from R to D, the vehicle has moved approximately 23.0 ft. (7 m) or less

■ The system will stop operating when

→ P.459

■ Sensor detection information

The detection range of the system differs from the detection range of the intuitive parking assist.

Therefore, even if the intuitive parking assist detects a static object and provides a warning, the PKSB (Parking Support Brake) system may not start operating.

■ Objects which the sensor may not be properly detected

→ P.431

■ Intuitive parking assist sensor buzzer

Regardless of whether the intuitive parking assist sensor buzzer is enabled or not (→ P.436), if the PKSB (Parking Support Brake) system is enabled (→ P.458), the front or rear sensors detect an object and brake control is performed, the intuitive parking assist buzzer will sound to notify the driver of the approximate distance to the object.

■ Situations in which the system may not operate properly

→ P.432

■ Situations in which the system may operate even though there is no possibility of a collision

- In addition to the situations in which stationary objects around the vehicle (→ P.459) may not be detected, objects may not be detected by the sensors in the following situations:
- When moving sideways, such as when parallel parking → P.431

■ Detection of objects along the sides of the vehicle

- Objects along the sides of the vehicle are not instantaneously detected. The location of objects in relation to the vehicle is estimated after they are first detected by the front or rear side sensors, or side cameras. Therefore, after the power switch is changed to ON, even if an object is along the side of the vehicle, it may not be detected until the vehicle has been driven a small amount and the side sensors or side cameras completely scan the areas along the sides of the vehicle.
- If a vehicle, person, animal, etc., is detected by a side sensors or side cameras, but then leaves the detection area of the side sensors or side cameras, the system will assume the object has not moved.

Parking assistance through the Advanced Park main switch operation *

Purpose of the Lexus Teammate Advanced Park

The Advanced Park is a system which assists in safely and smoothly parking in a target parking space by displaying the blind spots around the vehicle and the parking spot through a bird's eye view, delivering operation guidance through displays and buzzer operation, and changing the shift position, operating the steering wheel, accelerator pedal, and brake pedal. Additionally, the panoramic view monitor can display the area in front, behind, and from above the vehicle, helping confirm the condition of the area around the vehicle. For details on the panoramic view monitor refer to "MULTIMEDIA OWNER'S MANUAL". Depending on the condition of the road surface or the vehicle, the distance between the vehicle and a parking space, etc., it may not be possible to assist in parking in the target space.

Purpose of the Remote control function *

Remote control function is a system which assists in parking or exiting from a parking space selected on the center display by allowing changing the shift position, operating the steering wheel, accelerator pedal, and brake pedal from outside of the vehicle via a smartphone.

Preparation before using

→ P.504

Related Links

[Customizable features\(P. 765\)](#)

Advanced Park functions

■ Perpendicular parking (forward/reverse) function

Assistance is provided from the position the vehicle is stopped near the target parking space until the vehicle is in the parking space. → P.482

■ Perpendicular exiting (forward/reverse) function

Assistance is provided from the parked position until the vehicle is in a position where you can easily exit from the parking space. → P.485

■ Parallel parking function

Assistance is provided from the position the vehicle is stopped near the target parking space until the vehicle is in the parking space. → P.488

*: If equipped

■ Parallel exiting function

Assistance is provided from the parked position until the vehicle is in a position where you can easily exit from the parking space. → [P.491](#)

■ Memory function

Assistance is provided until the vehicle is guided into a previously registered parking space. → [P.494](#)

■ Remote control function *

By operating a smartphone, assistance in entering or exiting a nearby target parking space, confirmed on the screen of the smartphone, is provided from outside of the vehicle. → [P.500](#)

WARNING

■ Cautions regarding the use of the system

The recognition and control capabilities for this system are limited. The driver should always drive safely by always being responsible without over-relying on the system and have a understanding of the surrounding situations.

- As with a normal vehicle, take care to observe your surroundings while the vehicle is moving.
- Always pay attention to the vehicle's surroundings while the system is operating and depress the brake pedal as necessary to slow or stop the vehicle.
- When parking, make sure that the vehicle can be parked in the target parking space before beginning operation.
- Depending on the condition of the road surface or the vehicle, the distance between the vehicle and a parking space, etc., it may not be possible to detect a parking space or the system may not be able to provide assistance to the point the vehicle is fully parked.
- This system will guide the vehicle to appropriate positions for changing the direction of travel, however, if you feel that the vehicle is approaching too close to an adjacent parked vehicle at any time, depress the brake pedal and change the shift position. However, if this is performed, the number of times the vehicle changes direction may increase, and the vehicle may be parked at an angle.
- As following objects may not be detected, make sure to check the safety of the area around your vehicle and depress the brake pedal to stop the vehicle if it may collide with an object.
 - Wires, fences, ropes, etc.
 - Cotton, snow and other materials that absorb sound waves
 - Sharply-angled objects

*: If equipped

⚠ WARNING

- Low objects (curb stones, parking blocks, etc.)
- Tall objects with upper sections projecting outwards in the direction of your vehicle
- Even if there is an object in the target parking space, it may not be detected and assistance may be performed.
- While the system is operating, if it is likely that your vehicle will collide with a nearby vehicle, parking block, object, or person, depress the brake pedal to stop the vehicle and press the Advanced Park main switch to disable the system.
- Never use only the center display to view the area behind the vehicle. The image displayed may differ than the actual situation. Using only the screen when backing up may lead to an accident, such as a collision with another vehicle. When backing up, make sure to look directly or use the mirrors to check the safety of the area around your vehicle, especially behind the vehicle.
- When the ambient temperature is extremely low, the screen may appear dark or the displayed image may become unclear. Also, as moving objects may appear distorted or may not be able to be seen on the screen, make sure to directly check the safety of the area around your vehicle.
- In the following situations, while the vehicle is stopped and held by Advanced Park, it may be canceled and the vehicle may start moving. Immediately depress the brake pedal. Failure to do so may lead to an accident.
 - When the driver's door is opened
 - When operations instructed by the system are not performed within a certain amount of time
 - When the brake pedal is depressed and the vehicle is stopped for a certain amount of time
 - When the system malfunctions
- As the steering wheel will turn while this system is operating, pay attention to the following.
 - Be careful so that a necktie, scarf, or arm does not get caught. Keep your upper body away from the steering wheel. Also, keep children away from the steering wheel.
 - Long fingernails may be caught and when the steering wheel is rotating, leading to injury.
 - In an emergency, depress the brake pedal to stop the vehicle, and then press the Advanced Park main switch to disable the system.
- Do not allow anyone to put their hands outside of a window while this system is operating.

WARNING

Precautions for the cameras and sensors

- Due to the characteristics of the camera lens, the position of and distance to people and objects displayed on the screen may differ from the actual situation. For details, refer to Panoramic view monitor [Vehicles equipped with Lexus Teammate Advanced Park (parking assist system)] in the "MULTIMEDIA OWNER'S MANUAL".
- Make sure to observe the precautions for using the intuitive parking assist, otherwise a sensor may not operate correctly, possibly leading to an accident. → P.431
- In situations such as the following, the sensors may not operate correctly, possibly leading to an accident. Proceed carefully.
 - When there is a parked vehicle next to the target parking space, if the displayed target parking space is far from the actual target parking space, a sensor may be misaligned. Have the vehicle inspected by your Lexus dealer.
 - Do not install any accessories near the detection area of the sensors.

To ensure correct operation of the Advanced Park

Observe the following precautions. Failing to do so may result in the vehicle being unable to be driven safely and possibly cause an accident.

- Do not use this system in situations such as the following:
 - When in areas other than common parking spaces
 - When the surface of the parking space is sand or gravel and is not clearly defined with parking space lines
 - When the parking space is not level, such as when on a slope or has differences in height
 - Mechanical parking system
 - Parking lot with a device which raises to contact the bottom of the vehicle
 - When the road surface is frozen, slick, or covered with snow
 - When it is extremely hot and the asphalt is melting
 - When there is an object in front of the vehicle
 - When there is an object between your vehicle and the target parking spot or within the target parking spot (within the displayed blue box)
 - When there is a gutter between your vehicle and the target parking space or within the target parking spot (within the displayed blue box)
 - When there is a hole or gutter in the exit direction
 - When in high pedestrian or vehicle traffic areas
 - When the parking space is in a location that is difficult to park in (too narrow for your vehicle, etc.)

⚠ WARNING

- When images are unclear due to dirt or snow attached to the camera lens, light being shined into the camera or shadows
 - When tire chains or a compact spare tire is installed to the vehicle
 - When the doors or back door are not completely closed
 - When an arm is held outside of a window
 - In inclement weather such as heavy rain or snow
- Make sure to use only standard sized tires, such as those that were installed to the vehicle when it was shipped from the factory. Otherwise, Advanced Park may not operate properly. Also, when the tires have been replaced, the displayed position of the lines or box displayed on the screen may become incorrect. When replacing the tires, contact your Lexus Dealer.
 - In situations such as the following, it may not be possible for the system to provide assistance to a registered parking spot:
 - When the tires are extremely worn or the tire inflation pressure is low
 - When carrying a heavy load
 - When the vehicle is tilted due to the carried load
 - When a heater is installed in the surface of the parking space (road surface freeze prevention heater)
 - When the wheels are misaligned, such after a wheel has been subjected to a strong impact
 - When a pedestrian or passing vehicle is detected during assistance
 - When something is incorrectly detected as a parking line (light, reflections from a building, difference in height on the parking surface, a gutter, painted road lines, redrawn lines, etc.)

If the vehicle deviates greatly from the set parking space in any situation other than the above, have the vehicle inspected by your Lexus dealer.

■ When using Remote control function

- Remote control function is a function of the Advanced Park system. When using Remote control function on public roads, be sure to follow all local road traffic laws and regulations.
- Remote control function can only be used after agreeing to the disclaimer of the smartphone application.
- Remote control function can only perform some driving operations. It should only be operated by a driver with a valid driving license. While using application, carry, electronic key. While operating, do not stare at the application screen, and pay

⚠ WARNING

attention to the vehicle's surroundings. In an emergency, cancel the Remote control function operation and stop the vehicle.

- As with a normal vehicle, take care to observe the area around the vehicle while the vehicle is moving.
- Always pay attention to the vehicle's surroundings while the system is operating.
- Remote control function is a system which assists in remote parking or exiting operations using a smartphone. When using Remote control function, the driver must carry the electronic key and smartphone and confirm the safety of the area around the vehicle.
- While using Remote control function, the vehicle can be stopped by stop continuously operating the smartphone (stopping movement of your finger, removing your finger from the screen, etc.). The vehicle can also be stopped by touching the cancel button on the smartphone application, unlocking the doors using the electronic key, or opening a door.
- If it seems like your vehicle may contact an obstruction, etc., stop operating the smartphone and cancel Remote control function if necessary.
- System operation will only be performed at a fixed speed and the vehicle cannot be accelerated or decelerated even if the speed of continuous operation of the smartphone is increased or decreased.
- Never drive the vehicle while staring at the smartphone screen.
- When driving, make sure to directly check the safety of the area around your vehicle.
- Do not use Remote control function when passengers or pets are in the vehicle.
- In an emergency, the system can be canceled by operating a switch on the electronic key or by opening a door.
- To use Remote control function, it is necessary to have a smartphone with the latest version of the Remote Park app. The following operating systems are supported:
 - Android™
 - Apple® iOS
- When registering the vehicle to the Remote Park smartphone app, disconnect any other apps which are connected to the vehicle.
- To enable Remote control function, make sure to disable the Apple CarPlay connection.
- When parking, make sure that the vehicle can be parked in the target parking space before beginning operation.
- Only use Remote control function on level road surfaces which are not slick. Do not use Remote control function for parking spaces on a downward or upward slope.

⚠ WARNING

- While Remote control function is operating, if a malfunction or system limitation is detected, the following will occur automatically:
 - Remote control function will be canceled
 - The vehicle will stop
 - The shift position will change to P and the parking brake will be engaged
 - The power switch will turn off (for some malfunctions, the power switch will not turn off or cannot be turned off. Enter the vehicle and take corrective action according to the message displayed on the smartphone.)
 - The doors will remain locked
- When starting Remote control function, unlock the doors with wireless remote control by electronic key.
- When Remote control function is operating, the driver should remain within approximately 9.8 ft. (3 m) of the vehicle. If the driver becomes more than approximately 9.8 ft. (3 m) away, Remote control function will be suspended and a message will be displayed on the smartphone. Remote control function operation can be resumed by approaching the vehicle.
- The headlights will be turned on if the surrounding area is dark.
- If system operation is canceled due to a malfunction, the emergency flashers will flash. The emergency flashers will turn off if any of the following conditions are met:
 - A door is opened
 - 3 minutes have elapsed since the emergency flashers began flashing
- Remote control function can only be started when the following conditions are met:
 - When the hybrid system is starting, after assist mode is selected
 - When the power switch is off
 - When the remote air conditioning is operating
- After unlocking the doors using the wireless remote control, if the doors are locked using the smart entry function, the lock operation may be delayed.

⚠ NOTICE**■ Precautions for use Advanced Park**

If the 12-volt battery was discharged or has been removed and installed, fold and extend the outside rear view mirrors.

NOTICE

■ When using Remote control function

- Check the battery charge level of the smartphone before using Remote control function. If the battery of the smartphone dies while operating Remote control function, assist will be suspended. Also, if the battery charge level of the smartphone is 20% or less when attempting to start Remote control function, Remote control function will not be started.
- Turn on the Bluetooth communication function of the smartphone before using Remote control function. Remote control function cannot be used if the Bluetooth function is off.
- Do not turn off the Bluetooth function of the smartphone or disconnect from the multi-media system while using Remote control function. If the vehicle cannot be connected to via Bluetooth, Remote control function cannot be used.
- Do not use Remote control function when the electronic key battery is depleted.
- While using Remote control function, if a call is received, etc., and another app is opened, Remote control function will be suspended. Assist can be resumed if the Remote Park app is reopened within 3 minutes. If 3 minutes or more elapse, assist will be canceled.
- While using Remote control function, if the home button or power button of the smartphone is pressed and the screen is locked, Remote control function will be suspended. Assist can be resumed if the Remote Park app is reopened within 3 minutes. If 3 minutes or more elapse, assist will be canceled.
- Do not use the Remote Park app with devices other than those which operation has been confirmed by the maker. Otherwise the system may not operate correctly.
- When the ambient temperature is low, it may take time for the system to start, due to 12-volt battery charging.
- If the 12-volt battery voltage drops, assistance will be canceled.
- When using Remote control function on a slope, the vehicle speed will be slower and the distance that the vehicle will approach objects will become longer than when on a level road surface.
- If a system temporary failure occurs, after the vehicle is stopped by the electronic parking brake or the shift position being changed to P, the power switch may turn off and the system may be canceled. In this case, have the vehicle inspected by your Lexus dealer.
- If a system malfunction occurs, assistance may be temporarily suspended. If the system returns to normal, operation can be resumed. Follow the content on the smartphone screen to resume operation.
- Remote control function cannot be started if the hybrid system has been started using an aftermarket remote starter.

⚠ NOTICE

- After Remote control function completes, the parking brake will be engaged as per regulations. As the parking brake may freeze and not be able to be released, avoid using Remote control function in extremely cold areas. Also, if the parking brake freezes, it may make a noise when it is released. However, this does not indicate a malfunction.

Type of Advanced Park cameras and sensors

Cameras and sensors are used to detect parked vehicles, making it easier to identify parking spaces.

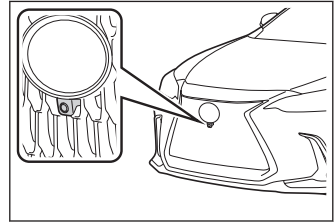
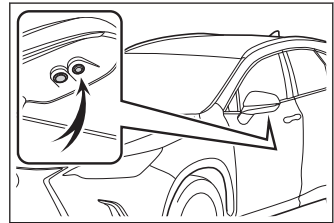
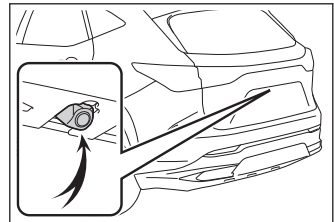
► Front camera**► Side cameras****► Rear camera****► Sensors**

→ P.436

□ INFORMATION**■ Camera images**

As special cameras are used, the colors in displayed images may differ from the actual color.

■ Precautions for use

For details on the following, refer to "Panoramic view monitor (Vehicles equipped with Lexus Teammate Advanced Park)" of "Peripheral monitoring system" in the "MULTIMEDIA OWNER'S MANUAL".

- Displayable range of the screens
- Cameras
- Differences between displayed images and the actual road
- Differences between displayed images and the actual objects

■ Detection range of the cameras and sensors

- If a parked vehicle is behind the target parking space and the distance between it and the vehicle becomes far, it may no longer be able to be detected. Depending on shape or condition of a parked vehicle, the detection range may become short or the vehicle may not be detected.
- Objects other than parked vehicles, such as columns, walls, etc., may not be detected. Also, if they are detected, they may cause the target parking space to be misaligned.

■ Situations in which white parking space lines may not be recognized properly

In situations such as the following, parking space lines on the road surface may not be detected:

- When the parking space does not use white lines (parking space boundaries are marked with rope, blocks, etc.)
- When the parking space lines are faded or dirty, making them unclear
- When the road surface is bright, such as concrete, and the contrast between it and the white parking space lines is small
- When the parking space lines are any color other than yellow or white
- When the area surrounding the parking space is dark, such as at night, in an underground parking lot, parking garage, etc.
- When it is raining or has rained and the road surface is wet and reflective or there are puddles
- When the sun is shining directly into a camera, such as in the early morning or evening
- When the parking space is covered with snow or de-icing agent
- When there marks from repairs or other marks on the road surface, or there is a traffic bollard, or other object on the road surface
- When the color or brightness of the road surface is uneven
- When a camera has been splashed by hot or cold water and the lens has fogged up
- When the appearance of the parking space is affected by the shadow of the vehicle or trees

- When a camera lens is dirty or covered with water droplets

In situations such as the following, the target parking space may not be recognized correctly:

- When there are marks from repairs or other marks on the road surface, or there is a parking block, traffic bollard, or other object on the road surface
- When it is raining or has rained and the road surface is wet and reflective or there are puddles
- When the area around the vehicle is dark or backlit
- When the color or brightness of the road surface is uneven
- When the parking space is on a slope
- When there are diagonal lines (access aisle) near the parking space
- When the appearance of the parking space is affected by the shadow of a parked vehicle (such as shadows from the grille, side step, etc.)
- When accessories which obstruct the view of the camera are installed
- When the parking space lines are faded or dirty, making them unclear
- When the appearance of the parking space is affected by the shadow of the vehicle or trees

■ Sensor detection information

→ P.431

■ Objects which the sensor may not be properly detected

→ P.431

■ Situations in which the sensor may not operate properly

→ P.431

■ Situations in which parking assistance may not operate even if there is no possibility of a collision

→ P.431

Turning the Advanced Park system on/off

INFORMATION

■ Operating conditions of the Advanced Park

Assistance will begin when all of the following conditions are met:

- The brake pedal is depressed
- The vehicle is stopped
- The driver's seat belt is fastened

6-2. Using the safe driving support functions

- The steering wheel is not being operated
- The accelerator pedal is not depressed
- All of the doors and the back door are closed
- The outside rear view mirrors are not folded
- The parking brake is not engaged
- The dynamic radar cruise control are not operating
- ABS, VSC, TRAC, PCS and PKSB are not operating
- The vehicle is not on a steep slope
- The VSC and TRAC are not turned off

If assistance cannot be started, check the message displayed on the center display → P.510

● Press the Advanced Park main switch.

If the switch is pressed while assistance is being performed, the assistance will be canceled.

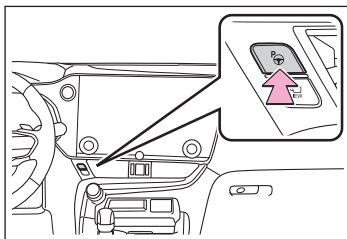

Advanced Park guidance screens

Guidance screens are displayed on the center display.

▶ Guidance screen (When assistance starts)

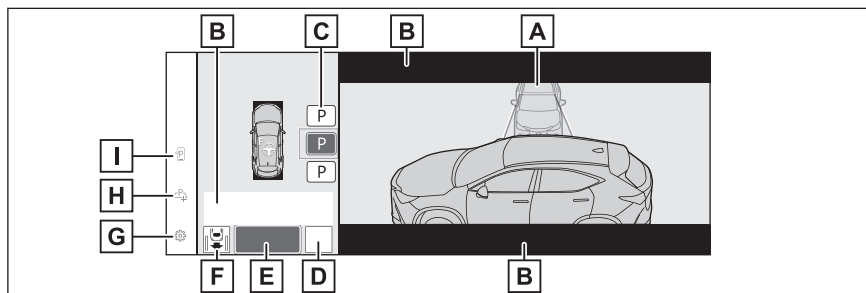

- A Target parking space box (blue)
- B Advice display
- C Parking type change button

If multiple buttons are displayed, depending on the condition of the button its function differs as follows.

or : Change the target to another parking space.

or : Change the target to another parking space.

: Select to change to the parallel parking function

: Change the perpendicular parking (forward/reverse) function

D [MODE] button

Select to change between the memory function and the perpendicular parking (forward/reverse) function and parallel parking function → P.494

E [Start] button

Select to start parking assistance.

F Perpendicular parking direction change button

Select to change between the parking (forward) function and parking (reverse) function

: Change the perpendicular parking (forward) function

: Change the perpendicular parking (reverse) function

G Customize setting button

Select to display the Advanced Park setting screen. → P.508

H Registration button

Select to begin registering a parking space.

I Remote control function start button *

Select to start parking assistance operation on the smartphone display.

► Guidance screen (When reversing)

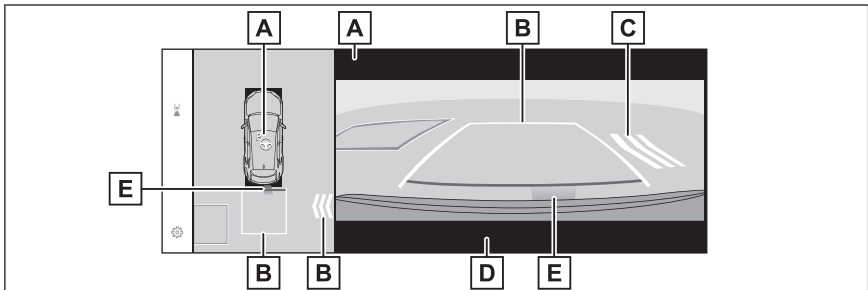

A Operation icon

Displayed when the Advanced Park is operating.

B Guide lines (yellow and red)

*: If equipped

6-2. Using the safe driving support functions

Display points from the center of the edge of the front or rear bumper to the target stopping position (yellow) *1 and approximately 1 ft. (0.3 m) (red) from the vehicle.

- C Moving object warning icon
- D Emergency support brake control operation display

"Brakel" is displayed.

- E Intuitive parking assist display

→ P.435

INFORMATION

■ Intuitive parking assist pop-up display

Regardless of whether the intuitive parking assist is off or on → P.436, if an object is detected by the intuitive parking assist when the Advanced Park is operating, the intuitive parking assist pop up display will automatically be displayed over the guidance display.

■ Brake control operation when Advanced Park is operating

While the Advanced Park is operating, if the system determines that the possibility of collision with detected moving or stationary object is high, the hybrid system output restriction control and brake control will operate.

If brake control operates, Advanced Park operation will be suspended and a message will be displayed on the multi-information display.

■ Buzzer

Depending on surrounding sounds or sounds from other systems, it may be difficult to hear the buzzer of this system.

■ If a black screen is displayed on the multimedia system when the Advanced Park is operating

The system is being affected by radio waves or may be malfunctioning. If a radio antenna is installed near a camera, move it to a location as far from the cameras as possible. If a radio antenna is not installed near a camera, and the screen does not return to normal after turning the power switch off and then starting the hybrid system again, have the vehicle inspected by your Lexus dealer.

Perpendicular parking (forward/reverse) function

■ Function description

The perpendicular parking (forward/reverse) function can be used if the target parking space can be detected when the vehicle is stopped close and

*1: When the distance to the target stopping position is more than 8.2 ft. (2.5 m), the line will be displayed 8.2 ft. (2.5 m) in front of the vehicle.

perpendicular to the center of the parking space. Also, depending on the condition of the parking space, etc., if it is necessary to change the direction of travel of the vehicle, the shift position can be changed by assistance control.

Parking using the perpendicular parking (forward/reverse) function

- 1 Stop the vehicle at a position close and perpendicular to the center of the target parking space.

► If there are parking space lines

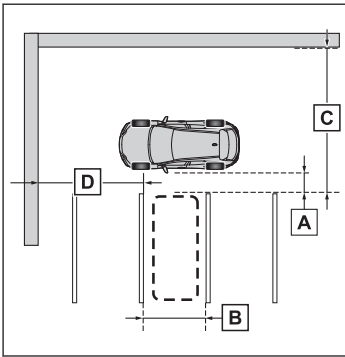

- A Approximately 3.3 ft. (1 m) ^{*2}
- B Approximately 8.2 ft. (2.5 m) ^{*2}
- C Approximately 19.7 ft. (6 m) or more ^{*2}
- D Approximately 18.0 ft. (5.5 m) or more ^{*2}

The system can operate even if there is a parking space line on only one side of the target parking space.

► If there is an adjacent parked vehicle

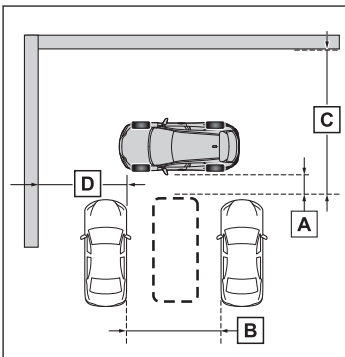

- A Approximately 3.3 ft. (1 m) ^{*3}
- B Approximately 9.8 ft. (3 m) or more ^{*3}
- C Approximately 19.7 ft. (6 m) or more ^{*3}
- D Approximately 18.0 ft. (5.5 m) or more ^{*3}



The system can operate even if there is a vehicle on only one side of the target parking space.

- 2 Press the Advanced Park main switch and check that a possible parking space is displayed on the center display.

^{*2}: This is a reference measurement for detection of a parking space. Depending on the surrounding environment, detection may not be possible.

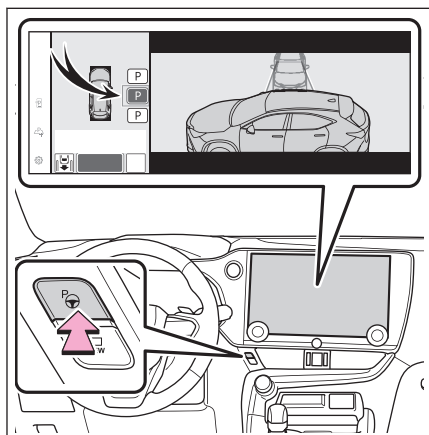
^{*3}: This is a reference measurement for detection of a parking space. Depending on the surrounding environment, detection may not be possible.



- If a space which your vehicle can be parked is detected, a target parking space box will be displayed.
- If it is possible to parallel park in the space, select the parking space, and then select **(P)** to change to the parallel parking function.
- If it is possible to change the direction which a parking space is entered, select the parking space, and then select  or  to change the direction.
- Depending on the surrounding environment, it may not be possible to use this function. According to the information displayed on the center display, use the function on another parking space.

3 Select [Start] button.

A buzzer will sound, an operation message will be displayed on the multi-information display, and assistance will begin operating.

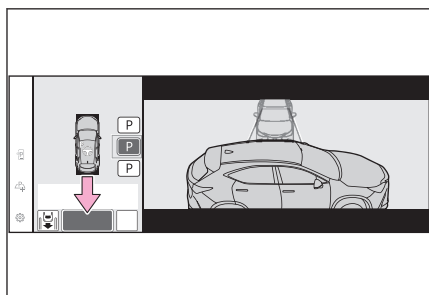

- When the brake pedal is released, **"Moving Forward..."**, **"Backing Up..."** will be displayed and the vehicle will begin moving forward/reverse.
- To cancel assistance, press the Advanced Park main switch.

If assistance is canceled, **"Advanced Park Canceled"** will be displayed.

If you feel that the vehicle is approaching close to a surrounding vehicle, object, person, or gutter: → [P.485](#)

- 4 Perform operations as indicated by the advice displays until the vehicle stops in the target parking space.

When the vehicle stops, "Advanced Park Finished" will be displayed and parking assistance will end.

If you select  on the center display, the vehicle displayed on the parking assist completion screen will rotate.

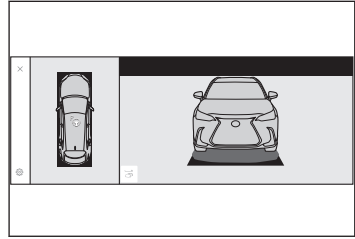

INFORMATION

- **If you feel that the vehicle is approaching close to a surrounding vehicle, object, person, or gutter**

Depress the brake pedal to stop the vehicle and then change the shift position to change the direction of travel of the vehicle. At this time, assist will be suspended. However, if the [Start] button is selected, assist will resume and the vehicle will move in the direction corresponding to the selected shift position.

NOTICE

■ **When using the perpendicular parking (forward/reverse) function**

- Make sure that there are no obstructions within the yellow guide lines and between the vehicle and target parking spot. If there are any obstructions between the vehicle and the target parking space, or between the yellow guide lines, cancel the function.
- As the target parking space will not be able to be set correctly if the surface of the parking space is on a slope or has differences in height, the vehicle may stray from the target parking space or be slanted. Therefore, do not use the function for this kind of parking spot.
- When parking in a narrow parking space, the vehicle may closely approach an adjacent parked vehicle. If a collision seems likely, depress the brake pedal to stop the vehicle.
- If a detected parked vehicle is narrow or parked extremely close to the curb, the position at which assistance will park the vehicle will also be close to the curb. If it seems likely the vehicle will collide with something or drive off of the road, depress the brake pedal to stop the vehicle, and then press the Advance Park main switch to disable the system.

Advanced Park perpendicular exiting (forward/reverse) function

■ Function description

When exiting from a perpendicular parking space, if the system determines that exit is possible the perpendicular exiting (forward/reverse) function can be used. Also, depending on the surrounding environment, if it is necessary to change the direction of travel of the vehicle, the shift position can be changed by assistance control.

Leaving a parking space using the perpendicular exiting (forward/reverse) function

- 1 With the brake pedal depressed and P shift position selected, press the Advanced Park main switch and check that the exit direction selection screen is displayed on the center display.

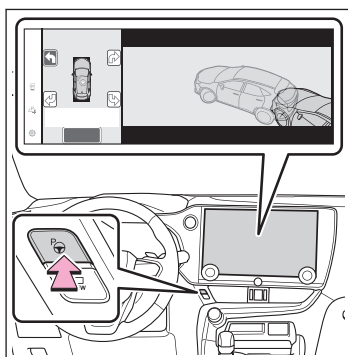

- 2 Select an arrow on the center display to select the direction you wish to exit.

If the turn signal lever is operated, only exit to the left or right can be selected.

- 3 Depress the brake pedal and select [Start] button.

If you feel that the vehicle is approaching close to a surrounding vehicle, object, person, or gutter: → P.485

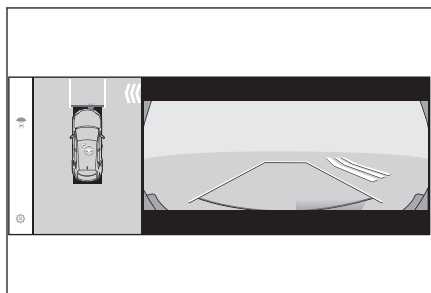

A buzzer will sound, an operation message will be displayed on the multi-information display, and assistance will begin operating. To cancel assistance, press the Advanced Park main switch. If assistance is canceled, "Advanced Park Canceled" will be displayed.

4 Perform operations as indicated by the advice displays until the vehicle is in a position where exit is possible.

If the steering wheel is not operated, the vehicle will stop at the exit position. Assistance can be ended by depressing the accelerator pedal or brake pedal. When the vehicle reaches a position where exit is possible, **"You can exit by moving the steering wheel"** will be displayed. If the steering wheel is operated, **"Advanced Park Finished"** will be displayed and assistance will end. Grip the steering wheel and drive forward.

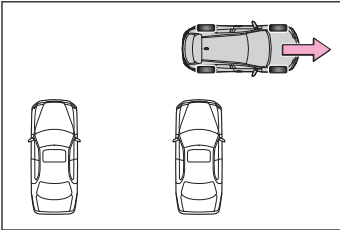

INFORMATION

- **If you feel that the vehicle is approaching close to a surrounding vehicle, object, person, or gutter**

→ P.485

■ **Perpendicular exiting (forward/reverse) function**

Do not use exiting (forward/reverse) function in any situation other than when exiting a parallel parking spot. If assistance is started unintentionally, depress the brake pedal and stop the vehicle, then press the Advanced Park main switch to cancel assistance.

- **Situations in which the perpendicular exiting (forward/reverse) function will not operate**

Situations in which the perpendicular exiting (forward/reverse) function will not operate.

- When a vehicle which is waiting to park is in the exit direction

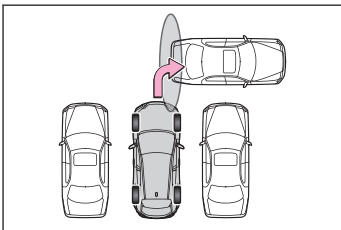

- When a wall, column, or person is detected as near a front or rear center or corner sensor

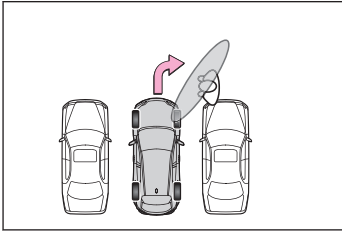

Advanced Park parallel parking function

■ Function description

The parallel parking function can be used if the target parking space can be detected when the vehicle is stopped close and aligned with the center of the parking space. Also, depending on the condition of the parking space, etc., if it is necessary to change the direction of travel of the vehicle, the shift position can be changed by assistance control.

Parking using the parallel parking function

1 Stop the vehicle with it aligned near the center of the target parking space.

► If there are parking space lines

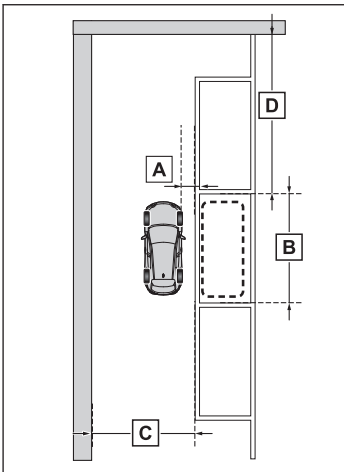

- A Approximately 3.3 ft. (1 m) ^{*4}
- B Approximately 16.4 to 19.7 ft. (5 to 6 m) ^{*4}
- C Approximately 14.8 ft. (4.5 m) or more ^{*4}
- D Approximately 26.2 ft. (8 m) or more ^{*4}

^{*4}: This is a reference measurement for detection of a parking space. Depending on the surrounding environment, detection may not be possible.

► If there is an adjacent parked vehicle

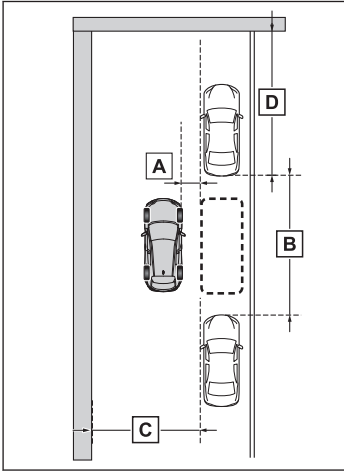

- A Approximately 3.3 ft. (1 m) *5
- B Approximately 23.0 ft. (7 m) or more *5
- C Approximately 14.8 ft. (4.5 m) or more *5
- D Approximately 26.2 ft. (8 m) or more *5

- 2 Press the Advanced Park main switch and check that a possible parking space is displayed on the center display.

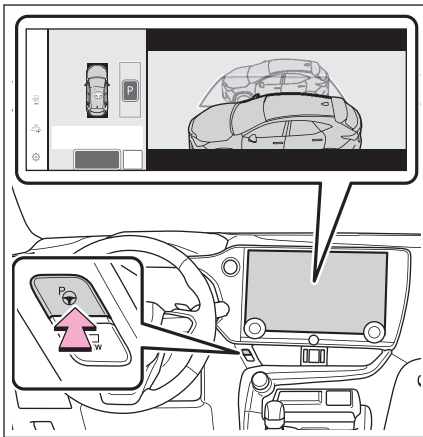

- If a space which your vehicle can be parked is detected, a target parking space box will be displayed.
- If it is possible to perpendicular parking (forward/reverse) in the space, select the parking space, and then select  to change to the perpendicular parking (forward/reverse) function.
- Depending on the surrounding environment, it may not be possible to use this function. According to the information displayed on the center display, use the function on another parking space.

*5: This is a reference measurement for detection of a parking space. Depending on the surrounding environment, detection may not be possible.

3 Select [Start] button.

A buzzer will sound, an operation message will be displayed on the multi-information display, and assistance will begin operating.

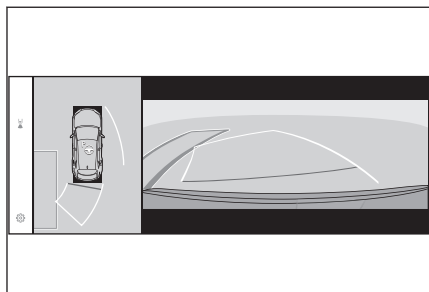

- When the brake pedal is released, **"Moving Forward..."** will be displayed and the vehicle will begin moving forward.
- To cancel assistance, press the Advanced Park main switch.

If assistance is canceled, **"Advanced Park Canceled"** will be displayed.

If you feel that the vehicle is approaching close to a surrounding vehicle, object, person, or gutter: → P.485

4 Perform operations as indicated by the advice displays until the vehicle stops in the target parking space.

When the vehicle stops, **"Advanced Park Finished"** will be displayed and parking assistance will end.

If you select  on the center display, the vehicle displayed on the parking assist completion screen will rotate.

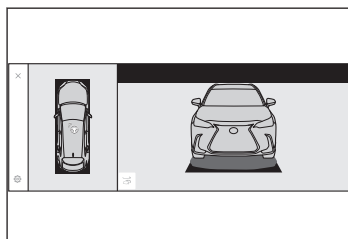

INFORMATION

- **If you feel that the vehicle is approaching close to a surrounding vehicle, object, person, or gutter**

→ P.485

- **"No available parking space" is displayed**

Even if the vehicle is stopped parallel to a parking space, an adjacent parked vehicle may not be detected. In this case, if the vehicle is moved to a position that a parked vehicle can be detected, assistance can be started.

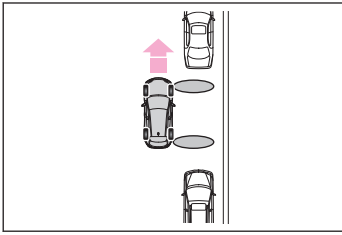

⚠ NOTICE

■ When using the parallel parking function → P.485

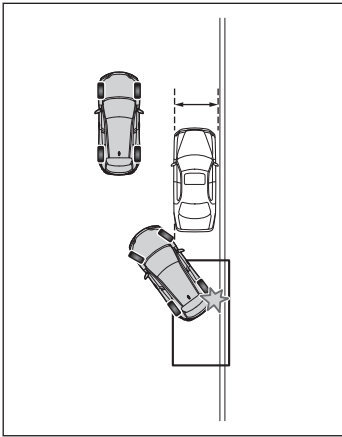

If there is a wall or other barrier on the inner side of the parking space, the vehicle may stop at a position slightly outside of the set target parking space.

Advanced Park parallel exiting function

■ Function description

When exiting from a parallel parking space, if the system determines that exit is possible the parallel exiting function can be used. Also, depending on the surrounding environment, if it is necessary to change the direction of travel of the vehicle, the shift position can be changed by assistance control.

Leaving a parking space using the parallel exiting function

- 1 With the brake pedal depressed and P shift position selected, press the Advanced Park main switch and check that the exit direction selection screen is displayed on the center display.

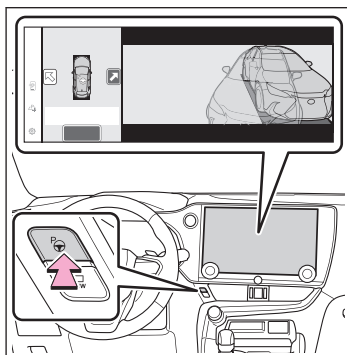

- 2 Select an arrow on the center display to select the direction you wish to exit.
If the turn signal lever is operated, only exit to the left or right can be selected.
- 3 Depress the brake pedal and select [Start] button.

A buzzer will sound, an operation message will be displayed on the multi-information display, and assistance will begin operating. To cancel assistance, press the Advanced Park main switch. If you feel that the vehicle is approaching close to a surrounding vehicle, object, person, or gutter: → P.485 If assistance is canceled, "Advanced Park Canceled" will be displayed.

- 4 Perform operations as indicated by the advice displays until the vehicle is in a position where exit is possible.

If the steering wheel is not operated, the vehicle will stop at the exit position. When the vehicle reaches a position where exit is possible, "You can exit by moving the steering wheel" will be displayed. If the steering wheel is operated, "Advanced Park Finished" will be displayed and assistance will end. Grip the steering wheel and drive forward.

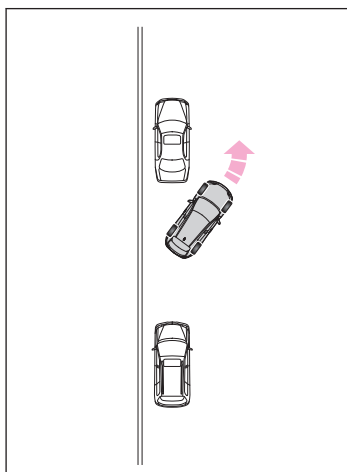

INFORMATION

- If you feel that the vehicle is approaching close to a surrounding vehicle, object, person, or gutter

→ P.485

■ Parallel exiting function

Do not use parallel exiting function in any situation other than when exiting a parallel parking spot. If assistance is started unintentionally, depress the brake pedal and stop the vehicle, then press the Advanced Park main switch to cancel assistance.

■ Situations in which the parallel exiting function will not operate

In situations such as the following, the parallel exiting function will not operate:

- When vehicles waiting at a traffic signal in the exit direction

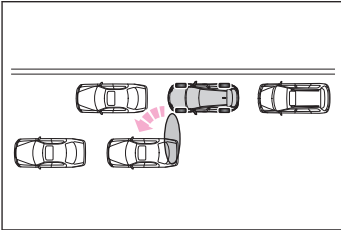

- When a vehicle is stopped in the area behind where the vehicle will exit

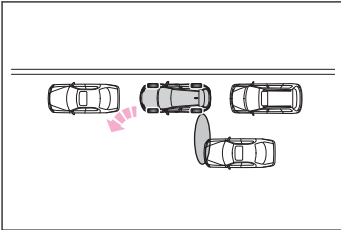

- When a wall, column, or person is detected as near a front or rear side sensor

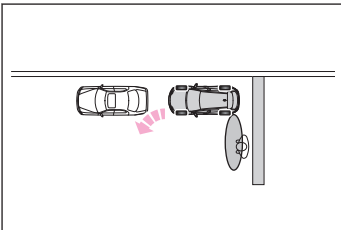

- When the vehicle has been parked on a curb and a side sensor detects the road surface

6-2. Using the safe driving support functions

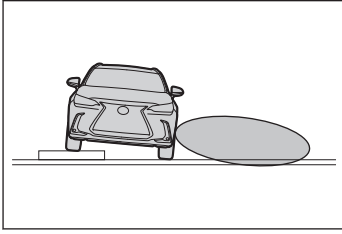

- When a vehicle is not parked in front of the vehicle
- When there is excessive space between the front of the vehicle and a parked vehicle

Advanced Park memory function

■ Function description

The memory function can be used to park in a previously registered parking space, even if there are no parking space lines or adjacent parked vehicles.

Up to 3 parking spaces can be registered.

Registering a parking space

- 1 Stop the vehicle with it aligned near the center of the target parking space.

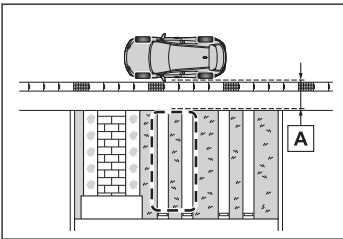

A Approximately 3.3 ft. (1 m)

- 2 Press the main switch and then select .

If the Advanced Park main switch is pressed at a parking space without parking lines or any adjacent parked vehicles, "No available parking space" may be displayed. Continuously select and hold .

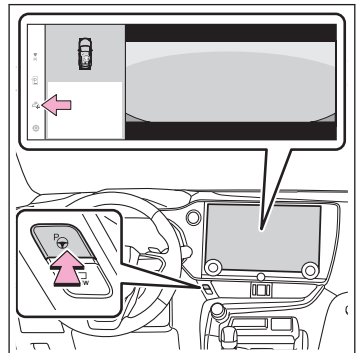

- 3 Select perpendicular parking (forward/reverse) function or parallel parking function.

Only parking spaces for which assist can be performed are displayed.

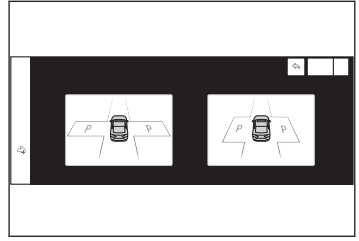

- 4 Select the parking direction.

When perpendicular parking (forward/reverse) was selected in step 3

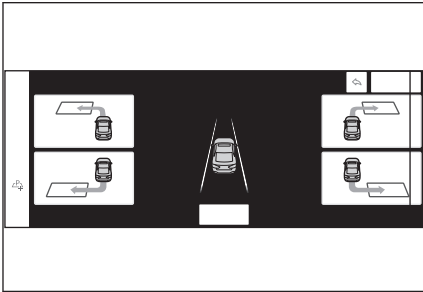

When parallel parking was selected in step 3

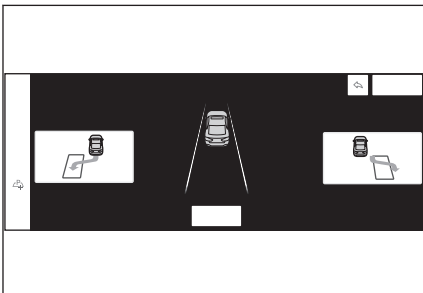

- 5 Using the arrow buttons, adjust the position of the parking space to be registered, and then select [OK] button.

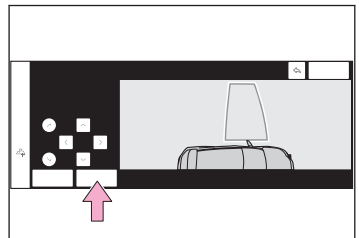

6 Select [Start] button.

A buzzer will sound, an operation message will be displayed on the multi-information display, and assistance will begin operating. When the brake pedal is released, "Moving Forward..." will be displayed and the vehicle will begin moving forward.

If you feel that the vehicle is approaching close to a surrounding vehicle, object, person, or gutter:

→ P.485

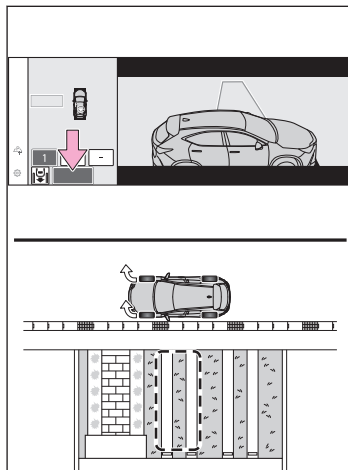

- 7 Perform operations as indicated by the advice displays until the vehicle stops in the target parking space.
- 8 Check the position that the vehicle has stopped. If necessary, adjust the position of the parking spot to be registered using the arrow buttons, and then select [Reg.] button.

"Registration Completed" will be displayed on the center display.

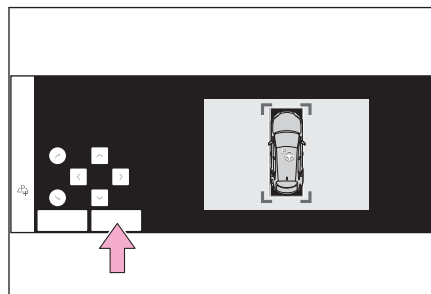

- Register the parking space only if there are no obstructions within the area shown by the thick lines.
- The amount that the position of the parking spot to be registered can be adjusted is limited.

When parking in a parking space registered to the memory function

- 1 Stop the vehicle with it aligned near the center of the target parking space.

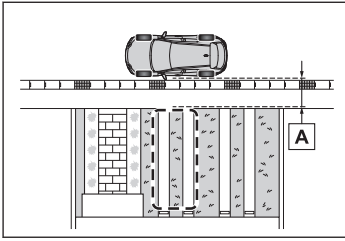

A Approximately 3.3 ft. (1 m)

- 2 Press the Advanced Park main switch and check that a possible parking space is displayed on the center display.

If the [MODE] button is displayed, the button can be touched to change between the memory function, perpendicular parking (forward/reverse) function and parallel parking function.

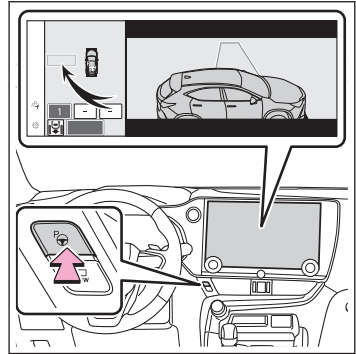

- 3 Select the desired parking space, and then select [Start] button.

Perform the procedure for the perpendicular parking (forward/reverse) function from step 3. → P.485

INFORMATION

- If you feel that the vehicle is approaching close to a surrounding vehicle, object, person, or gutter

→ P.485

- When overwriting a registered parking space

If the maximum number of parking spaces have been registered and  is selected, a registered parking space can be selected and then overwritten with a new parking space.

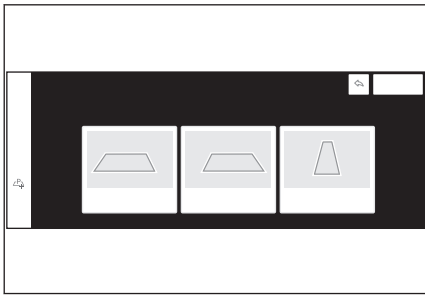

■ When multiple parking spaces are registered

Select the desired parking space, and then select [Start] button.

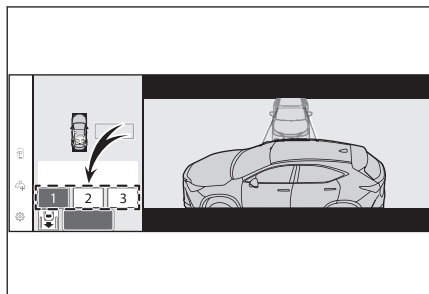

⚠ NOTICE

■ When using the memory function → P.482

- The memory function is a function which provides assistance in parking in a previously registered parking space. If the condition of the road surface, vehicle, or surrounding area differs from when registration was performed, the parking space may not be able to be detected correctly or assistance may not be provided to the point that the vehicle is fully parked.
- Do not register a parking space in situations such as the following, as the set parking space may not be able to be registered or assistance may not be possible later.
 - When a camera lens is dirty or covered with water droplets
 - When it is raining or snowing
 - When the surrounding area is dark (at night, etc.)
- In situations such as the following, it may not be possible to register a parking space.
 - When there is insufficient space between the road and parking space
 - When the road surface around the parking space does not have any differences the system can recognize
- If a parking space has been registered in situations such as the following, assistance may not be able to be started later or assistance to the registered position may not be possible.
 - When shadows are cast on the parking space (there is a carport over the parking space, etc.)

⚠ NOTICE

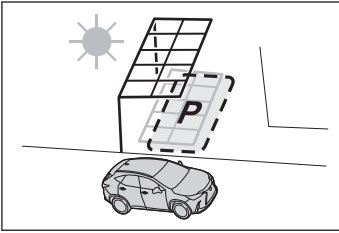

- When there are leaves, garbage, or other objects which will likely move, in the parking space
- When the road surface around the parking space has the same repeating pattern (brick, etc.)

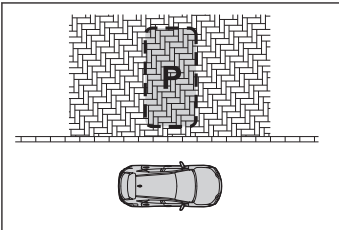

- In situations such as the following, it may not be possible for the system to provide assistance to a registered parking spot:
 - When the appearance of the parking space is affected by the shadow of the vehicle or trees
 - When an object is detected in the registered parking space
 - When a pedestrian or passing vehicle is detected during assistance
 - When the position the vehicle is stopped when assistance is started differs from the position when registration was performed
 - When the registered parking space cannot be reached due to the existence of parking blocks, etc.
 - When the road surface around the parking space has changed (road surface has degraded or been resurfaced)
 - When the sunlight conditions differ from when registration was performed (due to weather or time of day)
 - When the sun is shining directly into a camera, such as in the early morning or evening
 - When the color or brightness of the road surface is uneven
 - When a light is temporarily shined on the parking space (lights of another vehicle, security light, etc.)

NOTICE

- When the road surface around the parking space has the same repeating pattern
 - When there is a low protrusion on the road surface near the parking space
 - When the parking space is on a slope
 - When a camera has been splashed by hot or cold water and the lens has fogged up
 - When a camera lens is dirty or covered with water droplets
 - When accessories which obstruct the view of the camera are installed
- If assistance is ended during registration, perform registration again.
- When registering a parking space to the memory function, if the road surface cannot be detected "**No available parking space to register**" will be displayed.
 - When using the memory function, make sure to stop immediately in front of the stop position. Otherwise the parking space may not be able to be detected correctly or assistance may not be provided to the point that the vehicle is fully parked.
 - Do not use the memory function if a camera has been subjected to a strong impact or images of the panoramic view monitor are misaligned.
 - If a camera has been replaced, as the installation angle of the camera will have changed, it will be necessary to reregister parking spaces of the memory function.

Remote control function

■ Function description

A smartphone can be used to remotely operate the parking functions and exit functions. Also, assistance can be provided to remotely move the vehicle forward or backward into a garage, etc.

Parking using Remote control function

A smartphone can be used to remotely operate the parking function if the target parking space can be detected when the vehicle is stopped close and perpendicular to the center of the parking space. Also, depending on the condition of the parking space, etc., if it is necessary to change the direction of travel of the vehicle, the shift position can be changed by assistance control.

- 1 Stop the vehicle with it aligned near the center of the target parking space.
→ P.482
- 2 Press the Advanced Park main switch and check that a possible parking space is displayed on the center display. → P.482

- 3 Select the  button and then select [Perpendicular/parallel].
- 4 Select [OK] button.
- 5 Exit the vehicle while carrying the electronic key and smartphone, and then start the Remote Park app on the smartphone.

The detection area of the electronic key is within approximately 9.8 ft.(3 m) around the vehicle.

If there is an obstruction in the path of the vehicle, move it before parking the vehicle. A corn can also be moved after exit the vehicle.

- 6 From outside of the vehicle, confirm the parking space on the screen of the smartphone and then select the start button.

Start operation of Remote control function while standing approximately 1.6 ft. (50 cm) or more from the vehicle and out of the path of the vehicle.

- 7 Checking the safety of the area around the vehicle, trace the operation area on the screen of the smartphone continuously, the vehicle will move and parking assistance will be performed.

If operation of the screen of the smartphone is stopped, assistance can be suspended and the vehicle can be stopped. The doors are automatically locked before the vehicle starts moving.

- 8 When the parking space is reached, after the vehicle is stopped by the parking brake, the shift position will be changed to P, the power switch will be turned off, and the doors will be locked.

A completion screen will be displayed on the smartphone.



INFORMATION

■ The parking function can be used even if obstructions exist if

- When using the parking functions at a parking space made of white lines, even if an obstruction exists in the parking space, the space can be set as the target parking space. This allows for assistance to continue after setting a parking space from inside the vehicle and then exiting the vehicle to move an obstruction, such as a traffic cone placed in a handicapped parking space.
- When perpendicular parking using Advanced Park, 3 parking spaces on each side of the vehicle (up to 6 total) can be detected. However, when using Remote control function, only 1 parking space on each side of the vehicle can be detected.

Moving the vehicle forward and backward using Remote control function

After the vehicle is stopped, assistance can be provided to move the vehicle into a garage, etc., by using the forward and backward movement function.

- 1 Stop the vehicle at the location you would like to start assistance.

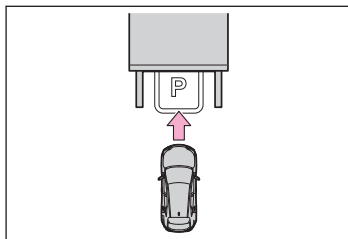

- 2 Press the Advanced Park main switch. → P.482
- 3 Select  and then select [Forward/reverse].
- 4 Select [OK].
- 5 Exit the vehicle while carrying the electronic key and smartphone, and then start the Remote Park app on the smartphone.

The detection area of the electronic key is within approximately 9.8 ft. (3 m) around the vehicle.

- 6 From outside of the vehicle, confirm the direction of travel on the screen of the smartphone and then select the start button.

Start operation of Remote control function while standing approximately 1.6 ft. (50 cm) or more from the vehicle and out of the path of the vehicle. The detection area of the electronic key is within approximately 9.8 ft. (3 m) around the vehicle.

- 7 Checking the safety of the area around the vehicle, trace the operation area on the screen of the smartphone continuously, the vehicle will move and parking assistance will be performed.

If operation of the screen of the smartphone is stopped, assistance can be suspended and the vehicle can be stopped. After assistance has been started, it can be stopped part way or the direction of travel of the vehicle can be changed.

- 8 Select the power button on the screen of the smartphone. The power switch will then turn OFF and the doors will lock automatically.

INFORMATION

■ Changing the direction of travel

While assistance is being performed, the direction of travel of the vehicle can be changed by the forward and reverse movement function. When there is a wall behind the vehicle, etc., by operating the direction of travel changing button on the screen of the smartphone, the vehicle can be slightly moved forward to allow loading of items and then moved back to its original position.

Exiting using Remote control function

Assistance can be provided to exit from a perpendicular or parallel parking space when the power switch OFF. When forward and backward movement is selected, the maximum distance the vehicle can move is 23.0 ft. (7 m) from the starting point and possible to change the direction of travel.

- 1 While near the parked vehicle, unlock the doors using the electronic key, and then start the Remote Park app on the smartphone.

If the smartphone cannot connect to the vehicle, using the electronic key, unlock the doors again.

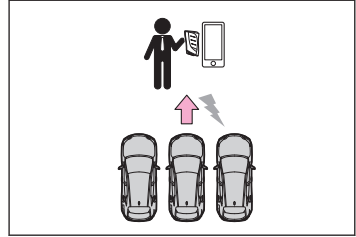

- 2 Select the start button on the screen of the smartphone.

The power switch will change to ON.

- 3 Check that a possible exit direction is displayed, select the exit direction.

- 4 Checking the safety of the area around the vehicle, trace the operation area on the screen of the smartphone continuously, the vehicle will move and parking assistance will be performed.

If operation of the screen of the smartphone is stopped, assistance can be suspended and the vehicle can be stopped. After assistance has been started, it can be stopped part way or the direction of travel of the vehicle can be changed.

- 5 Move the vehicle to the position where assistance ends and enter the vehicle while carrying the electronic key.

To stop assistance part way, stop operating the smartphone or enter the vehicle.

INFORMATION

Exit using the remote air conditioning

- While using the remote air conditioning, the assistance to exit can also be provided via remote function.
- When Remote control function is started while the remote air conditioning is operating, if tracing operations are not performed on a smartphone, assistance can be canceled by entering the vehicle and depressing the brake pedal.

Parking using the Remote control function and memory function

A smartphone can be used to remotely operate the memory function if the target parking space can be detected when the vehicle is stopped close to a parking space which was previously registered to the memory function. Also, depending on

6-2. Using the safe driving support functions

the condition of the parking space, etc., if it is necessary to change the direction of travel of the vehicle, the shift position can be changed by assistance control.

- 1 **Stop the vehicle with it aligned near the center of the target parking space.**
→ P.494
- 2 **Press the Advanced Park main switch, check that a possible parking space is displayed on the center display.** → P.494
- 3 **Select the  button and then select [Perpendicular/parallel].**
- 4 **[OK].**

If the [MODE] button is displayed, the button can be selected to change between the memory function, perpendicular parking (forward/reverse) function and parallel parking function.

- 5 **Exit the vehicle while carrying the electronic key and smartphone, and then start the Remote Park app on the smartphone.**

The detection area of the electronic key is within approximately 9.8 ft. (3 m) around the vehicle. If there is a cone or other obstruction in the path of the vehicle, move it after exiting the vehicle.

- 6 **From outside of the vehicle, confirm the parking space on the screen of the smartphone and then select the start button.**

Start operation of Remote control function while standing approximately 1.6 ft. (50 cm) or more from the vehicle and out of the path of the vehicle.

- 7 **Checking the safety of the area around the vehicle, trace the operation area on the screen of the smartphone continuously, the vehicle will move and parking assistance will be performed.**

If operation of the screen of the smartphone is stopped, assistance can be suspended and the vehicle can be stopped. The doors are automatically locked before the vehicle starts moving.

- 8 **When the parking space is reached, after the vehicle is stopped by the parking brake, the shift position will be changed to P, the power switch will be turned off, the doors will be locked and the mirrors will be closed .**

A completion screen will then be displayed on the smartphone.

Preparation before using Remote control function

Preparation before using

Make sure to perform the following before using Remote control function:

1. Download the Remote Park app from the app store.

2. Turn the power switch to ON and register the smartphone as a Bluetooth device to the multimedia system. For details on registering a Bluetooth device, refer to the "MULTIMEDIA OWNER'S MANUAL".
3. Setup the Remote Park app and register the vehicle.
4. The registered vehicle will be displayed on the screen of the smartphone. Select the vehicle.

The name and image of the vehicle can be changed on the new vehicle registration screen.

Vehicles can be added through the menu screen.

Remote control function on/off

- 1 Select  and then select [Advanced Park] on the center display.
- 2 Select [Remote Park] to turn it on/off. (The default setting is on.)
- 3 Press the Advanced Park main switch.

If the switch is pressed while assistance is being performed, the assistance will be canceled.

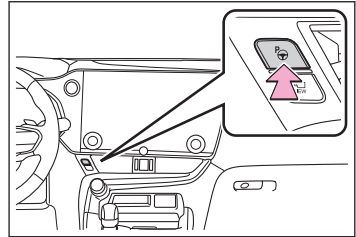

- 4 Select the  button displayed on the center display.

NOTICE

- When using Remote control function, make sure carry an electronic key in your pocket, etc.
- If an electronic key is held together with a smartphone, etc., the electronic key may not be able to be detected.
- Remote control function cannot be used when carrying only a digital key. The driver should always carry the electronic key.
- When entering the vehicle after using Remote control function, make sure that the electronic key is brought into the vehicle and all of the doors are closed.
After entering the vehicle and ending Remote control function operation, the seat return function will operate when the driver's seat seat belt is fastened or the brake pedal is depressed. (Vehicles with the power easy access system) The driver should always carry the electronic key.
- If the power switch is turned off when Remote control function operation has finished or been canceled, the doors will be locked automatically. However, if a

NOTICE

door is open, it may not be locked. Check the vehicle condition after Remote control function operation has finished.

- When the doors are locked after Remote control function operation has finished or been canceled, an alarm may sound if someone is detected inside the vehicle.

■ Situations in which the function may not operate correctly

- When the functions of the smart access system with push-button start may not operate correctly → P.108

- When the vehicle is near fluorescent lights

■ Radio wave interference → P.108

■ Electronic key battery consumption

- When Remote control function is being used, the electronic key battery will be used as the electronic key will continuously send and receive radio waves.

- If the electronic key battery is depleted → P.687

■ Situations in which the sensors may not operate properly

→ P.431

- When using Remote control function, visibility of the area around the vehicle may be limited. Make sure to check the following when using Remote control function:

- The vehicle and area around the vehicle are clearly visible
- There are no people, animals, or objects in the path of the vehicle
- An appropriate distance from the vehicle can be maintained and the safety of yourself and others can be ensured
- Caution for the area around the vehicle is always maintained and there is no potential for danger
- You can cancel Remote control function immediately if necessary

Advanced Park cancelation/suspension

■ Assistance will be canceled when

In situations such as the following, Advanced Park operation will be canceled.

As system operation has been canceled, begin the operation again or continue parking manually, using the steering wheel.

- The Advanced Park main switch is pushed
- The shift position has been changed to P
- The parking brake is engaged

- A door or the back door is opened
- The driver's seat belt is unfastened
- The outside rear view mirrors are folded
- The TRAC or VSC is turned off
- The TRAC, VSC or ABS operates
- The power switch is pressed
- The system determines assistance cannot be continued in the current parking environment
- The system malfunctions
- While the vehicle was stopped, [Cancel] was selected on the center display

■ Assistance will be suspended when

In situations such as the following, Advanced Park operation will be suspended.

Assistance can be started again by following the directions displayed on the center display.

Also, when assistance is suspended, if the shift position is changed twice with the brake pedal depressed, assistance will be canceled in that shift position. However, if assistance is suspended by changing the shift position, assistance will be canceled if the shift position is changed once.

- The steering wheel is operated
- The accelerator pedal is depressed
- The shift position has been changed
- Brake control operates
- Camera switch is pressed
- The PKSB (Parking Support Brake)/PCS (Pre-Collision System) has operates

■ Remote control function assistance will be canceled when

In situations such as the following, Remote control function operation will be canceled.

As system operation has been canceled, while carrying an electronic key, enter the vehicle and park the vehicle manually, using the steering wheel.

- When a condition for stopping Advanced Park assistance is met, with the exception suspension due to a door being opened or the driver's seat belt being released

6-2. Using the safe driving support functions

- When Remote control function is operated while the remote air conditioning is operating and the power switch is changed to ON before remote air conditioning has ended
- When 5 minutes have elapsed since Remote control function operation was started
- When 3 minutes have elapsed since any operation was performed
- When 30 seconds have elapsed with the vehicle not being able to be driven, even though the screen of the smartphone is being operated to drive the vehicle
- When the power button on the screen of the smartphone is selected
- When the Remote Park app is force closed
- When the vehicle is on a steep slope
- When an electronic key is detected inside the vehicle while Remote control function operation is suspended
- When the ambient temperature is 14°F (-10°C) or less

■ Remote control function assistance will be suspended when

In situations such as the following, assistance will be suspended.

- When the Bluetooth communication between the smartphone and multimedia system get lost
- When smartphone continuous operation is suspended
- When the Remote Park app is pushed to the background (a call is received, the home button is pressed, etc.)
- When electronic key does not detected
- When there is an obstruction in the movement direction of the vehicle
- When a charging cable is connected to the vehicle
- When the vehicle is operated while it is being driven by assistance
- When the smart key is operated while it is being driven by assistance
- When the door is unlocked while it is being driven by assistance
- When a door is opened while the vehicle is being driven

Changing the Advanced Park settings

Select  on the center display, and then select [Advanced Park].

■ [Remote Park]*

Remote control function can be turned on/off.

■ [Speed Profile]

The vehicle speed for when assistance is performed can be set.

This setting cannot be changed when registering a parking space to the memory function.

■ [Detect. range]

The distance from which obstacles will be avoided while assistance is being performed can be set.

■ [Prk. Method]

The preferred parking direction displayed when at a parking space which perpendicular (forward/reverse) or parallel parking is possible can be set.

■ [Prk. direction]

The preferred parking direction displayed when it is possible to pull perpendicular forward or reverse into a parking space can be selected.

■ [Exit dir.: Per.]

The preferred exit direction displayed when it is possible to pull forward or reverse to the left or right out of a parking space can be selected.

■ [Exit dir.: Par.]

The preferred exit direction displayed when it is possible to exit to the left or right from a parallel parking space can be selected.

■ [Parking view]

The display angle of the camera image when using the perpendicular parking (forward/reverse) function or parallel parking function can be set.

■ [Exit view]

The display angle of the camera image when using the perpendicular exiting (forward/reverse) function or parallel parking exit function can be set.

■ [Parking Path Adjustment]

The course for when parking assistance is operating can be adjusted inward or outward.

If the tires are worn, the path of vehicle may be offset from the center of the parking space. In this case, use this setting to adjust the parking course.

■ [Road Width Adjustment]

When parking assistance is started, the amount of lateral movement while the vehicle is moving forward can be adjusted.

*: If equipped

■ [Park Position Adjustment(fwd.)]

The position at which perpendicular parking (forward/reverse) is completed can be adjusted. (Except when using the memory function.)

■ [Park Position Adjustment(rev.)]

The position at which perpendicular parking (forward/reverse) is completed can be adjusted. (Except when using the memory function.)

■ [Rear Accessory Setting]

If an accessory, such as a trailer hitch, has been installed to the rear of the vehicle, the length of the rear of the vehicle can be adjusted to help avoid colliding with objects to the rear of the vehicle.

■ [Clear Registered Parking Space]

The parking spaces registered to the memory function can be deleted. Parking space information cannot be deleted when assistance is being performed or when registering parking space information to the memory function.

Changing the Remote Park app settings

■ Lexus parking assist-sensor warning sound ON/OFF (Smartphone setting)

The warning sounds of the Lexus parking assist-sensor from smartphone application can be turned on/off using the Remote Park app.

■ Lexus parking assist-sensor warning sound volume adjustment (Smartphone setting)

The volume of the warning sounds of the Lexus parking assist-sensor from smartphone application can be adjusted using the Remote Park app.

Advanced Park displayed messages

The operating state, assistance operation, etc. of the Advanced Park is displayed on the center display. If a message is displayed, respond according to the content displayed.

INFORMATION

■ "No available parking space" is displayed

Move the vehicle to a location where a parking space or parking lines can be detected.

■ If "Unavailable in current condition" is displayed

Move the vehicle to another location and use the system.

■ "Not enough space to exit" is displayed

The parallel parking exit function cannot be used due to a situation such as the distance between your vehicle and vehicles parked in front of and behind your vehicle being short, the existence of an object in the exit direction, etc.

Check the conditions of the area around your vehicle and exit from the parking space manually.

■ "Cannot control speed" is displayed

The system judged that it cannot adjust the speed of the vehicle when using the system in an area with a slope or step and assistance was canceled.

Use the system in a level location.

■ If "Obstacle detected" is displayed

The emergency support brake operated and assistance was suspended.

Check the condition of the surrounding area. To resume assistance, select the [Start] button on the center display.

■ "No available parking space to register" is displayed

This message is displayed when  is selected at a parking space that cannot be detected.

Operate the system at a parking space where differences in the road surface can be recognized. → P.494



Road Sign Assist

RSA (Road Sign Assist)



Vehicles with a navigation system: The RSA system detects specific road signs using the front camera and/or navigation system (when speed limit information is available) and warns the driver via displays and buzzers.

WARNING

For safe use

-  Driving safely is solely the responsibility of the driver. Pay careful attention to the surrounding conditions in order to ensure safe driving.
-  Do not rely solely upon the RSA. The RSA assists the driver by providing road sign information, but it is not a replacement for the driver's own vision and awareness. Driving safely is solely the responsibility of the driver. Pay careful attention to the surrounding conditions in order to ensure safe driving.

Situations in which the RSA should not be used

-  When it is necessary to disable the system: → P.373
-  Situations in which the system may not operate properly
-  Situations in which the sensors may not operate properly: → P.378

Displays on the display

When the front camera detects a sign or information of a sign is available from the navigation system, the sign will be displayed on the display.

-  Multiple signs can be displayed.

Depending on the specifications of the vehicle, the number of displayed signs may be limited.



INFORMATION

Operating conditions of sign display

Signs will be displayed when the following conditions are met:

-  The system has detected a sign

In the following situations, a displayed sign may stop being displayed:

-  When a new sign has not been detected for a certain distance
-  When the system determines that the road being driven on has changed, such as after a left or right turn

■ Situations in which the display function may not operate properly

In the following situations, the RSA system may not operate properly and may not detect signs or may display the incorrect sign. However, this does not indicate a malfunction.

- When a sign is dirty, faded, tilted or bent
- When the contrast of an electronic sign is low
- When all or part of a sign is hidden by a tree, utility pole, etc.
- When a sign is detected by the front camera for a short amount of time
- When the driving state (turning, changing lanes, etc.) is judged incorrectly
- When a sign is immediately after a freeway junction or in an adjacent lane just before merging
- When stickers are attached to the rear of a preceding vehicle
- When a sign similar to a system compatible sign is detected as a system compatible sign
- When a speed limit sign for a frontage road is within detection range of the front camera
- When driving around a roundabout
- When a sign intended for trucks, etc. is detected
- When the navigation system map data is out of date
- When the navigation system cannot be used

In this case, the speed limit signs displayed on the multi-information display and navigation system display may differ.

■ Notification function

In the following situations, the RSA system will output a warning to notify the driver.

- If the vehicle speed exceeds the speed warning threshold of the speed limit sign displayed on the display, the sign display will be emphasized and a buzzer will sound.
- When the RSA system detects a do not enter sign and determines that the vehicle has entered a no-entry area, the do not enter sign displayed on the display will flash and a buzzer will sound.

□ INFORMATION

■ Operating conditions of the notification functions

- Excess speed notification function

This function will operate when the following condition is met:

- A speed limit road sign is recognized by the system.

6-2. Using the safe driving support functions

- No entry notification function







This function will operate when all of the following conditions are met:

- More than one no entry road signs are recognized by the system simultaneously.
- The vehicle is passing between no entry road signs recognized by the system.

Types of road signs supported

- The following types of road signs can be displayed.

However, non-standard or recently introduced traffic signs may not be displayed.

	Speed limit
	Do Not Enter
	No U-turn
	No Turn On Red
	Stop
	Yield
	Warning

- Depending on the specifications of the vehicle, signs may be displayed overlapping.

	Duplicate display example
---	---------------------------

Changing RSA settings

The following settings of the RSA can be changed through customize settings.
→ P.776

Dynamic radar cruise control

Dynamic radar cruise control

This dynamic radar cruise control uses radar to detect the presence of vehicles ahead, determines the current vehicle-to-vehicle distance, and operates to maintain a suitable distance from the vehicle ahead. The desired vehicle-to-vehicle distance can be set by operating the vehicle-to-vehicle distance switch.

Use the dynamic radar cruise control only on highways and expressways.

▲ WARNING

■ For safe use

- Driving safely is solely the responsibility of the driver. Do not overly rely on this system, and pay careful attention to the surrounding conditions in order to ensure safe driving.
- The dynamic radar cruise control provides driving assistance to reduce the driver's burden. However, there are limitations to the assistance provided.

Read the following items carefully. Do not overly rely on this system and always drive carefully.

- Conditions under which the system may not operate correctly: → P.519
- Set the speed appropriately according to the speed limit, traffic flow, road conditions, weather conditions, etc. The driver is responsible for confirming the set speed.
- Even if the system is operating correctly, the condition of a preceding vehicle as recognized by the driver and detected by the system may differ. Therefore, it is necessary for the driver to pay attention, assess risks, and ensure safety. Over-reliance on this system to drive the vehicle safely may lead to an accident resulting in death or serious injury.

■ Precautions for the driving assist systems

Observe the following precautions, as there are limitations to the assistance provided by the system. Over-reliance on this system may lead to an accident resulting in death or serious injury.

- Details of support provided for the driver's vision

The dynamic radar cruise control is only intended to help the driver in determining the distance between the driver's own vehicle and a designated preceding vehicle. It is not a system which allows for careless or inattentive driving, and is not a system which assists in poor visibility conditions.

The driver must pay attention to their surroundings, even when the vehicle stops.

- Details of support provided for the driver's judgement

⚠ WARNING

The dynamic radar cruise control determines whether the distance between the driver's own vehicle and a designated preceding vehicle is within a set range. It is not capable of making any other type of judgement. Therefore, it is absolutely necessary for the driver to remain vigilant and to determine whether or not there is a possibility of danger.

● Details of support provided for the driver's operation

The dynamic radar cruise control does not include functions which will prevent or avoid collisions with vehicles ahead of your vehicle. Therefore, if there is ever any possibility of danger, the driver must take immediate and direct control of the vehicle and act appropriately in order to ensure safety.

■ **Situations in which the dynamic radar cruise control should not be used**

Do not use the dynamic radar cruise control in the following situations. As the system will not be able to provide appropriate control, using it may lead to an accident resulting in death or serious injury.

- Roads where there are pedestrians, cyclists, etc.
- When driving on a highway or expressway entrance or exit
- When the approach warning sounds frequently
- Situations in which the sensors may not operate properly: → P.378
- Situations in which the lane may not be detected: → P.373

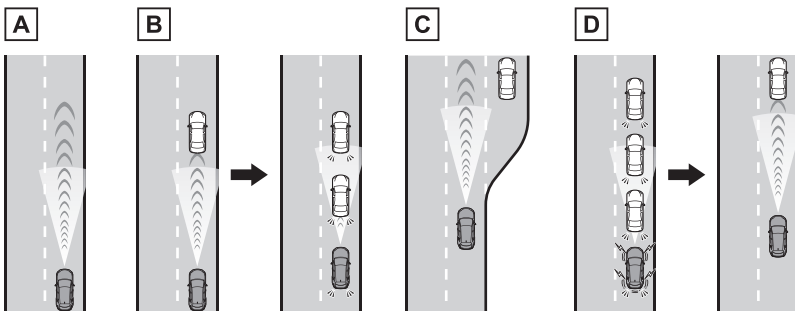
Basic functions

6-2. Using the safe driving support functions

A Constant speed cruising:

When there are no vehicles ahead

The vehicle drives at the speed set by the driver.

If the set vehicle speed is exceeded while driving down a hill, the set vehicle speed display will blink and a buzzer will sound.

B Deceleration and follow-up cruising

When a preceding vehicle driving slower than the set vehicle speed is detected

When a vehicle is detected driving ahead of your vehicle, the vehicle automatically decelerates and if a greater reduction in vehicle speed is necessary, the brakes are applied (the stop lights will come on at this time). The vehicle is controlled to maintain the vehicle-to-vehicle distance set by the driver, in accordance with changes in the speed of the preceding vehicle. If vehicle deceleration is not sufficient and the vehicle approaches the vehicle ahead, the approach warning will sound.

C Acceleration

When there are no longer any preceding vehicles driving slower than the set vehicle speed

The vehicle accelerates until the set vehicle speed is reached and then resumes constant speed cruising.

D Starting off:

If a preceding vehicle stops, the vehicle will also stop (controlled stop). After the preceding vehicle starts off, pressing the [+] switch or depressing the accelerator pedal will resume follow-up cruising (start off operation). If a start off operation is not performed, the controlled stop will continue.

INFORMATION

■ Operating conditions

- The shift position is in D.
- The desired set speed can be set when the vehicle speed is approximately 20 mph (30 km/h) or more.

(If the vehicle speed is set while driving at below approximately 20 mph [30 km/h], the set speed will be set to approximately 20 mph [30 km/h].)

■ Accelerating after setting the vehicle speed

As with normal driving, acceleration can be performed by depressing the accelerator pedal. After accelerating, the vehicle will return to the set vehicle speed. However, while in vehicle-to-vehicle distance control mode, the vehicle speed may decrease to below the set vehicle speed in order to maintain the distance from the preceding vehicle.

■ When the vehicle is stopped by system control during follow-up cruising

- When the [RES] switch is pressed while the vehicle is stopped by system control, if the preceding vehicle starts off within approximately 3 seconds, follow-up cruising will resume.
- If the preceding vehicle starts off within approximately 3 seconds of the vehicle being stopped by system control, follow-up cruising will resume.

■ Automatic cancellation of vehicle-to-vehicle distance control mode

In the following situations, vehicle-to-vehicle distance control mode will be canceled automatically:

- When the brake control or output restriction control of a driving support system operates (For example: Pre-Collision System, drive-start control)
- When the parking brake has been operated
- When the vehicle is stopped by system control on a steep incline
- When any of the following are detected while the vehicle is stopped by system control:
 - The driver's seat belt is unfastened
 - The driver's door is opened
 - Approximately 3 minutes have elapsed since the vehicle was stopped
- Situations in which some or all of the functions of the system cannot operate: → P.380

■ Dynamic radar cruise control system warning messages and buzzers

For safe use: → P.373

■ Preceding vehicles that the sensor may not detect correctly

In the following situations, depending on the conditions, if the system cannot provide sufficient deceleration or acceleration is necessary, operate the brake pedal or accelerator pedal.

As the sensor may not be able to correctly detect these types of vehicles, the approach warning (→ P.524) may not operate.

- When a vehicle cuts in front of your vehicle or changes lanes away from your vehicle extremely slowly or quickly
- When changing lanes
- When a preceding vehicle is driving at a low speed
- When a vehicle is stopped in the same lane as the vehicle
- When a motorcycle is traveling in the same lane as the vehicle

■ Conditions under which the system may not operate correctly

In the following situations, operate the brake pedal (or accelerator pedal, depending on the situation) as necessary.

6-2. Using the safe driving support functions

As the sensor may not be able to correctly detect a vehicle, the system may not operate properly.

- When a preceding vehicle brakes suddenly
- When changing lanes at low speeds, such as in a traffic jam

System components

■ Meter display

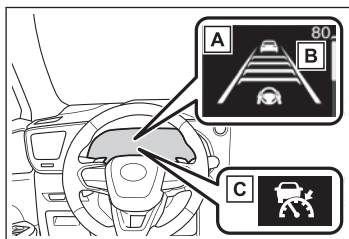

- A Multi-information display
- B Set vehicle speed
- C Indicators

■ Switches

► Vehicles without a head-up display

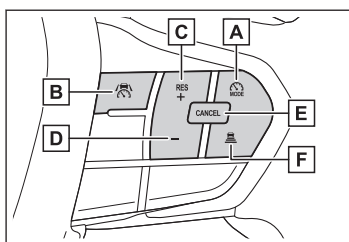

- A Driving assist mode select switch
- B Driving assist switch
- C [+] switch, [RES] switch
- D [-] switch
- E Cancel switch
- F Vehicle-to-vehicle distance switch

► Vehicles with a head-up display

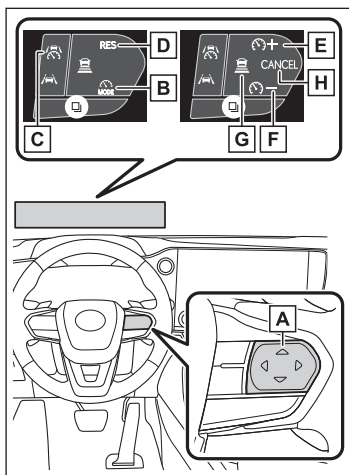

- A The function of each switch differs depending on the conditions and settings.

When a switch is touched, the function of each switch is displayed on the head-up display. If the head-up display is off, the functions will be displayed on the multi-information display.

- B Driving assist mode select switch
- C Driving assist switch
- D [RES] switch
- E [+]switch
- F [-]switch
- G Vehicle-to-vehicle distance switch
- H Cancel switch

Using the dynamic radar cruise control

Setting the vehicle speed

- 1 Press the driving assist mode select switch to select dynamic radar cruise control.

The dynamic radar cruise control indicator will illuminate.

► Vehicles without a head-up display

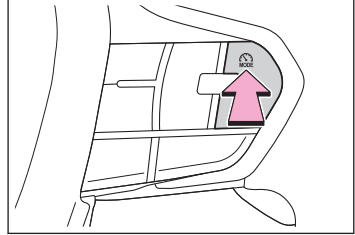

► Vehicles with a head-up display

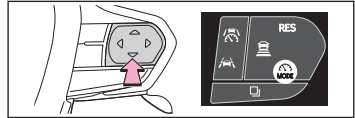

- 2 Using the accelerator pedal, accelerate or decelerate to the desired vehicle speed (approximately 20 mph [30 km/h] or more), and press the driving assist switch to set the set vehicle speed.

The set vehicle speed will be displayed on the multi-information display.

The vehicle speed at the moment the switch is released will be the set vehicle speed.

► Vehicles without a head-up display

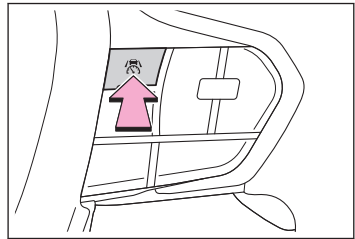

► Vehicles with a head display



Adjusting the set vehicle speed

■ Adjusting the set vehicle speed using the switches

- To change the set vehicle speed, press the [+] or [-] switch until the desired speed is displayed.

► Vehicles without a head-up display:

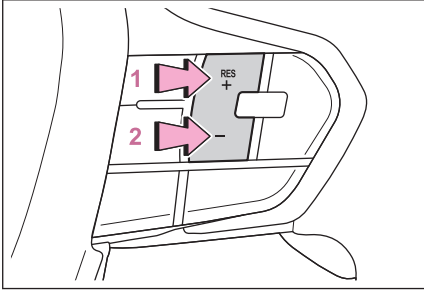

► Vehicles with a head-up display:

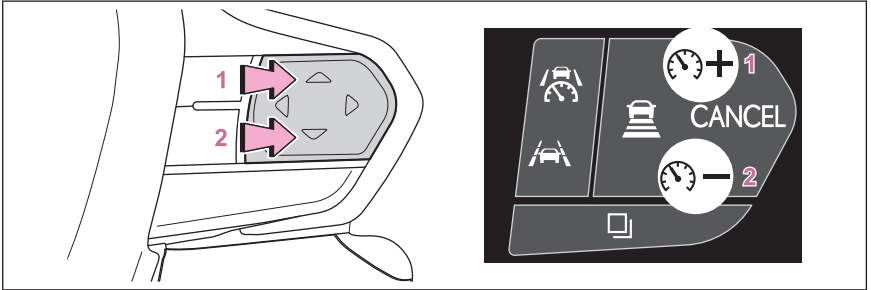

- 1 Increase set vehicle speed
- 2 Decrease set vehicle speed

Short press adjustment : Press the switch

Press and hold adjustment : Press and hold the switch until the desired set vehicle speed is reached.

The set vehicle speed will increase or decrease as follows:

● For U.S.A.

Short press adjustment : Increases or decreases by 1 mph (1.6 km/h) each time the switch is pressed

Press and hold adjustment : Increases or decreases in 1 mph (1.6 km/h) increments continuously while the switch is pressed and held

● Except for U.S.A.

Short press adjustment : By 1 km/h (0.6 mph) or 1 mph (1.6 km/h) each time the switch is pressed

Press and hold adjustment : Increases or decreases in 5 km/h (3.1 mph) or 5 mph (8 km/h) increments continuously while the switch is pressed and held

■ Increasing the set vehicle speed using the accelerator pedal

- 1 Depress the accelerator pedal to accelerate the vehicle to the desired vehicle speed.
- 2 Press the [+] switch.

Canceling/resuming control

- 1 Press the cancel switch or driving assist switch to cancel control.

Control will also be canceled if the brake pedal is depressed.

(If the vehicle has been stopped by system control, depressing the brake pedal will not cancel control.)

▶ Vehicles without a head-up display

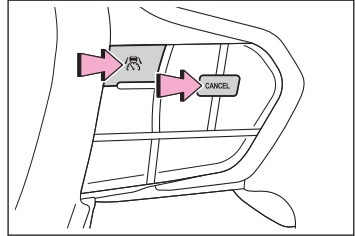

▶ Vehicles with a head-up display

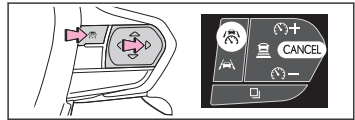

- 2 Press the [RES] switch to resume control.

Changing the vehicle-to-vehicle distance

- Each time the switch is pressed, the vehicle-to-vehicle distance setting will change as follows:

If a preceding vehicle is detected, the preceding vehicle mark will be displayed.

Illustration Number	Vehicle-to-vehicle distance	Approximate Distance (Vehicle Speed: 60 mph [100 km/h])
1	Extra long	Approximately 200 ft (60 m)
2	Long	Approximately 145 ft (45 m)
3	Medium	Approximately 100 ft (30 m)

▶ Vehicles without a head-up display

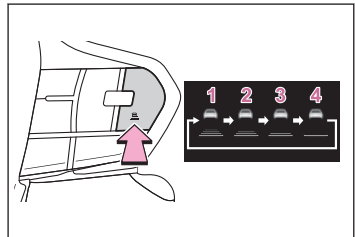

▶ Vehicles with a head-up display

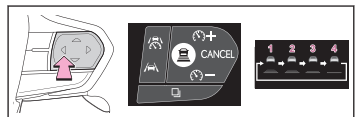

6-2. Using the safe driving support functions

Illustration Number	Vehicle-to-vehicle distance	Approximate Distance (Vehicle Speed: 60 mph [100 km/h])
4	Short	Approximately 85 ft (25 m)

The actual vehicle-to-vehicle distance varies in accordance with the vehicle speed. Also, when the vehicle is stopped by system control, it will be stopped at a certain distance from the preceding vehicle, depending on the situation, regardless of the setting.

Approach warning

In situations where the vehicle approaches a preceding vehicle and the system cannot provide sufficient deceleration, such as if a vehicle cuts in front of the vehicle, a warning display will flash and a buzzer will sound to alert the driver. Depress the brake pedal to ensure appropriate vehicle-to-vehicle distance.

■ Warnings may not occur when

In the following situations, the warning may not operate even though the vehicle-to-vehicle distance is short.

- When the preceding vehicle is traveling at the same speed or faster than your vehicle
- When the preceding vehicle is traveling at an extremely low speed
- Immediately after the vehicle speed has been set
- When the accelerator pedal is depressed

Curve speed reduction function

When a curve is detected, the vehicle speed will begin being reduced. When the curve ends, the vehicle speed reduction will end.

Depending on the situation, the vehicle speed will then return to the set vehicle speed.

In situations where vehicle-to-vehicle distance control needs to operate, such as when a preceding vehicle cuts in front of your vehicle, the curve speed reduction function will be canceled.



□ INFORMATION

■ Situations in which the curve speed reduction function may not operate

In situations such as the following, the curve speed reduction function may not operate:

- When the vehicle is being driven around a gentle curve
- When the accelerator pedal is being depressed
- When the vehicle is being driven around an extremely short curve

■ **Changing the settings of the curve speed reduction function**

Various settings of the curve speed reduction function can be changed through customize settings. (→ P.775)

Support for lane change

If your vehicle is being driven at approximately 50 mph (80 km/h) or more and a lane change to the passing lane is performed, when the turn signal lever is operated and the lane is changed, the vehicle will accelerate up to the set speed to assist in overtaking.

The system's recognition of which lane is the passing lane may be based solely on the location of the steering wheel in the vehicle (left-hand drive/right-hand drive). If the vehicle is driven in a location where the passing lane is on the opposite side of that where the vehicle was originally sold, the vehicle may accelerate when the turn signal lever is operated away from the passing lane. (e.g. The vehicle was manufactured for a right-hand traffic location, but is being driven in a left-hand traffic location. The vehicle may accelerate when the turn signal lever is operated to the right.)

If your vehicle is being driven at approximately 50 mph (80 km/h) or more and the lane is changed to that with a vehicle traveling slower than your vehicle, when the turn signal lever is operated the vehicle will gradually decelerate to assist in changing lanes.

Cruise Control

Cruise control

The vehicle can be driven at a set speed even if the accelerator pedal is not depressed.

Use the cruise control only on highways and expressways

⚠ WARNING

■ For safe use

- Driving safely is solely the responsibility of the driver. Therefore, do not overly rely on this system. The driver is solely responsible for paying attention to the vehicle's surroundings and driving safely.
- Set the speed appropriately according to the speed limit, traffic flow, road conditions, weather conditions, etc. The driver is responsible for confirming the set speed.

■ Situations in which cruise control should not be used

Do not use the cruise control in the following situations. As the system will not be able to provide appropriate control, using it may lead to an accident resulting in death or serious injury.

- On roads with sharp bends
- On winding roads
- On slippery roads, such as those covered with rain, ice or snow
- On steep downhills, or where there are sudden changes between sharp up and down gradients

Vehicle speed may exceed the set speed when driving down a steep hill.

- When it is necessary to disable the system: → P.373

System Components

■ Meter display

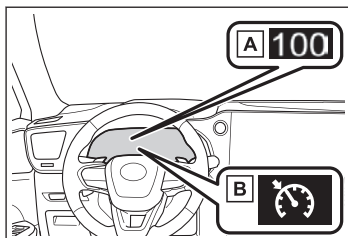

- A Set vehicle speed
- B Cruise control indicator

Switches

► Vehicles without a head-up display:

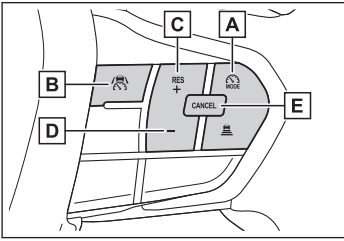

- A Driving assist mode select switch
- B Driving assist switch
- C [+] switch, [RES] switch
- D [-] switch
- E Cancel switch

► Vehicles with a head-up display:

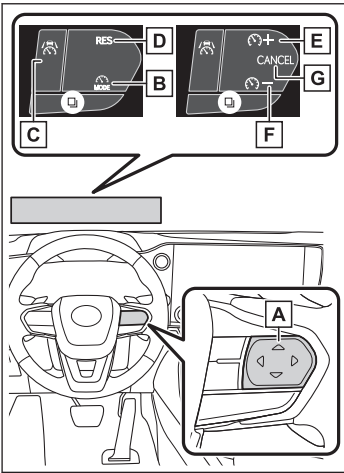

- A The function of each switch differs depending on the conditions and settings.

When a switch is touched, the function of each switch is displayed on the head-up display. If the head-up display is off, the functions will be displayed on the multi-information display.

- B Driving assist mode select switch
- C Driving assist switch
- D [RES] switch
- E [+] switch
- F [-] switch
- G Cancel switch

Using the cruise control

Setting the vehicle speed

- 1 Press the driving assist mode select switch to select cruise control.

The cruise control indicator will illuminate.

► Vehicles without a head-up display

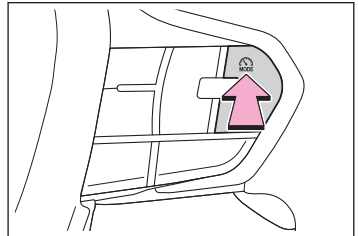

► Vehicles with a head-up display

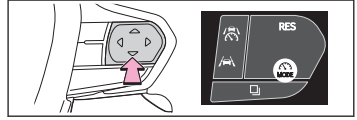

- 2 Using the accelerator pedal, accelerate to the desired vehicle speed (approximately 20 mph [30 km/h] or more), and press the driving assist switch to set the set vehicle speed.

The vehicle speed at the moment the switch is released will be the set vehicle speed.

► Vehicles without a head-up display

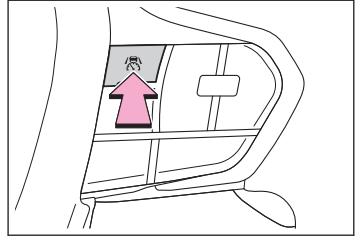

► Vehicles with a head-up display



Adjusting the set vehicle speed

■ Adjusting the set vehicle speed using the switches

- To change the set vehicle speed, press the [+] or [-] switch until the desired speed is displayed.

► Vehicles without a head-up display

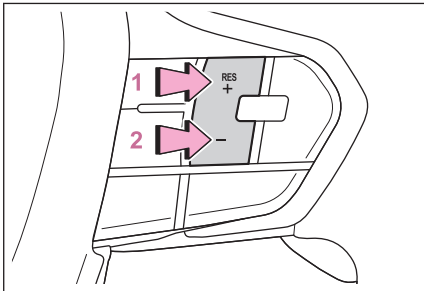

► Vehicles with a head-up display

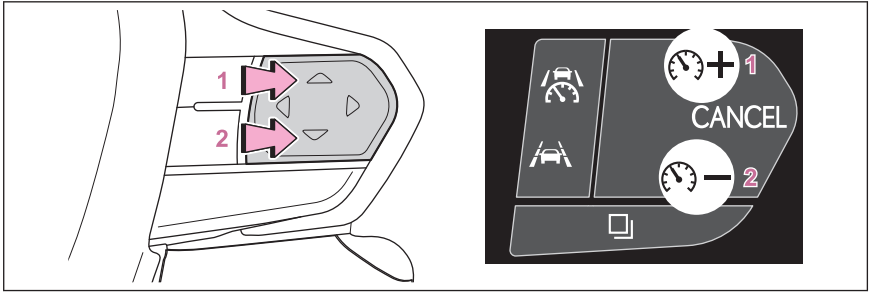

- 1 Increase set vehicle speed
- 2 Decrease set vehicle speed

The set vehicle speed will increase or decrease as follows:

Fine adjustment: By 1 mph (1.6 km/h) or 1 km/h (0.6 mph) each time the switch is pressed

Large adjustment: Increases continuously while the switch is pressed and held

■ Increasing the set vehicle speed using the accelerator pedal

- 1 Depress the accelerator pedal to accelerate the vehicle to the desired vehicle speed.
- 2 Press the [+] switch.

Canceling/resuming control

- 1 Press the cancel switch or driving assist switch to cancel control.

Control will also be canceled if the brake pedal is depressed.

► Vehicles without a head-up display

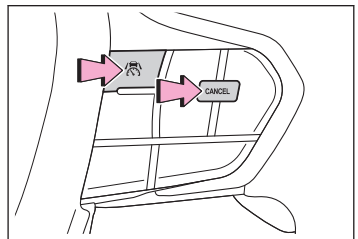

► Vehicles with a head-up display

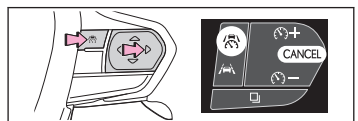

- 2 Press the [RES] switch to resume control.

Automatic cancellation of the cruise control

In the following situations, the cruise control will be canceled automatically:

- When the vehicle speed drops approximately 10 mph (16 km/h) or more below the set vehicle speed
- When the vehicle speed drops below approximately 20 mph (30 km/h)
- When the brake control or output restriction control of a driving support system operates (For example: PCS, drive-start control)
- When the parking brake has been operated
- Situations in which some or all of the functions of the system cannot operate: → [P.380](#)

Emergency Driving Stop System





Emergency Driving Stop System

The emergency driving stop system is a system which automatically decelerates and stops the vehicle within its lane if the driver becomes unable to continue driving the vehicle, such as if they have suffered a medical emergency, etc.

During LTA (Lane Tracing Assist) control, if the system does not detect driving operations, such as if the driver is not holding the steering wheel, and determines the driver is not responsive, the vehicle will be decelerated and stopped within its current lane to help avoid a collision or reduce the impact of a collision.

WARNING

For safe use

-  Driving safely is solely the responsibility of the driver. Pay careful attention to the surrounding conditions in order to ensure safe driving. The emergency driving stop system is designed to provide support in an emergency where it is difficult for the driver to continue driving, such as if they have had a medical emergency. It is not designed to support driving while drowsy or in poor physical health, or inattentive driving.
-  Although the emergency driving stop system is designed to decelerate the vehicle within its lane to help avoid or help reduce the impact of a collision if the system determines that it is difficult for the driver to continue driving, its effectiveness may change according to various conditions. Therefore, it may not always be able to achieve the same level of performance. Also, if the operating conditions are not met, this function will not operate.
-  After the emergency driving stop system operates, if driving becomes possible again, immediately begin driving again or, if necessary, park the vehicle on the shoulder of the road and set a warning reflector and flare to warn other drivers of your stopped vehicle.
-  After this system operates, passengers should attend to the driver as necessary and take appropriate hazard prevention measures, such as moving to a place where safety can be ensured, such as the shoulder of the road or behind a guardrail.
-  This system detects the condition of the driver through the operation of the steering wheel. This system may operate if the driver is aware but intentionally and continuously does not operate the vehicle. Also, the system may not operate if it cannot determine that the driver is not responsive, such as if they are leaning on the steering wheel.

Summary of the system

Operation of this system is separated into 4 control states. Through control state "warning phase 1" and "warning phase 2", the system determines if the driver is aware and responsive while outputting a warning and controlling the vehicle speed. If the system determines the driver is not responsive, it will operate in control state "deceleration stop phase" and "stop hold phase" and decelerate and stop the vehicle. It will then operate continuously in "stop hold phase".

INFORMATION

■ Operating conditions

This system operates when all of the following conditions are met:

- When the LTA is on
- When the vehicle speed is approximately 30 mph (50 km/h) or more

■ Operation cancelation conditions

In the following situations, system operation will be canceled:

- When LTA control has been canceled (the LTA switch has been pressed, etc.)
- When the dynamic radar cruise control has been canceled
- When driver operations are detected (the steering wheel is held, the brake pedal, accelerator pedal, parking brake, hazard light switch, or turn signal lever is operated)
- When the driving assist switch is pressed while in the stop and hold phase
- When the power switch has been turned from ON to OFF
- Situations in which some or all of the functions of the system cannot operate: → P.380

■ LTA control when operation is canceled

When emergency driving stop system operation is canceled, LTA control may also be canceled.

Warning phase 1

If driving operations are not detected after the hands off steering wheel warning operates, a buzzer will sound intermittently and a message will be displayed to warn the driver, and the system will judge if the driver is responsive or not. If driving operations, such as holding the steering wheel, are not performed within a certain amount of time, the system will enter warning phase 2.

Warning phase 2

After entering warning phase 2, a buzzer will sound in short intervals and a message will be displayed to warn the driver, and the vehicle will slowly decelerate to approximately 30 mph (50 km/h).

If driving operations, such as holding the steering wheel, are not performed within a certain amount of time, the system will determine that the driver is not responsive and enter the deceleration stop phase.

The audio system will be muted until the driver becomes responsive.

When the vehicle is decelerating, the brake lights may illuminate, depending on the road conditions, etc.

Deceleration stop phase

After entering the deceleration stop phase, a buzzer will sound continuously and a message will be displayed to warn the driver, and the vehicle will slowly decelerate and stop. After the vehicle stops, the system will enter the stop and hold phase.

Stop hold phase

After the vehicle is stopped, the parking brake will be applied automatically. After entering the stop and hold phase, the buzzer will continue sounding continuously and the emergency flashers (hazard lights) will flash to warn other drivers of the emergency.

Hybrid system output restriction when the accelerator pedal and brake pedal are depressed at the same time

Purpose of the brake override system

If the accelerator pedal and brake pedal are depressed at the same time, the brake override system may operate and restrain the hybrid system output. A warning message is displayed on the multi-information display while the system is operating.

WARNING

To avoid depressing the wrong pedal, become familiar with the location of the brake pedal and accelerator pedal before driving the vehicle.

If the accelerator pedal is mistaken for the brake pedal and depressed, the vehicle may suddenly start off.

NOTICE

Do not depress the accelerator pedal and brake pedal at the same time while driving, as this may cause the hybrid system output to be restrained.

Sudden start restraint control

Sudden start restraint control (Drive-Start Control [DSC])

When the following unusual operation is performed with the accelerator pedal depressed, the hybrid system output may be restrained.

- When the shift lever is shifted to R*1
- When the shift lever is shifted from P or R to forward drive shift position such as D*1

When the system operates, a message appears on the multi-information display. Read the message and follow the instruction.

A warning light comes on while the system is operating.

INFORMATION

■ Drive-Start Control (DSC)

When the TRAC is turned off, sudden start restraint control also does not operate. If your vehicle have trouble escaping from the mud or fresh snow due to sudden start restraint control operation, deactivate TRAC so that the vehicle may become able to escape from the mud or fresh snow.

Also, sudden start restraint control will not operate in the following conditions:

- When Trail Mode is turned on

— Related Links —

[Driving assist systems\(P. 381\)](#)

*1: Depending on the situation, the shift position may not be changed.

Reducing impact to passengers in a collision

Seat belt pretensioners

When the vehicle is subjected to a severe frontal or side impact or rollover, the pretensioners retract the seat belts of the front seats and rear outer seats to securely restrain the occupants.

The pretensioners will not operate in minor frontal or side impacts, or rear impacts.

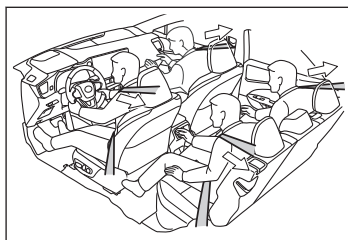

INFORMATION

■ Replacing the belt after the pretensioner has been activated

If the vehicle is involved in multiple collisions, the pretensioner will activate for the first collision, but will not activate for the second or subsequent collisions.

■ PCS-linked control

If the PCS (Pre-Collision System) determines that the possibility of a collision with a vehicle is high, the seat belt pretensioners will be prepared to operate.

⚠ WARNING

■ Seat belt pretensioners

Observe the following precautions to reduce the risk of injury in the event of sudden braking or an accident. Failure to do so may result in death or serious injury.

- Do not place anything, such as a cushion, on the front passenger's seat.

Doing so will disperse the passenger's weight, which prevents the sensor from detecting the passenger's weight properly. As a result, the seat belt pretensioner for the front passenger's seat may not operate in the event of a collision.

- If a pretensioner has operated, the SRS warning light will illuminate.

In this situation, the seat belt cannot be used and must be replaced by your Lexus dealer.

SRS airbags

The SRS airbags deploy when the vehicle is subjected to certain types of severe impact that may cause significant injury to the occupants. The airbags work together with the seat belts to help reduce the risk of death or serious injury.

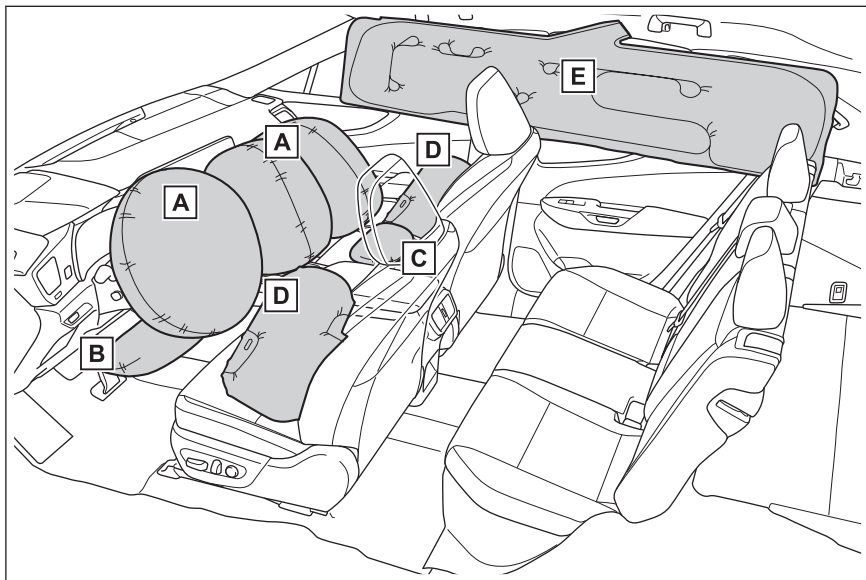

- A** SRS driver airbag/front passenger airbag
 - Help reduce impact to the head and chest of the driver and front passenger
- B** SRS knee airbags
 - Help reduce impact to the driver
- C** SRS seat cushion airbags
 - Helps reduce impact to the front passenger
 - Help restrain the occupant of a rear seat
- D** SRS side airbags
 - Help reduce impact to the chest of the occupants of the front seats
- E** SRS curtain shield airbags
 - Help reduce impact to the heads of the occupants of the front and rear outer seats
 - Can help prevent the occupants from being thrown from the vehicle in the event of vehicle rollover

Your vehicle is equipped with ADVANCED AIRBAGS designed based on US motor vehicle safety standards (FMVSS208). The airbag sensor assembly (ECU) controls airbag deployment based on information obtained from the sensors, etc.,

6-3. Reducing impact to the occupants in a collision

shown in the system components diagram above. This information includes crash severity and occupant information. As the airbags deploy, a chemical reaction in the inflators quickly fills the airbags with non-toxic gas to help restrain the motion of the occupants.

INFORMATION

■ If the SRS airbags deploy (inflate)

- Slight abrasions, burns, bruising, etc., may be sustained from SRS airbags, due to the extremely high speed of deployment (inflation) by hot gases.
- A loud noise and white powder will be emitted.
- Parts of the airbag module (steering wheel hub, airbag cover and inflator) as well as the parts around the airbags may be hot for several minutes. The airbag itself may also be hot.
- The windshield may crack.
- The hybrid system will be stopped and fuel supply to the engine will be stopped.
- All of the doors will be unlocked.
- The brakes and stop lights will be controlled automatically.
- The interior lights will turn on automatically.
- The emergency flashers will turn on automatically.
- For Safety Connect subscribers, if any of the following situations occur, the system is designed to send an emergency call to the response center, notifying them of the vehicle's location (without needing to push the [SOS] button) and an agent will attempt to speak with the occupants to ascertain the level of emergency and assistance required. If the occupants are unable to communicate, the agent automatically treats the call as an emergency and helps to dispatch the necessary emergency services.
 - When an SRS airbag has been deployed
 - When a seat belt pretensioner has operated
 - When the vehicle has been involved in a severe rear-end collision

■ The SRS airbags deploy in a frontal impact when

- The following SRS airbags will deploy in the event of an impact that exceeds a threshold level (level of force corresponding to an approximately 12 - 18 mph [20 - 30 km/h] frontal collision with a fixed wall that does not move or deform):
 - SRS front airbags
 - SRS seat cushion airbags
 - SRS knee airbags
- The threshold level at which the SRS airbags will deploy will be higher than normal in the in the following situations:

- When the vehicle collides with an object, such as a parked vehicle or sign pole, which moves or deforms on impact

If the vehicle is involved in an underride collision, such as a collision in which the front of the vehicle “underrides”, or goes under, the bed of a truck

- Depending on the type of collision, only the following may deploy:
 - Seat belt pretensioners
- The SRS airbags for the front passenger’s seat will not deploy if there is no passenger in the front passenger seat. However, the SRS airbags for the front passenger’s seat may deploy, even if the seat is unoccupied, if luggage is put on the seat.
- The SRS seat cushion airbag for the front passenger’s seat will not deploy if the seat belt of the front passenger’s seat is unfastened.
- In the event of an especially severe frontal collision, the left and right SRS curtain shield airbags may also deploy.

■ The SRS airbags deploy in a side impact when

- The following SRS airbags will deploy in the event of an impact that exceeds the set threshold level (level of force corresponding to the impact force produced by an approximately 3300 lb. [1500 kg] vehicle colliding with the passenger compartment at a perpendicular angle at an approximate speed of 12 - 18 mph [20 - 30 km/h]):
 - SRS side airbags
 - SRS curtain shield airbags
- In the event of a side collision, regardless of the impacted side, both the left and right SRS curtain shield airbags will deploy.
- If the vehicle is involved in a rollover, the following SRS airbags will deploy:
 - Both left and right SRS curtain shield airbags

■ The SRS airbags deploy in an underside impact when

- The following airbags may deploy if the underside of the vehicle collides with a hard object:

- SRS front airbags
- SRS knee airbags
- SRS seat cushion airbags
- SRS side airbags
- SRS curtain shield airbags

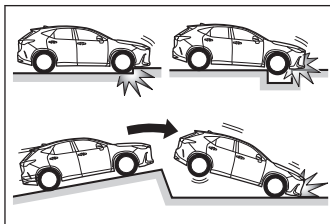

6-3. Reducing impact to the occupants in a collision

- The following airbags may deploy if the vehicle becomes significantly tilted or is strongly impacted by skidding into a curb, etc.:

- SRS curtain shield airbags

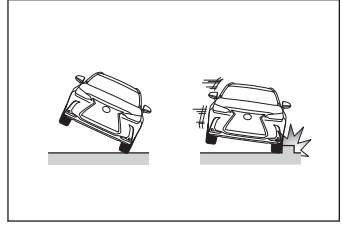

■ The SRS side airbags will not deploy when

- The following SRS airbags will not normally deploy in side or rear collisions, vehicle rollovers, or low speed frontal collisions. However, if such a collision causes sufficient sudden deceleration, the SRS airbags may deploy.

- SRS front airbags
- SRS knee airbags
- SRS seat cushion airbags

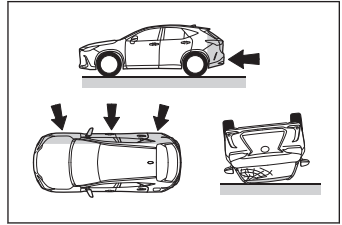

- The following SRS airbags may not deploy if the vehicle is collided with at a certain angle or in a side collision where an area of the vehicle other than the passenger compartment is collided with:

- SRS side airbags
- SRS curtain shield airbags

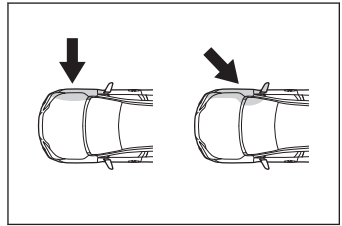

- The following SRS airbags will not normally deploy in front or rear collisions, vehicle rollovers, or low speed side collisions:

- SRS side airbags

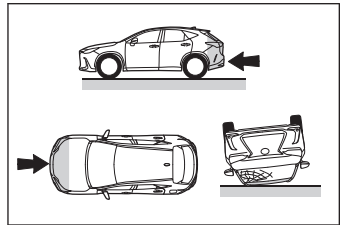

- The following SRS airbags will not normally deploy in rear collisions, end over end vehicle rollovers, or low speed front or side collisions

- SRS curtain shield airbags

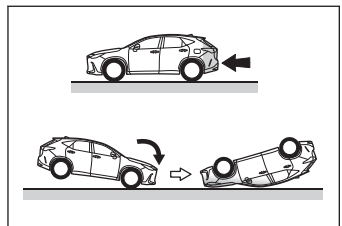

■ When to contact your Lexus dealer

In the following situations, the vehicle will require inspection and/or repair. Contact your Lexus dealer as soon as possible.

- When any of the SRS airbags have been deployed

- When the front of the vehicle is damaged or deformed, or was involved in a collision that was not severe enough to cause any of the following SRS airbags to deploy:

- SRS front airbags
- SRS knee airbags
- SRS seat cushion airbags

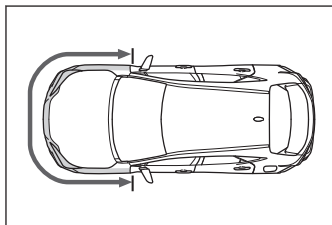

- When a door or its surrounding area is damaged, deformed or has had a hole made in it, or was involved in a collision that was not severe enough to cause any of the following SRS airbags to deploy:

- SRS side airbags
- SRS curtain shield airbags

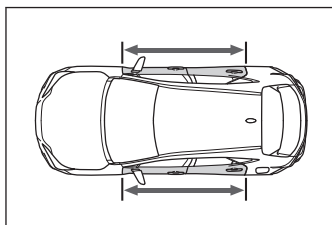

- When the pad section of the steering wheel, the dashboard near the front passenger SRS airbag or the lower side of the instrument panel is scratched, cracked, or otherwise damaged.

- When the seat cushion surface is scratched, cracked, or otherwise damaged.

- When the surface of a seat with an SRS side airbag is scratched, cracked, or otherwise damaged.

- When the part of a front pillar, rear pillar or roof side rail garnish (padding) which covers a SRS curtain shield airbag is scratched, cracked, or otherwise damaged.

▲ WARNING

■ SRS airbag precautions

Observe the following precautions. Failure to do so may result in death or serious injury.

- The driver and all passengers must wear their seat belts correctly.

The SRS airbags are supplemental devices to be used with the seat belts.

- The SRS driver airbag deploys with considerable force, and can cause death or serious injury, especially if the driver is very close to the airbag. The National Highway Traffic Safety Administration (NHTSA) advises:

Since the risk zone for the driver's airbag is the first 2 - 3 in. (50 - 75 mm) of inflation, placing yourself 10 in. (250 mm) from your driver airbag provides you with a clear

6-3. Reducing impact to the occupants in a collision

⚠ WARNING

margin of safety. This distance is measured from the center of the steering wheel to your breastbone. If your current driving position places you less than 10 in. (250 mm) away from the driver airbag, you can change your driving position in several ways:

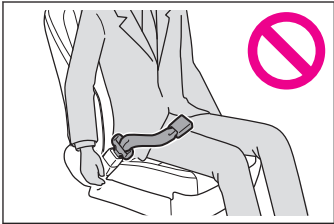
- Move your seat to the rear as far as possible while still being able to reach the pedals comfortably.
 - Slightly recline the seatback. Although vehicle designs vary, many drivers can achieve the 10 in. (251 mm) distance, even with the driver seat all the way forward, simply by reclining the seatback somewhat. If reclining the seatback makes it hard to see the road, raise yourself by using a firm, non-slippery cushion, or raise the seat if your vehicle has that feature.
 - If your steering wheel is adjustable, tilt it downward. This points the airbag toward your chest instead of your head and neck. The seat should be adjusted as recommended by the NHTSA, while still being able to control the vehicle with the pedals and steering wheel, and maintaining your view of the instrument panel controls.
- If a seat belt extender has been connected to a front seat belt buckle but the latch plate of the seat belt has not been fastened to the seat belt extender, the SRS airbag system will judge that the occupant is wearing the seat belt even though the seat belt has not been fastened. In this case, the SRS front airbags may not deploy correctly in a collision, resulting in death or serious injury. Be sure to wear the seat belt correctly when using a seat belt extender.
- 
- The SRS front passenger airbag deploys with considerable force, and can cause death or serious injury, especially if the front passenger is very close to the airbag. The front passenger seat should be positioned as far possible from the airbag with the seatback adjusted so that the passenger is sat upright.
 - Improperly seated and/or restrained infants and children can be killed or seriously injured by a deploying airbag. An infant or child who is too small to use a seat belt should be properly secured using a child restraint system. Lexus strongly recommends that all infants and children be placed in the rear seats of the vehicle and properly restrained. The rear seats are safer for infants and children than the front passenger seat.

⚠ WARNING

- Do not sit on the edge of the seat or lean against the dashboard.
- Do not allow a child to stand in front of the SRS front passenger airbag or sit on the lap of a front passenger.
- Front seat occupants should never hold items on their lap.
- Do not lean against the door, roof side rail, or front, side, or rear pillar.
- Do not allow anyone to kneel on a seat toward the door or put their head or hands outside the vehicle.
- Do not attach anything to or lean anything against areas such as the dashboard, steering wheel pad and lower portion of the instrument panel.

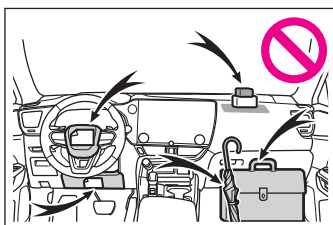
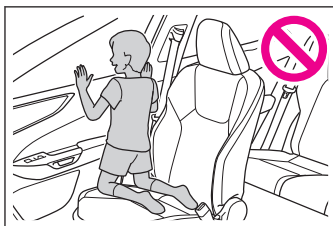
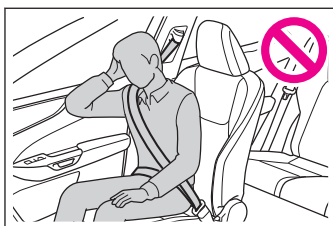
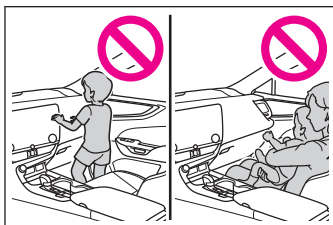
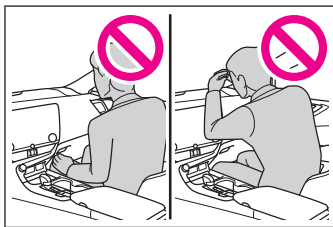

⚠ WARNING

- Do not attach anything to areas such as the doors, windshield, side windows, front or rear pillars, roof side rails and assist grips.

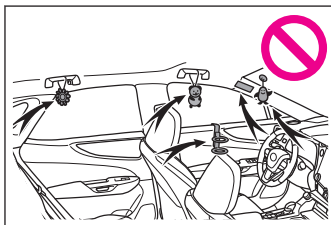

- Do not hang coat hangers or other hard objects on the coat hooks. These items could become projectiles if the SRS curtain shield airbags deploy, possibly leading to death or serious injury.
- If a vinyl cover is attached to the area where the SRS knee airbag deploys, be sure to remove it.
- Do not use seat accessories which cover the parts from which the SRS airbags deploy, as they may interfere with inflation of the SRS airbags. Such accessories may prevent the SRS airbags from deploying correctly, may disable the system or cause the SRS airbags to inflate unintentionally, possibly resulting in death or serious injury.
- Do not strike or apply significant force to the SRS airbag system components, front doors or their surrounding area. Doing so may cause the SRS airbags to malfunction.
- Do not touch any components of the SRS airbags immediately after the SRS airbags have deployed (inflated) as they may be hot.
- If breathing becomes difficult after the SRS airbags have deployed, open a door or window to allow fresh air in, or leave the vehicle if it is safe to do so. Wash off any residue as soon as possible to prevent skin irritation.
- If a part where an SRS airbag is stored is damaged or cracked, have it replaced by your Lexus dealer.
- Do not place anything, such as a cushion, on the front passenger's seat. Doing so will disperse the passenger's weight, which prevents the sensor from detecting the passenger's weight properly. As a result, the SRS front airbags for the front passenger's seat may not deploy in the event of a collision.

■ Modification and disposal of SRS airbag system components

Do not dispose of your vehicle or perform any of the following modifications without consulting your Lexus dealer.

The SRS airbags may malfunction or deploy unintentionally, possibly leading to death or serious injury.

- Removal, installation, disassembly or repair of the SRS airbags
- Repair, removal or modification of the following parts or their surrounding
 - Steering wheel

⚠ WARNING

- Instrument panel
- Dashboard
- Seats
- Seat upholstery
- Front pillars
- Side pillars
- Rear pillars
- Roof side rails
- Front door panels
- Front door trim
- Front door speakers
- Modifications to the front door panels (such as making holes in them)
- Repair or modification of the following parts or their surrounding
 - Front fender
 - Front bumper
 - Sides of the vehicle interior
- Installation of the following parts or accessories
 - Bull bars or kangaroo bars
 - Snow plows
 - Winches
- Modifications to the vehicle's suspension
- Installation of electronic devices such as mobile two-way radios (RF-transmitter) and CD players
- Modifications to your vehicle for a persons with a physical disability

Related Links

[Operation of emergency shut off system\(P. 637\)](#)

[Locking/unlocking the doors using smart access system with push-button start\(P. 119\)](#)

[Driving assist systems\(P. 381\)](#)

[Location of the interior lights\(P. 296\)](#)

[Using the emergency flashers to warn other drivers\(P. 635\)](#)

[Safety Connect\(P. 552\)](#)

Riding with children(P. 90)

Front passenger occupant classification system

Your vehicle is equipped with a front passenger occupant classification system. This system detects the conditions of the front passenger seat and activates or deactivates the following airbags.

- SRS front passenger airbag
- SRS front passenger knee airbag
- Front passenger's seat SRS seat cushion airbag

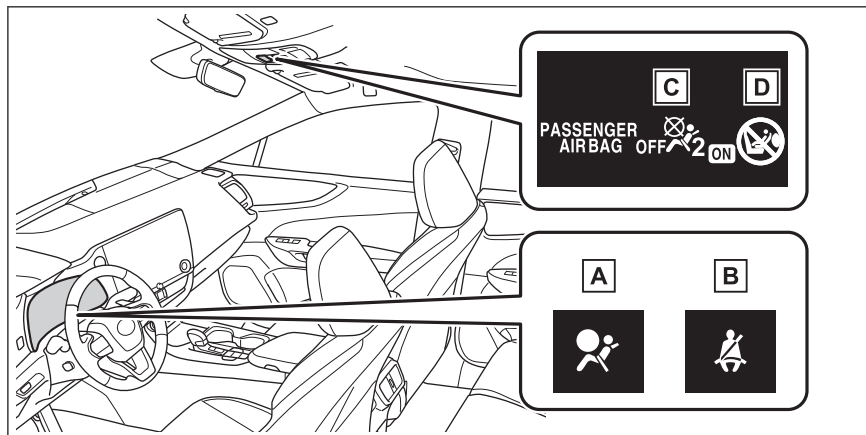

- A SRS warning light
- B Front passenger's seat belt reminder light
- C "AIR BAG OFF" indicator light
- D "AIR BAG ON" indicator light

⚠ WARNING

■ Front passenger occupant classification system precautions

Observe the following precautions regarding the front passenger occupant classification system. Failure to do so may cause death or serious injury.

- Wear the seat belt properly.
- Make sure the front passenger's seat belt plate has not been left inserted into the buckle before someone sits in the front passenger seat.
- Make sure the "AIR BAG OFF" indicator light is not illuminated when using the seat belt extender for the front passenger seat. If the "AIR BAG OFF" indicator light is illuminated, disconnect the extender tongue from the seat belt buckle, and reconnect the seat belt. Reconnect the seat belt extender after making sure the "AIR BAG ON" indicator light is illuminated. If you use the seat belt extender while the "AIR BAG

▲ WARNING

OFF" indicator light is illuminated, the SRS airbags for the front passenger will not activate, which could cause death or serious injury in the event of a collision.

- Do not apply a heavy load to the front passenger seat or equipment (e.g. seatback pocket or armrest).
- Do not put weight on the front passenger seat by putting your hands or feet on the front passenger seat seatback from the rear passenger seat.
- Do not let a rear passenger lift the front passenger seat with their feet or press on the seatback with their legs.
- Do not put objects under the front passenger seat.
- Do not recline the front passenger seatback so far that it touches a rear seat. This may cause the "AIR BAG OFF" indicator light to be illuminated, which indicates that the SRS airbags for the front passenger will not activate in the event of a severe accident. If the seatback touches the rear seat, return the seatback to a position where it does not touch the rear seat. Keep the front passenger seatback as upright as possible when the vehicle is moving. Reclining the seatback excessively may lessen the effectiveness of the seat belt system.
- If an adult sits in the front passenger seat, the "AIR BAG ON" indicator light is illuminated. If the "AIR BAG OFF" indicator is illuminated, ask the passenger to sit up straight, well back in the seat, feet on the floor, and with the seat belt worn correctly. If the "AIR BAG OFF" indicator still remains illuminated, either ask the passenger to move to the rear seat, or if that is not possible, move the front passenger seat fully rearward.
- When it is unavoidable to install a forward-facing child restraint system on the front passenger seat, install the child restraint system on the front passenger seat in the proper order.
- Do not modify or remove the front seats.
- Do not kick the front passenger seat or subject it to severe impact. Otherwise, the SRS warning light may come on to indicate a malfunction of the front passenger occupant classification system.
In this case, contact your Lexus dealer immediately.
- Child restraint systems installed on the rear seat should not contact the front seatbacks.
- Do not use a seat accessory, such as a cushion and seat cover, that covers the seat cushion surface.
- Do not modify or replace the upholstery of the front seat.

Related Links

[Child restraint system\(P. 93\)](#)

[Child restraint system installation method\(P. 94\)](#)

Front passenger occupant classification system conditions and operation

▶ Adult⁽¹⁾

Indicators / warning lights	"AIR BAG ON" and "AIR BAG OFF" indicator lights	"AIR BAG ON"
	SRS warning light	Off
	Front passenger's seat belt reminder light	Off ⁽²⁾ or flashing ⁽³⁾
Devices	Front passenger airbag	Activated
	Seat cushion airbag in the front passenger side	Activated ⁽²⁾ or deactivated ⁽³⁾

(1) The system judges a person of adult size as an adult. When a smaller adult sits in the front passenger seat, the system may not recognize him/her as an adult depending on his/her physique and posture.

(2) In the event the front passenger is wearing a seat belt.

(3) In the event the front passenger does not wear a seat belt.

▶ Child⁽³⁾

Indicators / warning lights	"AIR BAG ON" and "AIR BAG OFF" indicator lights	"AIR BAG OFF" or "AIR BAG ON" ⁽³⁾
	SRS warning light	Off
	Front passenger's seat belt reminder light	Off ⁽¹⁾ or flashing ⁽²⁾
Devices	Front passenger airbag	Deactivated or activated ⁽³⁾
	Seat cushion airbag in the front passenger side	Deactivated or activated ⁽¹⁾⁽³⁾

(1) In the event the front passenger is wearing a seat belt.

(2) In the event the front passenger does not wear a seat belt.

(3) For some children, child in seat, child in booster seat or child in convertible seat, the system may not recognize him/her as a child. Factors which may affect this can be the physique or posture.

6-3. Reducing impact to the occupants in a collision

► Child restraint system with infant⁽³⁾

Indicators / warning lights	"AIR BAG ON" and "AIR BAG OFF" indicator lights	"AIR BAG OFF" ⁽⁴⁾
	SRS warning light	Off
	Front passenger's seat belt reminder light	Off ⁽¹⁾ or flashing ⁽²⁾
Devices	Front passenger airbag	Deactivated
	Seat cushion airbag in the front passenger side	

(1) In the event the front passenger is wearing a seat belt.

(2) In the event the front passenger does not wear a seat belt.

(3) Never install a rear-facing child restraint system on the front passenger seat. A forward-facing child restraint system should only be installed on the front passenger seat when it is unavoidable.

(4) In case the indicator light is not illuminated, consult this manual on how to install the child restraint system properly.

► Unoccupied

Indicators / warning lights	"AIR BAG ON" and "AIR BAG OFF" indicator lights	"AIR BAG OFF"
	SRS warning light	Off
	Front passenger's seat belt reminder light	
Devices	Front passenger airbag	Deactivated
	Seat cushion airbag in the front passenger side	

► System malfunction

Indicators / warning lights	"AIR BAG ON" and "AIR BAG OFF" indicator lights	"AIR BAG OFF"
	SRS warning light	On
	Front passenger's seat belt reminder light	
Devices	Front passenger airbag	Deactivated
	Seat cushion airbag in the front passenger side	

7.1. Connected Services

Safety Connect	552
Remote Connect.....	556
Service Connect.....	557

Safety Connect*

Safety Connect is a subscription-based telematics service that uses Global Positioning System (GPS) data and embedded cellular technology to provide safety and security features to subscribers. Safety Connect is supported by Lexus' designated response center, which operates 24 hours per day, 7 days per week. Safety Connect service is available by subscription on select, telematics hardware-equipped vehicles. By using the Safety Connect service, you are agreeing to be bound by the Telematics Subscription Service Agreement and its Terms and Conditions, as in effect and amended from time to time, a current copy of which is available at Lexus.com. All use of the Safety Connect service is subject to such then-applicable Terms and Conditions.

System components

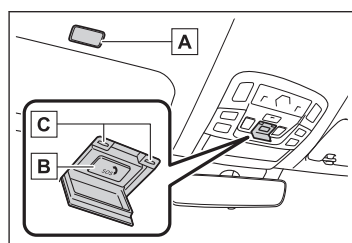

- A Microphone
- B [SOS] button
- C LED light indicators

Services

Subscribers have the following Safety Connect services available:

- Automatic Collision Notification*¹

Helps drivers receive necessary response from emergency service providers. → P.554

- Stolen Vehicle Location

Helps drivers in the event of vehicle theft. → P.554

- Emergency Assistance Button ([SOS])

Connects drivers to response-center support. → P.554

- Enhanced Roadside Assistance

Provides drivers various on-road assistance. → P.554

*: If equipped

*1: U.S. Patent No. 7,508,298 B2

Subscription

After you have signed the Telematics Subscription Service Agreement and are enrolled, you can begin receiving services.

A variety of subscription terms is available for purchase. Contact your Lexus dealer, call the following or push the [SOS] button in your vehicle for further subscription details.

- The United States
1-800-25-LEXUS (1-800-255-3987)
- Canada
1-800-26-LEXUS (1-800-265-3987)
- Puerto Rico
1-877-539-8777

INFORMATION

Safety Connect Services Information

- Phone calls using the vehicles Bluetooth® technology will not be possible during Safety Connect.
- Safety Connect is available beginning Fall 2009 on select Lexus models (in the contiguous United States only). Contact with the Safety Connect response center is dependent upon the telematics device being in operative condition, cellular connection availability, and GPS satellite signal reception, which can limit the ability to reach the response center or receive emergency service support. Enrollment and Telematics Subscription Service Agreement required. A variety of subscription terms is available; charges vary by subscription term selected and location.
- Automatic Collision Notification, Emergency Assistance and Stolen Vehicle Location will function in the United States, including Hawaii and Alaska, Puerto Rico and in Canada, and Enhanced Roadside Assistance will function in the United States, Puerto Rico and in Canada.
- Automatic Collision Notification, Emergency Assistance, Stolen Vehicle and Enhanced Road Assistance will not function in the United States Virgin Islands. For vehicles first sold in the USVI, no Safety Connect services will function in and outside the United States Virgin Islands.
- Safety Connect services are not subject to section 255 of the Telecommunications Act and the device is not TTY compatible.

■ Languages

The Safety Connect response center will offer support in multiple languages. The Safety Connect system will offer voice prompts in English, Spanish, and French. Please indicate your language of choice when enrolling.

■ When contacting the response center

You may be unable to contact the response center if the network is busy.

Safety Connect LED light indicators

When the power switch is turned to ON, the red indicator light comes on for 2 seconds then turns off. Afterward, the green indicator light comes on, indicating that the service is active. The following indicator light patterns indicate specific system usage conditions:

- Green indicator light on = Active service
- Green indicator light flashing = Safety Connect call in process
- Red indicator light (except at vehicle start-up) = System malfunction (contact your Lexus dealer)
- No indicator light (off) = Safety Connect service not active

Safety Connect services

■ Automatic Collision Notification

In case of either airbag deployment or severe rear-end collision, the system is designed to automatically call the response center. The responding agent receives the vehicle's location and attempts to speak with the vehicle occupants to assess the level of emergency. If the occupants are unable to communicate, the agent automatically treats the call as an emergency, contacts the nearest emergency services provider to describe the situation, and requests that assistance be sent to the location.

■ Stolen Vehicle Location

If your vehicle is stolen, Safety Connect can work with local authorities to assist them in locating and recovering the vehicle. After filing a police report, call the Safety Connect response center at 1-800-25-LEXUS (1-800-255-3987) in the United States, 1-877-539-8777 in Puerto Rico or 1-800-265-3987 in Canada, and follow the prompts for Safety Connect to initiate this service.

In addition to assisting law enforcement with recovery of a stolen vehicle, Safety-Connect-equipped vehicle location data may, under certain circumstances, be shared with third parties to locate your vehicle. Further information is available at Lexus.com.

■ Emergency Assistance Button ([SOS])

In the event of an emergency on the road, push the [SOS] button to reach the Safety Connect response center. The answering agent will determine your vehicle's location, assess the emergency, and dispatch the necessary assistance required.

If you accidentally press the [SOS] button, tell the response-center agent that you are not experiencing an emergency.

■ Enhanced Roadside Assistance

Enhanced Roadside Assistance adds GPS data to the already included warranty-based Lexus roadside service.

Subscribers can press the [SOS] button to reach a Safety Connect response-center agent, who can help with a wide range of needs, such as: towing, flat tire, fuel delivery, etc. For a description of the Roadside Assistance services and their limitations, please see the Safety Connect Terms and Conditions, which are available at Lexus.com.

Safety information for Safety Connect

Important! Read this information about exposure to radio frequency signals before using Safety Connect; The Safety Connect system installed in your vehicle is a low-power radio transmitter and receiver. It receives and also sends out radio frequency (RF) signals. In August 1996, the Federal Communications Commission (FCC) adopted RF exposure guidelines with safety levels for mobile wireless phones. Those guidelines are consistent with the safety standards previously set by the following U.S. and international standards bodies.

- ANSI (American National Standards Institute) C95.1 [1992]
- NCRP (National Council on Radiation Protection and Measurement) Report 86 [1986]
- ICNIRP (International Commission on Non-Ionizing Radiation Protection) [1996]

Those standards were based on comprehensive and periodic evaluations of the relevant scientific literature. Over 120 scientists, engineers, and physicians from universities, and government health agencies and industries reviewed the available body of research to develop the ANSI Standard (C95.1).

The design of Safety Connect complies with the FCC guidelines in addition to those standards.

Remote Connect

Remote Connect is a smartphone application that lets you view and remotely control certain aspects of your vehicle. For details about the functions and services of this application, refer to <http://www.lexus.com/enform/>. Function of the Remote Connect is achieved by using an embedded cellular device in the vehicle (DCM: Data Communication Module).

Remote Connect subscription

After you sign the Telematics Subscription Service Agreement, download the Lexus App from your smartphone's app store, and register within the app (or enroll and complete registration at the dealer), you can begin using these services. A variety of subscription terms are available. Contact your Lexus dealer, or call 1-800-25-LEXUS (1-800-255-3987) for further subscription details.

INFORMATION

■ Availability of service

Remote Connect is not available in some countries or areas.

■ Remote Connect Information

- Remote Connect should only be used by authorized users.
- Laws in some communities may require that the vehicle be within view of the user when operating Remote Connect. In some states, use of Remote Connect may violate state or local laws. Before using Remote Connect, check your state and local laws.
- Any malfunction of the Lexus should be repaired by your Lexus dealer.
- Remote Connect is designed to work at temperatures above -22°F (-30°C). This specification is related to the Remote Connect operation, but is dependent on the vehicle's operating temperature range which may be different.
- Content is subject to change without notice.
- Some features of the Remote Connect may not be available on some models.
- Additional information can be found at <https://www.lexus.com/enform/>.
- Availability of functions of the Remote Connect service is dependent on network reception level.

■ Safety information for Remote Connect

Refer to the safety information for Safety Connect: → P.555

Service Connect

Service Connect uses embedded telematics hardware to collect and transmit vehicle data that allows Lexus to provide:

- Vehicle Health Report (VHR) (Safety Recalls, Service Campaigns, Current Vehicle Alerts, Required Maintenance, and Vehicle Condition Status)
- Maintenance Notifications
- Vehicle Alert Notifications

For details about this service and how to register, refer to <http://www.lexus.com/enform/>. The Service Connect is achieved by using a Data Communication Module (DCM) built in the vehicle.

INFORMATION

■ Availability of service

Service Connect is not available in some countries or areas.

■ Service Connect Information

Availability of functions of the Service Connect is dependent on network reception level.

■ Safety information for Service Connect

Refer to the safety information for Safety Connect: → P.555

8-1. Exterior maintenance and care

Washing the vehicle **560**

8-2. Cleaning and protecting the vehicle interior

Cleaning the vehicle interior **566**

Cleaning the areas with satin-finish metal accents **568**

Cleaning the leather areas.. **569**

Cleaning the synthetic leather areas..... **570**

Cleaning DC/DC converter air intake vent..... **571**

8-3. Maintenance

Maintenance requirements **575**

Scheduled maintenance outline..... **576**

Do-it-yourself maintenance **577**

General maintenance **578**

Engine compartment maintenance items list **579**

Luggage compartment maintenance item list **580**

Vehicle interior maintenance items list **581**

Vehicle exterior maintenance items list **582**

Emission inspection and maintenance (I/M) programs..... **583**

8-4. Inspection of consumables

Do-it-yourself service precautions **584**

Opening the hood **586**

Engine compartment..... **587**

Adding washer fluid **594**

12-volt battery **595**

Air conditioning filter maintenance **598**

8-5. Tire maintenance

Tire maintenance **600**

Tire inspection items **601**

Run-flat tire features **604**

Operation of the tire pressure warning system..... **605**

Checking tire inflation pressure..... **616**

Lifting the vehicle with a floor jack..... **618**

Rotating the tires..... **619**

Wheels..... **620**

Replacing the tire **622**

Headlight aim..... **631**

Washing the vehicle

WARNING

- When washing the vehicle, do not apply water to the inside of the engine compartment.
If water contacts electrical components, it may cause the vehicle to catch fire.
- Exhaust gasses cause the exhaust pipes to become quite hot.
When washing the vehicle, be careful not to touch the exhaust pipes until they have cooled sufficiently. Touching a hot exhaust pipe can cause burns.

NOTICE

To prevent paint deterioration and corrosion of the body and components (wheels, etc.)

- Wash the vehicle immediately in the following cases:
 - After driving near the sea coast
 - After driving on salted roads
 - If coal tar or tree sap is present on the paint surface
 - If dead insects, insect droppings or bird droppings are present on the paint surface
 - After driving in an area contaminated with soot, oily smoke, mine dust, iron powder or chemical substances
 - If the vehicle becomes heavily soiled with dust or mud
 - If liquids such as benzine or gasoline are spilled on the paint surface
- If the paint is chipped or scratched, have it repaired immediately.
- To prevent the wheels from corroding, remove any dirt and store in a place with low humidity when storing the wheels.

To prevent damage to the windshield wiper arms

When lifting the wiper arms away from the windshield, pull the driver side wiper arm upward first, and repeat for the passenger side. When returning the wipers to their original position, do so from the passenger side first.

Perform cleaning in a manner appropriate to each component and its material.

- Working from top to bottom, liberally apply water to the vehicle body, wheel wells and underside of the vehicle to remove any dirt and dust.
- Wash the vehicle body using a sponge or soft cloth, such as a chamois.
- For hard-to-remove marks, use car wash soap and rinse thoroughly with water.
- Wipe away any water.

 **INFORMATION****■ Self-restoring coat**

The vehicle body has a self-restoring coating that is resistant to small surface scratches caused by a car wash, etc.

- The coating lasts for 5 to 8 years from when the vehicle is delivered from the plant.
- The restoration time differs depending on the depth of the scratch and outside temperature.

The restoration time may become shorter when the coating is warmed by applying warm water.

- Deep scratches caused by keys, coins, etc., cannot be restored.
- Do not use waxes that contain abrasives.

■ When using a car wash

If the door handle becomes wet while the electronic key is within the effective range, the door may lock and unlock repeatedly. In that case, follow the following correction procedures to wash the vehicle:

- Place the key in a position 6 ft. (2 m) or more separate from the vehicle while the vehicle is being washed.

Take care to ensure that the key is not stolen.

- Set the electronic key to battery-saving mode to disable the smart access system with push-button start.

■ Brake pads and calipers

Rust may form if the vehicle is parked with wet brake pads or disc rotors, causing them to stick. Before parking the vehicle after it is washed, drive slowly and apply the brakes several times to dry the parts.

Using an automatic car wash **NOTICE**

When using an automatic car wash, move the wiper lever to the off position.

If the wiper lever is in the AUTO position, the wipers may operate unintentionally and the wiper blades may be damaged.

- Perform the following before washing your vehicle:

- Fold the mirrors.
- Vehicles with power back door:
 - Turn off the power back door.

Start washing from the front of the vehicle.

Extend the mirrors before driving.

- Brushes used in automatic car washes may scratch the vehicle surface, parts (wheel, etc.) and harm your vehicle's paint.
- Depending on the automatic car wash, the rear spoiler may become caught, preventing it from being washed or causing damage to it.
- When it is necessary to set the power switch to ACC with the shift position held in N, refer to [P.198](#).

Using a high pressure washer to wash the vehicle

NOTICE

- When washing the vehicle, do not spray any of the cameras or their surrounding area directly. The shock from high pressure water may cause a camera to malfunction.
- Do not bring the tip of the nozzle close to connectors or the boots (rubber or resin cover) of the following parts.
The parts may be damaged if sprayed by high-pressure water.
 - Drivetrain related parts
 - Steering parts
 - Suspension parts
 - Brake parts
- Keep the tip of the nozzle at least 11.9 in. (30 cm) away from the vehicle body. Otherwise resin parts, such as the moldings, bumpers, etc., may be deformed and damaged. Also, do not continuously spray water on the same place.
- Do not spray the lower part of the windshield continuously. If water enters the air conditioning system intake located near the lower part of the windshield, the air conditioning system may not operate correctly.
- Do not wash the underside of the vehicle using a high pressure washer.
- Do not use the washer on the area around the charging port lid. Water could get into the AC charging inlet and could damage the vehicle.

When using a high pressure washer, as water may enter the cabin, do not bring the tip of the nozzle near the gaps around the doors or perimeter of the windows, or spray these areas continuously.

Cleaning the wheels and wheel ornaments

Perform the following:

- Remove any dirt immediately using a neutral cleaning agent.

- Wash detergent off with water immediately after use.
- To protect the finish from damage, make sure to observe the following precautions.
 - Do not use acidic, alkaline or abrasive cleaners
 - Do not use hard brushes
 - Do not use detergent on the wheels when they are hot, such as after driving or parking in hot weather

Cleaning the bumpers

⚠ WARNING

If the paint of the rear bumper is chipped or scratched, the following systems may not function correctly. If this occurs, consult your Lexus dealer.

- Lexus Safety System + 3
- BSM
- Safe Exit Assist (with door opening control)
- RCTA
- PKSB*

Do not scrub with abrasive cleaners.

Cleaning and protecting the plated portions

If dirt cannot be removed, clean the parts as follows:

- Use a soft cloth dampened with an approximately 5 % solution of neutral detergent and water to clean the dirt off.
- Wipe the surface with a dry, soft cloth to remove any remaining moisture.
- To remove oily deposits, use alcohol wet wipes or a similar product.

📖 INFORMATION

■ Black stainless steel window moldings*

The stainless steel window moldings are made of black oxide coated stainless steel.

When cleaning the vehicle, do not scrub the moldings with an abrasive cleaner as their finish may be damaged or the color may change.

*: If equipped

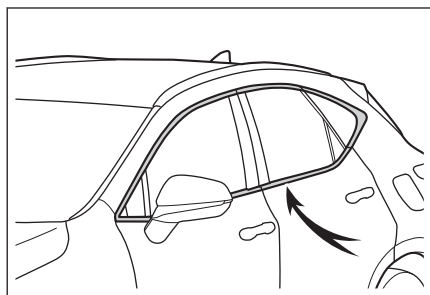

Cleaning the exterior lights

⚠ NOTICE

- Wash carefully. Do not use organic substances or scrub with a hard brush.
Doing so may damage the surface of the lights.
- Do not apply wax to the lights.
Wax may damage the lenses.

Cleaning the windshield

⚠ WARNING

Move the wiper lever to the off position.

If the wiper lever is in the AUTO position, the wipers may operate unexpectedly in the following situations, possibly leading serious injury from a hand being caught, or damage to the wiper blades.

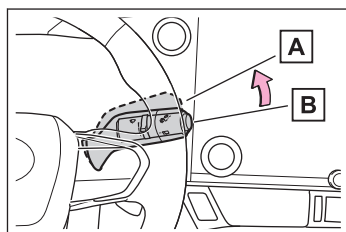

- A Off
- B AUTO

- When the upper part of the windshield where the raindrop sensor is located is touched by hand
- When a wet rag or similar is held close to the raindrop sensor
- If something bumps against the windshield
- If you directly touch the raindrop sensor body or if something bumps into the raindrop sensor

Waxing the vehicle

Wax the vehicle when the waterproof coating has deteriorated.

If water does not bead on a clean surface, apply wax when the vehicle body is cool.

Cleaning the vehicle interior

WARNING

Water in the vehicle

- Do not splash or spill liquid in the vehicle, such as on the floor, in DC/DC converter air intake vent, junction box and in the luggage compartment. Doing so may cause DC/DC converter, electrical components, etc., to malfunction or catch fire.
- Do not get any of the SRS components or wiring in the vehicle interior wet.
An electrical malfunction may cause the airbags to deploy or not function properly, resulting in death or serious injury.

Cleaning the interior (especially instrument panel)

Do not use wax polish or a polishing cleaner on the instrument panel. The instrument panel may reflect off the windshield, obstructing the driver's view and leading to an accident, resulting in death or serious injury.

NOTICE

Cleaning solvents

- Do not use the following cleaning solvents, as they may discolor the vehicle interior or cause streaks or damage to painted surfaces:
 - Areas other than the seats: Organic substances such as benzine or gasoline, alkaline or acidic solutions, dye, and bleach
 - Seats: thinner, benzine, alcohol, or alkaline or acidic solutions
- Do not use wax polish or a polishing cleaner. The painted surfaces of the instrument panel or other interior parts may be damaged.

Water on the floor

Do not wash the vehicle floor with water.

If water contacts audio system or other electrical components under the floor carpet, it may cause the vehicle to malfunction. Water may also cause the body to rust.

When cleaning the inside of the windshield

Do not allow glass cleaner to contact the lens of the front camera. Also, do not touch the lens.

Cleaning the inside of the windshield and rear window

- Do not use glass cleaners to clean the rear window, as this may cause damage to the rear window defogger heater wires or antenna. Use a cloth dampened with lukewarm water to gently wipe the window clean. Wipe the window in strokes running parallel to the heater wires or antenna.
- Be careful not to scratch or damage the heater wires or antenna.

Perform cleaning in a manner appropriate to each component and its material.

- **Remove dirt and dust using a vacuum cleaner. Wipe dirty surfaces with a cloth dampened with lukewarm water.**
- **If dirt cannot be removed, wipe it off with a soft cloth dampened with neutral detergent diluted to approximately 1%.**

Wring out any excess water from the cloth and thoroughly wipe off remaining traces of detergent and water.

INFORMATION

■ Shampooing the carpets

Excellent results can be obtained by keeping the carpet as dry as possible. When cleaning, use a commercially available foaming-type cleaner.

Use a sponge or brush to apply the foam and rub it in overlapping circles. Do not use water. Wipe the surface to remove the cleaner and dirt and let it dry.

■ Handling the seat belts

Clean with mild soap and lukewarm water using a cloth or sponge. Also check the belts periodically for excessive wear, fraying or cuts.

Cleaning the areas with satin-finish metal accents

- Remove dirt using a water-dampened soft cloth or synthetic chamois.
- Wipe the surface with a dry, soft cloth to remove any remaining moisture.

INFORMATION

■ **Cleaning the areas with satin-finish metal accents**

The metal areas use a layer of real metal for the surface. It is necessary to clean them regularly. If dirty areas are left uncleaned for long periods of time, they may be difficult to clean.

Cleaning the leather areas

NOTICE

Observe the following precautions to avoid damage to and deterioration of leather surfaces:

- Remove any dust or dirt from leather surfaces immediately.
- Do not expose the vehicle to direct sunlight for extended periods of time.
Park the vehicle in the shade, especially during summer.
- Do not place items made of vinyl, plastic, or containing wax on the upholstery, as they may stick to the leather surface if the vehicle interior heats up significantly.

- **Remove dirt and dust using a vacuum cleaner.**
- **Wipe off any excess dirt and dust with a soft cloth dampened with diluted detergent.**
Use a diluted water solution of approximately 5% neutral wool detergent.
- **Wring out any excess water from the cloth and thoroughly wipe off all remaining traces of detergent.**
- **Wipe the surface with a dry, soft cloth to remove any remaining moisture. Allow the leather to dry in a shaded and ventilated area.**

INFORMATION

Caring for leather areas

Lexus recommends cleaning the interior of the vehicle at least twice a year to maintain the quality of the vehicle's interior.

Cleaning the synthetic leather areas

- Remove dirt and dust using a vacuum cleaner.
- Wipe it off with a soft cloth dampened with neutral detergent diluted to approximately 1%.
- Wring out any excess water from the cloth and thoroughly wipe off remaining traces of detergent and water.

Cleaning DC/DC converter air intake vent

INFORMATION

■ Scheduled maintenance of the air intake vent is necessary when

In some situations such as when the vehicle is used frequently or in heavy traffic or dusty areas, the air intake vent may need to be cleaned more regularly. For details, refer to the "Warranty and Service Guide", "Owner's Manual Supplement" or "Scheduled Maintenance".

■ Cleaning the DC/DC converter air intake vent

Check the following regarding cleaning of the air intake vent.

- Dust in the air intake vent may interfere with the cooling of the DC/DC converter. If the cooling performance/capacity of the DC/DC converter becomes limited, the 12-volt battery may discharge. Inspect and clean the air intake vent periodically.
- Improper handling of the air intake vent cover and filter may result in damage to them. If you have any concerns about cleaning the filter, contact your Lexus dealer.

Cleaning the DC/DC converter air intake vent and filter

WARNING

When cleaning the air intake vent, observe the following:

- Do not use water or other liquids to clean the air intake vent. If water is applied to the DC/DC converter or other components, a malfunction or fire may occur.
- Before cleaning the air intake vent, make sure to turn the power switch off to stop the hybrid system.

NOTICE

To prevent malfunction of the DC/DC converter or vehicle, make sure to observe the following precautions.

- When cleaning the air intake vent, make sure to only use a vacuum to suck out dust and clogs.

If a compressed air blow gun, etc. is used to blow out dust and clogs, the dust or clogs may be pushed into the air intake vent, which may affect the performance of the DC/DC converter and cause a malfunction.

NOTICE

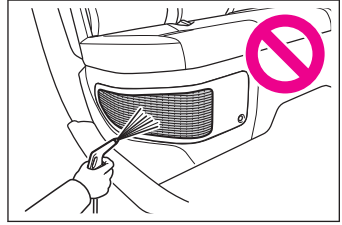

- Do not allow liquid or foreign matter to enter the air intake vent when the cover is removed.
- Carefully handle the removed filter so that it will not be damaged.
If the filter is damaged, have it replaced with a new filter by your Lexus dealer.
- Make sure to reinstall the filter and cover to their original positions after cleaning.
- Do not install anything to the air intake vent other than the exclusive filter for this vehicle or use the vehicle without the filter installed.

1 Remove the dust from the vent and filter with a vacuum cleaner.

Make sure to only use a vacuum to suck out dust and clogs. Attempting to blow out dust and clogs using an airgun, etc. may push it into the air intake vent.

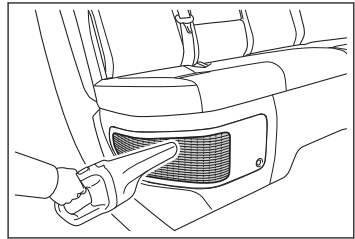

If dust and clogs cannot be completely removed with the air intake vent cover installed, remove the cover and clean the filter.

- 2 Turn the power switch off.
- 3 Using a phillips-head screwdriver, remove the clip.

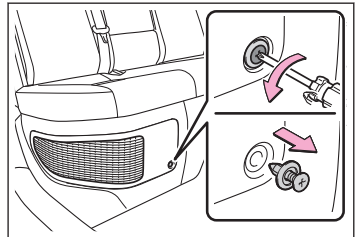

- 4 Pull the cover as shown in the illustration to disengage the 8 claws, starting from the claw in the upper right corner and pull the cover toward the front of the vehicle to remove it.

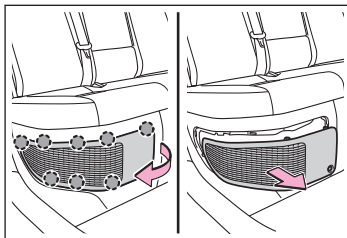

- 5 Disengage the 4 center claws from the filter.

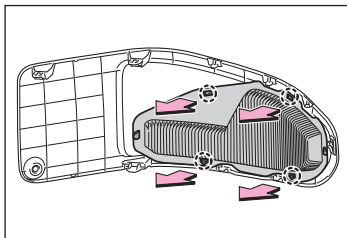

- 6 Disengage the claws in the order of **A** and **B** to remove the filter from the cover.

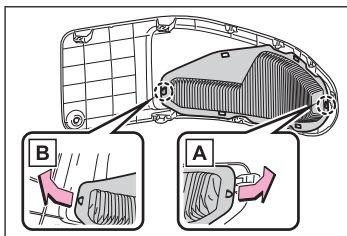

- 7 Remove the dust and clogs from the filter using a vacuum cleaner, etc.

Make sure to also remove the dust and clogs from the inner side of the air intake vent cover.

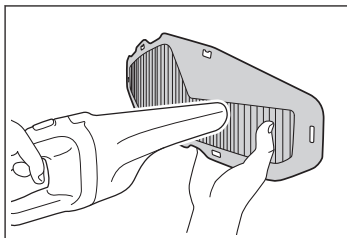

- 8 Engage the claws in the order of **B** and **A**.

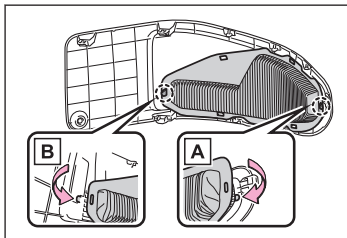

8-2. Cleaning and protecting the vehicle interior

- 9 Engage the 4 claws of the air intake vent cover to install the filter.

Make sure that the filter is not crooked or deformed when installing it.

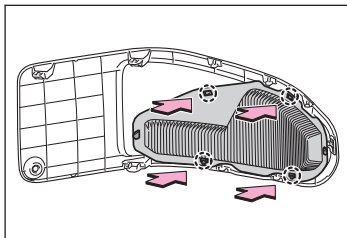

- 10 Insert the tab of the cover as shown in the illustration and push the cover to engage the 8 claws.

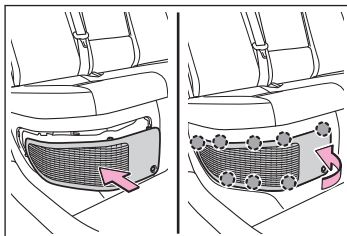

- 11 Using a phillips-head screwdriver, install the clip.

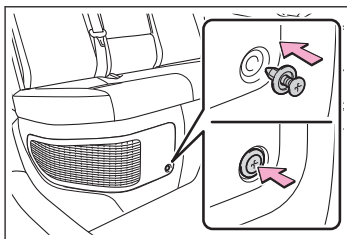

INFORMATION

After cleaning the air intake vent, start the hybrid system and check that the warning message is no longer shown. It may take approximately 20 minutes after the hybrid system is started until the warning message disappears. If the warning message does not disappear, have the vehicle inspected by your Lexus dealer.

Maintenance requirements



To ensure safe and economical driving, day-to-day care and regular maintenance are essential. It is the owner's responsibility to perform regular checks. Lexus recommends the following maintenance:

WARNING

If your vehicle is not properly maintained

Improper maintenance could result in serious damage to the vehicle and possible death or serious injury.

Handling of the 12-volt battery



-  Engine exhaust, some of its constituents, and a wide variety of automobile components contain or emit chemicals known to the State of California to cause cancer and birth defects and other reproductive harm. Work in a well ventilated area.
-  Oils, fuels and fluids contained in vehicles as well as waste produced by component wear contain or emit chemicals known to the State of California to cause cancer and birth defects or other reproductive harm. Avoid exposure and wash any affected area immediately.
-  12-volt battery posts, terminals and related accessories contain lead and lead compounds which are known to cause brain damage. Wash your hands after handling.

INFORMATION

Repair and replacement

It is recommended that genuine Lexus parts be used for repairs to ensure performance of each system. If non-Lexus parts are used in replacement or if a repair shop other than a Lexus dealer performs repairs, confirm the warranty coverage.

Allow inspection and repairs to be performed by a Lexus dealer

-  Lexus technicians are well-trained specialists and are kept up to date with the latest service information. They are well informed about the operation of all systems on your vehicle.
-  Keep a copy of the repair order. It proves that the maintenance that has been performed is under warranty coverage. If any problem should arise while your vehicle is under warranty, your Lexus dealer will promptly take care of it.

Scheduled maintenance outline

Scheduled maintenance should be performed at specified intervals according to the maintenance schedule.

For details about maintenance items and schedules, refer to the "Warranty and Service Guide", "Owner's Manual Supplement" or "Scheduled Maintenance".

Resetting the message indicating maintenance is required

After the required maintenance is performed according to the maintenance schedule, the message must be reset. To reset the message, perform the following procedure:

- 1 Select the  on the center display.
- 2 Select [Vehicle customize].
- 3 Select [Utility].
- 4 Select [Scheduled maintenance].
- 5 Select [Reset].

"The data has been reset" will be displayed on the center display when the reset procedure has been completed.

Resetting the engine oil change message

After the engine oil has been replaced, the engine oil maintenance data should be reset. Perform the following procedure:

- 1 Select the  on the center display.
- 2 Select [Vehicle customize].
- 3 Select [Utility].
- 4 Select [Oil maintenance].
- 5 Select [Reset].

"The data has been reset." will be displayed on the center display when the reset procedure has been completed.

Do-it-yourself maintenance

You can perform some maintenance procedures by yourself. Please be aware that do-it-yourself maintenance may affect warranty coverage.

The use of Lexus repair manuals is recommended. For details about warranty coverage, refer to the separate "Owner's Guide", "Warranty and Service Guide", "Owner's Manual Supplement" or "Warranty Booklet".

General maintenance

General maintenance items should be performed at the intervals specified in the "Warranty and Service Guide" or "Owner's Manual Supplement". This can be done by yourself or by a Lexus dealer. It is recommended that any problem you notice should be brought to the attention of your Lexus dealer or qualified service shop for advice.

WARNING

If the hybrid system is on, turn the power switch off and ensure that there is adequate ventilation before performing maintenance checks.

Engine compartment maintenance items list

Items	Check points
Brake fluid	Is the brake fluid at the correct level? → P.592
Engine/power control unit coolant	Is the engine/power control unit coolant at the correct level? → P.590
Engine oil	Is the engine oil at the correct level? → P.588
Exhaust system	There should not be any fumes or strange sounds.
Radiator/condenser	The radiator and condenser should be free from foreign objects. → P.591
Washer fluid	Is there sufficient washer fluid? → P.594

Luggage compartment maintenance item list

Items	Check points
12-volt battery	Check the connections. → P.596

Vehicle interior maintenance items list

Items	Check points
Accelerator pedal	The accelerator pedal should move smoothly. There should be no uneven pedal effort or catching.
Hybrid transmission "Park" mechanism	When parked on a slope and the shift position is in P, is the vehicle securely stopped?
Brake pedal	<ul style="list-style-type: none"> ● Does the brake pedal move smoothly? ● Does the brake pedal have appropriate clearance from the floor? ● Does the brake pedal have the correct amount of free play?
Brakes	<ul style="list-style-type: none"> ● The vehicle should not pull to one side when the brakes are applied. ● The brakes should work effectively. ● The brake pedal should not feel spongy. ● The brake pedal should not get too close to the floor when the brakes are applied.
Head restraints	Do the head restraints move smoothly and lock securely?
Indicators/buzzers	Do the indicators and buzzers function properly?
Lights	<ul style="list-style-type: none"> ● Do all the lights come on? ● Are the headlights aimed correctly?
Parking brake	<ul style="list-style-type: none"> ● Does the parking brake switch operate normally? ● When parked on a slope and the parking brake is on, is the vehicle securely stopped?
Seat belts	<ul style="list-style-type: none"> ● Do the seat belts operate smoothly? ● The seat belts should not be damaged.
Seats	Do the seat controls operate properly?
Steering wheel	<ul style="list-style-type: none"> ● Does the steering wheel rotate smoothly? ● Does the steering wheel have the correct amount of free play? ● There should not be any strange sounds coming from the steering wheel.

Vehicle exterior maintenance items list

Items	Check points
Doors	Do the doors operate smoothly?
Engine hood	Does the engine hood lock system work properly?
Fluid leaks	There should not be any signs of fluid leakage after the vehicle has been parked.
Tires	<ul style="list-style-type: none"> ● Is the tire inflation pressure correct? ● The tires should not be damaged or excessively worn. ● Have the tires been rotated according to the maintenance schedule? ● The wheel nuts should not be loose.
Windshield wipers/rear window wiper	<ul style="list-style-type: none"> ● The wiper blades should not show any signs of cracking, splitting, wear, contamination or deformation. ● The wiper blades should clear the windshield/rear window without streaking or skipping.

Emission inspection and maintenance (I/M) programs

Some states have vehicle emission inspection programs which include OBD (On Board Diagnostics) checks. The OBD system monitors the operation of the emission control system.

When the malfunction indicator lamp comes on

The OBD system determines that a problem exists somewhere in the emission control system.

Your vehicle may not pass the I/M test and may need to be repaired. Contact your Lexus dealer to service the vehicle.

Situations your vehicle may not pass the I/M test

Your vehicle may not pass the I/M test in the following situations:

- When the 12-volt battery is disconnected or discharged
Readiness codes that are set during ordinary driving are erased. Also, depending on your driving habits, the readiness codes may not be completely set.
- When the fuel tank cap is loose
The malfunction indicator lamp comes on indicating a temporary malfunction and your vehicle may not pass the I/M test.

When the malfunction indicator lamp still remains on after several driving trips

The error code in the OBD system will not be cleared unless the vehicle is driven 40 or more times.

When your vehicle does not pass the I/M test

Contact your Lexus dealer to prepare the vehicle for re-testing.

Do-it-yourself service precautions

If you perform maintenance by yourself, be sure to follow the correct procedure as given in the section for each part.

WARNING

The engine compartment contains many mechanisms and fluids that may move suddenly, become hot, or become electrically charged. Observe the following precautions.

When working on the engine compartment

- Make sure that the "IGNITION ON" on the multi-information display and the "READY" indicator are both off.
- Keep hands, clothing and tools away from the moving fan and engine drive belt.
- Be careful not to touch the engine, power control unit, radiator, exhaust manifold, etc., right after driving as they may be hot. Oil and other fluids may also be hot.
- Do not leave anything that may burn easily, such as paper and rags, in the engine compartment.
- Do not smoke, cause sparks or expose an open flame to fuel. Fuel fumes are flammable.

When working near the electric cooling fan or radiator grille

Be sure the power switch is OFF.

With the power switch in ON, the electric cooling fan may automatically start to run if the air conditioning is on or the coolant temperature is high.

Safety glasses

Wear safety glasses to prevent flying or falling material, fluid spray, etc., from getting in your eyes.

NOTICE

If you remove the air cleaner filter

Driving with the air cleaner filter removed may cause excessive engine wear due to dirt in the air.

Maintenance

Items which require maintenance and the necessary parts and tools to perform maintenance on those items are as follows:

12-volt battery condition

- Grease
- Conventional wrench (for terminal clamp bolts)

■ Brake fluid level

- FMVSS No.116 DOT 3 or SAE J1703; FMVSS No.116 DOT 4 or SAE J1704 brake fluid
- Rag or paper towel
- Funnel (used only for adding brake fluid)

■ Engine/power control unit coolant level

- "Toyota Super Long Life Coolant" or a similar high quality ethylene glycol-based non-silicate, non-amine, nonnitrite and non-borate coolant with long-life hybrid organic acid technology

For the U.S.A.: "Toyota Super Long Life Coolant" is pre-mixed with 50% coolant and 50% deionized water.

For Canada: "Toyota Super Long Life Coolant" is pre-mixed with 55% coolant and 45% deionized water.

- Funnel (used only for adding coolant)

■ Engine oil level

- "Toyota Genuine Motor Oil" or equivalent
- Rag or paper towel
- Funnel (used only for adding engine oil)

■ Fuses

Fuse with same amperage rating as original

■ Light bulbs

Bulb with same number and wattage rating as original

■ Headlight aim

Phillips-head screwdriver

■ Radiator and condenser

-

■ Tire inflation pressure

- Tire pressure gauge
- Compressed air source

■ Washer fluid

- Water or washer fluid containing antifreeze (for winter use)
- Funnel (used only for adding water or washer fluid)

Opening the hood

1 Pull the hood lock release lever.

The hood will pop up slightly.

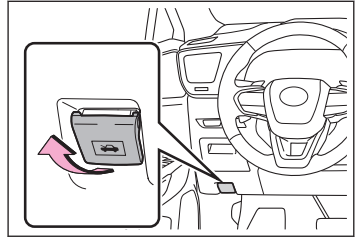

2 Push the auxiliary catch lever to the left and lift the hood.

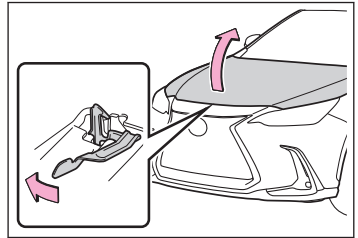

INFORMATION

■ Closing the hood

When closing the hood, make sure to release it from a slightly high position (approximately 7.9 in. [20 cm]) to close it.

If the hood is pushed by hand to close it, it may not lock on both sides.

▲ WARNING

■ Pre-driving check

Check that the hood is fully closed and locked.

If the hood is not locked properly, the hood may suddenly open while driving.

Engine compartment

Engine compartment components

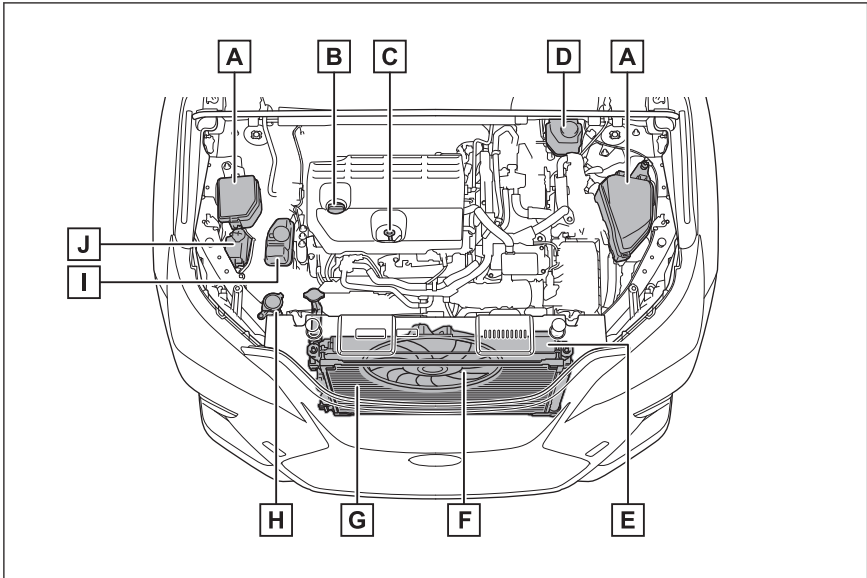

- A** Fuse boxes → P.734
- B** Engine oil filler cap → P.590
- C** Engine oil level dipstick → P.588
- D** Brake fluid reservoir → P.592
- E** Radiator → P.591
- F** Electric cooling fan
- G** Condenser → P.591
- H** Washer fluid tank → P.594
- I** Power control unit coolant reservoir → P.591
- J** Engine coolant reservoir → P.590

Checking and adding the engine oil

INFORMATION

■ Engine oil consumption

A certain amount of engine oil will be consumed while driving. In the following situations, oil consumption may increase, and engine oil may need to be added in between oil maintenance intervals.

8-4. Inspection of consumables

- When the engine is new, for example directly after purchasing the vehicle or after replacing the engine
- If low quality oil or oil of an inappropriate viscosity is used
- When driving at high engine speeds or with a heavy load, when towing (vehicles with towing package only), or when driving while accelerating or decelerating frequently
- When leaving the engine idling for a long time, or when driving frequently through heavy traffic

WARNING

- Used engine oil contains potentially harmful contaminants which may cause skin disorders such as inflammation and skin cancer, so care should be taken to avoid prolonged and repeated contact. To remove used engine oil from your skin, wash thoroughly with soap and water.
- Dispose of used oil and filters only in a safe and acceptable manner. Do not dispose of used oil and filters in household trash, in sewers or onto the ground. Call your Lexus dealer, service station or auto parts store for information concerning recycling or disposal.
- Do not leave used engine oil within the reach of children.

NOTICE

When replacing the engine oil

When replacing the engine oil, observe the following precautions.

- Be careful not to spill engine oil on the vehicle components.
- Avoid overfilling, or the engine could be damaged.
- Check the oil level on the dipstick every time you refill the vehicle.
- Be sure the engine oil filler cap is properly tightened.

If oil is spilled on the engine cover

To prevent the engine cover from being damaged, remove any engine oil from the engine cover as soon as possible using a neutral detergent. Do not use an organic solvent such as brake cleaner.

Checking the engine oil

With the engine at operating temperature and turned off, check the oil level on the dipstick.

⚠ NOTICE

To prevent serious engine damage, check the oil level on a regular basis.

- 1 Park the vehicle on level ground. After warming up the engine and turning off the hybrid system, wait more than 5 minutes for the oil to drain back into the bottom of the engine.
- 2 Holding a rag under the end, pull the dipstick out.

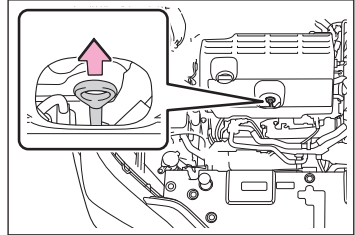

- 3 Wipe the dipstick clean.
- 4 Reinsert the dipstick fully.
- 5 Holding a rag under the end, pull the dipstick out and check the oil level.

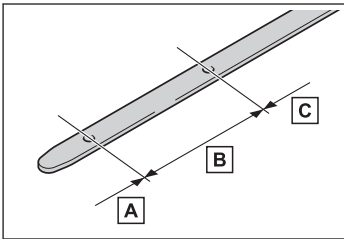

- A Low
- B Normal
- C Excessive

The shape of the dipstick may differ depending on the type of vehicle or engine.

- 6 Wipe the dipstick and reinsert it fully.

Checking the oil type and preparing the items needed

Make sure to check the oil type and prepare the items needed before adding oil.

- Engine oil selection
- Oil quantity (Low → Full)
1.6 qt. (1.5 L, 1.3 Imp.qt.)
- Items
Clean funnel

Related Links

[Lubrication system\(P. 745\)](#)

Adding engine oil

If the oil level is below or near the low level mark, add engine oil of the same type as that already in the engine.

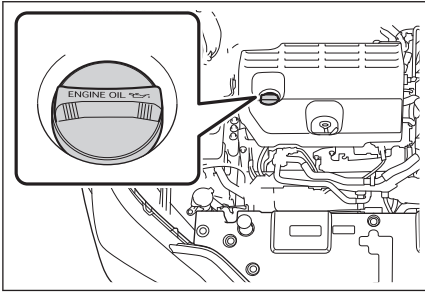

- 1 Remove the oil filler cap by turning it counterclockwise.
- 2 Add engine oil slowly, checking the dipstick.
- 3 Install the oil filler cap by turning it clockwise.

Checking the coolant

The coolant level is satisfactory if it is between the [FULL] and [LOW] lines on the reservoir when the hybrid system is cold.

■ Engine coolant reservoir

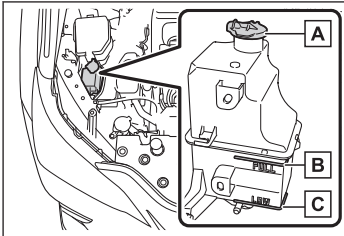

- A Reservoir cap
- B [FULL] line
- C [LOW] line

If the level is on or below the [LOW] line, add coolant up to the [FULL] line.

■ Power control unit coolant reservoir

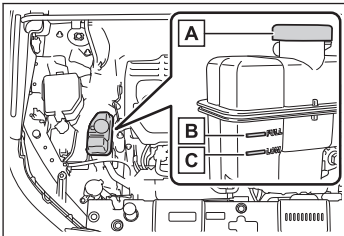

- A Reservoir cap
- B [FULL] line
- C [LOW] line

If the level is on or below the [LOW] line, add coolant up to the [FULL] line.

 **INFORMATION****■ Coolant selection**

Only use "Toyota Super Long Life Coolant" or a similar high quality ethylene glycol based non-silicate, non-amine, non-nitrite, and non-borate coolant with long-life hybrid organic acid technology.

U.S.A.: "Toyota Super Long Life Coolant" is a mixture of 50% coolant and 50% deionized water. (Minimum temperature: -31°F [-35°C])

Canada: "Toyota Super Long Life Coolant" is a mixture of 55% coolant and 45% deionized water. (Minimum temperature: -44°F [-42°C])

For more details about coolant, contact your Lexus dealer.

■ If the coolant level drops within a short time of replenishing

Visually check the radiator, hoses, engine/power control unit coolant reservoir caps, drain cock and water pump.

If you cannot find a leak, have your Lexus dealer test the cap and check for leaks in the cooling system.

▲ WARNING

When the hybrid system is hot, do not remove the engine coolant reservoir cap or power control unit coolant reservoir cap.

The cooling system may be under pressure and may spray hot coolant if the cap is removed, causing serious injuries, such as burns.

▲ NOTICE**■ When adding coolant**

Coolant is neither plain water nor straight antifreeze. The correct mixture of water and antifreeze must be used to provide proper lubrication, corrosion protection and cooling. Be sure to read the antifreeze or coolant label.

■ If you spill coolant

Be sure to wash it off with water to prevent it from damaging parts or paint.

Checking the radiator and condenser

Check the radiator and condenser and clear away any foreign objects.

If either of the above parts is extremely dirty or you are not sure of their condition, have your vehicle inspected by your Lexus dealer.

⚠ WARNING

■ When the hybrid system is hot

Do not touch the radiator or condenser as they may be hot and cause serious injuries, such as burns.

■ When the electric cooling fan are operating

Do not touch the engine compartment. With the power switch in ON, the electric cooling fan may automatically start to run if the air conditioning is on or the coolant temperature is high. Be sure the power switch is OFF when working near the electric cooling fan or radiator grille.

Checking the brake fluid

The brake fluid level should be between the [MAX] and [MIN] lines on the tank.

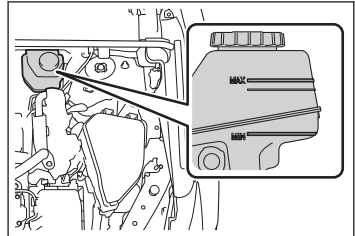

Adding the brake fluid

- 1 Slide and lift up the rubber strip to partly remove it as shown.

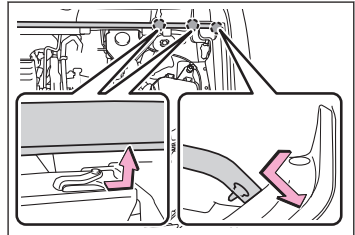

- 2 Disconnect the claws and remove the service cover.

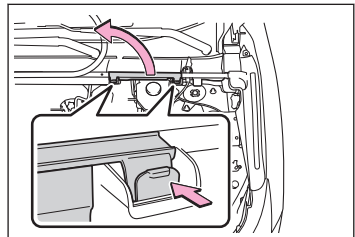

3 Remove the reservoir cap.

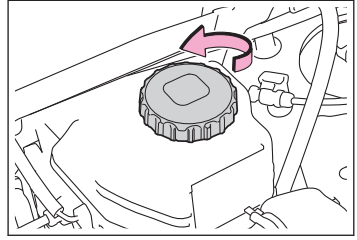

4 Add brake fluid slowly while checking the fluid level.

Make sure to check the fluid type and prepare the necessary item.

- Brake fluid type

FMVSS No.116 DOT 3 or SAE J1703; FMVSS No.116 DOT 4 or SAE J1704 brake fluid

- Items

Clean funnel

⚠ WARNING

Take care when filling the reservoir, as brake fluid can harm your hands and eyes and damage painted surfaces.

If brake fluid gets on your hands or in your eyes, flush the affected area with clean water immediately.

If you experience discomfort, see a doctor.

⚠ NOTICE

It is normal for the brake fluid level to go down slightly as the brake pads wear or when the fluid level in the accumulator is high.

If the reservoir needs frequent refilling, there may be a serious problem.

📄 INFORMATION

■ Brake fluid can absorb moisture from the air

Excess moisture in the brake fluid can cause a dangerous loss of braking efficiency. Use only newly opened brake fluid.

Adding washer fluid

If washer fluid does not spray from any of the washers or "Windshield Washer Fluid Low" is displayed on the multi-information display, the washer fluid bottle may be empty. Add washer fluid.

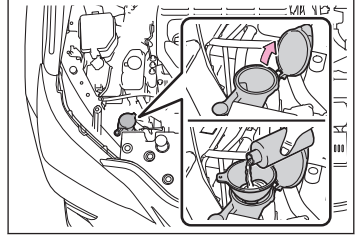

⚠ WARNING

Do not add washer fluid when the hybrid system is hot or operating.

As washer fluid contains alcohol, it may catch fire if spilled on the engine, etc.

⚠ NOTICE

■ Do not use any fluid other than washer fluid

Do not use soapy water or engine antifreeze instead of washer fluid. Doing so may cause streaking on the vehicle's painted surfaces, as well as damaging the pump leading to problems of the washer fluid not spraying.

■ Diluting washer fluid

Dilute washer fluid with water as necessary. Refer to the freezing temperatures listed on the label of the washer fluid bottle.

12-volt battery

12-volt battery location

⚠ WARNING

■ Chemicals in the 12-volt battery

The 12-volt battery contains poisonous and corrosive sulfuric acid and may produce hydrogen gas which is flammable and explosive.

Observe the following precautions while working on or near the 12-volt battery:

- Do not cause sparks by touching the 12-volt battery terminals with tools.
- Do not smoke or light a match near the 12-volt battery.
- Avoid contact with eyes, skin and clothes.
- Never inhale or swallow electrolyte.
- Wear protective safety glasses when working near the 12-volt battery.
- Keep children away from the 12-volt battery.

■ Where to safely charge the 12-volt battery

Always charge the 12-volt battery in an open area. Do not charge the 12-volt battery in a garage or closed room where there is insufficient ventilation.

■ Emergency measures regarding electrolyte

- If electrolyte gets in your eyes, flush your eyes with clean water for at least 15 minutes and get immediate medical attention. If possible, continue to apply water with a sponge or cloth while traveling to the nearest medical facility.
- If electrolyte gets on your skin, wash the affected area thoroughly. If you feel pain or burning, get medical attention immediately.
- If electrolyte gets on your clothes, it may soak through your clothing on to your skin. Immediately take off the clothing and follow the procedure above if necessary.
- If you accidentally swallow electrolyte, drink a large quantity of water or milk and get emergency medical attention immediately.

■ When disconnecting the 12-volt battery

Never disconnect the negative (-) terminal. The disconnected body ground terminal may touch the positive (+) terminal, which may cause a short, resulting in death or serious injury.

8-4. Inspection of consumables

The 12-volt battery is located on the left side of luggage compartment.

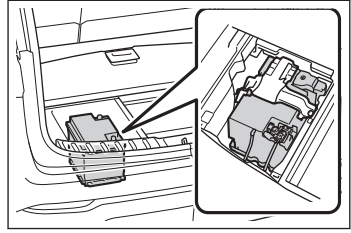

Removing the 12-volt battery cover

- 1 Open the deck board.
- 2 Remove the 12-volt battery cover.

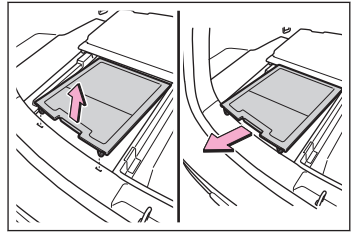

Checking the 12-volt battery

■ 12-volt battery exterior

Make sure that the 12-volt battery terminals are not corroded and that there are no loose connections, cracks, or loose clamps.

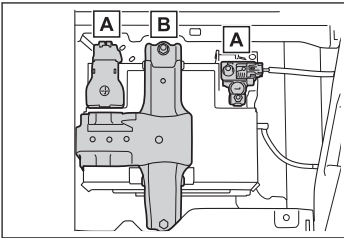

- A Terminals
- B Hold-down clamp

Before recharging

When recharging, the 12-volt battery produces hydrogen gas which is flammable and explosive. Therefore, observe the following precautions before recharging:

- If recharging with the 12-volt battery installed on the vehicle, be sure to disconnect the ground cable.
- Make sure the power switch on the charger is off when connecting and disconnecting the charger cables to the 12-volt battery.

⚠ NOTICE

When recharging the 12-volt battery, make sure that the hybrid system is operating and all accessories are off.

After recharging or reconnecting the 12-volt battery

The hybrid system may not start. Follow the procedure below to initialize the system.

- 1 **Change the shift position to P.**
- 2 **Open and close any of the doors.**
- 3 **Restart the hybrid system.**

📖 INFORMATION

- Unlocking the doors using the smart access system with push-button start may not be possible immediately after reconnecting the 12-volt battery. If this happens, use the wireless remote control or the mechanical key to lock/unlock the doors.
- Start the hybrid system with the power switch in ACC. The hybrid system may not start with the power switch turned off. However, the hybrid system will operate normally from the second attempt.
- The power switch mode is recorded by the vehicle. If the 12-volt battery is disconnected and reconnected, the vehicle will return the power switch to the mode it was in before the 12-volt battery was disconnected. Make sure to turn the power switch off before disconnecting the 12-volt battery. Take extra care when connecting the 12-volt battery if the power switch mode prior to the 12-volt battery being disconnected is unknown.

If the hybrid system does not start even after multiple attempts at all methods above, contact your Lexus dealer.

Air conditioning filter maintenance

The air conditioning filter must be changed regularly to maintain air conditioning efficiency.

Checking interval

Inspect and replace the air conditioning filter according to the maintenance schedule. In dusty areas or areas with heavy traffic flow, early replacement may be required.

- If air flow from the vents decreases dramatically, the air conditioning filter may be clogged. Check the filter and replace it if necessary.
(For scheduled maintenance information, please refer to the "Owner's Manual Supplement" or "Scheduled Maintenance".)
- If air fresheners, etc. are used inside the vehicle, the service life of the deodorizing function of the air conditioning filter with deodorizing function may be reduced significantly. If odors from the air conditioning system become a concern, replace the filter.

Replacing the air conditioning filter

NOTICE

Observe the following precautions when using the air conditioning system.

Make sure that a filter is always installed. Using the air conditioning system without a filter may cause damage to the system.

- 1 Turn the power switch off.
- 2 Open the glove box and disconnect the damper stay from the pin.

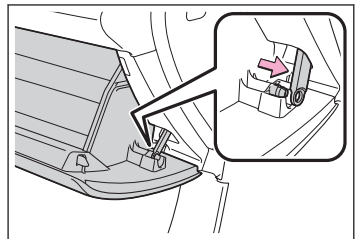

- 3 Push both the sides of the glove box inward and disengage each claw on the upper side. Then, pull the glove box to disengage the claws on the lower side and remove the glove box.

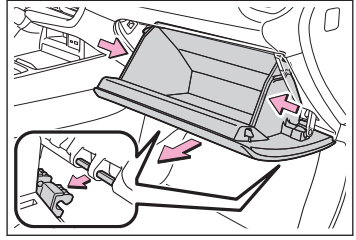

- 4 Unlock the filter cover (A), pull the filter cover out of the claws (B), and remove the filter cover.

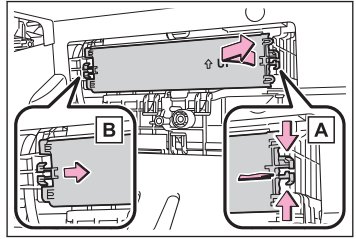

- 5 Remove the filter case.

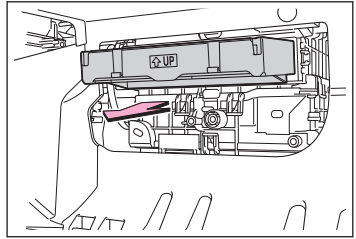

- 6 Remove the air conditioning filter from the filter case and replace it with a new one.

The [↑ UP] marks shown on the filter should be pointing up.

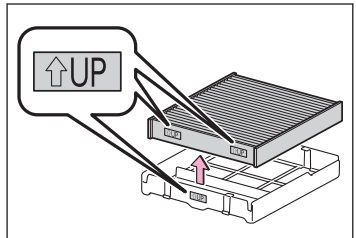

Tire maintenance

Replace or rotate tires in accordance with maintenance schedules and treadwear.

 **NOTICE**

Take particular care when driving on uneven rough roads with cracks and potholes.

These conditions may cause loss of tire inflation pressure, reducing the cushioning ability of the tires. Driving on rough roads may also cause damage to the tires themselves, as well as the vehicle's wheels and body.

Tire inspection items

⚠ WARNING

■ When inspecting or replacing the tires

Observe the following precautions.

Failure to do so may lead to damage to the drivetrain or unstable handling.

- Do not mix tires of different makes, models or tread patterns. Also, do not mix tires of remarkably different treadwear.
- Do not use tire sizes other than those recommended by Lexus.
- Do not mix differently constructed tires (radial, bias-belted or bias-ply tires).
- Do not mix summer, all season and snow tires.
- Do not use tires that have been used on another vehicle.

Do not use tires if you do not know how they were used previously.

⚠ NOTICE

If tire inflation pressure becomes low while driving, do not continue driving. Otherwise the tire or wheel may be damaged.

Check if the treadwear indicators are showing on the tires. Also check the tires for uneven wear, such as excessive wear on one side of the tread.

Check the spare tire condition and pressure if not rotated.

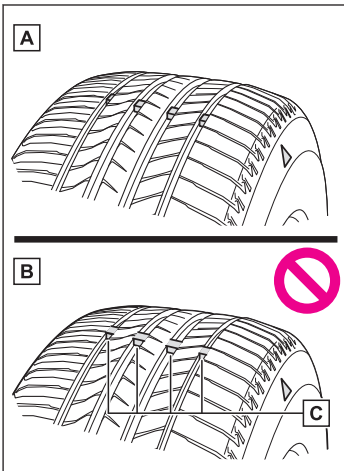

- A New tread
- B Worn tread
- C Treadwear indicator

The location of treadwear indicators is shown by a [TWI] or \triangle mark, etc., molded into the sidewall of each tire.

Replace the tires if the treadwear indicators are showing on a tire.

□ INFORMATION

■ When to replace your vehicle's tires

Tires should be replaced if:

- The treadwear indicators are showing on a tire.
- You have tire damage such as cuts, splits, cracks deep enough to expose the fabric, and bulges indicating internal damage.
- A tire goes flat repeatedly or cannot be properly repaired due to the size or location of a cut or other damage.

If you are not sure, consult with your Lexus dealer.

■ Tire life

Any tire over 6 years old must be checked by a qualified technician even if it has seldom or never been used or damage is not obvious.

■ Maximum load of tire

Check that the maximum load of the replacement tire is greater than 1/2 of the Gross Axle Weight Ratings (GAWR) of either the front axle or the rear axle, whichever is greater.

For the GAWR, see the Certification Label.

For the maximum load of the tire, see the load limit at maximum cold tire inflation pressure mentioned on the sidewall of the tire.

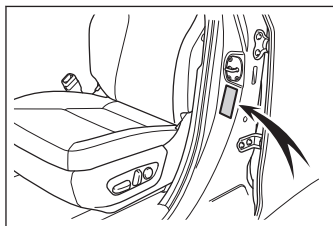

■ Tire types

- Summer tires

Summer tires are high-speed performance tires best suited to highway driving under dry conditions. Since summer tires do not have the same traction performance as snow tires, summer tires are inadequate for driving on snow-covered or icy roads. For driving on snow-covered roads or icy roads, the use of snow tires is recommended. When installing snow tires, be sure to replace all four tires.

- All season tires

All season tires are designed to provide better traction in snow and to be adequate for driving in most winter conditions as well as for use year-round. All season tires, however, do not have adequate traction performance compared with snow tires in heavy or loose snow. Also, all season tires fall short in acceleration and handling performance compared with summer tires in highway driving.

- Snow tires

For driving on snow-covered roads or icy roads, we recommend using snow tires. If you need snow tires, select tires of the same size, construction and load capacity as the originally installed tires. Since your vehicle has radial tires as original equipment, make

sure your snow tires also have radial construction. Do not install studded tires without first checking local regulations for possible restrictions.

Snow tires should be installed on all wheels.

■ **If the tread on snow tires wears down below 0.16 in. (4 mm)**

The effectiveness of the tires as snow tires is lost.

Run-flat tire features

When run-flat tires are installed, the vehicle can be driven for a maximum of 50 miles (80 km) at a speed below 50 mph (80 km/h) after any tire goes flat. (However, the vehicle speed may not increase to near 50 mph [80 km/h] depending on weather or driving conditions.)

Make sure to replace the flat tire before the vehicle has been driven for near 50 miles (80 km). Also, do not use a repaired tire.

A run-flat tire has a  mark on the side wall.

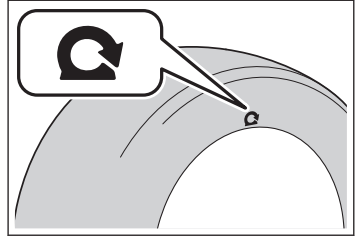

INFORMATION

■ Precautions for run-flat tires

- The run-flat tires are for only this vehicle. Do not use the tires on other vehicles.
- Do not mix run-flat tires and normal tires.
- If non-genuine Lexus wheels are used, it may be impossible to sufficiently demonstrate the performance of run-flat tires.

Operation of the tire pressure warning system

Your vehicle is equipped with a tire pressure warning system that uses tire pressure warning valves and transmitters to detect low tire inflation pressure before serious problems arise.

The tire pressure warning system of this vehicle adopts a 2-type warning system.

► Multi-information display (vehicles without a head-up display)



► Multi-information display (vehicles with a head-up display)

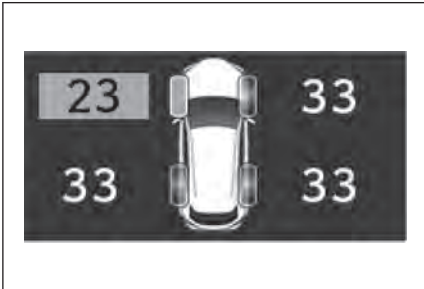

► Center display

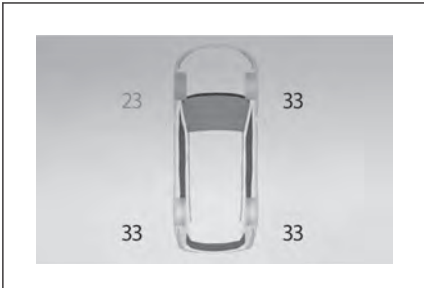

● When "Adjust Pressure" is displayed (Normal Warning)

A warning with the tire pressure warning light and warning buzzer when there is an unknown level of low tire pressure with the appearance of the tire due to natural air leakage as well as the pressure lowering due to changes in the pressure according to the outside temperature.

● When **"Immediately Check tire when Safe"** is displayed (Emergency Warning)

A warning with the tire pressure warning light and warning buzzer when there is a known level of low tire pressure with the appearance of the tire due to pressure suddenly lowering.

However, the system may not be able to detect sudden tire ruptures (bursting, etc.).

● The tire pressure detected by the tire pressure warning system can be displayed on the center display.

INFORMATION

■ Routine tire inflation pressure checks

The tire pressure warning system does not replace routine tire inflation pressure checks.

Make sure to check tire inflation pressure as part of your routine of daily vehicle checks.

■ Tire inflation pressure

- It may take a few minutes to display the tire inflation pressure after the power switch is turned to ON.

It may also take a few minutes to display the tire inflation pressure after inflation pressure has been adjusted.

- Tire inflation pressure changes with temperature. The displayed values may also be different from the values measured using a tire pressure gauge.

■ Situations in which the tire pressure warning system may not operate properly

- In the following cases, the tire pressure warning system may not operate properly.
 - If non-genuine Lexus wheels are used.
 - A tire has been replaced with a tire that is not an OE (Original Equipment) tire.
 - A tire has been replaced with a tire that is not of the specified size.
 - Tire chains, etc. are equipped.
 - If a window tint that affects the radio wave signals is installed.
 - If there is a lot of snow or ice on the vehicle, particularly around the wheels or wheel housings
 - If the tire inflation pressure is extremely higher than the specified level.
 - If tires not equipped with tire pressure warning valves and transmitters are used.
 - If the ID code on the tire pressure warning valves and transmitters is not registered in the tire pressure warning computer.
- Performance may be affected in the following situations.

- Near a TV tower, electric power plant, gas station, radio station, large display, airport or other facility that generates strong radio waves or electrical noise.
- When carrying a portable radio, cellular phone, cordless phone or other wireless communication device.

If tire position information is not correctly displayed due to the radio wave conditions, the display may be corrected by changing the location of the vehicle as the radio wave conditions may change.

- When the vehicle is parked, the time taken for the warning to start or go off could be extended.
- When tire inflation pressure declines rapidly for example when a tire has burst, the not to able detect.

Related Links

[Tire pressure](#)(P. 360)

[Tire pressure warning light \(warning buzzer\)](#)(P. 645)

Installing tire pressure warning valves and transmitters

NOTICE

Repairing or replacing tires, wheels, tire pressure warning valves, transmitters and tire valve caps

- When removing or fitting the wheels, tires or the tire pressure warning valves and transmitters, contact your Lexus dealer as the tire pressure warning valves and transmitters may be damaged if not handled correctly.
- Make sure to install the tire valve caps. If the tire valve caps are not installed, water could enter the tire pressure warning valves, corrode the valve, and cause sticking and air leaks.
- When replacing tire valve caps, do not use tire valve caps other than those specified. The cap may become stuck.

When replacing tires or wheels, tire pressure warning valves and transmitters must also be installed.

When new tire pressure warning valves and transmitters are installed, new ID codes must be registered in the tire pressure warning computer

INFORMATION

When replacing the tires and wheels

If the ID code of the tire pressure warning valve and transmitter is not registered, the tire pressure warning system will not work properly.

8-5. Tire maintenance

In this case, after driving for about 20 minutes, the tire pressure warning light blinks for 1 minute and stays on to indicate a system malfunction.

Registration of the position of each wheel after performing a tire rotation

It is necessary to register the position of each wheel after performing a tire rotation.

Wheel position registration can be performed by oneself. Wheel position registration is performed by driving forward with moderate left and right turns. However, depending on the driving conditions and driving environment, registration may take some time to complete.

- 1 **Park the vehicle in a safe place, turn the power switch off and wait 15 minutes or more.**
- 2 **Start the hybrid system.**

The wheel position registration procedure cannot be performed while the vehicle is moving.

- 3 **Select  on the center display.**
- 4 **Select [Vehicle customize].**
- 5 **Select [Tire pressure].**
- 6 **Select [Tire rotation].**
- 7 **Select [Continue].**

A message indicating that wheel position registration is being performed will be displayed on the multi-information display. "---" will be displayed for the tire inflation pressure of each tire and wheel position registration will begin.

- 8 **Drive straight (with occasional left and right turns) at approximately 25 mph (40 km/h) or more for approximately 10 to 30 minutes.**

When wheel position registration is complete, a message indicating that registration has been completed and the inflation pressure of each tire will be displayed on the multi-information display.

Even if it is not possible to drive continuously at approximately 25 mph (40 km/h) or more, registration can be completed by driving for a long time. However, if registration does not complete after driving for 1 hour or more, park the vehicle in a safe place and leave it with the power switch in ON for approximately 15 minutes or more, and then perform the driving procedure again.

INFORMATION

■ When performing wheel position registration

- Normally, wheel position registration can be completed within approximately 30 minutes.
- Wheel position registration is performed while driving at a vehicle speed of approximately 25 mph (40 km/h) or more.

■ Wheel position registration procedure

- If the power switch is turned off while registering the wheel position, the next time the power switch is turned to ON, the wheel position registration will resume and it will not be necessary to restart the procedure.
- While the position of each wheel is being determined and the inflation pressures are not being displayed, if the inflation pressure of a tire drops, the tire pressure warning light will come on.

■ If the wheel position cannot be registered easily

- In the following situations, wheel position registration may take longer than usual to be completed or may not be possible.
 - Vehicle is not driven at approximately 25 mph (40 km/h) or more
 - Vehicle is driven on unpaved roads
 - If wheel position registration does not complete after driving for 1 hour or more, park the vehicle in a safe place for approximately 15 minutes and then drive the vehicle again.
- If the vehicle is reversed during wheel position registration, all data collected until then will be cleared. Perform driving again.

Setting the tire pressure

In the following situations, it will be necessary to perform the tire inflation pressure setting procedure of the tire pressure warning system.

- When the specified tire inflation pressure has changed, such as due to carried load, etc.
- When the tire inflation pressure is changed such as when the tire size is changed.

If the tire inflation pressure has been adjusted to the specified level, perform the tire inflation setting procedure by selecting specified inflation pressure on the center display.

When the tire inflation pressure is to be other than specified, such as when tires other than the specified size are used, etc., set the tire inflation pressure using the current pressure. Make sure to adjust the tire inflation pressure of each tire

8-5. Tire maintenance

to the appropriate level before performing tire pressure setting. The tire pressure warning system operates based on this tire inflation pressure.

Related Links

[Setting by selecting a specified tire inflation pressure\(P. 610\)](#)

[Setting using the current tire inflation pressure\(P. 610\)](#)

Setting by selecting a specified tire inflation pressure

1 Start the hybrid system.

The tire inflation pressure cannot be set while the vehicle is moving.

2 Select on the center display.

3 Select [Vehicle customize].

4 Select [Tire pressure].

5 Select [Set indicated air pressure] and then select the desired front and rear tire pressures.

6 Select [OK].

The tire pressure warning light will slowly blink 3 times.

After setting the tire inflation pressure, a message indicating that setting has been completed will be displayed on the multi-information display.

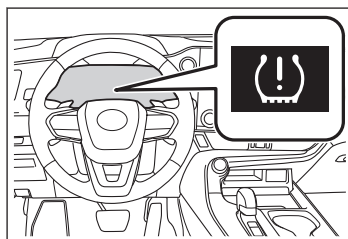

INFORMATION

■ If the tire inflation pressure cannot be set easily

- If the tire pressure warning light does not blink 3 times when starting the tire inflation pressure setting procedure, the procedure may not have started. Perform the procedure again from the beginning.
- If tire inflation pressure setting procedure cannot be completed after performing the above procedure, contact your Lexus dealer.

Setting using the current tire inflation pressure

WARNING

Make sure to adjust the tire inflation pressure of each tire to the appropriate level before performing tire pressure setting. Otherwise, the tire pressure warning light may not illuminate even if the tire inflation pressure drops or may illuminate even though the tire inflation pressure is normal.

INFORMATION

Warning performance of the tire pressure warning system

- When performing the tire pressure setting using the current tire inflation pressure, the warning timing of the tire pressure warning system will vary according to the conditions under which tire pressure setting was performed. Therefore, a warning may be output even if the tire inflation pressure drops slightly or if the tire inflation pressure increases above that when the tire inflation pressure was set.
- Make sure to perform the tire pressure setting procedure after adjusting the tire inflation pressure. Also, make sure the tires are cold before performing the tire pressure setting procedure or adjusting the tire inflation pressure.

1 Adjust the tire inflation pressure of each tire to the appropriate level.

Make sure to adjust the tire inflation pressure with the tires cold.

2 Start the hybrid system.

The tire inflation pressure cannot be set while the vehicle is moving.

3 Select on the center display.

4 Select [Vehicle customize].

5 Select [Tire pressure].

6 Select [Set current air pressure].

7 Select [Continue].

The tire pressure warning light will slowly blink 3 times and a message indicating that tire inflation pressure is being set will be displayed on the multi-information display.

After setting the tire inflation pressure, a message indicating that setting has been completed will be displayed on the multi-information display.

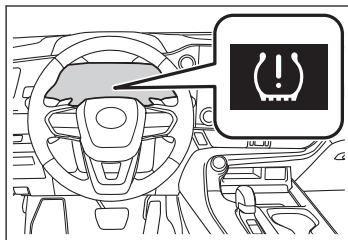

INFORMATION

Tire inflation pressure setting procedure

- If the power switch is turned off while setting the tire inflation pressure, the next time the power switch is turned to ON, the setting procedure will resume and it will not be necessary to restart the procedure.
- If the tire inflation pressure setting procedure is started unnecessarily, adjust the tire inflation pressure to the specified level with the tires cold and then perform setting by selecting a specified tire inflation pressure, or perform the tire inflation pressure setting procedure with the current tire inflation pressure.

■ If the tire inflation pressure cannot be set easily

- Normally, the tire inflation pressure setting procedure can be completed in 2 or 3 minutes.
- If the tire pressure warning light does not blink 3 times when starting the tire inflation pressure setting procedure, the procedure may not have started. Perform the procedure again from the beginning.
- If tire inflation pressure setting procedure cannot be completed after performing the above procedure, contact your Lexus dealer.

Registering ID codes

The tire pressure warning valve and transmitter is equipped with a unique ID code. When new tire pressure warning valves and transmitters are installed, new ID codes must be registered in the tire pressure warning computer.

□ INFORMATION

- ID codes can be registered by yourself, but depending on the driving conditions and driving environment, registration may take some time to complete.
- When using a wheel set which all of the ID codes have already been registered, the wheel set can be changed in a short amount of time.

Before performing ID code registration, make sure that no wheels with tire pressure warning valve and transmitters installed are near the vehicle.

- 1 **Park the vehicle in a safe place, turn the power switch off and wait 15 minutes or more.**
- 2 **Start the hybrid system.**
The ID code registration procedure cannot be performed while the vehicle is moving.
- 3 **Select  on the center display.**
- 4 **Select [Vehicle customize].**
- 5 **Select [Tire pressure].**
- 6 **Check if the desired wheel set ([Set 1] or [Set 2]) is displayed.**

ID codes will be registered to the displayed wheel set.

To change the wheel set to be registered, select the displayed set, and then select the wheel set you wish to register.

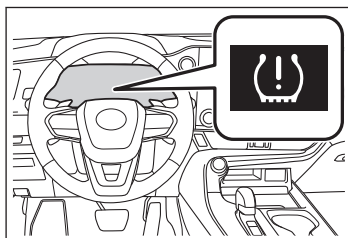

If ID codes have already been registered for that wheel set, the tire pressure warning light will slowly blink 3 times, and a message indicating that change is occurring will be displayed on the multi-information display.

7 Select [New tire registration].

8 Select [Continue].

The tire pressure warning light will slowly blink 3 times and a message indicating that ID code registration is being performed will be displayed on the multi-information display. Wheel set changing will be canceled and registration will begin.

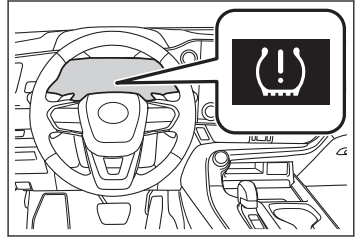

When registration is being performed, the tire pressure warning light will blink for approximately 1 minute then illuminate and "---" will be displayed for the inflation pressure of each tire on the multi-information display.

INFORMATION

If the tire pressure warning light does not blink 3 times when starting ID code registration procedure, the procedure may not have started. Perform the procedure again from the beginning.

9 Drive straight (with occasional left and right turns) at approximately 25 mph (40 km/h) or more for approximately 10 to 30 minutes.

When registration is complete, the tire pressure warning light will turn off and a message indicating that registration has been completed will be displayed on the multi-information display.

Registration may take longer than normal to complete if the vehicle speed cannot be maintained at approximately 25 mph (40 km/h) or more. If registration cannot be completed after driving for 1 hour or more, perform the registration procedure again from the beginning.

INFORMATION

■ When registering ID codes

- Normally, wheel position registration can be completed within approximately 30 minutes.
- ID code registration is performed while driving at a vehicle speed of approximately 25 mph (40 km/h) or more.

■ If ID codes are not registered easily

- In the following situations, ID code registration may take longer than usual to be completed or may not be possible.

- When the vehicle has not been parked for approximately 15 minutes or more before being driven
 - Vehicle is not driven at approximately 25 mph (40 km/h) or more
 - Vehicle is driven on unpaved roads
 - Vehicle is driven near other vehicles and system cannot recognize tire pressure warning valve and transmitters of your vehicle over those of other vehicles
 - Wheel with tire pressure warning valve and transmitter installed is inside or near the vehicle
- If the vehicle is reversed during registration, all data collected until then will be cleared. Perform driving again.
 - If registration does not complete after driving for 1 hour or more, perform the ID code registration procedure again from the beginning.
 - If the ID codes cannot be registered even when performing the above procedure, contact your Lexus dealer.

10 If the tire inflation pressure of the wheel set installed differs from that of the previous set, it will be necessary to perform the tire inflation pressure setting procedure of the tire pressure warning system.

If the specified tire inflation pressure is the same, it will not be necessary to perform the tire inflation pressure setting procedure.

Related Links

[Setting the tire pressure\(P. 609\)](#)

Canceling ID code registration

To cancel ID code registration after it has been started, select [**New tire registration**] again on the center display.

If ID code registration has been canceled, the tire pressure warning light will turn off.

If the warning light does not turn off, ID code registration may not have been cancelled correctly. To cancel registration, select [**New tire registration**] again on the center display.

Selecting wheel set

Your vehicle is equipped with a tire pressure warning system with a function to register two sets of ID codes. This allows for registration of a second wheel set, for example a winter set.

- The wheel set can be changed only if a second wheel set has been registered to the system. If a second wheel set has not been registered, "**Set 2(Unregistered)**" will be displayed and it will not be possible to change to the selected wheel set.

ID codes can be registered by yourself.

- Only a change between both registered wheel set is possible, mixing between these wheel sets is not supported.
- While registering ID codes, it may not be possible to change between wheel sets normally. Cancel registration before changing between wheel sets.

- 1 Install the desired wheel set.
- 2 Select  on the center display.
- 3 Select [Vehicle customize].
- 4 Select [Tire pressure].
- 5 Select the wheel set ([Set 1] or [Set 2]) displayed for the set selection setting.
- 6 Select the wheel set you wish to register, and then select [OK].

The tire pressure warning light will slowly blink 3 times, a message indicating that change is occurring will be displayed, and the wheel set change will begin.

Wheel set change will begin and the tire pressure warning light will blink for 1 minute and then illuminate. Also, while the change is being performed, "---" will be displayed for the tire inflation pressure of each tire on the multi-information display.

After approximately 2 minutes, the wheel set change will complete, the tire pressure warning light will turn off, and a completion message will be displayed on the multi-information display.

If changing does not complete after approximately 4 minutes, a message indicating that the change could not be completed will be displayed.

Check which wheel set is installed and perform the change procedure again from the beginning.

- 7 **If the specified tire inflation pressure of the wheel set installed differs from that of the previous set, it will be necessary to perform the tire inflation pressure setting procedure of the tire pressure warning system.**

If the specified tire inflation pressure is the same, it will not be necessary to perform the tire inflation pressure setting procedure.

- 8 Register the position of each wheel.

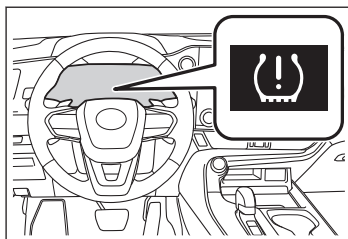

Related Links

[Registration of the position of each wheel after performing a tire rotation\(P. 608\)](#)

Checking tire inflation pressure

You should check tire inflation pressure every two weeks, or at least once a month. Do not forget to check the spare.

WARNING

In order to ensure the performance of the tires, maintain proper tire inflation pressure.

If the tires are not properly inflated, the following may occur:

- Excessive wear
- Uneven wear
- Poor handling
- Possibility of blowouts resulting from overheated tires
- Air leaking from between tire and wheel
- Wheel deformation and/or tire damage
- Greater possibility of tire damage while driving (due to road hazards, expansion joints, sharp edges in the road, etc.)

NOTICE

After inspecting and adjusting tire inflation pressure, make sure to install the tire valve caps.

If a valve cap is not installed, dirt or moisture may get into the valve and cause an air leak, resulting in decreased tire inflation pressure.

Driving with incorrect tire inflation pressure may result in the following:

- Reduced fuel economy
- Reduced driving comfort and poor handling
- Reduced tire life due to wear
- Reduced safety
- Damage to the drive train

If a tire needs frequent inflating, have it checked by your Lexus dealer.

■ Instructions for checking tire inflation pressure

When checking tire inflation pressure, observe the following:

- Check only when the tires are cold.

If your vehicle has been parked for at least 3 hours or has not been driven for more than 1 mile or 1.5 km, you will get an accurate cold tire inflation pressure reading.

- Always use a tire pressure gauge.

It is difficult to judge if a tire is properly inflated based only on its appearance.

- It is normal for the tire inflation pressure to be higher after driving as heat is generated in the tire. Do not reduce tire inflation pressure after driving.
- Never exceed the vehicle capacity weight.

Passengers and luggage weight should be placed so that the vehicle is balanced.

Checking the specified tire inflation pressure

The recommended cold tire inflation pressure and tire size are displayed on the tire and loading information label.

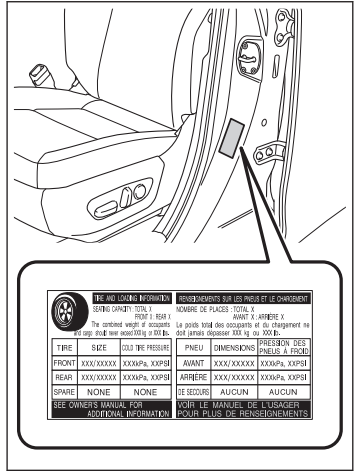

Tire inflation pressure inspection and adjustment procedure

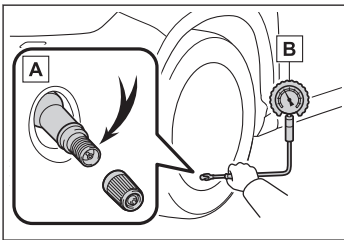

- 1 **A** Tire valve
- 2 **B** Tire pressure gauge
- 1 Remove the tire valve cap.
- 2 Press the tip of the tire pressure gauge onto the tire valve.
- 3 Read the pressure using the gauge gradations.
- 4 If the tire inflation pressure is not at the recommended level, adjust the pressure.

If you add too much air, press the center of the valve to deflate.

- 5 After completing the tire inflation pressure measurement and adjustment, apply soapy water to the valve and check for leakage.
- 6 Put the tire valve cap back on.

Lifting the vehicle with a floor jack

When using a floor jack, follow the instructions in the manual provided with the jack and perform the operation safely. When raising your vehicle with a floor jack, position the jack correctly. Improper placement may damage your vehicle or cause injury.

Front jack point position

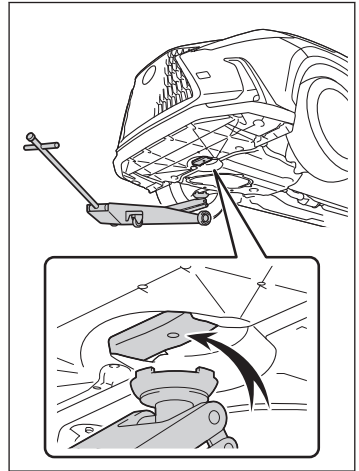

Rear jack point position

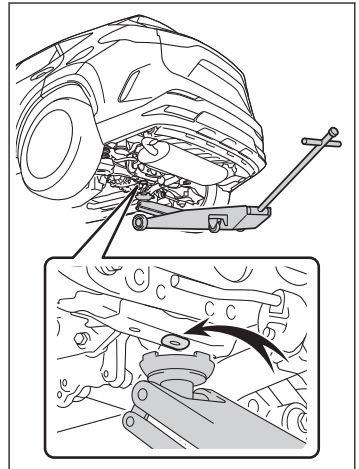

Rotating the tires

To equalize tire wear and extend tire life, Lexus recommends that tire rotation be performed at the same interval as tire inspection.

Rotate the tires as shown in the illustration.

Make sure to perform wheel position registration procedure after rotating the tires.

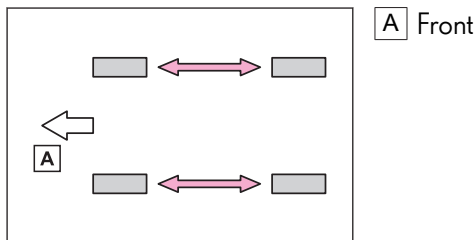

Related Links

[Registration of the position of each wheel after performing a tire rotation\(P. 608\)](#)

Wheels

If a wheel is bent, cracked or heavily corroded, it should be replaced. Otherwise, the tire may separate from the wheel, causing a loss of handling control.

Wheel selection

When replacing wheels, care should be taken to ensure that they are equivalent to those removed in load capacity, diameter, rim width and inset*1.

Replacement wheels are available at your Lexus dealer.

Lexus does not recommend using the following:

- Wheels of different sizes or types
- Used wheels
- Bent wheels that have been straightened

INFORMATION

When replacing wheels

The wheels of your vehicle are equipped with tire pressure warning valves and transmitters that allow the tire pressure warning system to provide advance warning in the event of a loss in tire inflation pressure.

Whenever wheels are replaced, tire pressure warning valves and transmitters must be installed.

WARNING

When replacing wheels

- Do not use wheels that are a different size from those recommended in the Owner's Manual, as this may result in a loss of handling control.
- Never use an inner tube in a leaking wheel which is designed for a tubeless tire. Doing so may result in an accident, causing death or serious injury.
- Use the correct wheel bolts for the wheels to be installed.

For details, contact your Lexus dealer.

Wheel bolts

Observe the following precautions to reduce the risk of death or serious injury:

- Do not over tighten.
- Never use oil or grease on the wheel bolts. Oil and grease may cause the wheel bolts to be excessively tightened, leading to bolt or disc wheel damage. In addition, the oil

*1: Conventionally referred to as offset.

⚠ WARNING

or grease can cause the wheel bolts to loosen and the wheel may fall off, causing a serious accident. Remove any oil or grease from the wheel bolts.

- If there are any cracks or deformations in the wheel bolts, or if the surface treatment becomes worn, have the wheel bolts replaced at your Lexus dealer. Failure to follow these precautions could cause the wheel bolts to loosen and the tire to fall off, resulting in death or serious injury.

■ Use of defective wheels prohibited

Do not use cracked or deformed wheels.

Doing so could cause the tire to leak air during driving, possibly causing an accident.

⚠ NOTICE**■ Replacing tire pressure warning valves and transmitters**

- Because tire repair or replacement may affect the tire pressure warning valves and transmitters, make sure to have tires serviced by your Lexus dealer or other qualified service shop. In addition, make sure to purchase your tire pressure warning valves and transmitters at your Lexus dealer.
- Ensure that only genuine Lexus wheels are used on your vehicle.
Tire pressure warning valves and transmitters may not work properly with non-genuine wheels.

Aluminum wheel precautions

Observe the following precautions when handling the aluminum wheels.

- Use only Lexus wheel bolts and wrenches designed for use with your aluminum wheels.
- When rotating, repairing or changing your tires, check that the wheel bolts are still tight after driving 621 miles (1000 km).
- Be careful not to damage the aluminum wheels when using tire chains.
- Use only Lexus genuine balance weights or equivalent and a plastic or rubber hammer when balancing your wheels.

Replacing the tire

When raising your vehicle with a jack, position the jack correctly.

Improper placement may damage your vehicle or cause injury.

If necessary tire replacement seems difficult to perform, contact your Lexus dealer.

Preparation for lifting the vehicle with a jack

□ INFORMATION

■ Jack and tools

As your vehicle is equipped with run-flat tires, the following tools for replacing a tire are not included with your vehicle. They can be purchased at your Lexus dealer.

- Jack
- Jack handle
- Wheel bolt socket
- Guide pin
- Wheel bolt wrench

Before lifting the vehicle with a jack, perform the following.

- Stop the vehicle in a safe place on a hard, flat surface.
- Set the parking brake.
- Change the shift position to P.
- Stop the hybrid system.

Storage position of the tools and jack

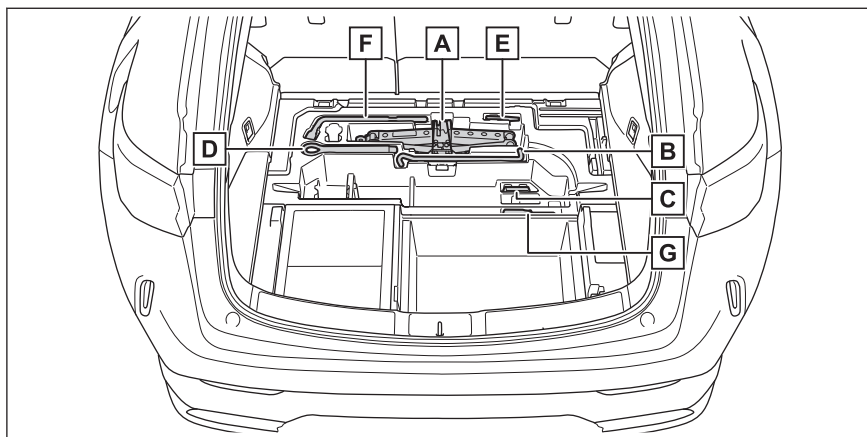

A Jack*

⚠ WARNING

Improper use of the tire jack may cause the vehicle to fall. Therefore, observe the following precautions.

- Do not use the tire jack for any purpose other than replacing tires or installing and removing tire chains.
- Only use the tire jack that comes with this vehicle for replacing a flat tire. Do not use it on other vehicles, and do not use other tire jacks for replacing tires on this vehicle.

B Jack handle*

C Wheel bolt socket*

D Towing eyelet*

E Guide pin*

F Wheel bolt wrench*

G Screwdriver

Taking out the jack

1 Remove the deck board.

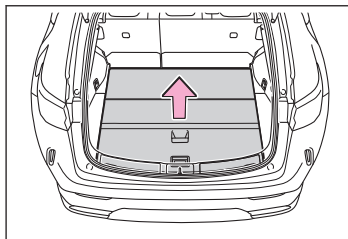

2 Take out the jack.

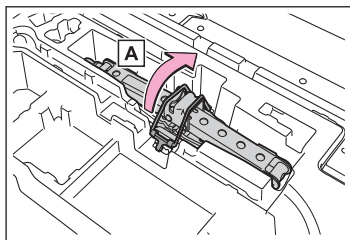

A Disengage the tightening strap.

*: If equipped

Removing a tire

⚠ WARNING

■ Precautions for replacing a tire

- Do not try to remove the wheel ornament by hand.

Take due care in handling the ornament to avoid unexpected personal injury.

- Do not touch the disc wheels or the area around the brakes immediately after the vehicle has been driven.

After the vehicle has been driven the disc wheels and the area around the brakes will be extremely hot. Touching these areas with hands, feet or other body parts while changing a tire, etc., may result in burns.

■ Setting the power back door when replacing the tires

When replacing a tire, make sure to disable the power back door. If not disabled, the power back door may operate unintentionally, and hands or fingers may be caught and injured.

1 Chock the tires.

Wheel chock position

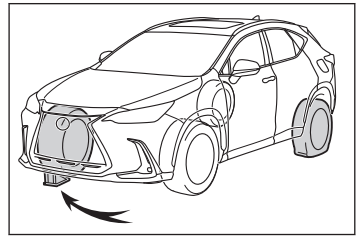

- Flat tire: Front left

Place the wheel chock behind the rear right tire.

- Flat tire: Front right

Place the wheel chock behind the rear left tire.

- Flat tire: Rear left

Place the wheel chock in front of the front right tire.

- Flat tire: Rear right

Place the wheel chock in front of the front left tire.

- 2 Using a wheel bolt wrench, slightly loosen the wheel bolts (approximately one turn).

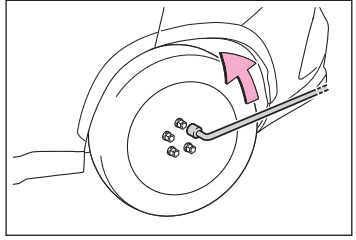

- 3 Turn the tire jack portion **A** by hand until the notch of the jack is in contact with the jack point.

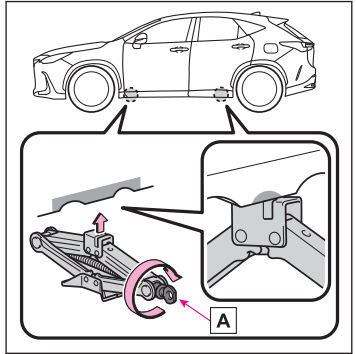

▲ WARNING

Make sure the jack is positioned properly in the jack point.

- 4 Install the wheel bolt socket to the jack handle.

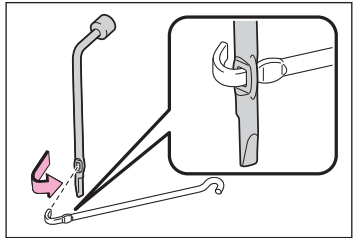

- 5 Raise the vehicle until the tire is slightly raised off the ground.

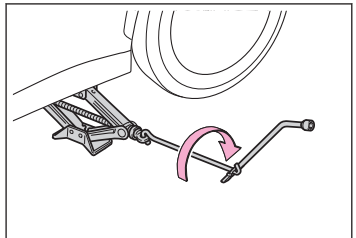

▲ WARNING

Observe the following precautions when using the jack.

⚠ WARNING

- Do not put any part of your body under the vehicle while it is supported by the jack.
- Do not start the hybrid system or drive the vehicle while the vehicle is supported by the jack.
- Do not raise the vehicle while someone is inside.
- When raising the vehicle, do not put an object on or under the jack.
- Do not raise the vehicle to a height greater than that required to replace the tire.
- Use a jack stand if it is necessary to get under the vehicle.

6 Remove the uppermost wheel bolt and install the guide pin **A** by hand.

Turn the guide pin clockwise to tighten it until it stops.

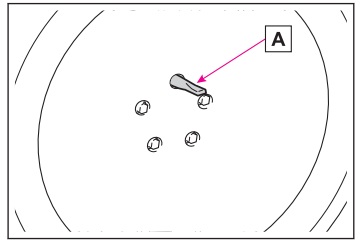

⚠ WARNING

When removing or installing a tire, make sure to use the guide pin.

Also, the guide pin is made of resin. It may be damaged if the wheel is placed anywhere other than **A** or if a large amount of force is applied to the guide pin.

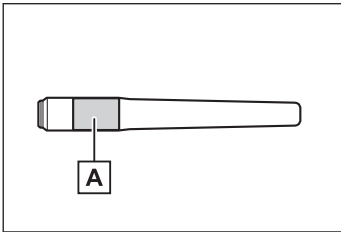

7 Remove the remaining wheel bolts and the tire.

When resting the tire on the ground, place the tire so that the wheel design faces up, to avoid scratching the wheel surface.

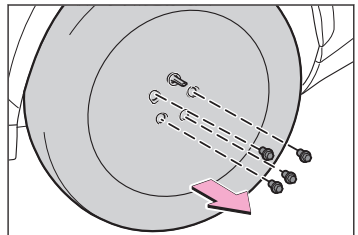

Installing the tire

- 1 Remove any dirt or foreign matter from the wheel contact surfaces and wheel bolts.

If foreign matter is not removed, the wheel bolts may loosen while the vehicle is in motion, and the wheel may come off.

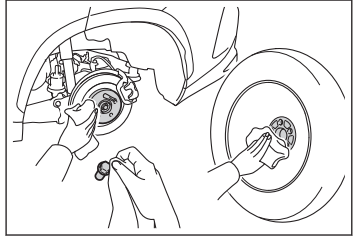

- 2 Align a wheel bolt hole on the spare tire with the guide pin, and set the spare tire on the guide pin.

Align the center hole of the wheel with the center of the hub and securely set the spare tire so that the wheel and hub contact surfaces are touching.

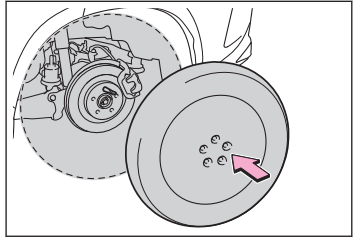

⚠ WARNING

When removing or installing a tire, make sure to use the guide pin.

Also, the guide pin is made of resin. It may be damaged if the wheel is placed anywhere other than **A** or if a large amount of force is applied to the guide pin.

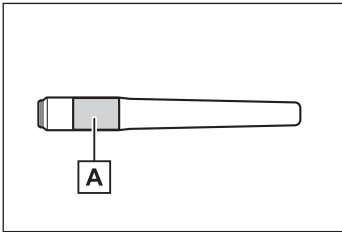

- 3 Loosely tighten each wheel bolt by hand or using a wheel bolt socket **A**.

Do not use the wheel bolt socket for anything other than loosely tightening the wheel bolts by hand.

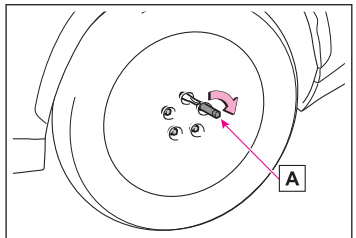

⚠ WARNING

Observe the following precautions. Failure to do so may lead to the wheel bolts loosening and the tire falling off.

- Never apply oil or grease to the wheel bolts or their contact surface on the wheel **A**.

Doing so may cause the wheel bolts to be tightened excessively, leading to damage to the wheel bolts, the threaded portion the wheel bolts install to **B**, or the wheel.

Also, the wheel bolts may come loose, possibly leading to the wheel coming off, causing a serious accident. If oil or grease is attached to either of these parts, remove it.

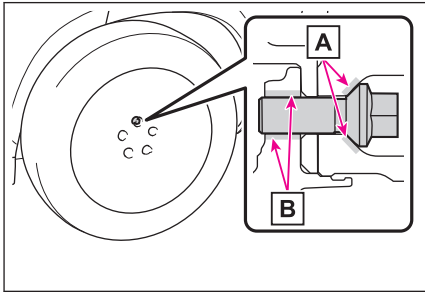

- When installing a wheel, use the same wheel bolts that were removed with the wheel. Also, do not use any wheel bolts other than Lexus Genuine wheel bolts.
- If a wheel bolt hole in a wheel or the threads of a wheel bolt or the wheel hub are deformed, cracked, rusty or otherwise damaged, have the vehicle inspected by your Lexus dealer.
- Do not install the wheel ornament if it is damaged, as it may fly off the wheel while the vehicle is being driven.

- 4 Remove the guide pin and loosely tighten the wheel bolt as in step 3.

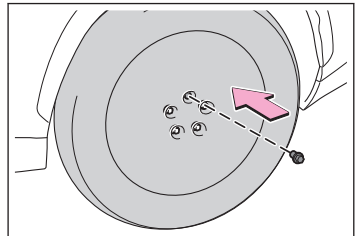

5 Lower the vehicle.

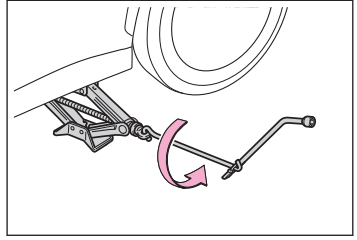

⚠ WARNING

When lowering the vehicle, make sure that no one is near the vehicle. If there are people nearby, warn them vocally before lowering the vehicle.

6 Firmly tighten each wheel bolt in the order shown in the illustration two or three times.

Tightening torque: 103 ft•lb (140 N•m, 14.3 kgf•m)

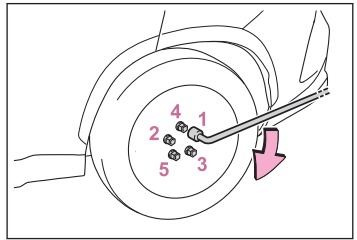

⚠ WARNING

When tightening the wheel bolts, do not tighten them excessively. Doing so may cause the wheel bolts, the threads of the wheel hub, or the wheel to be damaged.

7 Stow the jack and all tools.

⚠ WARNING

- After using the tools and jack, before driving, make sure that the tools and jack are securely stored. Failure to do so may result in injury during a collision or sudden braking.
- After replacing a tire, check the tightening torque as soon as possible.

After replacing a tire, check the tightening torque as soon as possible. Also, after driving approximately 621 miles (1000 km), be sure to check that the wheel bolts are still tightened to the specified torque.

⚠ NOTICE

When removing or fitting the wheels, tires or the tire pressure warning valves and transmitters, contact your Lexus dealer as the tire pressure warning valves and transmitters may be damaged if not handled correctly.

— Related Links —

[Checking tire inflation pressure\(P. 616\)](#)

[Setting the tire pressure\(P. 609\)](#)

[Registration of the position of each wheel after performing a tire rotation\(P. 608\)](#)

Headlight aim

Vertical movement adjusting bolts

► Type A

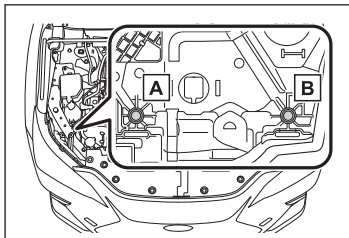

A Adjustment bolt A

B Adjustment bolt B

► Type B

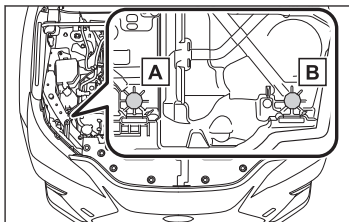

A Adjustment bolt A

B Adjustment bolt B

Checking the headlight aim

Before checking the headlight aim, confirm the following.

- The vehicle has a full tank of gasoline and the area around the headlight is not deformed.
- The vehicle is parked on level ground.
- The tire inflation pressure is at the specified level.
- Someone is sitting in the driver's seat.
- The vehicle has been bounced several times after being parked.

Adjusting the headlight aim

- 1 Using a Phillips-head screwdriver, turn bolt A in either direction. Remember the turning direction and the number of turns.

► Type A

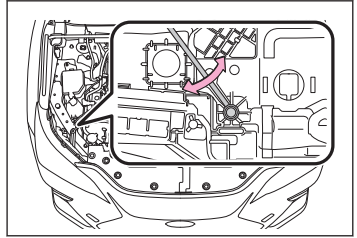

► Type B

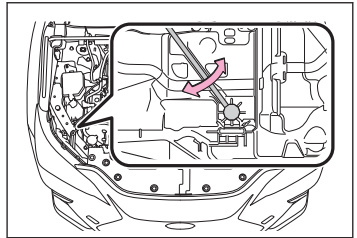

- 2 Turn bolt B the same number of turns and in the same direction as step 1.

If the headlight cannot be adjusted using this procedure, take the vehicle to your Lexus dealer to adjust the headlight aim.

► Type A

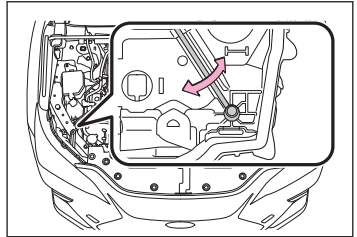

► Type B

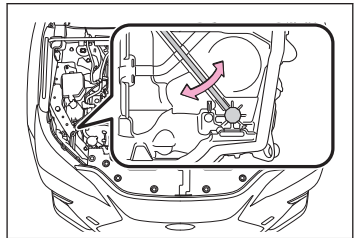

9-1. What to do if a problem occurs while driving

What to do if a problem occurs while driving.....**635**

9-2. If a warning light illuminates/flashes or a warning message is displayed on the meter

If a warning light turns on/flashes.....**638**

If a warning message is displayed.....**651**

9-3. If the hybrid system will not start

When the hybrid system cannot be started even though the correct starting procedure is being followed**672**

When the interior lights or headlights are dim and the hybrid system cannot be started**675**

When the interior lights or headlights do not illuminate and the hybrid system cannot be started**682**

When the horn sounds at a low volume and the hybrid system cannot be started .**683**

When the horn does not sound and the hybrid system cannot be started**684**

9-4. If a tire is flat

Precautions for when you have a flat tire**685**

9-5. If a door cannot be opened or locked

If a key has been lost.....**686**

When the doors/windows/moon roof cannot be operated using an electronic key.....**687**

If a door cannot be opened using the door opener switch.....**696**

If the rear doors cannot be opened from the inside**699**

If the back door cannot be opened.....**700**

9-6. If the moon roof or electronic sunshade does not operate correctly

If the moon roof does not operate correctly.....**701**

9-7. If refueling cannot be performed

If the fuel filler door cannot be opened**702**

9-8. If the plug-in hybrid system cannot be used normally

If the hybrid battery (traction battery) of the plug-in hybrid system cannot be charged**703**

If the charging connector cannot be disconnected

from the AC charging inlet	707	The steering wheel cannot be turned after the hybrid system is stopped	726
When a malfunction occurs during charging.....	709	If the windows do not open or close by operating the power window switches.....	727
If the charging schedule function does not operate normally.....	711	The power switch is turned off automatically.....	729
9-9. If an indicator on an interior fea- ture illuminates or flashes		If your vehicle overheats.....	730
When the wireless charger operation indicator light (on the charging tray) flashes.....	713	If electrical components cannot be used or do not operate when a switch is operated.....	733
9-10. If the vehicle cannot move		If a light does not illuminate.	734
When a hybrid system warning message is dis- played and the vehicle does not move	714		
If the hybrid transmission makes abnormal sounds.....	715		
Towing with a tow truck.....	716		
Using a flatbed truck.....	718		
Towing with another vehicle	719		
Getting unstuck from mud, sand, or snow.....	722		
9-11. If you think something is wrong			
If a vehicle abnormality is found.....	723		
If abnormal sounds are emitted from the vehicle....	724		
If the vehicle behaves ab- normally.....	725		
9-12. Items to check before contact- ing a dealership			

What to do if a problem occurs while driving

Using the emergency flashers to warn other drivers

Use the emergency flashers to inform other drivers of the presence of your vehicle when it is stopped on the road, such as if the vehicle has broke down.

Press the switch.

All the turn signal lights will flash. To turn them off, press the switch once again.

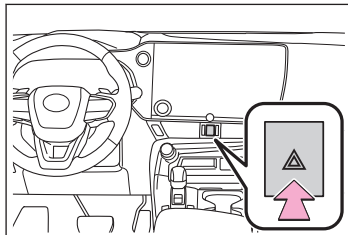

INFORMATION

■ Emergency flashers

- If the emergency flashers are used for a long time with the hybrid system stopped (while the "READY" indicator is not illuminated), the 12-volt battery may become discharged.
- If any of the SRS airbags deploy (inflate) or in the event of a strong rear impact, the emergency flashers will turn on automatically.

The emergency flashers will turn off automatically after operating for approximately 20 minutes. To manually turn the emergency flashers off, press the switch twice. (The emergency flashers may not turn on automatically depending on the force of the impact and conditions of the collision.)

Stopping the vehicle in an emergency

Stop the vehicle using the following procedure only in an emergency, such as if it becomes impossible to stop the vehicle in the normal way:

WARNING

■ If the hybrid system has to be stopped while driving

Power assist for the steering wheel will be lost, making the steering wheel heavier to turn. Decelerate as much as possible before stopping the hybrid system.

1 Steadily step on the brake pedal with both feet and firmly depress it.

Do not pump the brake pedal repeatedly as this will increase the effort required to slow the vehicle.

9.1. What to do if a problem occurs while driving

2 Change the shift position to N.

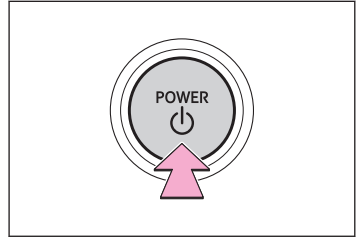

- If the shift position is changed to N:

After slowing down, stop the vehicle in a safe place by the road.

Stop the hybrid system.

- If the shift position cannot be changed to N:

Keep depressing the brake pedal with both feet to reduce vehicle speed as much as possible.

To stop the hybrid system, press and hold the power switch for 2 consecutive seconds or more, or press it briefly 3 times or more in succession.

3 Stop the vehicle in a safe place by the road.

▲ WARNING

To restart the hybrid system after performing an emergency shutdown, change the shift position to N and then press the power switch.

If the vehicle is submerged or water on the road is rising

This vehicle is not designed to be able to drive on roads that are deeply flooded with water. Do not drive on roads where the roads may be submerged or the water may be rising. It is dangerous to remain in the vehicle, if it anticipated that the vehicle will be flooded or set a drift.

Remain calm and follow the following.

- If the door can be opened, open the door and exit the vehicle.
- If the door cannot be opened, open the window using the power window switch and ensure an escape route.
- If the window can be opened, exit the vehicle through the window.
- If the door and window cannot be opened due to the rising water, remain calm, wait until the water level inside the vehicle rises to the point that the water pressure inside of the vehicle equals the water pressure outside of the vehicle and then open the door after waiting for the rising water to enter the vehicle, and exit the vehicle.

When the outside water level exceeds half the height of the door, the door cannot be opened from the inside due to water pressure.

INFORMATION

Water level exceeds the floor

When the water level exceeds the floor and time has passed, the electrical equipment will get damaged, the power windows will not operate, the engine and motor stop, and the vehicle may not be able to get moving.

Using an emergency escape hammer*1

Laminated glass* is used in the windshield and the windows on this vehicle. Laminated glass cannot be shattered with an emergency hammer*1.

How to distinguish laminated glass

When looking from the cross-sectional view point, laminated glass is two sheets of glass pasted together.

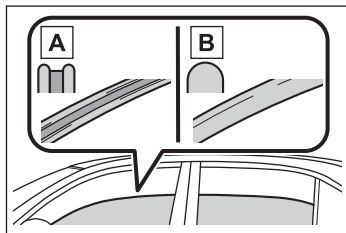

A Laminated glass

B Tempered glass

WARNING

Caution while driving

Do not drive on roads where the roads may be submerged or the water may be rising. Otherwise the vehicle may be damaged and cannot move, as well as become flooded and set a drift, which may lead to death.

Operation of emergency shut off system

When a certain level of impact is detected by an impact sensor, the emergency shut off system blocks the high voltage current and stops the fuel pump to minimize the risk of electrocution and fuel leakage. If the emergency shut off system activates, your vehicle will not be able to be restarted. To restart the hybrid system, contact your Lexus dealer.

*: If equipped

*1: Contact your Lexus dealer or aftermarket accessory manufacturer for further information about an emergency hammer.

If a warning light turns on/flashes



Calmly perform the following actions if any of the warning lights comes on or flashes. If a light comes on or flashes, but then goes off, this does not necessarily indicate a malfunction in the system. However, if this continues to occur, have the vehicle inspected by your Lexus dealer.

INFORMATION

■ Warning buzzer

In some cases, the buzzer may not be heard due to being in a noisy location or audio sound.

Brake system warning light (warning buzzer)



Condition	Cause / Remedy
 <p>BRAKE (U.S.A.) or  (red) (Canada)</p>	<p>Indicates that:</p> <ul style="list-style-type: none"> ● The brake fluid level is low; or ● The brake system is malfunctioning <p>Immediately stop the vehicle and contact your Lexus dealer. Continuing to drive the vehicle may be dangerous.</p>

WARNING

If both the ABS and the brake system warning lights remain on, stop your vehicle in a safe place immediately and contact your Lexus dealer.

The vehicle will become extremely unstable during braking, and the ABS system may fail, which could cause an accident resulting in death or serious injury.

Brake system warning light (warning buzzer)

Condition	Cause / Remedy
 <p> (yellow)</p>	<p>Indicates a malfunction in:</p> <ul style="list-style-type: none"> ● The regenerative braking system; ● The electronically controlled brake system; or ● The electric parking brake <p>Have the vehicle checked by your Lexus dealer immediately.</p>

9-2. If a warning light illuminates/flashes or a warning message is displayed on the meter

▲ WARNING

If both the ABS and the brake system warning lights remain on, stop your vehicle in a safe place immediately and contact your Lexus dealer.

The vehicle will become extremely unstable during braking, and the ABS system may fail, which could cause an accident resulting in death or serious injury.

High coolant temperature warning light (warning buzzer)

Condition	Cause / Remedy
 <p>This light illuminates on the multi-information display.</p>	<p>Indicates that the engine coolant temperature is too high</p> <p>Immediately stop the vehicle in a safe take the corrective actions for overheating.</p>

Related Links

[If your vehicle overheats\(P. 730\)](#)

Hybrid system overheat warning light (warning buzzer)

Condition	Cause / Remedy
 <p>This light illuminates on the multi-information display.</p>	<p>Indicates the hybrid system has overheated</p> <p>Stop the vehicle in a safe place and perform the necessary actions.</p>

Related Links

[If your vehicle overheats\(P. 730\)](#)



Charging system warning light (warning buzzer)

Condition	Cause / Remedy
 <p>This light illuminates on the multi-information display.</p>	<p>Indicates a malfunction in the vehicle's charging system</p> <p>Immediately stop the vehicle in a safe place and contact your Lexus dealer.</p>

Low engine oil pressure warning light (warning buzzer)

Condition	Cause / Remedy
 <p>This light illuminates on the multi-information display.</p>	<p>Indicates that the engine oil pressure is too low Immediately stop the vehicle in a safe place and contact your Lexus dealer.</p>

Malfunction indicator lamp

Condition	Cause / Remedy
 (U.S.A.) or  (Canada)	<p>Indicates a malfunction in:</p> <ul style="list-style-type: none"> ● The hybrid system; ● The electronic engine control system; ● The electronic throttle control system; or ● The electronic transmission control system <p>Immediately stop the vehicle in a safe place and contact your Lexus dealer.</p>

INFORMATION

■ If the malfunction indicator lamp comes on while driving

First check the following:

- Is the fuel tank empty?
If it is, fill the fuel tank immediately.
- Is the fuel tank cap loose?
If it is, tighten it securely.

The light will go off after several driving trips.

If the light does not go off even after several trips, contact your Lexus dealer as soon as possible.

SRS warning light

Warning light	Details / Actions
	<ul style="list-style-type: none"> ● The SRS airbag system is malfunctioning ● The seat belt pretensioner system is malfunctioning <p>Have the vehicle checked by your Lexus dealer immediately.</p>

SRS warning light



This warning light indicates problems with the following:

- Airbag sensor assembly
- Front impact sensors
- Side impact sensors (front door)
- Side impact sensors (front)
- Front passenger occupant classification sensors
- Driver's seat position sensor
- Driver's seat belt buckle switch
- Front passenger's seat belt buckle switch
- "AIR BAG ON" indicator light
- "AIR BAG OFF" indicator light
- Seat belt pretensioners
- Air bags
- Interconnecting wiring and power sources.

Related Links

[SRS airbags\(P. 537\)](#)

ABS warning light (warning buzzer)

Condition	Cause / Remedy
 (U.S.A.) or  (Canada)	<p>Indicates a malfunction in:</p> <ul style="list-style-type: none"> ● The ABS; or ● The brake assist system <p>Have the vehicle checked by your Lexus dealer immediately.</p>

⚠ WARNING

If both the ABS and the brake system warning lights remain on, stop your vehicle in a safe place immediately and contact your Lexus dealer.

The vehicle will become extremely unstable during braking, and the ABS system may fail, which could cause an accident resulting in death or serious injury.

Inappropriate pedal operation warning light (warning buzzer)

Condition	Cause / Remedy
 <p>This light illuminates on the multi-information display.</p>	<p>When a buzzer sounds: Indicates a malfunction in:</p> <ul style="list-style-type: none"> ● The Brake Override System ● The Drive-Start Control <p>Have the vehicle checked by your Lexus dealer immediately.</p>
	<p>When a buzzer sounds: Indicates that the shift position was changed and Drive-Start Control was operated while depressing the accelerator pedal.</p> <p>Momentarily release the accelerator pedal.</p>
	<p>When a buzzer sounds: PKSB (Parking Support Brake)* has operated</p> <p>Follow the instructions displayed on the multi-information display.</p>
	<p>When a buzzer does not sound: Indicates that the accelerator and brake pedals are being depressed simultaneously, and the Brake Override System is operating.</p> <p>Release the accelerator pedal and depress the brake pedal.</p>

*: If equipped

Electric power steering system warning light (warning buzzer)

Condition	Cause / Remedy
 (red/yellow)	Indicates a malfunction in the EPS (Electric Power Steering) system Have the vehicle checked by your Lexus dealer immediately.

INFORMATION

■ Electric power steering system warning light (warning buzzer)

When the 12-volt battery charge becomes insufficient or the voltage temporarily drops, the electric power steering system warning light may come on and the warning buzzer may sound.

WARNING

When the electric power steering system warning light comes on yellow, the assist to the power steering is restricted. When the light comes on red, the assist to the power steering is lost and handling operations of the steering wheel become extremely heavy.

When steering wheel operations are heavier than usual, grip the steering wheel firmly and operate it using more force than usual.

Low fuel level warning light

Condition	Cause / Remedy
	Indicates that remaining fuel is approximately 2.3 gal. (8.5 L, 1.9 Imp. gal.) or less Refuel the vehicle.

Driver's and front passenger's seat belt reminder light (warning buzzer)

Condition	Cause / Remedy
	Warns the driver and/or front passenger to fasten their seat belts Fasten the seat belt. If the front passenger's seat is occupied, the front passenger's seat belt also needs to be fastened to make the warning light (warning buzzer) turn off.

9-2. If a warning light illuminates/flashes or a warning message is displayed on the meter

INFORMATION

■ Driver's and front passenger's seat belt warning buzzer

● Driver's seat belt warning buzzer:

The driver's seat belt warning buzzer sounds to alert the driver that his or her seat belt is not fastened. Once the power switch is turned to ON, the buzzer sounds. If the seat belt is still unfastened, the buzzer sounds intermittently for a certain period of time after the vehicle reaches a certain speed.

● Front passenger's seat belt warning buzzer:



The front passenger's seat belt warning buzzer sounds to alert the front passenger that his or her seat belt is not fastened. If the seat belt is unfastened, the buzzer sounds intermittently for a certain period of time after the vehicle reaches a certain speed.

■ Front passenger detection sensor, seat belt reminder and warning buzzer

● If luggage is placed on the front passenger seat, the front passenger detection sensor may cause the warning light to flash and the warning buzzer to sound even if a passenger is not sitting in the seat.

● If a cushion is placed on the seat, the sensor may not detect a passenger, and the warning light may not operate properly.

Rear passengers' seat belt reminder light (warning buzzer)

Condition	Cause / Remedy
 (Vehicles without a head-up display)	Warns the rear passengers to fasten their seat belts Fasten the seat belt.
 (Vehicles with a head-up display)	

INFORMATION

■ Rear passengers' seat belt warning buzzer

The rear passengers' seat belt warning buzzer sounds to alert the rear passenger that his or her seat belt is not fastened. If the seat belt is unfastened, the buzzer sounds intermittently for a certain period of time, after the seat belt is fastened and unfastened and the vehicle reaches a certain speed.

Tire pressure warning light (warning buzzer)

Condition	Cause / Remedy
	When the light comes on after blinking for approximately 1 minute (a buzzer does not sound): Malfunction in the tire pressure warning system Have the system checked by your Lexus dealer.
	When the light comes on (a buzzer sounds): Low tire inflation pressure from natural causes After the temperature of the tires has lowered sufficiently, check the inflation pressure of each tire and adjust them to the specified level.
	When the light comes on (a buzzer sounds): Low tire inflation pressure from flat tire Immediately stop the vehicle in a safe place and perform the necessary actions

INFORMATION**■ If the tire pressure warning light comes on**

Inspect the tires to check if a tire is punctured.

- If a tire is punctured: → P.685
- If none of the tires are punctured: Turn the power switch off then turn it to ON. Check if the tire pressure warning light comes on or blinks.

- If the tire pressure warning light blinks for approximately 1 minute then stays on
There may be a malfunction in the tire pressure warning system. Have the vehicle inspected by your Lexus dealer immediately.

- If the tire pressure warning light comes on
After the temperature of the tires has lowered sufficiently, check the inflation pressure of each tire and adjust them to the specified level.

If the warning light does not turn off even after several minutes have elapsed, check that the inflation pressure of each tire is at the specified level and perform the tire inflation pressure setting procedure.

If the warning light does not turn off even after several minutes have elapsed since performing the tire inflation pressure setting procedure, have the vehicle inspected by your Lexus dealer immediately.

■ The tire pressure warning light may come on due to natural causes

The tire pressure warning light may come on due to natural causes such as natural air leaks and tire inflation pressure changes caused by temperature. In this case, adjusting the tire inflation pressure will turn off the warning light (after a few minutes).

▲ WARNING

■ If the tire pressure warning light comes on

Be sure to observe the following precautions. Failure to do so could cause a loss of vehicle control and result in death or serious injury.

- Decelerate to the lowest appropriate speed as soon as possible. Do not drive over 50 mph (80 km/h).
- Stop your vehicle in a safe place as soon as possible. Adjust the tire inflation pressure immediately.
- If the tire pressure warning light comes on even after tire inflation pressure adjustment, it is probable that you have a flat tire. Have the flat tire replaced by the nearest Lexus dealer.
- Avoid abrupt maneuvering and braking. If the vehicle tires deteriorate, you could lose control of the steering wheel or the brakes.

■ If a blowout or sudden air leakage should occur

The tire pressure warning system may not activate immediately.

■ Maintenance of the tires

Each tire, including the spare (if provided), should be checked monthly when cold and inflated to the inflation pressure recommended by the vehicle manufacturer on the vehicle placard or tire inflation pressure label (tire and load information label). (If your vehicle has tires of a different size than the size indicated on the vehicle placard or tire inflation pressure label [tire and load information label], you should determine the proper tire inflation pressure for those tires.)

As an added safety feature, your vehicle has been equipped with a tire pressure monitoring system (TPMS-tire pressure warning system) that illuminates a low tire pressure telltale (tire pressure warning light) when one or more of your tires is significantly under-inflated. Accordingly, when the low tire pressure telltale (tire pressure warning light) illuminates, you should stop and check your tires as soon as possible, and inflate them to the proper pressure. Driving on a significantly under-inflated tire causes the tire to overheat and can lead to tire failure. Under-inflation also reduces fuel efficiency and tire tread life, and may affect the vehicle's handling and stopping ability.

Please note that the TPMS (tire pressure warning system) is not a substitute for proper tire maintenance, and it is the driver's responsibility to maintain correct tire pressure, even if under-inflation has not reached the level to trigger illumination of the TPMS low tire pressure telltale (tire pressure warning light).

9-2. If a warning light illuminates/flashes or a warning message is displayed on the meter

WARNING

Your vehicle has also been equipped with a TPMS (tire pressure warning system) malfunction indicator to indicate when the system is not operating properly. The TPMS (tire pressure warning system) malfunction indicator is combined with the low tire pressure telltale (tire pressure warning light). When the system detects a malfunction, the telltale will flash for approximately one minute and then remain continuously illuminated. This sequence will continue upon subsequent vehicle start-ups as long as the malfunction exists. When the malfunction indicator is illuminated, the system may not be able to detect or signal low tire pressure as intended.

TPMS (tire pressure warning system) malfunctions may occur for a variety of reasons, including the installation of replacement or alternate tires or wheels on the vehicle that prevent the TPMS (tire pressure warning system) from functioning properly. Always check the TPMS (tire pressure warning system) malfunction telltale after replacing one or more tires or wheels on your vehicle to ensure that the replacement or alternate tires and wheels allow the TPMS (tire pressure warning system) to continue to function properly.

NOTICE

To ensure the tire pressure warning system operates properly

Do not install tires with different specifications or makers, as the tire pressure warning system may not operate properly.

Intuitive parking assist OFF indicator (warning buzzer)

Condition	Cause / Remedy
	Indicates a malfunction in the intuitive parking assist function Have the vehicle checked by your Lexus dealer immediately.
	Indicates that the system is temporarily unavailable, possibly due to a sensor being dirty or covered with ice, etc. Follow the instructions displayed on the multi-information display.

PCS warning light (warning buzzer)

Condition	Cause / Remedy
	Indicates a malfunction in the PCS (Pre-Collision System). Follow the instructions displayed on the display. ● Illuminates when the PCS (Pre-Collision System) or VSC (Vehicle Stability Control) system is disabled.

LTA indicator (warning buzzer)

Condition	Cause / Remedy
 (Orange)	Indicates a malfunction in the LTA (Lane Tracing Assist). ● Follow the instructions displayed on the display.

LDA indicator (warning buzzer)

Condition	Cause / Remedy
 (Orange)	Indicates a malfunction in the LDA (Lane Departure Alert). ● Follow the instructions displayed on the display.

Dynamic radar cruise control indicator (warning buzzer)

Condition	Cause / Remedy
 (Orange)	Indicates a malfunction in the dynamic radar cruise control system. ● Follow the instructions displayed on the display.

Cruise control indicator (warning buzzer)

Condition	Cause / Remedy
 (Orange)	Indicates a malfunction in the cruise control system. ● Follow the instructions displayed on the display.

Driving assist information indicator



Condition	Cause / Remedy
	<p>Indicates one of the following systems is malfunctioning.</p> <ul style="list-style-type: none"> ● PCS (Pre-Collision System) ● LDA (Lane Departure Alert) <p>Indicates one of the following systems is malfunctioning or disabled.</p> <ul style="list-style-type: none"> ● PKSB (Parking Support Brake)* ● RCD (Rear Camera Detection)* ● BSM (Blind Spot Monitor) ● RCTA(Rear cross traffic alert) ● Safe Exit Assist (with door opening control) ● Follow the instructions displayed on the display.

Slip indicator

Condition	Cause / Remedy
 <p>(illuminates)</p>	<p>Indicates a malfunction in:</p> <ul style="list-style-type: none"> ● The VSC system; ● The Trailer Sway Control system; ● The TRAC system; ● The Trail Mode function; or ● The hill-start assist control system <p>Have the vehicle checked by your Lexus dealer immediately.</p>

*: If equipped

Parking brake indicator

Condition	Cause / Remedy
 (U.S.A.) (flashes) or  (Canada) (flashes)	It is possible that the parking brake is not fully engaged or released Operate the parking brake switch once again. This light comes on when the parking brake is not released. If the light turns off after the parking brake is fully released, the system is operating normally.
	Indicates a malfunction in the parking brake system Have the vehicle checked by your Lexus dealer immediately.

Brake hold operated indicator (warning buzzer)

Condition	Cause / Remedy
 (flashes)	Indicates a malfunction in the brake hold system Have the vehicle checked by your Lexus dealer immediately.

If a warning message is displayed

The multi-information display shows warnings for system malfunctions and incorrectly performed operations, and messages that indicate a need for maintenance. When a message is displayed, perform the appropriate corrective action for the message.

If a warning message is displayed again after the appropriate actions have been performed, contact your Lexus dealer.

Additionally, if a warning light comes on or flashes at the same time that a warning message is displayed, take the appropriate corrective action for the warning light.

INFORMATION

■ Warning messages

The warning messages explained below may differ from the actual messages according to operation conditions and vehicle specifications.

■ Warning buzzer

In some cases, the buzzer may not be heard due to being in a noisy location or audio sound.

"Engine Oil Level Low Add or Replace"

Cause	Remedy
The engine oil level may be low.	Check the level of the engine oil, and add engine oil if necessary. This message may be displayed if the vehicle is stopped on a slope. Move the vehicle to a level surface and check if the message disappears.

— Related Links —

[Checking and adding the engine oil\(P. 587\)](#)

"Hybrid System Stopped Steering Power Low"

Cause	Remedy
This message is displayed if the hybrid system is stopped while driving.	When steering wheel operations are heavier than usual, grip the steering wheel firmly and operate it using more force than usual.

"Auto Power OFF to Conserve Battery"

Cause	Remedy
Power was turned off due to the automatic power off function.	Next time when starting the hybrid system, operate the hybrid system for approximately 5 minutes to recharge the 12-volt battery.

— Related Links —

[Changing the power switch mode\(P.184\)](#)

"Shift is in N Release Accelerator Before Shifting"

Cause	Remedy
The accelerator pedal has been depressed when the shift position is in N.	Release the accelerator pedal and change the shift position to D or R.

"Press brake when vehicle is stopped Hybrid system may overheat"

Cause	Remedy
The message may be displayed when the accelerator pedal is depressed to hold the vehicle while the vehicle is stopped on an incline, etc.	The hybrid system may overheat. Release the accelerator pedal and depress the brake pedal.

"12-Volt Battery Charging System Malfunction Stop in a Safe Place See Owner's Manual"

Cause	Remedy
It may indicate a malfunction.	Immediately stop the vehicle and contact your Lexus dealer. Continuing to drive the vehicle may be dangerous.

"Traction battery needs to be protected. Shift into P to restart."

Cause	Remedy
This message is displayed when the hybrid battery (traction battery) charge has become extremely low because the vehicle has been left with the N shift position selected for a certain amount of time.	When operating the vehicle, shift to P and restart the hybrid system.

"Traction battery needs to be protected. Refrain from the use of N position."

Cause	Remedy
This message may be displayed when the shift position is in N.	As the hybrid battery (traction battery) cannot be charged when the shift position is in N, shift the shift position to P when the vehicle is stopped.

"Hybrid System Overheated Output Power Reduced"

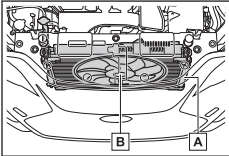
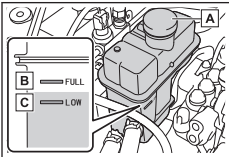
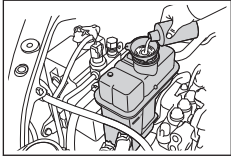
Cause	Remedy
<p>This message may be displayed when driving under severe operating conditions. (For example, when driving up a long steep hill.)</p>	<ol style="list-style-type: none"> 1 Stop the vehicle in a safe place. 2 Stop the hybrid system and carefully lift the hood. 3 After the hybrid system has cooled down, inspect the hoses and radiator core (radiator) for any leaks. If a large amount of coolant has leaked, immediately contact your Lexus dealer. <div style="display: flex; align-items: center;">  <div style="margin-left: 20px;"> <p>A Radiator</p> <p>B Cooling fan</p> </div> </div> <ol style="list-style-type: none"> 4 Check that the coolant level is between the [FULL] and [LOW] lines on the reservoir. <div style="display: flex; align-items: center;">  <div style="margin-left: 20px;"> <p>A Reservoir</p> <p>B [FULL] line</p> <p>C [LOW] line</p> </div> </div> <ol style="list-style-type: none"> 5 Add coolant if necessary. Water can be used in an emergency if coolant is unavailable. <div style="text-align: right;">  </div> <ol style="list-style-type: none"> 6 After stopping the hybrid system and waiting for 5 minutes or more, start the hybrid system again and check for the multi-information display.

9 When trouble arises

9-2. If a warning light illuminates/flashes or a warning message is displayed on the meter

Cause	Remedy
This message may be displayed when driving under severe operating conditions. (For example, when driving up a long steep hill.)	If the message does not disappear: Stop the hybrid system and contact your Lexus dealer. If the message is not displayed: The hybrid system temperature has dropped and the vehicle may be driven normally. However, if the message appears again frequently, contact your Lexus dealer.

WARNING

When opening the hood, observe the following precautions.

- If steam is seen coming from under the hood, do not open the hood until the steam has subsided. The engine compartment may be very hot.

- After turning the hybrid system off, check that the "READY" indicator is off.

When the hybrid system is operating, the gasoline engine may automatically start, or the cooling fan may suddenly operate even if the gasoline engine is stopped.

Also, it may operate for several minutes even after the power switch is turned off.

Do not touch or approach rotating parts such as the fan, which may lead to fingers or clothing (especially a tie, a scarf or a muffler) getting caught, resulting in serious injury.

- Do not loosen the coolant reservoir cap while the hybrid system and radiator are hot. High temperature steam or coolant could spray out.

NOTICE

When adding engine/power control unit coolant

Add coolant slowly after the hybrid system has cooled down sufficiently.

Adding cool coolant to a hot hybrid system too quickly can cause damage to the hybrid system.

To prevent damage to the cooling system

Observe the following precautions:

- Avoid contaminating the coolant with foreign matter (such as sand, dust, etc.).
- Do not use coolant additives.

"Tire Set Switching Incomplete Try Tire Set Registration Again See Owner's Manual"

Cause	Remedy
The wheel set change could not be completed.	Check which wheel set is installed and perform the change procedure again from the beginning.

— Related Links —

[Selecting wheel set\(P. 614\)](#)

"Maintenance Required For Traction Battery At Your Dealer"

Remedy
<p>The hybrid battery (traction battery) is scheduled to be inspected or replaced. Have the vehicle inspected by your Lexus dealer immediately.</p> <ul style="list-style-type: none"> ● Continuing to drive the vehicle without having the hybrid battery (traction battery) inspected will cause the hybrid system not to start. ● If the hybrid system does not start, contact your Lexus dealer immediately.

"Headlight System Malfunction Visit Your Dealer"

Cause	Remedy
The system may be malfunctioning.	Have the vehicle checked by your Lexus dealer.

"AWD System Overheated Switching to 2WD Mode"

Cause	Remedy
AWD system is overheated.	<ul style="list-style-type: none"> ● Stop the vehicle in a safe place with the hybrid system operating.*1 <p>If the message disappears after a while, there is no problem. If the message remains, have the vehicle inspected by your Lexus dealer immediately.</p>

*1: When stopping the vehicle, do not stop the hybrid system until the display message has turned off.

"AWD System Overheated 2WD Mode Engaged"

Cause	Remedy
AWD system has been temporarily released and switched to front-wheel drive due to overheating.	<ul style="list-style-type: none"> ● Stop the vehicle in a safe place with the hybrid system operating.*2 <p>If the message disappears after a while, AWD system will automatically recover. If the message remains, have the vehicle inspected by your Lexus dealer immediately.</p>

"AWD System Malfunction 2WD Mode Engaged Visit Your Dealer"

Cause	Remedy
A malfunction occurs in the AWD system.	<ul style="list-style-type: none"> ● Have the vehicle inspected by your Lexus dealer immediately.

"Engine Coolant Temp High Stop in a Safe Place See Owner's Manual"

Remedy
Take the corrective actions for overheating.

Related Links

[If your vehicle overheats\(P. 730\)](#)

"Access System with Elec.Key malfunction See owner's manual"

Cause	Remedy
It may indicate a malfunction.	Have the vehicle checked by your Lexus dealer immediately.

"Braking Power Low Stop in a Safe Place See Owner's Manual"

Cause	Remedy
It may indicate a malfunction.	Immediately stop the vehicle and contact your Lexus dealer. Continuing to drive the vehicle may be dangerous.

*2: When stopping the vehicle, do not stop the hybrid system until the display message has turned off.

"Oil pressure low Stop in a safe place See owner's manual"

Cause	Remedy
It may indicate a malfunction.	Immediately stop the vehicle and contact your Lexus dealer. Continuing to drive the vehicle may be dangerous.

"High Power Consumption Power to Climate Temporarily Limited"

Cause	Remedy
If this message is displayed frequently, there is a possible malfunction relating to the charging system or the 12-volt battery may be deteriorating.	Have the vehicle checked by your Lexus dealer immediately.

A message that indicates the need for visiting your Lexus dealer

Cause	Remedy
The system or part shown on the multi-information display is malfunctioning.	Have the vehicle inspected by your Lexus dealer immediately.

"A New Key has been Registered Contact Your Dealer for Details"

Cause	Remedy
This message will be displayed each time the driver's door is opened when the doors are unlocked from the outside for approximately 10 days after a new electronic key has been registered.	If this message is displayed but you have not had a new electronic key registered, ask your Lexus dealer to check if an unknown electronic key (other than those in your possession) has been registered.

"Parking Brake Temporarily Unavailable"

Cause	Remedy
If the parking brake is operated repeatedly over a short period of time, the system may restrict operation to prevent overheating.	If this happens, refrain from operating the parking brake. Normal operation will return after about 1 minute.

"EPB Activation Stopped Incompletely"

Cause	Remedy
Operate the parking brake switch. If the message does not disappear after operating the switch several times, the system may be malfunctioning.	Have the vehicle checked by your Lexus dealer.

"Parking Brake Unavailable"

Cause	Remedy
Operate the parking brake switch. If the message does not disappear after operating the switch several times, the system may be malfunctioning.	Have the vehicle checked by your Lexus dealer.

"Brake Hold Malfunction Press Brake to Deactivate Visit Your Dealer"

Cause	Remedy
The system may be malfunctioning.	Have the vehicle checked by your Lexus dealer immediately.

"Maintenance required for DCDC converter cooling parts See Owner's Manual"

Cause	Remedy
The air intake vent or filter of the DC/DC converter may be clogged, the air intake vent may be blocked, or there may be a gap in the duct. Therefore, perform the following correction procedure.	<ul style="list-style-type: none"> ● If the air intake vent or filter of the DC/DC converter are dirty, clean them. ● If the warning message is shown when the air intake vent and filter the DC/DC converter are not dirty, have the vehicle inspected at your Lexus dealer.

Related Links

[Cleaning DC/DC converter air intake vent\(P.571\)](#)

9-2. If a warning light illuminates/flashes or a warning message is displayed on the meter

"EV Mode Unavailable"

Cause	Remedy
<p>The EV drive mode is not available.</p> <p>The reason the EV drive mode is not available (the vehicle is idling, battery charge is low, vehicle speed is higher than the EV drive mode operating speed range or accelerator pedal is depressed too much) may be displayed.</p>	<p>Use the EV drive mode when it becomes available.</p>

"EV Mode Deactivated"

Cause	Remedy
<p>The EV drive mode is not available.</p> <p>The reason the EV drive mode is not available (the battery charge is low, vehicle speed is higher than the EV drive mode operating speed range or accelerator pedal is depressed too much) may be displayed.</p>	<p>Drive the vehicle for a while before attempting to turn on the EV drive mode again.</p>

"Charging Stopped Due to Pulled Charging Connector"

Cause	Remedy
<ul style="list-style-type: none"> ● Charging connector is removed while charging ● After the hybrid battery (traction battery) is fully charged, the charging connector is removed while the hybrid battery (traction battery) is being recharged again because electricity-consuming functions^{*3} have been used and the remaining charge is now reduced. 	<p>If the charging connector is disconnected during charging, charging will be suspended. To continue charging, reconnect the charging connector.</p>

*3: Electricity is consumed when operating traction battery heater. Using My Room Mode also consumes power.

9-2. If a warning light illuminates/flashes or a warning message is displayed on the meter

Cause	Remedy
Charging connector is not securely connected	<p>Check the connection status of the charging connector.</p> <ul style="list-style-type: none"> ● When connecting the charging connector, make sure not to touch the latch release button. Insert the charging connector securely until you hear a click. The charging connector may not be connected correctly if the latch release button is pressed while inserting. ● After connecting the charging connector, check that the latch release button is not pressed and the charging indicator of the charging port is turned on. <p>If charging cannot be carried out, even though the proper procedures were followed, have the vehicle inspected by your Lexus dealer.</p>
Latch release button of charging connector was pressed while charging	When the latch release button is pressed while charging, charging stops. To continue charging, reconnect the charging connector.

"Charging Complete Limited Charge Due to Battery Temp"

Cause	Remedy
Charging was stopped to protect the hybrid battery (traction battery) as it continued to remain hot for a certain period of time.	Allow the hybrid battery (traction battery) to cool down and perform charging again if the charging amount has not reached the desired amount.

"Charging Stopped Check Charging Source"

Cause	Remedy
<p>Problem in power supply from external power source</p>	<p>Check the following items.</p> <ul style="list-style-type: none"> ● Plug is not disconnected ● Plug is securely inserted ● Power source indicator on the CCID (Charging Circuit Interrupting Device) is illuminated ● The circuit breaker has tripped ● Extension cord is not used and outlet is not overloaded ● Connected to a dedicated power line ● Electrical leakage has occurred or not <p>If there is no problem with any of the above items, there may be a problem with the outlet of the building. Contact an electrician and request an inspection. (Contact the facility manager of the charging station when there is a problem with charging station.)</p> <p>If charging cannot be carried out, even though there is no problem with the power source path, there may be a malfunction in the system. Have the vehicle inspected by your Lexus dealer.</p> <p>Furthermore, if the error warning indicator on the CCID (Charging Circuit Interrupting Device) is flashing, there may be an electrical leakage. Consult your Lexus dealer.</p>
<p>Charger has stopped charging</p>	<ul style="list-style-type: none"> ● Charging may be canceled by an interruption of power supply depending on specifications of a charger. Refer to the instructions provided with the charger. <ul style="list-style-type: none"> • When charging is stopped using the charger • Equipment with charging schedule function • Equipment that is not compatible with the charging schedule function of the vehicle ● Check if it is possible to charge with the AC charging cable equipped to the vehicle. If charging cannot be carried out, even when using the genuine AC charging cable, consult your Lexus dealer.

9-2. If a warning light illuminates/flashes or a warning message is displayed on the meter

Cause	Remedy
Charger is not compatible with vehicle	<p>Check if it is possible to charge with the AC charging cable equipped to the vehicle.</p> <p>If charging cannot be carried out, even when using the genuine AC charging cable, consult your Lexus dealer.</p>

"Charging Stopped High Energy Use See Owner's Manual"

Cause	Remedy
Power is being consumed by electrical components of vehicle	<p>Check the following items, and then carry out charging again.</p> <ul style="list-style-type: none"> ● If the headlights and audio are turned on, turn them off. ● Turn the power switch off. <p>If charging cannot be carried out, even after performing the above, the 12-volt battery may not be sufficiently charged. Operate the hybrid system for approximately 15 minutes or more to charge the 12-volt battery.</p>

"Charging System Malfunction See Owner's Manual"

Cause / Remedy
<p>Malfunction occurred in charging system</p> <p>Have the vehicle checked by your Lexus dealer.</p>

"The Traction Battery Temp is low System put priority on charging to preserve battery condition" (Alaska and Canada only)

Cause	Remedy
The traction battery warming control was operated	<p>When the traction battery warming control operates, the charging schedule is not used and charging is performed.</p> <p>This is a control to protect the hybrid battery (traction battery), and not a malfunction.</p>

"Engine Started to Clean System EV Driving Unavailable"

Remedy
EV driving may be canceled in order to protect the hybrid system, etc. In this case, perform driving with the gasoline engine until EV driving will be returned to automatically.

"No New Fuel has been Added Recently Please refuel"

Cause	Remedy
Refueling has not been performed for a certain amount of time, and the quality of the fuel in the fuel tank may have decreased.	Refuel the vehicle immediately.

"Shift System Malfunction Shifting Unavailable Drive to a Safe Place and Stop"

Cause	Remedy
There is a malfunction in the shift control system.	Have the vehicle checked by your Lexus dealer immediately.

"Shift System Malfunction Driving Unavailable"

Cause	Remedy
There is a malfunction in the shift control system.	Have the vehicle checked by your Lexus dealer immediately.

If a message that indicates the need for the shift lever operation is displayed

Cause	Remedy
To prevent the shift lever from being operated incorrectly or the vehicle from moving unexpectedly, a message that requires shifting the shift position may be displayed on the multi-information display.	Follow the instruction of the message and shift the shift position.

"Shift System Malfunction Apply Parking Brake Securely When Parking See Owner's Manual"

Cause	Remedy
It may indicate a malfunction.	Have the vehicle checked by your Lexus dealer immediately.

"P Switch Malfunction Apply Parking Brake Securely When Parking See Owner's Manual"

Cause	Remedy
It may indicate a malfunction.	Have the vehicle checked by your Lexus dealer immediately.

"Shift System Unavailable Apply Parking Brake Securely When Parking See Owner's Manual"

Cause	Remedy
It may indicate a malfunction.	Have the vehicle checked by your Lexus dealer immediately.

"Shift System Malfunction See Owner's Manual"

Cause	Remedy
It may indicate a malfunction.	Have the vehicle checked by your Lexus dealer immediately.

"Shift System Malfunction Stop in a Safe Place See Owner's Manual"

Cause	Remedy
It may indicate a malfunction.	Have the vehicle checked by your Lexus dealer immediately.









"Battery Low Shifting Unavailable See Owner's Manual"

Cause	Remedy
It may indicate a malfunction.	Have the vehicle checked by your Lexus dealer immediately.

"Key Battery Low Replace Key Battery"









Cause	Remedy
The electronic key has a low battery.	Replace the electronic key battery.

"System Malfunction Visit Your Dealer"

Cause	Remedy
<p>Indicates one of the following systems is disabled.</p> <ul style="list-style-type: none"> ● PCS (Pre-Collision System) ● LDA (Lane Departure Alert) ● LTA (Lane Tracing Assist) ●  LCA (Lane Change Assist)* ● AHB (Automatic High Beam)* ● AHS (Adaptive High-beam System)* ● Dynamic radar cruise control system ●  RSA (Road Sign Assist) ●  BSM (Blind Spot Monitor) ●  RCTA (Rear Cross Traffic Alert) ●  Automatic Rear Flashing Hazard Lights ●  Safe Exit Assist (with door opening control) ● Intuitive parking assist* ●  PKSB (Parking Support Brake)* ●  RCD (Rear camera detection)* 	<ul style="list-style-type: none"> ● Have the vehicle inspected by your Lexus dealer immediately.



*: If equipped

"System Stopped See Owner's Manual"



Cause	Remedy
<p>Indicates one of the following systems is disabled.</p> <ul style="list-style-type: none"> ● PCS (Pre-Collision System) ● LDA (Lane Departure Alert) ● LTA (Lane Tracing Assist) ●  LCA (Lane Change Assist)* ● AHB (Automatic High Beam)* ● AHS (Adaptive High-beam System)* ● Dynamic radar cruise control system ●  RSA (Road Sign Assist) ●  BSM (Blind Spot Monitor) ●  RCTA (Rear Cross Traffic Alert) ●  Automatic Rear Flashing Hazard Lights ●  Safe Exit Assist (with door opening control) ● Intuitive parking assist* ●  PKSB (Parking Support Brake)* ●  RCD (Rear camera detection)* 	<ul style="list-style-type: none"> ● Check the sensors that the Lexus Safety System+ uses for foreign matter covering them. Remove them if any. → P.375
<p>Indicates the sensors may not be operating properly. → P.378</p>	<ul style="list-style-type: none"> ● When problems are solved and the sensors are operational, this indication may disappear by itself.

*: If equipped

"System Stopped Front Camera Low Visibility See Owner's Manual"

Cause	Remedy
<p>Indicates one of the following systems is disabled.</p> <ul style="list-style-type: none"> ● PCS (Pre-Collision System) ● LDA (Lane Departure Alert) ● LTA (Lane Tracing Assist) ●  LCA (Lane Change Assist)* ● AHB (Automatic High Beam)* ● AHS(Adaptive High-beam System)* ● Dynamic radar cruise control system ●  RSA (Road Sign Assist) 	<ul style="list-style-type: none"> ● Follow the following correction methods. <ul style="list-style-type: none"> ● Using the windshield wipers, remove the dirt or foreign matter from the windshield. ● Using the air conditioning system, defog the windshield. ● Close the hood, remove any stickers, etc. to clear the obstruction in front of the front camera.

"System Stopped Front Camera Out of Temperature Range Wait until Normal Temperature"

Cause	Remedy
<p>Indicates one of the following systems is disabled.</p> <ul style="list-style-type: none"> ● PCS (Pre-Collision System) ● LDA (Lane Departure Alert) ● LTA (Lane Tracing Assist) ●  LCA (Lane Change Assist)* ● AHB (Automatic High Beam)* ● AHS (Adaptive High-beam System)* ● Dynamic radar cruise control system ●  RSA (Road Sign Assist) 	<ul style="list-style-type: none"> ● Follow the following correction methods. <ul style="list-style-type: none"> ● If the front camera is hot, such as after the vehicle is parked in the sun, use the air conditioning system to decrease the temperature around the front camera ● If a sunshade was used when the vehicle was parked, depending on its type, the sunlight reflected from the surface of the sunshade may cause the temperature of the front camera to become excessively high ● If the front camera is cold, such after the vehicle is parked in an extremely cold environment, use the air conditioning system to increase the temperature around the front camera

*: If equipped

"System Stopped Front Radar Sensor Blocked Clean Radar Sensor"

Cause	Remedy
<p>Indicates one of the following systems is disabled.</p> <ul style="list-style-type: none"> ● PCS (Pre-Collision System) ● LDA (Lane Departure Alert) ● LTA (Lane Tracing Assist) ●  LCA (Lane Change Assist)* ● AHB (Automatic High Beam)* ● AHS (Adaptive High-beam System)* ● Dynamic radar cruise control system 	<ul style="list-style-type: none"> ● Follow the following correction methods. <ul style="list-style-type: none"> ● Check if there is any foreign matter attached to the radar sensor or radar sensor cover and clean them if necessary.→ P.375 ● This message may be displayed when driving in an open area with few nearby vehicles or structures, such as a desert, grasslands, suburbs, etc. The message may be cleared by driving the vehicle in an area with structures, vehicles, etc. nearby.

"System Stopped Front Radar Sensor Out of Temperature Range Wait until Normal Temperature"

Cause	Remedy
<p>Indicates one of the following systems is disabled.</p> <ul style="list-style-type: none"> ● PCS (Pre-Collision System) ● LDA (Lane Departure Alert) ● LTA (Lane Tracing Assist) ●  LCA (Lane Change Assist)* ● AHB (Automatic High Beam)* ● AHS (Adaptive High-beam System)* ● Dynamic radar cruise control system 	<ul style="list-style-type: none"> ● The temperature of the radar sensor is outside of the operating range. Wait for the temperature to become appropriate.

*: If equipped

"System Stopped Front Radar In Self Calibration See Owner's Manual"

Cause	Remedy
<p>Indicates one of the following systems is disabled.</p> <ul style="list-style-type: none"> ● PCS (Pre-Collision System) ● LDA (Lane Departure Alert) ● LTA (Lane Tracing Assist) ●  LCA (Lane Change Assist)* ● AHB (Automatic High Beam)* ● AHS (Adaptive High-beam System)* ● Dynamic radar cruise control system 	<ul style="list-style-type: none"> ● Follow the following correction methods. <ul style="list-style-type: none"> ● Check if there is any foreign matter attached to the radar sensor or radar sensor cover and clean them if necessary. → P.375 ● The radar sensor may be misaligned and will be adjusted automatically while driving. Continue driving for a while.

"Parking Assist Unavailable Low Visibility See Owner's Manual"

Cause	Remedy
<p>Indicates one of the following systems is disabled.</p> <ul style="list-style-type: none"> ● RCD (Rear camera detection)* ● PKSB (Parking Support Brake)* 	<ul style="list-style-type: none"> ● Remove any dirt or foreign matter from the front/rear cameras.

"Check Engine"

Cause	Remedy
<p>It may indicate a malfunction.</p>	<ul style="list-style-type: none"> ● Have the vehicle inspected by your Lexus dealer immediately.

"Hybrid System Malfunction"

Cause	Remedy
<p>It may indicate a malfunction.</p>	<ul style="list-style-type: none"> ● Have the vehicle inspected by your Lexus dealer immediately.

*: If equipped

"Accelerator System Malfunction"

Cause	Remedy
It may indicate a malfunction.	● Have the vehicle inspected by your Lexus dealer immediately.

"Plug-in Charging System Malfunction"

Cause	Remedy
It may indicate a malfunction.	● Have the vehicle inspected by your Lexus dealer immediately.

"Traction battery system malfunction"

Cause	Remedy
It may indicate a malfunction.	● Have the vehicle inspected by your Lexus dealer immediately.

"Hybrid System Stopped"

Cause	Remedy
The vehicle may have run out of fuel.	● Stop the vehicle in a safe place and, if the fuel level is low, refuel the vehicle.

"Engine stopped No Fuel"

Cause	Remedy
The vehicle may have run out of fuel.	● Stop the vehicle in a safe place and, if the fuel level is low, refuel the vehicle.

"Unavailable Activation Condition not Satisfied See Owner's Manual"

Cause	Remedy
 The LCA function cannot be used as the operating conditions have not been met. → P.405	● Operate the turn signal lever again after all of the operating conditions are met.

*: If equipped

"Cruise Control Unavailable See Owner's Manual"

Cause	Remedy
<p>Indicates one of the following systems is disabled.</p> <ul style="list-style-type: none">● Dynamic radar cruise control● Cruise control <p>A message is displayed when the driving assist switch is pushed repeatedly.</p>	<ul style="list-style-type: none">● Press the driving assist switch quickly and firmly.

9-3. If the hybrid system will not start

When the hybrid system cannot be started even though the correct starting procedure is being followed

Cause	Remedy
If the smart access system with push-button start has been disabled by a setting, the electronic key may not operate normally.	Make sure that the smart access system with push-button start has not been disabled by a customization setting. If the function has been disabled, enable it.
If the electronic key has been set to battery saving mode, it may not operate normally.	Check if electronic key has been set to battery saving mode. If it is, cancel the mode.
There may not be sufficient fuel in the vehicle's tank.	Refuel the vehicle.
There may be a malfunction in the immobilizer system.	<ul style="list-style-type: none">● If the key is touching or is covered by a metallic object, move the key away from the object.● If the key is near to or touching a key to the security system (key with a built-in transponder chip) of another vehicle, move the key away from the other key.
There may be a malfunction in the steering lock system.	Contact your Lexus dealer.
The hybrid system may be malfunctioning due to an electrical problem such as electronic key battery depletion or a blown fuse.	However, depending on the type of malfunction, a temporary measure is available to start the hybrid system.
There may be a malfunction in the shift control system.*1	Contact your Lexus dealer.
There is a possibility that the temperature of the hybrid battery (traction battery) is extremely low (approximately below -22°F [-30°C]).	Try to start the hybrid system again after the temperature of the hybrid battery increases due to the outside temperature increase etc.

*1: It may not be possible to shift the shift position from P.

Related Links

Starting the hybrid system in an emergency(P. 673)

Starting the hybrid system when the electronic key is not operating normally (P. 673)

If a warning message is displayed(P. 651)

Key types(P. 104)

Refueling(P. 218)

Starting the hybrid system(P. 182)

Enable the immobilizer system(P. 126)

Changing the power switch mode(P. 184)

If a warning message is displayed(P. 651)

Starting the hybrid system in an emergency

Do not use this starting procedure except in cases of emergency.

- 1 **Pull the parking brake switch to check that the parking brake is set.**
Parking brake indicator will come on.
- 2 **Check that the shift position is in P.**
- 3 **Turn the power switch to ACC ^{*2}.^{*3}**
- 4 **Press and hold the power switch for about 15 seconds while depressing the brake pedal firmly.**

Even if the hybrid system can be started using the above steps, the system may be malfunctioning.

Have the vehicle checked by your Lexus dealer immediately.

Starting the hybrid system when the electronic key is not operating normally

- 1 **Ensure that the shift position is in P and depress the brake pedal.**
- 2 **Touch the Lexus emblem side of the electronic key to the power switch.**

When the electronic key is detected, a buzzer will sound and the power switch mode will change to ON.

If the smart access system with push-button start has been disabled by a customization setting, the power switch mode will change to ACC.

*2: This can be enabled/disabled through a customize setting.

*3: When ACC is disabled, turn the power switch to ON then OFF, and perform the following steps within 5 seconds.

9-3. If the hybrid system will not start

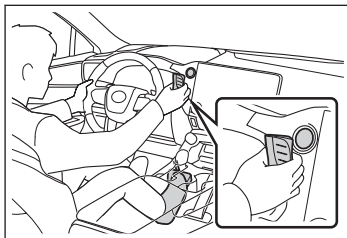

- 3 Firmly depress the brake pedal and check that a message is shown on the multi-information display.
- 4 Press the power switch.

In the event that the hybrid system still cannot be started, contact your Lexus dealer.

INFORMATION

■ Stopping the hybrid system

Shift the shift position to P, set the parking brake and press the power switch as you normally do when stopping the hybrid system.

■ Electronic key battery

As the above procedure is a temporary measure, it is recommended that the electronic key battery be replaced immediately when the battery is depleted.

■ Changing power switch modes

Release the brake pedal and press the power switch in step 4 above. The hybrid system will not start and the mode will be changed each time the switch is pressed.

Related Links

[Replace the electronic key battery\(P. 687\)](#)

When the interior lights or headlights are dim and the hybrid system cannot be started

Cause	Remedy
The 12-volt battery may be discharged.	Restarting the hybrid system using the jumper (or booster) cables.
The 12-volt battery terminals may be loose or corroded.	Check if a 12-volt battery terminal is loose or corroded.

Related Links

Restarting the hybrid system when the 12-volt battery is discharged(P. 692)

If the vehicle 12-volt battery is discharged(P. 675)

If the vehicle 12-volt battery is discharged(P. 675)

Key types(P. 104)

Opening/closing the doors(P. 115)

Using the mechanical key(P. 690)

If a door cannot be opened using the door opener switch(P. 696)

When removing the 12-volt battery terminals(P. 679)

Items to initialize(P. 783)

If the vehicle 12-volt battery is discharged

WARNING

■ When replacing the 12-volt battery

- When the vent plug and indicator are close to the hold down clamp, the battery fluid (sulfuric acid) may leak.
- For information regarding 12-volt battery replacement, contact your Lexus dealer.

If the 12-volt battery discharges, it may not be possible to shift the shift position to other positions.

In this case, the vehicle cannot be towed without lifting both front wheels because the front wheels will be locked.

INFORMATION

■ When the 12-volt battery is removed or discharged

- In some cases, it may not be possible to unlock the doors using the smart access system with push-button start after the 12-volt battery has been replaced.

Use the wireless remote control or the mechanical key to lock or unlock the doors.

- If the hybrid system cannot be started the first time the power switch is pressed after removing and installing the 12-volt battery, touch the Lexus emblem side of the electronic key to the power switch to start the hybrid system.
- The power switch mode is memorized by the vehicle.

After the 12-volt battery has been recharged or replaced, the power switch will return to the mode it was in before it was discharged or removed.

Before disconnecting the 12-volt battery, turn the power switch off.

If you are unsure what mode the power switch was in before the 12-volt battery was discharged, be especially careful when reconnecting the 12-volt battery.

- Some systems may require initialization.

■ To prevent 12-volt battery discharge

- Turn off the headlights and the audio system while the hybrid system is off.
- Turn off any unnecessary electrical components when the vehicle is running at a low speed for an extended period, such as in heavy traffic.

■ If the vehicle 12-volt battery is discharged

- The doors cannot be locked or unlocked using the Smart access system with push-button start or wireless remote control, and the door opener switches will not operate. Use the mechanical key to enable/disable manual release handle operation. By enabling manual release handle operation, the door can be opened.
- Information recorded by various computers will be cleared.

If the 12-volt battery has become discharged, have the vehicle inspected by your Lexus dealer.

- Some systems may require initialization.

■ Charging the 12-volt battery

The electricity stored in the 12-volt battery will discharge gradually even when the vehicle is not in use, due to natural discharge and the draining effects of certain electrical appliances.

If the vehicle is left for a long time, the 12-volt battery may discharge, and the hybrid system may be unable to start.

(The 12-volt battery recharges automatically while the hybrid system is operating.)

■ When replacing the 12-volt battery

- Use a 12-volt battery that the case size is same as the previous one (LN2), 20 hour rate capacity (20HR) is equivalent (60Ah) or greater, and performance rating (CCA) is equivalent (345A) or greater.
 - If the sizes differ, the 12-volt battery cannot be properly secured.
 - If the 20 hour rate capacity of the replacement battery is low, even if the vehicle is used frequently, the 12-volt battery may discharge and hybrid system may not be able to start.
- After replacing the 12-volt battery, install the following to the exhaust holes of the new 12-volt battery.*1
 - Use the exhaust hose that was attached to the removed 12-volt battery and make sure that it is securely engaged to the hole in the vehicle.
 - Use the exhaust hole plug that is included with the new 12-volt battery or the one installed to the removed 12-volt battery.

Contact your Lexus dealer for details.

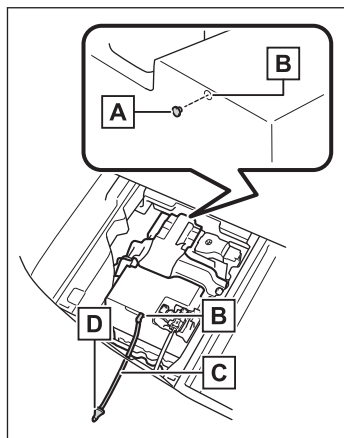

- A Exhaust hole plug
- B Exhaust hole
- C Exhaust hose
- D Hole in vehicle

When the doors cannot be locked from outside the vehicle after the 12-volt battery was discharged

The doors cannot be locked using the Smart access system with push-button start or wireless remote control.

*1: The exhaust holes of the new 12-volt battery may be plugged.

Disabling the operation of the driver's door

- 1 Insert a plastic card, etc. into the gap in the door handle to pry up the cover.
To avoid damage, do not apply excessive force to the cover.
- 2 Remove the cover by pressing it on the rear.
- 3 Using the mechanical key, turn the door lock to the lock side to disable the door.

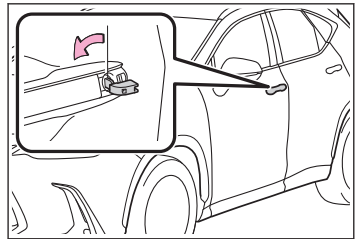
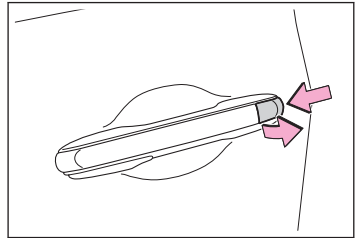
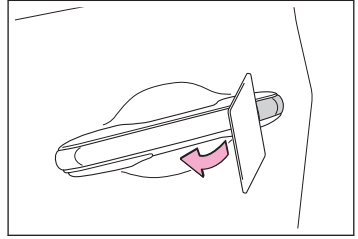

- 4 Check that the door cannot be opened.

Disabling the operation of doors other than the driver's door

- 1 Open the door. Using the mechanical key, slide the cover as shown in the illustration.
To avoid damage, do not apply excessive force to the cover.

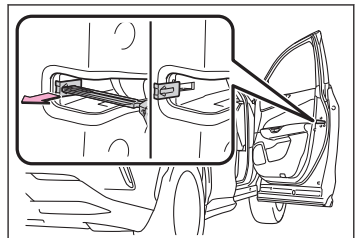

- 2 Insert the mechanical key into the opening.

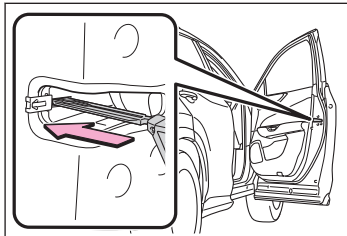

- 3 Remove the mechanical key and slide the emergency lock cover back to its original position.

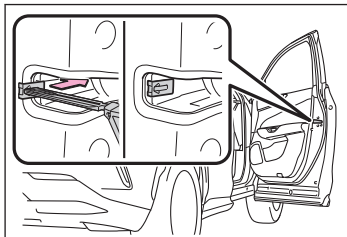

- 4 Check that all of the doors cannot be opened.

When removing the 12-volt battery terminals

When disconnecting a 12-volt battery terminal, contact your Lexus dealer.

If a 12-volt battery terminal is disconnected, the doors will not be able to be opened using the door opener switches and the electronic key may become trapped in the vehicle.

To prevent the electronic key (mechanical key) from being locked inside the vehicle, make sure to remove it from the vehicle before disconnecting a 12-volt battery terminal.

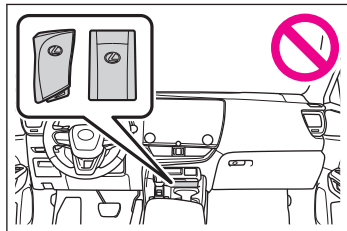

If the electronic key (mechanical key) is to be left in the vehicle, make sure to open a window so an inside manual release handle can be operated.

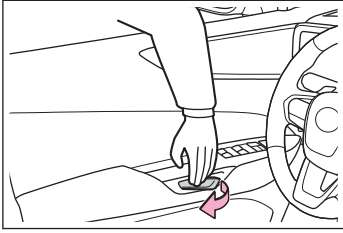

▲ WARNING

■ When removing the 12-volt battery terminals

Always remove the negative (-) terminal first. If the positive (+) terminal contacts any metal in the surrounding area when the positive (+) terminal is removed, a spark may occur, leading to a fire in addition to electrical shocks and death or serious injury.

■ Avoiding 12-volt battery fires or explosions

Observe the following precautions to prevent accidentally igniting the flammable gas that may be emitted from the 12-volt battery:

Do not smoke, use matches, cigarette lighters or allow open flame near the 12-volt battery.

■ 12-volt battery precautions

The 12-volt battery contains poisonous and corrosive acidic electrolyte, while related parts contain lead and lead compounds. Observe the following precautions when handling the 12-volt battery:

- When working with the 12-volt battery, always wear safety glasses and take care not to allow any battery fluids (acid) to come into contact with skin, clothing or the vehicle body.

- Do not lean over the 12-volt battery.

- In the event that battery fluid comes into contact with the skin or eyes, immediately wash the affected area with water and seek medical attention.

Place a wet sponge or cloth over the affected area until medical attention can be received.

- Always wash your hands after handling the 12-volt battery support, terminals, and other battery-related parts.

- Do not allow children near the 12-volt battery.

 **INFORMATION****■ If a 12-volt battery terminal has been disconnected**

- If a 12-volt battery terminal has been disconnected, the doors cannot be locked or unlocked using the Smart access system with push-button start system or wireless remote control, and the door opener switches will not operate.

Make sure to remove the electronic key (mechanical key) from the vehicle before disconnecting a 12-volt battery terminal.

If the electronic key (mechanical key) is to be left in the vehicle, open a window so an inside manual release handle can be operated.

- The doors may not be able to be unlocked using the Smart access system with push-button start immediately after a 12-volt battery terminal is disconnected and reconnected.

If the doors cannot be unlocked, use the wireless remote control or mechanical key to lock and unlock the doors.

- When a 12-volt battery terminal is disconnected, information recorded by various computers will be cleared.
- Some systems may require initialization.

When the interior lights or headlights do not illuminate and the hybrid system cannot be started

Cause	Remedy
The 12-volt battery may be discharged.	Restarting the hybrid system using the jumper (or booster) cables. Contact your Lexus dealer if the problem cannot be repaired, or if repair procedures are unknown.
One or both of the 12-volt battery terminals may be disconnected.	Check if a 12-volt battery terminal is disconnected. Contact your Lexus dealer if the problem cannot be repaired, or if repair procedures are unknown.
The steering lock system may be malfunctioning.	Contact your Lexus dealer.

Related Links

[If the vehicle 12-volt battery is discharged\(P. 675\)](#)

[Restarting the hybrid system when the 12-volt battery is discharged\(P. 692\)](#)

[If the vehicle 12-volt battery is discharged\(P. 675\)](#)

[Key types\(P. 104\)](#)

[Locking/unlocking the doors\(P. 119\)](#)

[Opening/closing the doors\(P. 115\)](#)

[Using the mechanical key\(P. 690\)](#)

[If a door cannot be opened using the door opener switch\(P. 696\)](#)

[When removing the 12-volt battery terminals\(P. 679\)](#)

[Items to initialize\(P. 783\)](#)

When the horn sounds at a low volume and the hybrid system cannot be started

Cause	Remedy
The 12-volt battery may be discharged.	Restarting the hybrid system using the jumper (or booster) cables.
The 12-volt battery terminal connections may be loose or corroded.	The 12-volt battery terminals may be loose or corroded.

Related Links

[If the vehicle 12-volt battery is discharged\(P. 675\)](#)

[Restarting the hybrid system when the 12-volt battery is discharged\(P. 692\)](#)

[If the vehicle 12-volt battery is discharged\(P. 675\)](#)

When the horn does not sound and the hybrid system cannot be started

Cause	Remedy
The 12-volt battery may be discharged.	Restarting the hybrid system using the jumper (or booster) cables. Contact your Lexus dealer if the problem cannot be repaired, or if repair procedures are unknown.
One or both of the 12-volt battery terminals may be disconnected.	Check if a 12-volt battery terminal is loose. Contact your Lexus dealer if the problem cannot be repaired, or if repair procedures are unknown.
The steering lock system may be malfunctioning.	Contact your Lexus dealer.

Related Links

[If the vehicle 12-volt battery is discharged\(P. 675\)](#)

[Restarting the hybrid system when the 12-volt battery is discharged\(P. 692\)](#)

[If the vehicle 12-volt battery is discharged\(P. 675\)](#)

Precautions for when you have a flat tire

Your vehicle is not equipped with a spare tire, but instead you can continue driving the vehicle with run-flat tires even if any tire goes flat. In this case, slow down and drive with extra caution.

Take your vehicle to the nearest Lexus dealer or authorized tire dealer as soon as possible if any tire goes flat.

The vehicle can be driven for a maximum of 50 miles (80 km) at a speed below 50 mph (80 km/h) after the tire pressure warning light comes on.

A run-flat tire has a  mark on the side wall.

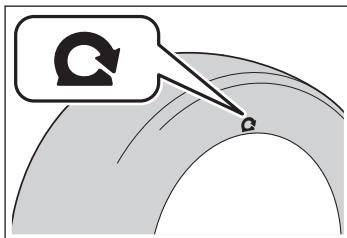

INFORMATION

In some conditions (such as at high temperatures)

You cannot continue driving for up to 50 miles (80 km).

NOTICE

When replacing the tires

When removing or fitting the wheels, tires or the tire pressure warning valve and transmitter, contact your Lexus dealer as the tire pressure warning valve and transmitter may be damaged if not handled correctly.

When driving over bumps

If a vehicle has a flat tire, the vehicle height will be lower than usual. Ensure that nothing strikes the bottom of the vehicle.

To avoid damage to the tire pressure warning valves and transmitters

When a tire is repaired with liquid sealants, the tire pressure warning valve and transmitter may not operate properly. If a liquid sealant is used, contact your Lexus dealer or other qualified service shop as soon as possible. Make sure to replace the tire pressure warning valve and transmitter when replacing the tire.

If a key has been lost

New genuine mechanical keys can be made by your Lexus dealer using another mechanical key and the key number stamped on your key number plate.

Keep the plate in a safe place such as your wallet, not in the vehicle.

 **NOTICE**

If the electronic key remains lost, the risk of vehicle theft increases significantly. Visit your Lexus dealer immediately with all remaining electronic keys and the card key* that were provided with your vehicle.

*: If equipped

When the doors/windows/moon roof cannot be operated using an electronic key

If communication between the electronic key and vehicle is interrupted or the electronic key cannot be used because the battery is depleted, the smart access system with push-button start and wireless remote control cannot be used.

The smart access system with push-button start may have been disabled by a customize setting.

In this case, change the customize setting to enable the smart access system with push-button start.

NOTICE

When taking the vehicle to your Lexus dealer due to a malfunction of the smart access system with push-button start, make sure to bring all registered electronic keys (including the card key).

The electronic key may have been set to battery saving mode.

battery saving mode has been set, cancel it.

The battery of the electronic key may be discharged.

- **Replace the battery.**
- **Using the mechanical key.**

The 12-volt battery may be discharged.

Restarting the hybrid system using the jumper (or booster) cables.

Replace the electronic key battery

Replace the battery with a new one if it is depleted.

The battery for the card key is available only at Lexus dealers. Your Lexus dealer can replace the battery for you.

Prepare the following before replacing the battery:

- Flathead screwdriver
- Small flathead screwdriver
- Lithium battery CR2032

 **INFORMATION**

■ **Use a CR2032 lithium battery**

Batteries can be purchased at your Lexus dealer, local electrical appliance shops or camera stores.

- Replace only with the same or equivalent type recommended by the manufacturer.
- Dispose of used batteries according to the local laws.

■ **If the electronic key battery is depleted**

The following symptoms may occur:

- The smart access system with push-button start and wireless remote control will not function properly.
- The operational range will be reduced.

1 Take out the mechanical key.

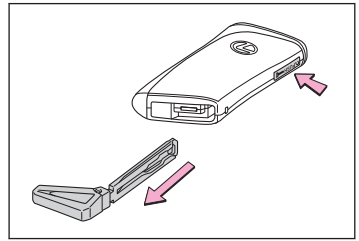

2 Remove the cover.

To prevent damage to the key, cover the tip of the flathead screwdriver with a tape.

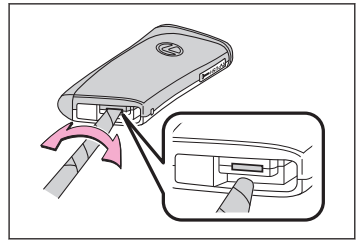

3 Remove the depleted battery.

Insert a new battery with the “+” terminal facing up.

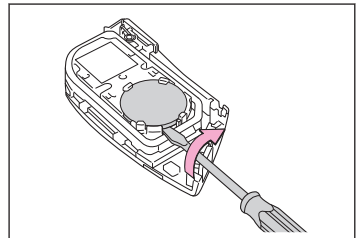

⚠ WARNING**■ Battery precautions**

Observe the following precautions. Failure to do so may result in death or serious injury.

- Do not swallow the battery. Doing so may cause chemical burns.
- A coin battery or button battery is used in the electronic key. If a battery is swallowed, it may cause severe chemical burns in as little as 2 hours and may result in death or serious injury.
- Keep away new and removed batteries from children.
- If the cover cannot be firmly closed, stop using the electronic key and stow the key in the place where children cannot reach, and then contact your Lexus dealer.
- If you accidentally swallow a battery or put a battery into a part of your body, get emergency medical attention immediately.

■ To prevent battery explosion or leakage of flammable liquid or gas

- Replace the battery with a new battery of the same type. If a wrong type of battery is used, it may explode.
- Do not expose batteries to extremely low pressure due to high altitude or extremely high temperatures.
- Do not burn, break or cut a battery.

⚠ NOTICE**■ When replacing the battery**

Use a flathead screwdriver of appropriate size. Applying excessive force may deform or damage the cover.

■ For normal operation after replacing the battery

Observe the following precautions to prevent accidents:

- Always work with dry hands.
Moisture may cause the battery to rust.
- Do not touch or move any other component inside the remote control.
- Do not bend either of the battery terminals.

Using the mechanical key

To take out the mechanical key, push the release button and take the key out.

The mechanical key can only be inserted in one direction, as the key only has a groove on one side. If the key cannot be inserted in a lock cylinder, turn it over and attempt to insert it again. After using the mechanical key, return it to its original position and carry it with the electronic key. If the electronic key battery is depleted, the entry function is not operating properly, or the vehicle 12-volt battery is discharged, you will need the mechanical key.

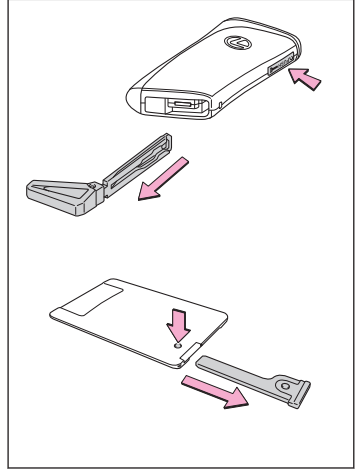

NOTICE

Do not apply excess force when inserting the mechanical key into the card key. Doing so may damage the card key.

INFORMATION

■ If the incorrect key is used

The key cylinder rotates freely to isolate inside mechanism.

■ Card key

- If it is difficult to take out the mechanical key, push down the release button using a pen tip, etc. If it is still difficult to pull it out, use a coin, etc.
- To store the mechanical key in the card key, insert it while pressing the release button.

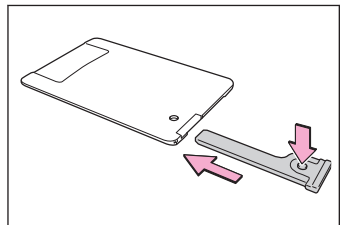

■ Alarm

If a door is unlocked using the mechanical key when the alarm system is set, a 10 second pre-alarm sounds.

Locking/unlocking the doors

- 1 Insert a plastic card, etc. into the gap in the door handle to pry up the cover.

To avoid damage, do not apply excessive force to the cover.

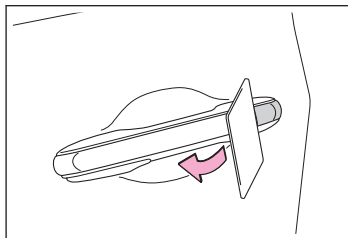

- 2 Remove the cover by pressing it on the rear.

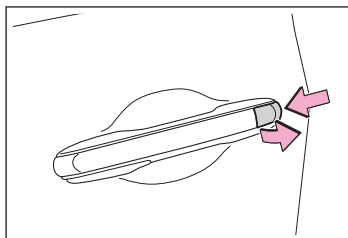

- 3 Use the mechanical key in order to perform the following operations:

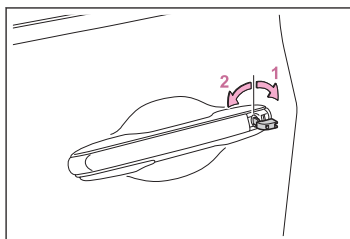

- 1 Unlocks all the doors
Turning the key unlocks the driver's door. Turning the key again unlocks the other doors.
- 2 Locks all the doors

INFORMATION

Key linked functions

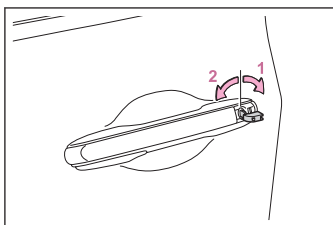

- 1 Opens the windows and the moon roof (turn and hold)*¹
- 2 Closes the windows and the moon roof (turn and hold)*¹

*1: These settings must be customized at your Lexus dealer.

9-5. If a door cannot be opened or locked

WARNING

Operate the power window or moon roof after checking to make sure that there is no possibility of any passenger having any of their body parts caught in the window or moon roof. Also, do not allow children to operate the mechanical key. It is possible for children and other passengers to get caught in the power window or moon roof.

Restarting the hybrid system when the 12-volt battery is discharged

If you have a set of jumper (or booster) cables and a second vehicle with a 12-volt battery, you can jump start your vehicle by following the steps below.

INFORMATION

The hybrid system cannot be started by push-starting.

WARNING

Avoiding 12-volt battery fires or explosions

Observe the following precautions to prevent accidentally igniting the flammable gas that may be emitted from the 12-volt battery:

- Make sure each jumper cable is connected to the correct terminal and that it is not unintentionally in contact with any other than the intended terminal.
- Do not allow the other end of the jumper cable connected to the “+” terminal to come into contact with any other parts or metal surfaces in the area, such as brackets or unpainted metal.
- Do not allow the + and - clamps of the jumper cables to come into contact with each other.
- Do not smoke, use matches, cigarette lighters or allow open flame near the 12-volt battery.

12-volt battery precautions

The 12-volt battery contains poisonous and corrosive acidic electrolyte, while related parts contain lead and lead compounds. Observe the following precautions when handling the 12-volt battery:

- When working with the 12-volt battery, always wear safety glasses and take care not to allow any battery fluids (acid) to come into contact with skin, clothing or the vehicle body.
- Do not lean over the 12-volt battery.
- In the event that battery fluid comes into contact with the skin or eyes, immediately wash the affected area with water and seek medical attention. Place a wet sponge or cloth over the affected area until medical attention can be received.

⚠ WARNING

- Always wash your hands after handling the 12-volt battery support, terminals, and other battery-related parts.
- Do not allow children near the 12-volt battery.

■ When replacing the 12-volt battery

After replacing, securely attach the exhaust hose and exhaust hole plug to the exhaust hole of the new 12-volt battery. If not properly installed, gases (hydrogen) may leak into the vehicle interior, and there is the possible danger of the gas igniting and exploding.

1 Confirm that the electronic key is being carried.

When connecting the jumper (or booster) cables, depending on the situation, the alarm may activate and the doors may lock.

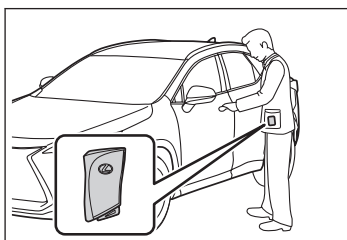
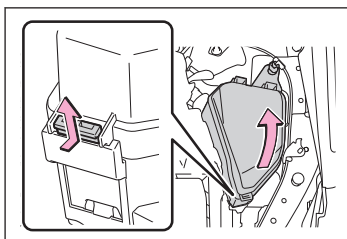
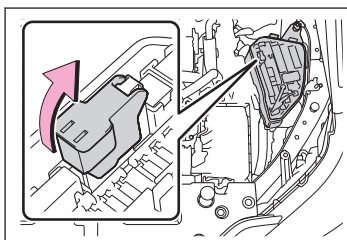
**2 Open the hood and exclusive jump starting terminal cover.****3 Open the exclusive jump starting terminal cover.**

- 4** Connect a positive jumper cable clamp to **A** on your vehicle and connect the clamp on the other end of the positive cable to **B** on the second vehicle. Then, connect a negative cable clamp to **C** on the second vehicle and connect the clamp at the other end of the negative cable to **D**.

9-5. If a door cannot be opened or locked

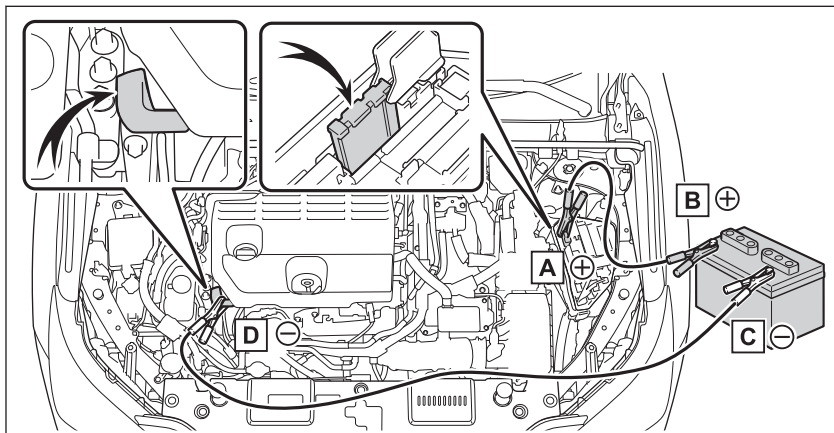

- A Exclusive jump starting terminal (your vehicle)
- B Positive (+) battery terminal (second vehicle)
- C Negative (-) battery terminal (second vehicle)
- D Solid, stationary, unpainted metallic point away from the exclusive jump starting terminal and any moving parts as shown in the illustration

⚠ NOTICE

■ When handling jumper cables

When connecting the jumper cables, ensure that they do not become entangled in the cooling fan or belt.

■ Exclusive jump starting terminal

The exclusive jump starting terminal is intended to charge the 12-volt battery on your vehicle from another vehicle in an emergency.

Do not use the exclusive jump starting terminal to jump start another vehicle.

- 5 Start the engine of the second vehicle. Increase the engine speed slightly and maintain at that level for approximately 5 minutes to recharge the 12-volt battery of your vehicle.
- 6 Open and close any of the doors of your vehicle with the power switch off.
- 7 Maintain the engine speed of the second vehicle and start the hybrid system of your vehicle by turning the power switch to ON.
- 8 Make sure the "READY" indicator comes on.
If the indicator light does not come on, contact your Lexus dealer.
- 9 Once the hybrid system has started, remove the jumper cables in the exact reverse order from which they were connected.

Once the hybrid system starts, have the vehicle inspected at your Lexus dealer as soon as possible.

▲ WARNING

After recharging the 12-volt battery, have the 12-volt battery inspected by your Lexus dealer as soon as possible.

If the 12-volt battery is deteriorating, continued use may cause the 12-volt battery to emit a malodorous gas, which may be detrimental to the health of passengers.

If a door cannot be opened using the door opener switch

If a door cannot be opened using the door opener switch, it can be opened using a manual release handle.

Operating a manual release handle

NOTICE

Normally, the manual release handles cannot be used to open the doors. To enable manual release handle operation, perform the following. If the following is not performed and/or a manual release handle is operated with force, it may deform or be damaged.

► Outside the vehicle

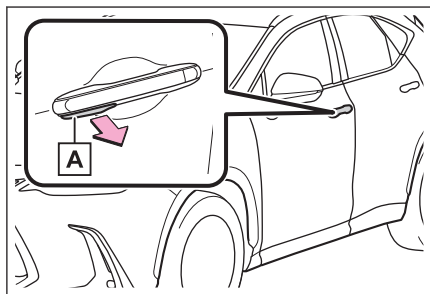

Pull the manual release handle **A** to open the door.

Normally, the manual release handles cannot be used to open the doors.

To open a door, enable manual release handle operation. → P.698

► Inside the vehicle

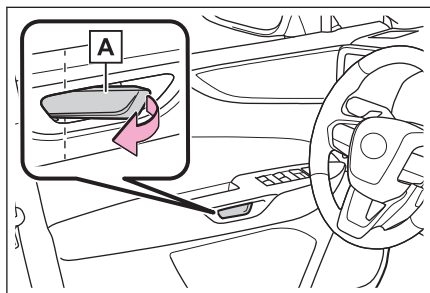

Pull the manual release handle **A** twice to open the door.

Pulling the handle once will enable operation. Pulling the handle again will open the door.

INFORMATION

Manual release handle operating conditions

- If the vehicle is involved in a severe frontal or rear collision, manual release handle operation will be enabled for all of the doors.

However, the manual release handle may not become operable depending on the force of the impact and conditions of the collision.

- When the 12-volt battery voltage drops slowly while a door was unlocked
It may not work depending on how it is lowered.
- When manual release handle operation is enabled from inside the vehicle

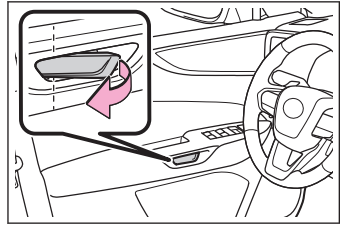

- When manual release handle operation is enabled from outside the vehicle using a mechanical key

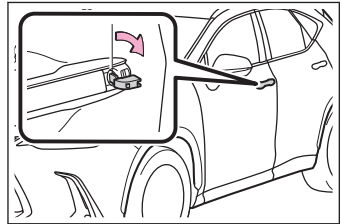

Conditions which manual release handle operation is disabled

- Normally, operation of the outside manual release handles is disabled, and they cannot be used to open the doors.

When operation is enabled by operating a manual release handle or using a mechanical key, operation will be disabled automatically if the door is opened using the door opener switch or locked.

- Operation of the inside manual release handles is disabled when the power switch is in ON, and they cannot be used to open the doors.

When operation is enabled by operating a manual release handle or using a mechanical key, operation will be disabled automatically if the door is opened using the door opener switch or locked.

9-5. If a door cannot be opened or locked

- To prevent a door from being opened accidentally, when the power switch is in ON, after an inside manual release handle is operated once, operation will automatically be disabled after approximately 1 second.

Related Links

[Using the mechanical key\(P. 690\)](#)

Enabling outside manual release handle operation using a mechanical key

Operation of a manual release handle can be enabled by unlocking a door with the mechanical key.

- 1 **Insert a plastic card, etc. into the gap in the door handle to pry up the cover.**

To avoid damage, do not apply excessive force to the cover.

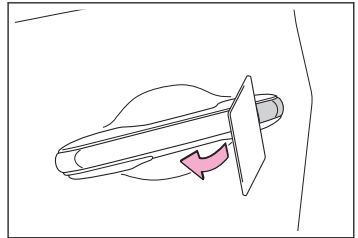

- 2 **Remove the cover by pressing it on the rear.**

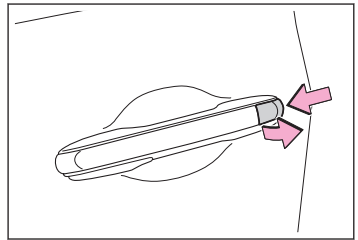

- 3 **Using the mechanical key, turn the lock cylinder to the unlock side to enable the manual release handle operation.**

The mechanical key can only be inserted in one direction, as the key only has a groove on one side.

If the key cannot be inserted in a lock cylinder, turn it over and re-attempt to insert it.

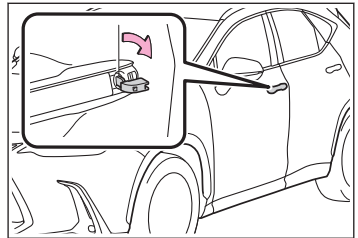

If the rear doors cannot be opened from the inside

The child-protector lock may be engaged.

Open the door from outside the vehicle and disengage the child-protector lock.

Related Links

[Preventing the rear doors from being opened from the inside of the vehicle \(child-protector lock\)\(P. 92\)](#)

If the back door cannot be opened

The back door can be unlocked from the inside.

- 1 Using a flathead screwdriver, remove the cover.

To protect the cover, place a rag between the flathead screwdriver and the cover as shown in the illustration.

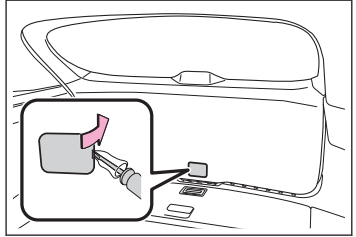

- 2 Loosen the screw and turn back the cover.

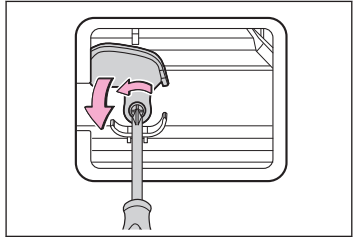

- 3 Using a screwdriver, push the lever.

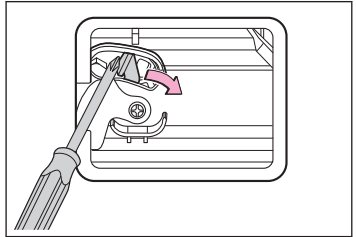

If the moon roof does not operate correctly

If the moon roof closes but then re-opens slightly

- 1 Stop the vehicle.
- 2 Press and hold the  switch.*1



The moon roof will close, reopen and pause for approximately 10 seconds.*2

Then it will close again, tilt up and pause for approximately 1 second. Finally, it will tilt down, open and close.

- 3 Check to make sure that the moon roof completely stops and then release the switch.



If the moon roof does not fully close even after performing the above procedure correctly, have the vehicle inspected by your Lexus dealer.

If the moon roof tilts down but then tilts back up



- 1 Stop the vehicle.
- 2 Press and hold the  switch until the moon roof moves into the tilt up position and stops.*3
- 3 Release the switch once and then press and hold the  switch again.*3
- 4 Check to make sure that the moon roof is completely closed and then release the switch.

If the moon roof does not fully close even after performing the above procedure correctly, have the vehicle inspected by your Lexus dealer.

*1: If the switch is released at the incorrect time, the procedure will have to be performed again from the beginning.

*2: If the switch is released after the above mentioned 10 second pause, automatic operation will be disabled. In that case, press and hold the  or  switch, and the moon roof will tilt up and pause for approximately 1 second. Then it will tilt down, open and close. Check to make sure that the moon roof is completely closed and then release the switch.

*3: If the switch is released at the incorrect time, the procedure will have to be performed again from the beginning.

*4: If the switch is released after the above mentioned 10 second pause, automatic operation will be disabled. In that case, press and hold the  or  switch, and the moon roof will tilt up and pause for approximately 1 second. Then it will tilt down, open and close. Check to make sure that the moon roof is completely closed and then release the switch.

If the fuel filler door cannot be opened

If the fuel filler door opener switch cannot be operated, contact your Lexus dealer to service the vehicle. In case where refueling is urgently necessary, the following procedure can be used to open the fuel filler door.

- 1 Remove the cover inside the luggage compartment by inserting a screwdriver.**

When removing the cover, to prevent damage, cover the tip of the screwdriver with a rag.

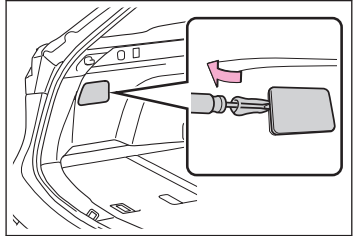

- 2 Pull the lever.**

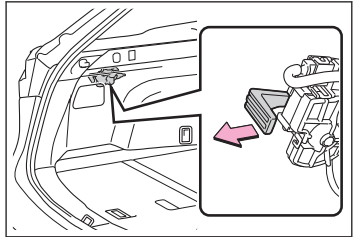

⚠ NOTICE

■ When opening the fuel filler door manually

- Do not open the fuel filler door manually except in an emergency. Fuel may overflow.
- Using the lever to open the fuel filler door may not allow for an adequate reduction in fuel tank pressure before refueling. To prevent fuel from spilling out, turn the cap slowly when removing it.
- During refueling, fuel may spill out from the filler opening due to air being discharged from inside the fuel tank. Therefore, fill the fuel tank carefully and slowly.

If the hybrid battery (traction battery) of the plug-in hybrid system cannot be charged

If the charging port lid does not open

In an emergency, if the charging port lid cannot be opened using the normal procedure, it can be opened using the charging port lid lock emergency release lever.

Opening the charging port lid in an emergency

- 1 Using a flathead screwdriver, remove the cover inside the luggage compartment as shown in the illustration.

When removing the cover, to prevent damage, cover the tip of the screwdriver with a rag.

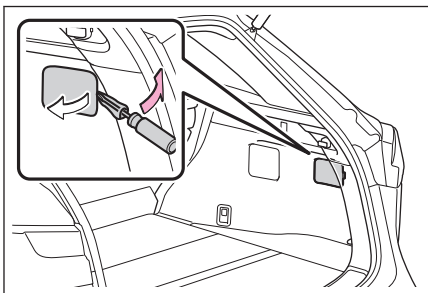

- 2 Insert a hand from the lower side of the vehicle obliquely upward, and hook a finger to the emergency release lever.

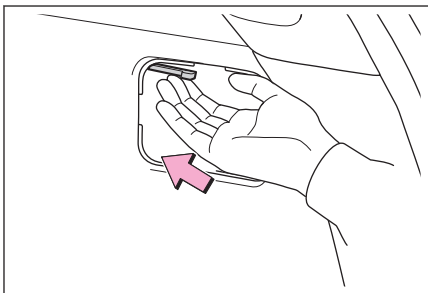

- 3 Move the emergency release lever in the direction shown in the illustration.

Make sure to move in the direction shown in the illustration. Applying force in other directions may damage the emergency release lever.

9-8. If the plug-in hybrid system cannot be used normally

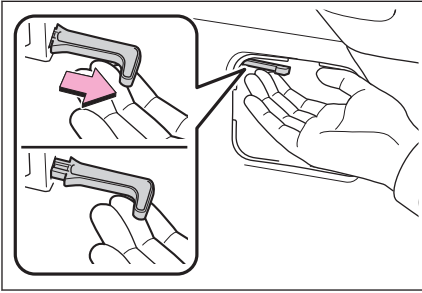

The charging port lid is unlocked and can be opened.

4 Press the central rear edge of the charging port lid to open it.

This unlocking method is a temporary correction procedure for emergency use only. If the problem persists, have the vehicle inspected by your Lexus dealer immediately.

The power source indicator on the CCID (Charging Circuit Interrupting Device) does not illuminate, even though the plug is connected to an external power source.

Plug is not properly connected to socket

Check that the plug is properly connected to the socket.

Power is out

After power is restored, carry out the charging procedure again.

Remote switch is off

If the remote switch is equipped, turn the switch on.

Building breaker is tripped and power is cut off

Check that the breaker is connected and if there is no malfunction, check if the vehicle can be charged through another socket.

If charging is possible, the first socket may have a malfunction. Contact the building or facility manager, or an electrician.

Short circuit between CCID (Charging Circuit Interrupting Device) and plug

Immediately stop charging and contact your Lexus dealer.

The error warning indicator on the CCID (Charging Circuit Interrupting Device) flashes.

Electrical leakage detection function or self-diagnostic function operates and power is cut off.

When the voltage is insufficient, the error warning indicator may flash when there is noise interference. Perform a reset and connect to a proper power source.

If charging does not start, immediately stop charging and contact your Lexus dealer.

Charging indicator of the charging port does not illuminate, even though charging connector is connected.

The plug is not properly connected to the socket

Check that the plug is properly connected to the socket.

Charging connector is not securely connected to AC charging inlet

Check the connection status of the charging connector.

- When connecting the charging connector, make sure not to touch the latch release button. Insert the charging connector securely until you hear a click. The charging connector may not be connected correctly if the latch release button is pressed while inserting.
- After connecting the charging connector, check that the latch release button is not pressed and the charging indicator of the charging port is turned on.

If the charging indicator of the charging port does not illuminate, even though the charging connector is securely connected, there may be a malfunction in the system. Immediately stop charging and contact your Lexus dealer.

Hybrid battery (traction battery) is already fully charged

When the hybrid battery (traction battery) is fully charged, charging is not performed.

The charger does not operate

Please contact the facility manager when there is a problem with charger.

When the charging indicator on the charging port is blinking

When charging indicator of the charging port flashes: Charging schedule is registered

When you wish to charge according to the charging schedule, wait until the set time.

To start charging, set [**Charge now**] to on.

When charging indicator of the charging port rapidly flashes: Malfunction occurred in an external power source or the vehicle

9-8. If the plug-in hybrid system cannot be used normally

Start the hybrid system and follow the instructions displayed by the message on the multi-information display.

If the charging connector cannot be disconnected from the AC charging inlet

If the charging connector cannot be unlocked

The charging connector can be unlocked by operating the emergency release lever.

Unlocking the charging connector in an emergency

- 1 Using a flathead screwdriver, remove the cover inside the luggage compartment as shown in the illustration.

When removing the cover, to prevent damage, cover the tip of the screwdriver with a rag.

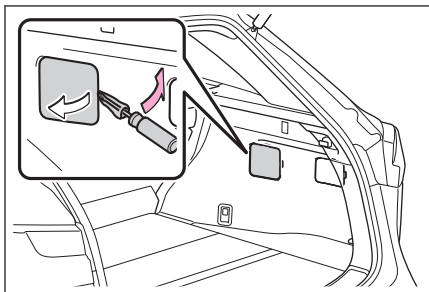

- 2 Move the emergency release lever in the direction shown in the illustration.

Move the emergency release lever only in the direction shown in the illustration. Even if a click sound is heard after beginning operation, do not stop pulling the emergency release lever until it cannot be moved. If the emergency release lever is moved in any other direction, it may be damaged.

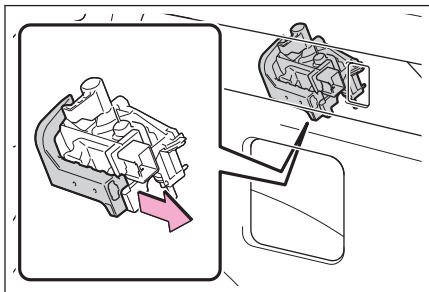

The charging connector is unlocked and can be removed.

This procedure is a temporary correction procedure for emergency use only. If the problem persists, have the vehicle inspected by your Lexus dealer immediately.

Do not operate the emergency release lever when the charging connector can be unlocked in the normal procedure.

9-8. If the plug-in hybrid system cannot be used normally

INFORMATION

After operating the connector lock emergency release lever, push it back to its original position until a click sound is heard.

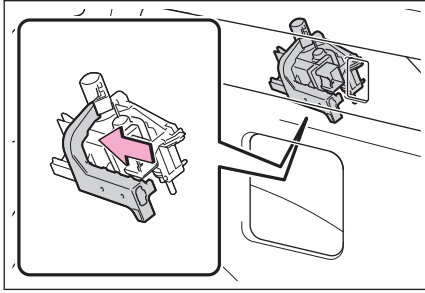

When a malfunction occurs during charging

The indicators on the CCID (Charging Circuit Interrupting Device) use a combination of different statuses (not illuminated, illuminated or flashing) to inform the user of internal malfunctions.

When the error warning indicator is illuminated or flashing, temporarily remove the plug from the outlet and then reconnect it to check if the error indicator turns off.

If the error warning indicator turns off, charging is now possible. If it does not turn off, perform the correction procedure in the following chart.

Status	Power indicator	Error warning indicator	Cause/Correction procedure
Charging system error	Not illuminated	Not illuminated or illuminated	An electrical leakage is detected and charging is canceled, or there is a malfunction in the AC charging cable. Consult your Lexus dealer.
	Illuminated	Flashes	
Plug temperature detection malfunction	Flashes	Flashes	There is a malfunction in the plug temperature detection part. Consult your Lexus dealer.
Plug temperature increase detection	Flashes	Not illuminated	An increase in the temperature of the plug is detected due to an improper connection between the socket and plug. Check that the plug is securely connected to the socket.

9-8. If the plug-in hybrid system cannot be used normally

Status	Power indicator	Error warning indicator	Cause/Correction procedure
AC charging cable life span notice	Illuminated	Flashes	The number of charges using the AC charging cable is nearing the end of its usable life span. Consult your Lexus dealer.
AC charging cable life span	Illuminated	Illuminated	The number of charges using the AC charging cable has exceeded its usable number of charges. Consult your Lexus dealer.

If the charging schedule function does not operate normally

Cannot charge at desired time

Vehicle clock is not properly adjusted

Check the clock settings and adjust it to the proper time.*1

The vehicle calendar is not set correctly.

Check the calendar setting and set it to the correct date.*1

AC charging cable is not connected to vehicle

Before using the charging schedule, connect the AC charging cable.

Incorrect charging mode selected

Check the charging mode setting.

When the charging mode is **[Start at set time]**, charging starts at the set time, but when it is **[Departure time]**, charging is completed by the set time (The charging start time is automatically controlled by the system).

Cannot change **[Next charging event]** from smartphone application

Smartphone is outside its coverage area*2

Check the signal strength. If the smartphone is outside its coverage area, move to a place with a better signal.

Charging starts, even though charging schedule is registered

[Charge now] is set to on

When charging according to the charging schedule, set **[Charge now]** to off.

Charging schedule is set to off

Check that charging schedule is not set to off.

Charging mode is set to **[Departure time]** and schedule departure time is close to current time

When the system determines that there is no time to finish charging by the set scheduled departure time, it starts charging. Check the charging schedules.

AC charging cable was removed and reinserted while charging indicator of the charging port was flashing

*1: For the setting procedure for the clock, refer to the "MULTIMEDIA OWNER'S MANUAL".

*2: It may be necessary to use a smartphone with a dedicated app to change the next charging schedule.

9-8. If the plug-in hybrid system cannot be used normally

If the AC charging cable is removed and reinserted while the charging indicator is flashing, the charging schedule is canceled. Temporarily remove the AC charging cable, and then reconnect it.

My Room Mode was operated

When My Room Mode is operated, the system will start charging, even if the charging schedule is registered. To carry out charging using the charging schedule, stop My Room Mode, and then reconnect the AC charging cable.

Traction battery heater operated

When the charging mode is set to **[Departure time]**, traction battery heater may operate before charging starts. Check the status of the charging indicator of the charging port.

Outside temperature is low and hybrid battery (traction battery) warming control operated (Alaska and Canada only)

When hybrid battery (traction battery) warming control operates, the charging schedules are ignored and charging starts. In order to protect the hybrid battery (traction battery), allow charging to continue.

Charging ends earlier than time set in [Departure time]

Charging end time does not match estimated end time due to condition of power source or outside temperature

If sudden changes in temperature or changes in the condition of the power source occur while charging, charging may end earlier than the time estimated by the system.

Charging is not complete, even though it is time set in [Departure time]

Charging end time does not match estimated end time due to condition of power source or outside temperature

If sudden changes in temperature or changes in the condition of the power source occur while charging, charging may end earlier than the time estimated by the system.

Charging does not start, even though it is time set in [Start at set time]

AC charging cable was connected after set time

Connect the AC charging cable before the time set in **[Start at set time]**.

When the wireless charger operation indicator light (on the charging tray) flashes*

When the wireless charger indicator light continuously flashes once per second (orange / green)

Cause	Remedy
Poor communication between the vehicle and wireless charger.	If the hybrid system is operating, stop the hybrid system and then restart it. If the power switch is in ACC, start the hybrid system.

When the wireless charger indicator light continuously flashes 3 times quickly (orange)

Cause	Remedy
<p>The following causes are possible.</p> <ul style="list-style-type: none"> ● Foreign matter detected: If a metallic foreign object is detected in the charge area, the overheat prevention function of the charging coil will operate ● Portable device not aligned correctly: If the charging coil of a portable device is not properly positioned on the charging area, the overheat prevention function of the charging coil will operate 	<ul style="list-style-type: none"> ● Remove the foreign object from the charge area. ● Remove the portable device from the charging tray, check that the operation indicator light changes back to green, and then place the portable device so that it is near the center of the charging tray. Also, if a case or cover is installed to the portable device, remove it.

When the wireless charger indicator light continuously flashes 4 times quickly (orange)

Cause	Remedy
The temperature inside the wireless charger may have become too high.	Stop charging, remove the portable device from the charging tray, and wait for the temperature to decrease before attempting to begin charging again.

*: If equipped

When a hybrid system warning message is displayed and the vehicle does not move

There may be a problem with the drivetrain.

Contact your Lexus dealer or commercial towing service before towing.

If the hybrid transmission makes abnormal sounds

There may be a problem with the drivetrain.

Contact your Lexus dealer or commercial towing service before towing.

Towing with a tow truck

⚠ NOTICE

■ To prevent damage to the vehicle when towing using a wheel-lift type truck

- Do not tow the vehicle from the rear when the power switch is off. The steering lock mechanism is not strong enough to hold the front wheels straight.
- When raising the vehicle, ensure adequate ground clearance for towing at the opposite end of the raised vehicle. Without adequate clearance, the vehicle could be damaged while being towed.

Towing with a tow truck

If towing is necessary, we recommend having your vehicle towed by your Lexus dealer or a commercial towing service, using a wheel-lift type truck or flatbed truck. Use a safety chain system for all towing, and abide by all state/provincial and local laws.

⚠ WARNING

Be sure to transport the vehicle with all four wheels raised off the ground. If the vehicle is towed with the tires contacting the ground, the drivetrain or related parts may be damaged, the vehicle may fly off the truck, or electricity generated by the operation of the motor may cause a fire to occur depending on the nature of the damage or malfunction.

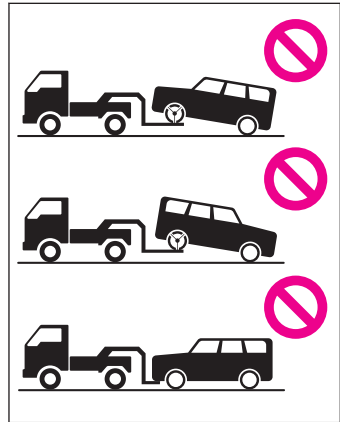

⚠ NOTICE

■ Towing with a sling-type truck

Do not tow with a sling-type truck to prevent body damage.

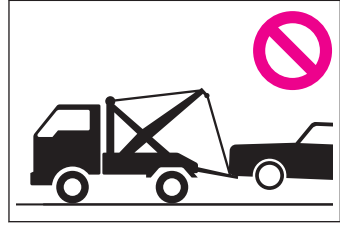

► **From the front**

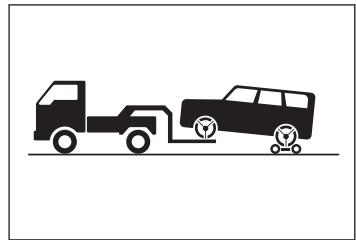

Use a towing dolly under the rear wheels.

► **From the rear**

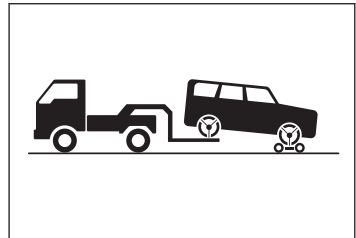

Use a towing dolly under the front wheels.

9-10. If the vehicle cannot move

Using a flatbed truck

When using a flat-bed truck to transport the vehicle, use tire strapping belts. Refer to the owner's manual of the flat-bed truck for the tire strapping method.

In order to suppress vehicle movement during transportation, set the parking brake and turn the power switch off.

Towing with another vehicle

If towing is necessary, we recommend having your vehicle towed by your Lexus dealer or a commercial towing service, using a wheel-lift type truck or flatbed truck. Use a safety chain system for all towing, and abide by all state/provincial and local laws.

Emergency towing (vehicles with towing eyelet)

If a tow truck is not available in an emergency, your vehicle may be temporarily towed using cables or chains secured to the emergency towing eyelets. This should only be attempted on hard surfaced roads for short distances at under 18 mph (30 km/h).

A driver must be in the vehicle to steer and operate the brakes. The vehicle's wheels, drive train, axles, steering and brakes must be in good condition.

Situations when it is not possible to be towed by another vehicle (vehicles with towing eyelet)

In the following situations, it is not possible to be towed by another vehicle using cables or chains, as the front wheels may be locked due to the parking lock.

Contact your Lexus dealer or commercial towing service.

- There is a malfunction in the shift control system.
- There is a malfunction in the immobilizer system.
- There is a malfunction in the smart access system with push-button start.
(→ P.673)
- The 12-volt battery is discharged.

Related Links

[Changing the power switch mode\(P. 184\)](#)

[If a warning message is displayed\(P. 651\)](#)

[Enable the immobilizer system\(P. 126\)](#)

[If the vehicle 12-volt battery is discharged\(P. 675\)](#)

Emergency towing procedure (vehicles with towing eyelet)

To have your vehicle towed by another vehicle, the towing eyelet must be installed to your vehicle. Install the towing eyelet using the following procedure.

9-10. If the vehicle cannot move

⚠ WARNING

Do not perform any of the following as doing so may cause the parking lock mechanism to engage, locking the front wheels and possibly leading to an accident resulting in death or serious injury:

- Unfasten the driver's seat belt and open the driver's door.
- Turn the power switch off.

1 Take out the flathead screwdriver and towing eyelet.

2 Remove the eyelet cover using a flathead screwdriver.

To protect the bodywork, place a rag between the screwdriver and the vehicle body as shown in the illustration.

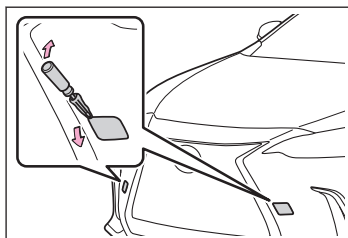

3 Insert the towing eyelet into the hole and tighten partially by hand.

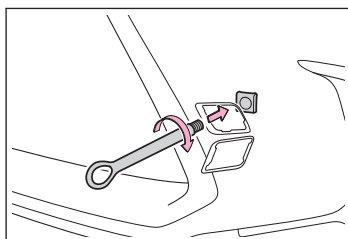

4 Tighten down the towing eyelet securely using a wheel bolt wrench or hard metal bar.

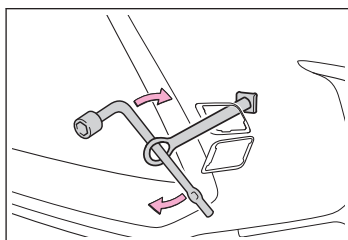

📄 INFORMATION

■ Wheel bolt wrench

Wheel bolt wrench can be purchased at your Lexus dealer.

⚠ WARNING

When installing towing eyelets to the vehicle, make sure to securely install them to the specified positions.

⚠ WARNING

If not securely installed, towing eyelets may come loose during towing.

5 Securely attach cables or chains to the towing eyelet.

Take care not to damage the vehicle body.

⚠ NOTICE

To prevent damage to the vehicle during emergency towing, do not secure cables or chains to the suspension components.

6 Enter the vehicle being towed and start the hybrid system.

If the hybrid system does not start, turn the power switch to ON.

📄 INFORMATION**■ While towing**

If the hybrid system is off, the power assist for the brakes and steering will not function, making steering and braking more difficult.

⚠ WARNING

Do not turn the power switch off while towing the vehicle with another vehicle. This may lead to an accident as the front wheels will be locked by the parking lock.

7 Shift the shift position to N and release the parking brake.

Turn auto mode of the parking brake off.

⚠ WARNING

When towing, avoid sudden starts, etc., which place excessive stress on the towing eyelets, cables or chains. The towing eyelets, cables or chains may become damaged, broken debris may hit people, and cause serious damage.

Getting unstuck from mud, sand, or snow

- 1 Stop the hybrid system. Set the parking brake and shift the shift position to P.
- 2 Remove the mud, snow or sand from around the front wheels.
- 3 Place wood, stones or some other material under the front wheels to help provide traction.
- 4 Restart the hybrid system.
- 5 Shift the shift position to D or R and release the parking brake. Then, while exercising caution, depress the accelerator pedal.

WARNING

- When shifting the shift lever, do not shift it with the accelerator pedal depressed. Doing so may lead to unexpected rapid acceleration of the vehicle that may cause an accident.
- If you choose to push the vehicle back and forth to free it, make sure the surrounding area is clear to avoid striking other vehicles, objects or people. The vehicle may also lunge forward or lunge back suddenly as it becomes free. Use extreme caution.

NOTICE

Avoid spinning the front wheels and depressing the accelerator pedal more than necessary.

Doing so may damage the hybrid transmission and other components.

- 6 If it is difficult to free the vehicle, press the  switch and turn the TRAC off. If the vehicle remains stuck even after these procedures are performed, the vehicle may require towing to be freed.

If a vehicle abnormality is found

The following symptoms are abnormal.

- Fluid leaks under the vehicle

Water dripping from the air conditioning after use is normal.

- Flat-looking tires or uneven tire wear

- High engine coolant temperature warning light comes on.

Contact your Lexus dealer as soon as possible. Your vehicle probably needs adjustment or repair.

If abnormal sounds are emitted from the vehicle

Condition	Remedy
<p>The following sounds are abnormal sounds.</p> <ul style="list-style-type: none">● Changes in exhaust sound● Excessive tire squeal when cornering● Strange noises related to the suspension system● Pinging or other noises related to the hybrid system	<p>Contact your Lexus dealer as soon as possible. Your vehicle probably needs adjustment or repair.</p>

If the vehicle behaves abnormally

The following symptoms are abnormal.

- Engine misfiring or misses, stumbling or running roughly
- Appreciable loss of power
- Vehicle pulls heavily to one side when braking
- Vehicle pulls heavily to one side when driving on a level road
- Loss of brake effectiveness, spongy feeling, pedal almost touches the floor

Contact your Lexus dealer as soon as possible. Your vehicle probably needs adjustment or repair.

The steering wheel cannot be turned after the hybrid system is stopped

It is locked automatically to prevent theft of the vehicle.

- When the steering lock cannot be released, **"Push Power Switch while Turning Steering Wheel in Either Direction"** will be displayed on the multi-information display. Check that the shift position is in P. Press the power switch while turning the steering wheel left and right.

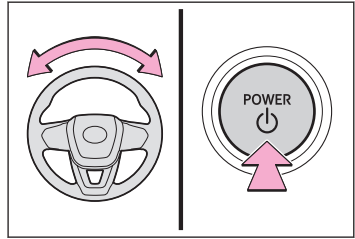

- To prevent the steering lock motor from overheating, operation of the motor may be suspended if the hybrid system is turned on and off repeatedly in a short period of time. In this case, refrain from operating the hybrid system. After about 10 seconds, the steering lock motor will resume functioning.

Related Links

[Changing the power switch mode\(P.184\)](#)

If the windows do not open or close by operating the power window switches

Check if the window lock switch is on.

If the window lock switch is on, the power windows other than that for the driver's seat cannot be operated.

Turn the window lock switch off.

- **When the jam protection function or catch protection function operates unusually and the side window cannot be opened or closed, perform the following operations with the power window switch of that door.**
 - Stop the vehicle. With the power switch in ON, within 4 seconds of the jam protection function or catch protection function activating, continuously operate the power window switch in the one-touch closing direction or one-touch opening direction so that the door window can be opened and closed.
 - If the door window cannot be opened and closed even when performing the above operations, perform the procedure for function initialization.

— Related Links —

[Functions which aid in safe opening and closing of the windows\(P. 157\)](#)

[Operations using the power window switches\(P. 158\)](#)

[Prevent accidental operation of the windows\(P. 159\)](#)

Initializing the jam protection function/catch protection function

- 1 Turn the power switch to ON.
- 2 Pull and hold the power window switch in the one-touch closing direction and completely close the side window.
- 3 Release the power window switch for a moment, resume pulling the switch in the one-touch closing direction, and hold it there for approximately 6 seconds or more.
- 4 Press and hold the power window switch in the one-touch opening direction. After the side window is completely opened, continue holding the switch for an additional 1 second or more.
- 5 Release the power window switch for a moment, resume pushing the switch in the one-touch opening direction, and hold it there for approximately 4 seconds or more.

- 6 Pull and hold the power window switch in the one-touch closing direction again. After the side window is completely closed, continue holding the switch for a further 1 second or more.

If you release the switch while the window is moving, start again from the beginning.

If the window reverses and cannot be fully closed or opened, have the vehicle inspected by your Lexus dealer.

Related Links

[Functions which aid in safe opening and closing of the windows\(P. 157\)](#)

[Operations using the power window switches\(P. 158\)](#)

The power switch is turned off automatically

In the following situations, power will be turned off due to the automatic power off function.

- The vehicle is left in ACC or ON (the hybrid system is not operating) for more than 20 minutes with the shift position in P.
- The 12-volt battery is low with the shift position is in P and the power switch is in ACC or ON (the hybrid system is not operating).

Next time when starting the hybrid system, operate the hybrid system for approximately 5 minutes to recharge the 12-volt battery.

Do not leave the vehicle with the power switch in ACC or ON for long periods of time when the hybrid system is not operating.

If your vehicle overheats

The following may indicate that your vehicle is overheating.

- The high coolant temperature warning light comes on.
- A loss of hybrid system power is experienced. (For example, the vehicle speed does not increase.)
- "Engine Coolant Temp High Stop in a Safe Place See Owner's Manual" is displayed on the multi-information display.
- "Hybrid System Overheated Output Power Reduced" is displayed on the multi-information display.
- Steam comes out from under the hood.

Related Links

["Hybrid System Overheated Output Power Reduced"\(P. 653\)](#)

The high coolant temperature warning light comes on or "Engine Coolant Temp High Stop in a Safe Place See Owner's Manual" is displayed on the multi-information display

- 1 Stop the vehicle in a safe place, turn off the air conditioning system, and stop the hybrid system.

▲ WARNING

After turning the hybrid system off, check that the "READY" indicator is off.

When the hybrid system is operating, the gasoline engine may automatically start, or the cooling fan may suddenly operate even if the gasoline engine is stopped.

Also, it may operate for several minutes even after the power switch is turned off.

Do not touch or approach rotating parts such as the fan, which may lead to fingers or clothing (especially a tie, a scarf or a muffler) getting caught, resulting in serious injury.

- 2 If you do not see steam, carefully lift the hood.

If you see steam, carefully lift the hood after the steam subsides.

▲ WARNING

When opening the hood, observe the following precautions.

- If steam is seen coming from under the hood, do not open the hood until the steam has subsided. The engine compartment may be very hot.

⚠ WARNING

- Do not loosen the radiator cap and the coolant reservoir cap while the hybrid system and radiator are hot. High temperature steam or coolant could spray out.

3 After the hybrid system has cooled down sufficiently, inspect the hoses and radiator core (radiator) for any leaks.

If a large amount of coolant has leaked, immediately contact your Lexus dealer.

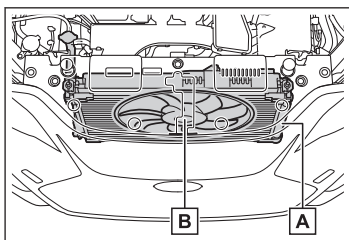

- A Radiator
- B Cooling fan

4 Check that the coolant level is between the [FULL] and [LOW] lines on the reservoir.

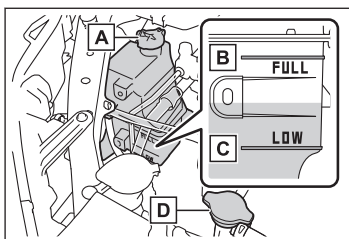

- A Reservoir
- B [FULL] line
- C [LOW] line
- D Radiator cap

5 Add coolant if necessary.

Water can be used in an emergency if coolant is unavailable.

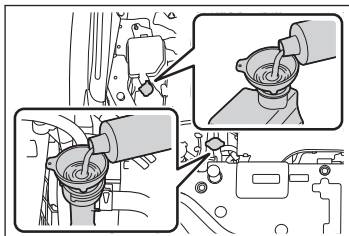
**⚠ NOTICE**

■ When adding engine/power control unit coolant



Add coolant slowly after the hybrid system has cooled down sufficiently.

NOTICE

Adding cool coolant to a hot hybrid system too quickly can cause damage to the hybrid system.

To prevent damage to the cooling system

Observe the following precautions:

-  Avoid contaminating the coolant with foreign matter (such as sand, dust, etc.).
-  Do not use coolant additives.

- 6 Start the hybrid system and turn the air conditioning system on to check that the radiator cooling fan operate and to check for coolant leaks from the radiator or hoses.**

The fan operates when the air conditioning system is turned on immediately after a cold start.

Confirm that the fan is operating by checking the fan sound and air flow. If it is difficult to check these, turn the air conditioning system on and off repeatedly. (The fan may not operate in freezing temperatures.)

- 7 If the fan is not operating: Stop the hybrid system immediately and contact your Lexus dealer.**

If the fan is operating: Have the vehicle inspected at the nearest Lexus dealer.

- 8 Check if "Engine Coolant Temp High Stop in a Safe Place See Owner's Manual" is displayed on the multi-information display.**

If the message does not disappear: Stop the hybrid system and contact your Lexus dealer.

If the message is not displayed: Have the vehicle inspected at the nearest Lexus dealer.

If electrical components cannot be used or do not operate when a switch is operated

If any of the electrical components do not operate, a fuse may have blown.

If this happens, check and replace the fuses as necessary.

Related Links

[Checking and replacing fuses\(P. 734\)](#)

If a light does not illuminate

The following may be the cause:

- The 12-volt battery may be discharged.
- One or both of the 12-volt battery terminals may be disconnected.
- A fuse may have blown. Check the fuses.

Contact your Lexus dealer if the problem cannot be repaired, or if repair procedures are unknown.

INFORMATION

■ Condensation build-up on the inside of a lens

Temporary condensation build-up on the inside of the headlight lens does not indicate a malfunction. Contact your Lexus dealer for more information in the following situations:

- Large drops of water have built up on the inside of the lens.
- Water has built up inside the headlight.

Checking and replacing fuses

WARNING

Observe the following precautions. Failure to do so may cause damage to the vehicle, possibly leading to a fire or injury.

- Never use a fuse of a higher amperage rating than specified, or use any other object in place of a fuse.
- Always use a genuine Lexus fuse or equivalent. Never replace a fuse with a wire, even as a temporary fix.
- Do not modify the fuses or fuse boxes.
- Never check or replace the fuses in the fuse box near the inverter with converter assembly, as there are high voltage parts and wiring near the fuse box.

Doing so may cause electric shock, resulting in death or serious injury.

NOTICE

Have the cause of electrical overload determined and repaired by your Lexus dealer as soon as possible.

- 1 Turn the power switch off.
- 2 Open the fuse box cover.

► Engine compartment (Type A)

Push in the claw and remove the lid.

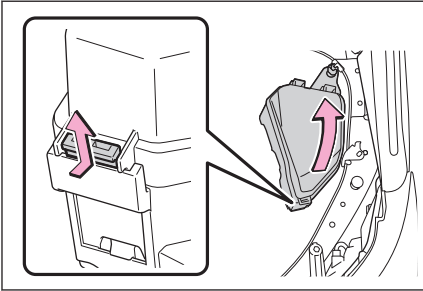

► Engine compartment (Type B)

Push in the claw and remove the lid.

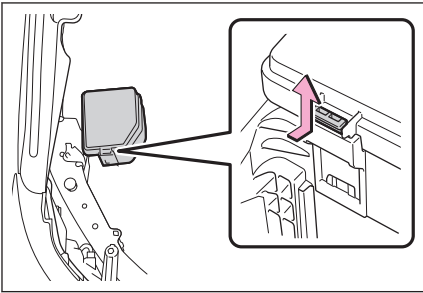

► Left side instrument panel

Remove the lid.

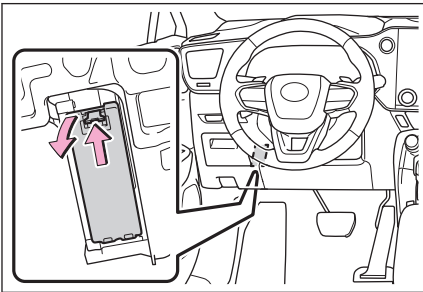

► Luggage compartment (Type A)

Fold the deck board, remove the side board and cover, then remove the fuse box cover.

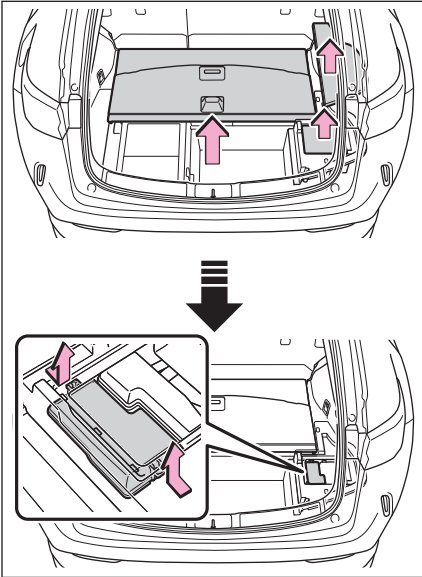

► **Luggage compartment (Type B)**

Fold the deck board, remove the side board and cover, then remove the fuse box cover.

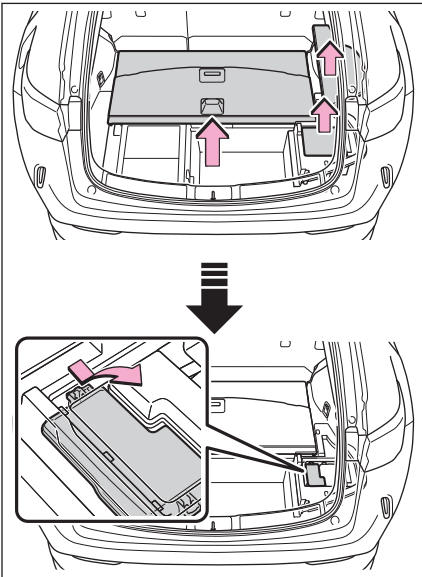

3 Remove the fuse.

Only some fuses can be removed using the pullout tool.

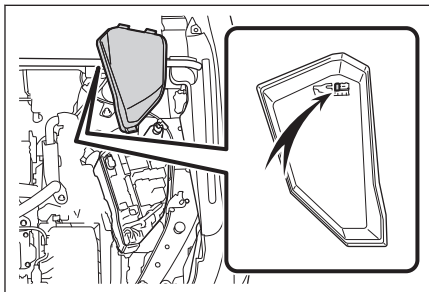

4 Check if the fuse is blown.

Replace the blown fuse with a new fuse of an appropriate amperage rating. The amperage rating can be found on the fuse box lid.

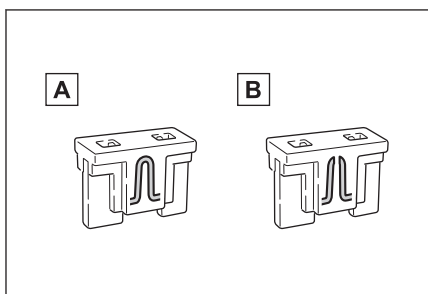

A Normal fuse

B Blown fuse

INFORMATION

■ After a fuse is replaced

- When installing the lid, make sure to engage the claw securely.
- If the lights do not turn on even after the fuse has been replaced, a bulb may need replacement.
- If the replaced fuse blows again, have the vehicle inspected by your Lexus dealer.

■ If a circuit is overloaded

The fuses are designed to blow, protecting the wiring harness from damage.

■ When replacing light bulbs

Lexus recommends that you use genuine Lexus products designed for this vehicle.

Because certain bulbs are connected to circuits designed to prevent overload, non-genuine parts or parts not designed for this vehicle may be unusable.

Light bulbs

The difficulty level of replacement varies depending on the bulb. If necessary bulb replacement seems difficult to perform, contact your Lexus dealer. For more information about replacing other light bulbs, contact your Lexus dealer.

■ Replacing the following bulbs

If any of the lights listed below has burnt out, have it replaced by your Lexus dealer.

- Headlight
- Front position lights and daytime running lights
- Front turn signal lights (LED type)
- Side turn signal lights
- Front side marker lights
- Front fog lights
- Cornering lights*
- Stop/tail lights
- Rear side marker lights
- Back-up light
- Rear turn signal light
- High mounted stoplight
- License plate lights

INFORMATION

■ LED Lights

The lights other than the front turn signal lights (bulb type) each consist of a number of LEDs. If any of the LEDs burn out, take your vehicle to your Lexus dealer to have the light replaced.

WARNING

Observe the following precautions related to replacing the bulbs.

- Turn off the lights. Do not attempt to replace the bulb immediately after turning off the lights. The bulbs become very hot and may cause burns.
- Do not touch the glass portion of the light bulb with bare hands. When it is unavoidable to hold the glass portion, use and hold with a clean dry cloth to avoid getting moisture and oils on the bulb. Also, if the bulb is scratched or dropped, it may blow out or crack.

*: If equipped

⚠ WARNING

- Fully install light bulbs and any parts used to secure them. Failure to do so may result in heat damage, fire, or water entering the headlight unit. This may damage the headlights or cause condensation to build up on the lens.
- Do not attempt to repair or disassemble the light bulbs, connectors, electric circuits or related parts.
Doing so may result in electric shock leading to death or serious injury.
- To prevent damage or fire, make sure the bulbs are fully installed and securely locked into each light unit.
- Check the wattage of the bulb before installing it to prevent heat damage.

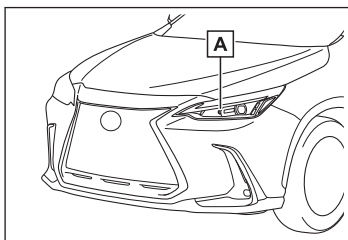
Bulb locations

A Front turn signal light (bulb type)

Replacing the front turn signal lights (bulb type)

Before replacing, check the wattage of the light bulb to be replaced.

- 1 Turn the bulb base counterclockwise.

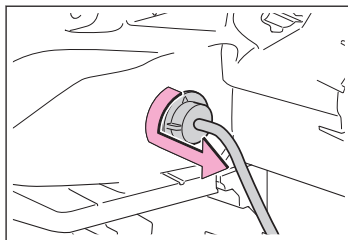

- 2 Remove the light bulb.

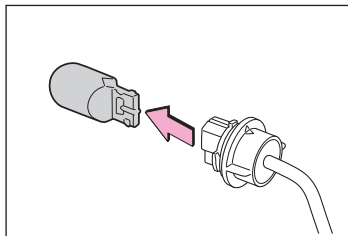

- 3** Install a new light bulb then install the bulb base to the light unit by inserting it and turning the bulb base clockwise.

After installing the light bulb, turn on the front turn signal light to visually check that there is no light leaking from the bulb base.

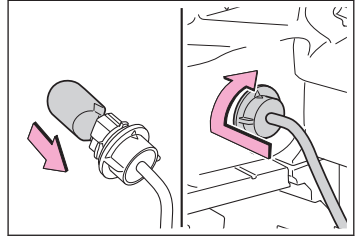

10-1. Specifications

Maintenance data (fuel, oil level, etc.).....	742
Fuel information	750
Tire information	753

10-2. Customizable features

User customization function outline.....	763
Method to change settings .	764
Customizable features.....	765

10-3. Initialization

Items to initialize	783
---------------------------	-----

10-1. Specifications

Maintenance data (fuel, oil level, etc.)

Dimensions and weight

Overall length	183.5 in. (4660 mm)	
Overall width	73.4 in. (1865 mm)	
Overall height ⁽¹⁾	65.4 in. (1660 mm) ⁽²⁾ 65.7 in. (1670 mm) ⁽³⁾	
Wheelbase	105.9 in. (2690 mm)	
Tread	Front	63.2 in. (1605 mm)
	Rear	64.0 in. (1625 mm)
Vehicle capacity weight (Occupants + luggage)	895 lb. (405 kg)	
Trailer Weight Rating ⁽⁴⁾ (Trailer weight + cargo weight)	2000 lb. (910 kg)	

(1) Unladen vehicle

(2) Vehicles with 235/60R18 tires

(3) Vehicles with 235/50R20 tires

(4) Vehicles with towing package

Seating capacity

Seating capacity	5 (Front 2, Rear 3)
------------------	---------------------

Vehicle identification

■ Vehicle identification number

The vehicle identification number (VIN) is the legal identifier for your vehicle. This is the primary identification number for your Lexus. It is used in registering the ownership of your vehicle.

- This number is stamped on the top left of the instrument panel.

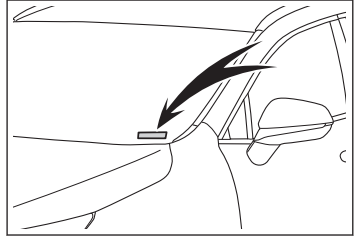

- This number is also on the Certification Label.

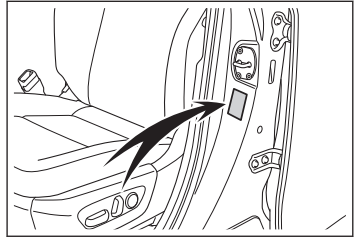

- On some models, this number is also stamped under the right-hand front seat.

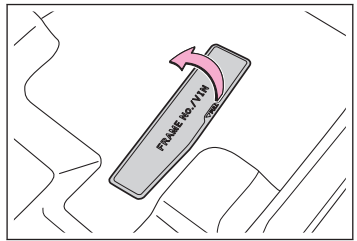

■ Engine number

The engine number is stamped on the engine block as shown.

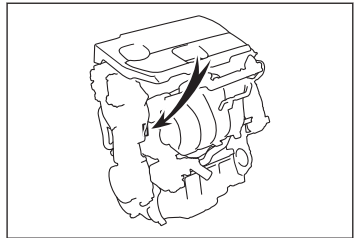

Engine

Model	2.5 L 4-cylinder (A25A-FXS)
Type	4-cylinder in line, 4-cycle, gasoline
Bore and stroke	3.44 × 4.07 in. (87.5 × 103.4 mm)

10-1. Specifications

Displacement	151.8 cu. in. (2487 cm ³)
Valve clearance (engine cold)	Automatic adjustment

Fuel

Fuel type	Unleaded gasoline only
Octane Rating	91 (Research Octane Number 96) or higher [recommended] 87 (Research Octane Number 91) or higher [minimum]
Fuel tank capacity (Reference)	14.5 gal. (55.0 L, 12.1 Imp. gal.)

Electric motor (traction motor)

► Front

Type	Permanent magnet synchronous motor
Maximum output	134 kW
Maximum torque	199.1 ft•lbf (270 N•m, 27.5 kgf•m)

► Rear (AWD models)

Type	Permanent magnet synchronous motor
Maximum output	40 kW
Maximum torque	89.2 ft•lbf (121 N•m, 12.3 kgf•m)

Hybrid battery (traction battery)

Type	Lithium-ion battery
Voltage	3.7 V/cell
Capacity	51 Ah
Quantity	96 cells
Nominal voltage	355 V

Lubrication system

Oil capacity (Drain and refill) (Reference)*1

With filter	4.8 qt. (4.5 L, 4.0 Imp. qt.)
Without filter	4.4 qt. (4.2 L, 3.7 Imp. qt.)

Engine oil selection

"Toyota Genuine Motor Oil" is used in your Lexus vehicle. Use Lexus approved "Toyota Genuine Motor Oil" or equivalent to satisfy the following grade and viscosity.

Oil grade: ILSAC GF-6B multigrade engine oil

Recommended viscosity: SAE OW-16

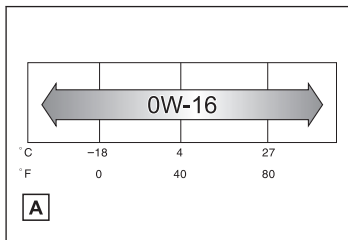

A Outside temperature

SAE OW-16 is the best choice for good fuel economy and good starting in cold weather. If SAE OW-16 is not available, SAE OW-20 oil may be used. However, it must be replaced with SAE OW-16 at the next oil change.

How to read oil container label

API registered mark is added to some oil containers to help you select the oil you should use.

Oil viscosity (OW-16 is explained here as an example):



- The OW in OW-16 indicates the characteristic of the oil which allows cold startability.

Oils with a lower value before the W allow for easier starting of the engine in cold weather.

*1: The engine oil capacity is a reference quantity to be used when changing the engine oil. Warm up the engine and turn off the hybrid system, wait more than 5 minutes, and check the oil level on the dipstick.

10-1. Specifications

- The 16 in 0W-16 indicates the viscosity characteristic of the oil when the oil is at high temperature.

An oil with a higher viscosity (one with a higher value) may be better suited if the vehicle is operated at high speeds, or under extreme load conditions.

Cooling system

Capacity ⁽¹⁾	Gasoline engine	8.7 qt. (8.2 L, 7.2 Imp. qt.)
	Power control unit	2.1 qt. (2.0 L, 1.6 Imp. qt.)
Coolant type	Use either of the following: <ul style="list-style-type: none">● "Toyota Super Long Life Coolant"● Similar high-quality ethylene glycol-based non-silicate, non-amine, non-nitrite, and non-borate coolant with long-life hybrid organic acid technology Do not use plain water alone.	

(1) The coolant capacity is a reference quantity. If replacement is necessary, contact your Lexus dealer.

Ignition system (spark plug)

Make	DENSO FC16HR-Q8
Gap	0.03 in. (0.8 mm)

NOTICE

Iridium-tipped spark plugs

Use only iridium-tipped spark plugs. Do not adjust the spark plug gap.

Electrical system

■ 12-volt battery

Open voltage at 68°F (20°C):	12.0 V or higher (Turn the power switch off and turn on the high beam headlights for 30 seconds.)
------------------------------	--

■ Charging rates

Quick charge	15 A max.
Slow charge	5 A max.

Hybrid transmission

Fluid capacity ⁽¹⁾	4.7 qt. (4.4 L, 3.9 Imp. qt.)
Fluid type	"Toyota Genuine ATF WS"

(1) The fluid capacity is a reference quantity. If replacement is necessary, contact your Lexus dealer.

⚠ NOTICE

■ Hybrid transmission fluid type

Using transmission fluid other than the above type may cause abnormal noise or vibration, or ultimately damage the transmission of your vehicle.

Rear differential (Rear electric motor)

Oil capacity ⁽¹⁾	1.8 qt. (1.7 L, 1.5 Imp. qt.)
Oil type and viscosity	"Toyota Genuine ATF WS"

(1) The oil capacity is a reference quantity.
If replacement is necessary, contact your Lexus dealer.

⚠ NOTICE

■ Transmission fluid type

Using differential gear oil other than the specified oil may cause abnormal noise or vibration, or damage the differential gear of your vehicle.

Brakes

10-1. Specifications

Pedal clearance (1)	5.0 in. (128 mm)
Brake pad wear limit	0.04 in. (1.0 mm)
Pedal free play	0.04 - 0.25 in. (1 - 6 mm)
Fluid type	● FMVSS No. 116 DOT 3 or SAE J1703 ● FMVSS No. 116 DOT 4 or SAE J1704

(1) Minimum pedal clearance when depressed with a force of 67.5 lbf (300 N, 30.6 kgf) while the engine is running.

Steering

Free play	Less than 1.2 in. (30 mm)
-----------	---------------------------

Tires and wheels

► Type A

Tire size	235/60R18 103H
Tire inflation pressure (Recommended cold tire inflation pressure)	Front: 33 psi (230 kPa, 2.3 kgf/cm ² or bar) Rear: 33 psi (230 kPa, 2.3 kgf/cm ² or bar) Driving at high speeds (above 100 mph [160 km/h]) (in countries where such speeds are permitted by law) Add 3 psi (20 kPa, 0.2 kgf/cm ² or bar) to the front and rear tires. Never exceed the maximum cold tire inflation pressure indicated on the tire sidewall.
Wheel size	18 × 7 1/2 J
Wheel bolt torque	103 ft•lbf (140 N•m, 14.3 kgf•m)

► Type B

Tire size	235/50R20 100V
-----------	----------------

Tire inflation pressure (Recommended cold tire inflation pressure)	<p>Front: 33 psi (230 kPa, 2.3 kgf/cm² or bar)</p> <p>Rear: 33 psi (230 kPa, 2.3 kgf/cm² or bar)</p> <p>Driving at high speeds (above 100 mph [160 km/h]) (in countries where such speeds are permitted by law)</p> <p>Add 6 psi (40 kPa, 0.4 kgf/cm² or bar) to the front and rear tires. Never exceed the maximum cold tire inflation pressure indicated on the tire sidewall.</p>
Wheel size	20 × 7 1/2 J
Wheel bolt torque	103 ft•lbf (140 N•m, 14.3 kgf•m)

Light bulbs

	Light bulbs	Bulb No.	W	Type
Exterior	Front turn signal lights (bulb type)	WY21W	21	A

A: Wedge base bulbs (amber)

Fuel information

You must only use unleaded gasoline in your vehicle.

Recommended to use premium unleaded gasoline with octane rating of 91 (Research Octane Number of 96) or higher for optimum engine performance. You may use unleaded gasoline with octane rating as low as 87 (Research Octane Number of 91). In this case, engine performance may be decreased.

Use of unleaded gasoline with an octane rating lower than 87 may result in engine knocking. Persistent knocking can lead to engine damage.

At minimum, the gasoline you use should meet the specifications of ASTM D4814 in the U.S.A.

INFORMATION

■ Gasoline quality

In very few cases, driveability problems may be caused by the brand of gasoline you are using. If driveability problems persist, try changing the brand of gasoline. If this does not correct the problem, consult your Lexus dealer.

■ Recommendation of the use of gasoline containing detergent additives

- Lexus recommends the use of gasoline that contains detergent additives to avoid the build-up of engine deposits.
- All gasoline sold in the U.S.A. contains minimum detergent additives to clean and/or keep clean intake systems, per EPA's lowest additives concentration program.
- Lexus strongly recommends the use of Top Tier Detergent Gasoline. For more information on Top Tier Detergent Gasoline and a list of marketers, please go to the official website www.toptiergas.com.

■ Recommendation of the use of low emissions gasoline

Gasolines containing oxygenates such as ethers and ethanol, as well as reformulated gasolines, are available in some cities. These fuels are typically acceptable for use, providing they meet other fuel requirements.

Lexus recommends these fuels, since the formulations allow for reduced vehicle emissions.

■ Non-recommendation of the use of blended gasoline

- Use only gasoline containing up to 15% ethanol. DO NOT use any flex-fuel or gasoline that could contain more than 15% ethanol, including from any pump labeled E30 (30% ethanol **A**), E50 (50% ethanol **B**), E85 (85% ethanol **C**) (which are only some examples of fuel containing more than 15% ethanol).

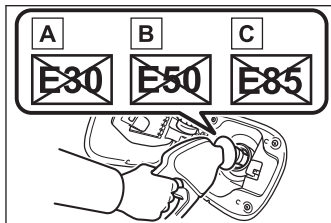

- If you use gasohol in your vehicle, be sure that it has an octane rating no lower than 87.
- Lexus does not recommend the use of gasoline containing methanol.

■ Non-recommendation of the use of gasoline containing MMT

Some gasoline contains an octane enhancing additive called MMT (Methylcyclopentadienyl Manganese Tricarbonyl).

Lexus does not recommend the use of gasoline that contains MMT. If fuel containing MMT is used, your emission control system may be adversely affected.

The malfunction indicator lamp on the instrument cluster may come on. If this happens, contact your Lexus dealer for service.

■ If your engine knocks

- Consult your Lexus dealer.
- You may occasionally notice light knocking for a short time while accelerating or driving uphill. This is normal and there is no need for concern.

⚠ NOTICE

■ Notice on fuel quality

- Do not use improper fuels. If improper fuels are used, the engine will be damaged.
- Do not use leaded gasoline.

Leaded gasoline can cause damage to your vehicle's three-way catalytic converters causing the emission control system to malfunction.

- Do not use gasohol other than the type previously stated.

Other gasohol may cause fuel system damage or vehicle performance problems.

- Using unleaded gasoline with an octane number or rating lower than the level previously stated will cause persistent heavy knocking.

At worst, this will lead to engine damage.

■ Fuel-related poor driveability

If poor driveability (poor hot starting, vaporization, engine knocking, etc.) is encountered after using a different type of fuel, discontinue the use of that type of fuel.

 **NOTICE**

 **When refueling with gasohol**

Take care not to spill gasohol. It can damage your vehicle's paint.

Tire information

Typical tire symbols

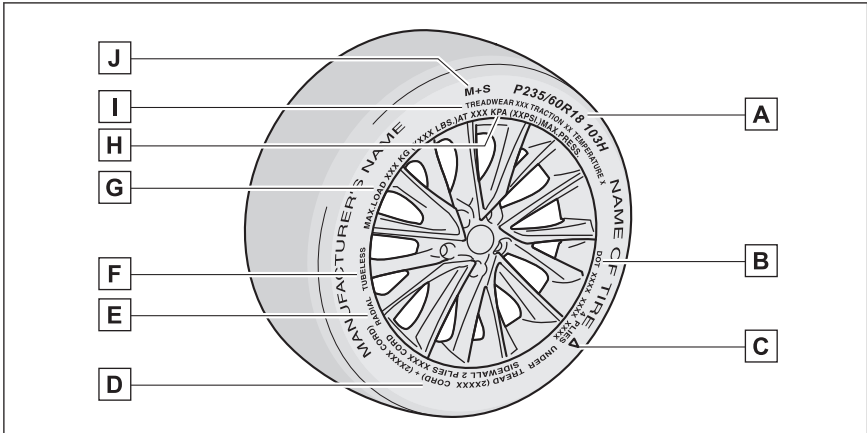

- A Tire size
- B DOT and Tire Identification Number (TIN)
- C Location of treadwear indicators
- D Tire ply composition and materials

Ply is layers of rubber-coated parallel cords. Cords are the strands which form the plies in a tire.

- E Radial tires or bias-ply tires

A radial tire has **[RADIAL]** on the sidewall. A tire not marked **[RADIAL]** is a bias-ply tire.

- F TUBELESS or TUBE TYPE

A tubeless tire does not have a tube and air is directly put into the tire. A tube type tire has a tube inside the tire and the tube maintains the air pressure.

- G Load limit at maximum cold tire inflation pressure
- H Maximum cold tire inflation pressure

This means the pressure to which a tire may be inflated.

- I Uniform tire quality grading

For details, see [Uniform Tire Quality Grading](#)(→ P.755) that follows.

- J Summer tires or all season tires

An all season tire has **[M+S]** on the sidewall. A tire not marked **[M+S]** is a summer tire.

Typical DOT and Tire Identification Number (TIN)

► Type A

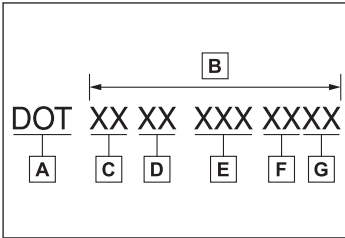

- A DOT symbol*¹
- B Tire Identification Number (TIN)
- C Tire manufacturer's identification mark
- D Tire size code
- E Manufacturer's optional tire type code (3 or 4 letters)
- F Manufacturing week
- G Manufacturing year

► Type B

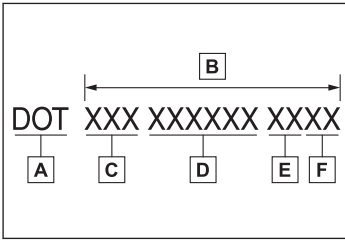

- A DOT symbol*¹
- B Tire Identification Number (TIN)
- C Tire manufacturer's identification mark
- D Manufacturer's code
- E Manufacturing week
- F Manufacturing year

Tire size

■ Typical tire size information

The illustration indicates typical tire size.

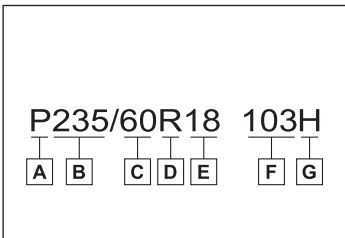

- A Tire use
(P = Passenger car, T = Temporary use)
- B Section width (millimeters)
- C Aspect ratio (tire height to section width)
- D Tire construction code
(R = Radial, D = Diagonal)
- E Wheel diameter (inches)
- F Load index (2 digits or 3 digits)
- G Speed symbol (alphabet with one letter)

*1: The DOT symbol certifies that the tire conforms to applicable Federal Motor Vehicle Safety Standards.

■ Tire dimensions

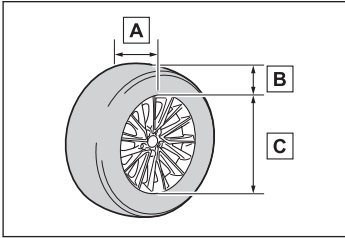

- A Section width
- B Tire height
- C Wheel diameter

Tire section names

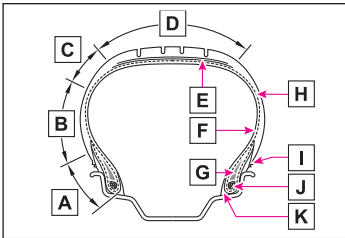

- A Bead
- B Sidewall
- C Shoulder
- D Tread
- E Belt
- F Inner liner
- G Reinforcing rubber
- H Carcass
- I Rim lines
- J Bead wires
- K Chafer

Uniform Tire Quality Grading

This information has been prepared in accordance with regulations issued by the National Highway Traffic Safety Administration of the U.S. Department of Transportation.

It provides the purchasers and/or prospective purchasers of Lexus vehicles with information on uniform tire quality grading.

Your Lexus dealer will help answer any questions you may have as you read this information.

■ DOT quality grades

All passenger vehicle tires must conform to Federal Safety Requirements in addition to these grades. Quality grades can be found where applicable on the tire sidewall between tread shoulder and maximum section width.

For example: Treadwear 200 Traction AA Temperature A

■ Treadwear

The treadwear grade is a comparative rating based on the wear rate of the tire when tested under controlled conditions on a specified government test course.

For example, a tire graded 150 would wear one and a half (1 - 1/2) times as well on the government course as a tire graded 100.

The relative performance of tires depends upon the actual conditions of their use, however, and may depart significantly from the norm due to variations in driving habits, service practices and differences in road characteristics and climate.

■ Traction AA, A, B, C

The traction grades, from highest to lowest, are AA, A, B and C, and they represent the tire's ability to stop on wet pavement as measured under controlled conditions on specified government test surfaces of asphalt and concrete.

A tire marked C may have poor traction performance.

Warning: The traction grade assigned to this tire is based on braking (straight ahead) traction tests and does not include cornering (turning) traction.

■ Temperature A, B, C

The temperature grades are A (the highest), B, and C, representing the tire's resistance to the generation of heat and its ability to dissipate heat when tested under controlled conditions on a specified indoor laboratory test wheel.

Sustained high temperature can cause the material of the tire to degenerate and reduce tire life, and excessive temperature can lead to sudden tire failure.

Grade C corresponds to a level of performance which all passenger car tires must meet under the Federal Motor Vehicle Safety Standard No. 109.

Grades B and A represent higher levels of performance on the laboratory test wheel than the minimum required by law.

Warning: The temperature grades for this tire are established for a tire that is properly inflated and not overloaded.

Excessive speed, underinflation, or excessive loading, either separately or in combination, can cause heat buildup and possible tire failure.

Glossary of tire terminology

Tire related term	Meaning
Cold tire inflation pressure	Tire pressure when the vehicle has been parked for three hours or more, or has not been driven more than 1 mile or 1.5 km under that condition
Maximum inflation pressure	The maximum cold inflated pressure to which a tire may be inflated, shown on the sidewall of the tire
Recommended inflation pressure	Cold tire inflation pressure recommended by a manufacturer
Accessory weight	The combined weight (in excess of those standard items which may be replaced) of transmission, power steering, power brakes, power windows, power seats, radio and heater, to the extent that these items are available as factory-installed equipment (whether installed or not)
Curb weight	The weight of a motor vehicle with standard equipment, including the maximum capacity of fuel, oil and coolant, and if so equipped, air conditioning and additional weight optional engine
Maximum loaded vehicle weight	The sum of: (a) Curb weight (b) Accessory weight (c) Vehicle capacity weight (d) Production options weight
Normal occupant weight	150 lb. (68 kg) times the number of occupants specified in the second column of Table 1 ⁽¹⁾ that follows
Occupant distribution	Distribution of occupants in a vehicle as specified in the third column of Table 1 ⁽¹⁾ below

10-1. Specifications

Tire related term	Meaning
Production options weight	The combined weight of installed regular production options weighing over 5 lb. (2.3 kg) in excess of the standard items which they replace, not previously considered in curb weight or accessory weight, including heavy duty brakes, ride levelers, roof rack, heavy duty 12-volt battery, and special trim
Rim	A metal support for a tire or a tire and tube assembly upon which the tire beads are seated
Rim diameter (Wheel diameter)	Nominal diameter of the bead seat
Rim size designation	Rim diameter and width
Rim type designation	The industry manufacturer's designation for a rim by style or code
Rim width	Nominal distance between rim flanges
Vehicle capacity weight (Total load capacity)	The rated cargo and luggage load plus 150 lb. (68 kg) times the vehicle's designated seating capacity
Vehicle maximum load on the tire	The load on an individual tire that is determined by distributing to each axle its share of the maximum loaded vehicle weight, and dividing by two
Vehicle normal load on the tire	The load on an individual tire that is determined by distributing to each axle its share of curb weight, accessory weight, and normal occupant weight (distributed in accordance with Table 1 ⁽¹⁾ below), and dividing by two
Weather side	The surface area of the rim not covered by the inflated tire
Bead	The part of the tire that is made of steel wires, wrapped or reinforced by ply cords and that is shaped to fit the rim
Bead separation	A breakdown of the bond between components in the bead

Tire related term	Meaning
Bias ply tire	A pneumatic tire in which the ply cords that extend to the beads are laid at alternate angles substantially less than 90 degrees to the centerline of the tread
Carcass	The tire structure, except tread and sidewall rubber which, when inflated, bears the load
Chunking	The breaking away of pieces of the tread or sidewall
Cord	The strands forming the plies in the tire
Cord separation	The parting of cords from adjacent rubber compounds
Cracking	Any parting within the tread, sidewall, or innerliner of the tire extending to cord material
CT	A pneumatic tire with an inverted flange tire and rim system in which the rim is designed with rim flanges pointed radially inward and the tire is designed to fit on the underside of the rim in a manner that encloses the rim flanges inside the air cavity of the tire
Extra load tire	A tire designed to operate at higher loads and at higher inflation pressures than the corresponding standard tire
Groove	The space between two adjacent tread ribs
Innerliner	The layer(s) forming the inside surface of a tubeless tire that contains the inflating medium within the tire
Innerliner separation	The parting of the innerliner from cord material in the carcass

10-1. Specifications

Tire related term	Meaning
Intended outboard sidewall	(a) The sidewall that contains a whitewall, bears white lettering, or bears manufacturer, brand, and/or model name molding that is higher or deeper than the same molding on the other sidewall of the tire, or (b) The outward facing sidewall of an asymmetrical tire that has a particular side that must always face outward when mounted on a vehicle
Light truck (LT) tire	A tire designated by its manufacturer as primarily intended for use on lightweight trucks or multipurpose passenger vehicles
Load rating	The maximum load that a tire is rated to carry for a given inflation pressure
Maximum load rating	The load rating for a tire at the maximum permissible inflation pressure for that tire
Maximum permissible inflation pressure	The maximum cold inflation pressure to which a tire may be inflated
Measuring rim	The rim on which a tire is fitted for physical dimension requirements
Open splice	Any parting at any junction of tread, sidewall, or innerliner that extends to cord material
Outer diameter	The overall diameter of an inflated new tire
Overall width	The linear distance between the exteriors of the sidewalls of an inflated tire, including elevations due to labeling, decorations, or protective bands or ribs
Passenger car tire	A tire intended for use on passenger cars, multipurpose passenger vehicles, and trucks, that have a gross vehicle weight rating (GVWR) of 10,000 lb. or less.
Ply	A layer of rubber-coated parallel cords
Ply separation	A parting of rubber compound between adjacent plies

Tire related term	Meaning
Pneumatic tire	A mechanical device made of rubber, chemicals, fabric and steel or other materials, that, when mounted on an automotive wheel, provides the traction and contains the gas or fluid that sustains the load
Radial ply tire	A pneumatic tire in which the ply cords that extend to the beads are laid at substantially 90 degrees to the centerline of the tread
Reinforced tire	A tire designed to operate at higher loads and at higher inflation pressures than the corresponding standard tire
Section width	The linear distance between the exteriors of the sidewalls of an inflated tire, excluding elevations due to labeling, decoration, or protective bands
Sidewall	That portion of a tire between the tread and bead
Sidewall separation	The parting of the rubber compound from the cord material in the sidewall
Snow tire	A tire that attains a traction index equal to or greater than 110, compared to the ASTM E-1136 Standard Reference Test Tire, when using the snow traction test as described in ASTM F-1805-00, Standard Test Method for Single Wheel Driving Traction in a Straight Line on Snow-and Ice-Covered Surfaces, and which is marked with an Alpine Symbol () on at least one sidewall
Test rim	The rim on which a tire is fitted for testing, and may be any rim listed as appropriate for use with that tire
Tread	That portion of a tire that comes into contact with the road
Tread rib	A tread section running circumferentially around a tire

10-1. Specifications

Tire related term	Meaning
Tread separation	Pulling away of the tread from the tire carcass
Treadwear indicators (TWI)	The projections within the principal grooves designed to give a visual indication of the degrees of wear of the tread
Wheel-holding fixture	The fixture used to hold the wheel and tire assembly securely during testing

(1) Table 1—Occupant loading and distribution for vehicle normal load for various designated seating capacities

Designated seating capacity, Number of occupants	Vehicle normal load, Number of occupants	Occupant distribution in a normally loaded vehicle
2 through 4	2	2 in front
5 through 10	3	2 in front, 1 in second seat
11 through 15	5	2 in front, 1 in second seat, 1 in third seat, 1 in fourth seat
16 through 20	7	2 in front, 2 in second seat, 2 in third seat, 1 in fourth seat

User customization function outline

Your vehicle includes a variety of electronic features that can be personalized to suit your preferences. The settings of these features can be changed using the center display or at your Lexus dealer.

WARNING

As the hybrid system needs to be operating during customization, ensure that the vehicle is parked in a place with adequate ventilation. In a closed area such as a garage, exhaust gases including harmful carbon monoxide (CO) may collect and enter the vehicle. Possibly may leading to death or a serious health hazard.

NOTICE

While performing customization, make sure that the hybrid system is operating, in order to prevent the 12-volt battery from becoming discharged.

Method to change settings



Setting on the center display

Set by selecting

Stop the vehicle in a place where operations can be performed safely, engage the parking brake, and change the shift position to P.

- 1 Select  on the center display.
- 2 Select [Vehicle customize] or [Driving assist].
- 3 Select the item to change the settings of from the list.

The setting of each items can be changed. For details, see the customizable items list.

For functions that can be turned on/off, select  (ON) /  (OFF)

Set by selecting

- 1 Select  on the center display.
- 2 Select [Driving assist].
- 3 Select the item to change the settings of from the list.

Each time the switch is selected, the setting will be enabled/disabled.

When enabling is selected, the item display will be emphasized.

Customizable features

Some function settings are changed simultaneously with other functions being customized. Contact your Lexus dealer for further details.

A Settings that can be changed using the center display

B Settings that can be changed by your Lexus dealer

Definition of symbols: ○ = Available, – = Not available

Gauges, meters and multi-information display

The language, units of measure, etc. of some items displayed on the meter or multi-information display will be changed according to settings on the center display. Refer to "MULTIMEDIA OWNER'S MANUAL".

Function	Default setting	Customized setting	A	B
Meter display type ⁽¹⁾	Type 1	Type 2	○	–
		Type 3		
Tachometer setting	Change according to driving mode	Always tachometer	○	–
		Always Hybrid System Indicator		
EV indicator ⁽¹⁾	On	Off	○	–
Rev indicator ⁽²⁾	4000 rpm	2000 - 6000 rpm	○	–
		Off		
Rev peak ⁽²⁾	On	Off	○	–
Suggestion function ⁽¹⁾	On	On (when the vehicle is stopped)	○ ⁽³⁾	○
		Off		
Rear seat reminder function ⁽¹⁾	On	Off	○	–

⁽¹⁾ This setting changes in accordance with My Settings*.

*: If equipped

10-2. Customizable features

(2) F SPORT models

(3) The setting can be changed on [Notifications] of .

Head-up Display*

Function	Default setting	Customized setting	A	B
Display ⁽¹⁾	On	Off	<input type="radio"/>	—
Display mode ⁽¹⁾	Normal	Maximum	<input type="radio"/>	—
		Minimum		

(1) This setting changes in accordance with My Settings*.

Steering wheel switches (vehicles with a head-up display)

Function	Default setting	Customized setting	A	B
Right steering wheel switch favorite functions ⁽¹⁾	Display control	Custom	<input type="radio"/>	—
Left steering wheel switch favorite functions ⁽¹⁾	Audio	Climate	<input type="radio"/>	—
		Custom		
Switch sensor high sensitivity mode (winter glove mode) ⁽¹⁾	Off	On	<input type="radio"/>	—

(1) This setting changes in accordance with My Settings*.

*: If equipped

Door lock

Function	Default setting	Customized setting	A	B
Door lock switch indicator illumination time	30 seconds	60 seconds	-	○
		600 seconds		
		1200 seconds		
Inside door opener switch operation adjustment (door opening function adjustment)	Short	Mid	-	○
		Long		
Multi-information display/buzzer operation when a door opener switch inside the vehicle is operated	On	Off	-	○
Inside/outside door opener switch operating method	Unlatch while pushing switch	0.6 Seconds	-	○
		Operating from inside the cabin: 0.6 Seconds Operating from outside: Unlatch while pushing switch		
		Operating from inside the cabin: Unlatch while pushing switch Operating from outside: 0.6 Seconds		

10-2. Customizable features

Function	Default setting	Customized setting	A	B
Unlocking using a mechanical key	Driver's door unlocked in one step, all doors unlocked in two step	All doors unlocked in one step	–	○
Shift position linked door locking function ⁽¹⁾	On	Off	○	○
Automatic door unlocking function ⁽¹⁾	Shift position linked door unlocking operation	Off	○	○
		Driver's door linked door unlocking operation ⁽²⁾		

(1) This setting changes in accordance with My Settings*.

(2) All doors are automatically unlocked when driver's door is opened within approximately 45 seconds after turning the power switch off.

Power back door

Function	Default setting	Customized setting	A	B
Back door automatic open and stop position	5	Stop at the desired position (height) ⁽¹⁾	○	–
		1 to 5		
Power back door operations	On	Off	○	–
Operation buzzer volume	3	1	○	–
		2		
Kick Sensor ^{*(2)}	On	Off	○	–

*: If equipped

Function	Default setting	Customized setting	A	B
Kick operation buzzer *(2)	On	Off	–	○
The function that validates the  switch of the wireless remote control when locking the door	On	Off	–	○
Close & lock (walk away) function	On	Off	–	○
Hands free close & lock (walk away) function *	Off	On	–	○

(1) Configured by operating the  switch of the lower back door.

(2) When the towing hitch is installed, the kick sensor does not work

Smart access system with push-button start and wireless remote control

Function	Default setting	Customized setting	A	B
Operation buzzer volume ⁽¹⁾	5	Off	○	○
		1 to 7		
Operation signal (Emergency flashers) ⁽¹⁾	On	Off	○	○
Time elapsed before automatic door lock function is activated if door is	60 seconds	Off	○	○
		30 seconds		

10-2. Customizable features

Function	Default setting	Customized setting	A	B
not opened after being unlocked ⁽¹⁾	60 seconds	120 seconds	<input type="radio"/>	<input type="radio"/>
Open door warning buzzer	On	Off	–	<input type="radio"/>

(1) This setting changes in accordance with My Settings*.

Smart access system with push-button start

Function	Default setting	Customized setting	A	B
Smart access system with push-button start	On	Off	–	<input type="radio"/>
The doors that are unlocked using the smart access system with push-button start can be selected ⁽¹⁾	Driver's door	All the doors	<input type="radio"/>	<input type="radio"/>
Number of consecutive door lock operations	2 times	As many as desired	–	<input type="radio"/>
Time elapsed before unlocking all the door when gripping and holding the driver's door handle	2 seconds	Off	–	<input type="radio"/>
		1.5 seconds		
		2.5 seconds		

(1) This setting changes in accordance with My Settings*.

*: If equipped

Wireless remote control

Function	Default setting	Customized setting	A	B
Unlocking operation ⁽¹⁾	Driver's door unlocked in one step, all doors unlocked in two step	All doors unlocked in one step	<input type="radio"/>	<input type="radio"/>
Panic function	On	Off	–	<input type="radio"/>
Power back door unlocking operation	Press and hold (short)	One short press	–	<input type="radio"/>
		Push twice		
		Press and hold (long)		
		Off		
Locking operation when door opened ⁽¹⁾	On	Off	<input type="radio"/>	<input type="radio"/>

(1) This setting changes in accordance with My Settings*.

Driving position memory

Function	Default setting	Customized setting	A	B
Driver's seat movement when exiting the vehicle ⁽¹⁾	Standard	Off	<input type="radio"/>	<input type="radio"/>
		Partial		
Steering wheel movement ⁽¹⁾	Tilt only	Telescopic only	<input type="radio"/>	–
		Tilt and telescopic		
		Off		

(1) This setting changes in accordance with My Settings*.

*: If equipped

Outside rear view mirrors

Function	Default setting	Customized setting	A	B
Automatic mirror folding and extending operation	Linked to the locking/unlocking of the doors	Off	-	○
		Linked to operation of the power switch		

Power windows and moon roof

Function	Default setting	Customized setting	A	B
Mechanical key linked operation	Off	On	-	○
Wireless remote control linked operation	Off	On (open only)	-	○

Moon roof

Function	Default setting	Customized setting	A	B
Linked operation of components when mechanical key is used (open only)	Slide only	Tilt only	-	○
Linked operation of components when wireless remote control is used	Slide only	Tilt only	-	○

Automatic light control system

Function	Default setting	Customized setting	A	B
Light sensor sensitivity ⁽¹⁾	Standard	-2 to 2	<input type="radio"/>	<input type="radio"/>
Time elapsed before head-lights automatically turn off after doors are closed ⁽¹⁾	30 seconds	Off	<input type="radio"/>	<input type="radio"/>
		60 seconds		
		90 seconds		
Windshield wiper linked head-light illumination	On	Off	-	<input type="radio"/>

(1) This setting changes in accordance with My Settings *

Lights

Function	Default setting	Customized setting	A	B
Daytime running lights ⁽¹⁾⁽²⁾	On	Off	<input type="radio"/>	<input type="radio"/>
Welcome lighting	On	Off	-	<input type="radio"/>
AFS (Adaptive Front-lighting System)*	On	Off	-	<input type="radio"/>

(1) Except for Canada

(2) This setting changes in accordance with My Settings *

Adaptive High-beam System *

Function	Customized settings	A	B
Adaptive Highbeam System	ON/OFF	-	<input type="radio"/>

*: If equipped

10-2. Customizable features

Function	Customized settings	A	B
Brightness and illuminated area adjustment of the high beams according to the vehicle speed	9 mph (15 km/h) / 19 mph (30 km/h) / 50 mph (80 km/h)	–	○
Projection distance adjustment of the low beams according to the distance to a preceding vehicle	ON/OFF	–	○

Pre-Collision System

Function	Customized setting	A	B
Pre-Collision System	ON/OFF	○	–
Warning timing ⁽¹⁾	Later / Default / Earlier	○	–

⁽¹⁾ This setting changes in accordance with My Settings*.

Front Cross Traffic Alert*

Function	Customized setting	A	B
Front Cross Traffic Alert	ON/OFF	○	–
Alert timing ⁽¹⁾	Later / Default / Earlier	○	–

⁽¹⁾ This setting changes in accordance with My Settings*.

Lane Departure Alert system

Function	Customized settings	A	B
Lane Departure Alert system ⁽¹⁾	ON/OFF	○	–
Alert timing ⁽¹⁾	Default/Earlier	○	–

*: If equipped

Function	Customized settings	A	B
Alert options	Vibration/Beep	○	–

(1) This setting changes in accordance with My Settings*.

Lane Change Assist*

Function	Customized setting	A	B
Lane Change Assist ⁽¹⁾	ON/OFF	○	–

(1) This setting changes in accordance with My Setting*.

Driver break suggestion

Function	Customized setting	A	B
Driver break suggestion	ON/OFF	○	–

Curve speed reduction

Function	Customized setting	A	B
Curve speed reduction ⁽¹⁾	OFF / High / Mid / Low	○	–

(1) This setting changes in accordance with My Settings*.

Dynamic Radar Cruise Control

Function	Customized setting	A	B
Acceleration setting ⁽¹⁾	High / Mid / Low	○	–
Guide message ⁽¹⁾	ON/OFF	○	–

(1) This setting changes in accordance with My Settings*.

*: If equipped

Road Sign Assist

Function	Customized setting	A	B
Road Sign Assist ⁽¹⁾	ON/OFF	<input type="radio"/>	–
Excess speed notification method ⁽¹⁾	None / Visual / Visual&Audible	<input type="radio"/>	–
Other notifications method ⁽¹⁾	None / Visual / Visual&Audible	<input type="radio"/>	–
Excess speed notification level ⁽¹⁾	5 mph (10 km/h) / 3 mph (5 km/h) / 1 mph (2 km/h)	<input type="radio"/>	–

⁽¹⁾ This setting changes in accordance with My Settings*.

Intuitive parking assist*

Function	Default setting	Customized setting	A	B
Intuitive parking assist ⁽¹⁾	On	Off	<input type="radio"/>	–

⁽¹⁾ This setting changes in accordance with My Settings*.

Parking assist volume*

Function	Default setting	Customized setting	A	B
Parking assist volume ⁽¹⁾	Mid	Low	<input type="radio"/>	–
		High		

⁽¹⁾ This setting changes in accordance with My Settings*.

*: If equipped

BSM (Blind Spot Monitor)

Function	Default setting	Customized setting	A	B
Blind spot monitor	On	Off	<input type="radio"/>	–
Alert timing for presence of approaching vehicle (sensitivity) ⁽¹⁾	Intermediate	Early	<input type="radio"/>	–
		Late		
Outside rear view mirror indicator brightness ⁽¹⁾	Bright	Dim	<input type="radio"/>	–

(1) This setting changes in accordance with My Settings*.

Safe Exit Assist (with door opening control)

Function	Default setting	Customized setting	A	B
Safe Exit Assist	On	Off	<input type="radio"/>	–
Outside rear view mirrors display ⁽¹⁾	On	Off	<input type="radio"/>	–
Detection sensitivity ⁽¹⁾	Middle	High	<input type="radio"/>	–
		Low		

(1) This setting changes in accordance with My Settings*.

RCTA (Rear Cross Traffic Alert)

Function	Default setting	Customized setting	A	B
RCTA (Rear Cross Traffic Alert) ⁽¹⁾	On	Off	<input type="radio"/>	–

*: If equipped

10-2. Customizable features

(1) This setting changes in accordance with My Settings*.

RCD (Rear camera detection)*

Function	Default setting	Customized setting	A	B
RCD (Rear camera detection) ⁽¹⁾	On	Off	<input type="radio"/>	—

(1) This setting changes in accordance with My Settings*.

PKSB (Parking Support Brake)*

Function	Default setting	Customized setting	A	B
PKSB (Parking Support Brake) ⁽¹⁾	On	Off	<input type="radio"/>	—

(1) This setting changes in accordance with My Settings*.

Driving mode select switch

Function	Default setting	Customized setting	A	B
Powertrain control in custom mode*	Normal	Power	<input type="radio"/>	—
		Eco		
Suspension in custom mode*	Normal	Sport	<input type="radio"/>	—
Steering in custom mode*	Normal	Sport	<input type="radio"/>	—
Air conditioning operation in customized mode*	Normal	Eco	<input type="radio"/>	—

*: If equipped

Automatic air conditioning system

Function	Default setting	Customized setting	A	B
Automatic switching between outside air mode and recirculated air mode when the "AUTO" switch is on (AUTO switch linked air mode changing) ⁽¹⁾	On	Off	<input type="radio"/>	<input type="radio"/>
Automatic turning on of the A/C switch when the AUTO switch is turned on (AUTO switch linked A/C switch) ⁽¹⁾	On	Off	<input type="radio"/>	<input type="radio"/>
Steering wheel heater temperature adjustment in AUTO mode ⁽¹⁾	Standard	-2 (cooler) to 2 (warmer)	<input type="radio"/>	<input type="radio"/>
Temperature/Fan speed adjustment when the driver's side automatic seat heater/ventilator is in AUTO mode ⁽¹⁾	Standard	-2 (cooler) to 2 (warmer)	<input type="radio"/>	<input type="radio"/>

10-2. Customizable features

Function	Default setting	Customized setting	A	B
Temperature/Fan speed adjustment when the front passenger's side automatic seat heater/ventilator is in AUTO mode ⁽¹⁾	Standard	-2 (cooler) to 2 (warmer)	<input type="radio"/>	<input type="radio"/>

(1) This setting changes in accordance with My Settings*.

Illumination

Function	Default setting	Customized setting	A	B
Time elapsed before the lights turn off ⁽¹⁾	15 seconds	Off	<input type="radio"/>	<input type="radio"/>
		7.5 seconds		
		30 seconds		
Operation after the power switch is turned off	On	Off	-	<input type="radio"/>
Operation when you approach the vehicle with the electronic key on your person	On	Off	-	<input type="radio"/>
Operation when the doors are unlocked	On	Off	-	<input type="radio"/>
Footwell lights	On	Off	-	<input type="radio"/>

*: If equipped

Function	Default setting	Customized setting	A	B
Door-trim ornament lights*, inside handle lights and center console light*	On	Off	-	○
Time elapsed before the outer foot lights turn off ⁽¹⁾	15 seconds	Off	○	○
		7.5 seconds		
		30 seconds		
Operation of the outer foot lights when you approach the vehicle with the electronic key on your person	On	Off	-	○
Operation of the outer foot lights when the doors are unlocked	On	Off	-	○
Operation of the outer foot lights when a door is opened	On	Off	-	○
Fading out of the outer foot lights when they turn off	Long	Short	-	○
Operation of interior lights and outer foot lights after the doors are locked	On	Off	-	○
Color selection ⁽¹⁾	Silky white	Set color	○	-
		Custom		

10-2. Customizable features

Function	Default setting	Customized setting	A	B
Brightness control ⁽¹⁾	Maximum	Desired brightness	○	—

(1) This setting changes in accordance with My Settings*.

Charging system

Function	Default setting	Customized setting	A	B
Charging Current	MAX	8A	○	—
		16A ⁽¹⁾		
Connector lock	Auto Lock	Auto Lock & Unlock	○	—
		OFF		
Traction battery heater	On	Off	○	—
Traction battery cooler	On	Off	○	—

(1) Vehicles with 7 kW onboard traction battery charger only

Power switch

Function	Customized setting	A	B
ACC mode	ON/OFF	○	○

*: If equipped

Items to initialize

Must be initialized for normal system operation after such cases as the 12-volt battery being reconnected, or maintenance being performed on the vehicle:

Item	When to initialize	Reference
Power back door	<ul style="list-style-type: none"> ● After reconnecting or changing the 12-volt battery 	→ P.130
Lexus parking assist-monitor	<ul style="list-style-type: none"> ● After reconnecting or changing the 12-volt battery 	Refer to "MULTIMEDIA OWNER'S MANUAL".
Panoramic view monitor *	<ul style="list-style-type: none"> ● After reconnecting or changing the 12-volt battery 	Refer to "MULTIMEDIA OWNER'S MANUAL".
Message indicating maintenance is required	<ul style="list-style-type: none"> ● After maintenance is performed 	→ P.576
Oil maintenance	<ul style="list-style-type: none"> ● After maintenance is performed 	→ P.576
Tire pressure warning system	<ul style="list-style-type: none"> ● When the specified tire inflation pressure has changed, such as due to carried load, etc. ● When the tire inflation pressure is changed such as when the tire size is changed. 	→ P.605

*: If equipped

11-1. For owners

- Reporting safety defects for
U.S. owners786
- Reporting safety defects for
Canadian owners787
- Seat belt instructions for
Canadian owners (in
French)..... 788
- SRS airbag instructions for
Canadian owners (in
French).....789
- Headlight aim instructions
for Canadian owners (in
French).....795

Reporting safety defects for U.S. owners

If you believe that your vehicle has a defect which could cause a crash or could cause injury or death, you should immediately inform the National Highway Traffic Safety Administration (NHTSA) in addition to notifying the Lexus Division of Toyota Motor Sales, U.S.A., Inc. (Toll-free: 1-800-25-LEXUS). If NHTSA receives similar complaints, it may open an investigation, and if it finds that a safety defect exists in a group of vehicles, it may order a recall and remedy campaign. However, NHTSA cannot become involved in individual problems between you, your dealer, or Lexus Division of Toyota Motor Sales, U.S.A., Inc. To contact NHTSA, you may call the Vehicle Safety Hotline toll-free at 1-888-327-4236 (TTY: 1-800-424-9153); go to <http://www.safercar.gov>; or write to: Administrator, NHTSA, 1200 New Jersey Ave. SE., Washington, DC 20590. You can also obtain other information about motor vehicle safety from <http://www.safercar.gov>.

Reporting safety defects for Canadian owners

Canadian customers who wish to report a safety-related defect to Transport Canada, Defects Investigations and Recalls, may telephone the toll-free hotline 1-800-333-0510, mail Transport Canada - ASFAD, 330 Sparks Street, Ottawa, ON, K1A 0N5, or complete the online form at <https://www.tc.gc.ca/recalls>.

Seat belt instructions for Canadian owners (in French)

The following is a French explanation of seat belt instructions extracted from the seat belt section in this manual.

See the seat belt section for more detailed seat belt instructions in English.

Utilisation des ceintures de sécurité

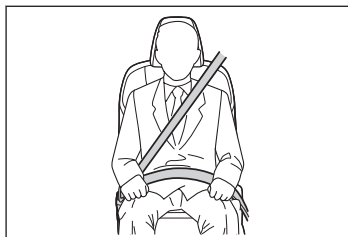

- Déroulez la sangle diagonale de telle sorte qu'elle passe bien sur l'épaule, sans pour autant être en contact avec le cou ou glisser de l'épaule.
- Placez la sangle abdominale le plus bas possible sur les hanches.
- Réglez la position du dossier de siège. Asseyez-vous le dos droit et caliez-vous bien dans le siège.
- Ne vrillez pas la ceinture de sécurité.

⚠ WARNING

Inspectez le système de ceintures de sécurité régulièrement. Contrôlez l'absence de coupures, d'effilochages et de pièces desserrées. N'utilisez pas une ceinture de sécurité endommagée avant qu'elle ne soit remplacée. Une ceinture de sécurité endommagée ne permet pas de protéger un occupant de blessures graves ou mortelles.

Traitement des ceintures de sécurité

Nettoyez avec un chiffon ou une éponge humidifiés avec de l'eau savonneuse tiède. Vérifiez régulièrement que les ceintures ne sont pas usées, effilochées ou entaillées excessivement.

SRS airbag instructions for Canadian owners (in French)

The following is a French explanation of SRS airbag instructions extracted from the SRS airbag section in this manual.

See the SRS airbag section for more detailed SRS airbag instructions in English.

Coussins gonflables SRS

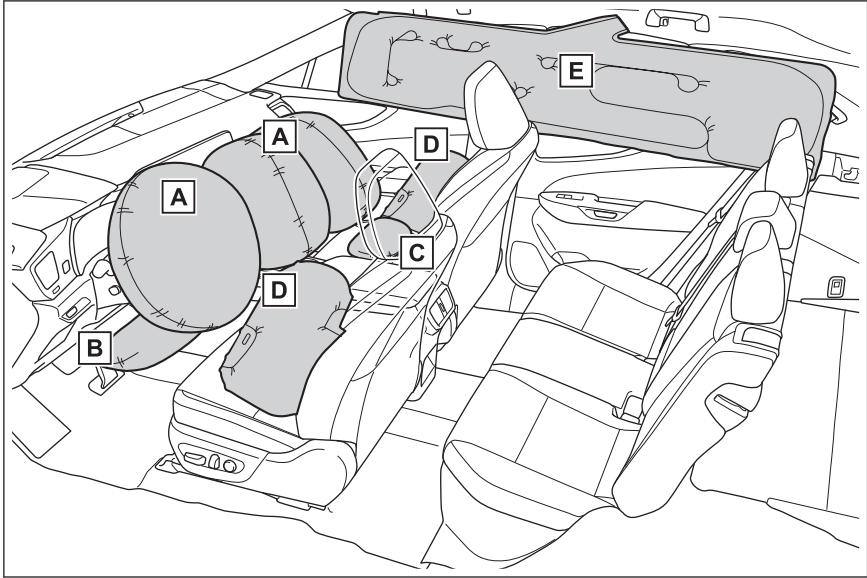

- A** Coussin gonflable conducteur/coussin gonflable du passager avant SRS
Permettent de réduire le choc à la tête et au thorax du conducteur et du passager avant
- B** Coussins gonflables de genoux SRS
Permettent de réduire le choc pour le conducteur et le passager avant
- C** Coussins gonflables de coussin de siège SRS
- Permet de réduire le choc pour le passager avant
 - Aident à la retenue de l'occupant du siège arrière
- D** Coussins gonflables latéraux SRS
- Permettent de réduire le choc au thorax pour les occupants des sièges avant
- E** Coussins gonflables rideaux SRS
- Permettent de réduire le choc à la tête pour les occupants des sièges avant et latéraux arrière
 - Peut contribuer à empêcher les occupants d'être éjectés du véhicule en cas de tonneau

Votre véhicule est équipé de COUSSINS GONFLABLES INTELLIGENTS conçus selon les normes de sécurité américaines applicables aux véhicules à moteur (FMVSS208). L'ensemble de capteurs de coussins gonflables (ECU) régule le déploiement des coussins gonflables sur la base des informations qu'il reçoit des capteurs, etc., indiqués ci-dessus dans le schéma illustrant les composants du système. Parmi ces informations figurent la gravité du choc et l'occupation du véhicule par les passagers. Le déploiement rapide des coussins gonflables est obtenu au moyen d'une réaction chimique dans les dispositifs pyrotechniques, qui produit un gaz inoffensif permettant d'amortir le mouvement des occupants.

WARNING

Précautions relatives aux coussins gonflables SRS

Respectez les précautions suivantes. Le non-respect de ces précautions peut occasionner des blessures graves, voire mortelles.

- Le conducteur et tous les passagers doivent porter correctement leur ceinture de sécurité.

Les coussins gonflables SRS sont des dispositifs supplémentaires à utiliser avec les ceintures de sécurité.

- Le coussin gonflable conducteur SRS se déploie avec une force considérable, pouvant occasionner des blessures graves, voire mortelles, si le conducteur se trouve très près du coussin gonflable. L'autorité fédérale chargée de la sécurité routière aux États-Unis (NHTSA) conseille:

La zone à risque du coussin gonflable conducteur se situant dans les premiers 2 à 3 in. (50 à 75 mm) de déploiement, vous placer à 10 in. (250 mm) de votre coussin gonflable conducteur vous garantit une marge de sécurité suffisante. Cette distance est à mesurer entre le centre du volant et le sternum. Si votre position de conduite vous place à moins de 10 in. (250 mm) du coussin gonflable conducteur, vous pouvez changer votre position de conduite de plusieurs façons:

- Reculez votre siège le plus possible, de manière à pouvoir encore atteindre confortablement les pédales.
- Inclinez légèrement le dossier du siège. Bien que les véhicules aient une conception différente, un grand nombre de conducteurs peuvent s'asseoir à une distance de 10 in. (251 mm), même avec le siège conducteur complètement avancé, simplement en inclinant un peu le dossier de siège. Si vous avez des difficultés à voir la route après avoir incliné le dossier de votre siège, utilisez un coussin ferme et antidérapant pour vous rehausser ou remontez le siège si votre véhicule est équipé de cette fonction.
- Si votre volant est réglable, inclinez-le vers le bas. Cela a pour effet d'orienter le coussin gonflable en direction de votre poitrine plutôt que de votre tête et de votre cou. Réglez votre siège selon les recommandations de la NHTSA, tout en

⚠ WARNING

conservant le contrôle du véhicule avec les pédales et le volant, et en préservant la vue des commandes du tableau de bord.

- Si vous attachez une rallonge de ceinture de sécurité à la boucle de ceinture de sécurité d'un siège avant sans l'attacher au pêne de la ceinture de sécurité, le système de coussins gonflables SRS détermine que l'occupant porte sa ceinture de sécurité, bien que la ceinture de sécurité ne soit pas attachée. Dans ce cas, les coussins gonflables frontaux SRS peuvent ne pas se déployer correctement lors d'une collision, pouvant occasionner des blessures graves, voire mortelles. Veillez à porter correctement la ceinture de sécurité lorsque vous utilisez une rallonge de ceinture de sécurité.
- Le coussin gonflable passager avant SRS se déploie avec une force considérable, pouvant occasionner des blessures graves, voire mortelles, si le passager avant se trouve très près du coussin gonflable. Le siège du passager avant doit être placé aussi loin que possible du coussin gonflable en réglant le dossier de siège de façon à ce que le passager avant soit assis bien droit dans le siège.
- Les nourrissons et les enfants qui ne sont pas correctement assis et/ou attachés peuvent être grièvement blessés ou tués par le déploiement d'un coussin gonflable. Un nourrisson ou un enfant trop petit pour utiliser une ceinture de sécurité doit être correctement attaché au moyen d'un siège de sécurité enfant. Lexus recommande vivement d'installer tous les nourrissons et enfants sur les sièges arrière du véhicule et de prévoir pour eux des systèmes de retenue adaptés. Les sièges arrière sont plus sûrs pour les nourrissons et les enfants que le siège du passager avant.
- N'installez jamais un siège de sécurité enfant type dos à la route sur le siège passager avant, même si le témoin indicateur "AIR BAG OFF" est allumé. En cas d'accident, la force engendrée par le déploiement rapide du coussin gonflable du passager avant peut blesser grièvement, voire tuer l'enfant si le siège de sécurité enfant type dos à la route est installé sur le siège du passager avant.
- Ne vous asseyez pas sur le bord du siège et ne vous appuyez pas contre la planche de bord.

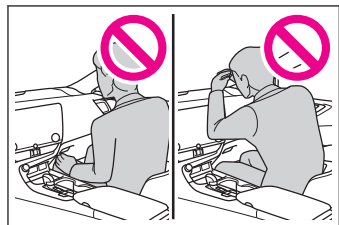
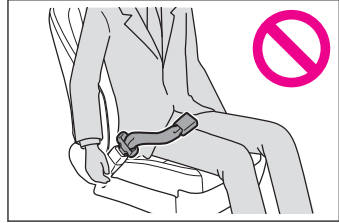

⚠ WARNING

- Ne laissez pas un enfant rester debout devant le coussin gonflable passager avant SRS ou s'asseoir sur les genoux du passager avant.
- Les occupants des sièges avant ne doivent jamais voyager avec un objet sur les genoux.

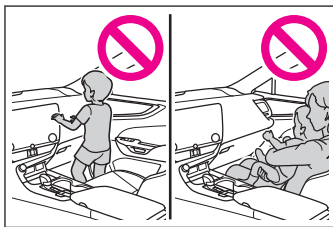

- Ne vous appuyez pas contre la porte, le rail latéral de toit ou les montants avant, latéraux et arrière.



- Ne laissez personne s'agenouiller sur un siège en appui contre la porte ou sortir la tête ou les mains à l'extérieur du véhicule.

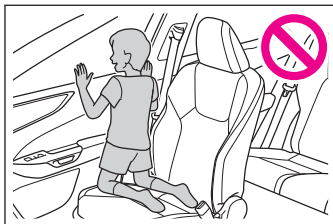

- Ne fixez rien et ne posez rien sur des emplacements tels que la planche de bord, la garniture du volant et la partie inférieure du tableau de bord.

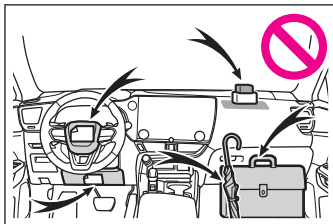

- Ne fixez rien aux portes, à la vitre du pare-brise, aux vitres latérales, aux montants avant et arrière, aux rails latéraux de toit et aux poignées de maintien.

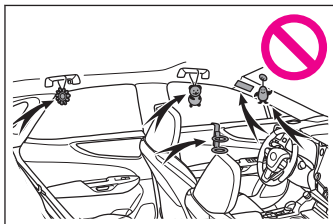

⚠ WARNING

- Ne suspendez aucun cintre ou objet dur aux crochets à vêtements. Ces objets pourraient devenir des projectiles si les coussins gonflables rideaux SRS se déploient, pouvant entraîner des blessures graves ou mortelles.
- Si un cache en vinyle est fixé sur la zone où le coussin gonflable de genoux SRS se déploie, assurez-vous de le retirer.
- N'utilisez aucun accessoire de siège recouvrant les zones de déploiement des coussins gonflables SRS, car il risque de gêner le déploiement des coussins gonflables SRS. De tels accessoires peuvent empêcher les coussins gonflables SRS de se déployer correctement, désactiver le système ou entraîner le déploiement accidentel des coussins gonflables SRS, occasionnant des blessures graves, voire mortelles.
- Évitez de faire subir des chocs ou des pressions excessives aux composants des coussins gonflables SRS, aux portes avant ou aux parties environnantes. Cela pourrait provoquer un dysfonctionnement des coussins gonflables SRS.
- Ne touchez aucun composant des coussins gonflables SRS immédiatement après le déploiement (gonflage) des coussins gonflables SRS, car ils peuvent être chauds.
- Si vous avez des difficultés à respirer après le déploiement des coussins gonflables SRS, ouvrez une porte ou une vitre pour faire entrer de l'air frais, ou bien descendez du véhicule si cela ne présente pas de danger. Essayez tout résidu dès que possible afin d'éviter d'éventuelles irritations de la peau.
- Si une zone renfermant un coussin gonflable SRS est endommagée ou craquelée, faites-la remplacer par votre concessionnaire Lexus.
- Ne placez rien sur le siège du passager avant, comme un coussin par exemple. Cela a pour conséquence de répartir le poids du passager sur toute la surface du siège, ce qui empêche le capteur de détecter correctement le poids du passager. Il en résulte que les coussins gonflables avant SRS du siège passager avant risquent de ne pas se déployer en cas de collision.

■ Modification et mise au rebut des composants du système de coussins gonflables SRS

Ne mettez pas votre véhicule au rebut et ne procédez à aucune des modifications suivantes sans consulter votre concessionnaire Lexus.

Les coussins gonflables SRS peuvent ne pas fonctionner correctement ou se déployer accidentellement, pouvant provoquer de graves blessures ou la mort.

- Retrait, installation, démontage ou réparation des coussins gonflables SRS
- Réparation, retrait ou modification des pièces suivantes ou des pièces les avoisinant
 - Volant
 - Tableau de bord
 - Tableau de bord

⚠ WARNING

- Sièges
- Rembourrage de siège
- Piliers avant
- Piliers latéraux
- Piliers arrière
- Rails de toit latéraux
- Panneaux de porte avant
- Garniture de porte avant
- Haut-parleurs de porte avant
- Modifications apportées aux panneaux de porte avant (par exemple, perçage d'un trou dans le panneau)
- Réparation ou modification des pièces suivantes ou des pièces les avoisinant
 - Aile avant
 - Pare-choc avant
 - Côtés de l'intérieur du véhicule
- Installation des pièces ou accessoires suivants
 - Pare-bufiles ou barres stabilisatrices
 - Chasse-neige
 - Treuils
- Modifications apportées à la suspension du véhicule
- Installation de dispositifs électroniques, tels que des radios mobiles bidirectionnelles (émetteur RF) et des lecteurs de CD
- Modifications apportées à votre véhicule pour les personnes atteintes d'un handicap physique

Headlight aim instructions for Canadian owners (in French)

The following is a French explanation of headlight aim instructions from the headlight aim section in this manual.

Boulons de réglage du mouvement vertical

► Type A

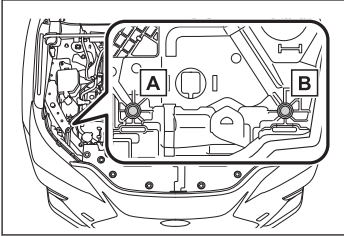

A Boulon de réglage A

B Boulon de réglage B

► Type B

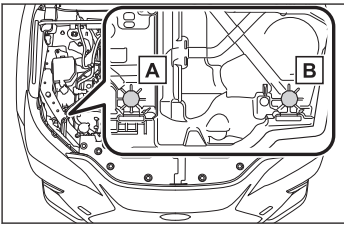

A Boulon de réglage A

B Boulon de réglage B

Vérification du réglage des phares

Avant de vérifier le réglage des phares, confirmez les points suivants.

- Le réservoir de carburant du véhicule est plein et que la zone autour des phares n'est pas déformée.
- Le véhicule est stationné sur un sol plat.
- La pression de gonflage des pneus est au niveau recommandé.
- Une personne est assise sur le siège conducteur.
- Le véhicule a rebondi plusieurs fois après avoir été stationné.

Réglage du faisceau des phares

- 1 À l'aide d'un tournevis cruciforme, tournez le boulon A dans n'importe quel sens. Mémorisez le sens dans lequel vous avez tourné et le nombre de tours.

► Type A

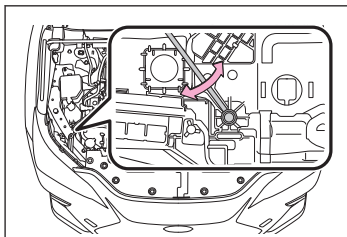

► Type B

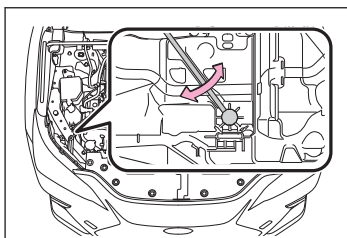

- 2 Tournez le boulon B du même nombre de tours dans le même sens qu'à l'étape 1.

Si vous n'arrivez pas à régler le phare en procédant de la sorte, confiez le véhicule à votre concessionnaire Lexus pour qu'il règle le faisceau des phares.

► Type A

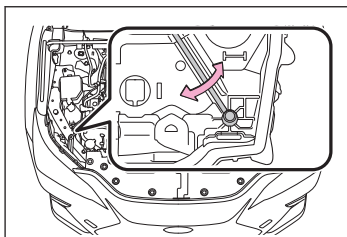

► Type B

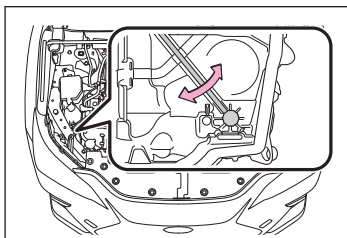

Supplement

Supplementary information about unauthorized modifications, recorded vehicle data, etc.

Accessories, spare parts and modification of your Lexus

A wide variety of non-genuine spare parts and accessories for Lexus vehicles are currently available in the market. You should know that Toyota does not warrant these products and is not responsible for their performance, repair, or replacement, or for any damage they may cause to, or adverse effect they may have on, your Lexus vehicle.

This vehicle should not be modified with non-genuine Lexus products. Modification with non-genuine Lexus products could affect its performance, safety or durability, and may even violate governmental regulations. In addition, damage or performance problems resulting from the modification may not be covered under warranty.

Vehicle data recording

This vehicle is equipped with sophisticated computers that record certain data regarding vehicle controls and operations.

■ Data recorded by the computers

Certain data, such as the following, is recorded depending on the operation timing and status of each function.

- Basic vehicle behavior related data (engine speed/electric motor speed, accelerator/brake pedal operation, vehicle speed, etc.)
- Operating state of the driving support systems (recorded during system operation, includes basic vehicle behavior related data)
- Driving support system sensor data
- Image data (images from the front, rear and side cameras)*¹
- Location information

These computers do not record conversations, sounds, or images of the inside of the vehicle.

Also, personal information which may be used to identify the owner of the vehicle (name, gender, age, etc.) is not recorded.

*1: The vehicle has multiple cameras. For details on from which cameras images are recorded, contact your Lexus dealer.

The recorded data varies according to the vehicle grade level and options with which it is equipped.

■ Usage of recorded data and personal information by the Lexus Safety System + 3

The operating state of each system, data from each sensor, image data (images from the front/rear cameras), and position information is recorded by the Lexus Safety System + 3 in the following situations. Toyota obtains this information when the vehicle is brought to the dealership or when sent to the Toyota servers.

- In certain collisions or collision-like situations
- When driving on roads with certain traffic situations, such as congestion, poor road surfaces, poor weather, etc.
- When driving on certain roads, such as roads which were recently opened or extended
- After the hybrid system is started, for a certain amount of time

To learn more about the vehicle data collected, used and shared by Lexus, please visit <http://www.lexus.com/privacyts/>.

■ Data provision and use purpose by third parties

Data recorded by the computers may be used for collision analysis, malfunction diagnosis, automated driving, advanced safety and map related technologies (technology, product development, product improvement, etc.) and products and services which use data (maps used for automated driving and advanced safety technologies, driving condition analysis, analysis of the driving environment, such as road infrastructure, traffic condition communication, etc. Herein referred to as “individual services”).

Also, this data may be used for customer support related to a collision, collision analysis or resolution.

In situations such as the following, Toyota may disclose the recorded data to a third party:

- When the consent of the vehicle owner (or the lessee if the vehicle is leased) has been given
- When officially requested by the police, a court of law or a government agency
- When it is to be used by Toyota in a lawsuit
- When data is to be used research purposes after processing so that the data is not tied to a specific vehicle or vehicle owner.

In addition to the above, Toyota may disclose the data recorded by the Lexus Safety System + 3 to a third party in the following situations:

- When separate consent of the vehicle owner (or the lessee if the vehicle is leased) has been given

This includes situations when the user subscribes to an individual service which is provided by a second party and uses vehicle recorded data, where the provider has obtained the user's consent for providing data to a third-party.

- When providing data to a company involved in autonomous driving software, etc. for the purpose of research and development (technology, product development, product improvement, etc.) of automated driving, advanced safety and map related technologies
- When providing image data and position information to a company involved in map creation, etc. for the purpose of research and development map related technologies
- When providing image data and position information to a local government for the purpose of road maintenance, etc.
- When providing processed image data and position information to traffic condition communication individual services
- When providing image data from near a fire, or other area that emergency services are dispatched, to the fire department of a local government which has entered a separate contract with Lexus

INFORMATION

Image information recorded by the vehicle can be erased by your Lexus dealer.

The image recording function can be disabled. However, if the function is disabled, data from when systems operate will not be available.

If you wish to stop the collection of Lexus Safety System + 3 data by the Toyota servers for the purpose of research and development and provision to individual services, contact your Lexus dealer.

Event data recorder

This vehicle is equipped with an event data recorder (EDR). The main purpose of an EDR is to record, in certain crash or near crash-like situations, such as an air bag deployment or hitting a road obstacle, data that will assist in understanding how a vehicle's systems performed. The EDR is designed to record data related to vehicle dynamics and safety systems for a short period of time, typically 30 seconds or less.

The EDR in this vehicle is designed to record such data as:

- How various systems in your vehicle were operating;
- Whether or not the driver and passenger safety belts were buckled/fastened;

- How far (if at all) the driver was depressing the accelerator and/or brake pedal; and,
- How fast the vehicle was traveling.

These data can help provide a better understanding of the circumstances in which crashes and injuries occur.

NOTE: EDR data are recorded by your vehicle only if a non-trivial crash situation occurs; no data are recorded by the EDR under normal driving conditions and no personal data (e.g., name, gender, age, and crash location) are recorded. However, other parties, such as law enforcement, could combine the EDR data with the type of personally identifying data routinely acquired during a crash investigation.

To read data recorded by an EDR, special equipment is required, and access to the vehicle or the EDR is needed. In addition to the vehicle manufacturer, other parties, such as law enforcement, that have the special equipment, can read the information if they have access to the vehicle or the EDR.

■ Disclosure of the EDR data

Lexus will not disclose the data recorded in an EDR to a third party except when:

- An agreement from the vehicle's owner (or the lessee for a leased vehicle) is obtained
- In response to an official request by the police, a court of law or a government agency
- For use by Lexus in a lawsuit

However, if necessary, Lexus may:

- Use the data for research on vehicle safety performance
- Disclose the data to a third party for research purposes without disclosing information about the specific vehicle or vehicle owner

Precautions for installation of a mobile two-way radio system

The installation of a mobile two-way radio system in your vehicle could affect electronic systems such as:

- Hybrid system
- Multiport fuel injection system/sequential multiport fuel injection system
- Lexus Safety System +3
- Anti-lock brake system
- SRS airbag system
- Seat belt pretensioner system

Be sure to check with your Lexus dealer for precautionary measures or special instructions regarding installation of a mobile two-way radio system.

High voltage parts and cables on hybrid electric vehicles have structures which act as electromagnetic shielding. They emit approximately the same amount of electromagnetic radiation as conventional gasoline powered vehicles and home electronic appliances.

Unwanted noise may occur in the reception of the mobile two-way radio.

Precautions for scrapping your Lexus

The SRS airbag and seat belt pretensioner devices in your Lexus contain explosive chemicals. If the vehicle is scrapped with the airbags and seat belt pretensioners left as they are, this may cause an accident such as fire. Be sure to have the systems of the SRS airbag and seat belt pretensioner removed and disposed of by a qualified service shop or by your Lexus dealer before you scrap your vehicle.

“QR code”

The word “QR Code” is registered trademark of DENSO WAVE INCORPORATED in Japan and other countries.

Symbols

12-volt battery.....	595
12-volt battery checking.....	595

A

A/C

Air conditioning filter.....	598
------------------------------	-----

AC charging cable

CCID (Charging Circuit Interrupting Device).....	56,60
--	-------

If the charging connector cannot be unlocked.....	707
---	-----

Indicator.....	60,709
----------------	--------

Locking and unlocking.....	50
----------------------------	----

Maintenance.....	58
------------------	----

Safety functions.....	59
-----------------------	----

ACCESSORY mode.....	184
---------------------	-----

Acoustic Vehicle Alerting System.....	36
---------------------------------------	----

Adaptive Front-lighting System (AFS).....	225
---	-----

Adaptive High-beam System.....	227
--------------------------------	-----

Advanced Park.....	469
--------------------	-----

Operation.....	479
----------------	-----

AFS (Adaptive Front-lighting System).....	225
---	-----

AHB

See Automatic High Beam

AHS

See Adaptive High-beam System

Air conditioning filter.....	598
------------------------------	-----

Air conditioning system.....	279
------------------------------	-----

Air conditioning filter.....	598
------------------------------	-----

Defogger.....	246
---------------	-----

Alarm.....	125
------------	-----

Warning buzzer.....	638
---------------------	-----

Antennas (smart access system with push-button start).....	108
--	-----

Anti-lock Brake System (ABS)

ABS warning light.....	641
------------------------	-----

AUTO EV/HV mode switch.....	34
-----------------------------	----

Automatic air conditioning system

My Room Mode.....	86
-------------------	----

Automatic headlight leveling system..	226
---------------------------------------	-----

Automatic headlight leveling system (Headlight)

Function.....	226
---------------	-----

Automatic High Beam.....	231
--------------------------	-----

Automatic light control system.....	222
-------------------------------------	-----

B

Back door.....	130
----------------	-----

If the back door cannot be opened.	700
------------------------------------	-----

Back-up light

Replacing light bulbs.....	738
----------------------------	-----

Battery (12-volt battery)

If the 12-volt battery is discharged...	675
---	-----

Blind Spot Monitor.....	418
-------------------------	-----

Brake

Brake system warning light.....	638
---------------------------------	-----

Fluid.....	592,747
------------	---------

Regenerative braking.....	32
---------------------------	----

Brake hold

Brake hold operated indicator.....	650
------------------------------------	-----

Brake Hold

Warning messages.....	658
-----------------------	-----

B buzzers

Open window warning.....	157
--------------------------	-----

C

Card key.....	104
---------------	-----

- Care**..... 560,566
- Exterior..... 560
 - Interior..... 566
 - Seat belts..... 566
 - Wheels and wheel ornaments..... 562
- Cargo capacity**..... 89,129
- Catch protection function**..... 157
- Center console light**..... 296
- Charging**..... 50
- AC charging cable..... 56
 - Charging equipment..... 50
 - Charging precautions..... 46
 - Charging procedure..... 69
 - Charging schedule function..... 78
 - Information related to charging display..
..... 68
 - My Room Mode..... 86
 - Power sources precautions..... 60
 - Power sources that can be used..... 60
 - When charging cannot be carried out...
..... 703-705
- Charging port**..... 50
- Locking and unlocking..... 50
 - Opening and closing..... 54,55
- Charging schedule function**..... 78
- Child restraint system**..... 90,91
- Child safety**
- 12-volt battery precautions..... 595
 - Charging precautions..... 46
 - Power window lock switch..... 159
 - Seat belt extender precautions..... 165
- Child seat**..... 90
- Child-protector lock**..... 90,92
- Cleaning**..... 560,566
- Exterior..... 560
 - Interior..... 566
 - Seat belts..... 566
 - Wheels and wheel ornaments..... 562
- Clock**..... 333,340
- Condenser**..... 591
- Connected Services**..... 552
- Cooling system**..... 590
- Cornering lights**..... 225
- Lights..... 225
 - Replacing light bulbs..... 738
- Courtesy lights**
- Location..... 296
- Cruise control**..... 526
- Customizable features**..... 763
-
- D**
- Daytime running light system**..... 222
- DC/DC converter air intake vent**..... 39
- Defogger**
- Outside rear view mirrors..... 249
 - Rear window defogger..... 248
 - Windshield..... 246
- Defogger (Rear window defogger)**.... 248
- Differential**
- Rear differential oil..... 747
- Digital Key**..... 113
- Digital Rear-view Mirror**..... 170
- Dimension**..... 742
- Dinghy towing**..... 156
- Distance to empty**..... 333,340,355
- Do-it-yourself maintenance**..... 577
- Door**
- Child-protector lock..... 92

- If a door cannot be opened.....696
 - Smart access system with push-button start.....108
 - Door courtesy lights**
 - Location.....296
 - Door trim ornament lights..... 296**
 - Doors**
 - Close & lock (walk away) function.... 121
 - Door lock switches.....121
 - Impact detection door lock release system.....119
 - Drive-Start Control (DSC)**
 - Sudden start restraint control..... 535
 - Driver's and front passenger's seat belt reminder light..... 643**
 - Driving**
 - EV driving range.....43
 - Plug-in hybrid electric vehicle driving tips.....41
 - Driving position memory.....272**
 - Memory recall function.....273
 - Position memory.....273
 - Driving time.....354,364**
 - Dynamic radar cruise control..... 516**
- E**
- Eco air conditioning mode..... 285**
 - EDSS**
 - See Emergency Driving Stop System
 - Electric motor (traction motor)..... 26,27**
 - Electric power steering system**
 - Electric power steering system warning light..... 643
 - Electronic key.....104**
 - Battery-saving function.....104
 - If the electronic key does not operate properly.....673,687
 - Replacing the battery..... 687
 - Emergency Driving Stop System.....531**
 - Emergency flashers**
 - Switches.....635
 - Emergency shut off system.....637**
 - Emergency towing..... 719**
 - Emergency, in case of**
 - A warning light turns on/flashes..... 638
 - If a warning message is displayed..... 651
 - If the 12-volt battery is discharged..... 675,687
 - If the battery is discharged..... 675,687
 - If the electronic key does not operate properly.....673,687
 - If the hybrid system will not start..... 672,675,682-684
 - If the vehicle is submerged or water on the road is rising..... 636
 - If you have a flat tire..... 685
 - If your vehicle overheats.....730
 - Stopping the vehicle in an emergency... 635
 - Towing with a tow truck..... 716
 - Towing with another vehicle..... 719
 - Using a flatbed truck..... 718
 - Engine**
 - Compartment.....587
 - Engine switch.....182
 - Hood.....586
 - Identification number..... 742
 - If the hybrid system will not start.....672
 - Ignition switch (engine switch).....182
 - Ignition switch (power switch).....182

- Immobilizer system.....125
 - Malfunction indicator lamp.....640
 - Overheating.....730
 - Starting the hybrid system.....182
 - Engine compartment**
 - Steam comes out from under the hood.....730
 - Engine coolant.....590**
 - Capacity.....746
 - Checking.....590
 - Engine oil.....587**
 - Capacity.....745
 - Checking.....587
 - Low engine oil pressure warning light.....640
 - Engine oil maintenance data.....576**
 - Engine switch (power switch)**
 - Auto power off function.....184
 - Changing the power switch modes..184
 - Starting the hybrid system.....182
 - EV driving range.....43**
 - EV mode.....29**
 - EV/HV mode selection switch.....34**
- F**
- FCTA.....415**
 - Flat tire**
 - Run-flat tires.....685
 - Floor mats.....24**
 - Fluid**
 - Brake.....747
 - Hybrid transmission.....747
 - Washer.....594
 - Fog lights.....255**
 - Switch.....255
 - Footwell lights.....296**
 - Front automatic air conditioning system....**
 -279
 - Front Cross Traffic Alert.....415**
 - Front fog lights**
 - Replacing light bulbs.....738
 - Front seats.....160**
 - Adjustment.....160
 - Cleaning.....566
 - Head restraints.....161
 - Memory recall function.....273
 - Position memory.....272
 - Power easy access system.....272
 - Front side marker lights**
 - Light switch.....222
 - Replacing light bulbs.....738
 - Front turn signal lights (bulb type)**
 - Replacing light bulbs.....738
 - Wattage.....749
 - Fuel**
 - Capacity.....744
 - Information.....750
 - Low fuel level warning light.....643
 - Refueling.....218
 - Type.....744
 - Fuel consumption.....354,359,364**
 - Fuel filler door.....218**
 - If the fuel filler door cannot be opened...702
 - Refueling.....218
 - Fuel gauge.....333,340**
 - Function.....453,458**
 - Fuses**
 - Replacing.....734

G

Garage door opener.....	210
Gauges.....	333,340
Changing the instrument panel light brightness.....	365
Displayed content.....	352
Head-up display.....	349
Indicators.....	329
Multi-information display.....	345,347
Warning lights.....	326

H

Hands Free Power Back Door.....	141
Head restraints.....	161
Head-up display.....	349
Headlight	
Cleaner.....	241
Replacing light bulbs.....	738
Headlight switch	
Light switches.....	222
Headlights	
Adaptive Front-lighting System (AFS).....	225
Heated steering wheel.....	289
Heaters	
Hybrid battery (traction battery).....	65
Outside rear view mirrors.....	249
High coolant temperature warning light....	639
High mounted stoplight	
Replacing light bulbs.....	738
High voltage components.....	27
Hood.....	586

Open.....	586
-----------	-----

Hooks

Retaining hooks (floor mat).....	24
----------------------------------	----

Horn.....	256
-----------	-----

HV mode.....	29
--------------	----

Hybrid battery (traction battery)

Charging.....	50
---------------	----

Location.....	27
---------------	----

Specification.....	744
--------------------	-----

Hybrid system.....	26
--------------------	----

Acoustic Vehicle Alerting System.....	36
---------------------------------------	----

Charging.....	50
---------------	----

Driving tips.....	41
-------------------	----

Emergency shut off system.....	637
--------------------------------	-----

High voltage components.....	27
------------------------------	----

Hybrid system overheat warning light....	639
--	-----

If the hybrid system will not start.....	672,675,682,684
--	-----------------

Overheating.....	730
------------------	-----

Plug-in hybrid system precautions.....	27,37
--	-------

Power (ignition) switch.....	182
------------------------------	-----

Regenerative braking.....	32
---------------------------	----

Service plug.....	27
-------------------	----

Starting the hybrid system.....	182
---------------------------------	-----

I

I/M test.....	583
---------------	-----

Identification

Engine.....	742
-------------	-----

Vehicle.....	742
--------------	-----

If the 12-volt battery is discharged.....	687
---	-----

- If you think something is wrong**..... 723
- Ignition switch (power switch)**
- Auto power off function.....184
 - Changing the power switch modes.....184
 - How to start the hybrid system..... 182
- Immobilizer system**..... 125
- Impact detection door lock release system**..... 119
- Indicators**..... 329
- Initialization**
- Items to initialize..... 783
 - Maintenance..... 576
- Inside door handle lights**..... 296
- Inside rear view mirror**..... 169
- Inspection**..... 601
- Interior lights**..... 297
- Intuitive parking assist**..... 431
- Intuitive parking assist OFF indicator..... 647
 - Operation..... 436
- J**
- Jack**
- Lifting the vehicle with a floor jack... 618
 - Vehicle-equipped jack..... 622
- Jack handle**..... 622
- Jam protection function**..... 157
- Power back door..... 130
- Junior seat**..... 90
- K**
- Key**
- If a key has been lost..... 686
- Keyless entry**..... 108
- Keyless entry**
- Smart access system with push-button start..... 108
- Keys**..... 104
- Battery-saving function..... 104
 - Card key..... 104
 - Electronic key..... 104
 - If the electronic key does not operate properly..... 673,687
 - Key number plate..... 104
 - Mechanical key..... 104
- L**
- Lane Change Assist**..... 405
- Lane Departure Alert**..... 409
- Lane Tracing Assist**..... 400
- LCA**..... 405
- LDA**)..... 409
- Lever**
- Auxiliary catch lever..... 586
 - Hood lock release lever..... 586
 - Wiper lever..... 239,242
- Lexus Climate Concierge**..... 277
- Lexus Safety System +3**..... 373
- License plate lights**
- Headlight switch..... 222
 - Replacing light bulbs..... 738
- Light bulbs**
- Replacing..... 738
- Lights**
- Emergency flashers..... 635
 - Fog light..... 255
 - Front fog lights..... 255
 - Headlight switch..... 222

Rear fog lights.....255
 Wattage.....749
Linked mirror function when reversing 177
Lock
 Smart access system with push-button start.....108
 Window lock switch.....159
LTA.....400

M

Maintenance
 Do-it-yourself maintenance.....584
 General maintenance.....578
 Maintenance data.....742
 Maintenance requirements.....575
Malfunction indicator lamp.....640
Max cool.....286
Max heat.....285
Memory recall function.....273
Meter.....333,340
 Changing the instrument panel light brightness.....365
 Displayed content.....352
 Head-up display.....349
 Indicators.....329
 Multi-information display.....345,347
 Warning lights.....326
Mirror
 Digital Rear-view Mirror.....170
 Inside rear view mirror.....169
Mirrors
 Outside rear view mirrors.....177
Moon roof
 If the moon roof closes but then re-opens slightly.....701

If the moon roof tilts down but then tilts back up.....701
Moving Vehicles Rear of the Vehicle...462
Multi-information display.....345,347
 Operating.....352
 Warning messages.....651
My Room Mode.....86
My Settings.....270

O

Odometer
 Changing/resetting.....339
 Function.....333,340
Oil
 Engine oil.....745
 Rear differential oil.....747
Opener
 Fuel filler door.....218
 Hood.....586
Option screen switch.....282
Outer foot lights.....296
Outside rear view mirrors.....177
 Adjustment.....177
 Blind Spot Monitor.....418
 Folding/extending.....179
 Heaters.....249
 Linked mirror function when reversing...
177
 Mirror position memory.....272
 RCTA function.....443
 Safe Exit Assist (with door opening control).....424
Outside temperature.....333,340
Outside/recirculated air mode.....284
Overheating.....730

P

- Paddle shift switches**.....201
- Panic mode**.....121
- Parking brake**.....207
- Parking brake engaged warning buzzer
.....207
 - Parking brake indicator.....650
- Parking lights**
- Light switch.....222
- PCS**.....388
- PCS (Pre-Collision System)**
- PCS warning light.....647
- Pedestrians Rear of the Vehicle**.....464
- Personal lights**.....298
- PKSB (Parking Support Brake)**...455,458
- Plug-in hybrid system**
- AUTO EV/HV mode.....29,32,34
 - Driving tips.....41
 - EV mode.....29,32,34
 - Features.....26
 - How to charge.....69
 - HV mode.....29,32,34
 - Hybrid battery (traction battery) charge
mode.....29,32,34,35
- Position memory**.....272
- Positions**.....91
- Power (ignition) switch**
- Auto power off function.....184
 - Changing the power switch modes..184
 - How to start the hybrid system.....182
- Power back door**.....130
- Adjusting the open position of the back
door.....142
 - Hands Free Power Back Door.....141
 - Jam protection function.....130
- Power control unit coolant**.....590
- Capacity.....746
 - Checking.....590
- Power switch**
- Stopping the vehicle in an emergency....
.....635
- Power windows**
- Catch protection function.....157
 - Door lock linked window operation.158
 - Jam protection function.....157
 - Operation.....158
 - Window lock switch.....159
- Pre-Collision System**.....388
- Predictive deceleration support**.....36
- Predictive SOC control**.....36

R

- Radiator**.....591
- Overheating.....730
- Rain-sensing windshield wipers**.....239
- RCD (Rear camera detection)**...450,453
- RCTA function**.....443
- Rear doors**
- If the rear doors cannot be opened
from the inside.....699
- Rear passengers' seat belt reminder light**..
.....644
- Rear seats**.....164
- Head restraints.....161
- Rear side marker lights**
- Light switch.....222

- Replacing light bulbs.....738
 - Rear turn signal light**
 - Replacing light bulbs.....738
 - Rear view mirror**
 - Inside rear view mirror..... 169
 - Rear window defogger**
 - Window..... 248
 - Refueling**
 - Capacity..... 744
 - Fuel types.....744
 - If the fuel filler door cannot be opened...
..... 702
 - Regenerative braking.....32**
 - Remote Connect..... 556**
 - Replacing**
 - Fuses..... 734
 - Light bulbs.....738
 - Tire..... 622
 - Replacing the battery.....687**
 - Resetting the message indicating maintenance is required..... 576**
 - Riding with children..... 90,91**
 - 12-volt battery precautions..... 692
 - Child restraint system..... 91
 - Child-protector lock..... 92
 - Seating positions for children..... 91
 - Road Sign Assist.....512**
 - RSA.....512**
 - Run-flat tire..... 604**
-
- S
- S-FLOW.....284**
 - Safe Exit Assist (with door opening control)..... 424**
 - Safety Connect..... 552**
 - Seat**
 - Child restraint system..... 90
 - Seat belt reminder light.....643**
 - Seat belt reminder lights..... 644**
 - Seat belts**
 - Adjusting the height..... 168
 - Automatic Locking Retractor.....167
 - Care.....566
 - Fastening and releasing.....167
 - How to wear your seat belt..... 165
 - Pregnant women, proper seat belt use...
.....165
 - Riding with children.....165
 - Seat belt extender..... 165
 - Seat belt reminder light..... 643
 - Seat belt reminder lights..... 644
 - Seat heaters.....290**
 - Seat position memory..... 272**
 - Seat ventilators..... 292**
 - Seating capacity..... 89**
 - Seats.....160,164**
 - Adjustment.....160
 - Cleaning..... 566
 - Driving position memory.....272
 - Head restraints.....161
 - Memory recall function.....273
 - Power easy access system..... 272
 - Security indicator.....125**
 - Sensor**
 - Automatic headlight system..... 222
 - Inside rear view mirror.....236
 - Raindrop sensor.....240
 - Service Connect.....557**

- Service plug**..... 27
- Service reminder message**..... 576
- Shift lever**..... 192
- Shift position**
- Changing the shift..... 194
 - Changing the shift range..... 201
 - Intended use of each shift position... 192
- Side marker lights**
- Light switch..... 222
- Side turn signal lights**
- Replacing light bulbs..... 738
- Smart access system with push-button start**..... 108
- Affects influenced by the radio wave..... 108
 - Antenna location..... 108
 - Battery-saving function..... 104
 - Entry functions..... 119,135
 - If the electronic key does not operate properly..... 687
 - Starting the hybrid system..... 182
- Spark plug**..... 746
- Specifications**..... 742
- Speedometer**..... 333,340
- Starting the hybrid system**..... 182
- Static Objects Front and Rear of the vehicle**..... 459
- Steering wheel**..... 169
- Adjustment..... 169
 - Electric power steering system warning light..... 643
 - Power easy access system..... 272
 - Steering wheel position memory..... 272
- Stop/tail lights**
- Replacing light bulbs..... 738
- Stopping the vehicle in an emergency** 635
- Sun visors**..... 235
- Switch**
- Fog lights..... 255
 - Front fog lights..... 255
 - Horn..... 256
 - Position memory..... 272
 - Rear fog lights..... 255
 - Seat position memory..... 272
- Switches**
- Adjustment..... 160
 - AUTO EV/HV mode switch..... 34
 - Door lock..... 121
 - Emergency flashers..... 635
 - Engine switch..... 182
 - EV/HV mode selection switch..... 34,35
 - Garage door opener..... 210
 - Ignition switch..... 182
 - Light switches..... 222
 - Meter control..... 352
 - Outside rear view mirrors..... 177
 - Paddle shift switches..... 201
 - Power switch..... 182
 - Power windows..... 158
 - Tilt and telescopic steering control switch..... 169
 - Washer..... 241,244
 - Window lock switch..... 159

- T**
- Tachometer**..... 333,340
- Tail lights**
Light switch..... 222
- Theft deterrent system**
Alarm..... 125
Immobilizer system..... 125
- Tire**..... 600
If you have a flat tire..... 685
Replacing the tire..... 622
Rotating the tires..... 619
Run-flat tire..... 604
Run-flat tires..... 685
Tire inflation pressure..... 616
- Tire inflation pressure**
Maintenance data..... 748
- Tire information**..... 753
Glossary..... 757
Size..... 754
Tire identification number..... 754
Uniform Tire Quality Grading..... 755
- Tire pressure warning system**..... 605
Registering ID codes..... 612
Registration of the position of each wheel..... 608
Selecting wheel set..... 614
Setting the tire pressure..... 609
Tire pressure warning light..... 645
Valves and transmitters..... 607
Warning messages..... 655
- Tires**
Information..... 753
Size..... 748
- Tool**..... 622
- Total load capacity**..... 742
- Towing**
Dinghy towing..... 156
Towing with a tow truck..... 716
Towing with another vehicle..... 719
Trailer towing..... 145,155
Using a flatbed truck..... 718
- Traction battery (hybrid battery)**
Location..... 27
Specification..... 744
- Traction motor (electric motor)**..... 27
- Trailer towing**..... 145,155
- Transmission**
Downshifting restriction warning buzzer..... 201,202
Operation..... 192
- Transmitters**..... 607
- Trip meter**
Changing/resetting..... 339
Function..... 333,340
- V**
- Vehicle data recording**..... 797
- Vehicle identification number**..... 742
- W**
- Warning buzzer**..... 638
- Warning buzzers**
Open door..... 115
Open window..... 157
- Warning label**..... 27
- Warning lights**..... 326,638
ABS warning light..... 641
Brake system warning light..... 638
Charging system warning light..... 639

- Driver's and front passenger's seat belt reminder light..... 643
- Driving assist information indicator. 649
- Dynamic radar cruise control indicator..... 648
- Electric power steering system warning light..... 643
- High coolant temperature warning light..... 639
- Hybrid system overheat warning light..... 639
- Intuitive parking assist OFF indicator..... 647
- LDA indicator..... 648
- Lexus parking assist-sensor OFF indicator..... 647
- Low engine oil pressure warning light..... 640
- Low fuel level warning light..... 643
- LTA indicator..... 648
- Malfunction indicator lamp..... 640
- Parking brake indicator..... 650
- PCS warning light..... 647
- Rear passengers' seat belt reminder light..... 644
- Slip indicator..... 649
- Tire pressure warning light..... 645
- Warning messages..... 651**
- Washer..... 241,244**
- Adding..... 594
- Switches..... 241,244
- Washing and waxing..... 560**
- Weight**
- Cargo capacity..... 89,129
- Load limits..... 89
- Weight..... 742
- Wheel**
- Replacing..... 622
- Wheel bolt wrench..... 622**
- Wheels**
- Size..... 748
- Window lock switch..... 159**
- Windows**
- If the windows do not open or close 727
- Rear window defogger..... 248
- Washer..... 241,244
- Windshield wiper and washer..... 239,241,242,244**
- Wireless remote control..... 121**
- Battery-saving function..... 104
- Open door warning buzzer..... 115
- Operation signals..... 119
- Replacing the battery..... 687

Certification

Millimeter wave radar sensor

FCC ID: HYQDNMWR011

NOTE:

This device complies with part 15 of the FCC Rules. Operation is subject to the following two conditions: (1) This device may not cause harmful interference, and (2) this device must accept any interference received, including interference that may cause undesired operation.

FCC WARNING:

Changes or modifications not expressly approved by the party responsible for compliance could void the user's authority to operate the equipment.

Radiofrequency radiation exposure Information:

This equipment complies with FCC radiation exposure limits set forth for an uncontrolled environment. This equipment should be installed and operated with minimum distance of 20 cm between the radiator (antenna) and your body. This transmitter must not be co-located or operating in conjunction with any other antenna or transmitter.

FCC ID: HYQDNMWR011

NOTE:

This device complies with part 15 of the FCC Rules. Operation is subject to the following two conditions: (1) This device may not cause harmful interference, and (2) this device must accept any interference received, including interference that may cause undesired operation.

FCC WARNING:

Changes or modifications not expressly approved by the party responsible for compliance could void the user's authority to operate the equipment.

Radiofrequency radiation exposure Information:

This equipment complies with FCC radiation exposure limits set forth for an uncontrolled environment. This equipment should be installed and operated with minimum distance of 20 cm between the radiator (antenna) and your body. This transmitter must not be co-located or operating in conjunction with any other antenna or transmitter.

NOTE:

This device contains licence-exempt transmitter(s)/receiver(s) that comply with Innovation, Science and Economic Development Canada's licence-exempt RSS(s). Operation is subject to the following two conditions:

- (1) This device may not cause interference.
- (2) This device must accept any interference, including interference that may cause undesired operation of the device.

This equipment complies with ISED radiation exposure limits set forth for an uncontrolled environment and meets RSS-102 of the ISED radio frequency (RF) Exposure rules. This equipment should be installed and operated keeping the radiator at least 20 cm or more away from person's body.

NOTE:

This device contains licence-exempt transmitter(s)/receiver(s) that comply with Innovation, Science and Economic Development Canada's licence-exempt RSS(s). Operation is subject to the following two conditions:

- (1) This device may not cause interference.
- (2) This device must accept any interference, including interference that may cause undesired operation of the device.

This equipment complies with ISED radiation exposure limits set forth for an uncontrolled environment and meets RSS-102 of the ISED radio frequency (RF) Exposure rules. This equipment should be installed and operated keeping the radiator at least 20 cm or more away from person's body.

NOTE:

L'émetteur/récepteur exempt de licence contenu dans le présent appareil est conforme aux CNR d'Innovation, Sciences et Développement économique Canada applicables aux appareils radio exempts de licence. L'exploitation est autorisée aux deux conditions suivantes :

- 1) L'appareil ne doit pas produire de brouillage;
- 2) L'appareil doit accepter tout brouillage radioélectrique subi, même si le brouillage est susceptible d'en compromettre le fonctionnement.

Cet équipement est conforme aux limites d'exposition aux rayonnements énoncées pour un environnement non contrôlé et respecte les règles d'exposition aux fréquences radioélectriques (RF) CNR-102 de l'ISDE. Cet équipement doit être installé et utilisé en gardant une distance de 20 cm ou plus entre le dispositif rayonnant et le corps.

NOTE:

L'émetteur/récepteur exempt de licence contenu dans le présent appareil est conforme aux CNR d'Innovation, Sciences et Développement économique Canada applicables aux appareils radio exempts de licence. L'exploitation est autorisée aux deux conditions suivantes :

- 1) L'appareil ne doit pas produire de brouillage;
- 2) L'appareil doit accepter tout brouillage radioélectrique subi, même si le brouillage est susceptible d'en compromettre le fonctionnement.

Cet équipement est conforme aux limites d'exposition aux rayonnements énoncées pour un environnement non contrôlé et respecte les règles d'exposition aux fréquences radioélectriques (RF) CNR-102 de l'ISDE. Cet équipement doit être installé et utilisé en gardant une distance de 20 cm ou plus entre le dispositif rayonnant et le corps.

Smart access system with push-button start/Advanced Park (Remote Controlled)

US

FCC ID:HYQ23ABN

FCC ID:HYQ14CBP

FCC ID:HYQ23ABP

FCC ID:HYQ14CCP

FCC ID:HYQ14FLC

FCC ID:HYQ14FLD

NOTE:

This device complies with part 15 of the FCC Rules. Operation is subject to the following two conditions: (1) This device may not cause harmful interference, and (2) this device must accept any interference received, including interference that may cause undesired operation.

FCC WARNING:

Changes or modifications not expressly approved by the party responsible for compliance could void the user's authority to operate the equipment.

<For 14FLC/14FLD>

The FCC ID is affixed inside the equipment. You can find the ID when replacing the battery.

001

US

FCC ID:HYQ23ABN

FCC ID:HYQ14FLC

FCC ID:HYQ14CBP

NOTE:

This device complies with part 15 of the FCC Rules. Operation is subject to the following two conditions: (1) This device may not cause harmful interference, and (2) this device must accept any interference received, including interference that may cause undesired operation.

FCC WARNING:

Changes or modifications not expressly approved by the party responsible for compliance could void the user's authority to operate the equipment.

<For 14FLC>

The FCC ID is affixed inside the equipment. You can find the ID when replacing the battery.

00

CA

NOTE:

This device contains licence-exempt transmitter(s)/receiver(s) that comply with Innovation, Science and Economic Development Canada's licence-exempt RSS(s).

Operation is subject to the following two conditions:

- (1) This device may not cause interference.
- (2) This device must accept any interference, including interference that may cause undesired operation of the device.

<For 14FLC/14FLD>

The IC Certification number is affixed inside the equipment. You can find the number when replacing the battery.

02

NOTE:

This device contains licence-exempt transmitter(s)/receiver(s) that comply with Innovation, Science and Economic Development Canada's licence-exempt RSS(s).

Operation is subject to the following two conditions:

- (1) This device may not cause interference.
- (2) This device must accept any interference, including interference that may cause undesired operation of the device.

<For 14FLC>

The IC Certification number is affixed inside the equipment. You can find the number when replacing the battery.

NOTE:

L'émetteur/récepteur exempt de licence contenu dans le présent appareil est conforme aux CNR d'Innovation, Sciences et Développement économique Canada applicables aux appareils radio exempts de licence.

L'exploitation est autorisée aux deux conditions suivantes :

- (1) L'appareil ne doit pas produire de brouillage;
- (2) L'appareil doit accepter tout brouillage radioélectrique subi, même si le brouillage est susceptible d'en compromettre le fonctionnement.

<Pour 14FLC/14FLD>

Le numéro d'accréditation IC est apposé à l'intérieur de l'appareil. Ce numéro est visible au remplacement de la pile.

CA

NOTE:

L'émetteur/récepteur exempt de licence contenu dans le présent appareil est conforme aux CNR d'Innovation, Sciences et Développement économique Canada applicables aux appareils radio exempts de licence.

L'exploitation est autorisée aux deux conditions suivantes :

- (1) L'appareil ne doit pas produire de brouillage;
- (2) L'appareil doit accepter tout brouillage radioélectrique subi, même si le brouillage est susceptible d'en compromettre le fonctionnement.

<Pour 14FLC>

Le numéro d'accréditation IC est apposé à l'intérieur de l'appareil. Ce numéro est visible au remplacement de la pile.

03

FCC ID: NI4TMLF19D-2

US

NOTE

This device complies with part 15 of the FCC Rules. Operation is subject to the following two conditions: (1) This device may not cause harmful interference, and (2) this device must accept any interference received, including interference that may cause undesired operation.

FCC WARNING

Changes or modifications not expressly approved by the party responsible for compliance could void the user's authority to operate the equipment.

92

FCC ID: NI4TMLF19D-2

US

NOTE

This device complies with part 15 of the FCC Rules. Operation is subject to the following two conditions: (1) This device may not cause harmful interference, and (2) this device must accept any interference received, including interference that may cause undesired operation.

FCC WARNING

Changes or modifications not expressly approved by the party responsible for compliance could void the user's authority to operate the equipment.

92

NOTE

CA

This device contains licence-exempt transmitter(s)/receiver(s) that comply with Innovation, Science and Economic Development Canada's licence-exempt RSS(s). Operation is subject to the following two conditions:

- (1) This device may not cause interference.
- (2) This device must accept any interference, including interference that may cause undesired operation of the device.

811

NOTE

CA

This device contains licence-exempt transmitter(s)/receiver(s) that comply with Innovation, Science and Economic Development Canada's licence-exempt RSS(s). Operation is subject to the following two conditions:

- (1) This device may not cause interference.
- (2) This device must accept any interference, including interference that may cause undesired operation of the device.

811

NOTE

CA

L'émetteur/récepteur exempt de licence contenu dans le présent appareil est conforme aux CNR d'Innovation, Sciences et Développement économique Canada applicables aux appareils radio exempts de licence. L'exploitation est autorisée aux deux conditions suivantes:

- (1) L'appareil ne doit pas produire de brouillage;
- (2) L'appareil doit accepter tout brouillage radioélectrique subi, même si le brouillage est susceptible d'en compromettre le fonctionnement.

811

NOTE

CA

L'émetteur/récepteur exempt de licence contenu dans le présent appareil est conforme aux CNR d'Innovation, Sciences et Développement économique Canada applicables aux appareils radio exempts de licence. L'exploitation est autorisée aux deux conditions suivantes:

- (1) L'appareil ne doit pas produire de brouillage;
- (2) L'appareil doit accepter tout brouillage radioélectrique subi, même si le brouillage est susceptible d'en compromettre le fonctionnement.

811

Digital Key

US

FCC ID:HYQ17EAA

NOTE

This device complies with part 15 of the FCC Rules. Operation is subject to the following two conditions: (1) This device may not cause harmful interference, and (2) this device must accept any interference received, including interference that may cause undesired operation.

FCC WARNING

Changes or modifications not expressly approved by the party responsible for compliance could void the user's authority to operate the equipment.

CAUTION : Radio Frequency Radiation Exposure

This equipment complies with FCC radiation exposure limits set forth for an uncontrolled environment and meets the FCC radio frequency (RF) Exposure Guidelines. This equipment should be installed and operated keeping the radiator at least 20cm or more away from person's body.

Co-location: This transmitter must not be co-located or operated in conjunction with any other antenna or transmitter.

00

This device contains licence-exempt transmitter(s)/receiver(s) that comply with Innovation, Science and Economic Development Canada's licence-exempt RSS(s). Operation is subject to the following two conditions:

- (1) This device may not cause interference.
- (2) This device must accept any interference, including interference that may cause undesired operation of the device.

The antenna cannot be removed (and changed) by user.

Co-location: This transmitter must not be co-located or operated in conjunction with any other antenna or transmitter.

CAUTION: Radio Frequency Radiation Exposure

This equipment complies with ISED radiation exposure limits set forth for an uncontrolled environment and meets RSS-102 of the ISED radio frequency (RF) Exposure rules. This equipment should be installed and operated keeping the radiator at least 20 cm or more away from person's body.

L'émetteur/récepteur exempt de licence contenu dans le présent appareil est conforme aux CNR d'Innovation, Sciences et Développement économique Canada applicables aux appareils radio exempts de licence. L'exploitation est autorisée aux deux conditions suivantes :

- (1) L'appareil ne doit pas produire de brouillage;
- (2) L'appareil doit accepter tout brouillage radioélectrique subi, même si le brouillage est susceptible d'en compromettre le fonctionnement.

L'utilisateur n'est pas autorisé à retirer (ou modifier) l'antenne.

Emplacement : Cet émetteur ne doit pas être installé ou utilisé conjointement avec d'autres antennes ou émetteurs.

ATTENTION : exposition aux radiofréquences

Cet équipement est conforme aux limites d'exposition aux rayonnements d'ISDE établies pour un environnement non contrôlé ainsi que la norme CNR-102 de la réglementation d'ISDE relative à l'exposition aux radiofréquences (RF). Cet équipement doit être installé et utilisé avec un minimum de 20 cm de distance entre la source de rayonnement et le corps.

Immobilizer system

FCC ID: NI4TMLF19D-2

US

NOTE

This device complies with part 15 of the FCC Rules. Operation is subject to the following two conditions: (1) This device may not cause harmful interference, and (2) this device must accept any interference received, including interference that may cause undesired operation.

FCC WARNING

Changes or modifications not expressly approved by the party responsible for compliance could void the user's authority to operate the equipment.

FCC ID: NI4TMLF19D-2

US

NOTE

This device complies with part 15 of the FCC Rules. Operation is subject to the following two conditions: (1) This device may not cause harmful interference, and (2) this device must accept any interference received, including interference that may cause undesired operation.

FCC WARNING

Changes or modifications not expressly approved by the party responsible for compliance could void the user's authority to operate the equipment.

92

NOTE

CA

This device contains licence-exempt transmitter(s)/receiver(s) that comply with Innovation, Science and Economic Development Canada's licence-exempt RSS(s). Operation is subject to the following two conditions:

- (1) This device may not cause interference.
- (2) This device must accept any interference, including interference that may cause undesired operation of the device.

811

NOTE

CA

This device contains licence-exempt transmitter(s)/receiver(s) that comply with Innovation, Science and Economic Development Canada's licence-exempt RSS(s). Operation is subject to the following two conditions:

- (1) This device may not cause interference.
- (2) This device must accept any interference, including interference that may cause undesired operation of the device.

811

NOTE

CA

L'émetteur/récepteur exempt de licence contenu dans le présent appareil est conforme aux CNR d'Innovation, Sciences et Développement économique Canada applicables aux appareils radio exempts de licence. L'exploitation est autorisée aux deux conditions suivantes:

- (1) L'appareil ne doit pas produire de brouillage;
- (2) L'appareil doit accepter tout brouillage radioélectrique subi, même si le brouillage est susceptible d'en compromettre le fonctionnement.

811

NOTE

CA

L'émetteur/récepteur exempt de licence contenu dans le présent appareil est conforme aux CNR d'Innovation, Sciences et Développement économique Canada applicables aux appareils radio exempts de licence. L'exploitation est autorisée aux deux conditions suivantes:

- (1) L'appareil ne doit pas produire de brouillage;
- (2) L'appareil doit accepter tout brouillage radioélectrique subi, même si le brouillage est susceptible d'en compromettre le fonctionnement.

811

Tire pressure warning system

FCC ID: PAXPMVE000

NOTE

This device complies with part 15 of the FCC Rules. Operation is subject to the following two conditions:

- (1) This device may not cause harmful interference, and (2) this device must accept any interference received, including interference that may cause undesired operation.

FCC WARNING

Changes or modifications not expressly approved by the party responsible for compliance could void the user's authority to operate the equipment.

FCC ID: PAXPMVE100

NOTE

This device complies with part 15 of the FCC Rules. Operation is subject to the following two conditions: (1) This device may not cause harmful interference, and (2) this device must accept any interference received, including interference that may cause undesired operation.

FCC WARNING

Changes or modifications not expressly approved by the party responsible for compliance could void the user's authority to operate the equipment.

NOTE

This device complies with Industry Canada licence-exempt RSS standard(s). Operation is subject to the following two conditions: (1) this device may not cause interference, and (2) this device must accept any interference, including interference that may cause undesired operation of the device.

NOTE

Le présent appareil est conforme aux CNR d'Industrie Canada applicables aux appareils radio exempts de licence. L'exploitation est autorisée aux deux conditions suivantes : (1) l'appareil ne doit pas produire de brouillage, et (2) l'utilisateur de l'appareil doit accepter tout brouillage radioélectrique subi, même si le brouillage est susceptible d'en compromettre le fonctionnement.

"Perchlorate Material – special handling may apply, See www.dtsc.ca.gov/hazardouswaste/perchlorate."

Safety Connect

FCC ID: JOYCW1011

NOTE

This device complies with part 15 of the FCC Rules. Operation is subject to the following two conditions: (1) This device may not cause harmful interference, and (2) this device must accept any interference received, including interference that may cause undesired operation.

FCC WARNING

Changes or modifications not expressly approved by the party responsible for compliance could void the user's authority to operate the equipment.

Co-location: This transmitter must not be co-located or operated in conjunction with any other antenna or transmitter.

CAUTION : Radio Frequency Radiation Exposure

This equipment complies with FCC radiation exposure limits set forth for an uncontrolled environment and meets the FCC radio frequency (RF) Exposure Guidelines. This equipment should be installed and operated keeping the radiator at least 20cm or more away from person's body.

IC: 574B-CW1011

NOTE

This device contains licence-exempt transmitter(s)/receiver(s) that comply with Innovation, Science and Economic Development Canada's licence-exempt RSS(s). Operation is subject to the following two conditions:

- (1) This device may not cause interference.
- (2) This device must accept any interference, including interference that may cause undesired operation of the device.

The antenna cannot be removed (and changed) by user.

Co-location: This transmitter must not be co-located or operated in conjunction with any other antenna or transmitter.

CAUTION: Radio Frequency Radiation Exposure

This equipment complies with ISED radiation exposure limits set forth for an uncontrolled environment and meets RSS-102 of the ISED radio frequency (RF) Exposure rules. This equipment should be installed and operated keeping the radiator at least 20 cm or more away from person's body.

NOTE

L'émetteur/récepteur exempt de licence contenu dans le présent appareil est conforme aux CNR d'Innovation, Sciences et Développement

économique Canada applicables aux appareils radio exempts de licence. L'exploitation est autorisée aux deux conditions suivantes :

- (1) L'appareil ne doit pas produire de brouillage;
- (2) L'appareil doit accepter tout brouillage radioélectrique subi, même si le brouillage est susceptible d'en compromettre le fonctionnement.

L'utilisateur n'est pas autorisé à retirer (ou modifier) l'antenne.

Emplacement: Cet émetteur ne doit pas être installé ou utilisé conjointement avec d'autres antennes ou émetteurs.

ATTENTION : exposition aux radiofréquences

Cet équipement est conforme aux limites d'exposition aux rayonnements ISDE établies pour un environnement non contrôlé et satisfait à la norme CNR-102 de la réglementation ISDE sur l'exposition aux radiofréquences (RF). Cet équipement doit être installé et utilisé avec un minimum de 20 cm de distance entre la source de rayonnement et le corps.

BSM (Blind Spot Monitor)

FCC ID : OAYSRR3A

This device complies with part 15 of the FCC Rules. Operation is subject to the following two conditions:

- (1) This device may not cause harmful interference, and
- (2) this device must accept any interference received, including interference that may cause undesired operation.

FCC Warning

Changes or modifications not expressly approved by the party responsible for compliance could void the user's authority to operate the equipment.

C3-002

FCC ID : OAYSRR3A

This device complies with part 15 of the FCC Rules. Operation is subject to the following two conditions:

- (1) This device may not cause harmful interference, and
- (2) this device must accept any interference received, including interference that may cause undesired operation.

FCC Warning

Changes or modifications not expressly approved by the party responsible for compliance could void the user's authority to operate the equipment.

C3-002

This device contains licence-exempt transmitter(s)/receiver(s) that comply with Innovation, Science and Economic Development Canada's licence-exempt RSS(s). Operation is subject to the following two conditions:

1. This device may not cause interference.
2. This device must accept any interference, including interference that may cause undesired operation of the device.

Radiofrequency radiation exposure information:

This equipment complies with radiation exposure limits set forth for an uncontrolled environment. This equipment should be installed and operated with minimum distance of 20 cm between the radiator and your body.

C3-005

This device contains licence-exempt transmitter(s)/receiver(s) that comply with Innovation, Science and Economic Development Canada's licence-exempt RSS(s). Operation is subject to the following two conditions:

1. This device may not cause interference.
2. This device must accept any interference, including interference that may cause undesired operation of the device.

Radiofrequency radiation exposure information:

This equipment complies with radiation exposure limits set forth for an uncontrolled environment. This equipment should be installed and operated with minimum distance of 20 cm between the radiator and your body.

C3-005

L'émetteur/récepteur exempt de licence contenu dans le présent appareil est conforme aux CNR d'Innovation, Sciences et Développement économique Canada applicables aux appareils radio exempts de licence. L'exploitation est autorisée aux deux conditions suivantes:

1. L'appareil ne doit pas produire de brouillage;
2. L'appareil doit accepter tout brouillage radioélectrique subi, même si le brouillage est susceptible d'en compromettre le fonctionnement.

Informations sur l'exposition aux rayonnements radiofréquences:

Cet équipement est conforme aux limites d'exposition aux rayonnements définies pour un environnement non contrôlé. Cet équipement doit être installé et utilisé avec un minimum de 20 cm de distance entre la source de rayonnement et votre corps.

C3-006

L'émetteur/récepteur exempt de licence contenu dans le présent appareil est conforme aux CNR d'Innovation, Sciences et Développement économique Canada applicables aux appareils radio exempts de licence. L'exploitation est autorisée aux deux conditions suivantes:

1. L'appareil ne doit pas produire de brouillage;
2. L'appareil doit accepter tout brouillage radioélectrique subi, même si le brouillage est susceptible d'en compromettre le fonctionnement.

Informations sur l'exposition aux rayonnements radiofréquences:

Cet équipement est conforme aux limites d'exposition aux rayonnements définies pour un environnement non contrôlé. Cet équipement doit être installé et utilisé avec un minimum de 20 cm de distance entre la source de rayonnement et votre corps.

C3-006

Wireless charger

FCC ID: ACJ932AT2001

NOTE:

This device complies with part 15 and part 18 of the FCC Rules. Operation is subject to the following two conditions: (1) This device may not cause harmful interference, and (2) this device must accept any interference received, including interference that may cause undesired operation.

FCC CAUTION

Changes or modifications not expressly approved by the party responsible for compliance could void the user's authority to operate the equipment.

This equipment has been tested and found to comply with the limits for a wireless power charger, pursuant to part 18 of the FCC Rules.

This equipment generates, uses and can radiate radio frequency energy and, if not installed and used in accordance with the instructions, may cause harmful interference to radio communications.

However, there is no guarantee that interference will not occur in a particular installation.

If this equipment does cause harmful interference to radio communications, which can be determined by turning the equipment off and on, the user is encouraged to try to correct the interference by one or more of the following measures:

- Reorient or relocate the receiving antenna.
- Increase the separation between the equipment and receiver.
- Connect the equipment into an outlet on a circuit different from that to which the receiver is connected.

This equipment complies with FCC radiation exposure limits set forth for an uncontrolled environment and meets the FCC radio frequency (RF) Exposure Guidelines. This equipment should be installed and operated keeping the radiator at least 20cm or more away from person's body.

This device contains licence-exempt transmitter(s)/receiver(s) that comply with Innovation, Science and Economic Development Canada's licence-exempt RSS(s). Operation is subject to the following two conditions:

- (1) This device may not cause interference.
- (2) This device must accept any interference, including interference that may cause undesired operation of the device.

L'émetteur/récepteur exempt de licence contenu dans le présent appareil est conforme aux CNR d'Innovation, Sciences et Développement économique Canada applicables aux appareils radio exempts de licence. L'exploitation est autorisée aux deux conditions suivantes :

- 1) L'appareil ne doit pas produire de brouillage;
- 2) L'appareil doit accepter tout brouillage radioélectrique subi, même si le brouillage est susceptible d'en compromettre le fonctionnement.

CAUTION

This equipment complies with ISED radiation exposure limits set forth for an uncontrolled environment and meets RSS-102 of the ISED radio frequency (RF) Exposure rules. This equipment should be installed and operated keeping the radiator at least 20cm or more away from person's body.

Cet équipement est conforme aux limites d'exposition aux rayonnements énoncées pour un environnement non contrôlé et respecte les règles d'exposition aux fréquences radioélectriques (RF) CNR-102 de l'ISDE. Cet équipement doit être installé et utilisé en gardant une distance de 20 cm ou plus entre le radiateur et le corps humain.

Garage door opener

This device complies with FCC rules part 15 and Innovation, Science, and Economic Development Canada RSS-210. Operation is subject to the following two conditions: (1) This device may not cause harmful interference, and (2) This device must accept any interference that may be received including interference that may cause undesired operation. WARNING: The transmitter has been tested and complies with FCC and ISED rules. Changes or modifications not expressly approved by the party responsible for compliance could void the user's authority to operate the device.

This equipment complies with FCC and ISED radiation exposure limits set forth for an uncontrolled environment. End Users must follow the specific operating instructions for satisfying RF exposure compliance. This transmitter must be at least 20 cm from the user and must not be co-located or operating in conjunction with any other antenna or transmitter.

This device complies with FCC rules part 15 and Innovation, Science, and Economic Development Canada RSS-210. Operation is subject to the following two conditions: (1) This device may not cause harmful interference, and (2) This device must accept any interference that may be received including interference that may cause undesired operation. WARNING: The transmitter has been tested and complies with FCC and ISED rules. Changes or modifications not expressly approved by the party responsible for compliance could void the user's authority to operate the device.

This equipment complies with FCC and ISED radiation exposure limits set forth for an uncontrolled environment. End Users must follow the specific operating instructions for satisfying RF exposure compliance. This transmitter must be at least 20 cm from the user and must not be co-located or operating in conjunction with any other antenna or transmitter.

Cet appareil est conforme aux règlements de la FCC, section 15, et au CNR-210 d'Innovation, Sciences et Développement économique Canada. Le fonctionnement est assujéti aux deux conditions suivantes : (1) cet appareil ne doit pas causer d'interférences nuisibles et (2) cet appareil doit accepter toute interférence reçue, y compris celle qui pourrait entraîner un dysfonctionnement. MISE EN GARDE : L'émetteur a subi des tests et est conforme aux règlements de la FCC et d'ISDE. Les changements ou modifications non approuvés explicitement par la partie responsable de la conformité pourraient rendre caduque l'autorisation de l'utilisateur de se servir du dispositif.

Cet appareil est conforme aux limites d'exposition aux radiations de la FCC et d'ISDE établies pour un environnement non contrôlé. Les utilisateurs finaux doivent respecter les instructions d'utilisation spécifiques pour satisfaire aux exigences de conformité aux expositions de RF. L'émetteur doit se trouver à 20 cm au minimum de l'utilisateur et ne doit pas être situé au même endroit que tout autre émetteur ou antenne ni fonctionner avec un autre émetteur ou antenne.



Owner's Manual:
Publication No. OM78343U
Part No. 01999-78343
Printed in Japan 01-2210-001
NX450h+ (北米U)