



owner.ford.com



ford.ca

2020 **SUPER DUTY** Owner's Manual



March 2020
Second Printing
Litho in U.S.A.



LC3J19A321 AA



The information contained in this publication was correct at the time of going to print. In the interest of continuous development, we reserve the right to change specifications, design or equipment at any time without notice or obligation. No part of this publication may be reproduced, transmitted, stored in a retrieval system or translated into any language in any form by any means without our written permission. Errors and omissions excepted.

© Ford Motor Company 2020

All rights reserved.

Part Number: 201909 20200128195653

California Proposition 65



WARNING: Operating, servicing and maintaining a passenger vehicle or off-highway motor vehicle can expose you to chemicals including engine exhaust, carbon monoxide, phthalates, and lead, which are known to the State of California to cause cancer and birth defects or other reproductive harm. To minimize exposure, avoid breathing exhaust, do not idle the engine except as necessary, service your vehicle in a well-ventilated area and wear gloves or wash your hands frequently when servicing your vehicle. For more information go to www.P65Warnings.ca.gov/passenger-vehicle.



WARNING: Battery posts, terminals and related accessories contain lead and lead compounds, chemicals known to the State of California to cause cancer and reproductive harm.
Wash your hands after handling.

Table of Contents

Introduction

About This Manual	9
Symbols Glossary	10
Data Recording	12
Perchlorate	16
Ford Credit	16
Replacement Parts Recommendation	16
Special Notices	17
Mobile Communications Equipment	18
Export Unique Options	18

Environment

Protecting the Environment	19
----------------------------------	----

At a Glance

Instrument Panel	20
------------------------	----

Child Safety

General Information	22
Installing Child Restraints	24
Booster Seats	33
Child Restraint Positioning	35
Child Safety Locks	37

Seatbelts

Principle of Operation	38
Fastening the Seatbelts	39
Seatbelt Height Adjustment	42
Seatbelt Warning Lamp and Indicator Chime	42
Seatbelt Reminder	43
Child Restraint and Seatbelt Maintenance	44
Seatbelt Extensions	44

Supplementary Restraints System

Principle of Operation	45
------------------------------	----

Driver and Passenger Airbags	46
Side Airbags	51
Safety Canopy™	52
Crash Sensors and Airbag Indicator	53
Airbag Disposal	54

Keys and Remote Controls

General Information on Radio Frequencies	55
Remote Control	55
Replacing a Lost Key or Remote Control	61

MyKey™

Principle of Operation	62
Creating a MyKey	63
Clearing All MyKeys	64
Checking MyKey System Status	64
Using MyKey With Remote Start Systems	64
MyKey – Troubleshooting	64

Doors and Locks

Locking and Unlocking	66
Keyless Entry	69

Tailgate

Tailgate Lock	71
Electronic Tailgate	71
Removing the Tailgate	72
Tailgate Step	72
Bed Extender	73

Security

Passive Anti-Theft System	76
Anti-Theft Alarm	78

Power Running Boards

Using Power Running Boards	80
----------------------------------	----

Table of Contents

Steering Wheel

Adjusting the Steering Wheel - Vehicles With: Manual Adjustable Steering Column	82
Adjusting the Steering Wheel - Vehicles With: Power Adjustable Steering Column	82
Audio Control	84
Voice Control	84
Cruise Control - Vehicles With: Cruise Control	84
Cruise Control - Vehicles With: Adaptive Cruise Control	85
Information Display Control	85
Heated Steering Wheel	85
Horn	85

Adjustable Pedals

Adjusting the Pedals	86
----------------------------	----

Wipers and Washers

Windshield Wipers	87
Autowipers	87
Windshield Washers	88

Lighting

General Information	89
Lighting Control	89
Autolamps	90
Instrument Lighting Dimmer	90
Daytime Running Lamps - Vehicles With: Configurable Daytime Running Lamps	90
Daytime Running Lamps - Vehicles With: Daytime Running Lamps (DRL)	91
Front Fog Lamps	91
Direction Indicators	92
Spot Lamps	92
Interior Lamps	92
Ambient Lighting	93
Cargo Lamps	93

Automatic High Beam Control

What Is Automatic High Beam Control	95
Switching Automatic High Beam Control On and Off	95
Automatic High Beam Control Indicators	95
Overriding Automatic High Beam Control	95

Windows and Mirrors

Power Windows	97
Global Opening	98
Exterior Mirrors	98
Interior Mirror	101
Sliding Windows	101
Sun Visors	102
Moonroof	102

Instrument Cluster

Gauges	104
Warning Lamps and Indicators	107
Audible Warnings and Indicators	111

Information Displays

General Information	112
Information Messages	123

Climate Control

Manual Climate Control	142
Automatic Climate Control	143
Hints on Controlling the Interior Climate - Vehicles With: Automatic Temperature Control	145
Hints on Controlling the Interior Climate - Vehicles With: Manual Temperature Control	146
Heated Windshield	147
Heated Rear Window	147
Heated Exterior Mirrors	147

Table of Contents

Remote Start	147
--------------------	-----

Interior Air Quality

What Is the Cabin Air Filter	149
Locating the Cabin Air Filter	149
Replacing the Cabin Air Filter	149

Seats

Sitting in the Correct Position	150
Head Restraints	150
Manual Seats	152
Power Seats	153
Memory Function	156
Rear Seats	157
Heated Seats	159
Ventilated Seats	160

Rear Occupant Alert System

What is the Rear Occupant Alert System	161
How Does the Rear Occupant Alert System Work	161
Rear Occupant Alert System Precautions	161
Rear Occupant Alert System Limitations	161
Switching Rear Occupant Alert System On and Off - Vehicles With: SYNC	161
Switching Rear Occupant Alert System On and Off - Vehicles With: SYNC 3	161
Rear Occupant Alert System Indicators - Vehicles With: SYNC	162
Rear Occupant Alert System Indicators - Vehicles With: SYNC 3	162
Rear Occupant Alert System Audible Warnings	162

Garage Door Opener

Universal Garage Door Opener	163
------------------------------------	-----

Auxiliary Power Points

Auxiliary Power Points	167
Wireless Accessory Charging	168

Storage Compartments

Center Console	171
Overhead Console	171
Under Seat Storage	171

Starting and Stopping the Engine

General Information	174
Ignition Switch	174
Keyless Starting	175
Starting a Gasoline Engine - 6.2L/7.3L	175
Starting a Diesel Engine - 6.7L Diesel	177
Switching Off the Engine - 6.7L Diesel	182
Engine Idle Shutdown	182
Engine Block Heater	182

Fuel and Refueling

Safety Precautions	184
Fuel Quality - E85	185
Fuel Quality - Gasoline	186
Fuel Quality - Diesel	187
Running Out of Fuel	189
Refueling - Gasoline	189
Refueling - Diesel	190
Fuel Consumption	193

Engine Emission Control

Emission Law	194
Catalytic Converter	195
Selective Catalytic Reductant System - Diesel	197
Diesel Particulate Filter	202

Table of Contents

Transmission

Automatic Transmission	207
Power Take-Off	211

Four-Wheel Drive

Using Four-Wheel Drive	212
------------------------------	-----

Rear Axle

Limited Slip Differential	220
Electronic Locking Differential	220

Brakes

General Information	222
Hints on Driving With Anti-Lock Brakes	224
Parking Brake	224
Hill Start Assist	224

Traction Control

Principle of Operation	226
Using Traction Control	226

Stability Control

Principle of Operation	227
Using Stability Control	228

Trail Control

What Is Trail Control	230
Switching Trail Control On and Off	230
Setting the Trail Control Speed	230
Canceling the Set Speed	230
Trail Control Indicators	230

Terrain Control

Principle of Operation	231
Using Hill Descent Control	231

Parking Aids

Principle of Operation	233
------------------------------	-----

Rear Parking Aid	233
Rear View Camera	234
360 Degree Camera	237

Cruise Control

What Is Cruise Control	241
Switching Cruise Control On and Off	241
Setting the Cruise Control Speed	241
Canceling the Set Speed	241
Resuming the Set Speed	242
Cruise Control Indicators	242
Using Adaptive Cruise Control	242

Driving Aids

Driver Alert	249
Lane Keeping System	250
Blind Spot Information System	253
Cross Traffic Alert	258
Steering	261
Pre-Collision Assist	263
Drive Control	267

Load Carrying

Load Limit	270
Bed Ramps	274

Towing

Towing a Trailer	277
Trailer Reversing Aids	279
Trailer Sway Control	295
Recommended Towing Weights	295
Essential Towing Checks	300
Towing the Vehicle on Four Wheels	309

Driving Hints

Economical Driving	312
Off-Road Driving	312
Breaking-In	315

Table of Contents

Driving Through Water	315	Engine Oil Dipstick - 6.2L	346
Snow Plowing	316	Engine Oil Dipstick - 6.7L Diesel	346
Floor Mats	318	Engine Oil Dipstick - 7.3L	346
Roadside Emergencies		Engine Oil Check - 6.2L	346
Roadside Assistance	320	Engine Oil Check - 6.7L Diesel	347
Hazard Flashers	321	Engine Oil Check - 7.3L	348
Fire Extinguisher	321	Changing the Engine Oil and Oil Filter	350
Warning Triangle	321	Oil Change Indicator Reset	350
Fuel Shutoff	321	Changing the Engine Air Filter - 6.2L	351
Jump Starting the Vehicle	322	Changing the Engine Air Filter - 6.7L Diesel	352
Post-Crash Alert System	324	Changing the Engine Air Filter - 7.3L	354
Transporting the Vehicle	324	Draining the Fuel Filter Water Trap - 6.7L Diesel	355
Towing Points	325	Engine Coolant Check - 6.2L	358
Customer Assistance		Engine Coolant Check - 6.7L Diesel	362
Getting the Services You Need	327	Engine Coolant Check - 7.3L	365
In California (U.S. Only)	328	Automatic Transmission Fluid Check	370
The Better Business Bureau (BBB) Auto Line Program (U.S. Only)	329	Transfer Case Fluid Check	371
Utilizing the Mediation/Arbitration Program (Canada Only)	330	Brake Fluid Check	371
Getting Assistance Outside the U.S. and Canada	330	Power Steering Fluid Check	372
Ordering Additional Owner's Literature	332	Changing the 12V Battery	373
Reporting Safety Defects (U.S. Only)	332	Adjusting the Headlamps	375
Reporting Safety Defects (Canada Only)	332	Washer Fluid Check	376
Fuses		Fuel Filter - 6.2L	376
Fuse Specification Chart	334	Checking the Wiper Blades	376
Changing a Fuse	340	Changing the Wiper Blades	376
Maintenance		Changing a Bulb	377
General Information	342	Changing the Engine-Mounted and Diesel Fuel Conditioner Module Fuel Filters - 6.7L Diesel	380
Opening and Closing the Hood	342	Spring U-Bolt Check - F-600	383
Under Hood Overview - 6.2L	343	Vehicle Care	
Under Hood Overview - 6.7L Diesel	344	General Information	385
Under Hood Overview - 7.3L	345	Cleaning Products	385
		Cleaning the Exterior	385
		Waxing	387

Table of Contents

Cleaning the Engine	387
Cleaning the Exhaust - 6.7L Diesel	387
Cleaning the Windows and Wiper Blades	388
Cleaning the Interior	388
Cleaning the Instrument Panel and Instrument Cluster Lens	390
Cleaning Leather Seats	390
Repairing Minor Paint Damage	392
Cleaning the Wheels	392
Vehicle Storage	392

Wheels and Tires

General Information	395
Tire Care	397
Using Snow Chains	413
Tire Pressure Monitoring System	414
Changing a Road Wheel	422
Technical Specifications	431

Capacities and Specifications

Engine Specifications - 6.2L	433
Engine Specifications - 6.7L Diesel	433
Engine Specifications - 7.3L	434
Motorcraft Parts - 6.2L	435
Motorcraft Parts - 6.7L Diesel	437
Motorcraft Parts - 7.3L	438
Vehicle Identification Number	439
Vehicle Certification Label	440
Transmission Code Designation	440
Capacities and Specifications - 6.2L	441
Capacities and Specifications - 6.7L Diesel	450
Capacities and Specifications - 7.3L	461
Bulb Specification Chart	471

Network Connectivity

Connecting the Vehicle to a Mobile Network	474
Network Connectivity – Troubleshooting	475

Vehicle Wi-Fi Hotspot

Creating a Vehicle Wi-Fi Hotspot	477
Changing the Vehicle Wi-Fi Hotspot Name or Password	477

Audio System

General Information	478
Audio Unit - Vehicles With: AM/FM/ Touchscreen Display/SYNC 3	478
Audio Unit - Vehicles With: SYNC	480
Digital Radio	482
Satellite Radio	484
USB Port	487

SYNC™

General Information	488
Using Voice Recognition	489
Using SYNC™ With Your Phone	491
SYNC™ Applications and Services	492
Using SYNC™ With Your Media Player	495
SYNC™ Troubleshooting	496

SYNC™ 3

General Information	505
Using Voice Recognition	507
Entertainment	513
Climate	523
Phone	525
Navigation	527
Apps	532
Settings	535
SYNC™ 3 Troubleshooting	537

Table of Contents

Accessories

Accessories	550
Auxiliary Switches	551

Ford Protect

Ford Protect	555
--------------------	-----

Scheduled Maintenance

General Maintenance Information	557
Normal Scheduled Maintenance	560
Special Operating Conditions Scheduled Maintenance	566
Scheduled Maintenance Record	575

Appendices

Electromagnetic Compatibility	585
End User License Agreement	588
Declaration of Conformity	613
Declaration of Conformity - Vehicles With: SYNC 3	613

Introduction

ABOUT THIS MANUAL

Thank you for choosing Ford. We recommend that you take some time to get to know your vehicle by reading this manual. The more that you know about your vehicle, the greater the safety and pleasure you will get from driving it.



WARNING: Driving while distracted can result in loss of vehicle control, crash and injury. We strongly recommend that you use extreme caution when using any device that may take your focus off the road. Your primary responsibility is the safe operation of your vehicle. We recommend against the use of any hand-held device while driving and encourage the use of voice-operated systems when possible. Make sure you are aware of all applicable local laws that may affect the use of electronic devices while driving.

Note: *This manual describes product features and options available throughout the range of available models, sometimes even before they are generally available. It may describe options that are not on your vehicle. It is possible that either Ford Motor Company or an authorized Ford dealer may have originally sold an incomplete vehicle to a vehicle modifier who upfitted it. As a result, some of the options and features on this vehicle may differ from what we describe in this manual.*

Note: *Some of the illustrations in this manual may show features as used in different models, so they may appear differently to you on your vehicle.*

Note: *Always use and operate your vehicle in line with all applicable laws and regulations.*

Note: *Pass on this manual when selling your vehicle. It is an integral part of the vehicle.*

Note: *Your vehicle's powertrain control systems can detect and store information about vehicle modifications that increase horsepower and torque output such as whether or not performance-enhancing powertrain components commonly referred to as performance chips have been used. This information will stay in the system's memory and cannot be erased even if the modification is removed. Ford Motor Company, Ford of Canada, Ford of Mexico and service or repair facilities can retrieve this information when servicing your vehicle. Ford Motor Company may use this information to determine if your warranty covers any needed repairs.*

Note: *Some aftermarket products may cause severe engine, transmission and exhaust system damage. See your warranty information for more details.*

Your new diesel engine may feel, drive and function somewhat differently than a gasoline engine. Therefore, it is very important that you read and thoroughly familiarize yourself and others operating the vehicle with this guide. There is a special procedure for turning off the diesel engine. See **Starting a Diesel Engine** (page 177). It is important to read and understand this material in order to maintain the best service life for your engine.

Ford may discontinue models or change specifications without any notice and without incurring obligations.

This manual may qualify the location of a component as left-hand side or right-hand side. The side is determined when facing forward in the seat.

Introduction



E154903

A Right-hand side

B Left-hand side

Note: Throughout this guide, you will find warnings identified by the warning symbol. Warnings remind you to be especially careful to reduce the risk of personal injury.

SYMBOLS GLOSSARY

These are some of the symbols you may see on your vehicle.



Air conditioning system



Air conditioning system lubricant type



Anti-lock braking system



Avoid smoking, flames or sparks



Battery



Battery acid



Brake fluid - non petroleum based



Brake system



Brake system



Cabin air filter



Check fuel cap



Child safety door lock or unlock



Child seat lower anchor



Child seat tether anchor



Cruise control



Do not open when hot



Engine air filter



Engine coolant



Engine coolant temperature



Engine oil



Explosive gas

Introduction



Fan warning



Fasten seatbelt



Flammable



Front airbag



Front fog lamps



Fuel pump reset



Fuse compartment



Hazard flashers



Heated rear window



Windshield defrosting system



Interior luggage compartment release



Jack



Keep out of reach of children



Lighting control



Low tire pressure warning



Maintain correct fluid level



Note operating instructions



Horn control



Panic alarm



Parking aid



Parking brake



Power steering fluid



Power windows front/rear



Power window lockout



Requires registered technician



Safety alert



See Owner's Manual



See Service Manual



Service engine soon



Passenger airbag activated

Introduction



Passenger airbag deactivated



Side airbag



Shield the eyes



Stability control



Hill descent control



Trail control



Windshield wiping system



Windshield wash and wipe

DATA RECORDING



WARNING: Do not connect wireless plug-in devices to the data link connector. Unauthorized third parties could gain access to vehicle data and impair the performance of safety related systems. Only allow repair facilities that follow our service and repair instructions to connect their equipment to the data link connector.

We respect your privacy and are committed to protecting it. The information contained in this publication was correct at the time of going to print, but as technology rapidly changes, we recommend that you visit the regional Ford website for the latest information.

Your vehicle has electronic control units that have data recording functionality and the ability to permanently or temporarily store data. This data could include information on the condition and status of your vehicle, vehicle maintenance requirements, events and malfunctions. The types of data that can be recorded are described in this section. Some of the data recorded is stored in event logs or error logs.

Note: *Error logs are reset following a service or repair.*

Note: *We may provide information in response to requests from law enforcement, other government authorities and third parties acting with lawful authority or through a legal process. Such information could be used by them in legal proceedings.*

Data recorded includes, for example:

- Operating states of system components, for example, fuel level, tire pressure and battery charge level.
- Vehicle and component status, for example, wheel speed, deceleration, lateral acceleration and seatbelt status.
- Events or errors in essential systems, for example, headlamps and brakes.
- System responses to driving situations, for example, airbag deployment and stability control.
- Environmental conditions, for example, temperature.

Some of this data, when used in combination with other information, for example, an accident report, damage to a vehicle or eyewitness statements, could be associated with a specific person.

Introduction

Service Data

Service data recorders in your vehicle are capable of collecting and storing diagnostic information about your vehicle. This potentially includes information about the performance or status of various systems and modules in the vehicle, such as engine, throttle, steering or brake systems. In order to properly diagnose and service your vehicle, Ford Motor Company (Ford of Canada in Canada), and service and repair facilities may access or share among them vehicle diagnostic information received through a direct connection to your vehicle when diagnosing or servicing your vehicle. Additionally, Ford Motor Company (Ford of Canada, in Canada) may, where permitted by law, use vehicle diagnostic information for vehicle improvement or with other information we may have about you, for example, your contact information, to offer you products or services that may interest you. Data may be provided to our service providers such as part suppliers that may help diagnose malfunctions, and who are similarly obligated to protect data. We retain this data only as long as necessary to perform these functions or to comply with law. We may provide information where required in response to official requests to law enforcement or other government authorities or third parties acting with lawful authority or court order, and such information may be used in legal proceedings. For U.S. only (if equipped), if you choose to use connected apps and services, you consent that certain diagnostic information may also be accessed electronically by Ford Motor Company and Ford authorized service facilities, and that the diagnostic information may be used to provide services to you, personalizing your experience, troubleshoot, and to improve products and services and offer you products and services that may interest

you, where permitted by law. For Canada only, for more information, please review the Ford of Canada privacy policy at www.ford.ca, including our U.S. data storage and use of service providers in other jurisdictions who may be subject to legal requirements in Canada, the United States and other countries applicable to them, for example, lawful requirements to disclose personal information to governmental authorities in those countries.

Event Data

This vehicle is equipped with an event data recorder. The main purpose of an event data recorder is to record, in certain crash or near crash-like situations, such as an airbag deployment or hitting a road obstacle; this data assist in understanding how a vehicle's systems performed. The event data recorder is designed to record data related to vehicle dynamics and safety systems for a short period of time, typically 30 seconds or less.

The event data recorder in this vehicle is designed to record such data as:

- How various systems in your vehicle were operating;
- Whether or not the driver and passenger seatbelts were buckled/fastened;
- How far (if at all) the driver was depressing the accelerator and/or the brake pedal; and
- How fast the vehicle was traveling; and
- Where the driver was positioning the steering wheel.

This data can help provide a better understanding of the circumstances in which crashes and injuries occur.

Introduction

Note: *Event data recorder data is recorded by your vehicle only if a non-trivial crash situation occurs; no data is recorded by the event data recorder under normal driving conditions and no personal data or information (e.g., name, gender, age, and crash location) is recorded. However, other parties, such as law enforcement, could combine the event data recorder data with the type of personally identifying data routinely acquired during a crash investigation.*

To read data recorded by an event data recorder, special equipment is required, and access to the vehicle or the event data recorder is needed. In addition to the vehicle manufacturer, other parties, such as law enforcement, that have such special equipment, can read the information if they have access to the vehicle or the event data recorder.

Comfort, Convenience and Entertainment Data

Your vehicle has electronic control units that have the ability to store data based on your personalized settings. The data is stored locally in the vehicle or on devices that you connect to it, for example, a USB drive or digital music player. You can delete some of this data and also choose whether to share it through the services to which you subscribe. See **Settings** (page 535).

Comfort and Convenience Data

Data recorded includes, for example:

- Seat and steering wheel position.
- Climate control settings.
- Radio presets.

Entertainment Data

Data recorded includes, for example:

- Music, videos or album art.
- Contacts and corresponding address book entries.
- Navigation destinations.

Services That We Provide

If you use our services, we collect and use data, for example, account information, vehicle location and driving characteristics, that could identify you. We transmit this data through a dedicated, protected connection. We only collect and use data to enable your use of our services to which you have subscribed, with your consent or where permitted by law. For additional information, see the terms and conditions of the services to which you have subscribed.

Services That Third Parties Provide

We recommend that you review the terms and conditions and data privacy information for any services to which you subscribe. We take no responsibility for services that third parties provide.

Vehicles With a Modem (If Equipped)



The modem has a SIM. The modem was enabled when your vehicle was built and periodically sends messages to stay connected to the cell phone network, receive automatic software updates and send vehicle-related information to us, for example, diagnostic information. These messages could include information that identifies your vehicle, the SIM and the electronic serial number of the modem. Cell phone network

Introduction

service providers could have access to additional information, for example, cell phone network tower identification. For additional information about our privacy policy, visit www.FordConnected.com or refer to your local Ford website.

Note: *The modem continues to send this information unless you disable the modem or stop the modem from sharing vehicle data by changing the modem settings. See **Network Connectivity** (page 474).*

Note: *The service can be unavailable or interrupted for a number of reasons, for example, environmental or topographical conditions and data plan coverage.*

Note: *To find out if your vehicle has a modem, visit www.FordConnected.com.*

Vehicles With SYNC

Mobile Device Data

If you connect a mobile device to your vehicle, you can display data from your device on the touchscreen for example, music and album art. You can share your vehicle data with mobile apps on your device through the system. See **Apps** (page 532).

The mobile apps function operates by your connected device sending data to us in the United States. The data is encrypted and includes the vehicle identification number of your vehicle, the SYNC module serial number, odometer, enabled apps, usage statistics and debugging information. We retain it only as long as necessary to provide the service, to troubleshoot, for continuous improvement and to offer you products and services that may be of interest to you according to your preferences and where allowed by law.

If you connect a cell phone to the system, the system creates a profile that links to that cell phone. The cell phone profile enables more mobile features and efficient operation. The profile contains, for example, data from your phonebook, read and unread text messages and call history, including history of calls when your cell phone was not connected to the system.

If you connect a media device, the system creates and retains a media device index of supported media content. The system also records a short diagnostic log of approximately 10 minutes of all recent system activity.

The cell phone profile, media device index and diagnostic log remain in your vehicle unless you delete them and are generally accessible only in your vehicle when you connect your cell phone or media device. If you no longer plan to use the system or your vehicle, we recommend you use the master reset function to erase the stored information. See **Settings** (page 535).

System data cannot be accessed without special equipment and access to your vehicle's module.

For additional information about our privacy policy, refer to your local Ford website.

Note: *To find out if your vehicle has a connectivity technology, visit www.FordConnected.com.*

Vehicles With an Emergency Call System

When the emergency call system is active, it may disclose to emergency services that your vehicle has been in a crash involving the deployment of an airbag or activation of the fuel pump shut-off. Certain versions or updates to the emergency call system may also be capable of electronically or verbally disclosing to emergency services operators your vehicle location or other

Introduction

details about your vehicle or crash to assist emergency services operators to provide the most appropriate emergency services. If you do not want to disclose this information, do not activate the emergency call system.

Note: *You cannot deactivate emergency call systems that are required by law.*

PERCHLORATE

Certain components in your vehicle such as airbag modules, seatbelt pretensioners and remote control batteries may contain perchlorate material. Special handling may apply for service or vehicle end of life disposal.

For more information visit:

Web Address
www.dtsc.ca.gov/hazardouswaste/perchlorate

FORD CREDIT

US Only

Ford Credit offers a full range of financing and lease plans to help you acquire your vehicle. If you have financed or leased your vehicle through Ford Credit, thank you for your business.

For assistance call 1-800-727-7000, or for more information about Ford Credit and access to the online Account Manager tool, visit www.ford.com/finance.

REPLACEMENT PARTS RECOMMENDATION

We have built your vehicle to the highest standards using quality parts. We recommend that you demand the use of genuine Ford and Motorcraft parts whenever your vehicle requires scheduled maintenance or repair. You can clearly identify genuine Ford and Motorcraft parts by looking for the Ford, FoMoCo or Motorcraft branding on the parts or their packaging.

Scheduled Maintenance and Mechanical Repairs

One of the best ways for you to make sure that your vehicle provides years of service is to have it maintained in line with our recommendations using parts that conform to the specifications detailed in this Owner's Manual.

Genuine Ford and Motorcraft parts meet or exceed these specifications.

Collision Repairs

We hope that you never experience a collision, but accidents happen sometimes.

Genuine Ford replacement collision parts meet our stringent requirements for fit, finish, structural integrity, corrosion protection and dent resistance. During vehicle development we validate that these parts deliver the intended level of protection as a whole system. A great way to know for sure you are getting this level of protection is to use genuine Ford replacement collision parts.

Warranty on Replacement Parts

Genuine Ford and Motorcraft replacement parts are the only replacement parts that benefit from a Ford Warranty.

Introduction

The Ford Warranty may not cover damage caused to your vehicle as a result of failed non-Ford parts.

For additional information, refer to the terms and conditions of the Ford Warranty.

SPECIAL NOTICES

New Vehicle Limited Warranty

For a detailed description of what is covered by your New Vehicle Limited Warranty, see your warranty guide that is available online. For more information, refer to our website and download your copy of the warranty guide.

Special Instructions

For your added safety, your vehicle is fitted with sophisticated electronic controls.



WARNING: You risk death or serious injury to yourself and others if you do not follow the instruction highlighted by the warning symbol. Failure to follow the specific warnings and instructions could result in personal injury.



WARNING: NEVER use a rearward facing child restraint on a seat protected by an ACTIVE AIRBAG in front of it, DEATH or SERIOUS INJURY to the CHILD can occur.

On Board Diagnostics Data Link Connector



WARNING: Do not connect wireless plug-in devices to the data link connector. Unauthorized third parties could gain access to vehicle data and impair the performance of safety related systems. Only allow repair facilities that follow our service and repair instructions to connect their equipment to the data link connector.

Your vehicle has an OBD Data Link Connector (DLC) that is used in conjunction with a diagnostic scan tool for vehicle diagnostics, repairs and reprogramming services. Installing an aftermarket device that uses the DLC during normal driving for purposes such as remote insurance company monitoring, transmission of vehicle data to other devices or entities, or altering the performance of the vehicle, may cause interference with or even damage to vehicle systems. We do not recommend or endorse the use of unapproved aftermarket plug-in devices. The vehicle Warranty will not cover damage caused by an aftermarket plug-in device.

Notice to Owners of Pickup Trucks and Utility Type Vehicles



WARNING: Utility vehicles have a significantly higher rollover rate than other types of vehicles.

Before you drive your vehicle, please read this Owner's Guide carefully. Your vehicle is not a passenger car. As with other vehicles of this type, failure to operate this vehicle correctly may result in loss of vehicle control, vehicle rollover, personal injury or death.

Introduction

Using Your Vehicle With a Snowplow

Do not use this vehicle for snowplowing.

Your vehicle does not have a snowplowing package.

Using Your Vehicle as an Ambulance

Do not use this vehicle as an ambulance.

Your vehicle does not have the Ambulance Preparation Package.

MOBILE COMMUNICATIONS EQUIPMENT



WARNING: Driving while distracted can result in loss of vehicle control, crash and injury. We strongly recommend that you use extreme caution when using any device that may take your focus off the road. Your primary responsibility is the safe operation of your vehicle. We recommend against the use of any hand-held device while driving and encourage the use of voice-operated systems when possible. Make sure you are aware of all applicable local laws that may affect the use of electronic devices while driving.

Using mobile communications equipment is becoming increasingly important in the conduct of business and personal affairs. However, you must not compromise your own or others' safety when using such equipment. Mobile communications can enhance personal safety and security when appropriately used, particularly in emergency situations. Safety must be paramount when using mobile

communications equipment to avoid negating these benefits. Mobile communication equipment includes, but is not limited to, cellular phones, pagers, portable email devices, text messaging devices and portable two-way radios.

EXPORT UNIQUE OPTIONS

For your particular global region, your vehicle may be equipped with features and options that are different from the features and options that are described in this Owner's Manual. A market unique supplement may be supplied that complements this book. By referring to the market unique supplement, if provided, you can properly identify those features, recommendations and specifications that are unique to your vehicle. This Owner's Manual is written primarily for the U.S. and Canadian Markets. Features or equipment listed as standard may be different on units built for export. **Refer to this Owner's Manual for all other required information and warnings.**

Environment

PROTECTING THE ENVIRONMENT

You should play your part in protecting the environment. Correct vehicle usage and the authorized disposal of waste, cleaning and lubrication materials are significant steps toward this aim.

For additional information about our sustainability progress and initiatives, visit www.sustainability.ford.com.

At a Glance

INSTRUMENT PANEL

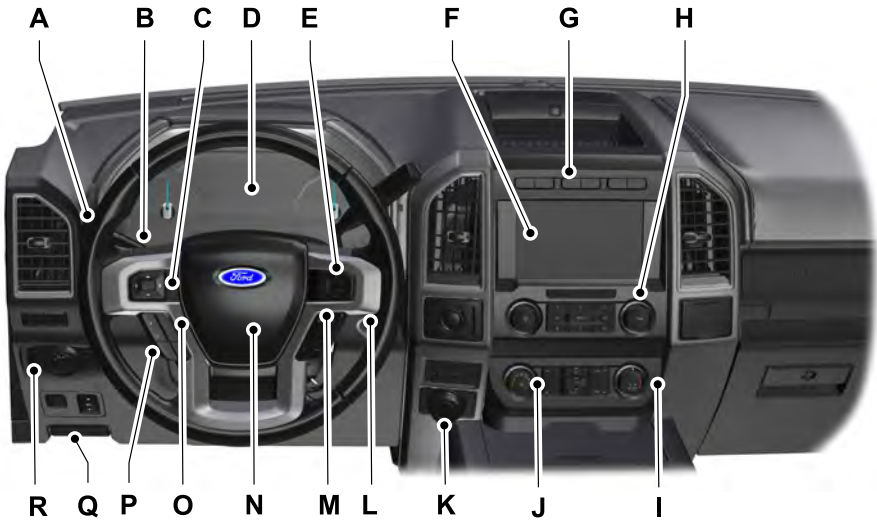

- A Direction indicators. See **Direction Indicators** (page 92).
- B Wiper lever. See **Wipers and Washers** (page 87).
- C Information display controls. See **Information Displays** (page 112).
- D Instrument cluster. See **Instrument Cluster** (page 104).
- E Navigation, media, phone.
- F Entertainment display.
- G Hazard flasher switch. See **Hazard Flashers** (page 321).
- H Audio. See **Audio System** (page 478).
- I Climate control. See **Climate Control** (page 142).
- J Rear defrost.
- K Trailer backup assist. See **Trailer Reversing Aids** (page 279).
- L Start button. See **Keyless Starting** (page 175).
- M Voice control. See **Voice Control** (page 84).

At a Glance

- N Horn.
- O Cruise control. See **Cruise Control** (page 241).
- P Steering wheel adjustment. See **Adjusting the Steering Wheel** (page 82).
- Q Parking brake release. See **Brakes** (page 222).
- R Lighting control. See **Lighting Control** (page 89).

Child Safety

GENERAL INFORMATION

See the following sections for directions on how to properly use safety restraints for children.



WARNING: Always make sure your child is secured properly in a device that is appropriate for their height, age and weight. Child safety restraints must be bought separately from your vehicle. Failure to follow these instructions and guidelines may result in an increased risk of serious injury or death to your child.



WARNING: All children are shaped differently. The National Highway Traffic Safety Administration and other safety organizations, base their recommendations for child restraints on probable child height, age and weight thresholds, or on the minimum requirements of the law. We recommend that you check with a NHTSA Certified Child Passenger Safety Technician

(CPST) to make sure that you properly install the child restraint in your vehicle and that you consult your pediatrician to make sure you have a child restraint appropriate for your child. To locate a child restraint fitting station and CPST, contact NHTSA toll free at 1-888-327-4236 or go to www.nhtsa.dot.gov. In Canada, contact Transport Canada toll free at 1-800-333-0371 or go to www.tc.gc.ca to find a Child Car Seat Clinic in your area. Failure to properly restrain children in child restraints made especially for their height, age and weight, may result in an increased risk of serious injury or death to your child.



WARNING: On hot days, the temperature inside the vehicle can rise very quickly. Exposure of people or animals to these high temperatures for even a short time can cause death or serious heat related injuries, including brain damage. Small children are particularly at risk.

Child Safety

Recommendations for Safety Restraints for Children

Child	Child Size, Height, Weight, or Age	Recommended Restraint Type
Infants or toddlers	Children weighing 40 lb (18 kg) or less (generally age four or younger).	Use a child restraint (sometimes called an infant carrier, convertible seat, or toddler seat).
Small children	Children who have outgrown or no longer properly fit in a child restraint (generally children who are less than 57 in (1.45 m) tall, are greater than age four and less than age 12, and between 40 lb (18 kg) and 80 lb (36 kg) and upward to 100 lb (45 kg) if recommended by your child restraint manufacturer).	Use a belt-positioning booster seat.
Larger children	Children who have outgrown or no longer properly fit in a belt-positioning booster seat (generally children who are at least 57 in (1.45 m) tall or greater than 80 lb (36 kg) or 100 lb (45 kg) if recommended by child restraint manufacturer).	Use a vehicle seatbelt having the lap belt snug and low across the hips, shoulder belt centered across the shoulder and chest, and seat backrest upright.

- You are required by law to properly use child restraints for infants and toddlers in the United States and Canada.
- Many states and provinces require that small children use approved booster seats until they reach age eight, a height of 57 in (1.45 m) tall, or 80 lb (36 kg). Check your local and state or provincial laws for specific requirements about the safety of children in your vehicle.
- When possible, always properly restrain children 12 years of age and under in a rear seating position of your vehicle. Accident statistics suggest that children are safer when properly restrained in the rear seating positions than in a front seating position.
- When installing a rear facing child restraint, adjust the vehicle seats to avoid interference between the child restraint and the vehicle seat in front of the child restraint.

Child Safety

INSTALLING CHILD RESTRAINTS

Child Seats



E142594

Use a child restraint (sometimes called an infant carrier, convertible seat, or toddler seat) for infants, toddlers, or children weighing 40 lb (18 kg) or less (generally age four or younger).

Using Lap and Shoulder Belts (Except Front Center Position of Super Cab and Crew Cab)



WARNING: Do not place a rearward facing child restraint in front of an active airbag. Failure to follow this instruction could result in personal injury or death.



WARNING: Even with advanced restraints systems, properly restrain children 12 and under in a rear seating position. Failure to follow this could seriously increase the risk of injury or death.



WARNING: Depending on where you secure a child restraint, and depending on the child restraint design, you may block access to certain seatbelt buckle assemblies and LATCH lower anchors, rendering those features potentially unusable. To avoid risk of injury, make sure occupants only use seating positions where they are able to be properly restrained.

When installing a child restraint with combination lap and shoulder belts:

- Use the correct seatbelt buckle for that seating position.
- Insert the belt tongue into the proper buckle until you hear a snap and feel it latch. Make sure the tongue is securely fastened in the buckle.
- Keep the buckle release button pointing up and away from the child restraint, with the tongue between the child restraint and the release button, to prevent accidental unbuckling.
- Place the vehicle seat in the upright position before you install the child restraint.
- Put the seatbelt in the automatic locking mode. This vehicle does not require the use of a locking clip.

Perform the following steps when installing the child restraint with combination lap and shoulder belts:

Note: *Although the child restraint illustrated is a forward facing child restraint, the steps are the same for installing a rear facing child restraint.*

Child Safety



E142528

1. Position the child restraint in a seat with a combination lap and shoulder belt.



E142529

2. Pull down on the shoulder belt and then grasp the shoulder belt and lap belt together.



E142530

3. While holding the shoulder and lap belt portions together, route the tongue through the child restraint according to the child restraint manufacturer's instructions. Make sure you did not twist the belt webbing.

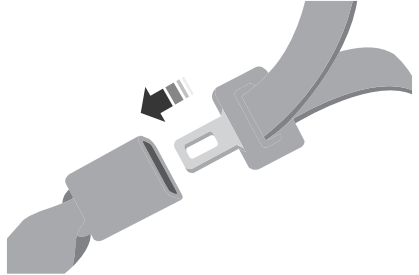

E142531

4. Insert the belt tongue into the proper buckle (the buckle closest to the direction the tongue is coming from) for that seating position until you hear a snap and feel the latch engage. Make sure you securely latched the tongue by pulling on it.



E142875

5. To put the retractor in the automatic locking mode, grasp the shoulder portion of the belt and pull downward until you pull all of the belt out.

Child Safety

Note: The automatic locking mode is available on the front passenger and rear seats. This vehicle does not require the use of a locking clip.

6. Allow the belt to retract to remove slack. The belt clicks as it retracts to indicate it is in the automatic locking mode.
7. Try to pull the belt out of the retractor to make sure the retractor is in the automatic locking mode. You should not be able to pull more belt out. If the retractor did not lock, unbuckle the belt and repeat Steps 5 and 6.



E142533

8. Remove remaining slack from the belt. Force the seat down with extra weight, for example, by pressing down or kneeling on the child restraint while pulling up on the shoulder belt in order to force slack from the belt. This is necessary to remove the remaining slack that exists once you add the extra weight of the child to the child restraint. It also helps to achieve the proper snugness of the child restraint to your vehicle. Sometimes, a slight lean toward the buckle helps to remove remaining slack from the belt.
9. If the child restraint has a tether strap, attach it.



E142534

10. Before placing the child in the seat, forcibly move the seat forward and back to make sure the seat is securely held in place.

To check this, grab the seat at the belt path and attempt to move it side to side and forward and back. There should be no more than 1 in (2.5 cm) of movement for proper installation.

We recommend checking with a NHTSA Certified Child Passenger Safety Technician to make certain the child restraint is properly installed. In Canada, check with Transport Canada for referral to a Child Car Seat Clinic.

Using Lap and Shoulder Belts (Front Center Position of Super Cab and Crew Cab)



WARNING: Do not place a rearward facing child restraint in front of an active airbag. Failure to follow this instruction could result in personal injury or death.



WARNING: Always use both the lap and shoulder portion of the seatbelt in the center seating position.

Child Safety

The belt webbing below the tongue is the lap portion of the combination lap and shoulder belt. The belt webbing above the tongue is the shoulder belt portion of the combination lap and shoulder belt.



E142528

1. Position the child restraint in the front center seat.



E162708

2. Slide the tongue up the webbing.



E142530

3. While holding both shoulder and lap portions next to the tongue, route the tongue and webbing through the child restraint according to the child restraint manufacturer's instructions. Make sure that you did not twist the belt webbing.

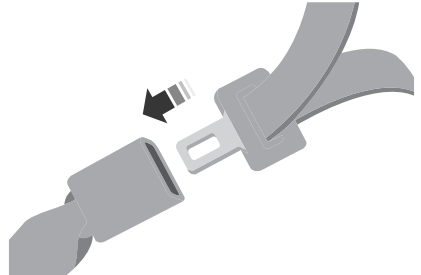

E142531

4. Insert the belt tongue into the proper buckle (the buckle closest to the direction the tongue is coming from) for that seating position until you hear a snap and feel the latch engage. Make sure the tongue is latched securely by pulling on it.

Child Safety



E142533

5. While pushing down with your knee on the child restraint, pull up on the shoulder belt portion to tighten the lap belt portion of the combination lap and shoulder belt.
6. Allow the seatbelt to retract and remove any slack in the belt to securely tighten the child restraint in the vehicle.
7. If the child restraint has a tether strap, attach it.

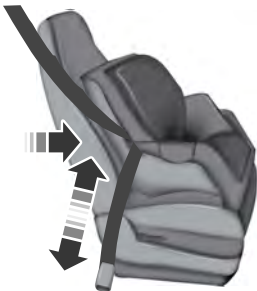

E142534

8. Before placing the child in the seat, forcibly move the seat forward and back to make sure the seat is securely held in place. To check this, grab the seat at the belt path and attempt to move it side to side and forward and back. There should be no more than 1 in (2.5 cm) of movement for proper installation.

9. Check from time to time to be sure that there is no slack in the lap and shoulder belt. The shoulder belt must be snug to keep the lap belt tight during a crash.

We recommend checking with a NHTSA Certified Child Passenger Safety Technician to make certain the child restraint is properly installed. In Canada, check with Transport Canada for referral to a Child Car Seat Clinic.

Using Lower Anchors and Tethers for Children (LATCH)



WARNING: Do not attach two child safety restraints to the same anchor. In a crash, one anchor may not be strong enough to hold two child safety restraint attachments and may break, causing serious injury or death.



WARNING: Depending on where you secure a child restraint, and depending on the child restraint design, you may block access to certain seatbelt buckle assemblies and LATCH lower anchors, rendering those features potentially unusable. To avoid risk of injury, make sure occupants only use seating positions where they are able to be properly restrained.

The LATCH system has three vehicle anchor points: two lower anchors where the vehicle seat backrest and seat cushion meet (called the seat bight) and one top tether anchor behind that seating position.

LATCH compatible child restraints have two rigid or webbing mounted attachments that connect to the two lower anchors at the LATCH equipped seating positions in your vehicle. This type of attachment method eliminates the need to use seatbelts to attach the child restraint. However, you can still use the seatbelt to attach the child restraint if the

Child Safety

lower anchors are not used. For forward-facing child restraints, you must also attach the top tether strap to the proper top tether anchor if a top tether strap has been provided with your child restraint.

Your vehicle has LATCH lower anchors for child restraint installation at the following seating positions (LATCH is not available on Regular Cab):

Crew Cab

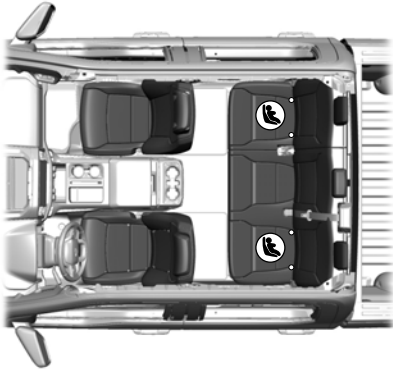

Super Cab

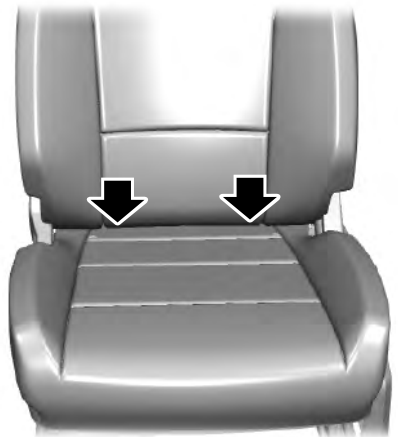
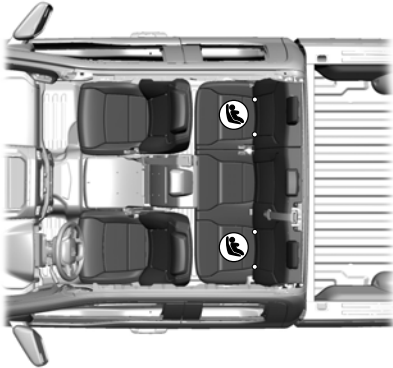

The lower LATCH anchors are at the rear section of the rear seat between the cushion and seat backrest. Follow the child restraint manufacturer's instructions to properly install a child restraint with LATCH attachments.

Follow the instructions later in this chapter on attaching child restraints with tether straps.

Attach LATCH lower attachments of the child restraint only to the anchors shown.

Use of Inboard Lower Anchors from the Outboard Seating Positions (Center Seating Use)

 **WARNING:** The standardized spacing for LATCH lower anchors is 11 in (280 mm) center to center. Do not use LATCH lower anchors for the center seating position unless the child restraint manufacturer's instructions permit and specify using anchors spaced at least as far apart as those in this vehicle.

Child Safety

The lower anchors at the center of the second row rear seat are spaced 26 in (652 mm) apart. The standardized spacing for LATCH lower anchors is 11 in (280 mm) center to center. You cannot install a child restraint with rigid LATCH attachments at the center seating position. You can only use LATCH compatible child restraints (with attachments on belt webbing) at this seating position provided that the child restraint manufacturer's instructions permit use with the anchor spacing stated. Do not attach a child restraint to any lower anchor if an adjacent child restraint is attached to that anchor.

Each time you use the child restraint, check that the seat is properly attached to the lower anchors and tether anchor, if applicable. Tug the child restraint from side to side and forward and back where it is secured to the vehicle. The seat should move less than 1 in (2.5 cm) when you do this for a proper installation.

If you did not properly anchor the child restraint, the risk of a child being injured in a crash greatly increases.

Combining Seatbelt and LATCH Lower Anchors for Attaching Child Restraints

When used in combination, either the seatbelt or the LATCH lower anchors may be attached first, provided a proper installation is achieved. Attach the tether strap afterward, if included with the child restraint.

Using Tether Straps

Many forward-facing child restraints include a tether strap which extends from the back of the child restraint and hooks to an anchoring point called the top tether anchor. Tether straps are available as an accessory for many older safety seats.

Contact the manufacturer of your child restraint for information about ordering a tether strap, or to obtain a longer tether strap if the tether strap on your child restraint does not reach the appropriate top tether anchor in the vehicle.

The passenger seats of your vehicle may have built-in tether strap anchors behind the seats as described below.

The tether anchors in your vehicle may be loops of webbing above the seat backrest or an anchor bracket behind the seat on the rear edge of the seat cushion.

The rear seat in the Crew Cab and Super Cab has three straps along the top of the seat backrest that function as both routing loops for the tether straps and anchor loops.

The tether strap anchors in your vehicle are in the following positions (shown from top view):

Regular Cab

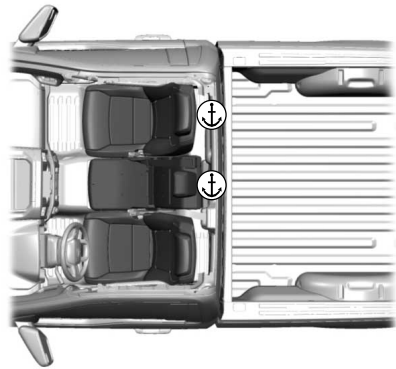

Child Safety

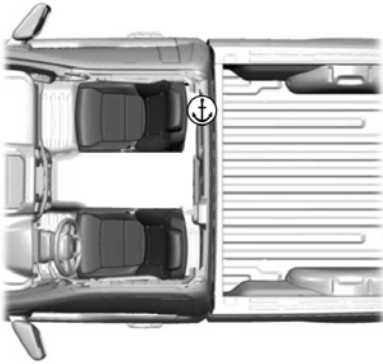

Crew Cab

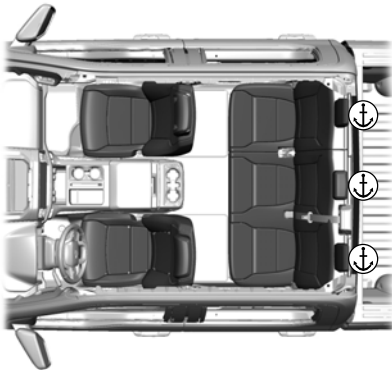

Super Cab

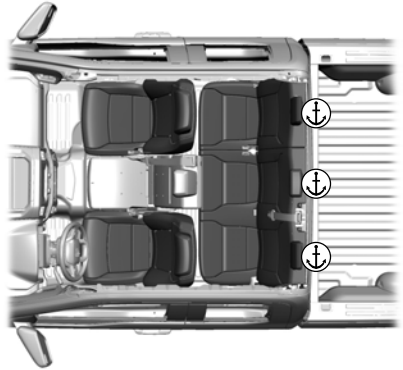

Attach the tether strap only to the appropriate tether anchor as shown. The tether strap may not work properly if attached somewhere other than the correct tether anchor.

If you install a child restraint with rigid LATCH attachments, do not tighten the tether strap enough to lift the child restraint off the vehicle seat cushion when the child is seated in it. Keep the tether strap just snug without lifting the front of the child restraint. Keeping the child restraint just touching the vehicle seat gives the best protection in a severe crash.

Once you install the child restraint using either the seatbelt, the lower anchors of the LATCH system, or both, you can attach the top tether strap.

Front Seat Tether Strap Attachment (Regular Cab)

Note: For vehicles with adjustable head restraints, route the tether strap under the head restraint and between the head restraint posts, otherwise route the tether strap over the top of the seat backrest.

Child Safety

1. Route the child restraint tether strap over the back of the seat and under the head restraint.
2. Locate the correct anchor for the selected seating position. You may need to pull the seat backrest forward to access the tether anchors. Make sure the seat is locked in the upright position before installing the child restraint.
3. Clip the tether strap to the anchor.
4. Tighten the child restraint tether strap according to the manufacturer's instructions.

Regular Cab Passenger and Center Seats (located on back panel)



E175295

If you clip the tether strap incorrectly, the child restraint may not be retained properly in the event of a crash.

If you did not properly anchor the child restraint, the risk of a child being injured in a crash greatly increases.

If your child restraint system has a tether strap, and the child restraint manufacturer recommends its use, we also recommend its use.

Rear Seat Tether Strap Attachment (Crew Cab and Super Cab)



E167009

There are three loops of webbing just above the back of the rear seat (along the bottom edge of the rear window). Use these loops as both routing loops and anchor loops for up to three child restraint tethers.

For example, you can use the center loop as a routing loop for a child restraint in the center rear seat and as an anchoring loop for child restraints installed in the outboard rear seats.

Many tether straps cannot be tightened if the tether strap is hooked to the loop directly behind the child restraint.

To provide a tight tether strap:

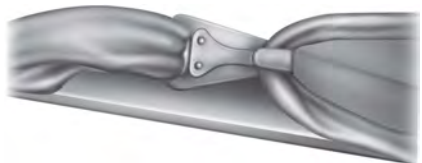

E162715

Child Safety

1. Route the vehicle tether loop between the head restraint posts, then route the child restraint tether strap through the loop, forward of the head restraint.
2. Hook the strap to the vehicle tether anchor loop in the adjacent seating position. If using the driver side, pass the strap behind the shoulder belt for the center seat. Always put the tether strap through the routing loop. The head restraint support post holds the child restraint tightly, but the head restraint post is not strong enough to hold the child restraint during a crash.
3. Tighten the tether strap according to the child restraint manufacturer's instructions.

If the child restraint is not anchored properly, the risk of a child being injured in a crash greatly increases.

If your child restraint system has a tether strap, and the child restraint manufacturer recommends its use, we also recommend its use.

BOOSTER SEATS



WARNING: Do not put the shoulder section of the seatbelt or allow the child to put the shoulder section of the seatbelt under their arm or behind their back. Failure to follow this instruction could reduce the effectiveness of the seatbelt and increase the risk of injury or death in a crash.

Use a belt-positioning booster seat for children who have outgrown or no longer properly fit in a child safety restraint (generally children who are less than 57 in (1.45 m) tall, are greater than age 4 and less than age 12, and between 40 lb (18 kg) and 80 lb (36 kg) and upward to 100 lb

(45 kg) if recommended by your child restraint manufacturer). Many state and provincial laws require that children use approved booster seats until they reach age eight, a height of 57 in (1.45 m) tall, or 80 lb (36 kg).

Booster seats should be used until you can answer YES to ALL of these questions when seated without a booster seat:

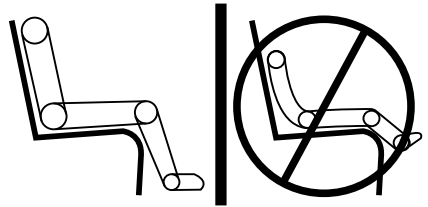

E142595

- Can the child sit all the way back against their vehicle seat backrest with knees bent comfortably at the edge of the seat cushion?
- Can the child sit without slouching?
- Does the lap belt rest low across the hips?
- Is the shoulder belt centered on the shoulder and chest?
- Can the child stay seated like this for the whole trip?

Always use booster seats in conjunction with your vehicle lap and shoulder belt.

Child Safety

Types of Booster Seats



E70710

E68924

- Backless booster seats

If your backless booster seat has a removable shield, remove the shield. If a vehicle seating position has a low seat backrest or no head restraint, a backless booster seat may place your child's head (as measured at the tops of the ears) above the top of the seat. In this case, move the backless booster to another seating position with a higher seat backrest or head restraint and lap and shoulder belts, or consider using a high back booster seat.

- High back booster seats

If, with a backless booster seat, you cannot find a seating position that adequately supports your child's head, a high back booster seat would be a better choice.

Children and booster seats vary in size and shape. Choose a booster that keeps the lap belt low and snug across the hips, never up across the stomach, and lets you adjust the shoulder belt to cross the chest and rest snugly near the center of the shoulder. The following drawings compare the ideal fit (center) to a shoulder belt uncomfortably close to the neck and a shoulder belt that could slip off the shoulder. The drawings also show how the lap belt should be low and snug across the child's hips.



E142596

Child Safety



E142597

If the booster seat slides on the vehicle seat upon which it is being used, placing a rubberized mesh sold as shelf or carpet liner under the booster seat may improve this condition. Do not introduce any item thicker than this under the booster seat. Check with the booster seat manufacturer's instructions.

CHILD RESTRAINT POSITIONING

WARNING: Do not place a rearward facing child restraint in front of an active airbag. Failure to follow this instruction could result in personal injury or death.

WARNING: Properly secure children 12 years old and under in a rear seating position whenever possible. If you are unable to properly secure all children in a rear seating position, properly secure the largest child on the front seat. If you must use a forward facing child restraint on the front seat, move the seat as far back as possible. Failure to follow these instructions could result in personal injury or death.

WARNING: Always carefully follow the instructions and warnings provided by the manufacturer of any child restraint to determine if the restraint device is appropriate for your child's size, height, weight, or age. Follow the child restraint manufacturer's instructions and warnings provided for installation and use in conjunction with the instructions and warnings provided by your vehicle manufacturer. A safety seat that is improperly installed or utilized, is inappropriate for your child's height, age, or weight or does not properly fit the child may increase the risk of serious injury or death.

WARNING: Do not allow a passenger to hold a child on their lap when your vehicle is moving. Failure to follow this instruction could result in personal injury or death in the event of a sudden stop or crash.

WARNING: Do not use pillows, books or towels to boost your child's height. Failure to follow this instruction could result in personal injury or death.

Child Safety



WARNING: Properly secure child restraints or booster seats when they are not in use. They could become projectiles in a sudden stop or crash. Failure to follow this instruction could result in personal injury or death.



WARNING: Do not put the shoulder section of the seatbelt or allow the child to put the shoulder section of the seatbelt under their arm or behind their back. Failure to follow this instruction could reduce the effectiveness of the seatbelt and increase the risk of injury or death in a crash.



WARNING: Do not leave children or pets unattended in your vehicle. Failure to follow this instruction could result in personal injury or death.

Recommendations for Attaching Child Safety Restraints for Children

Restraint Type	Combined Weight of Child and Child Restraint	Use Any Attachment Method as Indicated Below by X				
		LATCH (Lower Anchors and Top Tether Anchor)	LATCH (Lower Anchors Only)	Seatbelt and Top Tether Anchor	Seatbelt and LATCH (Lower Anchors and Top Tether Anchor)	Seatbelt Only
Rear facing child restraint	Up to 65 lb (29.5 kg)		X			X
Rear facing child restraint	Over 65 lb (29.5 kg)					X
Forward facing child restraint	Up to 65 lb (29.5 kg)	X		X	X	
Forward facing child restraint	Over 65 lb (29.5 kg)			X	X	

Child Safety

Note: *The child restraint must rest tightly against the vehicle seat upon which it is installed. It may be necessary to lift or remove the head restraint. See **Seats** (page 150).*

CHILD SAFETY LOCKS

When these locks are set, the rear doors cannot be opened from the inside.



E112197

The childproof locks are located on the rear edge of each rear door and must be set separately for each door.

Left-Hand Side

Turn counterclockwise to lock and clockwise to unlock.

Right-Hand Side

Turn clockwise to lock and counterclockwise to unlock.

Seatbelts

PRINCIPLE OF OPERATION



WARNING: Always drive and ride with your seatback upright and the lap belt snug and low across the hips.



WARNING: Children must always be properly restrained.



WARNING: Do not allow a passenger to hold a child on their lap when your vehicle is moving. Failure to follow this instruction could result in personal injury or death in the event of a sudden stop or crash.



WARNING: All occupants of your vehicle, including the driver, should always properly wear their seatbelts, even when an airbag supplemental restraint system is provided. Failure to properly wear your seatbelt could seriously increase the risk of injury or death.



WARNING: It is extremely dangerous to ride in a cargo area, inside or outside of a vehicle. In a crash, people riding in these areas are more likely to be seriously injured or killed. Do not allow people to ride in any area of your vehicle that is not equipped with seats and seatbelts. Make sure everyone in your vehicle is in a seat and properly using a seatbelt. Failure to follow this warning could result in serious personal injury or death.



WARNING: In a rollover crash, an unbelted person is significantly more likely to die than a person wearing a seatbelt.



WARNING: Each seating position in your vehicle has a specific seatbelt assembly made up of one buckle and one tongue designed to be used as a pair. Use the shoulder belt on the outside shoulder only. Never wear the shoulder belt under the arm. Never use a single seatbelt for more than one person.



WARNING: Even with advanced restraints systems, properly restrain children 12 and under in a rear seating position. Failure to follow this could seriously increase the risk of injury or death.



WARNING: Seatbelts and seats may be hot in a vehicle that is in the sunshine. The hot seatbelts or seats may burn a small child. Check seat covers and buckles before you place a child anywhere near them.

All seating positions in this vehicle have lap and shoulder belts. All occupants of the vehicle should always properly wear their seatbelts, even when an airbag supplemental restraint system is provided.

The seatbelt system consists of:

- Lap and shoulder seatbelts.
- Shoulder seatbelts with automatic locking mode, (except the driver seatbelt).
- Height adjusters at the front outermost seating positions.
- Seatbelt pretensioners at the front outermost and rear outermost seating positions.



- Seatbelt warning light and chime.

Seatbelts



- Crash sensors and monitoring system with readiness indicator.

The seatbelt pretensioners are designed to tighten the seatbelts when activated. In frontal and near-frontal crashes, the seatbelt pretensioners may be activated alone or, if the crash is of sufficient severity, together with the front airbags. In side crashes and rollovers, the seatbelt pretensioners activate when the Safety Canopy is activated.

FASTENING THE SEATBELTS

The front outermost and rear safety restraints in the vehicle are combination lap and shoulder belts.



E142587

1. Insert the belt tongue into the proper buckle (the buckle closest to the direction the tongue is coming from) until you hear a snap and feel it latch. Make sure you securely fasten the tongue in the buckle.

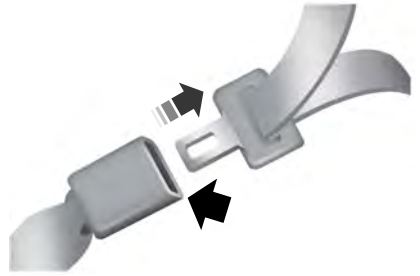

E142588

2. To unfasten, press the release button and remove the tongue from the buckle.

Using the Seatbelt with Cinch Tongue (Front Center Seat on Super Cab and Crew Cab)

The cinch tongue slides up and down the belt webbing when you stow the belt or while putting seatbelts on. When you buckle the lap and shoulder seatbelt, the cinch tongue allows you to shorten the lap portion, but pinches the webbing to keep the lap portion from getting longer. The cinch tongue is designed to slip during a crash, so always wear the shoulder belt properly and do not allow any slack in either the lap or shoulder portions.

Before you can reach and latch a lap and shoulder belt having a cinch tongue into the buckle, you may have to lengthen the lap belt portion of it.

Seatbelts



E162708

1. To lengthen the lap belt, pull some webbing out of the shoulder belt retractor.
2. While holding the webbing below the tongue, grasp the tip (metal portion) of the tongue so that it is parallel to the webbing and slide the tongue upward.
3. Provide enough lap belt length so that the tongue can reach the buckle.

Fastening the Cinch Tongue

WARNING: Always drive and ride with your seatback upright and the lap belt snug and low across the hips.

1. Pull the lap and shoulder belt from the retractor so that the shoulder belt portion of the seatbelt crosses your shoulder and chest.
2. Be sure the belt is not twisted. If the belt is twisted, remove the twist.
3. Insert the belt tongue into the proper buckle for your seating position until you hear a snap and feel it latch.
4. Make sure you securely fasten the tongue to the buckle by pulling on the tongue.

While you are fastened in the seatbelt, the lap and shoulder belt with a cinch tongue adjusts to your movement. However, if you brake hard, turn hard, or if your vehicle receives an impact of 5 mph (8 km/h) or more, the seatbelt locks and helps reduce your forward movement.

Using Seatbelts During Pregnancy

WARNING: Always ride and drive with your seatback upright and properly fasten your seatbelt. Fit the lap portion of the seatbelt snugly and low across the hips. Position the shoulder portion of the seatbelt across your chest. Pregnant women must follow this practice. See the following figure.

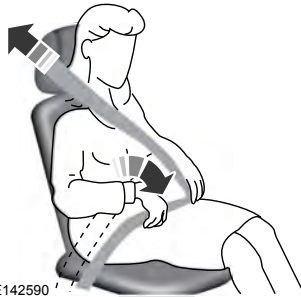

E142590

Pregnant women should always wear their seatbelt. Position the lap belt portion of a combination lap and shoulder belt low across the hips below the belly and worn as tight as comfort allows. Position the shoulder belt to cross the middle of the shoulder and the center of the chest.

Seatbelts

Seatbelt Locking Modes



WARNING: If your vehicle is involved in a crash, have the seatbelts and associated components inspected as soon as possible. Failure to follow this instruction could result in personal injury or death.

All safety restraints in the vehicle are combination lap and shoulder belts. The driver seatbelt has the first type of locking mode. The front outermost passenger and rear seat seatbelts have both types of locking modes described as follows:

Vehicle Sensitive Mode

This is the normal retractor mode, which allows free shoulder belt length adjustment to your movements and locking in response to vehicle movement. For example, if the driver brakes suddenly, turns a corner sharply, or the vehicle receives an impact of about 5 mph (8 km/h) or more, the combination seatbelts lock to help reduce forward movement of the driver and passengers.

In addition, the retractor is designed to lock if you pull the webbing out too quickly. If the seatbelt retractor locks, slowly lower the height adjuster to allow the seatbelt to retract. If the retractor does not unlock, pull the seatbelt out slowly then feed a small length of webbing back toward the stowed position. For rear seatbelts, recline the rear seat backrest or push the seat backrest cushion away from the seatbelt. Feed a small length of webbing back toward the stowed position.

Automatic Locking Mode

In this mode, the shoulder belt automatically pre-locks. The belt still retracts to remove any slack in the shoulder belt. The automatic locking mode is not available on the driver seatbelt.

When to Use the Automatic Locking Mode

Use this mode any time you install a child restraint in a front outermost passenger seating position in a Regular Cab, SuperCab, SuperCrew or any rear seating position of a SuperCab or SuperCrew. The optional front center seatbelt has a cinch mechanism. Properly restrain children 12 years old and under in a rear seat whenever possible.

How to Use the Automatic Locking Mode



E142591

1. Buckle the combination lap and shoulder belt.
2. Grasp the shoulder portion and pull downward until you pull the entire belt out.
3. Allow the belt to retract. As the belt retracts, you will hear a clicking sound. This indicates the seatbelt is now in the automatic locking mode.

Seatbelts

How to Disengage the Automatic Locking Mode

Unbuckle the combination lap and shoulder belt and allow it to retract completely to disengage the automatic locking mode and activate the vehicle sensitive (emergency) locking mode.

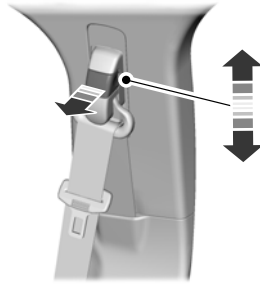

E145664

SEATBELT HEIGHT ADJUSTMENT



WARNING: Position the safety belt height adjuster so that the belt rests across the middle of your shoulder. Failure to adjust the safety belt properly could reduce the effectiveness of the safety belt and increase the risk of injury in a crash.

Adjust the height of the shoulder belt so the belt rests across the middle of your shoulder.

To adjust the shoulder belt height:

1. Pull the button and slide the height adjuster up or down.
2. Release the button and pull down on the height adjuster to make sure it is locked in place.

SEATBELT WARNING LAMP AND INDICATOR CHIME



This lamp illuminates and an indicator chime will sound if the driver seatbelt has not been fastened when the vehicle's ignition is turned on.

Conditions of operation

If	Then
The driver seatbelt is not buckled before the ignition switch is turned to the on position...	The seatbelt warning lamp illuminates and the indicator chime sounds for a few seconds.
The driver seatbelt is buckled while the warning lamp is illuminated and the indicator chime is sounding...	The seatbelt warning lamp and indicator chime turn off.
The driver seatbelt is buckled before the ignition switch is turned to the on position...	The seatbelt warning lamp and indicator chime remain off.

Seatbelts

SEATBELT REMINDER

Belt-Minder™

This feature supplements the seatbelt

warning function. It provides additional reminders by intermittently sounding a chime and illuminating the seatbelt warning light when you are in the driver seat and a seatbelt is unbuckled.

If...	Then...
You buckle your seatbelt before you switch the ignition on or less than 1-2 minutes elapse after you switch the ignition on...	The Belt-Minder feature will not activate.
You do not buckle your seatbelt before your vehicle reaches at least 6 mph (9.7 km/h) and 1-2 minutes elapse after you switch the ignition on...	The Belt-Minder feature activates - the seatbelt warning light illuminates and a warning tone sounds for six seconds every 25 seconds, repeating for about five minutes or until you buckle your seatbelt.
The driver seatbelt is unbuckled for about one minute while the vehicle is traveling at least 6 mph (9.7 km/h) and more than 1-2 minutes elapse after you switch the ignition on...	The Belt-Minder feature activates - the seatbelt warning light illuminates and the warning tone sounds for six seconds every 25 seconds, repeating for about five minutes or until you buckle your seatbelt.

Deactivating and Activating the Belt-Minder Feature (Driver only)



WARNING: While the system allows you to deactivate it, this system is designed to improve your chances of being safely belted and surviving an accident. We recommend you leave the system activated for yourself and others who may use the vehicle. To reduce the risk of injury, do not deactivate or activate the system while driving the vehicle.

Note: *If you are using MyKey, you cannot disable the Belt-Minder. Also, if the Belt-Minder has been previously disabled, it will be re-enabled during the use of MyKey. See **MyKey™** (page 62).*

Read Steps 1 - 4 thoroughly before proceeding with the programming procedure.

Before following the procedure, make sure that:

- The parking brake is set.
 - The transmission is in park (P).
 - The ignition is off.
 - All vehicle doors are closed.
 - The driver seatbelt is unbuckled.
1. Switch the ignition on. Do not start the engine.
 2. Wait until the seatbelt warning light turns off (about one minute). You must complete Step 3 within 30 seconds after the seatbelt warning light turns off.
 3. Buckle then unbuckle the seatbelt three times at a moderate speed, ending with the seatbelt in the unbuckled state. After Step 3, the seatbelt warning light turns on.

Seatbelts

4. While the seatbelt warning light is on, buckle then unbuckle the seatbelt. After Step 4, the seatbelt warning light flashes for confirmation.
 - This will switch the feature off if it is currently on.
 - This will switch the feature on if it is currently off.

CHILD RESTRAINT AND SEATBELT MAINTENANCE

Inspect the vehicle seatbelts and child safety seat systems periodically to make sure they work properly and are not damaged. Inspect the vehicle and child restraint seatbelts to make sure there are no nicks, tears or cuts. Replace if necessary. All vehicle seatbelt assemblies, including retractors, buckles, front seatbelt buckle assemblies, buckle support assemblies (slide bar-if equipped), shoulder belt height adjusters (if equipped), shoulder belt guide on seat backrest (if equipped), child safety seat LATCH and tether anchors, and attaching hardware, should be inspected after a crash. Read the child restraint manufacturer's instructions for additional inspection and maintenance information specific to the child restraint.

We recommend that all seatbelt assemblies in use in vehicles involved in a crash be replaced. However, if the crash was minor and an authorized dealer finds that the belts do not show damage and continue to operate properly, they do not need to be replaced. Seatbelt assemblies not in use during a crash should also be inspected and replaced if either damage or improper operation is noted.

Properly care for seatbelts. See **Vehicle Care** (page 385).

SEATBELT EXTENSIONS



WARNING: Persons who fit into the vehicle's seatbelt should not use an extension. Unnecessary use could result in serious personal injury in the event of a crash.



WARNING: Only use extensions provided free of charge by our dealers. The dealer will provide an extension designed specifically for this vehicle, model year and seating position. The use of an extension intended for another vehicle, model year or seating position may not offer you the full protection of your vehicle's seatbelt restraint system.



WARNING: Never use seatbelt extensions to install child restraints.



WARNING: Do not use a seatbelt extension with an inflatable seatbelt.





WARNING: Do not use extensions to change the way the seatbelt fits across the torso, over the lap or to make the seatbelt buckle easier to reach.

If, because of body size or driving position, it is not possible to properly fasten the seatbelt over your lap and shoulder, an extension that is compatible with the seatbelts is available free of charge from our dealers. Only use our seatbelt extensions made by the original equipment seatbelt manufacturer with our seatbelts. Ask your authorized dealer if your extension is compatible with your vehicle restraint system.

Supplementary Restraints System

PRINCIPLE OF OPERATION

 **WARNING:** Airbags do not inflate slowly or gently, and the risk of injury from a deploying airbag is the greatest close to the trim covering the airbag module.

 **WARNING:** All occupants of your vehicle, including the driver, should always properly wear their seatbelts, even when an airbag supplemental restraint system is provided. Failure to properly wear your seatbelt could seriously increase the risk of injury or death.

 **WARNING:** Properly secure children 12 years old and under in a rear seating position whenever possible. If you are unable to properly secure all children in a rear seating position, properly secure the largest child on the front seat. If you must use a forward facing child restraint on the front seat, move the seat as far back as possible. Failure to follow these instructions could result in personal injury or death.

 **WARNING:** Do not place your arms on the airbag cover or through the steering wheel. Failure to follow this instruction could result in personal injury.

 **WARNING:** Do not place a rearward facing child restraint in front of an active airbag. Failure to follow this instruction could result in personal injury or death.

 **WARNING:** Do not attempt to service, repair, or modify the supplementary restraint system or associated components. Failure to follow this instruction could result in personal injury or death.

 **WARNING:** Several airbag system components get hot after inflation. To reduce the risk of injury, do not touch them after inflation.

 **WARNING:** If a supplementary restraint system component has deployed, it will not function again. Have the system and associated components inspected as soon as possible. Failure to follow this instruction could result in personal injury or death.

The airbags are a supplemental restraint system and are designed to work with the seatbelts to help protect the driver and right front passenger from certain upper body injuries. Airbags do not inflate slowly; there is a risk of injury from a deploying airbag.

Note: *You will hear a loud bang and see a cloud of harmless powdery residue if an airbag deploys. This is normal.*

The airbags inflate and deflate rapidly upon activation. After airbag deployment, it is normal to notice a smoke-like, powdery residue or smell the burnt propellant. This may consist of cornstarch, talcum powder (to lubricate the bag) or sodium compounds (for example, baking soda) that result from the combustion process that inflates the airbag. Small amounts of sodium hydroxide may be present which may irritate the skin and eyes, but none of the residue is toxic.

While the system is designed to help reduce serious injuries, contact with a deploying airbag may also cause abrasions or swelling. Temporary hearing loss is also a possibility as a result of the noise associated with a deploying airbag. Because airbags must inflate rapidly and with considerable force, there is the risk of death or serious injuries such as fractures, facial and eye injuries or internal injuries,

Supplementary Restraints System

particularly to occupants who are not properly restrained or are otherwise out of position at the time of airbag deployment. Thus, it is extremely important that occupants be properly restrained as far away from the airbag module as possible while maintaining vehicle control.

Routine maintenance of the airbags is not required.

DRIVER AND PASSENGER AIRBAGS

 **WARNING:** Do not place your arms on the airbag cover or through the steering wheel. Failure to follow this instruction could result in personal injury.

 **WARNING:** Do not place a rearward facing child restraint in front of an active airbag. Failure to follow this instruction could result in personal injury or death.

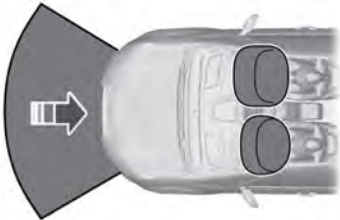

E151127

The driver and front passenger airbags deploy during significant frontal and near frontal crashes.

The driver and passenger front airbag system consists of:

- Driver and passenger airbag modules.



• Crash sensors and monitoring system with readiness indicator. See **Crash Sensors and Airbag Indicator** (page 53).

Passenger Airbag On and Off Switch (If Equipped)

 **WARNING:** Even with advanced restraints systems, properly restrain children 12 and under in a rear seating position. Failure to follow this could seriously increase the risk of injury or death.

 **WARNING:** The front passenger airbag is not designed to offer protection to an occupant in the center seating position.

 **WARNING:** Your vehicle may have an airbag deactivation switch. Before driving, always look at the switch to make sure it is in the appropriate position. Failure to put the switch in the proper position can increase the risk of serious injury or death in a crash.



The front passenger airbag on and off switch has indicators that illuminate, indicating that the front passenger frontal airbag is either on or off. The indicators are near the center of the instrument panel.

Note: The *OFF* and *ON* indicators illuminate for a short period of time when you switch the ignition on to confirm it is functional.

Supplementary Restraints System

Switch Position	Passenger Airbag Status Indicator	Passenger Airbag
Off	OFF: Lit	Disabled
	ON: Unlit	
On	OFF: Unlit	Enabled
	ON: Lit	

Switching the Passenger Airbag Off

WARNING: If the light does not illuminate when the passenger airbag switch is off and you switch the ignition on, have the passenger airbag switch serviced immediately by a qualified technician.

WARNING: To avoid switching on the airbag, always remove the ignition key with the switch in the off position.

WARNING: If your vehicle has rear seats, always transport children who are 12 and younger in the rear seat. Always use seatbelts and child restraints properly. Do not place a child in a rear facing infant seat in the front seat unless your vehicle is equipped with an airbag on and off switch and the passenger airbag is turned off. This is because the back of the infant seat is too close to the inflating airbag and the risk of a fatal injury to the infant when the airbag inflates is substantial.

The passenger airbag on and off switch is in the glovebox.



E181522

1. Insert the ignition key, turn the switch to OFF and hold in OFF while removing the key.
2. When you switch the ignition on, the passenger airbag off light illuminates briefly, momentarily shuts off and then switches back on. This indicates that the passenger airbag is deactivated.

Switching the Passenger Airbag Back On

WARNING: The seatbelts for the driver and right front passenger seating positions are specifically designed to operate together with the airbags in certain types of crashes. When you switch off your airbag, you not only lose

Supplementary Restraints System

the protection of the airbag, you also may reduce the effectiveness of your seatbelt system. If the passenger does not meet the requirements stated in the National Highway Traffic Safety Administration or Transport Canada deactivation criteria, switching off the airbag can increase the risk of serious injury or death in a crash.

WARNING: If your vehicle has rear seats, always transport children who are 12 and younger in the rear seat. Always use seatbelts and child restraints properly. Do not place a child in a rear facing infant seat in the front seat unless your vehicle is equipped with an airbag on and off switch and the passenger airbag is turned off. This is because the back of the infant seat is too close to the inflating airbag and the risk of a fatal injury to the infant when the airbag inflates is substantial.

WARNING: If the passenger airbag off light is illuminated when the passenger airbag switch is on and the ignition is on, have the passenger airbag switch serviced immediately by a qualified technician.

The passenger airbag remains off until you switch it back on.



E181521

1. Insert the ignition key and turn the switch to ON.
2. The passenger airbag off light will briefly illuminate when you switch the ignition on. This indicates that the passenger airbag is operational.

The passenger side airbag should always be on (the passenger airbag off light should not be illuminated) unless the passenger is a person who meets the requirements stated either in Category 1, 2 or 3 of the National Highway Traffic Safety Administration or Transport Canada deactivation criteria which follows.

The vast majority of drivers and passengers are much safer with an airbag than without. To do their job and reduce the risk of life threatening injuries, airbags must open with great force, and this force can pose a potentially deadly risk in some situations, particularly when a front seat occupant is not properly buckled up. The most effective way to reduce the risk of unnecessary airbag injuries without reducing the overall safety of the vehicle is to make sure all occupants are properly restrained in the vehicle, especially in the front seat. This provides the protection of seatbelts and permits the airbags to provide the additional protection they were

Supplementary Restraints System

designed to provide. If you choose to deactivate your airbag, you are losing the very significant risk reducing benefits of the airbag and you are also reducing the effectiveness of the seatbelts, because seatbelts in modern vehicles are designed to work as a safety system with the airbags.

National Highway Traffic Safety Administration Deactivation Criteria (Excluding Canada)



WARNING: This vehicle has special energy management seatbelts for the driver and right front passenger. These particular seatbelts are specifically designed to work with airbags to help reduce the risk of injury in a crash. The energy management seatbelt gives or releases additional seatbelt webbing in some accidents to reduce the concentration of force on an occupant's chest and to reduce the risk of certain bone fractures and injuries to underlying organs. In a crash, if the airbag is off, this energy management seatbelt might permit the passenger wearing the seatbelt to move forward enough to have a serious or fatal injury. The more severe the crash, and the heavier the occupant, the greater the risk. Make sure the airbag is on for any passenger who does not qualify under the National Highway Traffic Safety Administration deactivation criteria.

1. Infant. An infant (less than 1 year old) must ride in the front seat because:

- The vehicle has no rear seat;
- The vehicle has a rear seat too small to accommodate a rear-facing infant seat; or
- The infant has a medical condition which, according to the infant's physician, makes it necessary for the infant to ride in the front so that the driver can constantly monitor the child's condition.

2. Child age 1 to 12. A child age 1 to 12 must ride in the front seat because:

- The vehicle has no rear seat;
- Although children ages 1 to 12 ride in the rear seat(s) whenever possible, children ages 1 to 12 sometimes must ride in the front because no space is available in the rear seat(s) of the vehicle; or
- The child has a medical condition which, according to the child's physician, makes it necessary for the child to ride in the front seat so that the driver can constantly monitor the child's condition.

3. Medical condition. A passenger has a medical condition which, according to his or her physician:

- Causes the passenger airbag to pose a special risk for the passenger;
- Makes the potential harm from the passenger airbag in a crash greater than the potential harm from turning off the airbag and allowing the passenger, even if belted, to hit the dashboard or windshield in a crash.

Supplementary Restraints System

Transport Canada Deactivation Criteria (Canada Only)



WARNING: This vehicle has special energy management seatbelts for the driver and right front passenger. These particular seatbelts are specifically designed to work with airbags to help reduce the risk of injury in a crash. The energy management seatbelt gives or releases additional seatbelt webbing in some accidents to reduce the concentration of force on an occupant's chest and to reduce the risk of certain bone fractures and injuries to underlying organs. In a crash, if the airbag is off, this energy management seatbelt might permit the passenger wearing the seatbelt to move forward enough to have a serious or fatal injury. The more severe the crash, and the heavier the occupant, the greater the risk. Make sure the airbag is on for any passenger who does not qualify under the Transport Canada deactivation criteria.

1. **Infant:** An infant (less than 1 year old) must ride in the front seat because:

- My vehicle has no rear seat;
- The rear seat in my vehicle cannot accommodate a rear-facing infant seat;
- The infant has a medical condition which, according to the infant's physician, makes it necessary for the infant to ride in the front seat so that the driver can monitor the infant's condition.

2. **Child age 12 or under:** A child age 12 or under must ride in the front seat because:

- My vehicle has no rear seat;
- Although children age 12 and under ride in the rear seat whenever possible, children age 12 and under have no option but to sometimes ride in the front seat because rear seat space is insufficient;
- The child has a medical condition that, according to the child's physician, makes it necessary for the child to ride in the front seat so that the driver can monitor the child's condition.

3. **Medical condition:** A passenger has a medical condition that, according to his or her physician:

- Poses a special risk for the passenger if the airbag deploys; and
- Makes the potential harm from the passenger airbag deployment greater than the potential harm from turning off the airbag and experiencing a crash without the protection offered by the airbag

Proper Driver and Front Passenger Seating Adjustment



WARNING: National Highway Traffic Safety Administration (NHTSA) recommends a minimum distance of at least 10 in (25 cm) between an occupant's chest and the driver airbag module.

To properly position yourself away from the airbag:

- Move your seat to the rear as far as you can while still reaching the pedals comfortably.
- Recline the seat slightly (one or two degrees) from the upright position.

Supplementary Restraints System

After all occupants have adjusted their seats and put on seatbelts, it is very important that they continue to sit properly. Properly seated occupants sit upright, lean against the seat back, and center themselves on the seat cushion, with their feet comfortably extended on the floor. Sitting improperly can increase the chance of injury in a crash event. For example, if an occupant slouches, lies down, turns sideways, sits forward, leans forward or sideways, or puts one or both feet up, the chance of injury during a crash greatly increases.

Children and Airbags

WARNING: Do not place a rearward facing child restraint in front of an active airbag. Failure to follow this instruction could result in personal injury or death.



E142846

Children must always be properly restrained. Accident statistics suggest that children are safer when properly restrained in the rear seating positions than in the front seating position. Failure to follow these instructions may increase the risk of injury in a crash.

If two adults and a child occupy a Regular Cab, properly restrain the child in the center front unless doing so would interfere with driving your vehicle. This provides lap and shoulder belt protection for all occupants, and airbag protection for the adults. A child or infant properly restrained in the center front seat should not incur risk of serious injury from the airbags.

SIDE AIRBAGS

WARNING: Do not place objects or mount equipment on or near the airbag cover, on the side of the front or rear seatbacks, or in areas that may come into contact with a deploying airbag. Failure to follow these instructions may increase the risk of personal injury in the event of a crash.

WARNING: Do not use accessory seat covers. The use of accessory seat covers may prevent the deployment of the side airbags and increase the risk of injury in an accident.

WARNING: Do not lean your head on the door. The side airbag could injure you as it deploys from the side of the seatback.

WARNING: Do not attempt to service, repair, or modify the supplementary restraint system or associated components. Failure to follow this instruction could result in personal injury or death.

Supplementary Restraints System



WARNING: If a supplementary restraint system component has deployed, it will not function again. Have the system and associated components inspected as soon as possible. Failure to follow this instruction could result in personal injury or death.

The side airbags are on the outermost side of the front seat backrests. In certain sideways crashes or rollover events, the side airbags will be inflated. The airbag was designed to inflate between the door panel and occupant to further enhance the protection provided to occupants in side impact crashes.



E152533

The system consists of the following:

- A label or embossed side panel indicating that your vehicle has side airbags.
- Side airbags inside the driver and front passenger seat backrests.



Crash sensors and monitoring system with readiness indicator. See **Crash Sensors and Airbag Indicator** (page 53).

The design and development of the side airbag system included recommended testing procedures that were developed by a group of automotive safety experts known as the Side Airbag Technical Working Group. These recommended testing procedures help reduce the risk of injuries related to the deployment of side airbags.

SAFETY CANOPY™



WARNING: Do not place objects or mount equipment on or near the headliner at the siderail that may come into contact with a deploying curtain airbag. Failure to follow these instructions may increase the risk of personal injury in the event of a crash.



WARNING: Do not lean your head on the door. The curtain airbag could injure you as it deploys from the headliner.



WARNING: Do not attempt to service, repair, or modify the supplementary restraint system or associated components. Failure to follow this instruction could result in personal injury or death.



WARNING: All occupants of your vehicle, including the driver, should always properly wear their seatbelts, even when an airbag supplemental restraint system is provided. Failure to properly wear your seatbelt could seriously increase the risk of injury or death.



WARNING: To reduce risk of injury, do not obstruct or place objects in the deployment path of the airbag.

Supplementary Restraints System



WARNING: If a supplementary restraint system component has deployed, it will not function again. Have the system and associated components inspected as soon as possible. Failure to follow this instruction could result in personal injury or death.

The Safety Canopy deploys during significant side crashes or when a certain likelihood of a rollover event is detected by the rollover sensor. The Safety Canopy is mounted to the roof side rail sheet metal, behind the headliner, above each row of seats. In certain sideways crashes or rollover events, the Safety Canopy will be activated, regardless of which seats are occupied. The Safety Canopy is designed to inflate between the side window area and occupants to further enhance protection provided in side impact crashes and rollover events.

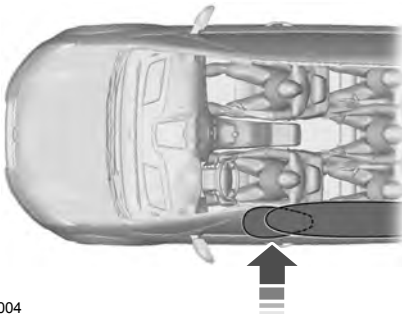

E75004

The system consists of the following:

- Safety Canopy curtain airbags above the trim panels over the front and rear side windows identified by a label or wording on the headliner or roof-pillar trim.
- A flexible headliner which opens above the side doors to allow air curtain deployment



• Crash sensors and monitoring system with a readiness indicator. See **Crash Sensors and Airbag Indicator** (page 53).

Properly restrain children 12 years old and under in the rear seats. The Safety Canopy will not interfere with children restrained using a properly installed child or booster seat because it is designed to inflate downward from the headliner above the doors along the side window opening.

The design and development of the Safety Canopy included recommended testing procedures that were developed by a group of automotive safety experts known as the Side Airbag Technical Working Group. These recommended testing procedures help reduce the risk of injuries related to the deployment of side airbags (including the Safety Canopy).

CRASH SENSORS AND AIRBAG INDICATOR



WARNING: Modifying or adding equipment to the front end of your vehicle (including hood, bumper system, frame, front end body structure, tow hooks and hood pins) may affect the performance of the airbag system, increasing the risk of injury. Do not modify or add equipment to the front end of your vehicle.

Your vehicle has a collection of crash and occupant sensors that provide information to the restraints control module which deploys (activates) the seatbelt pretensioners, driver airbag, passenger airbag, seat mounted side airbags, and the Safety Canopy. Based on the type of crash, the restraints control module deploy the appropriate safety devices.

Supplementary Restraints System

The restraints control module also monitors the readiness of the above safety devices plus the crash and occupant sensors. The readiness of the safety system is indicated by a warning indicator light in the instrument cluster or by a backup tone if the warning light is not working. Routine maintenance of the airbag is not required.

A difficulty with the system is indicated by one or more of the following:



The readiness light will not illuminate immediately after you switch the ignition on.

- The readiness light either flashes or stays lit.
- You hear a series of five beeps. The tone pattern repeats periodically until the problem, the light or both are repaired.

If any of these things happen, even intermittently, have the supplemental restraint system serviced at an authorized dealer immediately. Unless serviced, the system may not function properly in the event of a crash.

The fact that the seatbelt pretensioners or front airbags did not activate for both front seat occupants in a crash does not mean that something is wrong with the system. Rather, it means the restraints control module determined the accident conditions (crash severity, belt usage) were not appropriate to activate these safety devices.

- The design of the front airbags is to activate only in frontal and near-frontal crashes (not rollovers, side impacts or rear impacts unless the crash causes sufficient frontal deceleration).
- The design of the seatbelt pretensioners is to activate in frontal, near-frontal and side crashes, and in rollovers.

- The design of the side airbags is to inflate in certain side impact crashes. Side airbags may activate in other types of crashes if the vehicle experiences sufficient sideways motion or deformation.
- The design of the Safety Canopy is to inflate in certain side impact crashes or rollover events. The Safety Canopy may activate in other types of crashes if the vehicle experiences sufficient sideways motion or deformation, or a certain likelihood of rollover.

AIRBAG DISPOSAL

Contact your authorized dealer as soon as possible. Airbags must be disposed of by qualified personnel.

Keys and Remote Controls

GENERAL INFORMATION ON RADIO FREQUENCIES

This device complies with Part 15 of the FCC Rules and with Industry Canada license-exempt RSS standard(s). Operation is subject to the following two conditions: (1) This device may not cause harmful interference, and (2) This device must accept any interference received, including interference that may cause undesired operation.



WARNING: Changes or modifications not expressly approved by the party responsible for compliance could void the user's authority to operate the equipment. The term "IC:" before the radio certification number only signifies that Industry Canada technical specifications were met.

The typical operating range for your transmitter is approximately 33 ft (10 m). Vehicles with the remote start feature will have a greater range.

One of the following could cause a decrease in operating range:

- Weather conditions.
- Nearby radio towers.
- Structures around the vehicle.
- Other vehicles parked next to your vehicle.

The radio frequency used by your remote control can also be used by other radio transmitters, for example amateur radios, medical equipment, wireless headphones, wireless remote controls, cell phones, battery chargers and alarm systems. If the frequencies are jammed, you will not be able to use your remote control. You can lock and unlock the doors with the key.

Note: Make sure to lock your vehicle before leaving it unattended.

Note: If you are in range, the remote control will operate if you press any button unintentionally.

Note: The remote control contains sensitive electrical components. Exposure to moisture or impact may cause permanent damage.

Intelligent Access (If Equipped)

The system uses a radio frequency signal to communicate with your vehicle and authorize your vehicle to unlock when one of the following conditions are met:

- You activate the front exterior door handle switch.
- You press the luggage compartment button.
- You press a button on the transmitter.

If excessive radio frequency interference is present in the area or if the transmitter battery is low, you may need to mechanically unlock your door. You can use the mechanical key blade in your intelligent access key to open the driver door in this situation. See **Remote Control** (page 55).

REMOTE CONTROL

Integrated Keyhead Transmitter

Use the key blade to start your vehicle and unlock or lock the driver door from outside your vehicle. The integrated keyhead transmitter functions as a programmed ignition key that operates all the locks and starts your vehicle, as well as a remote control.

Keys and Remote Controls



Press the button to release the key blade. Press and hold the button to fold the key blade back in when not in use.



Note: Your vehicle keys came with a security label that provides important key cut information. Keep the label in a safe place for future reference.

Intelligent Access Key (If Equipped)

Note: You may not be able to shift out of park (P) unless the intelligent access key is inside your vehicle.



The intelligent access keys operate the power locks and the remote start system. The key must be in your vehicle to use the push button start.

Removable Key Blade

The intelligent access key also contains a removable key blade that you can use to unlock your vehicle.

Keys and Remote Controls



Press the release button and pull the key blade out.



Note: Your vehicle keys came with a security label that provides important key cut information. Keep the label in a safe place for future reference.

Replacing the Battery

WARNING: Keep batteries away from children to prevent ingestion. Failure to follow this instruction could result in personal injury or death. If ingested, immediately seek medical attention.

WARNING: If the battery compartment does not securely close, stop using the remote control and replace it as soon as possible. In the meantime, keep the remote control away from children. Failure to follow this instruction could result in personal injury or death.

Note: Refer to local regulations when disposing of transmitter batteries.

Note: Do not wipe off any grease on the battery terminals or on the back surface of the circuit board.

Note: Replacing the battery does not erase the programmed key from your vehicle. The transmitter should operate normally.

A message appears in the information display when the remote control battery is low. See **General Information** (page 112).

Integrated Keyhead Transmitter

The remote control uses one coin-type three-volt lithium battery CR2032 or equivalent.

Press the button to release the key blade before beginning the procedure.



Keys and Remote Controls

1. Insert a suitable tool, for example a screwdriver, in the position shown and gently push the clip.
2. Press the clip down to release the battery cover.



3. Carefully remove the cover.



E151800

Note: Do not touch the battery contacts or the printed circuit board with the screwdriver.

4. Insert a suitable tool, for example a screwdriver, in the position shown to release the battery.

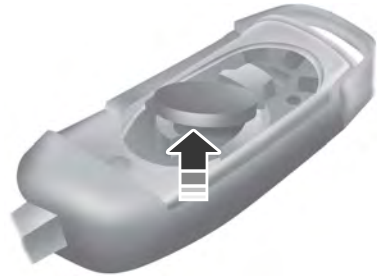

5. Remove the battery.
6. Insert a new battery with the + facing upward.
7. Reinstall the battery housing cover onto the transmitter.

Intelligent Access Key

The remote control uses one coin-type three-volt lithium battery CR2450 or equivalent.



1. Press the release button and pull the key blade out.

Keys and Remote Controls

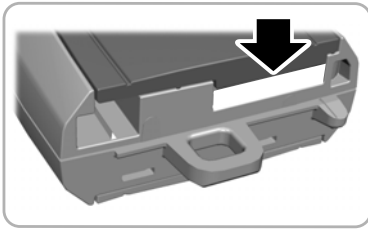

2. Twist a thin coin under the tab hidden behind the key blade head to remove the battery cover.
-
- A diagram showing the transmitter housing with the battery cover removed. A white arrow points up from the cover, and another white arrow points down from the housing, indicating the cover has been lifted out.

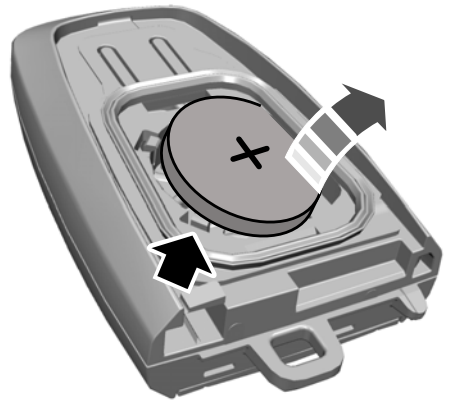

3. Insert a suitable tool, for example a screwdriver, in the position shown and carefully remove the battery.
4. Insert a new battery with the + facing upward.
5. Reinstall the battery housing cover onto the transmitter and install the key blade.

Memory Feature (if Equipped)

You can use the remote control to recall memory positions.

Press the unlock button on a linked remote control to recall memory positions. If you enable the easy entry and exit feature, the seat moves to the easy entry position. The seat moves to the driver memory position when you switch the ignition on.

Linking a Preset Position to your Remote Control

See **Memory Function** (page 156).

Keys and Remote Controls

Car Finder



Press the button twice within three seconds. A tone sounds and the direction indicators flash. We recommend you use this method to locate your vehicle, rather than using the panic alarm.

Sounding the Panic Alarm



Press the button to sound the panic alarm. Press the button again or switch the ignition on to turn it off.

Note: *The panic alarm only operates when the ignition is off.*

Remote Start (If Equipped)



WARNING: To avoid exhaust fumes, do not use remote start if your vehicle is parked indoors or in areas that are not well ventilated.

Note: *Do not use remote start if your fuel level is low.*



The remote start button is on the transmitter.

This feature allows you to start your vehicle from the outside. The transmitter has an extended operating range.

You can configure vehicles with automatic climate control to turn on the automatic climate control when you remote start your vehicle. See **Automatic Climate Control** (page 143). A manual climate control system runs at the setting you set it to when you switched your vehicle off.

Many states and provinces restrict the use of remote start. Check your local and state or provincial laws for specific requirements regarding remote start systems.

The remote start system does not work if any of the following occur:

- The ignition is on.
- The anti-theft alarm triggers.
- You switch off the feature.
- The hood is open.
- The transmission is not in park (P).
- The battery voltage is below the minimum operating voltage.

Remote Control Feedback

An LED on the remote control provides status feedback of remote start or stop commands.

LED	Status
Solid green	Remote start or extension successful
Solid red	Remote stop successful; vehicle off
Blinking red	Remote start or stop failed
Blinking green	Waiting for status update

Remote Starting Your Vehicle

Note: *You must press each button within three seconds of each other.*

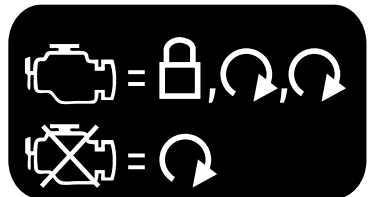

E138626

To remote start your vehicle:

Keys and Remote Controls

1. Press the lock button.
2. Press the remote start button twice.
The exterior lamps flash twice.

The horn sounds if the system fails to start, unless quiet start is on. Quiet start runs the blower fan at a slower speed to reduce noise. You can switch it on or off in the information display. See **General Information** (page 112).

Note: *If you do not follow this sequence, your vehicle does not start remotely, the direction indicators do not flash twice and the horn does not sound.*

Note: *If you remote start your vehicle with an integrated keyhead transmitter, you must switch on the ignition before driving your vehicle. If you remote start your vehicle with an intelligent access transmitter, you must press the push button ignition switch on the instrument panel once while applying the brake pedal before driving your vehicle.*

The power windows do not work during remote start and the radio does not turn on automatically.

The parking lamps remain on and your vehicle runs for 5, 10 or 15 minutes depending on the setting.

Extending the Engine Running Time

To extend the engine running time duration of your vehicle during remote start, repeat steps 1 and 2 while the engine is running. If the duration is set to 10 minutes, the duration extends by another 10 minutes. For example, if your vehicle had been running from the first remote start for 5 minutes, your vehicle continues to run now for a total of 20 minutes. You can extend the remote start up to a maximum of 30 minutes.

Wait at least five seconds before remote starting after the engine stops running.

Turning Your Vehicle Off After Remote Starting



Press the button once. The parking lamps turn off.

You may have to be closer to the vehicle than when starting due to ground reflection and the added noise of the running vehicle.

You can turn the remote start system on or off using the information display. See **General Information** (page 112).

REPLACING A LOST KEY OR REMOTE CONTROL

Replacement or additional keys or remote controls can be purchased from your authorized dealer. Your dealer can program the transmitters to your vehicle.

PRINCIPLE OF OPERATION

MyKey allows you to program keys with restricted driving modes to promote good driving habits. You can program the restrictions to all keys but one. Any keys that you did not program are administrator keys or admin keys.

You can use admin keys to:

- Create a MyKey with certain vehicle restrictions.
- Program certain MyKey settings.
- Clear all MyKey restrictions.

After you program a MyKey, you can view the following information through the information display:

- The total number of admin keys and MyKeys for your vehicle.
- The total distance a MyKey driver traveled with your vehicle.

Note: Every MyKey receives the same restrictions and settings. You cannot program them individually.

Note: For vehicles equipped with a push-button start switch: When both a MyKey and an admin key are present when you start your vehicle, the system recognizes the admin key only.

Standard Settings

Not every vehicle includes the features listed below. If your vehicle has this equipment, then you cannot change the following settings when using a MyKey:

- Seatbelt reminder or Belt-Minder™. MyKey mutes the audio system until drivers, and in some instances, passengers, fasten their seatbelts.
- Earlier low-fuel warning. The low-fuel warning activates earlier for MyKey drivers, giving them more time to refuel.

- Certain driver alerts, stability systems or parking aids turn on automatically when you use the MyKey system. For example, Blind Spot Information System (BLIS), cross traffic alert, lane departure warning or forward collision warning.
- Restricted touchscreen operation in some markets. For example, MyKey may prevent manual navigation destination input while the vehicle is in any gear other than park (P) or when the vehicle reaches a certain rate of speed.
- Satellite radio adult content restrictions, if this feature is available in your market.

Note: MyKey drivers may be able to switch the lane departure warning feature off, but this feature turns back on automatically with every new key cycle.

Note: If your vehicle includes an AM/FM radio or a very basic audio system, then the radio may not mute.

Optional Settings

You can configure certain vehicle feature settings when you first create a MyKey. You can also change the settings afterward with an admin key.

Note: Not every feature applies to every vehicle in every market. When they are available for your vehicle, then they appear in your information display, providing choices to switch them on or off, or to select a more specific setting.

- Various vehicle speed limits so the MyKey driver cannot exceed certain speeds. The information display shows warnings followed by an audible tone when the MyKey driver reaches the set speed. You cannot override the set speed by fully depressing the accelerator pedal.



WARNING: Do not set MyKey maximum speed limit to a limit that will prevent the driver from maintaining a safe speed considering posted speed limits and prevailing road conditions. The driver is always responsible to drive in accordance with local laws and prevailing conditions. Failure to do so could result in accident or injury.

- Various vehicle speed reminders so MyKey drivers know when their vehicle speed approaches the limits. Warnings appear in your information display and a tone sounds when the MyKey drivers exceed the set vehicle speed.
- The audio system's maximum volume limits to 45% so MyKey drivers can concentrate on the road. A message appears in the information display when MyKey drivers attempt to exceed the limited volume. MyKey also disables the automatic volume control.
- Always on setting. This setting forces certain features to remain on and active for MyKey drivers. For example, E911 or emergency assistance and the do not disturb features stay on even if a MyKey driver uses the feature's control to switch it off.

Note: *If your vehicle includes an AM/FM radio or a very basic audio system, then the radio may not mute.*

CREATING A MYKEY

Use the information display to create a MyKey.

1. Switch the ignition on using the key or the transmitter you want to program. If your vehicle has a push-button start, place the transmitter into the backup slot. See **Passive Anti-Theft System** (page 76).

2. Access the main menu in the information display and then scroll through the menus to begin programming your MyKey. See **Information Displays** (page 112).
3. Follow the instructions in the display.
4. A confirmation message appears in the display after you finish programming your MyKey. The programmed restrictions apply when you key off, open and close driver door and restart your vehicle with the programmed key or transmitter.

Note: *Make sure you label the programmed MyKey so you can distinguish it from the admin keys.*

You can also program the optional MyKey settings.

Programming or Changing Configurable Settings

Use the information display to program or change your optional MyKey settings.

1. Switch the ignition on using the key or the transmitter you want to program.
2. Access the main menu in the information display and then scroll through the menus to change the settings of your MyKey. See **Information Displays** (page 112).
3. Follow the instructions in the display.
4. A confirmation message appears in the display after you finish programming your MyKey. The programmed restrictions apply when you key off, open and close the driver door and restart your vehicle with the programmed key or transmitter.

Note: *You can clear or change your MyKey settings at any time during the same key cycle as you created the MyKey. If you switch the engine off, you must use an admin key to change or clear your optional MyKey settings.*

CLEARING ALL MYKEYS

When you clear your MyKeys, you remove all restrictions and return all MyKeys to their original admin key status at once. To clear all MyKeys of all MyKey settings, use the information display.

1. Switch the ignition on using an admin key.
2. Access the main menu in the information display and then scroll through the menus to begin clearing your MyKey programming. See **Information Displays** (page 112).
3. Follow the instructions in the display.
4. A confirmation message appears in the display after you finish clearing your MyKeys.

Note: *When you clear your MyKeys, you remove all restrictions and return all MyKeys to their original admin key status. You cannot remove the MyKey restrictions individually.*

CHECKING MYKEY SYSTEM STATUS

You can find information about your programmed MyKeys by using the information display. See **Information Displays** (page 112).

MYKEY – TROUBLESHOOTING

Condition	Potential causes
I cannot create a MyKey.	<ul style="list-style-type: none">· The key or transmitter used to start the vehicle does not have admin privileges.· Vehicles with keyless start: Make sure you place the transmitter into the backup slot.

MyKey Distance

Tracks the distance when drivers use a MyKey. The only way to delete the accumulated distance is by using an admin key to clear all MyKeys. If the distance does not accumulate as expected, then the intended user is not using the MyKey, or an admin key user recently cleared and then recreated a MyKey.

Number of MyKeys

Indicates the number of MyKeys programmed to your vehicle. Use this feature to detect how many MyKeys you have for your vehicle and determine when all MyKeys have been deleted.

Number of Admin Keys

Indicates how many admin keys are programmed to your vehicle. Use this feature to determine how many admin keys you have for your vehicle, and detect if an additional MyKey has been programmed.

USING MYKEY WITH REMOTE START SYSTEMS

MyKey is not compatible with non Ford-approved, aftermarket remote start systems. If you choose to install a remote start system, see an authorized dealer for a Ford-approved remote start system.

MyKey™

Condition	Potential causes
	<ul style="list-style-type: none"> · The key or transmitter used to start the vehicle is the only admin key. There always has to be at least one admin key. · SecuriLock passive anti-theft system is disabled or in unlimited mode.
I cannot program the configurable settings.	<ul style="list-style-type: none"> · The key or transmitter used to start the vehicle does not have admin privileges. · There are no MyKeys programmed to the vehicle. See Creating a MyKey (page 63).
I cannot clear the MyKeys.	<ul style="list-style-type: none"> · The key or transmitter used to start the vehicle does not have admin privileges. · No MyKeys are created. See Creating a MyKey (page 63).
I lost the only admin key.	<ul style="list-style-type: none"> · Purchase a new key or transmitter from your authorized dealer.
I lost a key.	<ul style="list-style-type: none"> · Program a spare key or transmitter. You may need to see your authorized dealer.
MyKey distances do not accumulate.	<ul style="list-style-type: none"> · The MyKey user is not using the MyKey. · An admin key holder cleared the MyKeys and created new MyKeys. · The key system has been reset.

Doors and Locks

LOCKING AND UNLOCKING

You can use the power door lock control or the remote control to lock and unlock your doors and tailgate. See **Tailgate Lock** (page 71).

Power Door Locks (If Equipped)

The power door lock control is on the driver and front passenger door panels.

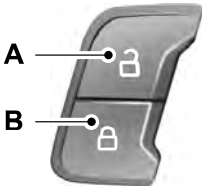

E138628

A Unlock.

B Lock.

Remote Control

You can use the remote control at any time your vehicle is not running.

Unlocking the Vehicle (Two-Stage Unlock)



Press the button to unlock the driver door. Press the button again within three seconds to unlock all doors. The direction indicators flash. The direction indicators flash twice to confirm the change. The unlocking mode applies to the remote control, keyless entry keypad and intelligent access.

Press and hold both the lock and unlock buttons on the remote control for four seconds to disable or enable two-stage unlocking. Disabling two-stage unlocking allows your entire vehicle to unlock with one press of the button.

Intelligent access at the driver door unlocks your entire vehicle when you disable two-stage unlocking.

Locking the Vehicle



Press the button to lock all doors. The direction indicators flash.

Press the button again within three seconds to confirm that all the doors have closed. The doors lock again, the horn sounds and the direction indicators flash if all the doors have closed.

Mislock

If any door is open, or if the hood is open on vehicles with an anti-theft alarm or remote start, the horn sounds twice and the direction indicators do not flash.

Activating Intelligent Access (If Equipped)

General Information

You can unlock and lock the vehicle without taking the keys out of your pocket or purse when your intelligent access key is within 3 ft (1 m) of your vehicle. Intelligent access uses a sensor on the back of the door handle for unlocking and a separate sensor on the face of each door handle for locking.

The system does not function if:

- Your vehicle battery has no charge.
- The key battery has no charge.
- The key frequencies have jammed.

Doors and Locks

Note: The system may not function if the key is close to metal objects or electronic devices, for example keys or a cell phone.

Note: If the system does not function, use the key blade to lock and unlock your vehicle. See **Remote Control** (page 55).

Unlocking Using Intelligent Access



With your intelligent access key within 3 ft (1 m) of your vehicle, touch the unlock sensor on the back of the door handle for a brief period and then pull on the door handle to unlock, being careful to not touch the lock sensor at the same time or pulling the door handle too quickly. The intelligent access system requires a brief delay to authenticate your intelligent access key fob.

Locking Using Intelligent Access

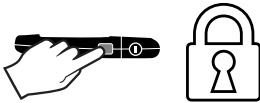

With your intelligent access key within 3 ft (1 m) of your vehicle, touch the outer door handle lock sensor for approximately one second to lock, being careful to not touch the unlock sensor on the back of the door handle at the same time. After locking, you can immediately pull on the door handle to confirm locking occurred without inadvertently unlocking.

Note: Do not use the outside door handle as a roof cargo strap.

At the Electronic Tailgate (If Equipped)



Press the exterior tailgate release button inside of the tailgate handle. The tailgate unlocks and opens. See **Tailgate Lock** (page 71).

Smart Unlock (If Equipped)

This feature helps to prevent you from locking your intelligent access key inside your vehicle's passenger compartment or rear cargo area.

If you leave your key in the ignition, when you open the driver door and lock your vehicle with the power door lock control, the doors lock then unlock.

You can still lock your vehicle with the key in the ignition by:

- Using the manual lock on the inside of the door.
- Locking the driver door with a key.
- Using the keyless entry keypad.
- Using the lock button on the remote control.

Smart Unlocks for Intelligent Access Keys (If Equipped)

This feature helps to prevent you from locking your intelligent access key inside your vehicle's passenger compartment or rear cargo area.

Doors and Locks

When you lock your vehicle using the power door lock control (with the door open, vehicle in park and ignition off), your vehicle searches for an intelligent access key in the passenger compartment after you close the door. If your vehicle finds a key, all the doors immediately unlock.

In order to override the smart unlock feature and intentionally lock the intelligent access key inside your vehicle, you can lock your vehicle after all doors are closed by using the keyless entry keypad, pressing the lock button on another intelligent access key or touching the locking area on the handle with another intelligent access key in your hand.

When you open one of the front doors and lock your vehicle using the power door lock control, all doors lock then unlock if the ignition is on.

Autolock (If Equipped)

Autolock locks all the doors when:

- All doors have closed.
- The ignition is on.
- You shift into any gear putting your vehicle in motion.
- Your vehicle reaches a speed greater than 12 mph (20 km/h).

Autolock repeats when:

- You open then close any door while the ignition is on and your vehicle speed is 9 mph (15 km/h) or lower.
- Your vehicle reaches a speed greater than 12 mph (20 km/h).

Autounlock

Autounlock unlocks all the doors when:

- Your vehicle comes to a stop and you switch the ignition off or to the accessory position.
- You open the driver door within 10 minutes of switching the ignition off or to accessory.

Note: *The doors do not autounlock if you electronically lock your vehicle after you switch the ignition off and before you open the driver door.*

Enabling or Disabling Autounlock

You can enable or disable the autounlock feature in the information display or an authorized dealer can do it for you. See **General Information** (page 112).

Illuminated Entry

The interior lamps and select exterior lamps illuminate when you unlock the doors with the remote entry system.

The illuminated entry system turns off the lights if:

- The ignition is on.
- You press the remote control lock button.
- After 25 seconds of illumination.

The dome lamp does not turn on if the control is set to the off position.

The lights do not turn off if:

- You switch them on with the dimmer control.
- Any door is open.

Battery Saver

The battery saver turns off the interior lamps 10 minutes after you switch the ignition off, or 10 minutes after you exit the vehicle.

Doors and Locks

Accessory Mode Battery Saver for Intelligent Access Keys (If Equipped)

If you leave the ignition on after leaving your vehicle, it turns off 30 minutes after you close all the doors.

KEYLESS ENTRY (IF EQUIPPED)

SECURICODE™ KEYLESS ENTRY KEYPAD

The keypad is near the driver window and illuminates when you touch it.

Note: *If you enter your entry code too fast on the keypad, the unlock function may not work. Re-enter your entry code more slowly.*



You can use the keypad to:

- Lock or unlock the doors and liftgate.
- Program and erase user codes.
- Arm and disarm the anti-theft alarm.

You can operate the keypad with the factory-set five-digit entry code. The code is located on the owner's wallet card in the glove box and is available from an authorized dealer. You can also create up to five of your own five-digit personal entry codes.

Programming a Personal Entry Code

To create your own personal entry code:

1. Enter the factory-set code.
2. Press **1-2** on the keypad within five seconds.
3. Enter your personal five-digit code.
4. Press **1-2** on the keypad to save personal code one.

The doors will lock then unlock to confirm that programming was successful.

To Program additional personal entry codes, repeat Steps 1-3, then for Step4:

- Press **3-4** to save personal code two.
- Press **5-6** to save personal code three.
- Press **7-8** to save personal code four.
- Press **9-0** to save personal code five.

Tips:

- Do not set a code that uses five of the same number.
- Do not use five numbers in sequential order.
- The factory-set code will work even if you have set your own personal code.

Erasing a Personal Code

1. Enter the factory-set five-digit code.
2. Press and release **1-2** on the keypad within five seconds.
3. Press and hold **1-2** for two seconds. This must be done within five seconds of completing Step 2.

All personal codes erase and only the factory-set five-digit code will work.

Anti-Scan Feature

The keypad will go into an anti-scan mode if you enter the wrong code seven times (35 consecutive button presses). This mode disables the keypad for one minute and the keypad lamp will flash.

Doors and Locks

The anti-scan feature will turn off after:

- One minute of keypad inactivity.
- Pressing the unlock button on the remote control.
- Switching the ignition on.
- Unlocking the vehicle using intelligent access.

Unlocking and Locking the Doors

To Unlock the Driver Door

Enter the factory-set five-digit code or your personal code. You must press each number within five seconds of each other. The interior lamps illuminate.

Note: *All doors unlock if you disable the two-stage unlocking feature. See **General Information** (page 112).*

To Unlock All Doors

Enter the factory-set code or your personal code, then press **3•4** control within five seconds.

To Lock All Doors

Press and hold **7•8** and **9•0** at the same time with the driver door closed. You do not need to enter the keypad code first.

To Release the Tailgate (If Equipped)

Enter the factory-set code or your personal code, then press **5•6** control within five seconds.

Tailgate (If Equipped)

TAILGATE LOCK (IF EQUIPPED)

The tailgate lock can help prevent theft of the tailgate.



E224958

Insert the ignition key into the tailgate lock. Turn it to the left to lock the tailgate. Turn it to the right to unlock the tailgate.

ELECTRONIC TAILGATE (IF EQUIPPED)



WARNING: It is extremely dangerous to ride in a cargo area, inside or outside of a vehicle. In a crash, people riding in these areas are more likely to be seriously injured or killed. Do not allow people to ride in any area of your vehicle that is not equipped with seats and safety belts. Make sure everyone in your vehicle is in a seat and properly using a safety belt. Failure to follow this warning could result in serious personal injury or death.

The electronic tailgate release will not operate when:

- The battery voltage is below the minimum operating voltage.
- The vehicle speed is at or above 3 mph (5 km/h).

With the Remote Control



Press the remote control button twice within three seconds.

With the Outside Control Button

1. Unlock the vehicle with the remote control or power door unlock control. If an intelligent access transmitter is within 3 ft (1 m) of the tailgate, the tailgate will unlock when you press the tailgate release button.



2. Press the button in the top of the tailgate handle.
3. Push the tailgate up to close the tailgate.

Note: *The electronic tailgate is not a powered tailgate. The use of a tonneau cover or other aftermarket accessories, freezing conditions or being parked downhill may stop your tailgate from opening automatically after it is unlatched. You may need to pull the handle to open the tailgate if the tailgate does not automatically lower after being unlatched.*

Tailgate (If Equipped)

REMOVING THE TAILGATE



WARNING: Always properly secure cargo to prevent shifting cargo or cargo falling from the vehicle. Failure to do so could result in compromised vehicle stability and serious personal injury to vehicle occupants or others.

You can remove the tailgate for more loading room.

1. Obtain the tailgate removal kit from the glove box.

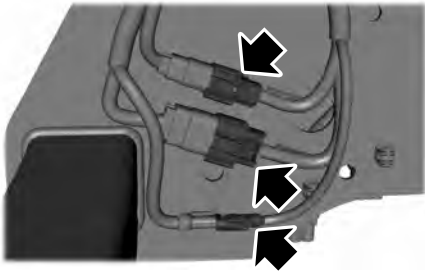

E248384

2. Locate and disconnect the frame connections. They are on the left-hand side of the vehicle.

Note: Your vehicle may have up to three frame connections.

3. Install the caps from the tailgate removal kit on the in-line connectors that remain on the vehicle.

Note: If you do not install the caps on the connectors, some features may not operate as intended.

4. Partially lower the tailgate. Carefully feed the tailgate harness up through the bumper and place it out of the way.
5. Lower the tailgate.

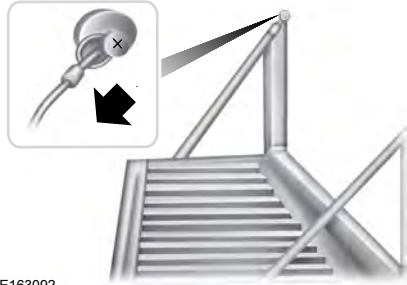

E163092

6. Use a screwdriver to gently pry the spring clip on each connector past the head of the support screw. Disconnect the cable.
7. Disconnect the other cable.
8. Lift the tailgate to a 45 degree angle from horizontal.
9. Lift the right side off its hinge.
10. Lift the tailgate to an 80 degree angle from horizontal.
11. Remove the tailgate from the left side hinge by sliding it to the right.

Reverse the steps to reinstall the tailgate.

TAILGATE STEP (IF EQUIPPED)

Use the step to make entering the truck bed easier.

To reduce the risk of falling:

- Only operate the step when your vehicle is on a level surface.
- Only operate the step in areas with sufficient lighting.
- Always open the step panel to widen the step.
- Always use the grab handle when climbing on the step.
- Do not use the step with bare feet.

Tailgate (If Equipped)

- Make sure the step is clean before use.
- Keep the step load, you plus the load, below 350 lb (159 kg).

Opening the Step

Note: Make sure to close and fully latch the step before moving your vehicle. Do not drive with the step or grab handle open.

1. Lower the tailgate.
2. Push the button in the center of the step molding. The step pops out slightly.



E187718

3. Pull the step out fully. Lower the step to its lowest position.



E189557

4. Pull the yellow handle stop backward out of the tailgate until it fully extends.
5. Rotate the handle up from horizontal to vertical until you hear a click. You have locked the handle in place.

Note: Do not tow with the step or grab handle.

Replace the slip resistance tape or grab handle molding if it appears as worn or damaged.

Closing the Step

1. Press the yellow button on the telescoping handle to lower the handle, then press the yellow lever at the bottom of the handle to unlock the handle. Rotate the handle down from vertical to horizontal and push it into the tailgate.
2. Rotate the step up until it is horizontal, then push it back into the tailgate until the step is secure.

BED EXTENDER (IF EQUIPPED)

Note: Do not use the bed extender when driving off road.

Note: Make sure to engage the locking pins and knobs fully before driving your vehicle.

Note: Make sure to secure all cargo.

Note: Do not exceed 150 pounds (68 kilograms) on the tailgate when your vehicle is moving.

Note: Do not keep the bed extender in the tailgate mode when you are not using it for restraining cargo. Always keep the bed extender in the grocery mode or the stowed position with the tailgate closed.

Tailgate (If Equipped)

Tailgate mode



E163095

1. Pull the locking pin toward the center of your vehicle.



E163096

2. Open the latches to release the panels.



E163097

3. Rotate the panels toward the tailgate. Repeat Steps 1-3 on the other side of your vehicle.



E163098

4. Connect the two panels. Rotate both knobs one-quarter turn clockwise to secure the panels.



E163099

5. Make sure to insert the latch rod into the tailgate hole. Make sure to engage both sides of the locking pins into their holes in the pick-up box.

Reverse the steps to store the bed extender.

Tailgate (If Equipped)

Grocery mode



E163100

Follow Steps 1-4 of the tailgate mode instructions by rotating the panels away from the tailgate. Close the tailgate.

Security

PASSIVE ANTI-THEFT SYSTEM

Note: *The system is not compatible with non-Ford aftermarket remote start systems. Use of these systems may result in engine starting problems and a loss of security protection.*

Note: *Metallic objects, electronic devices or a second coded key on the same key chain may result in vehicle starting problems, especially if they are too close to the key when starting your vehicle. Prevent these objects from touching the coded key when starting your vehicle. Switch the ignition off, move all objects on the key chain away from the coded key and restart your vehicle if a problem occurs.*

Note: *Do not leave a duplicate coded key in your vehicle. Always take your keys and lock all doors when leaving your vehicle.*

SecuriLock®

The system helps prevent the engine from starting unless you use a coded key programmed to your vehicle. Using the wrong key may prevent your vehicle from starting. A message may appear in the information display.

If you are unable to start your vehicle with a coded key, it is not operating correctly. A message may appear in the information display.

Automatic Arming

The system arms when you switch the ignition off.

Automatic Disarming

The system disarms when you switch the ignition on with a coded key.

Replacement Keys

Note: *Your vehicle comes with two keys.*

The integrated keyhead transmitter functions as a programmed ignition key that operates all the locks and starts your vehicle, as well as a remote control.

The intelligent access key functions as a programmed key that operates the driver door lock and turns on the intelligent access with push button start system, as well as a remote control.

If your coded keys are lost or stolen and you do not have an extra coded key, you need to erase the key codes from your vehicle and program new coded keys. Contact an authorized dealer.

Store an extra programmed key away from your vehicle in a safe place. You can purchase replacement keys or remote controls from an authorized dealer.

Programming a Spare Integrated Keyhead Transmitter

Note: *You can program a maximum of four keys to your vehicle. All six can be integrated keyhead transmitters.*

You can program your own integrated keyhead transmitter or standard SecuriLock coded keys to your vehicle. This procedure programs both the vehicle immobilizer keycode and the remote control to your vehicle.

Only use integrated keyhead transmitters or standard SecuriLock keys.

You must have two previously programmed coded keys and the new unprogrammed key readily accessible. Contact an authorized dealer to have the spare key programmed if two previously programmed keys are not available.

Read and understand the entire procedure before you begin.

1. Insert the first previously programmed coded key into the ignition.

Security

2. Switch the ignition from off to on. Keep the ignition on for at least 3 seconds, but no more than 10 seconds.
3. Switch the ignition off and remove the first coded key from the ignition.
4. After at least 3 seconds but within 10 seconds of switching the ignition off, insert the second previously coded key into the ignition.
5. Switch the ignition from off to on. Keep the ignition on for at least 3 seconds, but no more than 10 seconds.
6. Switch the ignition off and remove the second previously programmed coded key from the ignition.
7. After at least 3 seconds but within 10 seconds of switching the ignition off and removing the previously programmed coded key, insert the new unprogrammed key into the ignition.
8. Switch the ignition from off to on. Keep the ignition on for at least six seconds.
9. Remove the newly programmed coded key from the ignition.

If you have successfully programmed the new integrated keyhead transmitter, it will start your vehicle and operate the remote entry system.

If programming was unsuccessful, wait 10 seconds and repeat steps 1 through 9. If you are still unsuccessful, take your vehicle to your authorized dealer.

Programming a Spare Intelligent Access Key

Note: *Do not place the device on the wireless accessory charging area when programming intelligent access keys.*

Note: *You can program a maximum of six keys to your vehicle. All six must be intelligent access keys.*

This procedure programs both the vehicle immobilizer keycode and the remote control to your vehicle.

You must have two previously programmed intelligent access keys inside your vehicle and the new unprogrammed intelligent access key readily accessible. Contact an authorized dealer to have the spare key programmed if two previously programmed keys are not available.

Make sure that the ignition is switched off before beginning this procedure. Make sure that you close all the doors before beginning and that they remain closed throughout the procedure. Carry out all steps within 30 seconds of starting the sequence. Stop and wait for at least one minute before starting again if you carry out any steps out of sequence.

Read and understand the entire procedure before you begin.

Security

Type One

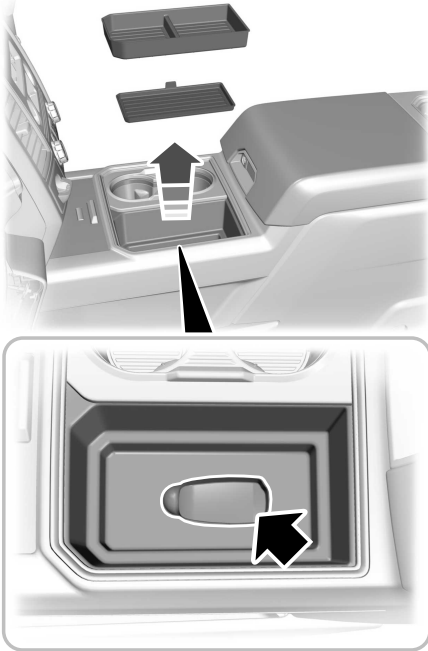

E226701

Type Two



1. Remove the key blade from the transmitter.

2. Remove the tray and the cover from the center console. With the buttons facing upward, place the first intelligent access key in the backup slot.
3. Press the push button ignition switch.
4. Wait five seconds and then press the push button ignition switch again.
5. Remove the intelligent access key.
6. Within 10 seconds, place a second programmed intelligent access key in the backup slot and press the push button ignition switch.
7. Wait five seconds and then press the push button ignition switch again.
8. Remove the intelligent access key.
9. Wait five seconds, then place the unprogrammed intelligent access key in the backup slot and press the push button ignition switch.

Programming is now complete. Check that the remote control functions operate and your vehicle starts with the new intelligent access key.

If programming was unsuccessful, wait 10 seconds and repeat steps 1 through 7. If you are still unsuccessful, take your vehicle to your authorized dealer.

ANTI-THEFT ALARM

The active anti-theft system is designed to warn you in the event of unauthorized vehicle entry and is also designed to help prevent unwanted towing of your vehicle. You can choose what is monitored by arming the system in different ways. See **Information Displays** (page 112).

The direction indicators flash and the horn sounds if the system triggers while the alarm is armed.

Take all remote controls to an authorized dealer if there is any potential alarm problem with your vehicle.

Security

Using the System

You can select two levels of alarm security. You can change the level of security when the ignition is switched off through the information display with the two options below:

Perimeter Only (If Equipped)

Perimeter only monitors the following:

- Doors.
- Hood.
- Tailgate.

All Sensors (If Equipped)

All sensors monitors the following:

- Doors.
- Hood.
- Tailgate.
- Movement inside your vehicle.
- Change in vehicle inclination, for example, unwanted towing.

Note: Do not choose all sensors monitor mode when the vehicle is in transport or if movement within the vehicle is likely to occur.

Note: For correct operation of the interior motion detection system, make sure you close all the windows prior to arming the system. This helps prevent accidental alarm activation due to external influences. Additionally, the interior motion sensing system does not arm if any door is ajar.

Arming the Alarm

The alarm is ready to arm when there is not a key in the ignition. Lock your vehicle using the remote control or keyless entry keypad. You can also lock your vehicle using the lock sensor on the exterior door handle if your vehicle is equipped with intelligent access. See **Locking and Unlocking** (page 66).

The direction indicators flash once after you lock your vehicle. This indicates the alarm is in the pre-armed mode. It fully arms after 20 seconds.

Disarming the Alarm

Disarm the alarm by any of the following actions:

- Press the power door unlock button within the 20-second pre-armed mode.
- Unlock the doors with the remote control or keyless entry keypad. If equipped with intelligent access, you can use the unlock sensor on the exterior door handle. See **Locking and Unlocking** (page 66).
- Switch the ignition on or start your vehicle.
- Use a key in the driver door lock cylinder to unlock your vehicle, then switch the ignition on within 12 seconds.

Power Running Boards (If Equipped)

USING POWER RUNNING BOARDS

WARNING: In extreme climates, excessive ice buildup may occur, causing the running boards not to deploy. Make sure that the running boards have deployed, and have finished moving before attempting to step on them. The running boards will resume normal function once the blockage is cleared.

WARNING: Switch off the running boards before jacking or placing any object under your vehicle. Never place your hand between the extended running board and your vehicle. A moving running board may cause injury.

Note: Do not use the running boards, front and rear hinge assemblies, running board motors, or the running board underbody mounts to lift your vehicle when jacking. Always use proper jacking points.

Note: The running boards may operate more slowly in cool temperatures.

Note: The running board mechanism may trap debris such as mud, dirt, snow, ice and salt. This may cause unwanted noise. If this happens, manually set the running boards to the deployed position. Then, wash the system, in particular the front and rear hinge arms, with a high-pressure car wash wand.

Automatic Power Deploy



E166682

The running boards automatically extend down and out when you open the door. This can help you enter and exit your vehicle.

Automatic Power Stow

When you close the doors, the running boards return to the stowed position after a two-second delay.

Manual Power Deploy

You can manually operate the running boards in the information display.

1. Select **Settings**.
2. Select **Advanced Settings**.
3. Select **Vehicle**.
4. Select **Power Running Boards**.
5. Select your desired power running board setting.

Set the running boards in the deployed position to access the roof.

The running boards return to the stowed position and enter automatic mode when the vehicle speed exceeds 3 mph (5 km/h).

Power Running Boards (If Equipped)

Enabling and Disabling

You can enable and disable the power running board feature in the information display.

- When disabled, the running boards move to the stowed position regardless of the door position.
- When enabled, the running boards move back to the correct positions based on the door position.

Bounce-back

The running board will reverse direction and move to the end of travel if it encounters an object while moving.

Steering Wheel

ADJUSTING THE STEERING WHEEL - VEHICLES WITH: MANUAL ADJUSTABLE STEERING COLUMN



WARNING: Do not adjust the steering wheel when your vehicle is moving.

Note: Make sure that you are sitting in the correct position. See **Sitting in the Correct Position** (page 150).

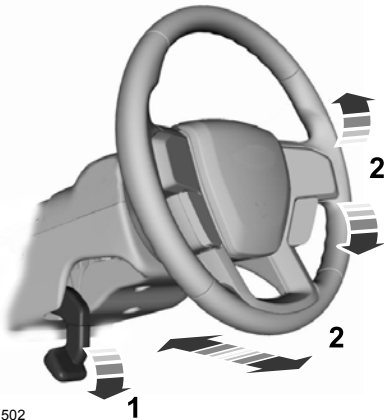

E261502

1. Unlock the steering column.
2. Adjust the steering wheel to the desired position.

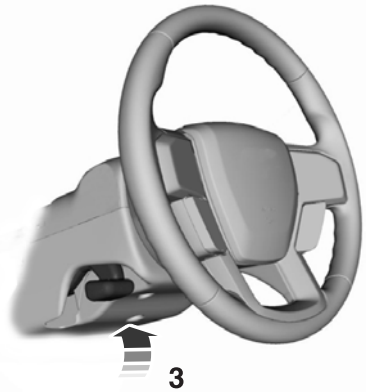

E261503

3. Lock the steering column.

ADJUSTING THE STEERING WHEEL - VEHICLES WITH: POWER ADJUSTABLE STEERING COLUMN



WARNING: Do not adjust the steering wheel when your vehicle is moving.

Note: Make sure that you are sitting in the correct position. See **Sitting in the Correct Position** (page 150).

Steering Wheel



E261582

Use the control on the side of the steering column to adjust the position.

To adjust:

- Tilt: Press the top or bottom of the control.
- Telescope: Press the front or rear of the control.

End of Travel Position

The steering column sets a stopping position just short of the end of the column position to prevent damage to the steering column. A new stopping position sets if the steering column encounters an object when tilting or telescoping.

To reset the steering column to its normal stopping position:

1. Confirm there is nothing obstructing the motion of the steering column.
2. Press and hold the steering column control until the steering column stops moving.
3. Press the steering column control again.

Note: The steering column may begin to move again.

4. When the steering column stops, continue holding the control for a few seconds.
5. Repeat for each direction as necessary.

A new stopping position sets. The next time you tilt or telescope the steering column, it stops just short of the end of the column position.

Memory Feature (if Equipped)

You can save and recall the steering column position with the memory function. See **Memory Function** (page 156).

Pressing the adjustment control during a memory recall cancels the operation.

Easy Entry and Exit Feature

The column moves up when you switch the ignition off. Switch the ignition on to return the system to its previous settings. You can switch this feature on or off in the information display. See **Information Displays** (page 112).

Note: If you press any adjustment or memory button when in easy exit mode, the system cancels the operation.

Note: Depending on your vehicle, the column may move up and in.

Steering Wheel

AUDIO CONTROL









E291380



E291395

You can operate the following functions with the control:

-  Press - to decrease volume level.
Press + to increase volume level.
-  Press to access the previous media selection.
-  Press to access the next media selection.
-  Press repeatedly to scroll through available audio sources.
-  Press to access phone mode or to answer a phone call.

 Press to end a phone call.

 Press to silence the current media

VOICE CONTROL

The controls are on the steering wheel.

 Press and release to activate voice recognition.

CRUISE CONTROL - VEHICLES WITH: CRUISE CONTROL



E191329

See **What Is Cruise Control** (page 241).

Steering Wheel

CRUISE CONTROL - VEHICLES WITH: ADAPTIVE CRUISE CONTROL



E191337

See **Using Adaptive Cruise Control** (page 242).

INFORMATION DISPLAY CONTROL



E191336

See **Information Displays** (page 112).

HEATED STEERING WHEEL (IF EQUIPPED)

Switch the heated steering wheel on and off using the touchscreen.



Touch the button to switch the heated steering wheel on and off.

Note: You can use the heated steering wheel only when the engine is running.

Note: The system uses a sensor and is designed to control the temperature of the steering wheel and to prevent it from overheating.

Note: In warm temperatures, the steering wheel quickly reaches its maximum temperature and the system reduces the current to the heating element. This could cause you to think that the system has stopped working but it has not. This is normal.

HORN



Adjustable Pedals (If Equipped)

ADJUSTING THE PEDALS



WARNING: Never use the pedal adjustment controls when your feet are on the accelerator or brake pedal when the vehicle is moving.

Note: Adjust the pedals only when your vehicle is in park (P).

Depending on your vehicle and equipment level, the shape and location of your power-adjustable pedal control can vary.

- If your control is vertical, then it is to the left of the steering column and on the instrument panel.
- If your control is horizontal, then it is on the left side of the steering column and on the instrument panel.

Vertical Control

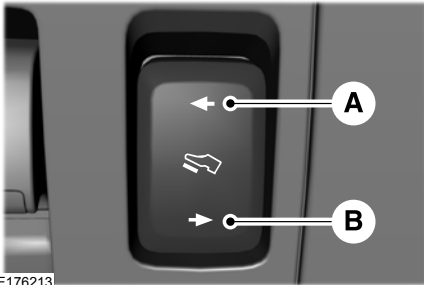

E176213

- A. Farther away from you.
- B. Closer to you.

Horizontal Control

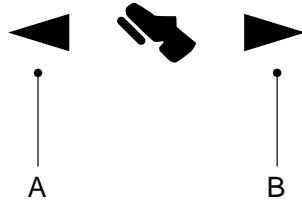

E162916

- A. Farther away from you.
- B. Closer to you.

Both horizontal and vertical controls operate the same way:

1. Press and hold A to move the pedals farther away from you.
2. Press and hold B to move the pedals closer to you.

You can save and recall the pedal positions with the memory feature. See **Seats** (page 150).

Wipers and Washers

WINDSHIELD WIPERS

Note: Fully defrost the windshield before you switch the windshield wipers on.

Note: Make sure you switch the windshield wipers off before entering a car wash.

Note: If streaks or smears appear on the windshield, clean the windshield and the wiper blades. If that does not resolve the issue, install new wiper blades.

Note: Do not operate the wipers on a dry windshield. This may scratch the glass, damage the wiper blades or cause the wiper motor to burn out. Always use the windshield washers before wiping a dry windshield.

Note: Make sure you switch the windshield wipers off before entering a car wash.

Note: If streaks or smears appear on the windshield, clean the windshield and the wiper blades. If that does not resolve the issue, install new wiper blades.

Note: The courtesy wipe feature turns on after using the windshield washers to remove any excess washer fluid and debris. You can adjust the courtesy wipe settings in the instrument display.

Wet or winter driving conditions with ice, snow or salty road mist can cause inconsistent and unexpected wiping or smearing.

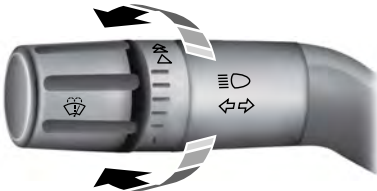

E172816

- Rotate away from you for a long wipe interval.
- Rotate toward you for a short wipe interval.

Speed Dependent Wipers

When your vehicle speed increases, the interval between wipes decreases.

AUTOWIPERS (IF EQUIPPED)

Note: Fully defrost the windshield before you switch the windshield wipers on.

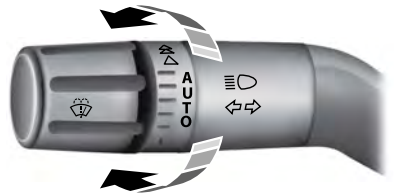

E172817

Use the rotary control to adjust the sensitivity of the autowipers. When you select low sensitivity, the wipers operate when the sensor detects a large amount of water on the windshield. When you select high sensitivity, the wipers operate when the sensor detects a small amount of water on the windshield.

Keep the outside of the windshield clean. The rain sensor is very sensitive and the wipers may operate if dirt, mist or insects hit the windshield.

Wipers and Washers

In these conditions, you can do the following:

- Lower the sensitivity of the autowipers to reduce the amount of smearing on the windshield.
- Switch to normal or high-speed wipe.
- Switch autowipers off.

WINDSHIELD WASHERS



E172818

- A brief press causes a single wipe without washer fluid.
- A brief press and hold causes the wipers to swipe three times with washer fluid.
- A long press and hold turns on the wipers and washer fluid for up to 10 seconds.

A wipe occurs a few seconds after washing to clear any remaining washer fluid. You can switch this feature on or off in the information display. See **Information Displays** (page 112).

Note: Do not operate the washers when the washer reservoir is empty. This could cause the washer pump to overheat.

Lighting

GENERAL INFORMATION

Condensation in the Exterior Front Lamps and Rear Lamps

Exterior front lamps and rear lamps have vents to accommodate normal changes in air pressure.

Condensation can be a natural by-product of this design. When moist air enters the lamp assembly through the vents, there is a possibility that condensation can occur when the temperature is cold. When normal condensation occurs, a fine mist can form on the interior of the lens. The fine mist eventually clears and exits through the vents during normal operation.

Clearing time may take as long as 48 hours under dry weather conditions.

Examples of acceptable condensation are:

- The presence of a fine mist (no streaks, drip marks or large droplets).
- A fine mist covers less than 50% of the lens.

Examples of unacceptable condensation are:

- A water puddle inside the lamp.
- Streaks, drip marks or large droplets present on the interior of the lens.

If you see any unacceptable condensation, have your vehicle checked by an authorized dealer.

LIGHTING CONTROL

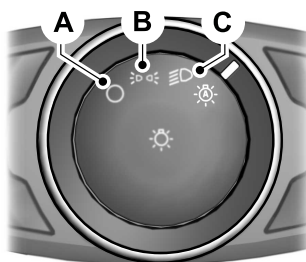

- A Lamps off.
- B Parking lamps, instrument panel lamps, license plate lamps and rear lamps.
- C Headlamps.

Headlamp High Beam

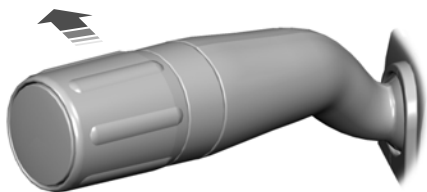

Push the lever away from you to switch the high beam on.

Push the lever forward again or pull the lever toward you to switch the high beams off.

Lighting

Flashing the Headlamp High Beam

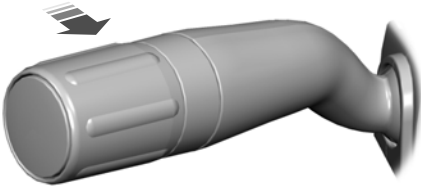

Slightly pull the lever toward you and release it to flash the headlamps.

AUTOLAMPS



WARNING: The system does not relieve you of your responsibility to drive with due care and attention. You may need to override the system if it does not turn the headlamps on in low visibility conditions, for example daytime fog.

Autolamps turn the headlamps on in low light situations or when the wipers operate.



Switch the lighting control to the autolamps position.

The headlamps remain on for a period of time after you switch the ignition off. Use the information display controls to adjust the period of time that the headlamps remain on.

Note: *If you switch the autolamps on, you cannot switch the high beams on until the system turns the low beams on.*

Windshield Wiper Activated Headlamps

When you switch the autolamps on, the headlamps turn on within 10 seconds of switching the wipers on. They turn off approximately 60 seconds after you switch the windshield wipers off.

The headlamps do not turn on with the wipers:

- During a single wipe.
- When using the windshield washers.
- If the wipers are in intermittent mode.

Note: *If you switch the autolamps and the autowipers on, the headlamps turn on when the windshield wipers continuously operate.*

INSTRUMENT LIGHTING DIMMER

The instrument lighting dimmer buttons are on the lighting control.



Repeatedly press one of the buttons to adjust the brightness.



DAYTIME RUNNING LAMPS - VEHICLES WITH: CONFIGURABLE DAYTIME RUNNING LAMPS



WARNING: The daytime running lamps system does not activate the rear lamps and may not provide adequate lighting during low visibility driving conditions. Make sure you switch the headlamps on, as appropriate, during all low visibility conditions. Failure to do so may result in a crash.

Lighting

Switch the daytime running lamps on or off using the information display. See

General Information (page 112).

The daytime running lamps turn on when:

1. The lamps are on in the information display.
2. You switch the ignition on.
3. The transmission is not in park (P) for vehicles with automatic transmissions or you release the parking brake for vehicles with manual transmissions.
4. The lighting control is in the autolamps position.
5. The headlamps are off.

The other lighting control switch positions do not turn on the daytime running lamps.

If the daytime running lamps are off in the information display, the lamps stay off in all switch positions.

DAYTIME RUNNING LAMPS - VEHICLES WITH: DAYTIME RUNNING LAMPS (DRL)



WARNING: The daytime running lamps system does not activate the rear lamps and may not provide adequate lighting during low visibility driving conditions. Make sure you switch the headlamps on, as appropriate, during all low visibility conditions. Failure to do so may result in a crash.

The system turns the lamps on in daylight conditions.

To switch the system on, switch the lighting control to any position except headlamps.

FRONT FOG LAMPS (IF EQUIPPED)

Switching the Front Fog Lamps On or Off

Only switch the front fog lamps on during reduced visibility.

You can switch the front fog lamps on if any of the following occur:

- You set the lighting control to the parking lamps position.
- You set the lighting control to the headlamps position.
- You set the lighting control to the autolamps position and the headlamps are on.

The front fog lamp button is on the lighting control.



Press the button to switch the front fog lamps on or off.

Note: *The brightness of the daytime running lamps may decrease when the front fog lamps are switched on.*

Front Fog Lamp Indicator



It illuminates when you switch the front fog lamps on.

Lighting

DIRECTION INDICATORS

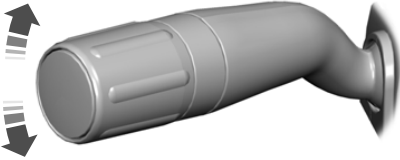

Push the lever up or down to use the direction indicators.

Note: Tap the lever up or down to make the direction indicators flash three times.

SPOT LAMPS (IF EQUIPPED)

The spot lamps are on the forward-facing side of the exterior mirrors. Switch on the spot lamps by pressing the buttons above the lighting control with the parking lamps on.



E176842

When switching on the spot lamps, the area in front of and to the side of your vehicle illuminates.

Adjust the aim of the spot lamps by moving the position of the exterior mirrors.

For manual folding mirrors, adjust the aim of the lamps by folding the exterior mirrors into or away from the windows. For power-folding mirrors, use the switch on the driver-side door.

Note: The spot lamps turn off when you reach a speed of 6 mph (10 km/h).

INTERIOR LAMPS

The lamps turn on under the following conditions:

- You open any door.
- You press a remote control button.
- You press the all lamps on button on the overhead console.

Front Interior Lamp



E262162

The front interior lamp switches are on the overhead console.

Note: The position of each button on the overhead console depends on your vehicle.

All Lamps On



Press to switch all interior lamps on.

Lighting

All Lamps Off



Press to switch all interior lamps off.

Individual Map Lamps



Press to switch the left-hand individual dome lamp on and off.



Press to switch the right-hand individual dome lamp on and off.

Interior Lamp Function



Press to switch the interior lamp function on and off.

When the interior lamp function is off and you open a door, the courtesy and door lamps stay off.

When the interior lamp function is on and you open a door, the courtesy and door lamps turn on.

Note: *The indicator lamp lights amber when the door function is off.*

Rear Interior Lamps

The rear interior lamps may be above the rear seat or above the rear windows.



Press to switch the lamps on or off.



Press to switch the left-hand individual dome lamp on and off.



Press to switch the right-hand individual dome lamp on and off.

AMBIENT LIGHTING (IF EQUIPPED)

Use the touchscreen to select the following:



Select the settings option on the feature bar.

Select **Vehicle**.

Select **Ambient Light**.



Switching Ambient Lighting On

Drag the slider above zero brightness.

Adjusting the Brightness

Drag the slider left or right.

Switching Ambient Lighting Off

Drag the slider left to zero brightness.

CARGO LAMPS (IF EQUIPPED)



Press the button in the lighting control panel or in the rear cargo box to switch on the lamps.

Lighting



E190880

The cargo lamps are in the following areas:

- Either side of the cargo box.
- Next to the tailgate handle.

Note: *The cargo lamps turn off when you reach a speed of 3 mph (5 km/h). They also turn off after 10 minutes, fading gradually to off.*

Automatic High Beam Control (If Equipped)

WHAT IS AUTOMATIC HIGH BEAM CONTROL

The system turns on high beams if it is dark enough and no other traffic is present. If it detects an approaching vehicle's headlamps or tail lamps, or street lighting ahead, the system turns the high beams off. Low beams remain on.

A camera sensor, centrally mounted behind the windshield of your vehicle, continuously monitors conditions to turn the high beams on and off.

SWITCHING AUTOMATIC HIGH BEAM CONTROL ON AND OFF

Switch the system on or off using the information display. See **General Information** (page 112).

Activating the Automatic High Beam Control



Switch the lighting control to the autolamps position to activate. See **Autolamps** (page 90).

Note: Automatic high beams are not available when autolamps are not turned on.

When active, the high beams turn on if:

- The ambient light level is low enough.
- There is no traffic in front of your vehicle.
- The vehicle speed is greater than approximately 32 mph (52 km/h).

When active, the high beams turn off if:

- The ambient light level is high enough that high beams are not required.
- The system detects an approaching vehicle's headlamps or tail lamps.
- The system detects severe rain, snow or fog.

- The camera is blocked.
- The vehicle speed falls below approximately 27 mph (44 km/h).

Note: The deactivation speed is lower on curves.

Note: High beam reactivation may be delayed in certain curvy road situations.

Note: The system may not operate properly if the sensor is blocked. Keep the windshield free from obstruction or damage.

Note: The system may not operate properly in cold or inclement conditions. You can switch on the high beams by overriding the system.

Note: If the system detects a blockage, for example bird droppings, bug splatter, snow or ice, the system goes into low beam mode until you clear the blockage. A message may appear in the information display if the camera is blocked.

Note: Using much larger tires or equipping vehicle accessories such as snowplows can modify your vehicle's ride height and degrade automatic high beam control performance.

AUTOMATIC HIGH BEAM CONTROL INDICATORS



The indicator illuminates to confirm when the system is ready to assist.

OVERRIDING AUTOMATIC HIGH BEAM CONTROL



WARNING: The system does not relieve you of your responsibility to drive with due care and attention. You may need to override the system if it does not turn the high beams on or off.

Automatic High Beam Control (If Equipped)

 **WARNING:** You may need to override the system when approaching other road users.

 **WARNING:** You may need to override the system during inclement weather.

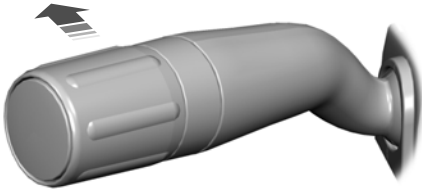

Push the lever away from you to switch between high beam and low beam.

Windows and Mirrors

POWER WINDOWS (IF EQUIPPED)



WARNING: Do not leave children unattended in your vehicle and do not let them play with the power windows. They may seriously injure themselves.



WARNING: When closing the power windows, you should verify they are free of obstructions and make sure that children and pets are not in the proximity of the window openings.

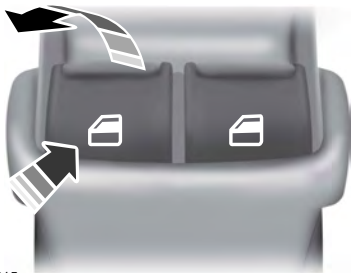

E176215

Press the control to open the window.

Lift the control to close the window.

Note: You may hear a pulsing noise when just one of the windows is open. Lower the opposite window slightly to reduce this noise.

One-Touch Up or Down (If Equipped)

Press or lift the switch fully and release it. Press or lift it again to stop the window.

Note: The window may disable for up to five minutes if you cycle it up and down repeatedly. This helps prevent damage to the motor. Normal operation will resume once the motor cools.

Restoring the One-Touch Up Function

You may lose the one-touch function if the vehicle battery is low.

To reset the function after the battery recharges:

1. Pull the switch all the way up.
2. Hold the switch until the glass stops and continue to hold for two seconds.
3. Press the switch down and operate the window to the full down position. One-touch up will now be functional.

Note: Perform one-touch up re-calibration with the door closed. Calibrating with the door open will cause the window to continuously bounce back.

Bounce-Back (If Equipped)

The window will automatically stop and reverse some distance if it detects an obstacle while closing.

Overriding the Bounce-Back Feature



WARNING: When you override the bounce-back feature the window will not reverse if it detects an obstacle. Take care when closing the windows to avoid personal injury or damage to your vehicle.

Pull up the window switch and hold within two seconds of the window reaching the bounce-back position. The window will travel up with no bounce-back protection. The window will stop if you release the switch before the window closes fully.

Windows and Mirrors

Window Lock (If Equipped)



E176216

Press the control to lock or unlock the rear window controls.

Accessory Delay (If Equipped)

The window switches remain operational for several minutes when you switch the ignition off or until you open either front door.

GLOBAL OPENING (IF EQUIPPED)

You can use the remote control to open the windows with the ignition off.

Note: To operate this feature, accessory delay must not be active.

Opening the Windows

You can only open the windows for a short time after you unlock your vehicle with the remote control. After you unlock your vehicle, press and hold the remote control unlock button to open the windows. Release the button once movement starts. Press the lock or unlock button to stop movement.

EXTERIOR MIRRORS

Power Exterior Mirrors (If Equipped)

 **WARNING:** Do not adjust the mirrors when your vehicle is moving. This could result in the loss of control of your vehicle, serious personal injury or death.



E144073

- A Left-hand mirror.
- B Adjustment control.
- C Right-hand mirror.

To adjust your mirrors, switch your vehicle on, with the ignition in accessory mode or the engine running, and then:

1. Select the mirror you want to adjust. The control lights.
2. Use the adjustment control to adjust the position of the mirror.
3. Press the mirror control again. The control light turns off.

Fold-Away Exterior Mirrors (If Equipped)

Push the mirror toward the door window glass. Make sure that you fully engage the mirror in its support when returning it to its original position.

Windows and Mirrors

Telescoping Mirrors (If Equipped)

This feature lets you extend the mirror about 3 in (75 mm). It is useful when towing a trailer. You can manually pull out or push in the mirrors to the desired position.

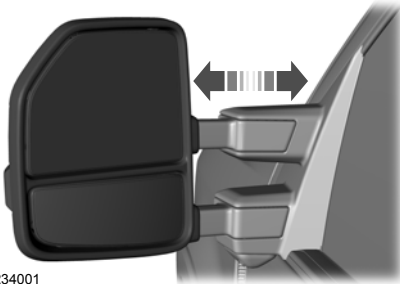

E234001

PowerScope™ Power Telescoping Mirrors (If Equipped)

Note: Do not stop the mirrors midway through their movement. Wait until the mirrors stop moving and press the control again.

Note: The left-hand and right-hand mirrors move at different rates. For example, one mirror may stop when the other one continues to move. This is normal.

Auto-Folding Mirrors

The exterior mirrors automatically fold in toward the glass after you place the transmission into park (P), switch off the vehicle, open and close the driver-side door and lock the vehicle. The exterior mirrors automatically unfold and return to their driving position after you unlock the vehicle. You can switch this feature on and off through the information display. See **General Information** (page 112).

Power-Folding Mirrors

You can fold the mirrors on demand by pressing the power-folding mirror control on the door. Press the control again to unfold the mirrors.



E234002

Note: If you use the power-folding control to fold the mirrors on demand and the auto fold feature is switched on through the information display, you must use the power-folding control again to unfold them.

Power Telescoping Mirrors

This feature lets you position both mirrors at the same time.

Windows and Mirrors

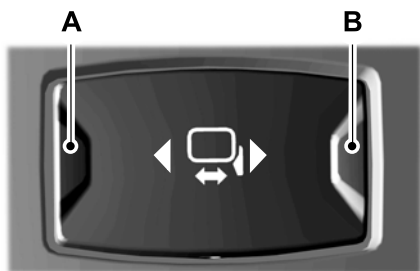

- A Extend.
- B Retract.

To adjust your mirrors, press the adjustment control to position the mirrors.

Note: *Moving the mirrors 10 or more times within one minute, or repeated folding, unfolding and telescoping of the mirrors when holding the control down during full travel, may disable the system to protect the motors from overheating. Wait approximately three minutes with the vehicle running, and up to 10 minutes with the vehicle off, for the system to reset and for function to return to normal.*

Loose Mirror

If your power-folding mirrors are manually folded, they may not work properly even after you re-position them. You need to reset them if:

- The mirrors vibrate when you drive.
- The mirrors feel loose.
- The mirrors do not stay in the folded or unfolded position.
- One of the mirrors is not in its normal driving position.

To reset the power-fold feature, use the power-folding mirror control to fold and unfold the mirrors. You may hear a loud noise as you reset the power-folding mirrors. This sound is normal. Repeat this process as needed each time the mirrors are manually folded.

Heated Exterior Mirrors (If Equipped)

See **Heated Exterior Mirrors** (page 147).

Memory Mirrors (If Equipped)

You can save and recall the mirror positions through the memory function. See **Memory Function** (page 156).

Direction Indicator Mirrors (If Equipped)

When the vehicle is running, the forward-facing portion of the appropriate mirror housing blinks when you switch on the direction indicator.

Puddle Lamps (If Equipped)

The lamps on the bottom part of the mirror housing light when you use your transmitter to unlock the doors or when you open a door.

Clearance Lamps (If Equipped)

The lower, outer part of the mirror housings light when you switch the headlamps or parking lamps on.

Spot Lamps (If Equipped)

The area lights are on the forward-facing portion of the mirror housing. You can switch them on and off by using the controls located on the instrument panel. See **Lighting** (page 89).

Trailer Towing Camera System (If Equipped)

See **360 Degree Camera** (page 237).

Windows and Mirrors

Blind Spot Information System (If Equipped)

See **Blind Spot Information System** (page 253).

INTERIOR MIRROR



WARNING: Do not adjust the mirrors when your vehicle is moving. This could result in the loss of control of your vehicle, serious personal injury or death.

Note: Do not clean the mirror housing or glass with harsh abrasives, fuel or other petroleum-based cleaning products.

You can adjust the interior mirror to your preference. Some mirrors also have a second pivot point. This lets you move the mirror hear up or down and from side to side.

Manual Dimming Mirror

Pull the tab below the mirror toward you to reduce the effect of bright light from behind.

Auto-Dimming Mirror (If Equipped)

Note: Do not block the sensors on the front and back of the mirror. A rear center passenger or raised rear center head restraint may also block light from reaching the sensor.

The mirror dims to reduce glare when bright lights are detected from behind your vehicle. It automatically returns to normal reflection when you shift the transmission into reverse (R) to make sure you have a clear view when backing up.

SLIDING WINDOWS (IF EQUIPPED)

Power Sliding Back Window (If Equipped)



WARNING: When operating the power sliding back window, you must make sure all rear seat occupants and cargo are not in the proximity of the back window.



WARNING: Do not leave children unattended in your vehicle and do not let them play with the power sliding back window. They may seriously injure themselves.

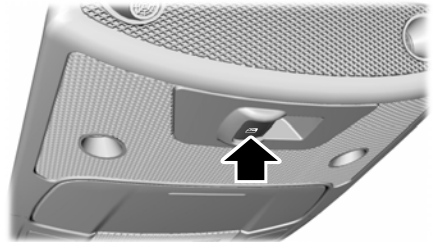

E176217

The control is on the overhead console.

Press and hold the control to open the window. Pull and hold the control to close the window.

Windows and Mirrors

SUN VISORS

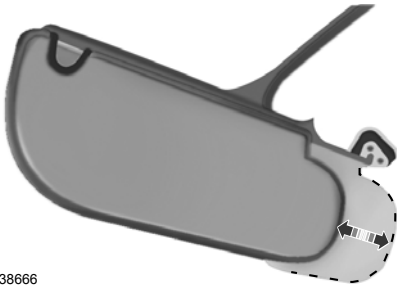

E138666

Rotate the sun visor toward the side window and extend it rearward for extra shade.

Illuminated Vanity Mirror (If Equipped)

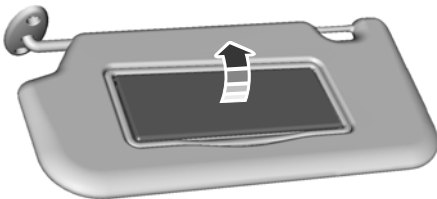

E162197

Lift the cover to switch the lamp on.

MOONROOF (IF EQUIPPED)



WARNING: Do not leave children unattended in your vehicle and do not let them play with the moonroof. Failure to follow this instruction could result in personal injury.



WARNING: When closing the moonroof, verify that it is free of obstruction and make sure that children and pets are not in the proximity of the roof opening.

The moonroof controls are on the overhead console and have a one-touch open and close feature. To stop its movement during one-touch operation, press the control a second time.

Opening and Closing the Moonroof

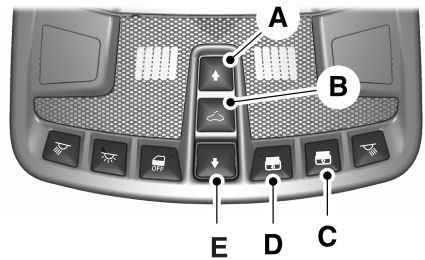

E191272

- A Moonroof open.
- B Moonroof vent.
- C Sunshade open.
- D Sunshade close.
- E Moonroof close.

Moonroof Open

Press and release the button to open the moonroof.

Note: *The moonroof stops short of the fully opened position to reduce wind noise or rumbling that may happen with the moonroof fully open. Press and release the button again to open the moonroof fully.*

Windows and Mirrors

Moonroof Vent

Press and release the button to vent the moonroof.

Sunshade Open

Press and release the button to open the sunshade. The sunshade opens with the moonroof. You can also open the sunshade with the moonroof closed.

Note: *The sunshade stops short of its fully opened position for the comfort of rear passengers. To open the sunshade fully, press the button again.*

Sunshade Close

Press and release the button to close the sunshade.

Moonroof Close

Press and release the button to close the moonroof from either the open or vent positions.

Note: *The sunshade stops short of the fully closed position. Press and release the button a second time to fully close the shade. The sunshade completely closes only when the moonroof is closed. The moonroof closes with a single press of the close button.*

Bounce-Back

The moonroof reverses some distance if it detects an obstacle when closing.

To override this feature, press and hold the moonroof close button within two seconds after the roof comes to a stop following a bounce-back reversal.

Instrument Cluster

GAUGES

Type 1 and 2

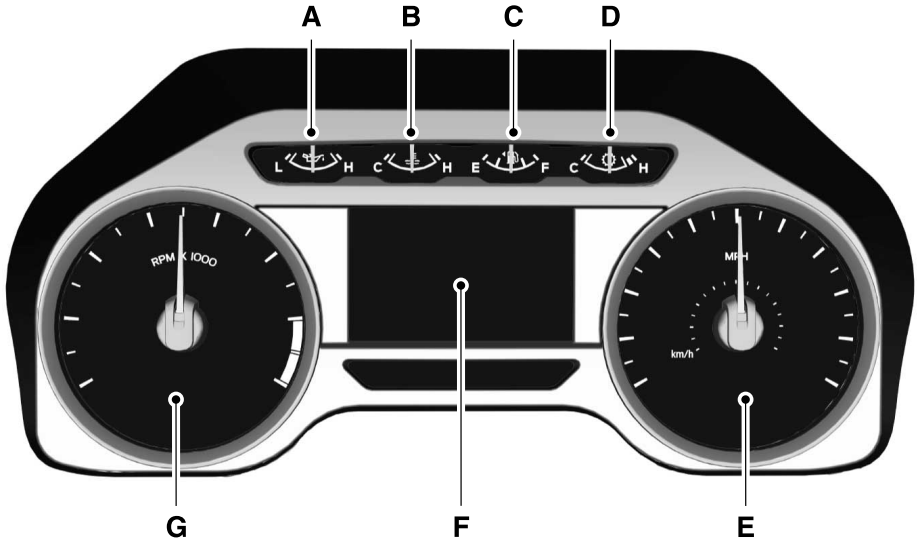

E219638

- A Engine oil pressure gauge.
- B Engine coolant temperature gauge.
- C Fuel gauge.
- D Transmission fluid temperature gauge.
- E Speedometer.
- F Information display. See **General Information** (page 112).
- G Tachometer.

Instrument Cluster

Type 3

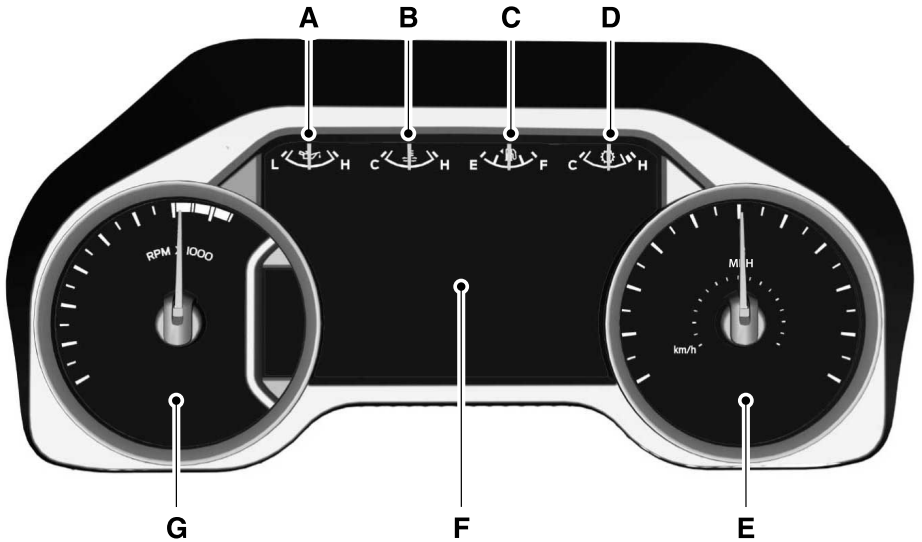

E219651

- A Engine oil pressure gauge.
- B Engine coolant temperature gauge.
- C Fuel gauge.
- D Configurable. Transmission fluid temperature, Turbo boost or DEF gauge (diesel engines only).
- E Speedometer.
- F Information display. See **General Information** (page 112).
- G Tachometer.

Instrument Cluster

Engine Oil Pressure Gauge

Indicates engine oil pressure. The needle should stay in the normal operating range (between L and H). If the needle falls below the normal range, stop your vehicle, turn off the engine and check the engine oil level. Add oil if needed. If the oil level is correct, have your vehicle checked by an authorized dealer.

Engine Coolant Temperature Gauge



WARNING: Do not remove the coolant reservoir cap when the engine is on or the cooling system is hot. Wait 10 minutes for the cooling system to cool down. Cover the coolant reservoir cap with a thick cloth to prevent the possibility of scalding and slowly remove the cap. Failure to follow this instruction could result in personal injury.

Indicates engine coolant temperature. At normal operating temperature, the level indicator will be in the normal range. If the engine coolant temperature exceeds the normal range, stop your vehicle as soon as safely possible, switch off the engine and let the engine cool.

Fuel Gauge

Note: *The fuel gauge may vary slightly when your vehicle is moving or on a slope.*

The fuel gauge indicates about how much fuel is in the fuel tank.

The arrow adjacent to the fuel pump symbol indicates on which side of your vehicle the fuel filler door is located.

Low Fuel Reminder

A low fuel level reminder displays and sounds when the distance to empty reaches 75 mi (120 km) to empty for MyKey, and at 50 mi (80 km), 25 mi (40 km), 10 mi (20 km) and 0 mi (0 km) for all vehicle keys.

Note: *The low fuel reminder can appear at different fuel gauge positions depending on fuel economy conditions. This variation is normal.*

Transmission Fluid Temperature Gauge

Indicates transmission fluid temperature. At normal operating temperature, the level indicator will be in the normal range. If the transmission fluid temperature exceeds the normal range, stop the vehicle as soon as safely possible and verify the airflow is not restricted such as snow or debris blocking airflow through the grill. Also, higher than normal operating temperature can be caused by special operation conditions (i.e. snowplowing, towing or off-road use). Operating the transmission for extended periods with the gauge in the higher than normal area may cause internal transmission damage. You need to alter the severity of your driving conditions to lower the transmission temperature into the normal range. If the gauge continues to show high temperatures, see an authorized dealer.

Turbo Boost Gauge (If Equipped)

Indicates the amount of manifold air pressure in the engine.

DEF Gauge (If Equipped)

Indicates the current DEF level.

Instrument Cluster

WARNING LAMPS AND INDICATORS

The following warning lamps and indicators alert you to a vehicle condition that may become serious. Some lamps illuminate when you start your vehicle to make sure they work. If any lamps remain on after starting your vehicle, refer to the respective system warning lamp for further information.

Note: *Some warning indicators appear in the information display and operate the same as a warning lamp but do not illuminate when you start your vehicle.*

Adaptive Cruise Control (If Equipped)



The speed control system indicator light changes color to indicate what mode the system is in. See **Using Adaptive Cruise Control** (page 242).

On (white light): Illuminates when the adaptive cruise control system is turned on. Turns off when the speed control system is turned off.

Engaged (green light): Illuminates when the adaptive cruise control system is engaged. Turns off when the speed control system is disengaged.

Adaptive Steering (If Equipped)



The adaptive steering system indicator illuminates if the system detects a fault during the continuous diagnostic checks.

Adaptive Steering Initialization (yellow, flashing): The adaptive steering system has detected a difference between steering wheel angle and the desired road wheel angle. The steering wheel adjusts itself to correct this difference. This adjustment is part of normal system operation.

Adaptive Steering Off (yellow, solid): The adaptive steering system is off. It is possible that the steering wheel may not be straight when the vehicle is driving straight ahead. If this message persists, see an authorized dealer.

Adaptive Steering Loss (red, solid): The adaptive steering system integrity cannot be verified. Do not drive the vehicle and contact an authorized dealer immediately. See **Steering** (page 261).

Anti-Lock Braking System



It illuminates momentarily when you switch on the ignition to confirm that the lamp is functional. If it does not illuminate when you switch on the ignition or begins to flash at anytime, have the system checked as soon as possible.

If it illuminates when you are driving, this indicates a malfunction. You will continue to have the normal braking system (without ABS) unless the brake system warning lamp is also illuminated. Have the system checked as soon as possible.

Automatic High Beam (If Equipped)



Illuminates when this feature is on. See **What Is Automatic High Beam Control** (page 95).

Instrument Cluster

Battery



If it illuminates while driving, it indicates a malfunction. Switch off all unnecessary electrical equipment and have the system checked by an authorized dealer immediately.

Brake System Warning Lamp



WARNING: Driving your vehicle with the warning lamp on is dangerous. A significant decrease in braking performance may occur. It may take you longer to stop your vehicle. Have your vehicle checked as soon as possible. Driving extended distances with the parking brake engaged can cause brake failure and the risk of personal injury.

Note: Indicators vary depending on region.

This lamp is a dual function lamp and will illuminate when:

- You apply the parking brake with the ignition on.
- Your vehicle has a brake fault or low brake fluid level, regardless of parking brake position.

BRAKE

If the lamp illuminates while you are moving, you may have the parking brake applied. Be sure that the parking brake is off.



Have your vehicle checked as soon as possible if the lamp continues to illuminate.

Blind Spot Monitor (If Equipped)



It illuminates when you switch this feature off or in conjunction with a message. See **Blind Spot Information System** (page 253).

Check Fuel Cap (If Equipped)



Illuminates when the fuel cap may not be properly installed. Continued driving with this light on may cause the Service engine soon warning indicator to come on.

Check 4X4 (If Equipped)



Illuminates with the message **Check 4x4** when a four-wheel drive fault is present. See **Using Four-Wheel Drive** (page 212).

Cruise Control (If Equipped)



Illuminates when you switch this feature on. See **What Is Cruise Control** (page 241).

Diesel Engine Brake (If Equipped)



Illuminates when you switch the manual engine brake on. See **General Information** (page 222).



Illuminates when you switch the automatic engine brake on. See **General Information** (page 222).

Diesel Exhaust Fluid (If Equipped)



With the key in the on position, illuminates when the DEF is contaminated, low or someone has tampered with the DEF system. See **Selective Catalytic Reductant System** (page 197).

Instrument Cluster

Direction Indicator



Illuminates when the left or right turn signal or the hazard warning flasher is turned on. If the indicators stay on or flash faster, check for a burned out bulb.

Door Ajar



Displays when the ignition is on and any door is not completely closed.

Electronic Locking Differential (if Equipped)



Illuminates when using the electronic locking differential.

Engine Coolant Temperature



Illuminates when the engine coolant temperature is high. Stop the vehicle as soon as possible, switch off the engine and let cool.

Engine Oil



If it illuminates with the engine running or when you are driving, this indicates a malfunction. Stop your vehicle as soon as it is safe to do so and switch the engine off. Check the engine oil level.

See **Engine Oil Check** (page 346).

Note: Do not resume your journey if it illuminates despite the level being correct. Have the system checked by your authorized dealer immediately.

Fasten Seatbelt



It illuminates and a chime sounds to remind you to fasten your seatbelt.

Front Airbag



If it fails to illuminate when you start your vehicle, continues to flash or remains on, it indicates a malfunction. Have the system checked by your authorized dealer.

Front Fog Lamps (If Equipped)



It illuminates when you switch the front fog lamps on.

High Beam



Illuminates when you switch the high beam headlamps on. It will flash when you use the headlamp flasher.

Hill Descent (If Equipped)



Illuminates when hill descent is switched on.

Low Fuel Level



Illuminates when the fuel level is low or the fuel tank is nearly empty. Refuel as soon as possible.

Low Tire Pressure Warning



It illuminates if the tire pressure in one or more tires is below the correct tire pressure.

It also illuminates momentarily when you switch the ignition on to confirm the lamp is functional. If it does not illuminate when you switch the ignition on, or begins to flash at any time, have the system checked by your authorized dealer.

Instrument Cluster

Powertrain Malfunction/Reduced Power/Electronic Throttle Control



Illuminates when a powertrain or a 4WD fault has been detected. Contact an authorized dealer.

Service Engine Soon



If it illuminates when the engine is running this indicates a malfunction. The On Board Diagnostics system has detected a malfunction of the vehicle emission control system.

If it flashes, engine misfire may be occurring. Increased exhaust gas temperatures could damage the catalytic converter or other vehicle components. Drive in a moderate fashion (avoid heavy acceleration and deceleration) and have your vehicle immediately serviced.

It illuminates when you switch the ignition on prior to engine start to check the bulb and to indicate whether your vehicle is ready for Inspection and Maintenance (I/M) testing.

Normally, it illuminates until the engine is cranked and automatically turns off if no malfunctions are present. However, if after 15 seconds it flashes eight times, this indicates that your vehicle is not ready for Inspection and Maintenance (I/M) testing. See **Emission Law** (page 194).

Stability Control



Illuminates when the system is active. If it remains illuminated or does not illuminate when you switch the ignition on, this indicates a malfunction. During a malfunction the system will switch off. Have the system checked by your authorized dealer immediately. See **Using Stability Control** (page 228).

Stability Control Off



Illuminates when you switch the system off. It will go out when you switch the system back on or when you switch the ignition off.

See **Using Stability Control** (page 228).

Tailgate Ajar



Illuminates when the tailgate is not completely closed or when opened and then closed when the transmission is in any gear other than park (P).

Transmission Tow/Haul (If Equipped)



Illuminates when the tow/haul feature has been activated. If the light flashes steadily, have the system serviced immediately, damage to the transmission could occur.

Wait To Start (If Equipped)



Illuminates when you switch the ignition on as part of the pre-start system. Wait until the wait to start indicator turns off before attempting to start vehicle. See **Starting a Diesel Engine** (page 177).

Water In Fuel (If Equipped)



WARNING: Do not drain the water-in-fuel separator while the engine is running. Failure to follow this warning may result in fire, serious injury, death or property damage.

Instrument Cluster



During refueling, it is possible for you to pump water-contaminated diesel fuel into your fuel tank. Your vehicle's fuel system is equipped with a fuel filter and water separator to remove water from the fuel. The water in fuel indicator lights when the fuel and water separator has a significant quantity of water in it and requires immediate draining.

If the water in fuel indicator illuminates when the engine is running, stop your vehicle as soon as safely possible, shut off the engine, then drain the fuel and water separator. See **Fuel Quality** (page 185). Allowing water to stay in the fuel system, after the water in fuel indicator illuminates, could result in extensive damage or failure of the fuel injection system.

Note: *Do not drain the fuel and water separator while the engine is running. Air will enter into the fuel system causing the engine not to operate properly.*

Four-Wheel Drive Indicators (if Equipped)

4X2



Illuminates momentarily when two-wheel drive high is selected.

4X4 HIGH



Illuminates when four-wheel drive high is engaged.

4X4 LOW



Illuminates when four-wheel drive low is engaged.

AUDIBLE WARNINGS AND INDICATORS

Key in Ignition Warning Chime

Sounds when you open the driver's door and you have left the key in the ignition.

Keyless Warning Alert (If Equipped)

Sounds the horn twice when you exit your vehicle with the intelligent access key, after the last door is closed and your keyless vehicle is in RUN, indicating your vehicle is still on.

Headlamps On Warning Chime

Sounds when you remove the key from the ignition and open the driver's door and you have left the headlamps or parking lamps on.

Parking Brake On Warning Chime

Sounds when you have left the parking brake on and drive your vehicle. If the warning chime remains on after you have released the parking brake, have the system checked by an authorized dealer immediately.

Information Displays

GENERAL INFORMATION



WARNING: Driving while distracted can result in loss of vehicle control, crash and injury. We strongly recommend that you use extreme caution when using any device that may take your focus off the road. Your primary responsibility is the safe operation of your vehicle. We recommend against the use of any hand-held device while driving and encourage the use of voice-operated systems when possible. Make sure you are aware of all applicable local laws that may affect the use of electronic devices while driving.

Various systems on your vehicle can be controlled using the information display controls on the steering wheel. Corresponding information displays on the instrument cluster information display.

Note: Some options could appear slightly different or not at all if the items are optional.

Note: Trailer options are not available if your vehicle speed is greater than 3 mph (5 km/h).

Note: Some MyKey menu options only appear if MyKey is enabled and at least one MyKey is programmed.

Information Display Controls



E184451

- Press the up and down arrow buttons to scroll through and highlight the options within a menu.
- Press the right arrow button to enter a sub-menu.
- Press the left arrow button to exit a menu.
- Press the **OK** button to choose and confirm a setting or messages.



This icon shows the features on or off status. A check in the box indicates the feature is on, and unchecked indicates the feature is off.

2 Inch Display Menu (If Equipped)

Main Menu
Trip 1
Trip 2
Fuel Economy
Driver Assist
Settings

Information Displays

Trip 1
Digital Speed
Trip Odometer
Trip Timer
DTE
Average Fuel
Outside Temp

- Digital Speed - Shows a digital display of your vehicle speed.
- Trip Odometer - Registers the mileage of individual trips.
- Trip Timer - Registers the time of individual trips.
- DTE - Indicates the approximate distance your vehicle can travel on the fuel remaining in the tank. Changes in driving pattern can cause the value to not only decrease but also increase or stay constant for periods of time.
- Average Fuel - Shows the average fuel economy for a given trip.
- Outside Air - Shows the outside air temperature.

Note: Press and hold the **OK** button to reset values.

Note: Trip 2 information is the same as Trip 1.

Fuel Economy
Distance to E
Instant Fuel Economy
Average Fuel Economy

- Distance to E - Indicates the approximate distance your vehicle can travel on the fuel remaining in the tank. Changes in driving pattern can cause the value to not only decrease but also increase or stay constant for periods of time.
- Instant Fuel Economy - Shows your instantaneous fuel usage.
- Average Fuel Economy - Shows the average fuel usage based on time.

Note: Press and hold the **OK** button to reset values.

Information Displays

Driver Assist		
Engine Hours	Select Your Setting	
Dual Fuel Tank	Select Your Setting	
Hill Strt Asst.		
Maint. Monitor	Air Fil. Mon. Shows air filter status	Hold to reset
	Water in Fuel	
	Oil Level Low	
	Oil Life XXX% Hold to Reset	Hold to reset
	DEF Range	
	Exhaust Filter	
	Tire Pressure	
Oil Temp	Oil Temp	
Trans. Temp.		
Rear Park Aid		
Tr Brake Type	Select Your Setting	
Tr Brake Effort		
Trailer Sway		

Settings		
Vehicle	A. Engine Off	
	Auto Regen	
	Lighting	Select Your Setting
	Locks	Select Your Setting
	Alarm	Select Your Setting
		Ask on Exit

Information Displays

Settings		
	Remote Start	Select Your Setting
	Windows	Select Your Setting
	Wiper Controls	Select Your Setting
MyKey	MyKey Status	Shows information related to the configured MyKey(s).
	Create MyKey	Hold OK to Create MyKey
	911 Assist	Select Your Setting
	Do Not Disturb	
	AdvanceTrac	
	Max Speed	
	Speed Minder	
	Vol. Limiter	
Clear MyKeys	Hold OK to Clear All MyKeys	
Display Setup	Display Settings	Select Your Setting
	Temperature	
	Tire Pressure	
	Language	

4 Inch Display Menu

Main Menu
Display Mode
Trip/Fuel
Towing
Off Road
Settings

Information Displays

Display Mode
Distance to Empty
Dual Fuel Tanks
DEF Status
Digital Speedometer
Engine Information
Maintenance Monitor
Transmission Temp.
Lane Keeping System

Trip/Fuel	
Trip 1	
Trip 2	
ECO Coach	
Fuel Economy	
Fuel History	
Compass	Select Your Setting
Average Speed	

Trip 1 or 2

- Shows the time, mileage and average fuel economy of an individual journey. Also shows DTE.

ECO Coach

- ECO Coach - Provides suggestions on how to drive more economically.

Fuel

- Fuel Economy - Shows your instantaneous fuel usage as a bar graph, average mpg and DTE.
- Fuel History - Shows your fuel usage based on time. The graph is updated each minute with the fuel economy that you achieved during 30 minutes of driving. Also shows DTE.

Note: Press and hold the **OK** button to reset values.

Information Displays

Towing		
Trailer Status	Provides trailer status information for the active trailer: Trailer light status, Blind Spot, Reverse Guidance, Pro Trailer Backup, trailer name, accumulated trailer miles, trailer brake gain and output.	
Trailer Tire Pressure	Displays the trailer tire pressure and options to customize the display.	
Trailer Options	Trailer Sway Control	
	Select Trailer	Select Your Setting
	Change Trailer Settings	Follow onscreen directions to confirm or modify your settings.
Connection Checklist	Conventional	Follow onscreen directions to confirm or modify your settings.
	Fifth Wheel	
	Gooseneck	

Note: Trailer options are only available at speeds less than 3.1 mph (5 km/h)

Note: Once you select a trailer, it remains active until you set it as no longer active. An active trailer still accumulates miles even after you physically disconnect it from your vehicle.

Off Road
Off Road Status

Displays pitch, steering angle and roll.

Settings	
Auto Regen	
Blind Spot	
Cross Traffic Alert	
DTE Calculation	Select Your Setting

Information Displays

Settings			
Rear Park Aid			
Pre-Collision	Select Your Setting		
Cruise Control	Select Your Setting		
Lane Keeping System	Select Your Setting		
Advanced Settings	Vehicle	30 min. Max Idle	
		Easy Entry/Exit	
		Lighting	Select Your Setting
		Locks	
		Mirrors	
		Neutral Tow	
		Alarm	
		Remote Start	
		Windows	
		Wiper Controls	
	MyKey	MyKey Status	
		Create MyKey	Follow onscreen directions to confirm or modify your settings.
		911 Assist	Select Your Setting
		Do Not Disturb	
		AdvanceTrac	
		Max Speed	
		Speed Minder	
		Volume Limiter	
		Clear MyKeys	Follow onscreen directions to confirm or modify your settings.

Information Displays

Settings			
	Display Setup	Distance Unit	Select Your Setting
		Temperature	
		Tire Pressure	
		Language	

8 Inch Display Menu (If Equipped)

Main Menu
MyView
Trip/Fuel
Truck Info
Towing
Off Road
Settings

MyView	
Tire Pressure	
Off Road Status	
Configure MyView	Select Your Setting

Trip/Fuel
Trip 1
Trip 2
ECO Coach
Fuel Economy
Fuel History

Information Displays

Trip/Fuel
Maintenance Monitor
Navigation/Compass

Trip 1 or 2

- Trip Timer - Registers the time of individual journeys.
- DTE - Indicates the approximate distance your vehicle can travel on the fuel remaining in the tank. Changes in driving pattern can cause the value to not only decrease but also increase or stay constant for periods of time.
- Odo - Registers the mileage of individual journeys.
- Avg mpg - Shows the average fuel economy for a given trip.

ECO Coach

- ECO Coach - Provides suggestions on how to drive more economically.

Fuel

- Fuel Economy - Shows your instantaneous fuel usage as a bar graph and average mpg.
- Fuel History - Shows your fuel usage based on time. The graph is updated each minute with the fuel economy that you achieved during 30 minutes of driving.

Maintenance Monitor

- Maintenance Monitor - Shows the maintenance status of various vehicle systems.

Navigation/Compass

- Navigation - Shows navigation turn by turn (Compass displayed when a route in Navigation is not set).

Note: Press and hold the **OK** button to reset values.

Truck Info	
Gauge View	Shows various powertrain gauges like trans temp and DEF fluid.
Tire Pressure	
Digital Speedometer	
Dual Fuel Tanks	
Engine Information	
Maintenance Monitor	Shows the maintenance status of various vehicle systems.
Transmission Temperature	

Information Displays

Note: Once you select a trailer, it remains active until you set it as no longer active. An active trailer still accumulates miles even after you physically disconnect it from your vehicle.

Towing		
Towing Status	% Grade, steering angle, gain and output display	
Towing Information	Trailer Name, Accumulated Miles, Trailer Reverse Guidance Status, Trailer BLIS Status and Trailer Disconnected	
Trailer Light Check	Provides status of the brake, park and direction indicator light for the active trailer.	
Trailer Tire Pressure	Follow onscreen directions to confirm or modify your settings.	
Trailer Setup	Trailer Sway Control	
	Select trailer	Select Your Setting
	Change Trailer Settings	Follow onscreen directions to confirm or modify your settings.
Connection Checklist	Conventional	Follow onscreen directions to confirm or modify your settings.
	Fifth Wheel	
	Gooseneck	

Off Road
Off Road Status

Displays pitch, steering angle, roll, Elocker and 4X4.

Settings
Auto Regen
Blind Spot
Cross Traffic Alert
Driver Alert
Rear Park Aid

Information Displays

Settings			
Pre-Collision	Select Your Setting		
Cruise Control			
Gauge Selection			
Lane Keeping System			
Advanced Settings	Vehicle	Auto Engine Off	
		Easy Entry/Exit	
		Lighting	Select Your Setting
		Locks	
		Neutral Tow	
		Alarm	
		Power Running Boards	
		Remote Start	
		Windows	
		Wiper Controls	
	MyKey	MyKey Status	
		Create MyKey	Follow onscreen directions to confirm or modify your settings.
		911 Assist	Select Your Setting
		Do Not Disturb	
		AdvanceTrac	
		Max Speed	
		Speed Minder	
		Volume Limiter	

Information Displays

Settings			
		Clear MyKeys	Follow onscreen directions to confirm or modify your settings.
Display Setup	Distance Unit	Select Your Setting	
	Temperature		
	Tire Pressure		
	Language		

INFORMATION MESSAGES

Note: Depending on your vehicle options and instrument cluster type, not all of the messages display or are available. The information display could abbreviate or shorten certain messages.



E184451

Press the **OK** button on the steering wheel to remove the warning. The information display removes other messages after a short time.

You need to confirm certain messages before you can access the menus.

Active Park

Message	Action
Active Park Fault	The system has detected a fault that requires service. Have the system checked by an authorized dealer.

Information Displays

Adaptive Cruise Control

Message	Action
Adaptive Cruise Malfunction	A radar malfunction is preventing the adaptive cruise control from engaging. See Using Adaptive Cruise Control (page 242).
Adaptive Cruise Not Available	A condition exists such that the adaptive cruise cannot function properly. See Using Adaptive Cruise Control (page 242).
Adaptive Cruise Not Available Sensor Blocked See Manual	You have a blocked sensor due to bad weather, ice, mud or water in front of the radar sensor. You can typically clean the sensor to resolve. See Using Adaptive Cruise Control (page 242).
Normal Cruise Active Adaptive Braking Off	You select normal cruise control. The system does not brake or react to traffic.
Front Sensor Not Aligned	A radar malfunction is preventing the adaptive cruise control from engaging.
Adaptive Cruise - Driver Resume Control	The adaptive cruise has reinstated controls to the driver.
Adaptive Cruise Speed Too Low to Activate	Your vehicle speed is too slow to activate the adaptive cruise.
Adaptive Cruise Shift Down	The adaptive cruise is automatically adjusting the gap distance and you need to shift the transmission into a lower gear.

Information Displays

Adaptive Steering

Message	Action
Adaptive Steering Initialization	The adaptive steering system detects a difference between steering wheel angle and the desired road wheel angle. The steering wheel adjusts itself to correct this difference. This adjustment is part of normal system operation.
Adaptive Steering Fault Service Required	The adaptive steering system is off. It is possible that the steering wheel could not be straight when the vehicle is driving straight ahead. If this message persists, see an authorized dealer.
Adaptive Steering Loss Do Not Drive	The adaptive steering system integrity cannot be verified. Do not drive the vehicle and contact an authorized dealer immediately.

AdvanceTrac and Traction Control

Message	Action
Service AdvanceTrac	The system detects a condition that requires service. Contact an authorized dealer as soon as possible.
AdvanceTrac Off	The status of the AdvanceTrac system after you switched it off.
AdvanceTrac On	The status of the AdvanceTrac system after you switched it on.
AdvanceTrac SPORT MODE	The status of the AdvanceTrac sport mode after you switched it on.
Traction Control Off	The status of the traction control system after you switched it off. See Using Traction Control (page 226).
Traction Control On	The status of the traction control system after you switched it on. See Using Traction Control (page 226).

Information Displays

Airbag

Message	Action
Occupant Sensor BLOCKED Remove Objects Near Passenger Seat	Displays when the system detects a malfunction due to a blocked sensor.

Alarm and Security

Message	Action
Vehicle Alarm To Stop Alarm, Start Vehicle.	Alarm triggered due to unauthorized entry. See Anti-Theft Alarm (page 78).

Automatic Engine Shutdown

Message	Action
Engine Shuts Off In {seconds to shut off:#0} Seconds	The engine is getting ready to shut off.
Engine Shut Off For Fuel Economy	The engine has shut off to help increase fuel economy.
Engine Shuts Off in {seconds to shut off:#0} Seconds Press Ok to Override	The engine is getting ready to shut off. Follow the prompt from the message to override the shut down.

Information Displays

Battery and Charging System

Message	Action
Check Charging System	The charging system needs servicing. If the warning stays on or continues to come on, contact an authorized dealer as soon as possible.
Low Battery Features Temporarily Turned Off	The battery management system detects an extended low-voltage condition. Your vehicle disables various features to help preserve the battery. Turn off as many of the electrical loads as soon as possible to improve system voltage. If the system voltage has recovered, the disabled features operate again as normal.
Turn Power Off To Save Battery	The battery management system determines that the battery is at a low state of charge. Turn your ignition off as soon as possible to protect the battery. This message clears once you restart your vehicle and the battery state of charge has recovered. Turning off unnecessary electrical loads allows faster battery state-of-charge recovery.

Blind Spot Information and Cross Traffic Alert System

Message	Action
Blindspot System Fault	A fault with the system has occurred. Contact an authorized dealer as soon as possible.
Blindspot Not Available Sensor Blocked See Manual	The system sensors are blocked. See Blind Spot Information System (page 253).
Vehicle Coming From X	The system detects a vehicle. See Blind Spot Information System (page 253).
Cross Traffic Not Available Sensor Blocked See Manual	The blind spot information system and cross traffic alert system sensors are blocked. See Blind Spot Information System (page 253).
Cross Traffic System Fault	A fault with the system has occurred. Contact an authorized dealer as soon as possible.

Information Displays

Message	Action
Cross Traffic Alert Deactivated Trailer Attached	The system automatically turns off and displays this message when you connect a trailer to the vehicle that does not have a trailer blind spot system or when you switch the trailer blind spot system off through the information display. See Blind Spot Information System (page 253).
Blind Spot Alert Deactivated Trailer Attached	The system automatically turns off and displays this message when you connect a trailer to the vehicle that does not have a trailer blind spot system or when you switch the trailer blind spot system off through the information display. See Blind Spot Information System (page 253).
Trailer Blind Spot Not available Due to Invalid Trailer	Displays when the trailer connected is a fifth wheel or goose-neck, or when the trailer width is wider than 10 ft (2.7 m) or longer than 33 ft (10 m).

Diesel Messages



WARNING: When the **Exhaust Filter Cleaning** message appears in the information display, do not park near flammable materials, vapors or structures until filter cleaning is complete.

Message	Action
Exhaust Filter Cleaning	Your vehicle has entered the cleaning mode. Various engine actions raises the exhaust temperature in the Diesel Particulate Filter system to burn off the particles (exhaust soot). After the vehicle burns the particles off, the exhaust temperature returns to normal levels. This message is NORMAL.
Exhaust Filter Overloaded Drive to Clean	The diesel particulate filter is full of particles (exhaust soot) and you are not operating the vehicle in a manner that allows normal cleaning. Drive the vehicle above 30 mph (48 km/h) until the message turns off.
Exhaust Filter Overloaded Clean Now	
Exhaust Filter at Limit Clean Now	The diesel particulate filter is full of particles (exhaust soot) and you are not operating the vehicle in a manner that allows normal cleaning. Drive the vehicle above 30 mph (48 km/h) until the message turns off.
Exhaust Filter at Limit Drive to Clean Now	

Information Displays

Message	Action
Exhaust System Overheated Stop Safely NOW	Your vehicle exhaust system temperature exceeded the intended operating range. If this warning occurs, a tone sounds, followed by reduced engine power. The engine shuts down when your vehicle speed is below 3 mph (5 km/h) . Stop the vehicle as soon as safely possible. Have the system checked by an authorized dealer.
Engine Warming Please Wait {seconds:00} sec	In extremely cold weather, typically below -15°F (-26°C) and if the engine block heater is not utilized, your engine will not respond to accelerator pedal movement for 30 seconds. This restriction allows your engine to properly circulate the oil to avoid engine damage.
Exhaust Filter Drive Complete	Your diesel particulate filter is clean.
Exhaust Filter Cleaned	Your diesel particulate filter is clean (OCR Only).
Exhaust Filter Cleaning Stopped	The manual regeneration process has stopped (OCR Only).
DEF Level Range: XX mi/ km Refill Now	The distance you can travel before depleting the remaining diesel exhaust fluid.
DEF Level Empty Speed Limited to XX MPH / km/ h in XX mi/km	Your diesel exhaust fluid is nearing empty. Your vehicle's top speed will become limited in the displayed distance. You must replenish the diesel exhaust fluid to resume normal operation of your vehicle. See Selective Catalytic Reductant System (page 197).
DEF Level Empty Speed Limited to XX MPH/km/ h Upon Restart	Your remaining diesel exhaust fluid has depleted. Upon restart, your vehicle speed is now limited. You must replenish the diesel exhaust fluid to resume normal operation of your vehicle. See Selective Catalytic Reductant System (page 197).
DEF Level Empty Speed Limited to XX MPH/km/ h	The diesel exhaust fluid is empty. You must replenish the diesel exhaust fluid to resume normal operation of your vehicle. See Selective Catalytic Reductant System (page 197).
DEF Level Empty Engine Idled Soon	The selective catalytic reduction system detects low exhaust fluid. The engine will eventually enter into an idle only mode. You must replenish the diesel exhaust fluid to resume normal operation of your vehicle. See Selective Catalytic Reductant System (page 197).

Information Displays

Message	Action
DEF Level Empty Engine Idled See Manual	A problem exists with the selective catalytic reduction system causing your vehicle into an idle-only mode. If the exhaust fluid is empty, you must replenish the diesel exhaust fluid to resume normal operation of your vehicle. See Selective Catalytic Reductant System (page 197).
DEF Fault Speed Limited to XX MPH/km/h in XX mi/km	The selective catalytic reduction system detects a fault. The system displays your vehicle's top speed limit and distance before limitation. Have the system checked by an authorized dealer.
DEF Fault Speed Limited to XX MPH/km/h Upon Restart	The selective catalytic reduction system detects a fault. Upon restart, your vehicle speed is now limited. Have the system checked by an authorized dealer.
DEF Fault Speed Limited to XX MPH/km/h	The selective catalytic reduction system detects a fault. The system displays your vehicle's top speed limit. Have the system checked by an authorized dealer.
Exhaust Filter Over Limit Service Now	You must have your vehicle serviced by an authorized dealer. Ignoring the warning message could lead to reduced drivability and customer expense, including damage to the diesel particulate filter. Your new vehicle warranty could not cover this damage.
Water in Fuel Drain Filter	The water separator has reached a predetermined capacity and needs draining. See Draining the Fuel Filter Water Trap (page 355).
Fuel Pressure Low	A low fuel pressure condition has occurred due to cold, low fuel level or fuel filters need to be changed. See Fuel Quality (page 187).

Doors and Locks

Message	Action
X Door Ajar	The door(s) listed is not completely closed.

Information Displays

Driver Alert

Message	Action
Driver Alert Warning Rest Now	Stop and rest as soon as it is safe to do so.
Driver Alert Warning Rest Suggested	Take a rest soon.

Drivetrain

Message	Action
To Engage Locking Differential Slow to XX mph/km/h	The electronic locking differential requests that you slow to a certain speed to engage.
To Engage Locking Differential Release Accelerator Pedal	The electronic locking differential requests that you release the accelerator in order to engage.
Check Locking Differential	An electronic locking differential (ELD) system fault is present. Contact an authorized dealer as soon as possible.
Neutral Tow Enabled Leave Transmission in Neutral	The transfer case is in the neutral position. This message indicates that your vehicle is safe to tow with all four wheels on the ground.
Neutral Tow Disabled	The transfer case is NOT in the neutral position. This message indicates that your vehicle is NOT safe to be towed with all four wheels on the ground.

Engine

Message	Action
Power Reduced to Lower Engine Temp	The engine has reduced power to help reduce high engine temperature.

Information Displays

Fuel

Message	Action
Fuel Level Low	An early reminder of a low fuel condition.
Check Fuel Fill Inlet	The fuel fill inlet could not be properly closed.

Keys and Remote Controls

Message	Action
To START Press Brake	A reminder to press the brake while starting the vehicle.
No Key Detected	The system does not detect a key in your vehicle. See Keyless Starting (page 175).
Restart Now or Key is Needed	You pressed the StartStop button to switch off the engine and your vehicle does not detect your intelligent access key inside your vehicle.
Full Accessory Power Active	Your vehicle is in the run ignition state.
Starting System Fault	There is a problem with your vehicle's starting system. See an authorized dealer for service.
Key Program Successful	You have successfully programmed an intelligent access key to the system.
Key Program Failure	You have failed to program an intelligent access key to the system.
Max Number of Keys Learned	You have programmed the maximum number of keys to the system.
Not Enough Keys Learned	You have not programmed enough keys to the system.
Engine ON	Informs you that you are exiting your vehicle and the engine is on.

Information Displays

Lane Keeping System

Message	Action
Lane Keeping Sys. Malfunction Service Required	The system malfunctioned. Contact an authorized dealer as soon as possible.
Front Camera Temporarily Not Available	The system detects a condition that has caused the system to be temporarily unavailable.
Front Camera Low Visibility Clean Screen	The system detects a condition that requires you to clean the windshield in order for it to operate properly.
Front Camera Malfunction Service Required	The system malfunctioned. Contact an authorized dealer as soon as possible.
Keep Hands on Steering Wheel	The system requests you to keep your hands on the steering wheel.

Maintenance

Message	Action
Low Engine Oil Pressure	Stop your vehicle as soon as safely possible and turn off the engine. Check the oil level. If the warning stays on or continues to come on with your engine running, contact an authorized dealer as soon as possible.
Change Engine Oil Soon	The engine oil life remaining is 10% or less.
Oil Change Required	The oil life left is at 0%.
Brake Fluid Level Low	The brake fluid level is low, inspect the brake system immediately. See Brake Fluid Check (page 371).
Check Brake System	The brake system needs servicing. Stop your vehicle in a safe place. Contact an authorized dealer.
Transport / Factory Mode Contact Dealer	Your vehicle is still in Transport or Factory mode. This could not allow some features to operate properly. See an authorized dealer.
See Manual	The powertrain needs service due to a powertrain malfunction.

Information Displays

MyKey

Message	Action
MyKey not Created	You did not program a MyKey.
MyKey Active Drive Safely	MyKey is active.
Speed Limited to XX MPH/km/h	When switching on your vehicle and MyKey is in use, displays that the MyKey speed limit is on.
Near Vehicle Top Speed	MyKey is in use and the MyKey speed limit is on and the vehicle speed is approaching 81 mph (130 km/h).
Vehicle at Top Speed of MyKey Setting	You have reached the speed limit set for your MyKey.
Check Speed Drive Safely	You have an active MyKey with a programmed set speed limit.
Buckle Up to Unmute Audio	Belt-Minder turns on with a MyKey in use.
AdvanceTrac On - MyKey Setting	With a MyKey in use, AdvanceTrac turns on.
Traction Control On - MyKey Setting	With a MyKey in use, traction control turns on.
MyKey Park Aid Cannot be Deactivated	With a MyKey in use, park aid is always on.
Lane Keeping Alert On MyKey Setting	With a MyKey in use, lane keeping alert turns on.

Off Road

Message	Action
Hill Descent Control Active	Hill descent control mode is active.
Hill Descent Control OFF	Hill descent control mode is inactive.
For Hill Descent Reduce Speed XX MPH/km/h or Less	Your vehicle speed requirement for off-road mode entry has not been met.
For Hill Descent Select Gear	You need to select a transmission gear for hill descent mode.

Information Displays

Message	Action
Hill Descent Driver Resume Control	Hill descent control mode is deactivated and you must resume control.
Hill Descent Control Fault	A hill descent system fault is present.
Hill Descent Control Off System Cooling	The hill descent system is cooling due to overuse.
Hill Descent Control Ready	The hill descent control system is ready.

Park Aid

Message	Action
Check Front Park Aid	The system has detected a fault that requires service. Contact an authorized dealer. See Rear Parking Aid (page 233).
Check Rear Park Aid	The system has detected a fault that requires service. Contact an authorized dealer. See Rear Parking Aid (page 233).
Front Park Aid On Off	Displays the park aid status.
Rear Park Aid On Off	Displays the park aid status.

Park Brake

Message	Action
To Release: Press Brake and Switch	The electric parking brake is set and a manual release is attempted without the brake pedal being pressed.
Park Brake Use Switch to Release	The electric park brake is set and an automatic release is attempted but cannot be performed. Perform a manual release.
Release Park Brake	The electric park brake is set and your vehicle speed exceeds 3 mph (5 km/h). Release park brake before continued driving.
Park Brake Not Applied	The electric park brake is not fully applied.
Park Brake Not Released	The electric park brake is not fully released.

Information Displays

Message	Action
Park Brake Maintenance Mode	The electric park brake system has been put into a special mode that is used to allow service of the rear brakes. Contact an authorized dealer.
Park Brake Limited Function Service Required	The electric park brake system has detected a condition that requires service. Some functionality could still be available. Contact an authorized dealer.
Park Brake Malfunction Service Now	The electric park brake system has detected a condition that requires service. Contact an authorized dealer.

Power Steering

Message	Action
Steering Fault Service Now	The power steering system detects a condition that requires service. See an authorized dealer.
Steering Loss Stop Safely	The power steering system is not working. Stop your vehicle in a safe place. Contact an authorized dealer.
Steering Assist Fault Service Required	The power steering system detects a condition within the power steering system or passive entry or passive start system requires service. Contact an authorized dealer.
Steering Lock Malfunction Service Now	The steering lock system detects a condition that requires service. See an authorized dealer.

Pre-Collision Assist

Message	Action
Pre-Collision Assist Not Available Sensor Blocked	You have a blocked sensor due to bad weather, ice, mud or water in front of the radar sensor. You can typically clean the sensor to resolve.
Pre-Collision Assist Not Available	A fault with the system has occurred. Contact an authorized dealer as soon as possible.

Information Displays

Remote Start

Message	Action
To Drive: Press Brake and Gear Shift Button	A reminder to apply the brake and push the gearshift button to drive your vehicle after a remote start.

Seats

Message	Action
Memory Recall Not Permitted While Driving	A reminder that memory seats are not available while driving.
Memory {0} Saved	Shows where you have saved your memory setting.

Starting System

Message	Action
To START Press Brake	A reminder to apply the brake when starting your vehicle .
Cranking Time Exceeded	The starter has exceeded its cranking time in attempting to start your vehicle.
Engine Start Pending Please Wait	The starter is attempting to start your vehicle.
Pending Start Cancelled	The system has cancelled the pending start.

Tailgate

Message	Action
Tailgate Ajar	The tailgate is not completely closed.

Information Displays

Tire Pressure Monitoring System

Message	Action
Tire Pressure Low	One or more tires on your vehicle has low tire pressure. See Tire Pressure Monitoring System (page 414).
Tire Pressure Monitor Fault	The tire pressure monitoring system is malfunctioning. If the warning stays on or continues to come on, contact an authorized dealer. See Tire Pressure Monitoring System (page 414).
Tire Pressure Sensor Fault	A tire pressure sensor is malfunctioning or your spare tire is in use. See Tire Pressure Monitoring System (page 414). If the warning stays on or continues to come on, contact an authorized dealer as soon as possible.

Trail Control (If Equipped)

Message	Action
Reduce Speed To Enter Trail Control	You must reduce your vehicle speed to use trail control.
Trail Control Not Available with Park Brake Applied	You must release the park brake to use trail control.
Trail Control Enabled Use SET Button to Set Speed	You successfully enabled trail control and must press SET to activate.
Trail Control Off Driver Resume Control	A trail control system fault has occurred, the driver must resume control.
Trail Control Off	The system has switched off.
Trail Control Fault See Manual	A system fault is present.
Trail Control Not Available with Cruise Control Active	You must switch the cruise control off to use trail control.
Trail Control Not Available with Driver Door Open	You must close the door to use trail control.
Descent Control Now Active Press Trail Control Switch To Exit	You switched descent control off, causing the system to turn trail control propulsion off. The vehicle still brakes if descending a hill. You must press the trail control switch to reset the system and switch it off. You can press the switch again to switch this system on.

Information Displays

Message	Action
Trail Control Not Available While Pro Trailer Backup Assist™ Active	Displays when you must switch off the trailer backup assist to use trail control.
Set Trail Control to 1 MPH to Aid in Getting Unstuck in Sand	Displays when the system detects that you could be stuck in sand and turns trail control on to the lowest set speed.
Set Trail Control to 2 km/h to Aid in Getting Unstuck in Sand	

Trailer

Message	Action
Trailer Brake Gain: {trailer gain value:#0.0}	The current gain setting for the trailer brake.
Trailer Brake Gain: {trailer gain value:#0.0} No Trailer	The current gain setting for the trailer brake when you do not have a trailer connected.
Trailer Brake Module Fault	Faults sensed in the Integrated Trailer Brake Control Module followed by a single chime. See Towing a Trailer (page 277).
Trailer Connected	The system detects a correct trailer connection during a given ignition cycle.
Trailer Disconnected	The system senses a trailer connection becomes disconnected, either intentionally or unintentionally, during a given ignition cycle.
Trailer Sway Reduce Speed	The trailer sway control has detected trailer sway.
Trailer Wiring Fault	There are certain faults in your vehicle wiring and trailer wiring/brake system. See Towing a Trailer (page 277).
Trailer Left Turn Lamps Fault Check Lamps	There is a fault with your trailer turn lamp. Check your lamp.
Trailer Right Turn Lamps Fault Check Lamps	There is a fault with your trailer turn lamp. Check your lamp.
Trailer Battery Not Charging See Manual	There is a fault with your trailer battery. See Towing a Trailer (page 277).
Trailer Lighting Module Fault See Manual	There is a fault with your vehicle trailer lighting module. See Towing a Trailer (page 277).

Information Displays

Message	Action
Trailer Tire Low Specified:	One or more tires on your trailer is below the specified tire pressure.
Trailer Tire Pressure Sensor Fault	A trailer tire pressure sensor is malfunctioning. If the warning stays on or continues to come on, contact an authorized dealer as soon as possible.
Trailer Tire Pressure Monitor Fault	The trailer tire pressure monitoring system is malfunctioning. If the warning stays on or continues to come on, contact an authorized dealer.
Trailer Tire Pressure Monitor Capability Not Detected	The system cannot detect the trailer tire pressure monitoring system.
Trailer Tire Pressure Indication Not Setup See Manual	The trailer tire pressure monitoring system is not setup. See Tire Pressure Monitoring System (page 414).

4WD

Message	Action
Check 4x4	A 4X4 system fault is present. Contact an authorized dealer as soon as possible.
4x4 Shift in Progress	The 4X4 system is making a shift.
For 4x4 LOW Shift to N	Displays when you attempt to switch to 4X4 LOW and you do not shift the transmission to neutral (N).
For 4x4 LOW Slow to 3 MPH	Displays when you attempt to switch to 4X4 LOW and your vehicle's speed is too fast.
For 4x4 LOW Slow to 5 km/h	
To Exit 4x4 LOW Shift to N	Displays when you attempt to switch out of 4X4 LOW and you do not shift the transmission to neutral (N)
To Exit 4x4 LOW Slow to 3 MPH	Displays when you attempt to switch out of 4X4 LOW and your vehicle's speed is too fast.
To Exit 4x4 LOW Slow to 5 km/h	
Shift Delayed Pull Forward	Could display when there is a Transfer case gear tooth blockage while shifting to or from 4L or to the neutral state.
Shift to Neutral	Displays when the system requires an additional transmission shift to neutral (N) to complete a transfer case shift.

Information Displays

Message	Action
To Engage 4x4 Slow to 3 MPH	Displays when you command a 4x4 shift during conditions which are potentially harmful to the drive-line components.
To Engage 4x4 Slow to 5 km/h	
To Engage 4x4 Release Accelerator Pedal	Displays when the 4x4 system requests you release the accelerator pedal to complete a 4x4 shift. See Using Four-Wheel Drive (page 212).
For Improved Performance 4x4 Recommended	Displays when you command a drive mode change to Deep Snow/Sand and the vehicle is in 2H.
To Exit 4x4 LOW Exit Rock Crawl Mode	Displays when you attempt to switch out of 4x4 LOW and Rock Crawl mode is engaged.
To Enter Rock Crawl Mode 4x4 LOW is Required	Displays when you attempt to select Rock Crawl mode and 4x4 LOW is not engaged.

Climate Control

MANUAL CLIMATE CONTROL



E291393

Note: Depending on your vehicle option package, the controls may look different from what you see here.

Directing the Airflow



Press and release the button to direct airflow to the windshield air vents and de-mister.



Press and release the button to direct airflow to the instrument panel air vents.



Press and release the button to direct airflow to the footwell air vents.

You can direct air through any combination of these air vents.

Setting the Blower Motor Speed

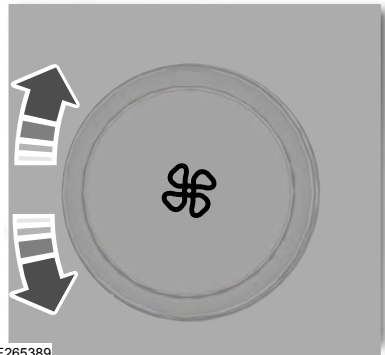

E265389

Turn the control to adjust the volume of air circulated in the vehicle.

Setting the Temperature

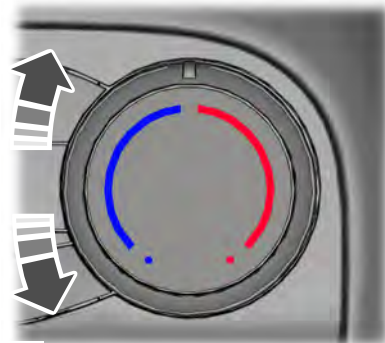

E244106

Turn the control to set the temperature.

Switching the Air Conditioning On and Off



Press and release the button.

Climate Control

Use air conditioning with recirculated air to improve cooling performance and efficiency.

Note: In certain conditions, for example, maximum defrost, the air conditioning compressor may continue to operate even though you switch off the air conditioning.

Switching the Climate Control On and Off



Press and release the button.

Switching Maximum Air Conditioning On and Off



Turn the temperature control counterclockwise to the lowest setting for maximum cooling.

Switching Maximum Defrost On and Off



Turn the temperature control clockwise to the highest setting for maximum defrosting.

You can also use this setting to defog and clear the windshield of a thin covering of ice.

Note: To prevent window fogging, you cannot select recirculated air when maximum defrost is on.

Switching Recirculated Air On and Off



Press and release the button to switch between outside air and recirculated air.

The air currently in the passenger compartment recirculates. This may reduce the time needed to cool the interior, when used with **A/C**, and reduce unwanted odors from entering your vehicle.

Note: Recirculated air may turn off, or prevent you from switching it on, in all air flow modes except **MAX A/C** to reduce the risk of fogging. Recirculation may also turn on and off in various air distribution control combinations during hot weather in order to improve cooling efficiency.

AUTOMATIC CLIMATE CONTROL (IF EQUIPPED)



E291388

Note: Depending on your vehicle option package, the controls may look different from what you see here.

Directing the Airflow



Press and release the button to direct airflow to the windshield air vents and de-mister.



Press and release the button to direct airflow to the instrument panel air vents.



Press and release the button to direct airflow to the footwell air vents.

You can direct air through any combination of these air vents.

Climate Control

Setting the Blower Motor Speed



Press and release **+** or **-** to adjust the volume of air circulated in the vehicle.

Setting the Temperature

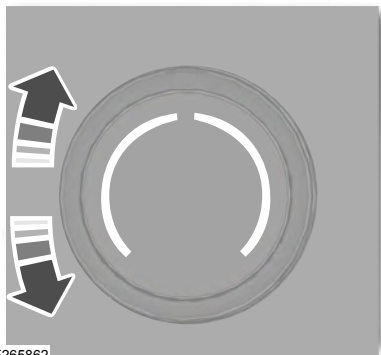

E265862

Turn the control on the left-hand side of the climate control to set the left-hand temperature.

Note: This control also sets the right-hand side temperature when you switch off dual zone mode.

Turn the control on the right-hand side of the climate control to set the right-hand temperature.

Switching Auto Mode On and Off



Press and release the button to switch on automatic operation, then set the temperature.

The system adjusts the blower motor speed, air distribution, air conditioning operation, and outside or recirculated air to reach and maintain the temperature you have set.

Switching the Air Conditioning On and Off



Press and release the button.

Use air conditioning with recirculated air to improve cooling performance and efficiency.

Note: In certain conditions, for example, maximum defrost, the air conditioning compressor may continue to operate even though you switch off the air conditioning.

Switching the Climate Control On and Off



Press and release the button.

Switching Dual Zone Mode On and Off



Press and release the button to switch on temperature control for the right-hand side of the vehicle.

Switching Maximum Air Conditioning On and Off



Press and release the button for maximum cooling.

The left-hand and right-hand settings set to LO, recirculated air flows through the instrument panel air vents, air conditioning turns on and the blower motor adjusts to the highest speed.

Switching Maximum Defrost On and Off



Press and release the button for maximum defrosting.

Climate Control

The left-hand and right-hand settings set to HI, air flows through the windshield air vents, and the blower motor adjusts to the highest speed.

You can also use this setting to defog and clear the windshield of a thin covering of ice.

Note: To prevent window fogging, you cannot select recirculated air when maximum defrost is on.

Note: The heated rear window also turns on when you select maximum defrost.

Switching Recirculated Air On and Off



Press and release the button to switch between outside air and recirculated air.

The air currently in the passenger compartment recirculates. This may reduce the time needed to cool the interior, when used with **A/C**, and reduce unwanted odors from entering your vehicle.

Note: Recirculated air may turn off, or prevent you from switching it on, in all air flow modes except **MAX A/C** to reduce the risk of fogging. Recirculation may also turn on and off in various air distribution control combinations during hot weather in order to improve cooling efficiency.

HINTS ON CONTROLLING THE INTERIOR CLIMATE - VEHICLES WITH: AUTOMATIC TEMPERATURE CONTROL

General Hints

Note: Prolonged use of recirculated air may cause the windows to fog up.

Note: You may feel a small amount of air from the footwell air vents regardless of the air distribution setting.

Note: To reduce humidity build-up inside your vehicle, do not drive with the system switched off or with recirculated air always switched on.

Note: Do not place objects under the front seats as this may interfere with the airflow to the rear seats.

Note: Remove any snow, ice or leaves from the air intake area at the base of the windshield.

Note: To improve the time to reach a comfortable temperature in hot weather, drive with the windows open until you feel cold air through the air vents.

Automatic Climate Control

Note: Adjusting the settings when your vehicle interior is extremely hot or cold is not necessary. Automatic mode is best recommended to maintain set temperature.

Note: The system adjusts to heat or cool the interior to the temperature you select as quickly as possible.

Note: For the system to function efficiently, the instrument panel and side air vents should be fully open.

Note: If you select **AUTO** during cold outside temperatures, the system directs air flow to the windshield and side window air vents. In addition, the blower motor may run at a slower speed until the engine warms up.

Note: If you select **AUTO** during hot temperatures and the inside of the vehicle is hot, the system uses recirculated air to maximize interior cooling. Blower motor speed may also reduce until the air cools.

Quickly Heating the Interior

1. Press and release **AUTO**.
2. Adjust the temperature function to the setting you prefer.

Climate Control

Recommended Settings for Heating

1. Press and release **AUTO**.
2. Adjust the temperature function to the setting you prefer. Use 72°F (22°C) as a starting point, then adjust the setting as necessary.

Quickly Cooling the Interior

1. Press and release **MAX A/C**.

Recommended Settings for Cooling

1. Press and release **AUTO**.
2. Adjust the temperature function to the setting you prefer. Use 72°F (22°C) as a starting point, then adjust the setting as necessary.

Defogging the Side Windows in Cold Weather

1. Press and release defrost or maximum defrost.
2. Adjust the temperature control to the setting you prefer. Use 72°F (22°C) as a starting point, then adjust the setting as necessary.

HINTS ON CONTROLLING THE INTERIOR CLIMATE - VEHICLES WITH: MANUAL TEMPERATURE CONTROL

General Hints

Note: *Prolonged use of recirculated air may cause the windows to fog up.*

Note: *You may feel a small amount of air from the footwell air vents regardless of the air distribution setting.*

Note: *To reduce humidity build-up inside your vehicle, do not drive with the system switched off or with recirculated air always switched on.*

Note: *Do not place objects under the front seats as this may interfere with the airflow to the rear seats.*

Note: *Remove any snow, ice or leaves from the air intake area at the base of the windshield.*

Note: *To improve the time to reach a comfortable temperature in hot weather, drive with the windows open until you feel cold air through the air vents.*

Quickly Heating the Interior

1. Adjust the blower motor speed to the highest speed setting.
2. Adjust the temperature control to the highest setting.
3. Direct air to the footwell air vents.

Recommended Settings for Heating

1. Adjust the blower motor speed to the center setting.
2. Adjust the temperature control to the midway point of the hot settings.
3. Direct air to the footwell air vents.

Quickly Cooling the Interior

1. Select **MAX A/C**.
2. Drive with the windows open for a short period of time.

Recommended Settings for Cooling

1. Adjust the blower motor speed to the center setting.
2. Adjust the temperature control to the midway point of the cold settings.

Climate Control

3. Direct air to the instrument panel air vents.

Vehicle Stationary for Extended Periods During Extreme High Ambient Temperatures

1. Apply the parking brake.
2. Place your vehicle in park (P) or neutral.
3. Select **MAX A/C**.
4. Adjust the blower motor speed to the lowest speed setting.

Defogging the Side Windows in Cold Weather

1. Direct air to the instrument panel and windshield air vents.
2. Press and release **A/C**.
3. Adjust the temperature control to the setting you prefer.
4. Adjust the blower motor speed to the highest setting.
5. Direct air toward the side windows.
6. Close the instrument panel air vents.

HEATED WINDSHIELD (IF EQUIPPED)

Windshield Wiper De-Icer



When you switch the heated rear window on, the windshield wiper de-icer turns on.

HEATED REAR WINDOW (IF EQUIPPED)



Press the button to clear the rear window of thin ice and fog. The heated rear window turns off after a short period of time.

Note: Do not use harsh chemicals, razor blades or other sharp objects to clean or remove decals from the inside of the heated rear window. The vehicle warranty may not cover damage to the heated rear window grid lines.

HEATED EXTERIOR MIRRORS

(IF EQUIPPED)



Press the button to clear the exterior mirrors of thin ice and fog. Press the button again to switch them off. They switch off after a short period of time.

Note: Do not remove ice from the mirrors with a scraper or adjust the mirror glass when it is frozen in place. These actions could cause damage to the glass and mirrors.

Note: Do not clean the mirror housing or glass with harsh abrasives, fuel or other petroleum-based cleaning products.

REMOTE START (IF EQUIPPED)

You can switch this feature on or off and adjust the settings in the information display.

The system adjusts the interior temperature depending on your chosen settings during remote start.

You cannot adjust the climate control setting during remote start operation. The information display and the indicators do not turn on during remote start. When you switch the ignition on, the climate control system returns to the previous settings. You can now make adjustments.

You need to switch on certain vehicle-dependent features, such as:

- Heated seats.
- Cooled seats.

Climate Control

- Heated steering wheel.
- Heated mirrors.
- Heated rear window.

Automatic Settings

In hot weather, the system sets to 72°F (22°C). The cooled seats are set to high, if available, and **AUTO** is on in the information display.

In moderate weather, the system either heats or cools, based on pre-selected settings. The rear defroster, heated mirrors and heated or cooled seats do not turn on.

In cold weather, the system sets to 72°F (22°C). The heated seats are set to high, if available, and **AUTO** is on in the information display. The heated rear window and heated mirrors turn on.

Interior Air Quality

WHAT IS THE CABIN AIR FILTER

Your vehicle has a cabin air filter, which gives you and your passengers the following benefits:

- It improves your driving comfort by reducing particle concentration.
- It improves the interior compartment cleanliness.
- It protects the climate control components from particle deposits.

LOCATING THE CABIN AIR FILTER

You can locate the cabin air filter behind the glove box.

REPLACING THE CABIN AIR FILTER

Replace the filter at regular intervals. See **Scheduled Maintenance** (page 557).

Note: *Make sure you have a cabin air filter installed at all times. This prevents foreign objects from entering the system. Running the system without a filter in place could result in degradation or damage to the system.*

Note: *Using an aftermarket cabin air filter could reduce cabin air filtration and climate control performance.*

Seats

SITTING IN THE CORRECT POSITION



WARNING: Sitting improperly, out of position or with the seatback reclined too far can take weight off the seat cushion and affect the decision of the passenger sensing system, resulting in serious injury or death in the event of a crash. Always sit upright against your seat back, with your feet on the floor.



WARNING: Do not recline the seatback too far as this can cause the occupant to slide under the seatbelt, resulting in serious injury in the event of a collision.



WARNING: Do not place objects higher than the top of the seat backrest. Failure to follow this instruction could result in personal injury or death in the event of a sudden stop or crash.

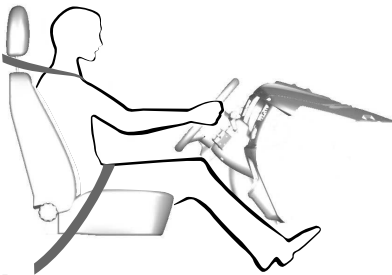

E68595

When you use them properly, the seat, head restraint, seatbelt and airbags will provide optimum protection in the event of a crash.

We recommend that you follow these guidelines:

- Sit in an upright position with the base of your spine as far back as possible.
- Do not recline the seat backrest so that your torso is more than 30° from the upright position.
- Adjust the head restraint so that the top of it is level with the top of your head and as far forward as possible. Make sure that you remain comfortable.
- Keep sufficient distance between yourself and the steering wheel. We recommend a minimum of 10 in (25 cm) between your breastbone and the airbag cover.
- Hold the steering wheel with your arms slightly bent.
- Bend your legs slightly so that you can press the pedals fully.
- Position the shoulder strap of the seatbelt over the center of your shoulder and position the lap strap tightly across your hips.

Make sure that your driving position is comfortable and that you can maintain full control of your vehicle.

HEAD RESTRAINTS



WARNING: Fully adjust the head restraint before you sit in or operate your vehicle. This will help minimize the risk of neck injury in the event of a crash. Do not adjust the head restraint when your vehicle is moving.

Seats



WARNING: The head restraint is a safety device. Whenever possible it should be installed and properly adjusted when the seat is occupied. Failure to adjust the head restraint properly could reduce its effectiveness during certain impacts.

Note: Adjust the seat backrest to an upright driving position before adjusting the head restraint. Adjust the head restraint so that the top of it is level with the top of your head and as far forward as possible. Make sure that you remain comfortable. If you are extremely tall, adjust the head restraint to its highest position.

Front Seat Head Restraint

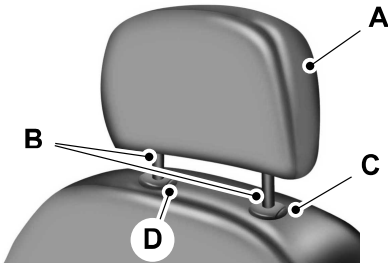

E138642

Rear Seat Outermost Head Restraints

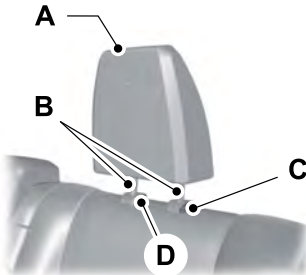

E153105

The head restraints may consist of:

- A An energy absorbing head restraint.
- B Two steel stems.
- C Guide sleeve adjust and release button.
- D Guide sleeve unlock and remove button.

Adjusting the Head Restraint

Raising the Head Restraint

Pull the head restraint up.

Lowering the Head Restraint

1. Press and hold button C.
2. Push the head restraint down.

Removing the Head Restraint

1. Press and hold buttons C and D.
2. Pull the head restraint up.

Installing the Head Restraint

Align the steel stems into the guide sleeves and push the head restraint down until it locks.

Front Row Center and Rear Seat Center (Crew Cab) Head Restraints

Your vehicle may have head restraints that are non-adjustable. The non-adjustable head restraints consist of:

Seats

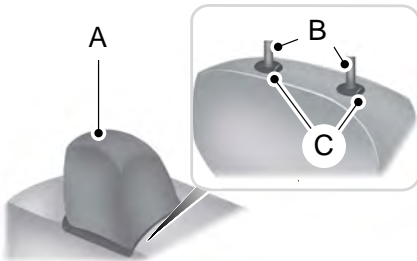

E162872

- A An energy absorbing head restraint.
- B Two steel stems.
- C Guide sleeve unlock and remove button.

Removing the Head Restraint

1. Press and hold buttons C.
2. Pull up the head restraint.

Installing the Head Restraint

Align the steel stems into the guide sleeves and push the head restraint down until it locks.

Front Seat Center Head Restraint

Your vehicle may have a front row center head restraint that you cannot adjust or remove.

Tilting Head Restraints (If Equipped)

The front head restraints tilt for extra comfort.



E144727

1. Adjust the seat backrest to an upright driving or riding position.
2. Pivot the head restraint forward toward your head to the desired position.

After the head restraint reaches the forward-most tilt position, pivot it forward again to release it to the rearward, un-tilted position.

Note: Do not attempt to force the head restraint backward after you tilt it. Instead, continue tilting it forward until the head restraint releases to the upright position.

MANUAL SEATS (IF EQUIPPED)



WARNING: Do not adjust the driver's seat or seatback when your vehicle is moving.

Seats

Moving the Seat Backward and Forward



E175314

Recline Adjustment



E175315

Manual Lumbar (If Equipped)



E166702

The lumbar support control is located on the outboard side of the seat. Turn the control to adjust your support.

POWER SEATS (IF EQUIPPED)

⚠ WARNING: Do not adjust the driver seat or seat backrest when your vehicle is moving. This may result in sudden seat movement, causing the loss of control of your vehicle.

⚠ WARNING: Do not place cargo or any objects behind the seatback before returning it to the original position.

Seats

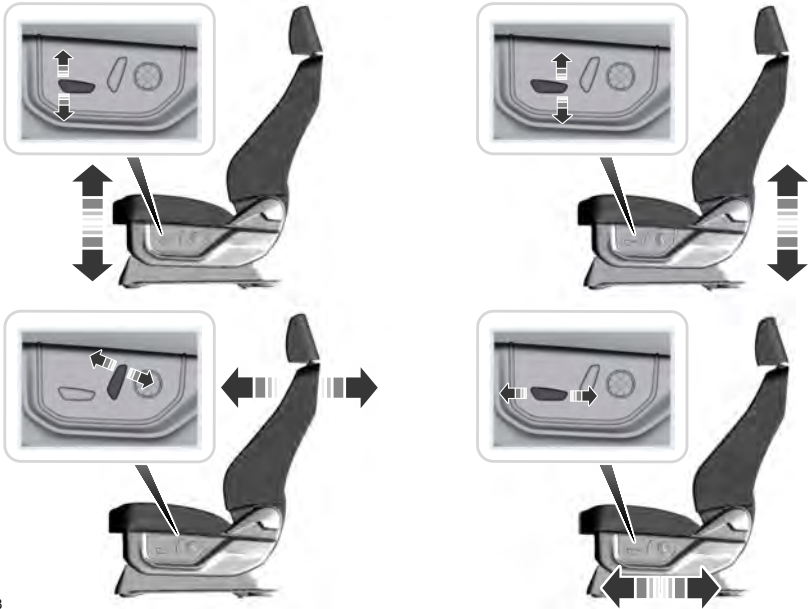

E176038

Adjusting the Lumbar Support (if Equipped)



E176039

Adjusting the Multi-Contour Front Seats With Active Motion (if Equipped)

Note: The engine must be running or the vehicle must be in accessory mode to activate the seats.

Note: Allow a few seconds for any selection to activate. When the seat backrest and cushion are both active, the massage alternates between zones.

Seats

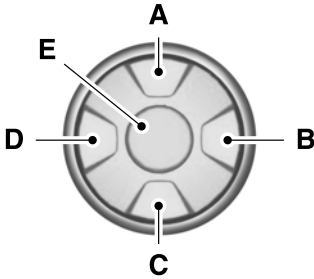

E156301

	Massage Mode	Lumbar and Bolster Mode
A	Back massage intensity adjustment	Upper lumbar
B	Massage intensity decrease and off*	Lumbar decrease
C	Cushion massage intensity adjustment	Lower lumbar**
D	Massage intensity increase	Lumbar increase
E	On and off	-

*The massage feature defaults to an alternating massage mode with back massage intensity adjustment. The lumbar and bolster feature defaults to the middle lumbar mode.

**Press C a second time to adjust the back bolster. Press C a third time to adjust the cushion bolster.

You can also adjust this feature through the touchscreen. When switched on, the system displays directions for you to adjust the lumbar settings in your seat or to set the massage function.

To access and make adjustments to the lumbar setting:

1. Press the Menu Settings icon > Vehicle > Multi-Contour Seat.

2. Choose the desired seat to adjust.
3. Press the + or - to adjust the lumbar intensity.

To access and make adjustments to the massage setting:

1. Press the Menu Settings icon > Vehicle > Multi-Contour Seat.
2. Choose the desired seat to adjust.
3. Press Off, Low or High.

Seats

MEMORY FUNCTION (IF EQUIPPED)



WARNING: Before activating the memory seat, make sure that the area immediately surrounding the seat is clear of obstructions and that all occupants are clear of moving parts.



WARNING: Do not use the memory function when your vehicle is moving.

This feature recalls the position of the following:

- Driver seat.
- Power mirrors.
- Optional power steering column.
- Optional power adjustable pedals.

The memory control is on the driver door.



Saving a Preset Position

1. Switch the ignition on.
2. Adjust the features to the positions you prefer.
3. Press and hold the preset button until you hear a single tone.

Note: A confirmation that you saved a memory preset appears in the information display.

Note: You can save up to three preset memory positions.

Note: You can save a memory preset at any time.

Recalling a Preset Position

1. Switch the ignition on.
2. Press and release the preset button associated with your preferred driving position. The seat and mirrors move to the position stored for that preset.

Note: You can only recall preset memory positions when you switch the ignition off, or when the transmission is in park (P) or neutral (N) if you switch the ignition on.

You can also recall a preset memory position by:

- Pressing the unlock button on your remote control if it is linked to a preset position.
- Unlocking the intelligent driver door handle if a linked keyfob is present.

Note: Using a linked key fob to recall your memory position when the ignition is off moves the seat and steering column to the easy entry position.

Note: Pressing any active memory feature control - power seat, mirror (or any memory button) during a memory recall cancels the operation.

Linking a PreSet Position to your Remote Control or Intelligent Access Key Fob

Your vehicle can save the preset memory positions for up to two remote controls.

1. With the ignition on, move the memory positions to the positions you prefer.
2. Press and hold the desired preset button for about five seconds. A tone will sound, and the instrument panel prompts you to press the lock button on your key fob.

Seats

3. Within ten seconds, press the lock button on the remote control you are linking. The instrument panel indicates a successful link.

To unlink a remote control, follow the same procedure – except in step 3, press the unlock button on the remote control.

Note: *If more than one linked remote control or intelligent access key is in range, the memory function moves to the settings of the first key to initiate a memory recall.*

Easy Entry and Exit Feature (If Equipped)

If you enable the easy entry and exit feature, it moves the driver seat rearward up to 2 in (5 cm) when you put the transmission in park (P) and remove the key from the ignition.

The driver seat returns to the previous position when you put the key in the ignition.

You can enable or disable this feature through the information display. See **Information Displays** (page 112).

REAR SEATS (IF EQUIPPED)

Folding Up the Rear Seat Cushion

If your vehicle has a 60/40 rear seat, you can flip each cushion up into a vertical storage position.



Rotate the seat cushion up until it locks into the vertical storage position.

Cushion Lock (If Equipped)

The locking key is in the remote control. See **Remote Control** (page 55).

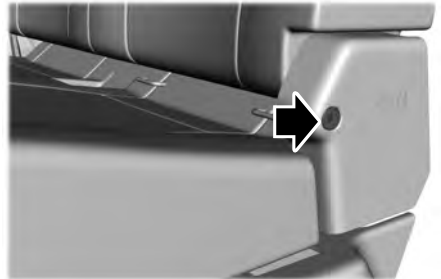

Turn the key to lock or unlock.

Seats

Returning the Seat to the Seating Position



WARNING: Check under the seat cushion to make sure no cargo or objects are under the seat cushion before returning the seat cushion to its original position, and that the seat cushion locks into place. Failure to do so may prevent the seat from operating properly in the event of a crash, which could increase the risk of serious injury.

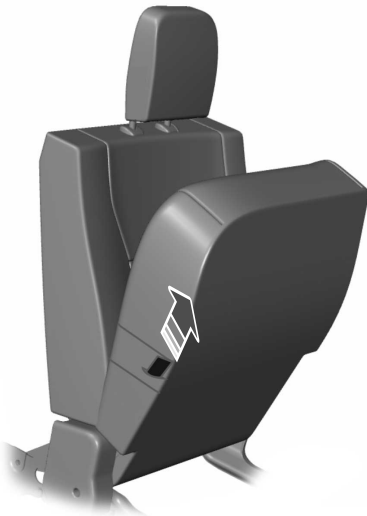

Pull the strap to release the seat cushion from the storage position.

Rear Under Seat Storage (If Equipped)

The rear seat has storage space under the seat cushion.

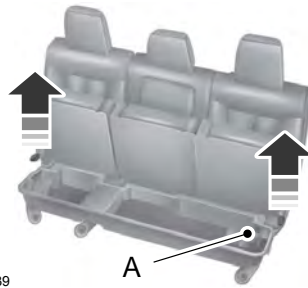

E162739

Lift the lever and flip up the seat cushion to access the storage space and the power point (A).

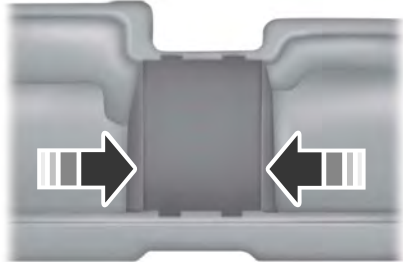

E162740

To remove the storage space divider, squeeze the sides and lift it from the storage tub.



E162741

Seats

Use your vehicle key to lock the storage space. See **Keys and Remote Controls** (page 55).

HEATED SEATS (IF EQUIPPED)



WARNING: People who are unable to feel pain to their skin because of advanced age, chronic illness, diabetes, spinal cord injury, medication, alcohol use, exhaustion or other physical conditions, must exercise care when using the heated seat. The heated seat may cause burns even at low temperatures, especially if used for long periods of time. Do not place anything on the seat that insulates against heat, such as a blanket or cushion. This may cause the heated seat to overheat. Do not puncture the seat with pins, needles or other pointed objects. This may damage the heating element which may cause the heated seat to overheat. An overheated seat may cause serious personal injury.

Do not do the following:

- Place heavy objects on the seat.
- Operate the heated seat if water or any other liquid spills on the seat. Allow the seat to dry thoroughly.

Note: *The engine must be running to use this feature.*



E146322

Press the heated seat symbol to cycle through the various heat settings and off. More indicator lights indicate warmer settings.

Note: *The heated seats may remain on after you remote start your vehicle, based on your remote start settings. The heated seats may also turn on when you start your vehicle if they were on when you switched your vehicle off.*

Rear Heated Seats (If Equipped)



WARNING: People who are unable to feel pain to their skin because of advanced age, chronic illness, diabetes, spinal cord injury, medication, alcohol use, exhaustion or other physical conditions, must exercise care when using the heated seat. The heated seat may cause burns even at low temperatures, especially if used for long periods of time. Do not place anything on the seat that insulates against heat, such as a blanket or cushion. This may cause the heated seat to overheat. Do not puncture the seat with pins, needles or other pointed objects. This may damage the heating element which may cause the heated seat to overheat. An overheated seat may cause serious personal injury.

Do not do the following:

- Place heavy objects on the seat.
- Operate the heated seat if water or any other liquid spills on the seat. Allow the seat to dry thoroughly.

Note: *The engine must be running to use this feature.*

The rear seat heat controls are on the rear of the center console.

Seats



E146322

Press the heated seat symbol to cycle through the various heat settings and off. More indicator lights indicate warmer settings.

The heated seat module resets at every ignition run cycle. While the ignition is in the on position, press the heated seat switch to enable heating mode. When activated, they turn off automatically when you switch off the engine.

VENTILATED SEATS (IF EQUIPPED)

Note: *The ventilated seats may remain on after you remote start your vehicle, based on your remote start settings. The ventilated seats may also turn on when you start your vehicle if they were on when you switched your vehicle off.*

Do not do the following:

- Spill liquid on the front seats. This may cause the air vent holes to become blocked and not work properly.
- Place cargo or objects under the seats. They may block the air intake causing the air vents to not work properly.

The engine must be running to use this feature.



E224689

Press this symbol to cycle through the various ventilation settings and off. More indicator lights indicate higher fan speeds.

If the engine falls below 350 RPM while the ventilated seats are on, the feature turns itself off. You need to reactivate it.

Note: *To improve comfort, use the ventilated seats along with the vehicle's air conditioning system.*

Rear Occupant Alert System (If Equipped)

WHAT IS THE REAR OCCUPANT ALERT SYSTEM

The rear occupant alert system monitors vehicle conditions and notifies you to check for rear seat occupants when you switch the ignition off.

HOW DOES THE REAR OCCUPANT ALERT SYSTEM WORK

The system monitors when rear doors have been opened and closed to indicate the potential presence of an occupant in the rear seat. It displays a message in the information and entertainment display screen and sounds an audible warning when you switch the ignition off.

The system alerts you in the following conditions:

- A rear door is opened or closed while the ignition is on.
- You switch the ignition on within 15 minutes of a rear door opening and closing.
- You switch the ignition on within 15 minutes of the alert having displayed or sounded.

REAR OCCUPANT ALERT SYSTEM PRECAUTIONS



WARNING: On hot days, the temperature inside the vehicle can rise very quickly. Exposure of people or animals to these high temperatures for even a short time can cause death or serious heat related injuries, including brain damage. Small children are particularly at risk.



WARNING: Do not leave children or pets unattended in your vehicle. Failure to follow this instruction could result in personal injury or death.

REAR OCCUPANT ALERT SYSTEM LIMITATIONS

The system does not detect the presence of objects or passengers in the rear seat. It monitors when rear doors are opened and closed.

Note: *It is possible to receive an alert when there is no rear seat occupant, but alert conditions are met.*

Note: *It is possible to receive no alert when there is an occupant in the rear seat, if alert conditions are not met. For example, if a rear seat occupant does not enter the vehicle through a rear door.*

Note: *The audible warning does not sound when the front door is opened before you switch the ignition off.*

SWITCHING REAR OCCUPANT ALERT SYSTEM ON AND OFF - VEHICLES WITH: SYNC



Press the button on the audio unit.

1. Using the controls on the audio unit, select **Settings**.
2. Switch **Rear Occupant Alert** on or off.

SWITCHING REAR OCCUPANT ALERT SYSTEM ON AND OFF - VEHICLES WITH: SYNC 3

1. Press **Settings** on the touchscreen.

Rear Occupant Alert System (If Equipped)

2. Press **Vehicle**.
3. Switch **Rear Occupant Alert** on or off.

Note: If you do not make a selection, the system defaults to on.

Note: Performing a master reset causes the system to switch on again.

REAR OCCUPANT ALERT SYSTEM INDICATORS - VEHICLES WITH: SYNC

Message
Check rear seats for occupants.

Displays when you switch the vehicle off after the alert conditions are met.

 The message displays for approximately ten seconds. Press the **OK** button to acknowledge and remove some messages from the information display.

REAR OCCUPANT ALERT SYSTEM INDICATORS - VEHICLES WITH: SYNC 3



Message
Check rear seats for occupants.

Displays when you switch your vehicle off after the alert conditions are met.

The message displays for approximately ten seconds. Press **Close** to acknowledge and remove the message.

REAR OCCUPANT ALERT SYSTEM AUDIBLE WARNINGS

Sounds when you switch your vehicle off with the alert armed.

The warning sounds for a short period of time.

Garage Door Opener (If Equipped)

UNIVERSAL GARAGE DOOR OPENER

HomeLink Wireless Control System



WARNING: Do not use the system with any garage door opener that does not have the safety stop and reverse feature as required by U.S. Federal Safety Standards (this includes any garage door opener manufactured before April 1, 1982). A garage door opener which cannot detect an object, signaling the door to stop and reverse, does not meet current federal safety standards. Using a garage door opener without these features increases the risk of serious injury or death.

Note: Make sure that the garage door and security device are free from obstruction when you are programming. Do not program the system with the vehicle in the garage.

Note: Make sure you keep the original remote control transmitter for use in other vehicles as well as for future system programming.

Note: We recommend that upon the sale or lease termination of your vehicle, you erase the programmed function buttons for security reasons. See **Erasing the Function Button Codes** later in this section.

Note: You can program a maximum of three devices. To change or replace any of the three devices after it has been initially programmed, you must first erase the current settings. See **Erasing the Function Button Codes**.



E188211

The universal garage door opener replaces the common hand-held garage door opener with a three-button transmitter integrated into the driver's sun visor.

The system includes two primary features, a garage door opener and a platform for remote activation of devices within the home. You can program garage doors as well as entry gate operators, security systems, entry door locks and home or office lighting.

Additional system information can be found online at www.homelink.com, www.youtube.com/user/HomeLinkGentex or by calling the toll-free help line at 1-800-355-3515.

In-Vehicle Programming

This process is to program your in-vehicle HomeLink function button with your hand-held transmitter.

Note: The programming steps below assume you will be programming HomeLink that was not previously programmed. If your HomeLink was previously programmed, you may need to erase your HomeLink buttons. See **Erasing the Function Button Codes**.

Note: Put a new battery in the hand-held transmitter. This allows for quicker training and accurate transmission of the radio-frequency signal.

Garage Door Opener (If Equipped)



E188212

1. With your vehicle parked outside of the garage, switch your ignition to the **on** position, but do not start your vehicle.
2. Press and release the function button that you would like to program.
3. Hold your hand-held garage door transmitter 1–3 in (2–8 cm) away from the HomeLink button you want to program.
4. Press and hold the hand-held transmitter button you want to program while watching the indicator light on HomeLink. Continue to hold the hand-held button until the HomeLink indicator light flashes rapidly or is continuously on.

Note: You may need to use a different method if you live in Canada or have difficulties programming your gate operator or garage door opener. See **Gate Operator / Canadian Programming**.

5. Press and hold the HomeLink button you programmed for two seconds, then release. You may need to do this twice to activate the door. If your garage door does not operate, watch the HomeLink indicator light.

If the indicator light stays on, the programming is complete. Your device should activate when the HomeLink button is pressed and released.

If the indicator light flashes rapidly, press and hold for two seconds and release the programmed HomeLink button. Repeat the "press/hold/release" sequence up to three times to complete the programming process. If your device still does not operate, you must program your garage door. See **Programming Your Garage Door Opener Motor**.

To program additional buttons, repeat Steps 1 – 4.

For questions or comments, please contact HomeLink at www.homelink.com, www.youtube.com/user/HomeLinkGentex or by calling the toll-free help line at 1-800-355-3515.

Programming Your Garage Door Opener Motor

Note: You may need a ladder to reach the unit and you may need to remove the cover or lamp lens on your garage door opener.



E142659

1. Press the learn button on the garage door opener motor and then you have 30 seconds to complete the next two steps.
2. Return to your vehicle.

Garage Door Opener (If Equipped)

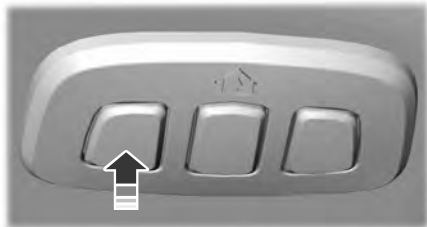

E188212

3. Press and hold the function button you want to program for 2 seconds, then release. Repeat this step. Depending on your brand of garage door opener, you may need to repeat this sequence a third time.

Gate Operator / Canadian Programming

Canadian radio-frequency laws require transmitter signals to “time-out” (or quit) after several seconds of transmission – which may not be long enough for HomeLink to pick up the signal during programming. Similar to this Canadian law, some U.S. gate operators are designed to “time-out” in the same manner.

Note: *If programming a garage door opener or gate operator, it is advised to unplug the device during the “cycling” process to prevent possible overheating.*

1. Press and release, **every two seconds**, your hand-held transmitter until the HomeLink indicator light changes to a rapidly blinking or continuously on light.
2. Release the hand-held transmitter button.
3. Continue programming HomeLink. See **In-Vehicle Programming, Step 4.**

Erasing the Function Button Codes

Note: *You cannot erase individual buttons.*

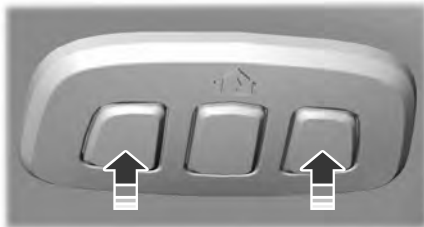

E188213

1. Press and hold the outer two function buttons simultaneously for approximately 10 seconds until the indicator light above the buttons flashes rapidly.
2. When the indicator light flashes, release the buttons. You erased the codes for all buttons.

Reprogramming a Single Button

To program a device to a previously trained button, follow these steps:

1. Press and hold the desired button. Do NOT release the button.
2. The indicator light begins to flash after 20 seconds. Without releasing the button, follow Step 1 in the Programming section.

For questions or comments, contact HomeLink at www.homelink.com, www.youtube.com/user/HomeLinkGentex or by calling the toll-free help line at 1-800-355-3515.

Garage Door Opener (If Equipped)

FCC and RSS-210 Industry Canada Compliance

This device complies with Part 15 of the FCC Rules and with RSS-210 of Industry Canada. Operation is subject to the following two conditions: (1) this device may not cause harmful interference, and (2) this device must accept any interference received, including interference that may cause undesired operation.



WARNING: Changes or modifications not expressly approved by the party responsible for compliance could void the user's authority to operate the equipment. The term "IC:" before the radio certification number only signifies that Industry Canada technical specifications were met.

This equipment complies with FCC radiation exposure limits set forth for an uncontrolled environment. End Users must follow the specific operating instructions for satisfying RF exposure compliance. This transmitter must be at least 8 in (20 cm) from the user and must not be co-located or operating in conjunction with any other antenna or transmitter.

The term "IC:" before the certification/registration number only signifies that Industry Canada technical specifications were met.

Auxiliary Power Points

12 V DC Power Point



WARNING: Do not plug optional electrical accessories into the cigar lighter socket. Incorrect use of the cigar lighter can cause damage not covered by the vehicle warranty, and can result in fire or serious injury.

Note: When you switch the ignition on, you can use the socket to power 12 V appliances with a maximum current rating of 20 A20 amps.

Note: Do not plug in any device that supplies power to the vehicle through the power points, this may result in damage to vehicle systems.

Note: Do not hang any accessory from the accessory plug.

Note: Do not use the power point over the vehicle capacity of 12 V DC 240 W or a fuse may blow.

Note: Always keep the power point caps closed when not in use.

Do not insert objects other than an accessory plug into the power point. This damages the power point and may blow the fuse.

Run the vehicle for full capacity use of the power point.

To prevent the battery from running out of charge:

- Do not use the power point longer than necessary when the engine is off.
- Do not leave devices plugged in overnight or when you park your vehicle for extended periods.

110 V 400 Watt AC Power Point (If Equipped)



WARNING: Do not keep electrical devices plugged in the power point whenever the device is not in use. Do not use any extension cord with the 110 volt AC power point, since it will defeat the safety protection design. Doing so may cause the power point to overload due to powering multiple devices that can reach beyond the 400 watt load limit and could result in fire or serious injury.

Note: This feature works only when you have the ignition switched on.

Note: This feature has a maximum output of 400 watts when the vehicle is in park (P).

Note: While in drive (D), the maximum outlet output is 300 watts.

Note: When powering electric devices that require more than 10 watts in vehicles equipped with keyless start, the engine must remain running. If the engine is turned off or you switch the ignition to accessory mode, plugged in devices will not be charged.

You can use the power point for electric devices that require up to 400 watts. It is on the instrument panel, and the rear of the center console.



E191617

Auxiliary Power Points

When the indicator light on the power point is:

- On: The power point is working, the ignition is on and a device is plugged in.
- Off: The power point is off, the ignition is off or no device is plugged in.
- Flashing: The power point is in fault mode.

The power outlet temporarily turns off power when in fault mode if the device exceeds the 400 watt limit. Unplug your device and switch the ignition off. Switch the ignition back on, but do not plug your device back in. Let the system cool off and switch the ignition off to reset the fault mode. Switch the ignition back on and make sure the indicator light remains on.

You can use the 400 watt power outlet for these types of electric devices:

- Electric hand drills.
- Rechargeable power tools.
- Video games.
- Laptops.
- Televisions.

Note: *Max 400W - when the vehicle is parked and 300W - when the vehicle is driving.*

Do not use the power point for certain electric devices, including:

- Cathode-ray, tube-type televisions.
- Motor loads, such as vacuum cleaners, electric saws and other electric power tools or compressor-driven refrigerators.
- Measuring devices, which process precise data, such as medical equipment or measuring equipment.
- Other appliances requiring an extremely stable power supply such as microcomputer-controlled electric blankets or touch-sensor lamps.

Locations

Note: *Timed power points remain on for 30 minutes if the vehicle is in accessory mode. If you switch the vehicle off, the timed power points remain on for 75 minutes.*

Power points may be in the following locations:

- On the instrument panel.
- Inside the center console.
- On the rear of the center console.
- In the seat bin.

WIRELESS ACCESSORY CHARGING (IF EQUIPPED)



WARNING: Wireless charging devices can affect the operation of implanted medical devices, including cardiac pacemakers. If you have any implanted medical devices, we recommend that you consult with your physician.



WARNING: Changes or modifications not expressly approved by the party responsible for compliance could void the user's authority to operate the equipment. The term "IC:" before the radio certification number only signifies that Industry Canada technical specifications were met.

Note: *Devices without built-in Qi wireless charging receivers require an additional Qi receiver or sleeve.*

Note: *For compatible devices with built-in Qi wireless charging capability, the charging performance may be affected if your device is in a case. It may be necessary to remove the case to wirelessly charge your device.*

Auxiliary Power Points

The system supports one Qi wireless charging compatible device on the charging area.

Keep the charging area clean and remove foreign objects prior to charging a device.

Do not place items with a magnetic strip, for example passports, parking tickets or credit cards, near the charging area when charging a device. Damage may occur to the magnetic strip.

Do not place metal objects, for example remote controls, coins and candy wrappers, on or near the charging area when charging a device. Metal objects may heat up and degrade the charging performance.

Note: *The device controls the rate of charge, or charging power. During charging, the device and the charger may heat up, this is normal. If the battery gets hotter than usual, the charger may stop charging.*



The charging area is on the center console or lower instrument panel. See **Center Console** (page 171).

You can charge a device if the vehicle is on, when in accessory mode, or anytime SYNC is on.

To begin charging, place the device on the center of the charging surface with the charging side down. The charging stops after your device reaches a full charge.

Note: *If the system detects a foreign object or if the device is misaligned on the charging area, a message appears in the display.*

Note: *Software and firmware updates may affect device compatibility, including the use of unofficial software or firmware. You should verify charging functionality with your specific devices when in your vehicle.*

Message	Behavior	Description
Wireless Charger Active	Message on screen display or pop-up window.	This message appears when wireless charging begins.
Charging Terminated Phone misaligned or object between phone and charger detected. Correct the condition to resume charging.	Pop-up window.	The system stops charging your device if the system detects the phone is misaligned, or a foreign metal object is on the charging surface.

FCC ID: L2C0066T

Auxiliary Power Points

Tests on this equipment show that it complies with part 18 of the FCC Rules.

- This equipment generates, uses and can radiate radio frequency energy and may cause harmful interference to radio communications. There is no guarantee that the interference will not occur in a particular installation. If this equipment does cause harmful interference to radio or television reception, please consult the dealer.
- This product is not end-user serviceable.

This device complies with Industry Canada licence-exempt RSS standard(s).

Operation is subject to:

- This device may not cause interference.
- This device must accept any interference, including interference that may cause undesired operation of the device.

Note: *Changes or modifications not expressly approved by the party responsible for compliance could void the user's authority to operate the equipment. The term "IC" before the radio certification number only signifies that Industry Canada technical specifications were met.*

Storage Compartments

CENTER CONSOLE (IF EQUIPPED)

Stow items in the cup holder carefully as items may become loose during hard braking, acceleration or crashes, including hot drinks which may spill.

Available console features include:

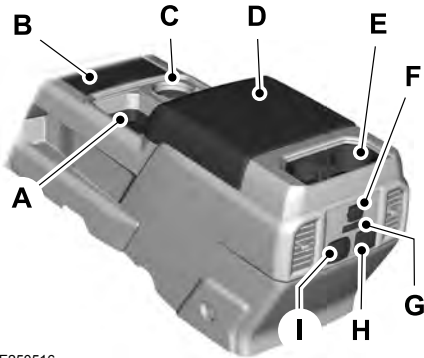

E250516

- A Storage compartment.
- B Front storage compartment with USB ports.
- C Sliding cup holder.
- D Center storage compartment with auxiliary power point.
- E Rear cup holders.
- F AC power point.
- G Heated rear seats.
- H Auxiliary power point.
- I USB charging ports.

OVERHEAD CONSOLE (IF EQUIPPED)

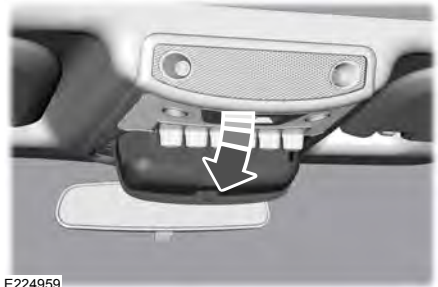

E224959

Press near the rear edge of the door to open it.

UNDER SEAT STORAGE (IF EQUIPPED)

Front Under Seat Storage Compartment - Vehicles Without Locking Storage



Lift the latch to open the lid and access to the storage compartment under the center seat cushion.

Storage Compartments

Front Under Seat Storage Compartment - Vehicles With Locking Storage

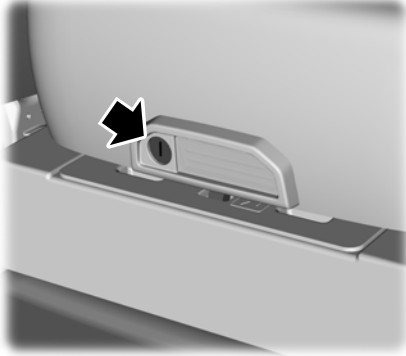

1. Use the key in the remote control to unlock. See **Remote Control** (page 55).

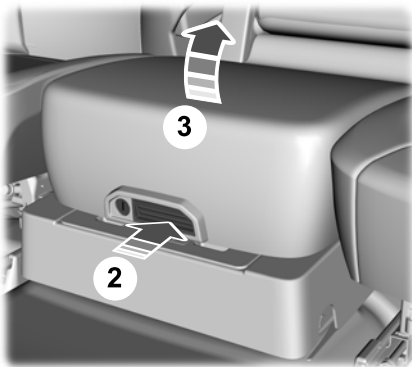

2. Press the latch to release the cushion.
3. Lift the cushion to access the storage compartment.

Rear Under Seat Storage (If Equipped)



1. Lift the rear seat to access the under seat storage bin.

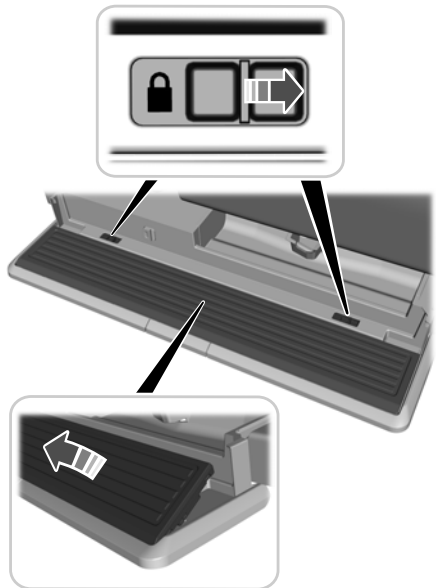

Storage Compartments

2. Lift the front and side panels to expand and lock them in place.

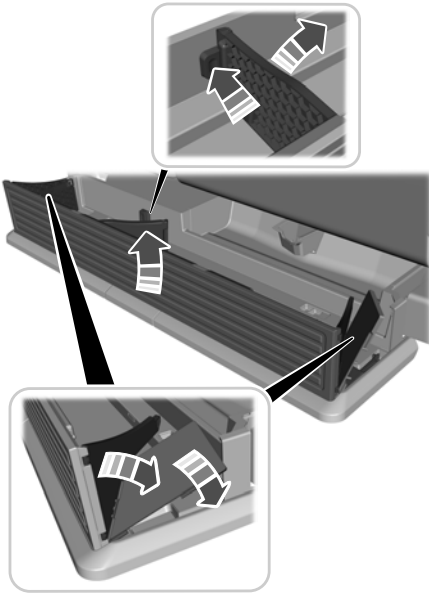

3. Lock the panels in an open position.

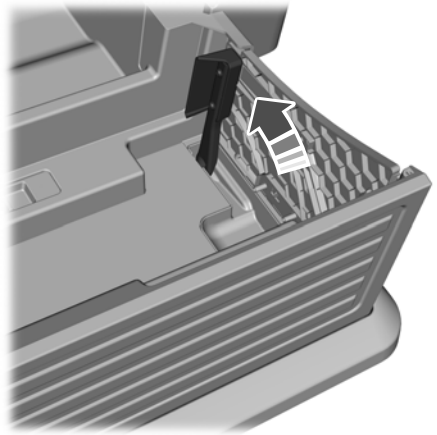

4. To collapse, release the lever, push down to the stowed position and fold in the side and front panels.

Note: Make sure the storage divider is not locked into place when collapsing. Push the button to release the divider door and swing it to the stowed position on the front wall.

Starting and Stopping the Engine

GENERAL INFORMATION

WARNING: Extended idling at high engine speeds can produce very high temperatures in the engine and exhaust system, creating the risk of fire or other damage.

WARNING: Do not park, idle or drive your vehicle on dry grass or other dry ground cover. The emission system heats up the engine compartment and exhaust system, creating the risk of fire.

WARNING: Do not start the engine in a closed garage or in other enclosed areas. Exhaust fumes can be toxic. Always open the garage door before you start the engine.

WARNING: Exhaust leaks may result in entry of harmful and potentially lethal fumes into the passenger compartment. If you smell exhaust fumes inside your vehicle, have your vehicle inspected immediately. Do not drive if you smell exhaust fumes.

If you disconnect the battery, your vehicle may exhibit some unusual driving characteristics for approximately 5.0 mi (8 km) after you reconnect it. This is because the engine management system must realign itself with the engine. You can disregard any unusual driving characteristics during this period.

The powertrain control system meets all Canadian interference-causing equipment standard requirements regulating the impulse electrical field or radio noise.

When you start the engine, avoid pressing the accelerator pedal before and during operation. Only use the accelerator pedal when you have difficulty starting the engine.

If your vehicle is operated in a heavy snow storm or blowing snow conditions, the engine air induction may become partially clogged with snow and ice. If this occurs, the engine may experience a significant reduction in power output. At the earliest opportunity, clear all the snow and ice away from the air induction inlet.

IGNITION SWITCH

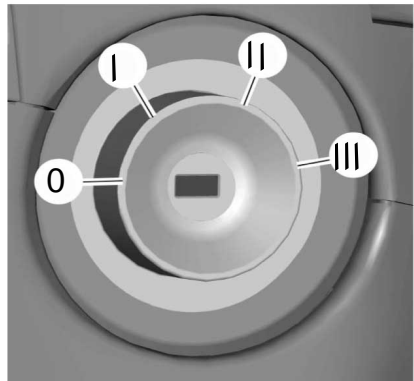

E252522

0 (off) - The ignition is off.

Note: When you switch the ignition off and leave your vehicle, do not leave your key in the ignition. This could cause your vehicle battery to lose charge.

I (accessory) - Allows the electrical accessories, such as the radio, to operate while the engine is not running.

Note: Do not leave the ignition key in this position for too long. This could cause your vehicle battery to lose charge.

II (on) - All electrical circuits are operational and the warning lamps and indicators illuminate.

III (start) - Cranks the engine.

Starting and Stopping the Engine

KEYLESS STARTING (IF EQUIPPED)

Note: The keyless starting system may not function if the key is close to metal objects or electronic devices such as cellular phones.

Note: A valid key must be located inside your vehicle to switch the ignition on and start the engine.



E144447

The keyless starting system has three modes:

Off: Turns the ignition off.

- Without applying the clutch pedal for manual transmissions, or brake pedal for automatic transmissions, press and release the button once when the ignition is in the on mode, or when the engine is running but the vehicle is not moving.

On: All electrical circuits are operational and the warning lamps and indicators illuminate.

- Without applying the clutch pedal for manual transmissions, or brake pedal for automatic transmissions, press and release the button once.

Start: Starts the vehicle.

- Press the clutch pedal for manual transmissions, or brake pedal for automatic transmissions, and then press the button for any length of time. An indicator light on the button illuminates when the ignition is on and when the engine starts.

STARTING A GASOLINE ENGINE - 6.2L/7.3L

When you start the engine, the idle speed increases. This helps to warm up the engine.

If the engine idle speed does not slow down, see an authorized dealer.

Before starting the engine check the following:

- Make sure all occupants fasten their seat belt.
- Make sure the headlamps and electrical accessories are off.
- Make sure the parking brake is on.
- Make sure the transmission is in park (P).
- Turn the ignition key to the on position.

Note: Do not touch the accelerator pedal.

- Fully press the brake pedal.
- Turn the key to the start position to start your vehicle.
- When the engine starts, release the key and then gradually release the brake pedal as the engine speed increases.

Note: The engine may continue cranking for up to 15 seconds or until it starts.

Note: If you cannot start the engine on the first try, wait for a short period and try again.

Vehicles with an Ignition Key

Note: Do not touch the accelerator pedal.

- Fully press the brake pedal.

Starting and Stopping the Engine

2. Turn the key to position **III** to start the engine.
3. When the engine starts, release the brake pedal.

Do not crank the engine for more than 10 seconds as starter damage may occur. If the engine does not start, switch the ignition off and wait 30 seconds before trying again.

Vehicles with Keyless Start

Note: Do not touch the accelerator pedal.

Note: If you press the push button ignition switch again prior to the engine starting, the ignition switches to accessory mode and will not start.

Note: If you release the brake pedal before the engine starts, follow the engine start sequence again.

1. Fully press the brake pedal.
2. Press the center of the push button ignition switch.
3. When the engine starts, release the brake pedal.

Failure to Start

If you cannot start the engine after three attempts, wait 10 seconds and follow this procedure:

1. Fully press the brake pedal.
2. Fully press the accelerator pedal and hold it there.
3. Start the engine.

Stopping the Engine When Your Vehicle is Stationary

1. When your vehicle has stopped, shift into park (P) and switch the ignition off.
2. Apply the parking brake.

Stopping the Engine When Your Vehicle is Moving



WARNING: Switching off the engine when your vehicle is still moving results in a significant decrease in braking assistance. Higher effort is required to apply the brakes and to stop your vehicle. A significant decrease in steering assistance could also occur. The steering does not lock, but higher effort could be required to steer your vehicle. When you switch the ignition off, some electrical circuits, for example airbags, also turn off. If you unintentionally switch the ignition off, shift into neutral (N) and restart the engine.

1. Put the transmission into neutral (N) and use the brakes to bring your vehicle to a safe stop.
2. When your vehicle has stopped, shift into park (P) and switch the ignition off.
3. Apply the parking brake.

Automatic Engine Shutdown

If your vehicle has a keyless ignition, it has a feature that shuts down the engine if it has been idling for an extended period of time. The ignition also turns off in order to save battery power. Before the engine shuts down, a message appears in the information display showing a timer counting down from 30 seconds. If you do not intervene within 30 seconds, the engine shuts down. Another message appears in the information display to inform you that the engine has shut down in order to save fuel. Start your vehicle as you normally do.

Starting and Stopping the Engine

Cold Weather Starting (Flexible Fuel Vehicles Only)

The starting characteristics of all grades of E85 ethanol make it unsuitable for use when ambient temperatures fall below 0°F (-18°C). Consult your fuel distributor for the availability of winter grade ethanol. As the outside temperature approaches freezing, ethanol fuel distributors should supply winter grade ethanol, the same as with unleaded gasoline.

If summer grade ethanol is used in cold weather conditions, 0°F (-18°C), you may experience increased cranking times, rough idle or hesitation until the engine has warmed up.

You may experience a decrease in performance when the engine is cold when operating on E85 ethanol.

Do not use starting fluid such as ether in the air intake system. Such fluid could cause immediate explosive damage to the engine and possible personal injury.

If you should experience cold weather starting problems on E85 ethanol, and neither an alternative brand of E85 ethanol nor an engine block heater is available, the addition of unleaded gasoline to your tank improves cold starting performance. Your vehicle is designed to operate on E85 ethanol alone, unleaded gasoline alone, or any mixture of the two.

If the Engine Fails to Start Using the Preceding Instructions (Flexible Fuel Vehicles Only)

1. Press the accelerator pedal down one-third to one-half of its travel, and then crank the engine.
2. When the engine starts, release the key, then gradually release the accelerator pedal as the engine speed increases. If the engine still does not start, repeat Step 1.

Guarding Against Exhaust Fumes



WARNING: Exhaust leaks may result in entry of harmful and potentially lethal fumes into the passenger compartment. If you smell exhaust fumes inside your vehicle, have your vehicle inspected immediately. Do not drive if you smell exhaust fumes.

Important Ventilating Information

If you stop your vehicle and then leave the engine idling for long periods of time, we recommend that you do one of the following:

- Open the windows at least 1 in (2.5 cm).
- Set your climate control to outside air.

STARTING A DIESEL ENGINE - 6.7L DIESEL

Read all starting instructions carefully before you start your vehicle.

For temperatures below 32°F (0°C), the use of the correct grade engine oil is essential for proper operation. Refer to engine oil specifications for more information. See **Engine Block Heater** (page 182).

Your vehicle may have a cold weather starting strategy that prevents severe engine damage by assisting in engine lubrication warm-up. In extremely cold ambient temperatures, this strategy activates and prevents the accelerator pedal from being used for 30 seconds after you start your vehicle. A message appears in the information display as your vehicle warms up. By not allowing the accelerator pedal to be used, the engine oil is allowed to properly lubricate the bearings

Starting and Stopping the Engine

preventing engine damage due to lack of proper lubrication. After the 30 second warm-up period, the accelerator pedal becomes operational again and a message appears informing you the vehicle is ok to drive.

When you start the engine in extremely cold temperatures -15°F (-26°C), we recommend that you allow the engine to idle for several minutes before you drive the vehicle.

Before starting the engine check the following:

- Make sure all occupants fasten their seatbelt.
- Make sure the headlamps and electrical accessories are off.
- Make sure the parking brake is on.
- Make sure the transmission is in park (P).

Note: *Do not press the accelerator during starting.*

Vehicles with an Ignition Key

Note: *Do not touch the accelerator pedal.*

1. Fully press the brake pedal.
2. Turn the key to position **II**

Note: *A message appears: Engine Start Pending, Please Wait.*

3. Wait until the engine glow-plug indicator turns off.
4. Turn the key to position **III** to start the engine.
5. When the engine starts, release the brake pedal.

Do not crank the engine for more than 10 seconds as starter damage may occur. If the engine does not start, switch the ignition off and wait 30 seconds before trying again.

Vehicles with Keyless Start

Note: *Do not touch the accelerator pedal.*

Note: *If the push button ignition switch is pressed again prior to the engine starting, the ignition switches to accessory mode and does not start.*

Note: *If you release the brake pedal before the engine starts, follow the engine start sequence again.*

1. Fully press the brake pedal.
2. Press the center of the push button ignition switch.

Note: *A message appears: Engine Start Pending, Please Wait.*

3. When the engine starts, release the brake pedal.

Diesel Engine Fast Start Glow Plug System

The diesel engine glow system consists of:

- Eight glow plugs, one per cylinder.
- Glow Plug Control Module.
- Engine Coolant Temperature sensor.
- Barometric pressure sensor.
- Environmental temperature sensor.

The powertrain and glow plug control modules electronically control the glow plug system. After you switch the ignition on, the glow plug control module immediately energizes the glow plugs. The glow plug control module uses the engine coolant temperature, barometric pressure sensor and environmental temperature sensor to determine how long the glow plugs stay energized. The required time for the glow plugs to be energized decreases as the coolant temperature, barometric pressure and environmental temperature increase.

Starting and Stopping the Engine

Automatic Engine Shutdown

If your vehicle is equipped with a keyless ignition, it has a feature that automatically shuts down the engine if it has been idling for an extended period. The ignition also turns off in order to save battery power. Before the engine shuts down, a message appears in the information display showing a timer counting down from 30 seconds. If you do not intervene within 30 seconds, the engine shuts down. Another message appears in the information display to inform you that the engine has shut down in order to save fuel. Start your vehicle as you normally do.

Cold Weather Starting



WARNING: Do not use starting fluid, for example ether, in the air intake system. Such fluid could cause immediate explosive damage to the engine and possible personal injury.



WARNING: Do not mix diesel with gasoline, gasohol or alcohol. This could cause an explosion.

We recommend that the engine block heater be used for starting when the temperature is -9°F (-23°C) or colder. See **Engine Block Heater** (page 182).

When operating in cold weather, you may use Motorcraft® cetane improvers or non-alcohol-based cetane improvers from a reputable manufacturer as needed.



Switch the ignition on. Do not start the engine until the glow-plug indicator turns off.

When the glow plug pre-heat indicator turns off, turn the key to start. After you start the engine, the glow plugs may remain on for a period. If you do not start the engine before the glow plug activation time ends, you need to reset the glow plugs by switching the ignition off. After the engine starts, allow it to idle for about 15 seconds. This protects the engine. Do not increase engine speed until the oil pressure gauge indicates normal pressure.

Cold Weather Operation

Note: *Idling in cold weather does not heat the engine to its normal operating temperature. Long periods of idling, especially in cold weather, can cause a buildup of deposits which can cause engine damage.*

Change to a lighter grade engine oil to make starting easier under these conditions. Refer to engine oil specifications. See **Engine Block Heater** (page 182).

Diesel fuel is adjusted seasonally for cold temperatures. Diesel fuel which has not been properly formulated for the ambient conditions may gel which can clog the fuel filters. One indication that the fuel filter(s) may be clogged is if the engine starts, stalls after a short time, and then does not restart. If you have been using biodiesel, you may need to use a fuel with lower biodiesel content, try another brand, or discontinue using biodiesel. Do not use alcohol based additives to correct fuel gelling. This may result in damage to the fuel injectors and system. Use the proper anti-gel and performance improvement product. See **Engine Block Heater** (page 182).

Starting and Stopping the Engine

Your vehicle has a fuel and water separator that recirculates fuel from the engine to help prevent fuel filter clogging. To avoid engine fuel starvation during cold weather operation of 32°F (0°C) or below, we recommend that the fuel level in your tank should not drop below ¼ full. This helps prevent air from entering the fuel system and stalling the engine.

Your vehicle has a selective catalytic reduction system that uses Diesel Exhaust Fluid (DEF) to operate properly. You need to replenish your vehicle's DEF at certain intervals. When filling your vehicle's DEF tank in cold weather, take special care to prevent damage to the tank. See **Selective Catalytic Reductant System** (page 197).

In cold weather below 32°F (0°C), the engine may slowly increase to a higher idle speed if you leave it idling in park (P). As the engine warms-up, the engine sound level decreases due to the activation of PCM-controlled sound reduction features.

If you operate your vehicle in a heavy snowstorm or blowing snow conditions, snow and ice can clog the engine air induction. If this occurs, the engine may experience a significant reduction in power output. At the earliest opportunity, clear all the snow and ice away from inside the air filter assembly. Remove the air cleaner cover and the air filter and remove any snow or ice. Remove any debris, snow or ice, on the foam filter by brushing the surface with a soft brush. Once you have cleared all of the debris, reinstall the air filter and cover.

Do not use water, solvents, or a hard brush for cleaning the foam filter.



WARNING: To reduce the risk of vehicle damage and personal burn injuries, do not start your engine with the air cleaner removed and do not remove it while the engine is running.

In order to operate the engine in temperatures of 32°F (0°C) or lower, read the following instructions:

- Make sure that the batteries are of sufficient size and are fully charged. Check other electrical components to make sure they are in optimum condition.
- Use the proper coolant solution at the concentration recommended protecting the engine against damage from freezing.
- Try to keep the fuel tank full as much as possible at the end of operation to prevent condensation in the fuel system.
- Make sure you use proper cold weather engine oil and that it is at its proper level. Also, if necessary, make sure to follow the engine oil and filter change schedule found under the Special operating conditions section listed in the scheduled maintenance information.
- At temperatures of -9°F (-23°C) or below, it is recommended that you use an engine block heater to improve cold engine starting.
- If operating in arctic temperatures of -20°F (-29°C) or lower, consult your truck dealer for information about special cold weather equipment and precautions.

Starting and Stopping the Engine

We recommend the following cold weather idling guidelines:

- You can use Motorcraft® cetane improvers or non-alcohol-based cetane improvers from a reputable manufacturer as needed.
- Maintain the engine cooling system properly.
- Avoid shutting the engine down after an extensive idling period. Drive your vehicle for several miles with the engine at normal operating temperatures under a moderate load.
- Consider using an engine block heater.
- For extended idle times use an approved idle speed increase device.

Winter Operating Tips for Arctic Operation -20°F (-29°C) and Below

The following information is a guideline only and is not to be the only source of possible solutions in resolving extreme cold temperature issues.

Starting Aids



WARNING: Do not use starting fluid, for example ether, in the air intake system. Such fluid could cause immediate explosive damage to the engine and possible personal injury.

The use of the factory engine block heater assists in engine starting in extreme cold ambient temperatures. See **Engine Block Heater** (page 182).

Idle Control

Your vehicle may have a factory option for a stationary elevated idle control through the upfitter switches in the overhead console. This allows the operator to elevate the idle RPM for extended idle periods, as well as aftermarket equipment such as PTO operation. You must configure this feature even if ordered from the factory. See your authorized dealer for required upfitting.

Operation in Snow and Rain

Vehicle operation in heavy snowfall or extreme rain conditions may feed excessive amounts of snow or water into the air intake system. This could plug the air filter with snow and may cause the engine to lose power and possibly shut down.

We recommend the following actions after operating your vehicle up to 200 mi (320 km) in snowfall or extreme rain:

- Snow: At the earliest opportunity, open the hood and clear all the snow and ice from the air filter housing inlet (do not remove the foam filter) and reset the air filter restriction gauge.

Note: *Removal of the foam filter degrades your vehicle performance during snow and hot weather conditions.*

- Extreme rain: The air filter dries after about 15–30 minutes at highway speeds. At the earliest opportunity, open the hood and reset the air filter restriction gauge.

Refer to Air filter and restriction gauge in the Maintenance chapter for more information. See **Changing the Engine Air Filter** (page 352).

Starting and Stopping the Engine

Operation in Standing Water

Ingestion of water into the diesel engine can result in immediate and severe damage to the engine. If driving through water, slow down to avoid splashing water into the intake. If the engine stalls, and you suspect ingestion of water into the engine, do not try to restart the engine. Consult your dealer for service immediately.

Your fuel tank vents to the atmosphere by valves on top of the tank and through the fuel cap. If water reaches the top of the tank, the valves may pull water into the fuel tank. Water in the fuel can cause performance issues and damage the fuel injection system.

SWITCHING OFF THE ENGINE - 6.7L DIESEL

Switch the ignition off.

To help prolong engine life, we recommend you allow the engine to idle for three to five minutes, especially after any of the following:

- Continuous engine speed.
- High ambient temperature.
- High GVW or GCW operation, for example heavy loads or trailers.

This allows the turbo charged engine to cool down.

ENGINE IDLE SHUTDOWN

Your vehicle may be equipped with an engine idle shutdown system. This system automatically shuts down your engine when it has been idling in **P** (Park) or **N** (Neutral) for five minutes (parking brake set) or 15 minutes (parking brake not set). When the engine idle shutdown process has started:

- A chime sounds and the information display will show ENGINE TURNS OFF IN 30 (seconds) and start counting down
- You can restart the five or 15-minute timer by changing the position of the accelerator pedal, brake pedal or the park brake within the final 30 seconds
- When the timer reaches zero, the engine shuts down and this message will appear in your information display ENGINE TURNED OFF
- One minute after the engine has shut down, the electrical system simulates key off, even though the ignition is still in the on position, initiating normal accessory delay period
- You must move the ignition to the off position to reset the system before restarting your vehicle.

The engine idle shutdown idle timer does not start if:

- The engine is operating in power take-off mode.
- The engine coolant temperature is below 60°F (16°C).
- The exhaust emission control device is regenerating.

ENGINE BLOCK HEATER (IF

EQUIPPED)



WARNING: Failure to follow engine block heater instructions could result in property damage or serious personal injury.



WARNING: Do not use your heater with ungrounded electrical systems or two-pronged adapters. There is a risk of electrical shock.

Starting and Stopping the Engine

Note: *The heater is most effective when outdoor temperatures are below 0°F (-18°C).*

For cold climates that are below 0°F (-18°C) needing a temporary battery installation. Order the cold climate pack.

The heater acts as a starting aid by warming the engine coolant. This allows the climate control system to respond quickly. The equipment includes a heater element (installed in the engine block) and a wire harness. You can connect the system to a grounded 120-volt AC electrical source.

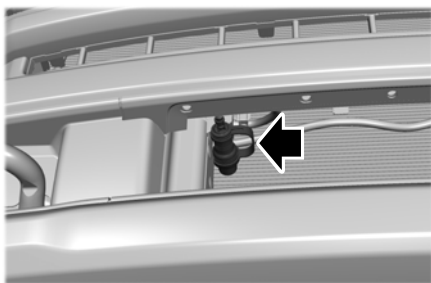

We recommend that you do the following for a safe and correct operation:

- Make sure your vehicle is parked in a clean area, clear of combustibles.
- Locate the block heater cord near the center of the lower front fascia.
- Use a 16-gauge outdoor extension cord that is product certified by Underwriter's Laboratory (UL) or Canadian Standards Association (CSA). This extension cord must be suitable for use outdoors, in cold temperatures, and be clearly marked Suitable for Use with Outdoor Appliances. Do not use an indoor extension cord outdoors. This could result in an electric shock or become a fire hazard.

- Use as short an extension cord as possible.
- Do not use multiple extension cords.
- Make sure that when in operation, the extension cord plug and heater cord plug connections are free and clear of water. This could cause an electric shock or fire.
- Make sure the heater, heater cord and extension cord are firmly connected.
- Check for heat anywhere in the electrical hookup once the system has been operating for approximately 30 minutes.
- Make sure the system is unplugged and properly stowed before starting and driving your vehicle. Make sure the protective cover seals the prongs of the block heater cord plug when not in use.
- Make sure the heater system is checked for proper operation before winter.

Using the Engine Block Heater

Make sure the receptacle terminals are clean and dry prior to use. Clean them with a dry cloth if necessary.

The heater uses 0.4 to 1.0 kilowatt-hours of energy per hour of use. The system does not have a thermostat. It achieves maximum temperature after approximately three hours of operation. Using the heater longer than three hours does not improve system performance and unnecessarily uses electricity.

Fuel and Refueling

SAFETY PRECAUTIONS



WARNING: Do not overfill the fuel tank. The pressure in an overfilled tank may cause leakage and lead to fuel spray and fire.



WARNING: The fuel system may be under pressure. If you hear a hissing sound near the fuel filler inlet, do not refuel until the sound stops. Otherwise, fuel may spray out, which could cause serious personal injury.



WARNING: Automotive fuels can cause serious injury or death if misused or mishandled.



WARNING: Flow of fuel through a fuel pump nozzle can produce static electricity. This can cause a fire if you are filling an ungrounded fuel container.



WARNING: Fuel may contain benzene, which is a cancer-causing agent.



WARNING: When refueling always shut the engine off and never allow sparks or open flames near the fuel tank filler valve. Never smoke or use a cell phone while refueling. Fuel vapor is extremely hazardous under certain conditions. Avoid inhaling excess fumes.

Observe the following guidelines when handling automotive fuel:

- Extinguish all smoking materials and any open flames before refueling your vehicle.
- Always turn off the vehicle before refueling.

- Automotive fuels can be harmful or fatal if swallowed. Fuel such as gasoline is highly toxic and if swallowed can cause death or permanent injury. If fuel is swallowed, call a physician immediately, even if no symptoms are immediately apparent. The toxic effects of fuel may not be visible for hours.
- Avoid inhaling fuel vapors. Inhaling too much fuel vapor of any kind can lead to eye and respiratory tract irritation. In severe cases, excessive or prolonged breathing of fuel vapor can cause serious illness and permanent injury.
- Avoid getting fuel liquid in your eyes. If fuel is splashed in the eyes, remove contact lenses (if worn), flush with water for 15 minutes and seek medical attention. Failure to seek proper medical attention could lead to permanent injury.
- Fuels can also be harmful if absorbed through the skin. If fuel is splashed on the skin, clothing or both, promptly remove contaminated clothing and wash skin thoroughly with soap and water. Repeated or prolonged skin contact with fuel liquid or vapor causes skin irritation.
- Be particularly careful if you are taking Antabuse or other forms of Disulfiram for the treatment of alcoholism. Breathing gasoline vapors could cause an adverse reaction, serious personal injury or sickness. If fuel is splashed on the skin, wash the affected areas immediately with plenty of soap and water. Consult a physician immediately if you experience any adverse reactions.

Fuel and Refueling

FUEL QUALITY - E85

Choosing the Right Fuel - Flex Fuel Vehicles

Flex fuel vehicles have one of the following identifiers:

- Yellow fuel filler cap.
- Yellow bezel around the fuel filler inlet.
- Yellow fuel filler housing.
- Yellow E85 label on the fuel tank filler door.

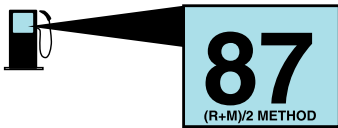

E161513

Your vehicle is designed to operate on regular unleaded gasoline with a minimum pump (R+M)/2 octane rating of 87 or regular unleaded gasoline blended with a maximum of 85% ethanol (E85).

Some fuel stations, particularly those in high altitude areas, offer fuels posted as regular unleaded gasoline with an octane rating below 87. The use of these fuels could result in engine damage that will not be covered by the vehicle warranty.

For best overall vehicle and engine performance, premium fuel with an octane rating of 91 or higher is recommended. The performance gained by using premium fuel is most noticeable in hot weather as well as other conditions, for example when towing a trailer. See **Towing** (page 277).

Do not be concerned if the engine sometimes knocks lightly. However, if the engine knocks heavily while using fuel with the recommended octane rating, contact an authorized dealer to prevent any engine damage.

We recommend Top Tier detergent gasolines, where available to help minimize engine deposits and maintain optimal vehicle and engine performance. For additional information, refer to www.toptiergas.com.

Note: *Use of any fuel for which the vehicle was not designed can impair the emission control system, cause loss of vehicle performance, and cause damage to the engine which may not be covered by the vehicle Warranty.*

Do not use:

- Diesel fuel.
- Fuels containing kerosene or paraffin.
- Fuels containing more than 85% ethanol or E100 fuel.
- Fuels containing methanol.
- Fuels containing metallic-based additives, including manganese-based compounds.
- Fuels containing the octane booster additive, methylcyclopentadienyl manganese tricarbonyl (MMT).
- Leaded fuel, using leaded fuel is prohibited by law.

The use of fuels with metallic compounds such as methylcyclopentadienyl manganese tricarbonyl (commonly known as MMT), which is a manganese-based fuel additive, will impair engine performance and affect the emission control system.

Fuel and Refueling

Switching Between E85 and Gasoline

We do not recommend repeatedly alternating between E85 and gasoline. If you switch from using E85 to gasoline, or from gasoline to E85, add as much fuel as possible, at least half a tank. Drive your vehicle immediately for a minimum of 5 mi (8 km) to allow it to adapt to the change in ethanol concentration. If you use E85 exclusively, we recommend that you fill the fuel tank with regular unleaded gasoline at each scheduled oil change.

FUEL QUALITY - GASOLINE

Choosing the Right Fuel

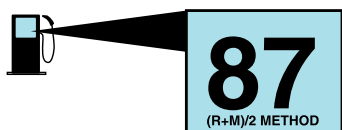

E161513

Your vehicle is designed to operate on regular unleaded gasoline with a minimum pump (R+M)/2 octane rating of 87.

Some fuel stations, particularly those in high altitude areas, offer fuels posted as regular unleaded gasoline with an octane rating below 87. The use of these fuels could result in engine damage that will not be covered by the vehicle warranty.

For best overall vehicle and engine performance, premium fuel with an octane rating of 91 or higher is recommended. The performance gained by using premium fuel is most noticeable in hot weather as well as other conditions, for example when towing a trailer. See **Towing** (page 277).

Do not be concerned if the engine sometimes knocks lightly. However, if the engine knocks heavily while using fuel with the recommended octane rating, contact an authorized dealer to prevent any engine damage.

We recommend Top Tier detergent gasolines, where available to help minimize engine deposits and maintain optimal vehicle and engine performance. For additional information, refer to www.toptiergas.com.

Note: *Use of any fuel for which the vehicle was not designed can impair the emission control system, cause loss of vehicle performance, and cause damage to the engine which may not be covered by the vehicle Warranty.*

Do not use:

- Diesel fuel.
- Fuels containing kerosene or paraffin.
- Fuel containing more than 15% ethanol or E85 fuel.
- Fuels containing methanol.
- Fuels containing metallic-based additives, including manganese-based compounds.
- Fuels containing the octane booster additive, methylcyclopentadienyl manganese tricarbonyl (MMT).
- Leaded fuel, using leaded fuel is prohibited by law.

The use of fuels with metallic compounds such as methylcyclopentadienyl manganese tricarbonyl (commonly known as MMT), which is a manganese-based fuel additive, will impair engine performance and affect the emission control system.

Fuel and Refueling

FUEL QUALITY - DIESEL

Fuel Requirements - Choosing The Right Fuel: Vehicles Operated Where Ultra Low Sulfur Diesel Fuel Is Required (United States/Canada/Puerto Rico/U.S. Virgin Islands And Other Locales)

Note: *Your warranty will not cover damage caused by using an improper type of fuel or fuel additive.*

Note: *Do not blend used engine oil with diesel fuel under any circumstances. Blending used oil with the fuel will significantly increase your vehicle's exhaust emissions and reduce engine life due to increased internal wear.*

We recommend Top Tier diesel fuel where available to help minimize engine deposits and maintain optimal vehicle and engine performance. For additional information, refer to www.toptiergas.com.

You should use Ultra-Low Sulfur Diesel fuel (also known as ULSD) designated as number 1-D or 2-D with a maximum of 15-ppm sulfur in your diesel vehicle. You may operate your vehicle on diesel fuels containing up to 20% biodiesel, also known as B20. These fuels should meet the ASTM D975 diesel or the ASTM D7467 B6-B20 biodiesel industry specifications. Outside of North America, use fuels meeting EN590 or equivalent local market standard.



Using low sulfur diesel fuel (16-500 ppm) or high sulfur diesel fuel (greater than 500 ppm) in your diesel engine will cause certain emission components to malfunction which may also cause the service engine soon light to illuminate indicating an emissions-related concern.

Diesel fuel is adjusted seasonally for cold temperature. For best results at temperatures below 19°F (-7°C), we recommended using a diesel fuel which has been seasonally adjusted for the ambient conditions.

Fuel Requirements - Choosing The Right Fuel: Vehicles Operated Where Ultra Low Sulfur Diesel Fuel Is Not Required

For the engine to operate reliably on low-sulfur or high-sulfur diesel fuel, the engine must be a factory built high-sulfur engine (available as a dealer order option for select markets) or an ultra low sulfur diesel fuel configured engine that has been retrofitted for high-sulfur diesel fuel using Ford Motor Company dealer service parts. Failure to use retrofit components other than those available through your authorized dealer will result in coolant system damage, engine overheating, selective catalyst reduction system or diesel particulate filter damage and possible base engine damage.

Use only a diesel engine configured for use with high sulfur diesel fuel in markets with diesel fuel that has sulfur content greater than 15 ppm. Using low sulfur diesel fuel (16–500 ppm) or high sulfur diesel fuel (greater than 500 ppm) in a diesel engine designed to use only Ultra Low Sulfur Diesel fuel may result in damage to engine emission control devices and the aftertreatment system, potentially rendering the vehicle inoperable.

Vehicles with engines configured for use with high sulfur diesel fuel are only available for sale in countries where ultra low sulfur diesel fuel is generally not available or mandated by the government. Vehicles originally sold in a ultra low sulfur diesel fuel market that are subsequently

Fuel and Refueling

exported to non- ultra low sulfur diesel fuel markets will need to be retrofitted at the customer's expense using Ford authorized dealer service parts in order to be reliably operated on non- ultra low sulfur diesel fuel.

Biodiesel



WARNING: Do not mix diesel with gasoline, gasohol or alcohol. This could cause an explosion.

Note: *Do not use home heating oil, agricultural fuel, raw fats and oils, waste cooking greases, biodiesel greater than 20% or any diesel not intended for highway use. Damage to the fuel injection system, engine and exhaust catalyst, and diesel particulate filter can occur if you use an improper fuel. Red dye is used to identify fuels intended for agricultural and non-highway use.*

You may operate your vehicle on diesel fuels containing up to 20% biodiesel, also known as B20.

Biodiesel fuel is a chemically converted product from renewable fuel sources, such as vegetable oils, animal fats and waste cooking greases.

To help achieve acceptable engine performance and durability when using biodiesel in your vehicle:

- Confirm the biodiesel content of the fuel to be B20 (20% biodiesel) or less
- Only use biodiesel fuel of good quality that complies with industry standards
- Follow the recommended service maintenance intervals. See **Normal Scheduled Maintenance** (page 560).

- Do not store biodiesel fuel in the fuel tank for more than 1 month
- Consider changing brands or reducing biodiesel content if you have cold temperature fuel gelling issues or a frequent LOW FUEL PRESSURE message appearing

Use of biodiesel in concentrations greater than 20% may cause damage to your vehicle, including engine and/or exhaust after-treatment hardware (exhaust catalyst and particulate filter) failures. Concentrations greater than 20% can also cause fuel filter restrictions that may result in a lack of power or damage to fuel system components, including fuel pump and fuel injector failures.

We recommend SAE 5W-40 oil for fuels with greater than 5% biodiesel (B5). For more information about oil change intervals and other maintenance when operating on biodiesel. See **Special Operating Conditions Scheduled Maintenance** (page 566).

Look for a label on the fuel pump to confirm the amount of biodiesel contained in a diesel fuel. Biodiesel content is often indicated with the letter B followed by the percent of biodiesel in the fuel. For example, B20 indicates a fuel containing 20% biodiesel. Ask the service station attendant to confirm the biodiesel content of a diesel fuel if you do not see a label on the fuel pump.

Biodiesel fuels degrade more easily than diesel fuels not containing biodiesel and should not be stored in the fuel tank for more than 1 month. If you plan to park or store your vehicle for more than 1 month, then you should empty your vehicle fuel tank of biodiesel fuel. You should fill the tank with a pure petroleum-based diesel fuel and run your vehicle for a minimum of 30 minutes.

Fuel and Refueling

Note: *Degraded or oxidized biodiesel can damage fuel system seals and plastics and corrode steel parts.*

During cold weather, if you have problems operating on biodiesel, you may need to use a diesel fuel with lower biodiesel content, try another brand, or discontinue the use of biodiesel.

Diesel Fuel Additives

It should not be necessary to add any aftermarket additives to your fuel if you use a high quality diesel fuel that conforms to ASTM industry specifications. Aftermarket additives can damage the fuel injector system or engine.

Use Motorcraft® cetane booster or an equivalent cetane booster additive if you suspect fuel has low cetane. Use Motorcraft® anti-gel & performance improver or an equivalent additive if there is fuel gelling.

Do not use alcohol-based additives to improve cetane quality, to prevent fuel gelling or any other use. The use of alcohol additives may result in damage to the fuel injectors and system. See **Engine Specifications** (page 433).

Your warranty may not cover repairs needed to correct the effects of using an aftermarket product that does not meet Ford specifications in your fuel.

RUNNING OUT OF FUEL



WARNING: Flow of fuel through a fuel pump nozzle can produce static electricity. This can cause a fire if you are filling an ungrounded fuel container.

Avoid running out of fuel because this situation may have an adverse effect on engine components.

If you have run out of fuel:

- You may need to cycle the ignition from off to on several times after refueling to allow the fuel system to pump the fuel from the tank to the engine. On restarting, cranking time will take a few seconds longer than normal. With keyless ignition, just start the engine. Crank time will be longer than usual.
- Normally, adding 1 gal (4 L) of fuel is enough to restart the engine. If the vehicle is out of fuel and on a steep grade, more than 1 gal (4 L) may be required.

REFUELING - GASOLINE



WARNING: When refueling always shut the engine off and never allow sparks or open flames near the fuel tank filler valve. Never smoke or use a cell phone while refueling. Fuel vapor is extremely hazardous under certain conditions. Avoid inhaling excess fumes.



WARNING: Fuel vapor burns violently and a fuel fire can cause severe injuries.



WARNING: Read and follow all the instructions on the pump island.



WARNING: Stay outside your vehicle and do not leave the fuel pump unattended when refueling your vehicle.



WARNING: Keep children away from the fuel pump. Never let children pump fuel.



WARNING: Wait at least five seconds before removing the fuel pump nozzle to allow any residual fuel to drain into the fuel tank.

Fuel and Refueling



WARNING: Stop refueling after the fuel pump nozzle automatically shuts off for the second time. Failure to follow this will fill the expansion space in the fuel tank and could lead to fuel overflowing.



WARNING: Do not remove the fuel pump nozzle from its fully inserted position when refueling.

Use the following guidelines to avoid electrostatic charge build-up when filling an ungrounded fuel container:

- Place approved fuel container on the ground.
- Do not fill a fuel container while it is in the vehicle - including the cargo area.
- Keep the fuel pump nozzle in contact with the fuel container while filling.
- Do not use a device that would hold the fuel pump handle in the fill position.

Fuel Filler Cap



WARNING: The fuel system may be under pressure. If you hear a hissing sound near the fuel filler inlet, do not refuel until the sound stops. Otherwise, fuel may spray out, which could cause serious personal injury.

Note: If you must replace the fuel filler cap, replace it with a fuel filler cap designed for your vehicle. The vehicle warranty may be void for any damage to the fuel tank or fuel system if you do not use the correct genuine Ford or Motorcraft® fuel filler cap.

When fueling your vehicle:

1. Put your vehicle in park (P).
2. Switch the engine off.

3. Carefully turn the filler cap counterclockwise until it spins off.
4. Pull to remove the cap from the fuel filler pipe.
5. To install the cap, align the tabs on the cap with the notches on the filler pipe.
6. Turn the filler cap clockwise until it clicks at least once.

If the Check Fuel Cap light or a Check Fuel Cap message appears in the instrument cluster and stays on after you start the engine, you may not have installed the fuel filler properly.

If the fuel cap light remains on, at the next opportunity, safely pull off of the road, remove the fuel filler cap, align the cap properly and reinstall it. The check fuel cap light or Check fuel cap message may not reset immediately. It may take several driving cycles for the indicators to turn off. A driving cycle consists of an engine start-up, after four or more hours with the engine off, followed by normal city and highway driving.

REFUELING - DIESEL



WARNING: Read and follow all the instructions on the pump island.



WARNING: Stay outside your vehicle and do not leave the fuel pump unattended when refueling your vehicle.



WARNING: Keep children away from the fuel pump. Never let children pump fuel.



WARNING: Wait at least five seconds before removing the fuel pump nozzle to allow any residual fuel to drain into the fuel tank.

Fuel and Refueling



WARNING: Do not remove the fuel pump nozzle from its fully inserted position when refueling.



WARNING: When refueling always shut the engine off and never allow sparks or open flames near the fuel tank filler valve. Never smoke or use a cell phone while refueling. Fuel vapor is extremely hazardous under certain conditions. Avoid inhaling excess fumes.



WARNING: Stop refueling after the fuel pump nozzle automatically shuts off for the second time. Failure to follow this will fill the expansion space in the fuel tank and could lead to fuel overflowing.



WARNING: The fuel system may be under pressure. If you hear a hissing sound near the fuel filler inlet, do not refuel until the sound stops. Otherwise, fuel may spray out, which could cause serious personal injury.

Note: *If you must replace the fuel filler cap, replace it with a fuel filler cap designed for your vehicle. The vehicle warranty may be void for any damage to the fuel tank or fuel system if you do not use the correct genuine Ford or Motorcraft® fuel filler cap.*

Fueling Tips

If air is allowed to enter the fuel system the engine automatically purges any trapped air. To purge the air sooner: prior to engine start, prime the system by turning the key to on for 30 seconds then to off. Repeat this several times. The engine may run rough and produce white smoke while air is in the system. This is normal.

Use only clean, approved containers that prevent the entry of dirt or water whenever you store diesel fuel.

Diesel fuel must not be stored in a galvanized container. The fuel can dissolve the zinc in the galvanized container. The zinc then remains in the fuel. If you run the contaminated fuel through the engine, the zinc can deposit in the fuel injectors causing expensive-to-repair damage.

Diesel fuel dispensing nozzle fill rate

Your vehicle has a fuel fill pipe that is able to accept fuel up to 20 gal (76 L) per minute from an 1.2 in (30 mm) fuel-dispensing nozzle. Pumping fuel at greater flow rates may result in premature nozzle shut-off or spit back.

Truck stops have pumps and nozzles designed for larger, heavy-duty trucks. When refueling at truck stops: if the nozzle shuts off repeatedly when refueling, wait 5–10 seconds; then use a slower rate of flow, do not depress the nozzle trigger as far.

Refueling

When fueling your vehicle do the following:

1. Fully open the fuel tank filler door and remove the fuel tank filler cap. Carefully turn the filler cap counterclockwise until it spins off.

Fuel and Refueling

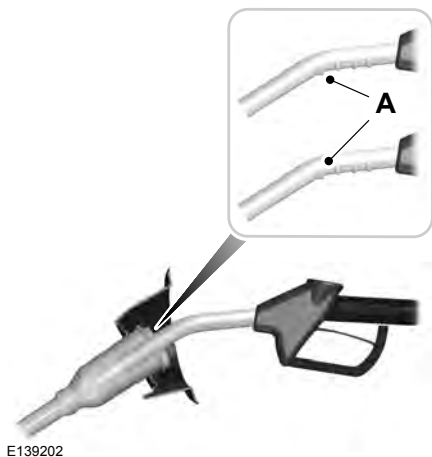

E139202

2. Insert the fuel pump nozzle up to the first notch on the nozzle A. Keep it resting on the cover of the fuel tank filler pipe opening.

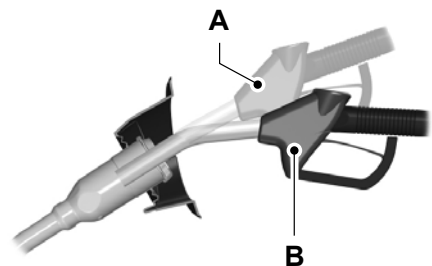

E139203

3. Hold the fuel pump nozzle in the lower position B when refueling. Holding the fuel pump nozzle in the higher position A may affect the flow of fuel and shut off the fuel pump nozzle before the fuel tank is full.



E119081

4. Slightly raise the fuel pump nozzle and then slowly remove it.
5. Replace the fuel tank filler cap and close the fuel tank filler door.

Note: Do not attempt to start the engine if you have filled the fuel tank with incorrect fuel. Incorrect fuel use can cause damage not covered by the vehicle warranty. Have your vehicle checked immediately.

Dual Fuel Tanks (If Equipped)

Your vehicle may have a dual fuel tank delivery system which operates independently and automatically. The fuel pump in the front fuel tank delivers fuel to the engine. When the fuel level in the front fuel tank drops below three quarter full, fuel automatically transfers from the rear fuel tank to the front fuel tank. Whenever there is fuel in the rear fuel tank, the front fuel tank level remains between half and three quarter full.

Note: If your vehicle runs out of fuel, you must add fuel to the front fuel tank to restart the engine.

Fuel and Refueling

FUEL CONSUMPTION

Advertised Capacity

The advertised capacity is the maximum amount of fuel that you can add to the fuel tank after running out of fuel. Included in the advertised capacity is an empty reserve. The empty reserve is an unspecified amount of fuel that remains in the fuel tank when the fuel gauge indicates empty.

Note: *The amount of fuel in the empty reserve varies and should not be relied upon to increase driving range.*

Fuel Economy

Your vehicle calculates fuel economy figures through the trip computer average fuel function. See **General Information** (page 112).

The first 1,000 mi (1,500 km) of driving is the break-in period of the engine. A more accurate measurement is obtained after 2,000 mi (3,000 km).

Impacting Fuel Economy

- Incorrect tire inflation pressures.
- Fully loading your vehicle.
- Carrying unnecessary weight.
- Adding certain accessories to your vehicle such as bug deflectors, rollbars or light bars, running boards and ski racks.
- Using fuel blended with alcohol. See **Fuel Quality** (page 185).
- Fuel economy may decrease with lower temperatures.
- Fuel economy may decrease when driving short distances.
- You may get better fuel economy when driving on flat terrain than when driving on hilly terrain.

Engine Emission Control

EMISSION LAW



WARNING: Do not remove or alter the original equipment floor covering or insulation between it and the metal floor of the vehicle. The floor covering and insulation protect occupants of the vehicle from the engine and exhaust system heat and noise. On vehicles with no original equipment floor covering insulation, do not carry passengers in a manner that permits prolonged skin contact with the metal floor. Failure to follow these instructions may result in fire or personal injury.

U.S. federal laws and certain state laws prohibit removing or rendering inoperative emission control system components. Similar federal or provincial laws may apply in Canada. We do not approve of any vehicle modification without first determining applicable laws.



Tampering with emissions control systems including related sensors or the Diesel Exhaust Fluid system can result in reduced engine power and the illumination of the service engine soon light.

Tampering With a Noise Control System

Federal laws prohibit the following acts:

- Removal or rendering inoperative by any person other than for purposes of maintenance.
- Repair or replacement of any device or element of the design incorporated into a new vehicle for the purpose of noise control prior to its sale or delivery to the ultimate purchaser or while it is in use.
- The use of the vehicle after any person removes or renders inoperative any device or element of the design.

The U.S. Environmental Protection Agency may presume to constitute tampering as follows:

- Removal of hood blanket, fender apron absorbers, fender apron barriers, underbody noise shields or acoustically absorptive material.
- Tampering or rendering inoperative the engine speed governor, to allow engine speed to exceed manufacturer specifications.

If the engine does not start, runs rough, experiences a decrease in engine performance, experiences excess fuel consumption or produces excessive exhaust smoke, check for the following:

- A plugged or disconnected air inlet system hose.
- A plugged engine air filter element.
- Water in the fuel filter and water separator.
- A clogged fuel filter.
- Contaminated fuel.
- Air in the fuel system, due to loose connections.
- An open or pinched sensor hose.
- Incorrect engine oil level.

Engine Emission Control

- Incorrect fuel for climatic conditions.
- Incorrect engine oil viscosity for climactic conditions.

Note: *Some vehicles have a lifetime fuel filter that is integrated with the fuel tank. Regular maintenance or replacement is not needed.*

Note: *If these checks do not help you correct the concern, have your vehicle checked as soon as possible.*

Noise Emissions Warranty, Prohibited Tampering Acts and Maintenance

On January 1, 1978, Federal regulation became effective governing the noise emission on trucks over 10,000 lb (4,536 kg) Gross Vehicle Weight Rating (GVWR). The preceding statements concerning prohibited tampering acts and maintenance, and the noise warranty found in the Warranty Guide, are applicable to complete chassis cabs over 10,000 lb (4,536 kg) GVWR.

CATALYTIC CONVERTER



WARNING: Do not park, idle or drive your vehicle on dry grass or other dry ground cover. The emission system heats up the engine compartment and exhaust system, creating the risk of fire.



WARNING: The normal operating temperature of the exhaust system is very high. Never work around or attempt to repair any part of the exhaust system until it has cooled. Use special care when working around the catalytic converter. The catalytic converter heats up to a very high temperature after only a short period of engine operation and stays hot after the engine is switched off.



WARNING: Exhaust leaks may result in entry of harmful and potentially lethal fumes into the passenger compartment. If you smell exhaust fumes inside your vehicle, have your vehicle inspected immediately. Do not drive if you smell exhaust fumes.



WARNING: Do not allow people or animals in truck beds that have modifications, such as bed covers or slide-in campers, when the engine is running. Exhaust fumes are toxic. Failure to follow this instruction could result in personal injury or death.

Your vehicle has various emission control components and a catalytic converter that enables it to comply with applicable exhaust emission standards.

To make sure that the catalytic converter and other emission control components continue to work properly:

- Do not crank the engine for more than 10 seconds at a time.
- Do not run the engine with a spark plug lead disconnected.
- Do not push-start or tow-start your vehicle. Use booster cables. See **Jump Starting the Vehicle** (page 322).
- Use only the specified fuel listed.
- Do not switch the ignition off when your vehicle is moving.
- Avoid running out of fuel.
- Have the items listed in scheduled maintenance information performed according to the specified schedule.

Note: *Your vehicle warranty does not cover resulting component damage.*

The scheduled maintenance items listed in scheduled maintenance information are essential to the life and performance of your vehicle and to its emissions system.

Engine Emission Control

If you use anything other than our parts for maintenance replacements or for service of components affecting emission control, such aftermarket parts should be equivalent to our genuine parts in performance and durability.

Illumination of the service engine soon indicator, charging system warning light or the temperature warning light, fluid leaks, strange odors, smoke or loss of engine power could indicate that the emission control system is not working properly.

An improperly operating or damaged exhaust system may allow exhaust to enter the vehicle. Have a damaged or improperly operating exhaust system inspected and repaired immediately.

Do not make any unauthorized changes to your vehicle or engine. By law, vehicle owners and anyone who manufactures, repairs, services, sells, leases, trades vehicles, or supervises a fleet of vehicles are not permitted to intentionally remove an emission control device or prevent it from working. Information about your vehicle's emission system is on the Vehicle Emission Control Information Decal located on or near the engine. This decal also lists engine displacement.

Please consult your warranty information for complete details.

On-Board Diagnostics (OBD-II)

Your vehicle has a computer known as the on-board diagnostics system (OBD-II) that monitors the engine's emission control system. The system protects the environment by making sure that your vehicle continues to meet government emission standards. The OBD-II system also assists a service technician in properly servicing your vehicle.



When the service engine soon indicator illuminates, the OBD-II system has detected a malfunction. Temporary malfunctions may cause the service engine soon indicator to illuminate. Examples are:

1. Your vehicle has run out of fuel—the engine may misfire or run poorly.
2. Poor fuel quality or water in the fuel—the engine may misfire or run poorly.
3. The fuel fill inlet may not have closed properly. See **Running Out of Fuel** (page 189).
4. Driving through deep water—the electrical system may be wet.

You can correct these temporary malfunctions by filling the fuel tank with good quality fuel, properly closing the fuel fill inlet or letting the electrical system dry out. After three driving cycles without these or any other temporary malfunctions present, the service engine soon indicator should stay off the next time you start the engine. A driving cycle consists of a cold engine startup followed by mixed city and highway driving. You do not require additional vehicle service.

If the service engine soon indicator remains on, have your vehicle serviced at the first available opportunity. Although some malfunctions detected by the OBD-II may not have symptoms that are apparent, continued driving with the service engine soon indicator on can result in increased emissions, lower fuel economy, reduced engine and transmission smoothness and lead to more costly repairs.

Engine Emission Control

Readiness for Inspection and Maintenance (I/M) Testing

Some state and provincial and local governments may have Inspection/Maintenance (I/M) programs to inspect the emission control equipment on your vehicle. Failure to pass this inspection could prevent you from getting a vehicle registration.



If the service engine soon indicator is on or the bulb does not work, your vehicle may need service. See On-Board Diagnostics.

Your vehicle may not pass the I/M test if the service engine soon indicator is on or not working properly, for example, the bulb does not work, or if the OBD-II system has determined that some of the emission control systems have not been properly checked. In this case, the vehicle is not ready for I/M testing.

If you have just serviced the vehicle's engine or transmission or the battery has recently run down or you have replaced it, the OBD-II system may indicate that the vehicle is not ready for I/M testing. To determine if the vehicle is ready for I/M testing, turn the ignition key to the on position for 15 seconds without cranking the engine. If the service engine soon indicator blinks eight times, it means that the vehicle is not ready for I/M testing; if the service engine soon indicator stays on solid, it means that your vehicle is ready for I/M testing.

The OBD-II system checks the emission control system during normal driving. A complete check may take several days.

If the vehicle is not ready for I/M testing, you can perform the following driving cycle consisting of mixed city and highway driving:

1. 15 minutes of steady driving on an expressway or highway followed by 20 minutes of stop-and-go driving with at least four 30-second idle periods.
2. Allow your vehicle to sit for at least eight hours with the ignition off. Then, start the vehicle and complete the above driving cycle. The vehicle must warm up to its normal operating temperature. Once started, do not turn off the vehicle until the above driving cycle is complete.

If the vehicle is still not ready for I/M testing, you need to repeat the above driving cycle.

SELECTIVE CATALYTIC REDUCTANT SYSTEM - DIESEL

Your vehicle may have a selective catalytic reduction system. The system helps reduce emission levels of oxides of nitrogen from the exhaust system. The system automatically injects diesel exhaust fluid into the exhaust system to enable correct selective catalytic reduction system function.

Note: *Selective catalytic reduction systems are not fitted to vehicles in markets where only high-sulfur diesel fuel is available.*

Diesel Exhaust Fluid Level

In order for the system to operate correctly you must maintain the diesel exhaust fluid level.

A warning message appears in the information display when the diesel exhaust fluid level is low. If a warning message appears, refill the diesel exhaust fluid tank as soon as possible. See **Information Messages** (page 123).

Engine Emission Control

Filling the Diesel Exhaust Fluid Tank



WARNING: Keep diesel exhaust fluid out of reach of children. Avoid contact with skin, eyes or clothing. In case of contact with your eyes, flush immediately with water and get prompt medical attention. In case of contact with your skin, clean immediately with soap and water. If you swallow any diesel exhaust fluid, drink plenty of water, call a physician immediately.



WARNING: Only refill the diesel exhaust fluid tank in a well ventilated area. When you remove the diesel exhaust fluid tank filler cap or a diesel exhaust fluid container cap, ammonia vapors may escape. Ammonia vapors can be irritating to skin, eyes and mucous membranes. Inhaling ammonia vapors can cause burning to the eyes, throat and nose and cause coughing and watery eyes.

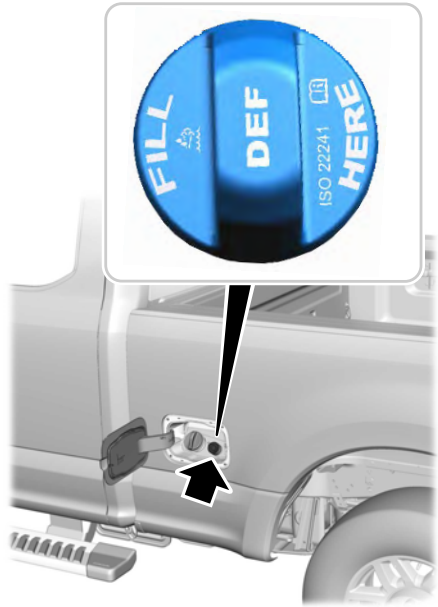

The diesel exhaust fluid tank has a blue filler cap. The tank is behind the left-hand front wheel. Fill the tank using a fluid pump at a diesel exhaust fluid filling station or a diesel exhaust fluid container. We recommend Motorcraft® diesel exhaust fluid. See **Capacities and Specifications** (page 450).

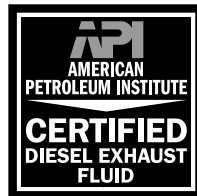

E163354

Engine Emission Control

Only use diesel exhaust fluid that is certified by the American Petroleum Institute (API). Non-certified diesel exhaust fluid use can cause damage not covered by the vehicle Warranty.

Note: *Do not put diesel exhaust fluid in the fuel tank. This can cause damage not covered by the vehicle Warranty.*

You can purchase diesel exhaust fluid at an authorized dealer, most highway truck stops or you can contact roadside assistance for help in finding a retailer that sells diesel exhaust fluid. In addition, there is a government website to help you find the nearest location to purchase diesel exhaust fluid:
<http://www.discoverdef.com>.

Filling the Diesel Exhaust Fluid Tank Using a Fuel Station Pump

Filling the diesel exhaust fluid tank using a nozzle is similar to fuel fill. The nozzle shuts off automatically when the tank is full. Do not continue to fill the tank as this could cause spilling or overflow, potentially damaging the tank.

Filling the Diesel Exhaust Fluid Tank Using a Container

The following procedure applies to Motorcraft diesel exhaust fluid or similar fluid containers. Always follow the manufacturer's instructions.

1. Remove the diesel exhaust fluid container cap. Place the spout on to the container and tighten it until you feel a strong resistance.
2. Remove the diesel exhaust fluid tank filler cap.
3. Insert the spout in to the filler neck until the seal on the spout seats on to the filler neck. Pour the fluid in to the tank. When the tank is full the fluid stops flowing automatically.

4. Return the container to the vertical position slightly below the diesel exhaust fluid filler neck. Allow any fluid remaining in the spout to drain back in to the container.
5. Remove the spout from the diesel exhaust fluid filler neck. Replace the diesel exhaust fluid tank cap.
6. Remove the spout from the diesel exhaust fluid container and replace the cap.

Note: *If there is diesel exhaust fluid left in the container retain it for later use. The spout is re-useable. Wash the spout with clean water prior to storage. Do not use the diesel exhaust fluid spout with any other fluid.*

Filling the Diesel Exhaust Fluid Tank in Cold Climates

Diesel exhaust fluid may freeze if the ambient temperature is below 12°F (-11°C). Your vehicle has a preheating system which allows diesel exhaust fluid to operate below 12°F (-11°C). If you do not use your vehicle for an extended period when the ambient temperature is below 12°F (-11°C), the fluid in the tank may freeze. If the tank is overfilled and the fluid freezes it may damage the tank. This is not covered by the vehicle warranty.

Diesel Exhaust Fluid Warning Messages and Vehicle Operations



WARNING: Diesel exhaust fluid must be refilled when low or replaced when contaminated or your vehicle speed becomes limited to 50 mph (80 km/h). In these conditions, drive with caution and refill diesel exhaust fluid immediately. If the diesel exhaust fluid becomes empty or contaminated and fluid is not replaced, your vehicle

Engine Emission Control

becomes limited to engine idle only once stopped. In these conditions, be cautious where you stop your vehicle because you may not be able to drive long distances or maintain highway speeds until you refill or replace the diesel exhaust fluid.



WARNING: Tampering with or disabling the selective catalytic reduction system results in severe vehicle performance limitation including eventual speed limiting to 5 mph (8 km/h).

The information display shows a series of messages about the amount of diesel exhaust fluid available. A systems check displays messages indicating the amount of diesel exhaust fluid available or displays a warning message indicating the approximate distance remaining as the fluid in the diesel exhaust fluid tank nears empty. See **Information Messages** (page 123).



As the diesel exhaust fluid level nears empty, the warning symbol displays and a series of tones and messages starting at 500 mi (800 km) remaining before diesel exhaust fluid is depleted. The warning symbol and messages continue until you refill the diesel exhaust fluid tank.

Continued driving without refilling results in the following actions as required by the California Air Resources Board (CARB) and the U.S. Environmental Protection Agency (EPA):

- Within a preset distance to empty, speed is limited upon vehicle restart. Prior to this occurring a message appears in the information display.
- Further vehicle operation without refilling the diesel exhaust fluid tank causes the engine to enter an idle-only condition. This only occurs upon vehicle refueling or at an extended idle. A message indicates the required actions to resume normal operation. It is required to add a minimum of 1.0 gal (3.8 L) of diesel exhaust fluid to the tank to exit the idle-only condition, but your vehicle is still in the speed-limiting mode until you refill the tank completely.

Note: For either vehicle speed limiting or idle-only condition, normal vehicle operation resumes when you refill the diesel exhaust fluid tank.

Note: When filling the diesel exhaust fluid tank from empty, there may be a short delay before detecting the increased level of fluid. The increased level detection must occur before your vehicle returns to full power.

Diesel Exhaust Fluid Guidelines and Information

- Use only diesel exhaust fluid that carries the American Petroleum Institute (API) certified diesel exhaust fluid trademark or ISO 22241.
- Do not put diesel exhaust fluid in the diesel fuel tank.
- Do not overfill the diesel exhaust fluid tank.
- Diesel exhaust fluid is corrosive.
- Do not re-use the diesel exhaust fluid container once it is emptied.

Engine Emission Control

- Avoid spilling diesel exhaust fluid on painted surfaces, carpeting or plastic components. Immediately wipe away any diesel exhaust fluid that has spilled with a damp cloth and water. If it has already crystallized, use warm water and a sponge.
- Store diesel exhaust fluid out of direct sunlight and in temperatures between 23°F (-5°C) and 68°F (20°C).
- Diesel exhaust fluid freezes below 12°F (-11°C).
- Do not store the diesel exhaust fluid bottle in your vehicle. If it leaks it could cause damage to interior components or release an ammonia odor inside your vehicle.
- Diesel exhaust fluid is non-flammable, non-toxic, colorless and water-soluble liquid.
- The system has a diesel exhaust fluid quality sensor. Dilution of diesel exhaust fluid or use of any other liquid in the SCR system leads to a diesel exhaust fluid system fault, eventually leading to the vehicle only operating in idle-only mode.
- Do not dilute diesel exhaust fluid with water or any other liquid.
- An ammonia odor may be smelled when the cap is removed or during refill. Refill diesel exhaust fluid in a well ventilated area.

Typical Diesel Exhaust Fluid Usage When Using the Power Take Off (PTO)

Continuous PTO use—Minimal PTO use

0–7,800 mi (0–12,550 km)

Contaminated Diesel Exhaust Fluid or Inoperative Selective Catalytic Reduction System

Selective catalytic reduction systems are sensitive to contamination of the diesel exhaust fluid. Maintaining the purity of the fluid is important to avoid system malfunctions. If you remove or drain the diesel exhaust fluid tank, do not use the same fluid to refill the tank. The system has a sensor to monitor fluid quality.



A warning lamp illuminates and a message appears in the information display if the system becomes contaminated or inoperative.

Continued driving without replacing diesel exhaust fluid or having the selective catalytic reduction system repaired results in the following actions as required by the California Air Resources Board (CARB) and U.S. Environmental Protection Agency (EPA):

- Within a preset distance to empty, speed is limited upon vehicle restart. Prior to this occurring a message appears in the information display.
- Further vehicle operation without replacing contaminated diesel exhaust fluid causes the engine to enter an idle-only condition. This only occurs upon vehicle refueling, vehicle idling in park for 1 hour, or engine shutdown for 10 minutes or more and is indicated by a message in the information display indicating required actions to resume normal operation.

Engine Emission Control

Note: For vehicle speed limiting or idle-only condition, normal vehicle operation resumes when you repair the contaminated system. To service a contaminated or inoperative system, see an authorized dealer.

DIESEL PARTICULATE FILTER

The filter forms part of the emissions reduction system on your vehicle. It filters harmful diesel particulates (soot) from the exhaust gas.

Regeneration



WARNING: Do not park or idle your vehicle over dry leaves, dry grass or other combustible materials. The regeneration process creates very high exhaust gas temperatures and the exhaust will radiate a considerable amount of heat during and after regeneration and after you have switched the engine off. This is a potential fire hazard.

Note: Avoid running out of fuel.

Note: During regeneration at low speed or engine idle, you may smell a hot metallic odor and could notice a clicking metallic sound. This is due to high temperatures reached during regeneration and is normal.

Note: Changes in the engine or exhaust sound may be heard during the regeneration process.

The diesel particulate filter on your vehicle requires periodic regeneration to maintain its correct function. Your vehicle will carry out this process automatically.

If your journeys meet one of the following conditions:

- You drive only short distances.
- You frequently switch the ignition on and off.
- Your journeys contain a high level of acceleration and deceleration.

You must carry out occasional trips with the following conditions to assist the regeneration process:

- Drive your vehicle in more favorable conditions, which you will find at higher vehicle speeds in normal driving, on a main road or freeway for a minimum of 20 minutes. This drive may include short stops that will not affect the regeneration process.
- Avoid prolonged idling and always observe speed limits and road conditions.
- Do not switch the ignition off.
- Select a suitable gear to ideally maintain engine speed between 1500 and 3000 RPM.

Oxidation Catalytic Converter and Diesel Particulate Filter System (if

Equipped)



WARNING: The normal operating temperature of the exhaust system is very high. Never work around or attempt to repair any part of the exhaust system until it has cooled. Use special care when working around the diesel oxidation catalytic converter or the diesel particulate filter. The diesel oxidation catalytic converter and the diesel particulate filter heat up to very high temperatures after only a short period of engine operation and remain hot after you switch the engine off.

Engine Emission Control

Your vehicle has a diesel particulate filter. The diesel particulate filter is an inline filter in the exhaust system that reduces carbon emissions by trapping exhaust particles before they reach the tailpipe. The diesel particulate filter looks similar to a traditional exhaust catalyst and is part of the exhaust system under your vehicle. The filter couples to a diesel oxidation catalyst that reduces the amount of harmful exhaust emitted from the tailpipe. As soot gathers in the system, it begins to restrict the filter. The system must periodically clean the soot that gathers inside the filter. This is carried out in two ways, passive regeneration and active regeneration. Both methods occur automatically and require no actions from the driver. During either one of these regeneration methods, you may notice a change in exhaust tone. At certain times, the information display shows various messages related to the diesel particulate filter. See **Information Messages** (page 123).

Diesel Particulate Filter Maintenance

You must properly maintain your vehicle's diesel particulate filter in order for it to function properly.

Do not disregard maintenance messages that appear in the information display. Failure to follow the instructions of an information message may degrade vehicle performance and could lead to engine damage that may not be covered by the vehicle Warranty.

Failure to perform active or operator commanded regeneration when instructed could result in a clogged diesel particulate filter. If the diesel particulate filter fills beyond the regeneration threshold, your vehicle disables the ability for active and operator commanded regeneration. This could result in irreversible damage to the diesel particulate filter requiring replacement that may not be covered by the vehicle Warranty.

Passive Regeneration

In passive regeneration, the exhaust system temperature and constituents automatically clean the filter by oxidizing the soot. Cleaning automatically occurs during normal vehicle operating conditions due to driving patterns.

Active Regeneration

Once the diesel particulate filter is full of exhaust particles, the engine control module commands the exhaust system to clean the filter through active regeneration. Active regeneration requires the engine computer to raise the exhaust temperature to eliminate the particles. During cleaning, the particles convert to harmless gasses. Once cleaned the diesel particulate filter continues trapping exhaust particles.

The regeneration process operates more efficiently when you drive your vehicle at a constant speed above 30 mph (48 km/h) and at a steady engine speed for approximately 20 minutes. The frequency and duration of regeneration fluctuates by how you drive your vehicle, outside air temperature and altitude. For most driving, regeneration frequency varies from 100–500 mi (160–805 km) between occurrences and each occurrence lasts 9–35 minutes. You can usually reduce the duration of regeneration if you maintain a constant speed above 30 mph (48 km/h).

When the engine control module detects that the diesel particulate filter is nearly full of particulates and you are not operating your vehicle in a manner to allow effective automatic regeneration, messages appear in the information display as a reminder for you to drive your vehicle in order to clean the diesel particulate filter. If you drive your vehicle in a manner to allow effective automatic regeneration, the information display

Engine Emission Control

shows a cleaning exhaust filter message, which is the normal regeneration process. You can also choose operator commanded regeneration to clean the exhaust system at this point. See **Information Messages** (page 123).

If you are not able to drive in a manner that allows effective automatic active regeneration or you choose to perform regeneration of the diesel particulate filter while at idle, then operator commanded regeneration would need to be performed.

Operator Commanded Regeneration (If Equipped)

If your vehicle is operated with significant stationary operation, low speed drive cycles less than 25 mph (40 km/h), short drive cycles, a drive time is less than 10 - 15 minutes or the vehicle does not fully warm up, passive and active regeneration may not sufficiently clean the diesel particulate filter system. Operator commanded regeneration allows you to manually start regeneration of the diesel particulate filter at idle to clean the filter. If you are not sure whether your vehicle has this feature, contact an authorized dealer.

When to Carry Out Operator Commanded Regeneration

You can use the operator commanded regeneration feature when a message appears in the information display and you are not able to drive in a manner that allows effective automatic active regeneration or if you choose to manually start the regeneration of the diesel particulate filter manually while the vehicle is idle. See **Information Messages** (page 123).

Operator Commanded Regeneration Precautions and Safe Exhaust Position



WARNING: Do not park or idle your vehicle over dry leaves, dry grass or other combustible materials. The regeneration process creates very high exhaust gas temperatures and the exhaust will radiate a considerable amount of heat during and after regeneration and after you have switched the engine off. This is a potential fire hazard.



WARNING: Stay clear of the exhaust tailpipe during regeneration. Hot exhaust gases can burn you badly.

Make sure that the louvers located at the tip of the exhaust are clear of any obstructions as they are used to introduce fresh air into the tailpipe to cool the exhaust gases as they leave the exhaust system.

Before you start operator commanded regeneration, do the following:

- Shift into park (P) and apply the parking brake, on stable, level ground.
- Park your vehicle outside of any structure.
- Park your vehicle 10–15 ft (3–5 m) away from any obstructions and away from materials that can easily combust or melt, for example paper, leaves, petroleum products, fuels, plastics and other dry organic material.
- Make sure there is a minimum of 1/8 tank of fuel.
- Make sure all fluids are at proper levels.

Engine Emission Control

How to Start Operator Commanded Regeneration



WARNING: Stay clear of the exhaust tailpipe during regeneration. Hot exhaust gases can burn you badly.

Note: You cannot use the operator commanded regeneration until the diesel particulate filter load percentage has reached 100%. The diesel particulate filter load percentage fluctuates up and down when driving your vehicle due to active and passive regenerations.

Note: During the use of operator commanded regeneration, you may observe a light amount of white smoke. This is normal.



You may not be able to use operator commanded regeneration if the service engine soon warning lamp appears in the information display

Information Display Procedure

Start with your vehicle engine and when it has reached the normal operating temperature, press the information display control button on the steering wheel. See **Information Display Control** (page 85). If a message advising that the exhaust filter is full appears in the information display, press the **OK** button as instructed. Answer yes to this prompt and then follow the next prompts regarding the exhaust position required to initiate operator commanded regeneration. Be sure to understand each prompt. If you are not sure what is being asked by each prompt, contact an authorized dealer. The display confirms the operation has started and when it has finished.

If the diesel particulate filter is near or at saturation, a message requesting permission to initiate filter cleaning appears in the information display. See **Information Messages** (page 123). Answer yes to this prompt and then follow the next prompts regarding exhaust position required to initiate operator commanded regeneration. Be sure to understand each prompt. If you are not sure what is being asked by each prompt, contact an authorized dealer. The display confirms the operation has started and when it has finished. You can also drive to clean the filter.



When the system is at the point of oversaturation, the service engine warning lamp illuminates and a message appears in the information display. You cannot initiate filter cleaning. You must have your vehicle checked as soon as possible.

Once operator commanded regeneration starts, engine speed increases to approximately 1600 rpm and the cooling fan speed increases. You will hear a change in audible sound due to engine speed and cooling fan speed increases.

It is not necessary to open the hood on the engine compartment. Once operator commanded regeneration completes, the engine speed returns to normal idling. The exhaust system remains very hot for several minutes even after regeneration is complete. Do not reposition the vehicle over materials that could burn until the exhaust system has had sufficient time to cool. Depending on the amount of soot collected by the diesel particulate filter, ambient temperature and altitude, operator commanded regeneration lasts approximately 30 minutes.

Engine Emission Control

Operator Commanded Regeneration with Automatic Regeneration Control (If Equipped)

If your vehicle is operated with significant stationary operation, low speed drive cycles less than 25 mph (40 km/h), short drive cycles, drive time less than 15 minutes or the vehicle does not fully warm up, passive and active regeneration may not sufficiently clean the diesel particulate filter system. You can switch off automatic regeneration until better driving conditions are available, for example steady high speed driving. You can then switch automatic regeneration back on to clean the diesel particulate filter.

Switching Automatic Regeneration Control On and Off

To switch operator commanded regeneration on and off, use the information display control on the steering wheel. See **Information Display Control** (page 85). Scroll to the exhaust cleaning message, a check in the box indicates the feature is enabled, and unchecked indicates the feature is disabled.

How to Interrupt or Cancel Operator Commanded Regeneration

If you need to cancel the operator commanded regeneration, pressing the brake, accelerator or switching the engine off stops the procedure. Depending on the amount of time you allowed the operator commanded regeneration to operate, soot may not have had sufficient time to be fully eliminated, but the exhaust system and exhaust gas may still be hot. If you shut your vehicle off during operator commanded regeneration, you may notice turbo flutter. This is a normal consequence caused by shutting off a diesel engine during boosted operation and is considered normal.

Filter Service and Maintenance

Over time, a slight amount of ash builds up in the diesel particulate filter, which is not removed during the regeneration process. The filter may need to be replaced with a new or remanufactured part at approximately 250,000 mi (400,000 km). Actual mileage varies depending on engine and vehicle operating conditions.



If filter service is required, the engine control system warning lamp illuminates in the information display.



If there are any issues with the diesel particulate filter system, the engine control system warning lamp and a service engine soon warning lamp illuminate to inform you that your vehicle requires service. Have your vehicle checked as soon as possible.



Resonator and Tailpipe Assembly Maintenance

Aftermarket devices or modifications to the exhaust system may reduce the effectiveness of the exhaust system as well as cause damage to the exhaust system or engine. This may also degrade vehicle performance and could lead to engine damage that may not be covered by the vehicle Warranty.

Transmission

AUTOMATIC TRANSMISSION



WARNING: Apply the parking brake, shift into park (P), switch the ignition off and remove the key before you leave your vehicle. Failure to follow this instruction could result in personal injury or death.



WARNING: When your vehicle is stationary, keep the brake pedal fully pressed when shifting gears. Failure to follow this instruction could result in personal injury, death or property damage.

Note: You may not be able to shift out of park (P) unless the intelligent access key is inside your vehicle.

Understanding the Shift Positions of Your Automatic Transmission

(If Equipped)

10 Speed Transmissions

10 9 8 7 6 5 4 3 2 1
P R N D M

Putting your vehicle in or out of gear:

1. Fully press down the brake pedal.
2. Move the gearshift lever into the preferred gear.
3. When you have finished driving, come to a complete stop.
4. Move the gearshift lever and securely latch it in park (P).

The instrument cluster displays the current gear.

Park (P)

This position locks the transmission and prevents the rear wheels from turning.

Reverse (R)

With the gearshift lever in reverse (R), your vehicle moves backward. Always come to a complete stop before shifting into and out of reverse (R).

Neutral (N)

With the gearshift lever in neutral (N), you can start your vehicle and is free to roll. Hold the brake pedal down when in this position.

Drive (D)

Drive (D) is the normal driving position for the best fuel economy. The drive function allows automatic upshifts and downshifts through the full range of gears.

Manual (M)

With the gearshift lever in manual (M), the driver can change gears up or down as preferred. By moving the gearshift lever from drive position drive (D) to manual (M) you now have control of selecting the gear you prefer using buttons on the shift lever.

To return to the normal drive (D) position, move the shift lever from manual (M) to drive (D).

The transmission operates through the full range of gears.

Forced downshifts

- Allowed in drive (D) with the tow/haul feature on or off.
- Press the accelerator to the floor.
- Allows transmission to select an appropriate gear.

Transmission

Understanding Your SelectShift Automatic™ Transmission



E249567

Note: When pressing the button on the gearshift lever, you can cycle through the available drive modes. See **Drive Control** (page 267).

Your vehicle has a SelectShift Automatic™ transmission gearshift lever. The SelectShift Automatic transmission gives you the ability to change gears up or down without a clutch.

To prevent the engine from running at too low of an RPM, which could cause it to stall, SelectShift will downshift if it determines that you have not downshifted in time.

SelectShift does not upshift, even if the engine is approaching the RPM limit. Shift it manually by pressing the + button.

Note: Engine damage could occur if you maintain excessive engine revving without shifting.

The SelectShift Automatic transmission feature has two modes:

- Progressive Range Selection
- Manual (M)

Progressive Range Selection - PRS

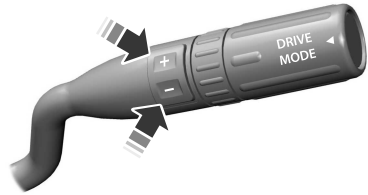

Progressive Range Selection gives you the ability to lockout gears from the automatic shifting range. This could provide you with an improved driving experience, for example, in slippery conditions or when experiencing a steep slope.

With the gearshift lever in drive (D), press the – button to active PRS. The instrument cluster indicates the available and selected gears.

All available gears display with the current gear indicated. Press the – button again to lock out gears beginning with the highest gear for example, press the – button twice to lock out 6th and 5th gears. Only the available gears display, and the transmission shifts between the available gears. Press the + button to unlock gears to allow the transmission to shift to higher gears. The transmission shifts within the gear range you select.

Manual (M)

Moving the gearshift lever to the manual (M) position allows you to manually select the gear you prefer. Only the current gear displays. Use the buttons on the gearshift lever to manually select gears. Press the + button to upshift or the – button to downshift. Return the transmission to a different gearshift position to deactivate manual control.

Transmission

Recommended shift speeds

Upshift according to the following chart:

Upshifts when Accelerating (Recommended for Best Fuel Economy) 10 Speed		
Shift from:	Gasoline engines	Diesel engines
1 - 2	7 mph (11 km/h)	10 mph (16 km/h)
2 - 3	10 mph (16 km/h)	15 mph (24 km/h)
3 - 4	17 mph (27 km/h)	19 mph (31 km/h)
4 - 5	20 mph (32 km/h)	22 mph (35 km/h)
5 - 6	23 mph (37 km/h)	25 mph (40 km/h)
6 - 7	29 mph (47 km/h)	31 mph (50 km/h)
7 - 8	34 mph (55 km/h)	36 mph (58 km/h)
8 - 9	44 mph (71 km/h)	45 mph (72 km/h)
9 - 10	47 mph (76 km/h)	49 mph (79 km/h)

Automatic Transmission Adaptive Learning

This feature's design is to increase durability and provide consistent shift feel over the life of your vehicle. A new vehicle or transmission may have firm shifts, soft shifts or both. This operation is normal and does not affect function or durability of the transmission. Over time, the adaptive learning process fully updates transmission operation. Additionally, whenever you disconnect the battery or install a new battery, the system must relearn the strategy.

For F350, F450, F550 and F600 Chassis Cab Vehicles

Your transmission could reduce the load on the engine when the vehicle stops, and the gear selector is in drive (D) to reduce fuel consumption and emissions. The transmission resumes operation when you release the brake. This feature activates when the transmission is sufficiently warmed, and the vehicle is on a level slope.

Brake-Shift Interlock



WARNING: When doing this procedure, you need to take the transmission out of park (P) which means your vehicle can roll freely. To avoid unwanted vehicle movement, always fully apply the parking brake prior to doing this procedure. Use wheels chocks if appropriate.

Transmission



WARNING: If the parking brake is fully released, but the brake warning lamp remains illuminated, the brakes may not be working properly. Have your vehicle checked as soon as possible.

Note: Do not drive your vehicle until you verify that the brake lamps are working.

Your vehicle comes with brake-shift interlock that prevents the gearshift lever from moving from park (P) when you switch the ignition on but have not pressed the brake pedal.

If you cannot move the gearshift lever out of the park (P) position when the ignition is on and the brake pedal pressed, a malfunction could have occurred. It is possible that a fuse has blown, or your vehicle's brake lamps are not operating properly. See **Fuse Specification Chart** (page 334).

If you do not have a blown fuse and the brake lamps are working properly, the following procedure allows you to move the gearshift lever from park (P):

1. Apply the parking brake. Switch the ignition key to 1 - 0, then remove the key.
2. Move the steering column to the full down and full rearward position, toward the driver seat.
3. Remove the gearshift lever boot.
4. Place fingers into hole where you removed the gearshift lever boot and pull top half of shroud up and forward to separate it from the lower half of the shroud. There is a hinge at the forward edge of the top shroud. Roll the top half of the shroud upward on the hinge point, then pull straight rearward toward the driver seat to remove.
5. Remove the top half of the shroud.

6. Remove the three fasteners under the column that secure the lower shroud half to the column.



E163185

7. Pull the lock lever into the full unlocked position and remove the lower shroud cover by pulling the lever handle through the slot in the cover.
8. Apply the brake. Gently lift the override disk and move the gearshift lever into neutral (N).

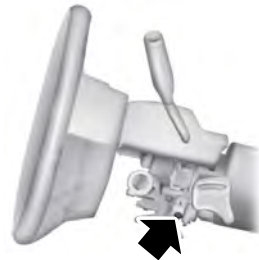

E163186

9. Start your vehicle.

Perform steps 4 through 8 in reverse order, making sure to engage the hinge pivots between the upper and lower halves of the shroud. Keep slight pressure in the forward direction as you rotate the halves together.

Transmission

If Your Vehicle Gets Stuck in Mud or Snow

Note: Do not rock your vehicle if the engine is not at normal operating temperature or damage to the transmission could occur.

Note: Do not rock your vehicle for more than a minute or damage to the transmission and tires could occur, or the engine could overheat.

If your vehicle is stuck in mud or snow, you can rock it out by shifting between forward and reverse gears, stopping between shifts in a steady pattern. Press lightly on the accelerator in each gear.

POWER TAKE-OFF (IF EQUIPPED)

Note: Use of auxiliary equipment that exceeds the maximum Power Take-Off (PTO) load specified in our Truck Body Builders Layout Book can adversely affect the performance of the powertrain system. Refer to the Body Builders Layout Book for instructions about the appropriate installation of additional equipment.

Auxiliary equipment called power take-off, or PTO, is often added to the engine or transmission to operate utility equipment. Examples include a wheel-lift for tow trucks, cranes, tools for construction or tire service, and pumping fluids. PTO applications draw auxiliary horsepower from the powertrain, often while the vehicle is stationary. In this condition, there is limited cooling air flow through the radiator and around the vehicle that normally occurs when a vehicle is moving. The aftermarket PTO system installer, having the most knowledge of the final application, is responsible for determining whether additional chassis heat protection or powertrain cooling is required, and alerting the user to the safe and proper operation.

Split Shaft Capability (If Equipped)

Our Super Duty vehicles are approved for use as a stationary, including split shaft capability with 6.7L diesel only, or mobile power source, within limits and operating guidelines detailed in our Truck Body Builders Layout Book. For additional information, visit www.fordbbas.com.

Four-Wheel Drive (If Equipped)

USING FOUR-WHEEL DRIVE

Note: For important information regarding the safe operation of this type of vehicle, see General Information in the Wheels and Tires chapter.

Note: Do not use 4H or 4L mode on dry, hard surfaced roads. Doing so can produce excessive noise, increase tire wear and may damage drive components. 4X4 mode is only intended for consistently slippery or loose surfaces. Use of 4L mode on these surfaces may produce some noise, such as occasional clunks, but will not damage drive components.

Note: If 4X4 low is selected while the vehicle is moving above 3 mph (5 km/h), the 4WD system will not perform a shift. This is normal and should be no reason for concern. Refer to Shifting to or from 4L (4X4 Low) for proper operation.

Note: You can switch on and switch off the electronic locking differential by pulling the 4WD control (4WD vehicles) or turning the electronic locking differential control (2WD vehicles). See **Electronic Locking Differential** (page 220).

Electronic Shift-On-the-Fly (ESOF) 4WD system (If Equipped)

Note: If 4X4 Low is selected while the vehicle is moving above 3 mph (5 km/h), the 4WD system will not perform a shift. This is normal and should be no reason for concern. Refer to Shifting to or from 4L (4X4 Low) for proper system operation.

Note: Auto-manual hub locks can be manually locked by rotating the hub lock control from AUTO to LOCK.



E163188

For proper operation, make sure that each hub is fully engaged and that both hub locks are set to the same position (both set to LOCK or both set to AUTO). To engage LOCK, turn the hub locks completely clockwise; to engage AUTO, turn the hub locks completely counterclockwise.

The ESOF 4WD system:

- Provides 4x4 High engagement and disengagement while the vehicle is moving.
- Is operated by a rotary control located on the instrument panel that allows you select 4x2, 4x4 High or 4x4 Low operation.
- Uses auto-manual hub locks that can be engaged and disengaged automatically based on the 4x4 mode selected.
- Will increase fuel economy when used in the hub lock's recommended AUTO mode.

4WD Indicator Lights

Note: When a 4X4 system fault is present, the system will typically remain in whichever 4X4 mode was selected prior to the fault condition occurring. It will not default to 4X2 in all circumstances. When this warning is displayed, have your vehicle serviced by an authorized dealer.

Four-Wheel Drive (If Equipped)

4X2

2H Momentarily illuminates when 2H is selected.

4X4 HIGH

4H Continuously illuminates when 4H is selected.

4X4 LOW

4L Continuously illuminates when 4L is selected.

CHECK 4X4



Displays when a 4X4 fault is present.

Using the Electronic Shift on the Fly 4WD system (If Equipped)

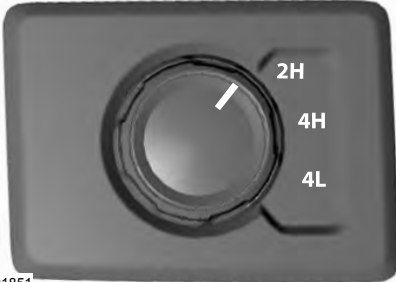

E191851

2H (4X2)

For general on-road driving. Sends power to the rear wheels only and should be used for street and highway driving. Provides optimal smoothness and fuel economy at high speeds.

4H (4X4 HIGH)

Provides mechanically locked four-wheel drive power to both the front and rear wheels for use in off-road or winter conditions such as deep snow, sand or mud. This mode is not for use on dry pavement.

4L (4X4 LOW)

Provides mechanically locked four-wheel drive power to both the front and rear wheels for use on low traction surfaces, but does so with additional gearing for increased torque multiplication. Intended only for off-road applications such as deep sand, steep grades, or pulling heavy objects. 4L (4X4 low) will not engage while your vehicle is moving above 3 mph (5 km/h); this is normal and should be no reason for concern. Refer to Shifting to or from 4L (4X4 low) for proper operation.

Shifting between system modes

Note: Momentarily releasing the accelerator pedal when a shift in progress message displays improves engagement or disengagement performance.

Note: Do not perform this operation if the rear wheels are slipping or when applying the accelerator pedal.

Note: Some noise may be heard as the system shifts or engages; this is normal.

Note: 4X4 high mode is not intended for use on dry pavement.

You can move the control from 2H or 4H at a stop or while driving. The information display may display a message indicating a 4X4 shift is in progress. Once the shift is complete the message center will then display the system mode selected.

Shifting to or from 4L (4X4 low)

Note: Some noise may be heard as the system shifts or engages; this is normal.

Four-Wheel Drive (If Equipped)

Note: 4x4 low mode is not intended for use on dry pavement.

1. Bring the vehicle to a speed of 3 mph (5 km/h) or less.
2. Place the transmission in neutral (N).
3. Move the 4WD control to the preferred position.

The information display will display a message indicating a 4X4 shift is in progress. The information display will then display the system mode selected. If any of the above shift conditions are not met, the shift will not occur and the information display will display information guiding the driver through the proper shifting procedures.

If **Shift Delayed Pull Forward** appears in the information display, transfer case gear tooth blockage is present. To alleviate this condition, place the transmission in a forward gear, move the vehicle forward approximately 5 ft (1.5 m), and shift the transmission back to neutral to allow the transfer case to complete the range shift.

Entering and Exiting Rock Crawl Mode with Tremor Package (If

Equipped)



- To enter rock crawl your vehicle must be in 4x4 low.
- Press the drive mode button on the shifter column to bring up the information display and select rock crawl mode.
- With the switch in 4x4 low position, press rock crawl mode again to deactivate it.

- You can now perform a shift out of 4x4 low.
- Refer to Shifting to or from 4L(4x4 low) as described previously for proper operation of 4x4 low in this procedure.

Operating 4WD Vehicles with Spare or Mismatched Tires

On four-wheel drive vehicles, the size of the spare tire can affect the 4X4 system. If there is a significant difference between the size of the spare tire and the remaining tires, you may have limited four-wheel drive functionality.

When driving with the full-size, dissimilar spare wheel and tire assembly, recommend that you do not:

- Exceed 50 mph (80 km/h) with a 4WD mode turned on.
- Turn on a 4WD mode unless the vehicle is stationary.
- Use a 4WD mode on dry pavement.

When driving with the full-size, dissimilar spare wheel and tire assembly, you may have limited 4WD functionality, especially when driving in a mechanically locked 4WD mode. You may experience the following:

- Additional noise from the transfer case or other drive components.
- Difficulty shifting out of a mechanically locked 4WD mode.

Use of a dissimilar spare wheel and tire assembly may lead to impairment of the following:

- Comfort and noise.
- Winter weather driving capability.
- Wet driving capability.
- Four-wheel drive capability.

Four-Wheel Drive (If Equipped)

How Your Vehicle Differs from Other Vehicles



WARNING: Vehicles with a higher center of gravity (utility and four-wheel drive vehicles) handle differently than vehicles with a lower center of gravity (passenger cars). Avoid sharp turns, excessive speed and abrupt steering in these vehicles. Failure to drive cautiously increases the risk of losing control of your vehicle, vehicle rollover, personal injury and death.

Truck and utility vehicles can differ from some other vehicles. Your vehicle may be higher to allow it to travel over rough terrain without getting hung up or damaging underbody components.

The differences that make your vehicle so versatile also make it handle differently than an ordinary passenger car.

Maintain steering wheel control at all times, especially in rough terrain. Since sudden changes in terrain can result in abrupt steering wheel motion, make sure you grip the steering wheel from the outside. Do not grip the spokes.

Drive cautiously to avoid vehicle damage from concealed objects such as rocks and stumps.

You should either know the terrain or examine maps of the area before driving. Map out your route before driving in the area. To maintain steering and braking control of your vehicle, you must have all four wheels on the ground and they must be rolling, not sliding or spinning.

Driving Off-Road With Truck and Utility Vehicles

Note: *On some models, the initial shift from two-wheel drive to four-wheel drive while the vehicle is moving can cause some momentary clunk and ratcheting sounds. This is the front drivetrain coming up to speed and the automatic locking hubs engaging and is not cause for concern.*

Note: *Your vehicle may come with a front air dam that can become damaged (due to reduced ground clearance) when taking your vehicle off-road. This air dam can be taken off by removing 15 bolts.*

Four-wheel drive vehicles are specially equipped for driving on sand, snow, mud and rough terrain and have operating characteristics that are somewhat different from conventional vehicles, both on and off the road.

Power is supplied to all four wheels through a transfer case. On four-wheel drive vehicles, the transfer case allows you to select 4WD when necessary. Information on transfer case operation and shifting procedures can be found in this chapter. Information on transfer case maintenance can be found in the Maintenance chapter. You should become thoroughly familiar with this information before you operate your vehicle.

Four-wheel drive (when you select a 4WD mode) uses all four wheels to power the vehicle. This increases traction, enabling you to drive over terrain and road conditions that a conventional two-wheel drive vehicle cannot.

Four-Wheel Drive (If Equipped)

Basic Operating Principles

- Drive slower in strong crosswinds which can affect the normal steering characteristics of your vehicle.
- When driving your vehicle on surfaces made slippery by loose sand, water, gravel, snow or ice proceed with care.
- Do not use 4H or 4L on dry, hard surfaced roads. Doing so will produce excessive noise, increase tire wear and may damage drive components. 4H or 4L modes are only intended for consistently slippery or loose surfaces.

If Your Vehicle leaves the Road

If your vehicle leaves the road, reduce your vehicle speed and avoid severe braking. When your vehicle speed has been reduced ease your vehicle back onto the road. Do not turn the steering wheel sharply while returning your vehicle to the road.

It may be safer to stay on the shoulder of the road and slow down gradually before returning to the road. You may lose control if you do not slow down or if you turn the steering wheel too sharply or abruptly.

It may be less risky to strike small objects, such as freeway reflectors, with minor damage to your vehicle rather than attempt a sudden return to the road which could cause your vehicle to slide sideways out of control or roll over. Remember, your safety and the safety of others should be your primary concern.

Emergency Maneuvers

In an unavoidable emergency situation where a sudden sharp turn must be made, remember to avoid over-driving your vehicle (i.e. turn the steering wheel only as rapidly and as far as required to avoid the emergency). Excessive steering can result in loss of vehicle control. Apply smooth pressure to the accelerator pedal or brake pedal when changes in vehicle speed are

required. Avoid abrupt steering, acceleration and braking. This could result in an increased risk of vehicle roll over, loss of vehicle control and personal injury. Use all available road surface to bring your vehicle to a safe direction of travel.

In the event of an emergency stop, avoid skidding the tires and do not attempt any sharp steering wheel movements.

If your vehicle goes from one type of surface to another (i.e. from concrete to gravel) there will be a change in the way your vehicle responds to a maneuver (i.e. steering, acceleration or braking).

Sand

When driving over sand, try to keep all four wheels on the most solid area of the trail. Avoid reducing the tire pressures but shift to a lower gear and drive steadily through the terrain. Apply the accelerator slowly and avoid excessive wheel slip.

When driving at slow speeds in deep sand under high outside temperatures, use a low gear when possible. Low gear operation will maximize the engine and transmission cooling capability.

Avoid driving at excessive speeds, this causes vehicle momentum to work against you and your vehicle could become stuck to the point that assistance may be required from another vehicle. Remember, you may be able to back out the way you came if you proceed with caution.

Mud and Water

Mud

Be cautious of sudden changes in vehicle speed or direction when you are driving in mud. Even four-wheel drive vehicles can lose traction in slick mud. If your vehicle does slide, steer in the direction of the slide until you regain control of your vehicle.

Four-Wheel Drive (If Equipped)

After driving through mud, clean off residue stuck to rotating driveshafts and tires. Excess mud stuck on tires and rotating driveshafts can cause an imbalance that could damage drive components.

Water

If you must drive through high water, drive slowly. Traction or brake capability may be limited.

When driving through water, determine the depth and avoid water higher than the bottom of the hubs. If the ignition system gets wet, your vehicle may stall.

Once through water, always try the brakes. Wet brakes do not stop your vehicle as effectively as dry brakes. Drying can be improved by applying light pressure to the brake pedal while moving slowly.

Note: *Driving through deep water may damage the transmission. If the front or rear axle is submerged in water, the axle lubricant and power transfer unit lubricant should be checked and changed if necessary.*

Driving on Hilly or Sloping Terrain

Although natural obstacles may make it necessary to travel diagonally up or down a hill or steep incline, you should always try to drive straight up or straight down.

Note: *Avoid turning on steep slopes or hills. A danger lies in losing traction, slipping sideways and possible vehicle roll over. Whenever driving on a hill, determine beforehand the route you will use. Do not drive over the crest of a hill without seeing what conditions are on the other side. Do not drive in reverse over a hill without the aid of an observer.*

When climbing a steep slope or hill, start in a lower gear rather than downshifting to a lower gear from a higher gear once the ascent has started. This reduces strain on the engine and the possibility of stalling.

If your vehicle stalls, do not try to turn around because this could cause vehicle roll over. It is better to reverse back to a safe location.

Apply just enough power to the wheels to climb the hill. Too much power will cause the tires to slip, spin or lose traction, resulting in loss of vehicle control.



E143949

Descend a hill in the same gear you would use to climb up the hill to avoid excessive brake application and brake overheating. Do not descend in neutral. Disengage overdrive or move the transmission selector lever to a lower gear. When descending a steep hill, avoid sudden hard braking as you could lose control. The front wheels have to be turning in order to steer your vehicle.

If your vehicle has anti-lock brakes, apply the brakes steadily. Do not pump the brakes.

Driving on Snow and Ice



WARNING: If you are driving in slippery conditions that require tire chains or cables, then it is critical that you drive cautiously. Keep speeds down, allow for longer stopping distances and avoid aggressive steering to reduce the

Four-Wheel Drive (If Equipped)

chances of a loss of vehicle control which can lead to serious injury or death. If the rear end of your vehicle slides while cornering, steer in the direction of the slide until you regain control of your vehicle.

Note: Excessive tire slippage can cause transmission damage.

Four-wheel drive vehicles have advantages over two-wheel drive vehicles in snow and ice but can skid like any other vehicle. Should you start to slide while driving on snowy or icy roads, turn the steering wheel in the direction of the slide until you regain control.

Avoid sudden applications of power and quick changes of direction on snow and ice. Apply the accelerator slowly and steadily when starting from a full stop.

Avoid sudden braking. Although a four-wheel drive vehicle may accelerate better than a two-wheel drive vehicle in snow and ice, it will not stop any faster as braking occurs at all four wheels. Do not become overconfident as to road conditions.

Make sure you allow sufficient distance between you and other vehicles for stopping. Drive slower than usual and consider using one of the lower gears. In emergency stopping situations, apply the brake steadily. Do not pump the brake pedal. See **Hints on Driving With Anti-Lock Brakes** (page 224).

If Your Vehicle Gets Stuck in Mud or Snow



WARNING: Do not spin the wheels at over 34 mph (55 km/h). The tires may fail and injure a passenger or bystander.

If your vehicle gets stuck in mud or snow, it may be rocked out by shifting between forward and reverse gears, stopping between shifts in a steady pattern. Press lightly on the accelerator in each gear.

Note: Do not rock your vehicle if the engine is not at normal operating temperature, damage to the transmission may occur.

Note: Do not rock your vehicle for more than a minute, damage to the transmission and tires may occur or the engine may overheat.

Parking



WARNING: If the parking brake is fully released, but the brake warning lamp remains illuminated, the brakes may not be working properly. Have your vehicle checked as soon as possible.



WARNING: Apply the parking brake, shift into park (P), switch the ignition off and remove the key before you leave your vehicle. Failure to follow this instruction could result in personal injury or death.

On some four-wheel drive vehicles, when the transfer case is in the N (Neutral) position, the engine and transmission are disconnected from the rest of the driveline. Therefore, the vehicle is free to roll even if the automatic transmission is in P (Park) or the manual transmission is in gear. Do not leave the vehicle unattended with the transfer case in the neutral (N) position. Always set the parking brake fully and turn off the ignition when leaving the vehicle.

Four-Wheel Drive (If Equipped)

Maintenance and Modifications

The suspension and steering systems on your vehicle have been designed and tested to provide predictable performance whether loaded or empty. For this reason, we strongly recommend that you do not make modifications such as adding or removing parts (i.e. lift kits or stabilizer bars) or by using replacement parts not equivalent to the original factory equipment.

We recommend that you use caution when your vehicle has either a high load or device (i.e. ladder or luggage racks). Any modifications to your vehicle that raise the center of gravity may cause your vehicle to roll over when there is a loss of vehicle control.

Failure to maintain your vehicle correctly may void the warranty, increase your repair cost, reduce vehicle performance and operational capabilities and adversely affect you and your passenger's safety. We recommend you frequently inspect your vehicle's chassis components when your vehicle is subject to off road usage.

Rear Axle

LIMITED SLIP DIFFERENTIAL

(IF EQUIPPED)

This axle provides added traction on slippery surfaces, particularly when one wheel is on a poor traction surface. Under normal conditions, the limited-slip axle functions like a standard rear axle. The axle may exhibit a slight noise or vibration during tight turns with low vehicle speed. This is normal behavior and indicates the axle is working.

ELECTRONIC LOCKING DIFFERENTIAL (IF EQUIPPED)

Note: *The electronic locking differential is for off-road use only and is not for use on dry pavement. Using the electronic locking differential on dry pavement will result in increased tire wear, noise and vibration.*

The electronic locking differential is a device housed in the rear axle that allows both rear wheels to turn at the same speed. The electronic locking differential can provide additional traction should your vehicle become stuck. You can activate the differential electronically and shift it on the fly within the differential operating speed range. The differential is for use in mud, rocks, sand, or any off-road condition where you need maximum traction. It is not for use on dry pavement.

The following conditions will affect the electronic locking differential:

- The electronic locking differential will not engage if your vehicle speed is above 20 mph (32 km/h) in 4x2, or 4x4 High modes.
- The electronic locking differential will not engage if your vehicle speed is above or 56 mph (90 km/h) in 4X4 Low.
- The electronic locking differential may not engage if you press your accelerator pedal during an engagement attempt. A message may display in the instrument display guiding you to release the accelerator pedal.
- In 4x2, and 4x4 High modes, the electronic locking differential will automatically disengage at speeds above 25 mph (41 km/h) and will automatically reengage at speeds below 20 mph (32 km/h).
- In 4L (4X4 low), the electronic locking differential will automatically disengage at speeds above 62 mph (100 km/h) and will automatically reengage at speeds below 56 mph (90 km/h).
- The AdvanceTrac system has the ability to take over control of the electronic locking differential and disable it during driving maneuvers when necessary.

When you switch the system on, if you do not meet the required conditions for electronic locking differential activation, the instrument cluster will display the appropriate information guiding you through the proper activation process.

Activating the Electronic Locking Differential

Note: *Do not use electronic locking differential on dry, hard surfaced roads. Doing so will produce excessive noise, vibration and increase tire wear.*

Note: *If the electronic locking differential has difficulty disengaging, release the accelerator pedal and turn the steering wheel in the opposite direction while rolling.*

Rear Axle

For 4WD vehicles

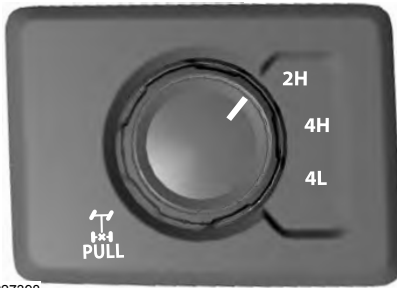

E227398

Pull the 4WD control knob toward you.

For 2WD vehicles

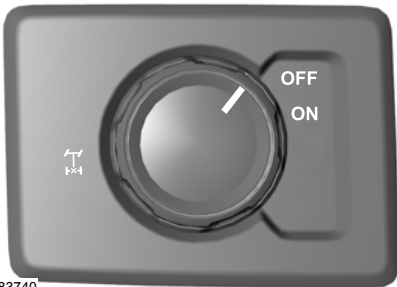

E183740

Turn the control to ON.



Once the indicator light illuminates in the information display, both rear wheel axle shafts will be locked together providing added traction.

If the indicator does not come on, or the indicator turns off while driving, one of the following has occurred:

- The vehicle speed is too high.
- The left and right rear wheel speed difference is too high during an engagement attempt.

- The system has malfunctioned and is accompanied by a message in the information display. See your authorized Ford dealer for assistance.
- The vehicle is experiencing an anti-lock brake activation.

Operating ELD With a Spare or Mismatched Tires

On vehicles with an ELD, the size of the spare tire can affect performance of the system. If there is a significant difference between the two rear tires, you may have limited ELD functionality. If the electronic locking differential has difficulty disengaging, release the accelerator pedal and turn the steering wheel in the opposite direction when rolling. We recommend engaging and disengaging the ELD at a stop when you mount a spare on the rear axle.

Brakes

GENERAL INFORMATION

Note: *Occasional brake noise is normal. If a metal-to-metal, continuous grinding or continuous squeal sound is present, the brake linings may be worn-out. Have the system checked by an authorized dealer. If your vehicle has continuous vibration or shudder in the steering wheel while braking, have it checked by an authorized dealer.*

Note: *Brake dust may accumulate on the wheels, even under normal driving conditions. Some dust is inevitable as the brakes wear and does not contribute to brake noise.*

Wet brakes result in reduced braking efficiency. Gently press the brake pedal a few times when driving from a car wash or standing water to dry the brakes.

Brake Over Accelerator

In the event the accelerator pedal becomes stuck or entrapped, apply steady and firm pressure to the brake pedal to slow the vehicle and reduce engine power. If you experience this condition, apply the brakes and bring your vehicle to a safe stop. Shift the transmission to park (P), switch the engine off and apply the parking brake. Inspect the accelerator pedal for any interference. If none are found and the condition persists, have your vehicle towed to the nearest authorized dealer.

Brake Assist

Brake assist detects when you brake rapidly by measuring the rate at which you press the brake pedal. It provides maximum braking efficiency as long as you press the pedal, and can reduce stopping distances in critical situations.

Anti-lock Brake System

This system helps you maintain steering control during emergency stops by keeping the brakes from locking.



This lamp momentarily illuminates when you switch the ignition on. If the light does not illuminate during start up, remains on or flashes, the system may be disabled. Have the system checked by an authorized dealer. If the anti-lock brake system is disabled, normal braking is still effective.

See **Warning Lamps and Indicators** (page 107).

Note: *Indicators vary depending on region.*



If the lamp remains illuminated after you release the parking brake, have the system checked by an authorized dealer.



It also illuminates momentarily when you switch the ignition on to confirm the lamp is functional. If it does not illuminate when you switch the ignition on, or begins to flash at any time, have the system checked by an authorized dealer.

Diesel Engine Exhaust Braking (if Equipped)



WARNING: Do not use tow/haul when the road surface is slippery. Failure to follow this instruction could result in the loss of control of your vehicle.



WARNING: Do not use diesel engine exhaust braking when the road surface is slippery. Failure to follow this instruction could result in the loss of control of your vehicle.

Brakes

This feature increases engine braking at higher engine speeds to provide better grade descent control with less brake and transmission wear and tear.

Note: Use this when driving downhill and carrying heavy loads or trailering.

Benefits of engine braking are:

- Lower brake temperature.
- Reduced brake fade.
- Longer brake life.
- Improved driving and trailering control.



Press the button on the switch bank next to the audio unit to switch the system on or off.

There are two engine brake modes, manual and automatic.

Manual Engine Braking

1. Press the button to switch on manual engine braking.
2. Release the accelerator pedal to maximize engine braking.
3. Apply the brakes. The transmission downshifts to lower gears.

Note: The engine braking feature only functions when you release the accelerator.

Note: You can shift the transmission to lower gears with progressive range selection (PRS) or manual shifting independent of pressing the brakes.

Note: You can also use manual engine braking with cruise control to improve grade descent control.

Note: If your vehicle has Adaptive Cruise Control, the speed control system uses the selected engine brake mode, transmission gears, and brakes to maintain the set speed and distance to the vehicle being followed.

Automatic Engine Braking

1. Press the button twice to switch on automatic engine braking.
2. Release the accelerator or brake pedal. The system remembers your vehicle speed.

Note: This feature offers smoother, less aggressive engine braking during downhill descents. It may not apply braking if the vehicle speed is not increasing, although it will apply full engine braking force when needed to prevent acceleration. The system automatically activates the engine brake and, if necessary, downshifts the transmission to lower gears to not exceed your vehicle's set speed when the brake or accelerator were last released.

Warning Lamp Conditions

- Illuminates when this feature is switched on and the system is operating properly. See **Warning Lamps and Indicators** (page 107).
- Flashes when the engine brake is disabled due to a fault or the engine does not meet the required braking conditions.
- Does not illuminate when the switch or indicator is faulty.

You can switch the system on at anytime. The system becomes active once the braking conditions are met.

Braking Conditions

- Your vehicle is in a forward gear.
- The engine speed is above about 1500 RPM.
- Your foot is off the accelerator.

Brakes

You can use this feature with tow/haul or progressive range selection to provide further increased engine braking. The transmission automatically upshifts to prevent the engine from entering the red zone on the tachometer. See **Automatic Transmission** (page 207).

HINTS ON DRIVING WITH ANTI-LOCK BRAKES

The anti-lock braking system does not eliminate the risks when:

- You drive too closely to the vehicle in front of you.
- Your vehicle is hydroplaning.
- You take corners too fast.
- The road surface is poor.

Note: *If the system activates, the brake pedal may pulse and may travel further. Maintain pressure on the brake pedal. You may also hear a noise from the system. This is normal.*

PARKING BRAKE



WARNING: Always set the parking brake fully and make sure the transmission is placed in park (P). Failure to set the parking brake and engage park could result in vehicle roll-away, property damage or bodily injury. Turn the ignition to the lock position and remove the key whenever you leave your vehicle.

Apply the parking brake whenever your vehicle is parked. Press the pedal downward to set the parking brake. The brake warning lamp in the instrument cluster will illuminate and remains illuminated until the parking brake is released.

To release, pull the brake release lever located at the lower left side of the instrument panel.

If you are parking your vehicle on a grade or with a trailer, press and hold the brake pedal down, then set the parking brake. There may be a little vehicle movement as the parking brake sets to hold the vehicle's weight. This is normal and should be no reason for concern. If needed, press and hold the service brake pedal down, then try reapplying the parking brake. Chock the wheels if required. If the parking brake cannot hold the weight of the vehicle, the parking brake may need to be serviced or the vehicle may be overloaded.

HILL START ASSIST



WARNING: The system does not replace the parking brake. When you leave your vehicle, always apply the parking brake.



WARNING: You must remain in your vehicle when the system turns on. At all times, you are responsible for controlling your vehicle, supervising the system and intervening, if required. Failure to take care may result in the loss of control of your vehicle, serious personal injury or death.



WARNING: The system will turn off if a malfunction is apparent or if you rev the engine excessively. Failure to take care may result in the loss of control of your vehicle, serious personal injury or death.

The system makes it easier to pull away when your vehicle is on a slope without the need to use the parking brake.

Brakes

When the system is active, your vehicle remains stationary on the slope for two to three seconds after you release the brake pedal. This allows time to move your foot from the brake to the accelerator pedal. The system releases the brakes automatically once the engine has developed sufficient torque to prevent your vehicle from rolling down the slope. This is an advantage when pulling away on a slope, for example from a car park ramp, traffic lights or when reversing uphill into a parking space.

The system activates on any slope that causes your vehicle to roll.

Note: *There is no warning light to indicate the system is either on or off.*

Using Hill Start Assist

1. Press the brake pedal to bring your vehicle to a complete standstill. Keep the brake pedal pressed and shift into first gear when facing uphill or reverse (R) when facing downhill.
2. If the sensors detect that your vehicle is on a slope, the system activates automatically.
3. When you remove your foot from the brake pedal, your vehicle remains on the slope without rolling away for about two to three seconds. This hold time automatically extends if you are in the process of driving off.
4. Drive off in the normal manner. The system releases the brakes automatically.

Note: *When you remove your foot from the brake pedal and press the pedal again when the system is active, you will experience significantly reduced brake pedal travel. This is normal.*

Switching the System On and Off

Vehicles with Manual Transmission

You can switch this feature on or off in the information display. The system remembers the last setting when you start your vehicle.

Vehicles with Automatic Transmission

You cannot turn the system on or off. When you switch the ignition on, the system automatically turns on.

Traction Control

PRINCIPLE OF OPERATION

The traction control system helps avoid drive wheel spin and loss of traction.

If your vehicle begins to slide, the system applies the brakes to individual wheels and, when needed, reduces engine power at the same time. If the wheels spin when accelerating on slippery or loose surfaces, the system reduces engine power in order to increase traction.

USING TRACTION CONTROL



WARNING: The stability and traction control light illuminates steadily if the system detects a failure. Make sure you did not manually disable the traction control system using the information display controls or the switch. If the stability control and traction control light is still illuminating steadily, have the system serviced by an authorized dealer immediately. Operating your vehicle with the traction control disabled could lead to an increased risk of loss of vehicle control, vehicle rollover, personal injury and death.

The system automatically turns on each time you switch the ignition on.

If your vehicle is stuck in mud or snow, switching traction control off may be beneficial as this allows the wheels to spin.

Note: *When you switch traction control off, stability control remains fully active.*

Note: *For additional information on the traction and stability control systems. See **Using Stability Control** (page 228).*

Switching the System Off

When you switch the system off or on, a message appears in the information display showing system status.

Use the traction and stability control switch on the instrument panel to switch the system off or on.

The switch illuminates when traction control is off.

When you place your vehicle into four-wheel drive low mode the traction control disables. Traction control resumes full operation when you put your vehicle back into two-wheel drive mode.

System Indicator Lights and Messages



The stability and traction control light:

- Temporarily illuminates on engine start-up.
- Flashes when a driving condition activates either of the systems.
- Illuminates if a problem occurs in either of the systems.



The stability and traction control off light temporarily illuminates on engine start-up and stays on when you switch the traction control system off.

Stability Control

PRINCIPLE OF OPERATION



WARNING: Vehicle modifications involving braking system, aftermarket roof racks, suspension, steering system, tire construction and wheel and tire size may change the handling characteristics of your vehicle and may adversely affect the performance of the electronic stability control system. In addition, installing any stereo loudspeakers may interfere with and adversely affect the electronic stability control system. Install any aftermarket stereo loudspeaker as far as possible from the front center console, the tunnel, and the front seats in order to minimize the risk of interfering with the electronic stability control sensors. Reducing the effectiveness of the electronic stability control system could lead to an increased risk of loss of vehicle control, vehicle rollover, personal injury and death.



WARNING: Remember that even advanced technology cannot defy the laws of physics. It's always possible to lose control of a vehicle due to inappropriate driver input for the conditions. Aggressive driving on any road condition can cause you to lose control of your vehicle increasing the risk of personal injury or property damage. Activation of the electronic stability control system is an indication that at least some of the tires have exceeded their ability to grip the road; this could reduce the operator's ability to control the vehicle potentially resulting in a loss of vehicle control, vehicle rollover, personal injury and death. If your electronic stability control system activates, SLOW DOWN.

The system automatically turns on each time you switch the ignition on.

If a fault occurs in either the stability control or the traction control system, you may experience the following conditions:

- The stability and traction control light illuminates steadily.
- The stability control and traction control systems do not enhance your vehicle's ability to maintain traction of the wheels.
- The Adaptive Steering system (if equipped) automatically changes the steering function to a fixed steering ratio. See **Steering** (page 261).

If a driving condition activates either the stability control or the traction control system you may experience the following conditions:

- The stability and traction control light flashes.
- Your vehicle slows down.
- Reduced engine power.
- A vibration in the brake pedal.
- The brake pedal is stiffer than usual.
- If the driving condition is severe and your foot is not on the brake, the brake pedal may move as the system applies higher brake force.

The stability control system has several features built into it to help you maintain control of your vehicle:

Electronic Stability Control

The system enhances your vehicle's ability to prevent skids or lateral slides by applying brakes to one or more of the wheels individually and, if necessary, reducing engine power.

Stability Control

Roll Stability Control

The system enhances your vehicle's ability to prevent rollovers by detecting your vehicle's roll motion and the rate at which it changes by applying the brakes to one or more wheels individually.

Traction Control

The system enhances your vehicle's ability to maintain traction of the wheels by detecting and controlling wheel spin. See **Using Traction Control** (page 226).

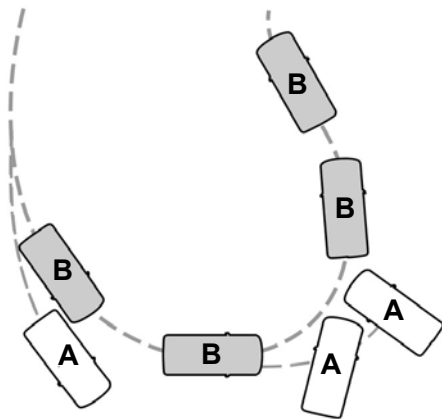

E72903

- A Vehicle without stability control skidding off its intended route.
- B Vehicle with stability control maintaining control on a slippery surface.

USING STABILITY CONTROL

AdvanceTrac® with Roll Stability Control™ (RSC®)

The system turns on each time you switch the ignition on.

You can switch the electronic stability control and roll stability control portions of the system off.

When you shift the transmission into reverse (R) the systems disable.



Use the traction and stability control switch on the instrument panel to switch the systems off or on.

You can independently switch off the traction control portion of the system.

Stability Control

AdvanceTrac with RSC Features				
Button functions	Stability control light	Roll stability control	Electronic stability control	Traction control system
Default at start-up	Illuminated during bulb check	Enabled	Enabled	Enabled
Button pressed momentarily	Illuminated	Enabled	Enabled ¹	Disabled
Button pressed and held for more than 5 seconds	illuminated ³	Disabled	Disabled	Disabled
Double Press (Pickup Only)	Illuminated	Enabled	Enabled ¹	Enabled ²
Button pressed again after deactivation	Not illuminated	Enabled	Enabled	Enabled
Transfer case switched to 4WD Low ⁴	Illuminated	Disabled	Disabled	Disabled

¹Electronic stability control has reduced sensitivity compared to a fully active system.

²Traction control has reduced sensitivity compared to a fully active system.

³Lamp light starts blinking for four seconds after entering the press and hold state.

⁴Engaging 4WD Low disables roll stability control, electronic stability control and the traction control systems.

Trail Control (If Equipped)

WHAT IS TRAIL CONTROL



WARNING: The system does not control speed in low traction conditions or extremely steep slopes. The system is designed to be an aid and does not relieve you of your responsibility to drive with due care and attention. Failure to follow this instruction could result in personal injury.



WARNING: The system does not replace the parking brake. When you leave your vehicle, always apply the parking brake and shift the transmission into park (P) for automatic transmission or first gear for manual transmission.

Trail control lets you focus on steering during low-speed and off-road use by controlling your vehicle's acceleration and braking.

You can use trail control under the following speeds:

- 20 mph (31 km/h) in two-wheel or four-wheel drive high range.
- 10 mph (15 km/h) in four-wheel drive low range.
- 5 mph (8 km/h) in reverse (R).

You may hear a noise from the anti-lock brake system pump motor when you use the system. This is normal.

SWITCHING TRAIL CONTROL ON AND OFF



Press the button.

The system switches off if you press the button again or exceed 42 mph (68 km/h).

SETTING THE TRAIL CONTROL SPEED

Note: The buttons are located on the steering wheel.

Drive to your preferred speed.

SET+

Press button to increase the set current speed.

SET-

Press button to decrease the set current speed.

Note: The indicator changes color.

You can adjust the set speed in small or large increments. Press the toggle button upward or downward once to adjust the set speed in small increments. Press and hold the toggle button upward or downward to adjust the set speed in large increments.

You can also adjust the set speed by braking.

Note: Pressing the brake pedal does not switch off the system.

CANCELING THE SET SPEED

CNCL

Press the button.

TRAIL CONTROL INDICATORS



Terrain Control (If Equipped)

PRINCIPLE OF OPERATION



WARNING: Hill descent control cannot control descent in all surface conditions and circumstances, such as ice or extremely steep grades. Hill descent control is a driver assist system and cannot substitute for good judgment by the driver. Failure to do so may result in loss of vehicle control, crash or serious injury.



WARNING: Hill descent control does not provide hill hold at zero miles per hour (0 kilometers per hour). When stopped, the parking brake must be applied or the vehicle must be placed in **P** (Park) or it may roll away.

Hill descent control allows the driver to set and maintain vehicle speed while descending steep grades in various surface conditions.

Hill descent control can maintain vehicle speeds on downhill grades between 2 mph (3 km/h) and 12 mph (20 km/h). Above 20 mph (32 km/h), the system remains armed, but descent speed cannot be set or maintained.

Hill descent control requires a cooling down interval after a period of sustained use. The amount of time that the feature can remain active before cooling varies with conditions. The system will provide a warning in the message center and a chime will sound when the system is about to disengage for cooling. At this time, manually apply the brakes as needed to maintain descent speed.

USING HILL DESCENT CONTROL



Press and release the hill descent button located on the instrument panel. A light in the cluster will illuminate and a chime will sound when this feature is activated.

To increase descent speed, press the accelerator pedal until the desired speed is reached. To decrease descent speed, press the brake pedal until the desired speed is reached.

Whether accelerating or decelerating, once the desired descent speed is reached, remove your feet from the pedals and the chosen vehicle speed will be maintained.

Note: *Noise from the ABS pump motor may be observed during hill descent control operation. This is a normal characteristic of the ABS and should be no reason for concern.*

Hill descent modes

- At speeds below 20 mph (32 km/h): When the Hill Descent Control switch is pressed and Hill Descent Control is active, the Hill Descent Control telltale will flash.
- At speeds below 20 mph (32 km/h): When the Hill Descent Control switch is pressed and conditions are not correct for hill descent activation, the Hill Descent Control system will be enabled, the Hill Descent Control telltale will be solid and a message will display in the information display.
- At speeds above 20 mph (32 km/h): When the Hill Descent Control switch is pressed, the Hill Descent Control system will be enabled, the telltale in the cluster will not be illuminated and a message will be displayed in the information display.

Terrain Control (If Equipped)

Refer to the Information Displays for additional Hill Descent Control messages. See **Information Messages** (page 123).

Parking Aids (If Equipped)

PRINCIPLE OF OPERATION



WARNING: To help avoid personal injury, always use caution when in reverse (R) and when using the sensing system.



WARNING: The system may not detect objects with surfaces that absorb reflection. Always drive with due care and attention. Failure to take care may result in a crash.



WARNING: Traffic control systems, inclement weather, air brakes, external motors and fans may affect the correct operation of the sensing system. This may cause reduced performance or false alerts.



WARNING: The system may not detect small or moving objects, particularly those close to the ground.

Note: *Certain add-on devices installed around the bumper or fascia may create false beeps. For example, large trailer hitches, bike or surfboard racks, license plate brackets, bumper covers or any other device that may block the normal detection zone of the system.*

Note: *Keep the sensors, located on the bumper or fascia, free from snow, ice and large accumulations of dirt. If the sensors are covered, the system's accuracy can be affected. Do not clean the sensors with sharp objects.*

Note: *If your vehicle sustains damage to the bumper or fascia, leaving it misaligned or bent, the sensing zone may be altered causing inaccurate measurement of obstacles or false alarms. See your authorized technician.*

Note: *When a trailer is connected to your vehicle, the rear parking aid may detect the trailer and therefore provide warnings. Disable the rear parking aid when a trailer is connected to prevent these warnings.*

Note: *The sensing system cannot be turned off when a MyKey is present. See **Principle of Operation** (page 62).*

The sensing system warns the driver of obstacles within a certain range of your vehicle. The system turns on automatically whenever you switch the ignition on.

When receiving a detection warning, the radio volume reduces to a predetermined level. After the warning goes away, the radio volume returns to the previous level.

The sensing system can be switched off through the information display menu or from the pop-up message that appears once you shift the transmission into reverse (R). See **General Information** (page 112).

If a fault is present in the system, a warning message appears in the information display and you cannot switch the system on through the pop-up message. See **Information Messages** (page 123).

REAR PARKING AID

The rear sensors are only active when the transmission is in reverse (R). As your vehicle moves closer to the obstacle, the rate of the audible warning increases. When the obstacle is less than 11.81 in (30 cm) away, the warning sounds continuously. If the system detects a stationary or receding object farther than 11.81 in (30 cm) from the corners of the bumper, the tone sounds for only two seconds. Once the system detects an object approaching, the warning sounds again.

Parking Aids (If Equipped)



E231381

Coverage area of up to 6 ft (1.8 m) from the rear bumper. There may be decreased coverage area at the outer corners of the bumper.

The system detects certain objects while the transmission is in reverse (R) :

- Your vehicle is moving toward a stationary object at a speed of 3 mph (5 km/h) or less.
- Your vehicle is not moving, but a moving object is approaching the rear of your vehicle at a speed of 3 mph (5 km/h) or less.
- Your vehicle is moving at a speed of less than 3 mph (5 km/h) and a moving object is approaching the rear of your vehicle at a speed of less than 3 mph (5 km/h).

The system provides audio warnings only when your vehicle is moving or when your vehicle is stationary and the detected obstacle is less than 12 in (30 cm) away from the bumper.

Obstacle Distance Indicator (If Equipped)

The system provides obstacle distance indication through the display screen. See **Rear View Camera** (page 234).

REAR VIEW CAMERA

 **WARNING:** The rear view camera system is a reverse aid supplement device that still requires the driver to use it in conjunction with the interior and exterior mirrors for maximum coverage.

 **WARNING:** Objects that are close to either corner of the bumper or under the bumper, might not be seen on the screen due to the limited coverage of the camera system.

 **WARNING:** Reverse your vehicle as slow as possible, higher speeds may limit your reaction time to stop your vehicle.

 **WARNING:** Use caution when the tailgate is ajar. If the tailgate is ajar, the camera will be out of position and the video image may be incorrect. All guidelines disappear when the tailgate is ajar. Some vehicles may not come equipped with guidelines.

 **WARNING:** Use caution when turning camera features on or off when the transmission is not in park (P). Make sure your vehicle is not moving.

The rear view camera system displays what is behind your vehicle when you shift the transmission into reverse (R).

During operation, lines appear in the display that represents the path of your vehicle and proximity to objects behind it.

Parking Aids (If Equipped)



The rear view camera is located on the tailgate.

Using the Rear View Camera System

The system uses three types of guides to help you see what is behind your vehicle:

- Active guidelines: Show the intended path of your vehicle when reversing.
- Fixed guidelines: Show the actual path your vehicle is moving while reversing in a straight line. This can be helpful when backing into a parking space or aligning your vehicle with another object behind you.
- Centerline: Helps align the center of your vehicle with an object (for example, a trailer).

Note: *If the transmission is in reverse (R) and the tailgate is ajar, no rear view camera features are displayed.*

Note: *If the image does not turn off while the transmission is not in reverse (R) and you are driving over a speed of 5 mph (8 km/h), have the system inspected by an authorized dealer.*

Note: *When towing, the camera only sees what is being towed behind your vehicle. This might not provide adequate coverage as it usually provides in normal operation and some objects might not be seen. In some vehicles, the guidelines may disappear once the trailer tow connector is engaged.*

The camera may not operate correctly under the following conditions:

- Nighttime or dark areas if the reverse lamps are not operating.
- Mud, water or debris obstructs the camera's view. Clean the lens with a soft, lint-free cloth and non-abrasive cleaner.
- The camera is misaligned due to damage to the rear of your vehicle.

Camera Guidelines

Note: *Active guidelines and fixed guidelines are only available when the transmission is in reverse (R).*

Note: *The centerline is only available if Active or Fixed guidelines are on.*

Note: *Some vehicles may not come equipped with guidelines.*

Parking Aids (If Equipped)

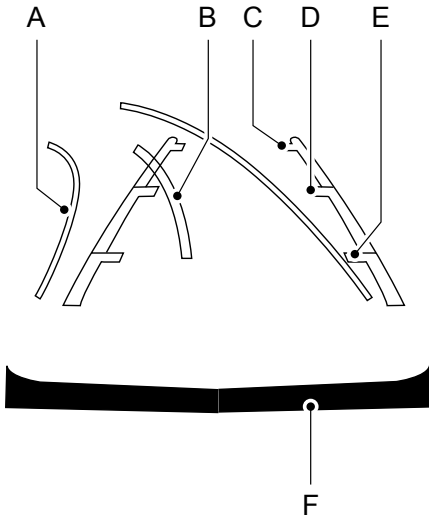

E142436

- A Active guidelines
- B Centerline
- C Fixed guideline: Green zone
- D Fixed guideline: Yellow zone
- E Fixed guideline: Red zone
- F Rear bumper

To use active guidelines, turn the steering wheel to point the guidelines toward an intended path. If the steering wheel position is changed while reversing, the vehicle might deviate from the original intended path.

The active guidelines fade in and out depending on the steering wheel position. The active guidelines are not shown when the steering wheel position is straight.

Always use caution while reversing. Objects in the red zone are closest to your vehicle and objects in the green zone are farther away. Objects are getting closer to your vehicle as they move from the green zone to the yellow or red zones. Use the side view mirrors and rear view mirror to get better coverage on both sides and rear of your vehicle.

Obstacle Distance Indicator



E190459

The system will provide an image of your vehicle and the sensor zones. The zones will highlight green, yellow and red when the parking aid sensors detect an object in the coverage area.

Rear Camera Delay

Selectable settings for this feature are ON and OFF.

Parking Aids (If Equipped)

When shifting the transmission out of reverse (R) and into any gear other than park (P), the camera image remains in the display until:

- Your vehicle speed sufficiently increases.
- You shift your vehicle into park (P).
- You apply the parking brake on vehicles with a manual transmission.

360 DEGREE CAMERA



WARNING: The 360 degree camera system still requires the driver to use it in conjunction with looking out of the windows, and checking the interior and exterior mirrors for maximum coverage.



WARNING: Objects that are close to either corner of the bumper or under the bumper, might not be seen on the screen due to the limited coverage of the camera system.



WARNING: Use caution when turning camera features on or off when the transmission is not in park (P). Make sure your vehicle is not moving.

Note: The 360 degree camera system turns off when your vehicle is in motion at low speed, except when in reverse (R).

The 360 degree camera system consists of front, side and rear cameras. The system:

- Allows you to see what is directly in front or behind your vehicle.
- Provides cross traffic view in front and behind your vehicle.

- Allows you to see a top-down view of the area outside your vehicle, including the blind spots.
- Provides visibility around your vehicle to you in parking maneuvers such as:
 - Centering in a parking space.
 - Obstacles near vehicle.
 - Parallel parking.

Camera Views



The camera button is located on the instrument panel. Pressing the camera button activates the system.

When in park (P), neutral (N) or drive (D), only images from the front cameras are displayed. Press the camera button to display the front camera image on the display screen.

When in reverse (R), only images from the rear cameras are displayed. When you shift into reverse (R), the rear view camera image automatically shows on the display screen.

Advanced Camera Views (If Equipped)



Additional camera views may be available for vehicles with specific features. Press the small camera icon shown on the top left corner of the display screen to open the camera view menu.

The following camera views can be accessed in park (P), neutral (N) or drive (D) when you press the camera button:

- **Front 360 + Normal:** Contains the normal front camera view next to a 360 degree camera view.
- **Front Normal View:** Provides an image of what is directly in front of your vehicle.

Parking Aids (If Equipped)

- **Front Split View:** Provides an extended view of what is in front of your vehicle.
- **Rear High View:** Provides an image of your truck bed and can be used to assist you when backing up to align and hitch a fifth wheel or gooseneck trailer.
- **Auxiliary View:** Provides a rear view image from the back of your trailer while reversing.

The following camera views can be accessed when you shift into reverse (R):

- **Rear 360 + Normal:** Contains the normal rear camera view next to a 360 degree camera view. Press the zoom (+) button to quickly access Rear Normal View from this screen.
- **Rear Normal View:** Provides an image of what is directly behind your vehicle.
- **Rear Split View:** Provides an extended view of what is behind your vehicle.
- **Rear High View:** Provides an image of your truck bed and can be used to assist you when backing up to align and hitch a fifth wheel or gooseneck trailer.
- **Auxiliary View:** Provides a rear view image from the back of your trailer while reversing.
- **Trailer Reverse Guidance View:** Provides an image of the rear of your vehicle using the side cameras, useful when reversing with a trailer. Use the arrows at the bottom of the screen to adjust the side camera position. See **Trailer Reversing Aids** (page 279).

Keep Out Zone

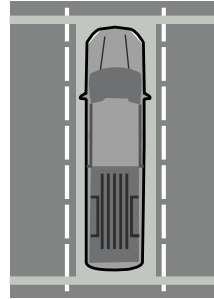

E184448

The Keep Out Zone is represented by the yellow dotted lines running parallel to your vehicle. It is designed to give you the indication on the ground of the fully extended outside mirror position.

Front Camera



WARNING: The front camera system still requires the driver to use it in conjunction with looking out of your vehicle.



E184044

Parking Aids (If Equipped)

The front video camera, located in the grille, provides a video image of the area in front of your vehicle. It adds assistance to the driver while driving forward at low speeds. To use the front video camera system, place the transmission in any gear except reverse (R). An image will display once the camera enable button is pressed. The area displayed on the screen may vary according to your vehicle's orientation and/or road condition.

Side Camera

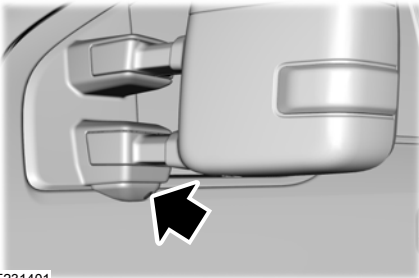

E231401

The side view camera, located in the outside mirror, provide a video image of the area on the sides of your vehicle. It aids you while parking your vehicle, or when parking with a trailer attached.

Note: Use caution when using the 360 view while any of the doors are ajar. If a door is ajar, the camera will be out of position and the video image may be incorrect.

Bed View Camera (If Equipped)

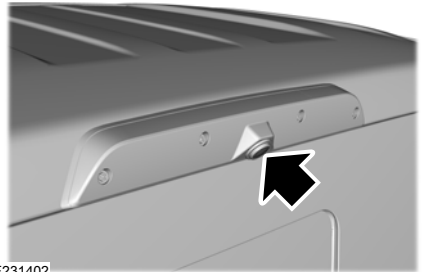

E231402

The bed view camera system is a variant of the rear view camera that is mounted within the high-mount stop lamp. It is designed to display the contents of your truck bed or assist you when backing up to align and hitch a fifth wheel or gooseneck trailer. The bed view camera is not meant as an alternative to the rear view camera.

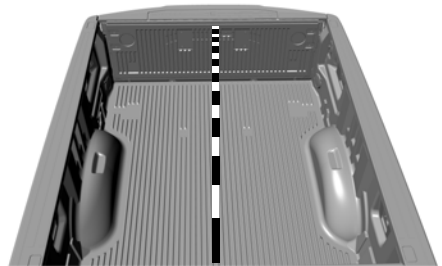

E233763

The camera view contains a dynamic guideline to help you locate the center of your vehicle. This view can only be accessed while in reverse (R).

Auxiliary Camera (If Equipped)

Note: The auxiliary camera works with trailers up to 50 ft (15 m) in length.

Parking Aids (If Equipped)



Access the auxiliary camera view by pressing the button on the display screen when in reverse (R).

The auxiliary camera system is a variant of the rear view camera. It is designed to display a rear view image from the back of a trailer while reversing. The auxiliary camera is not meant as an alternative to the rear view camera.

Cruise Control (If Equipped)

WHAT IS CRUISE CONTROL

Cruise control lets you maintain a set speed without keeping your foot on the accelerator pedal. You can use cruise control when your vehicle speed is greater than 20 mph (30 km/h).

SWITCHING CRUISE CONTROL ON AND OFF



WARNING: Do not use cruise control on winding roads, in heavy traffic or when the road surface is slippery. This could result in loss of vehicle control, serious injury or death.

The cruise controls are on the steering wheel. See **Cruise Control** (page 84).

Switching Cruise Control On

ON

Press the button.

Switching Cruise Control Off

OFF

Press the button when the system is in standby mode.

The system also turns off when you switch the ignition off.

Note: *The set speed erases when you switch the system off.*

SETTING THE CRUISE CONTROL SPEED



WARNING: When you are going downhill, your vehicle speed could increase above the set speed. The system does not apply the brakes.

Drive to the speed you prefer.

SET+

Press either button to set the current speed.

SET-

Take your foot off the accelerator pedal.

Note: *The indicator changes color in the information display.*

Changing the Set Speed

SET+

Press and release the button to increase the set speed in small increments.

Press and hold the button to accelerate. Release the button when you reach your preferred speed.

SET-

Press and release the button to decrease the set speed in small increments.

Press and hold the button to decelerate. Release the button when you reach your preferred speed.

Note: *If you accelerate by pressing the accelerator pedal, the set speed does not change. When you release the accelerator pedal, your vehicle returns to the speed that you previously set.*

CANCELING THE SET SPEED

CNCL

Press the button, or tap the brake pedal to cancel the set speed.

Note: *The system remembers the set speed.*

Note: *The system cancels if the vehicle speed drops below 10 mph (16 km/h) under the set speed when driving uphill.*

Cruise Control (If Equipped)

RESUMING THE SET SPEED



Press the button.

CRUISE CONTROL INDICATORS



Illuminates when you switch the system on.

USING ADAPTIVE CRUISE CONTROL



WARNING: You are responsible for controlling your vehicle at all times. The system is designed to be an aid and does not relieve you of your responsibility to drive with due care and attention. Failure to follow this instruction could result in the loss of control of your vehicle, personal injury or death.



WARNING: Pay close attention to changing road conditions such as entering or leaving a highway, on roads with intersections or roundabouts, roads without visible lanes of travel, roads that are winding, slippery, unpaved, or steep slopes.



WARNING: Do not use the system in poor visibility, for example fog, heavy rain, spray or snow.



WARNING: Do not use the system when towing a trailer that has aftermarket electronic trailer brake controls. Failure to follow this instruction could result in the loss of control of your vehicle, personal injury or death.



WARNING: Do not use tire sizes other than those recommended because this can affect the normal operation of the system. Failure to do so may result in a loss of vehicle control, which could result in serious injury.



WARNING: The system may not detect stationary or slow moving vehicles below 6 mph (10 km/h).



WARNING: The system does not detect pedestrians or objects in the road.



WARNING: The system does not detect oncoming vehicles in the same lane.



WARNING: The system is not a crash warning or avoidance system.



WARNING: Do not use the system with a snow plow blade installed.

The system adjusts your vehicle speed to maintain the set gap between you and the vehicle in front of you in the same lane. You can select four gap settings.

The system uses a radar sensor that projects a beam directly in front of your vehicle.



E262918

Cruise Control (If Equipped)

The adaptive cruise controls are on the steering wheel.

Switching Adaptive Cruise Control On

ON

Press and release the button.



The indicator, current gap setting and set speed appear in the information display.



E233874

Setting the Adaptive Cruise Speed

Drive to your preferred speed.

SET+

SET-

Press and release either button.

Take your foot off the accelerator pedal.

The indicator, current gap setting and set speed appear in the information display.



E233874

A vehicle graphic illuminates if there is a vehicle detected in front of you.

Note: When adaptive cruise control is active, the speedometer may vary slightly from the set speed displayed in the information display.

Following a Vehicle



WARNING: When following a vehicle that is braking, your vehicle does not always decelerate quickly enough to avoid a crash without driver intervention. Apply the brakes when necessary. Failure to follow this instruction could result in personal injury or death.



WARNING: The system only warns of vehicles detected by the radar sensor. In some cases there may be no warning or a delayed warning. Apply the brakes when necessary. Failure to follow this instruction could result in personal injury or death.

Note: When you are following a vehicle and you switch on a direction indicator, adaptive cruise control may provide a small temporary acceleration to help you pass.

Note: The brakes may emit noise when applied by the system.

Cruise Control (If Equipped)

When a vehicle ahead of you enters the same lane or a slower vehicle is ahead in the same lane, the vehicle speed adjusts to maintain a preset gap distance. A vehicle graphic illuminates in the instrument cluster.

Your vehicle maintains a consistent gap from the vehicle ahead until:

- The vehicle in front of you accelerates to a speed above the set speed.
- The vehicle in front of you moves out of the lane you are in.
- Your vehicle speed falls below 12 mph (20 km/h).
- You set a new gap distance.

The system applies the brakes to slow your vehicle to maintain a safe gap distance from the vehicle in front. The system only applies limited braking. You can override the system by applying the brakes.

If the system determines that its maximum braking level is not sufficient, an audible warning sounds, a message appears in the information display and an indicator flashes when the system continues to brake. Take immediate action.

Setting the Gap Distance

You can decrease or increase the distance between your vehicle and the vehicle in front by pressing the gap control.



Press and release to decrease the gap distance.



Press and release to increase the gap distance.



E233874

The selected gap appears in the information display as shown by the bars in the image.

Note: *The gap setting is time dependent and therefore the distance adjusts with your vehicle speed.*

Note: *It is your responsibility to select a gap appropriate to the driving conditions.*

Adaptive Cruise Control Gap Settings

Graphic Display, Bars Indicated Between Vehicles	Distance Gap	Dynamic Behavior
1	Closest.	Sport.
2	Close.	Normal.
3	Medium.	Normal.
4	Far.	Comfort.

Each time you switch the system on, it selects the last chosen gap setting.

Cruise Control (If Equipped)

Overriding the Set Speed



WARNING: If you override the system by pressing the accelerator pedal, it does not automatically apply the brakes to maintain a gap from any vehicle ahead.

When you press the accelerator pedal, you override the set speed and gap distance.



Use the accelerator pedal normally to intentionally exceed the set speed limit.

When you override the system, the green indicator light illuminates and the vehicle image does not appear in the information display.

The system resumes operation when you release the accelerator pedal. The vehicle speed decreases to the set speed, or a lower speed if following a slower vehicle.

Changing the Set Speed

SET+

Press and release to increase the set speed in small increments.

SET-

Press and release to decrease the set speed in small increments.

Press and hold either button to change the set speed in large increments. Release the button when you reach your preferred speed.

The system may apply the brakes to slow the vehicle to the new set speed. The set speed displays continuously in the information display when the system is active.

Canceling the Set Speed

CNCL

Press and release the button or tap the brake pedal.

The set speed does not erase.

Note: If you press the clutch pedal (manual transmission only) for an extended period, this action also cancels the set speed.

Resuming the Set Speed

RES

Press and release the button.

Your vehicle speed returns to the previously set speed and gap setting. The set speed displays continuously in the information display when the system is active.

Note: Only use resume if you are aware of the set speed and intend to return to it.

Automatic Cancellation

The system is not functional at vehicle speeds below 12 mph (20 km/h). The information display indicates low engine speed, an audible alarm sounds and the automatic braking releases if the vehicle drops below this speed.

Automatic cancellation can also occur when:

- The tires lose traction.
- You apply the parking brake.

Note: If the engine speed drops too low, an audible warning sounds and a message appears in the information display. Automatic braking releases.

Hilly Condition and Trailer Tow Usage

You should select a lower gear when the system is active in situations such as prolonged downhill driving on steep grades, for example in mountainous areas. The system needs additional engine braking in these situations to reduce the load on the vehicle's regular brake system to prevent it from overheating.

Cruise Control (If Equipped)

Note: An audible alarm sounds and the system shuts down if it applies brakes for an extended period of time. This allows the brakes to cool. The system functions normally again after the brakes cool.

Note: When towing with adaptive cruise control, switch on Tow/Haul Mode and Diesel Engine Brake.

Note: Tow/Haul mode increases the time gaps and allows more distance for braking.

Switching Adaptive Cruise Control Off

OFF

Press and release the button when the system is in standby mode, or switch the ignition off.

Note: You erase the set speed and gap setting when you switch the system off.

Detection Issues



WARNING: On rare occasions, detection issues can occur due to the road infrastructures, for example bridges, tunnels and safety barriers. In these cases, the system may brake late or unexpectedly. At all times, you are responsible for controlling your vehicle, supervising the system and intervening, if required.



WARNING: If the system malfunctions, have your vehicle checked as soon as possible.

The radar sensor has a limited field of view. It may not detect vehicles at all or detect a vehicle later than expected in some situations. The lead vehicle graphic does not illuminate if the system does not detect a vehicle in front of you.

A

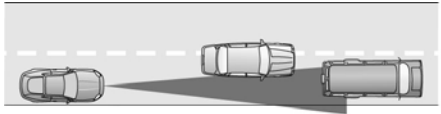

B

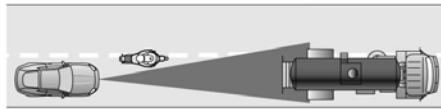

C

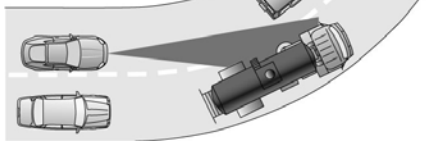

E71621

Detection issues can occur:

- A When driving on a different line than the vehicle in front.
- B With vehicles that edge into your lane. The system can only detect these vehicles once they move fully into your lane.
- C There may be issues with the detection of vehicles in front when driving into and coming out of a bend or curve in the road.

In these cases, the system may brake late or unexpectedly. You should stay alert and take action when necessary.

If something hits the front end of your vehicle or damage occurs, the radar-sensing zone may change. This could cause missed or false vehicle detection.

Cruise Control (If Equipped)

Optimal system performance requires a clear view of the road by the windshield-mounted camera.

Optimal performance may not occur if:

- The camera is blocked.
- There is poor visibility or lighting conditions.
- There are bad weather conditions.

System Not Available

Conditions that can cause the system to deactivate or prevent the system from activating when requested include:

- A blocked sensor.
- High brake temperature.
- A failure in the system or a related system.

Blocked Sensor



E243054

The camera is mounted on the windshield behind the interior mirror.

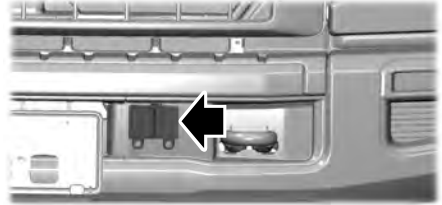

A message displays if something obstructs the radar signals from the sensor. The sensor is in the lower grille. The system cannot detect a vehicle ahead and does not function when something blocks the sensor.

Note: You cannot see the sensor. It is behind a fascia panel.

Keep the front of your vehicle free of dirt, metal badges or objects. Vehicle front protectors and aftermarket lights may also block the sensor.

Possible Causes and Actions for This Message Displaying:

Cause	Action
The surface of the radar is dirty or obstructed.	Clean the grille surface in front of the radar or remove the object causing the obstruction.
The surface of the radar is clean but the message remains in the display.	Wait a short time. It may take several minutes for the radar to detect that it is free from obstruction.
Heavy rain or snow is interfering with the radar signals.	Do not use the system in these conditions because it may not detect any vehicles ahead.

Cruise Control (If Equipped)

Cause	Action
Water, snow or ice on the surface of the road may interfere with the radar signals.	Do not use the system in these conditions because it may not detect any vehicles ahead.
You are in a desert or remote area with no other vehicles and no roadside objects.	Wait a short time or switch to normal cruise control.

Due to the nature of radar technology, it is possible to get a blockage warning with no actual block. A false blocked condition either self clears, or clears after you restart your vehicle.

Switching to Normal Cruise Control



WARNING: Normal cruise control will not brake when your vehicle is approaching slower vehicles. Always be aware of which mode you have selected and apply the brakes when necessary.



The cruise control indicator light replaces the adaptive cruise control indicator light if you select normal cruise control. The gap setting does not display, and the system does not respond to lead vehicles. Automatic braking remains active to maintain set speed.

You can change from adaptive cruise control to normal cruise control through the information display.

Driving Aids

DRIVER ALERT (IF EQUIPPED)



WARNING: You are responsible for controlling your vehicle at all times. The system is designed to be an aid and does not relieve you of your responsibility to drive with due care and attention. Failure to follow this instruction could result in the loss of control of your vehicle, personal injury or death.



WARNING: The system may not function if the sensor is blocked.



WARNING: Take regular rest breaks if you feel tired. Do not wait for the system to warn you.



WARNING: Certain driving styles may result in the system warning you even if you are not feeling tired.



WARNING: In cold and severe weather conditions the system may not function. Rain, snow and spray can all limit sensor performance.



WARNING: The system will not operate if the sensor cannot track the road lane markings.



WARNING: If damage occurs in the immediate area surrounding the sensor, have your vehicle checked as soon as possible.



WARNING: The system may not correctly operate if your vehicle is fitted with a suspension kit not approved by us.

Note: Keep the windshield free from obstructions. For example, bird droppings, insects and snow or ice.

Note: If you have a blocked camera or damaged windshield, the system may not function.

Note: The system remembers the last setting when you start your vehicle, unless it detects a MyKey™.

Note: If enabled in the menu, the system activates at speeds above 40 mph (64 km/h).

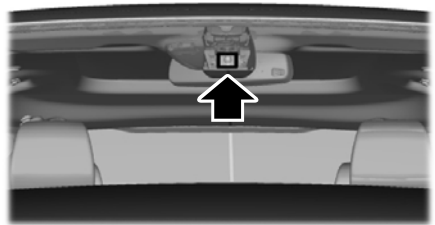

E249505

The system monitors your driving behavior using various inputs including the front camera sensor.

If the system detects reduced driving alertness below a certain threshold, the system alerts you using a tone and a message in the information display.

Using Driver Alert

Switching the system on and off

You may switch the system on or off through the information display by selecting Settings, Driver Assist and then Driver Alert in the menu. When activated, the system monitors your alertness level based upon your driving behavior in relation to the lane markings, and other factors.

System Warnings

Note: The system does not issue warnings below approximately 40 mph (64 km/h).

Driving Aids

The warning system is in two stages. At first the system issues a temporary warning that you need to take a rest. This message only appears for a short time. If the system detects further reduction in driving alertness, another warning could be issued which remains in the information display for a longer time. Press OK on the steering wheel control to clear the warning. When active the system runs in the background and only issues a warning if required.

Resetting the System

You can reset the system by either:

- Switching the ignition off and on.
- Stopping the vehicle and then opening and closing the driver door.

LANE KEEPING SYSTEM (IF EQUIPPED)

WARNING: You are responsible for controlling your vehicle at all times. The system is designed to be an aid and does not relieve you of your responsibility to drive with due care and attention. Failure to follow this instruction could result in the loss of control of your vehicle, personal injury or death.

WARNING: Always drive with due care and attention when using and operating the controls and features on your vehicle.

WARNING: In cold and severe weather conditions the system may not function. Rain, snow and spray can all limit sensor performance.

WARNING: The system will not operate if the sensor cannot track the road lane markings.

WARNING: The sensor may incorrectly track lane markings as other structures or objects. This can result in a false or missed warning.

WARNING: Large contrasts in outside lighting can limit sensor performance.

WARNING: The system may not operate properly if the sensor is blocked. Keep the windshield free from obstruction.

WARNING: If damage occurs in the immediate area surrounding the sensor, have your vehicle checked as soon as possible.

WARNING: The system may not correctly operate if your vehicle is fitted with a suspension kit not approved by us.

Note: The system works as long as the camera can detect one lane marking at a speed above 40 mph (64 km/h).

Note: The system may not function with a blocked camera, or if the windshield is damaged or dirty.

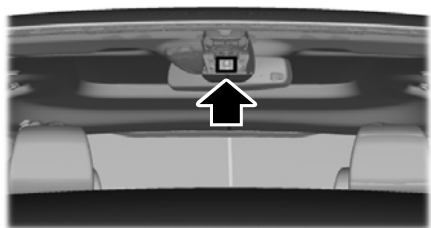

E249505

Driving Aids

When you switch the system on and it detects an unintentional drift out of your lane is likely to occur, the system notifies or assists you to stay in your lane through the steering system and information display. The system provides an audible warning and by vibrating the steering wheel.

Switching the System On and Off

Note: The system on or off setting is stored until it is manually changed, unless a MyKey is detected. If the system detects a MyKey, it defaults to on and the mode is set to alert.

Note: If a MyKey is detected, pressing the button does not affect the on or off status of the system. You can only change the mode and intensity settings.



Press the button to switch the system on or off. The button is above the audio unit or on the center console.

System Settings

The system sensitivity and intensity can be adjusted through the display screen. See **General Information** (page 112). The system remembers the last selection. You do not need to readjust the setting each time you turn on your vehicle.

Sensitivity: This setting allows you to select where in the lane a warning is provided. Increasing the sensitivity setting moves the warning zones in closer to your vehicle.

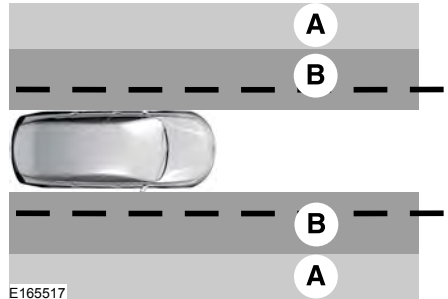

- A Normal
- B Increased

Note: The alert diagram illustrates general zone coverage. It does not provide exact zone parameters.

Intensity: This setting affects the intensity of the steering wheel vibration. Increasing the intensity causes a higher rate of haptic feedback.

- High.
- Normal.
- Low.

System Display



E233874

When you switch on the system, a graphic with lane markings appears in the display screen.

Driving Aids

Note: *The overhead vehicle graphic may still display if adaptive cruise control is enabled.*

While the system is on, the color of the lane markings change to indicate the system status.

Gray: Indicates that the system is temporarily unable to provide a warning on the indicated side(s). This may be because:

- Your vehicle is under the activation speed.
- The direction indicator is active.
- Your vehicle is in a dynamic maneuver.
- The road has no or poor lane markings in the camera field-of-view.
- The camera is obscured or unable to detect the lane markings due to environmental, traffic or vehicle conditions. For example, significant sun angles, shadows, snow, heavy rain or fog, following a large vehicle that is blocking or shadowing the lane or poor headlamp illumination.

See **Troubleshooting** for additional information.

Green: Indicates that the system is available or ready to provide a warning on the indicated side(s).

Red: Indicates that the system is providing or has just provided a lane keeping alert warning.

You can temporarily disable the system at any time by doing the following:

- Quick braking.
- Fast acceleration.
- Using your direction indicator.
- Evasive steering maneuver.
- Driving too close to the lane markings.

Troubleshooting

Why is the feature not available (line markings are gray) when I can see the lane markings on the road?
Your vehicle speed is outside the operational range of the feature.
The sun is shining directly into the camera lens.
A quick intentional lane change has occurred.
Your vehicle stays too close to the lane markings.
Driving at high speeds in curves.
The last feature activation occurred a short time ago.
Ambiguous lane markings, for example in construction zones.
Rapid transition from light to dark, or from dark to light.
Sudden offset in lane markings.

Driving Aids

Why is the feature not available (line markings are gray) when I can see the lane markings on the road?
ABS or AdvanceTrac™ is active.
There is a camera blockage due to dirt, grime, fog, frost or water on the windshield.
You are driving too close to the vehicle in front of you.
Transitioning between no lane markings to lane markings or vice versa.
There is standing water on the road.
Faint lane markings, for example partial yellow lane markings on concrete roads.
Lane width is too narrow or too wide.
The camera has not been calibrated after a windshield replacement.
Driving on tight roads or on uneven roads.
Vehicle accessories are blocking the camera, for example a snow plow.

BLIND SPOT INFORMATION SYSTEM (IF EQUIPPED)



WARNING: Do not use the blind spot information system as a replacement for using the interior and exterior mirrors or looking over your shoulder before changing lanes. The blind spot information system is not a replacement for careful driving.

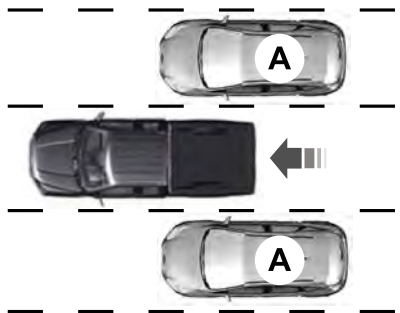

E227388

The Blind Spot Information System is designed to aid you in detecting vehicles that may have entered the blind spot zone (A). The detection area is on both sides of your vehicle, extending rearward from the exterior mirrors to approximately 13 ft (4 m) beyond the bumper. The system is designed to alert you if certain vehicles enter the blind spot zone while driving.

Driving Aids

Note: The Blind Spot Information System does not prevent contact with other vehicles or objects; nor detect parked vehicles, people, animals or infrastructure (fences, guardrails, trees). It is only designed to alert you to moving vehicles in the blind spot zones.

Note: When a vehicle passes quickly through the blind spot zone, typically fewer than two seconds, the system does not trigger.

Using the System

The Blind Spot Information System turns on when you start the engine and you drive your vehicle forward above 5 mph (8 km/h).

For automatic transmissions, the Blind Spot Information System remains on while the transmission is in drive (D). If shifted into reverse (R) or park (P) the Blind Spot Information System turns off. Once shifted back into drive (D), the Blind Spot Information System turns back on when you drive your vehicle above 5 mph (8 km/h).

Note: For automatic transmissions, the Blind Spot Information System does not function in reverse (R) or park (P).

For manual transmissions, the Blind Spot Information System is on for all gears except reverse (R).

System Lights and Messages



E142442

The Blind Spot Information System illuminates an amber alert indicator in the outside mirror on the side of your vehicle the approaching vehicle is coming from. When the Blind Spot Information System is alerting on a vehicle and the corresponding turn signal is ON, the Blind Spot Information System alert indicator flashes as an increased warning level.

The alert indicator dims when the system detects nighttime darkness.

Note: The alert indicator flashes in case of an alert and the turn signal is set to that side at the same time.

System Sensor Blockage



E231384

Driving Aids

The system uses radar sensors that are located inside the tail lamp on each side of your vehicle. Any dirt, mud and snow in front of the sensors or driving in heavy rain can cause system degradation. Also, other types of obstructions in front of the sensor can cause system degradation. This is referred to as a 'blocked' condition.

Note: Do not apply bumper stickers and/or repair compound to these areas, this can cause degraded system performance.

If the system detects a degraded performance condition, a message warning appears in the display screen. The alert indicators remain ON and the system no longer provides any warnings. You can clear the warning but the alert indicators remain illuminated.

A "blocked" condition can be cleared in two ways:

- After the blockage in front of the sensors is removed or the rainfall/snowfall rate decreases or stops, drive for a few minutes in traffic to allow the sensors to detect passing vehicles.
- By cycling the ignition from ON to OFF and then back ON.

Note: If your vehicle has a tow bar with a factory equipped trailer tow module and it is towing a trailer, the sensors will automatically turn the Blind Spot Information System off. If your vehicle has a tow bar but no factory equipped trailer tow module, it is recommended to turn the Blind Spot Information System off manually. Operating the Blind Spot Information System without the Blind Spot Trailer Tow package and a trailer attached will cause poor system performance.

Blind Spot Information System with Trailer Tow (If Equipped)

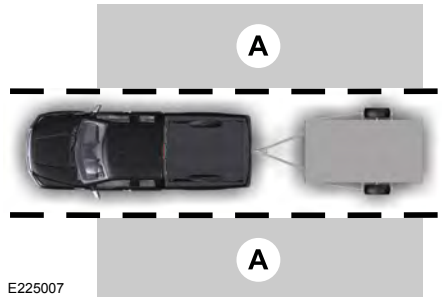

The Blind Spot Information System with Trailer Tow is designed to aid you in detecting vehicles that may have entered the detection area zone (A). The detection area is on both sides of your vehicle and trailer, extending rearward from the exterior mirrors to the end of your trailer.

When a trailer is attached and the customer has set up a Blind Spot Trailer, the Blind Spot Information System with Trailer Tow becomes active when driving forward above 6 mph (10 km/h). See **Trailer Reversing Aids** (page 279).

The Blind Spot Information System with Trailer Tow can be turned off in the instrument cluster. If the Blind Spot Information System is turned off, then the Blind Spot Information System with Trailer Tow automatically turns off.

Driving Aids

Setting up a Blind Spot Trailer

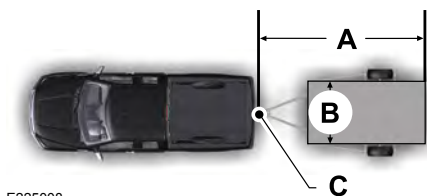

E225008

- A Trailer length
- B Trailer width
- C Trailer hitch ball

You can set-up any trailer to work with the Blind Spot Information System with Trailer Tow through the instrument cluster menu. See **General Information** (page 112). While setting up a trailer, a sequence of screens appear asking for trailer information. The Blind Spot Information System with Trailer Tow specific screens are described below:

- Select type of trailer screen - Conventional, fifth wheel or gooseneck.

The Blind Spot Information System with Trailer Tow only supports conventional trailers. If fifth wheel or gooseneck is selected, the system automatically turns off.

- Do you want to set up BLIS with trailer screen?

If no, the Blind Spot Information System turns off.

If yes, the menu goes to the next screen.

- Is the width less than 9 ft (2.7 m) and length less than 33 ft (10.1 m)?

If no, the Blind Spot Information System turns off.

If yes, the menu goes to the next screen.

- Trailer width measurement:

The width of the trailer is measured at the front of the trailer. It is not measured at the widest point of the trailer. The maximum width at the front of the trailer that the Blind Spot Information System with Trailer Tow can support is 8.5 ft (2.6 m).

Note: You do not need to enter an exact trailer width measurement; just measure that it is 8.5 ft (2.6 m) or less.

- Trailer length measurement:

The trailer length is the distance between the trailer hitch ball and the rear of the trailer. The maximum length that the Blind Spot Information System with Trailer Tow can support is 33 ft (10.1 m).

- Enter length of trailer:

The default setting is 18 ft (5.5 m). Toggling up or down using the menu buttons will increase/decrease the measurement by 3 ft (1 m). Select the length so that the value is equal to or within 3 ft (1 m) of the actual measured length. For example, if the actual measured length is 25 ft (7.6 m), then toggle the length in the menu to 27 ft (8.2 m). When the length has been entered, the Blind Spot Information System with Trailer Tow setup is saved.

If you do not set up a Blind Spot Trailer, a warning appears in the instrument cluster when a trailer is connected stating that the system has been turned off due to a trailer connect.

Note: If the trailer is actually a bike rack or cargo rack with electrical lighting, then the length will be 3 ft (1 m). Cross Traffic Alert will remain on for trailers 3 ft (1 m) or less.

Note: Proper measurement and measurement entry is required for Blind Spot Information System with Trailer Tow to function as designed.

Driving Aids

System Operation

If you select a trailer in the display screen prior to connecting the trailer, the system will load that configuration and the information cluster displays a message when the trailer is connected. A second message appears stating Cross Traffic Alert has been turned off; the Blind Spot Information System with Trailer Tow still functions normally when driving forward.

If no trailer has been set up and a trailer is connected, the instrument cluster provides a message indicating a trailer is connected followed by a message asking to select a trailer from the existing list of trailers or to add a trailer. In order for the Blind Spot Information System with Trailer Tow to function, an existing trailer must be selected or a new trailer must be added. If the request is ignored or if you exit the screen, a message appears prompting you that the system has been turned off due to a trailer connect. This message may not appear until your vehicle speed reaches 22 mph (35 km/h).

The Blind Spot Information System with Trailer Tow activates when driving forward for that particular trailer set up. If the ignition is cycled, the Blind Spot Information System with Trailer Tow continues to function using the last trailer selected.

Trailer Considerations

The Blind Spot Information System with Trailer Tow is designed to work with any trailer whose front width is 8.5 ft (2.6 m) or less and total length from the trailer hitch ball to the rear of the trailer is 33 ft (10.1 m) or less. Different trailers may cause a slight change in performance as outlined below.

Large box trailers may cause false alerts to trigger when driving next to buildings or near parking cars. A false alert may also occur while making a 90-degree turn.

Trailers that are 8.5 ft (2.6 m) wide at the front and have a total length greater than 20 ft (6 m) may have delayed alerts from passing vehicles when the vehicle is passing at high speed.

A box trailer whose front width is 8.5 ft (2.6 m) may cause early alerts when you are overtaking a vehicle.

When towing a clam shell or V-Nose box trailer with a front width of 8.5 ft (2.6 m), delayed alerts on merging vehicles that are traveling the same speed as your vehicle may occur.

System Errors

If the system senses a problem with the left or right sensor, the telltale illuminates and a message appears in the display screen. See **Information Messages** (page 123).

Switching the System Off and On

You can temporarily switch the Blind Spot Information System off in the display screen. See **General Information** (page 112). When the Blind Spot Information System switches off, you do not receive alerts and the display screen shows a system off message. The telltale in the cluster also illuminates. When you switch the Blind Spot Information System on or off, the alert indicators flash twice.

Note: *The Blind Spot Information System remembers the last selected on or off setting.*

You can also have the Blind Spot Information System switched off permanently at an authorized dealer. Once switched off permanently, the system can only be switched back on at an authorized dealer.

Driving Aids

CROSS TRAFFIC ALERT (IF EQUIPPED)



WARNING: Do not use the cross traffic alert system as a replacement for using the interior and exterior mirrors or looking over your shoulder before reversing out of a parking space. The cross traffic alert system is not a replacement for careful driving.



WARNING: The system may not operate properly during severe weather conditions, for example snow, ice, heavy rain and spray. Always drive with due care and attention. Failure to take care may result in a crash.

The system alerts you of vehicles approaching from the sides behind your vehicle when you shift into reverse (R).

Using Cross Traffic Alert

The system detects vehicles that approach at a speed between 4 mph (6 km/h) and 37 mph (60 km/h). Coverage decreases when the sensors are partially, mostly or fully obstructed. Slowly reversing helps increase the coverage area and effectiveness.

The system turns on when you start the engine and you shift into reverse (R). The system turns off when you shift out of reverse (R).

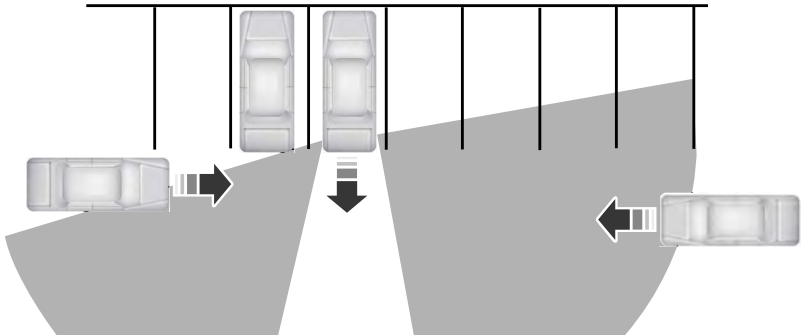

E142440

The sensor on the left-hand side is only partially obstructed and zone coverage on the right-hand side is maximized.

Driving Aids

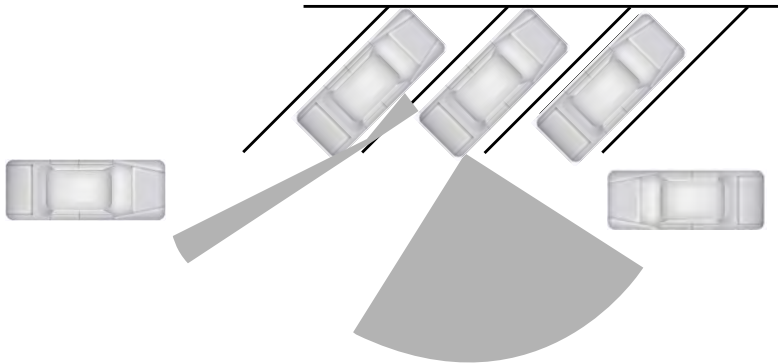

E142441

Zone coverage also decreases when parking at narrow angles. The sensor on the left-hand side is mostly obstructed and zone coverage on that side is severely reduced.

Cross Traffic Alert System Sensors

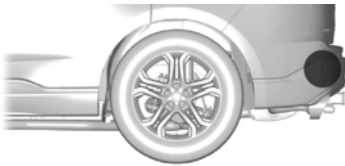

E205199

The sensors are behind the rear bumper on both sides of your vehicle.

Note: *Keep the sensors free from snow, ice and large accumulations of dirt.*

Note: *Do not cover the sensors with bumper stickers, repair compound or other objects.*

Note: *Blocked sensors could affect system performance.*

If the sensors are blocked, a message may appear in the information display when you shift into reverse (R).

Cross Traffic Alert System Limitations

The system may not correctly operate when any of the following occur:

- The sensors are blocked.
- Adjacently parked vehicles or objects are obstructing the sensors.
- Vehicles approach at speeds less than 4 mph (6 km/h) or greater than 37 mph (60 km/h).
- The vehicle speed is greater than 7 mph (12 km/h).
- You reverse out of an angled parking space.

Driving Aids

Cross Traffic Alert Behavior When Trailer is Attached

Note: *The system may not correctly operate when towing a trailer. For vehicles with an approved trailer tow module and tow bar, the system turns off when you attach a trailer. For vehicles with an aftermarket trailer tow module or tow bar, we recommend that you switch the system off when you attach a trailer.*

Cross traffic alert remains on when you attach a trailer in vehicles that come with blind spot information system with trailer tow under the following conditions:

- You connect a trailer.
- The trailer is a bike rack or cargo rack with a maximum length of 3 ft (1 m).
- You set the trailer length to 3 ft (1 m) in the information display.

See **Blind Spot Information System** (page 253).

Switching the System On and Off

To switch the system on or off, adjust the setting. Depending on your vehicle options, the setting could be in the following:

Cross Traffic Alert Information Messages

Message	Action
Cross Traffic Alert	Displays instead of indication arrows when the system detects a vehicle. Check for approaching traffic.
Cross Traffic Not Available Sensor Blocked See Manual	Indicates blocked cross traffic alert system sensors. Clean the sensors. If the message continues to appear, have your vehicle checked as soon as possible.
Cross Traffic System Fault	The system has malfunctioned. Have your vehicle checked as soon as possible.
Cross Traffic Alert Deactivated Trailer Attached	Displays if you attach a trailer to your vehicle.

- Information display. See **General Information** (page 112).
- Touchscreen. See **Settings** (page 535).

Note: *The system turns on every time you switch the ignition on. To permanently switch the system off, contact an authorized dealer.*

Cross Traffic Alert Indicator



When the system detects an approaching vehicle, a tone sounds, a warning lamp illuminates in the relevant exterior mirror and arrows appear in the information display to show which side the approaching vehicle is coming from.

Note: *If arrows do not display, a message appears in the information display.*

If the system malfunctions, a warning lamp illuminates in the instrument cluster and a message appears in the information display. Have your vehicle checked as soon as possible.

Note: *In exceptional conditions, the system could alert you, even when there is nothing in the detection zone, for example a vehicle passing further away from your vehicle.*

Driving Aids

STEERING

Hydraulic Power Steering

To help prevent damage to the power steering system:

- Do not hold the steering wheel at its furthest turning points for more than three to five seconds when the engine is running.
- Avoid continuously steering back and forth with elevated engine RPM as this may overheat the system. If trying to free a stuck vehicle, pause between attempts to allow the power steering system to cool or seek assistance. Typical steering and driving maneuvers allow the system to cool.
- Do not operate the vehicle if the power steering pump fluid level is below the MIN mark on the reservoir.
- Some noise is normal during operation. If excessive, check for low power steering pump fluid level before seeking service by your dealer.
- Heavy or uneven efforts may be caused by low power steering fluid. Check for low power steering pump fluid level before seeking service by your dealer.
- Do not fill the power steering pump reservoir above the MAX mark on the reservoir, as this may result in leaks from the reservoir.

If the power steering system breaks down or if you switch the engine off, you can steer the vehicle manually, but it takes more effort.

If you have any steering components serviced or replaced, install new fasteners. Many fasteners have coatings with thread adhesive, or have prevailing torque features you cannot reuse. Do not reuse a bolt or nut. Torque fasteners to specifications.

Steering Tips

If the steering wanders or pulls, check for:

- An improperly inflated tire.
- Uneven tire wear.
- Loose or worn suspension components.
- Loose or worn steering components.
- Improper vehicle alignment.

Note: *A high crown in the road or high crosswinds may also make the steering seem to wander or pull.*

Electronic Torque Overlay Steering

(If Equipped)



WARNING: The electric power steering system has diagnostic checks that continuously monitor the system. If a fault is detected, a message displays in the information display. Stop your vehicle as soon as it is safe to do so. Switch the ignition off. After at least 10 seconds, switch the ignition on and watch the information display for a steering system warning message. If a steering system warning message returns, have the system checked as soon as possible.



WARNING: If the system detects an error, you may not feel a difference in the steering, however a serious condition may exist. Have your vehicle checked as soon as possible. Failure to do so may result in loss of steering control.

Driving Aids

The electronic torque overlay steering system adds supplemental steering assist to the hydraulic gear when needed, dependent on vehicle conditions such as vehicle speed, steering wheel angle, and steering wheel torque. The hydraulic steering system provides the majority of steering assistance. The electronic torque overlay enables features such as pro trailer backup assistance and lane departure warning.

If your vehicle loses electrical power while you are driving, your vehicle loses electric power steering assistance. The steering system still operates, and you can steer your vehicle with hydraulic assist. Steering your vehicle with only hydraulic assist requires more effort.

Extreme continuous steering may increase the effort required for you to steer your vehicle. This increased effort prevents overheating and permanent damage to the steering system. You do not lose the ability to steer your vehicle manually. Typical steering and driving maneuvers allow the system to cool and return to normal operation.

Adaptive Learning (If Equipped)

The electronic power steering system adaptive learning helps correct road irregularities and improves overall handling and steering feel. It communicates with the brake system to help operate advanced stability control and accident avoidance systems. Whenever the battery is disconnected or a new battery installed, you must drive your vehicle a short distance before the system relearns the strategy and reactivates all systems.

Adaptive Steering (If Equipped)

Note: *The adaptive steering system has diagnostic checks that continuously monitor the system. If the system detects a fault, a message displays in the information display. If a red warning message displays, stop your vehicle as soon as it is safe to do so. The message may clear if the fault is no longer present. If an adaptive steering system warning message appears each time you start your vehicle, have the system checked as soon as possible.*

The adaptive steering system continually changes the steering ratio with changes to vehicle speed, optimizing the steering response in all conditions. The system also changes when you switch on the transmission tow/haul feature. When you select the tow/haul button, the adaptive steering system reduces vehicle sensitivity to steering inputs at higher vehicle speeds, while maintaining the ease of parking and maneuverability at low speeds.

Note: *The adaptive steering system is designed with a locking device. With the lock engaged, the adaptive steering system remains mechanically locked at a fixed steering ratio. You may also notice a click when you switch the vehicle on or after you switch it off, as the lock disengages or engages.*

Note: *If your vehicle loses electrical power or detects a fault when you are driving, the system automatically shuts down and you retain normal steering function with a fixed steering ratio. During this time it is possible that the steering wheel may not be straight when the vehicle is driving straight ahead. In addition, the driver may notice that the steering wheel angle required to steer the vehicle may be different.*

Driving Aids

Note: During parking maneuvers, the adaptive steering system balances the driver work load for various steering wheel inputs and vehicle loading conditions. Under extreme operating conditions the system locking device may engage. This strategy prevents overheating and permanent damage to the adaptive steering system. Typical steering and driving maneuvers allow the system to cool and return to normal operation.

PRE-COLLISION ASSIST (IF EQUIPPED)



WARNING: You are responsible for controlling your vehicle at all times. The system is designed to be an aid and does not relieve you of your responsibility to drive with due care and attention. Failure to follow this instruction could result in the loss of control of your vehicle, personal injury or death.



WARNING: The system does not detect vehicles that are driving in a different direction, cyclists or animals. Apply the brakes when necessary. Failure to follow this instruction could result in the loss of control of your vehicle, personal injury or death.



WARNING: The system does not operate during hard acceleration or steering. Failure to take care may lead to a crash or personal injury.



WARNING: The system may fail or operate with reduced function during cold and severe weather conditions. Snow, ice, rain, spray and fog can adversely affect the system. Keep the front camera and radar free of snow and ice. Failure to take care may result in the loss of control of your vehicle, serious personal injury or death.



WARNING: Some situations and objects prevent hazard detection. For example low or direct sunlight, inclement weather, unconventional vehicle types, and pedestrians. Apply the brakes when necessary. Failure to follow this instruction could result in the loss of control of your vehicle, personal injury or death.



WARNING: Take additional care if your vehicle is heavily loaded or you are towing a trailer. These conditions could result in reduced performance of this system. Failure to follow this instruction could result in the loss of control of your vehicle, personal injury or death.



WARNING: The system cannot help prevent all crashes. Do not rely on this system to replace driver judgment and the need to maintain a safe distance and speed.

Using the Pre-Collision Assist System

The Pre-Collision Assist system is active at speeds above approximately 3 mph (5 km/h) and pedestrian detection is active at speeds up to 50 mph (80 km/h).



E156130

Driving Aids

If your vehicle is rapidly approaching another stationary vehicle, a vehicle traveling in the same direction as yours, or a pedestrian within your driving path, the system provides three levels of functionality:

1. Alert
2. Brake Support
3. Active Braking

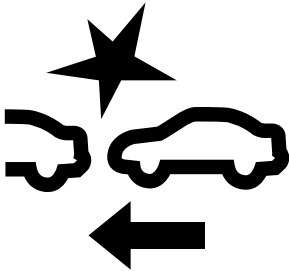

E255268

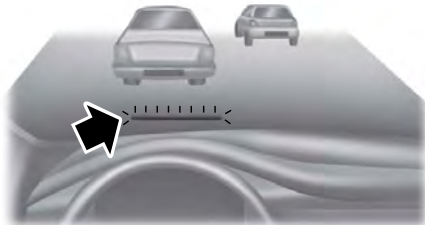

E156131

Alert: When active, a flashing visual warning appears and an audible warning tone sounds.

Brake Support: The system helps reduce the impact speed by preparing the brakes for rapid braking. The system does not apply the brakes. If you press the brake pedal, the system could apply additional braking up to maximum braking force, even if you lightly press the brake pedal.

Active Braking: Active braking may activate if the system determines that a collision is imminent. The system may help the driver reduce impact damage or avoid the crash completely.

Note: *Brake Support and Active Braking are active at speeds up to 75 mph (120 km/h). If the vehicle has a radar sensor or Adaptive Cruise Control, then Brake Support and Active Braking are active up to the maximum speed of the vehicle.*

Note: *If you perceive Pre-Collision Assist alerts as being too frequent or disturbing, then you can reduce the alert sensitivity, though the manufacturer recommends using the highest sensitivity setting where possible. Setting lower sensitivity would lead to fewer and later system warnings.*

Note: *The Pre-Collision Assist system disables when you select **4X4 LOW**, **Deep Snow/Sand** mode, **Rock Crawl** mode, or when you manually disable AdvanceTrac™.*

Distance Indication and Alert (if Equipped)

Distance Indication and Alert is a function that provides the driver with a graphical indication of the time gap to other preceding vehicles traveling in the same direction. The Distance Indication and Alert screen in the display screen shows one of the graphics that follow.

Driving Aids



E254791

If the time gap to a preceding vehicle is small, a red visual indication displays.

Note: *Distance Indication and Alert deactivates, and the graphics do not display when Adaptive Cruise Control is active.*

Speed	Sensitivity	Graphics	Distance Gap	Time Gap
62 mph (100 km/h)	Normal	Grey	>82 ft (25 m)	>0.9sec
62 mph (100 km/h)	Normal	Yellow	56–82 ft (17–25 m)	0.6sec — 0.9sec
62 mph (100 km/h)	Normal	Red	<56 ft (17 m)	<0.6sec

Adjusting the Pre-Collision Assist Settings

You can adjust the following settings by using the information display controls. See **General Information** (page 112).

- You can change Alert and Distance Alert sensitivity to one of three settings.
- You can switch Distance Indication and Alert on or off.

- If required, you can switch Active Braking on or off.
- If required, you can switch the entire Pre-Collision Assist feature on or off.

Note: *Active braking automatically turns on every time you switch the ignition on.*

Driving Aids

Note: If your vehicle has a radar sensor, we recommend that you switch the system off if you install a snow plow or similar object in such a way that it may block the radar sensor. Your vehicle remembers the selected setting across key cycles.

Blocked Sensors

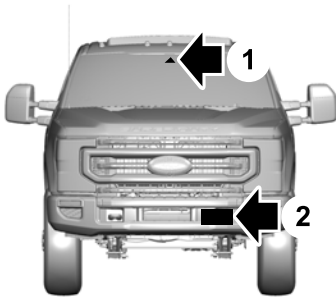

- 1 Camera.
- 2 Radar sensor (if equipped).

If a message regarding a blocked sensor or camera appears in the information display, the radar signals or camera images have become obstructed. If your vehicle has a radar sensor, it is located behind the fascia cover in the center of the lower grille. With a blocked sensor or camera, the Pre-Collision Assist system may not function, or performance may reduce. The following table lists possible causes and actions for when this message displays.

Camera Troubleshooting

Cause	Action
The windshield in front of the camera is dirty or obstructed in some way.	Clean the outside of the windshield in front of the camera.
The windshield in front of the camera is clean but the message remains in the display screen.	Wait a short time. It may take several minutes for the camera to detect that there is no obstruction.

Driving Aids

Radar Troubleshooting (If Equipped)

Cause	Action
The surface of the radar in the grille is dirty or obstructed in some way.	Clean the grille surface in front of the radar or remove the object causing the obstruction.
The surface of the radar in the grille is clean but the message remains in the display screen.	Wait a short time. It may take several minutes for the radar to detect that there is no obstruction.
Heavy rain, spray, snow or fog is interfering with the radar signals.	Pre-Collision Assist disables itself. The system automatically reactivates a short time after the weather conditions improve.
Swirling water or snow or ice on the surface of the road may interfere with the radar signals.	Pre-Collision Assist disables itself. The system automatically reactivates a short time after the weather conditions improve.
Radar is out of alignment due to a front end impact.	Contact an authorized dealer to have the radar checked for proper coverage and operation.

Note: *Proper system operation requires a clear view of the road by the camera. Have any windshield damage in the camera's field of view repaired.*

Note: *If something hits the front end of your vehicle or damage occurs and your vehicle has a radar sensor, the radar sensing zone may change. This could cause missed or false vehicle detections. Contact an authorized dealer to have the radar checked for proper coverage and operation.*

Note: *If your vehicle detects excessive heat at the camera or a potential misalignment condition, a message may display in the information display indicating temporary sensor unavailability. When operational conditions are correct, the message deactivates. For example, when the ambient temperature around the sensor decreases or the sensor automatically recalibrates successfully.*

DRIVE CONTROL (IF EQUIPPED)

Selectable Drive Modes

The system delivers a driving experience through a suite of sophisticated electronic vehicle systems. These systems optimize steering, handling and powertrain response. This provides a single location to control multiple system's performance settings.

Changing the drive mode automatically changes the functionality of the following systems:

Driving Aids

- Electronic stability control and traction control maintains your vehicle control in adverse conditions or high-performance driving.
- Electronic throttle control enhances the powertrain response to your inputs.
- Transmission controls are optimized with shift schedules tuned to each terrain.

Using the System

The system tailors your vehicle configuration for each mode you select.

Column Shifter



E249567

To change the drive mode setting, press the drive mode button. The drive mode selection menu appears in the instrument cluster and allows you to select through the available drive modes.



Normal – For everyday driving. This mode is a perfect balance of excitement, comfort, and convenience.



WARNING: Do not use tow/haul when the road surface is slippery. Failure to follow this instruction could result in the loss of control of your vehicle.



Tow/Haul – For improved transmission operation when towing a trailer or a heavy load. This mode moves upshifts to higher engine speeds to reduce the frequency of transmission shifting. This mode also provides engine braking in all forward gears, which slows your vehicle and assists you in controlling your vehicle when descending a grade. The amount of downshift braking provided varies based on the amount you press the brake pedal.



Deep Snow/Sand – For snow or soft, dry sand.



Eco – For efficient driving. This mode helps deliver maximum fuel efficiency and helps to increase driving range.



Slippery – For less than ideal road conditions such as snow or ice covered roads. Use this mode for crossing terrain where loose, wet or slippery material covers a firm surface. Slippery mode lowers throttle response and, if equipped with automatic transmission, optimizes shifting for slippery surfaces.



Rock Crawl – For optimum rock-climbing ability. Rock crawl mode prompts you to put your vehicle in 4x4 Low. Rock Crawl mode optimizes the throttle and transmission response to provide you additional control of your vehicle. See **Using Four-Wheel Drive** (page 212).



Some drive modes reduce traction and stability control performance and the warning indicator illuminates in the instrument cluster.

Driving Aids

Note: *Your vehicle starts in the last selected drive mode, for applicable modes, when you return to your vehicle after short trips up to 2 hours between ignition cycles. If the vehicle has not started for longer periods, the next startup activates a pop-up on the instrument cluster that asks you to confirm if you want to return to your last used drive mode.*

Note: *Mode changes are not available when the vehicle ignition is off. In drive (D), only some modes may be available.*

Note: *The system has diagnostic checks that continuously monitor the system for proper operation. Certain drive modes are not available based on the gearshift position. If a mode is unavailable due to a system fault or change in gearshift position, the mode defaults to Normal.*

Load Carrying

LOAD LIMIT

Vehicle Loading - with and without a Trailer

This section guides you in the proper loading of your vehicle, trailer, or both. Keep your loaded vehicle weight within its design rating capability, with or without a trailer. Properly loading your vehicle provides maximum return of vehicle design performance. Before you load your vehicle, become familiar with the following terms for determining your vehicle's weight rating, with or without a trailer, from the vehicle's Tire and Loading Information label or Safety Compliance Certification label.

Tire and Loading Label Information Example:



TIRE AND LOADING INFORMATION

SEATING CAPACITY TOTAL: 5 FRONT: 2 REAR: 3
 NOMBRE DE PLACES TOTAL 5 AVANT 2 ARRIERE 3

The combined weight of occupants and cargo should never exceed: 385 kg or 850 lbs.
 Le poids total des occupants et du chargement ne doit jamais dépasser 396 kg ou 875 lbs.

TIRE	SIZE	COLD TIRE PRESSURE
FRONT	235/45R18 94V	235 KPA, 34 PSI
REAR	235/45R18 94V	235 KPA, 34 PSI
SPARE	NONE	NONE

SEE OWNER'S
 MANUAL FOR
 ADDITIONAL
 INFORMATION



TIRE AND LOADING INFORMATION RENSEIGNEMENTS SUR LES PNEUS ET LE CHARGEMENT

SEATING CAPACITY TOTAL 5 FRONT 2 REAR 3
 NOMBRE DE PLACES TOTAL 5 AVANT 2 ARRIERE 3

The combined weight of occupants and cargo should never exceed 396 kg or 875 lbs.
 Le poids total des occupants et du chargement ne doit jamais dépasser 396 kg ou 875 lbs.

TIRE PNEU	SIZE DIMENSIONS	COLD TIRE PRESSURE PRESSION DES PNEUS A FROID
FRONT AVANT	235/40R19 96V	255 KPA, 37 PSI
REAR ARRIERE	235/40R19 96V	255 KPA, 37 PSI
SPARE DE SECOURS	T125/80R16 97M	415 KPA, 60 PSI

SEE OWNER'S
 MANUAL FOR
 ADDITIONAL
 INFORMATION
 VOIR LE MANUEL
 DE L'USAGER
 POUR PLUS DE
 RENSEIGNEMENTS

E198719

Payload

Payload is the combined weight of cargo and passengers that your vehicle is carrying. The maximum payload for your vehicle appears on the Tire and Loading label. The label is either on the B-pillar or the edge of the driver door. Vehicles exported outside the US and Canada may not have a tire and loading label. Look for "The combined weight of occupants and cargo should never exceed XXX kg OR XXX lb" for maximum payload. The payload listed on the Tire and Loading Information label

Load Carrying

is the maximum payload for your vehicle as built by the assembly plant. If you install any additional equipment on your vehicle, you must determine the new payload. Subtract the weight of the equipment from the payload listed on the Tire and Loading label. When towing, trailer tongue weight or king pin weight is also part of payload.



WARNING: The appropriate loading capacity of your vehicle can be limited either by volume capacity (how much space is available) or by payload capacity (how much weight the vehicle should carry). Once you have reached the maximum payload of your vehicle, do not add more cargo, even if there is space available. Overloading or improperly loading your vehicle can contribute to loss of vehicle control and vehicle rollover.

GAWR (Gross Axle Weight Rating)

GAWR is the maximum allowable weight that a single axle (front or rear) can carry. These numbers are on the Safety Compliance Certification label. The label is located on the door hinge pillar, door-latch post, or the door edge that meets the door-latch post, next to the driver seating position.

The total load on each axle must never exceed its Gross Axle Weight Rating.

GVWR (Gross Vehicle Weight Rating)

GVWR is the maximum allowable weight of the fully loaded vehicle. This includes all options, equipment, passengers and cargo. It appears on the Safety Compliance Certification label. The label is located on the door hinge pillar, door-latch post, or the door edge that meets the door-latch post, next to the driver seating position.

The gross vehicle weight must never exceed the Gross Vehicle Weight Rating.

Safety Compliance Certification Label Example:

MFD. BY FORD MOTOR CO.
 DATE: XXXX GVWR: XXXX LB (XXXX LB)
 FRONT GVWR: XXXX LB REAR GVWR: XXXX LB WITH
 XXXX KG (XXXX LB) WITH XXXX KG (XXXX LB) THIS
 XXXXXXXXXXXXXXXX THIS XXXXXXXXXXXXXXXX
 XXXXXX SMC XXXXXX RMS
 AT XXXX kPa/ XXX PSI(COLD) AT XXXX kPa/ XXX PSI(COLD)

THIS VEHICLE CONFORMS TO ALL APPLICABLE FEDERAL MOTOR
 VEHICLE SAFETY AND TIRES PROVISION STANDARDS IN
 EFFECT ON THE DATE OF MANUFACTURE SHOWN ABOVE.

VIN: XXXXXXXXXXXXXXXXXXXX
 TYPE: XXXX



EXPIRES: XX XXXX XX XX XX XXXX
 XX XX XX XX XX XX XX XX XX XX
 XXX XX XX XX XX XX XX XX
 XXXXXXXXXXXXXXXX XXX XXXXXXXXXXXXXXXX

MFD. BY FORD MOTOR CO.
 DATE: XXXX GVWR: XXXX LB (XXXX LB)
 FRONT GVWR: XXXX LB REAR GVWR: XXXX LB WITH
 XXXX KG (XXXX LB) WITH XXXX KG (XXXX LB) THIS
 XXXXXXXXXXXXXXXX THIS XXXXXXXXXXXXXXXX
 XXXXXX SMC XXXXXX RMS
 AT XXXX kPa/ XXX PSI(COLD) AT XXXX kPa/ XXX PSI(COLD)

THIS VEHICLE CONFORMS TO ALL APPLICABLE FEDERAL MOTOR
 VEHICLE SAFETY AND TIRES PROVISION STANDARDS IN
 EFFECT ON THE DATE OF MANUFACTURE SHOWN ABOVE.

VIN: XXXXXXXXXXXXXXXXXXXX
 TYPE: XXXX



EXPIRES: XX XXXX XX XX XX XXXX
 XX XX XX XX XX XX XX XX XX XX
 XXX XX XX XX XX XX XX XX
 XXXXXXXXXXXXXXXX XXX XXXXXXXXXXXXXXXX

E19828

Load Carrying



WARNING: Exceeding the Safety Compliance Certification label vehicle weight limits can adversely affect the performance and handling of your vehicle, cause vehicle damage and can result in the loss of control of your vehicle, serious personal injury or death.

Maximum Loaded Trailer Weight

Maximum loaded trailer weight is the highest possible weight of a fully loaded trailer the vehicle can tow. Consult an authorized dealer (or the RV and Trailer Towing Guide available at an authorized dealer) for more detailed information.

GCWR (Gross Combined Weight Rating)

GCWR is the maximum allowable weight of the vehicle and the loaded trailer, including all cargo and passengers, that the vehicle can handle without risking damage. (Important: The towing vehicle's braking system is rated for operation at Gross Vehicle Weight Rating, not at Gross Combined Weight Rating.) Separate functional brakes should

be used for safe control of towed vehicles and for trailers where the Gross Combined Weight of the towing vehicle plus the trailer exceed the Gross Vehicle Weight Rating of the towing vehicle.

The gross combined weight must never exceed the Gross Combined Weight Rating.

Note: For trailer towing information refer to the *RV and Trailer Towing Guide* available at an authorized dealer.



WARNING: Do not exceed the GVWR or the GAWR specified on the certification label.



WARNING: Do not use replacement tires with lower load carrying capacities than the original tires because they may lower your vehicle's GVWR and GAWR limitations. Replacement tires with a higher limit than the original tires do not increase the GVWR and GAWR limitations.



WARNING: Exceeding any vehicle weight rating can adversely affect the performance and handling of your vehicle, cause vehicle damage and can result in the loss of control of your vehicle, serious personal injury or death.

Load Carrying

Steps for determining the correct load limit:

1. Locate the statement "The combined weight of occupants and cargo should never exceed XXX kg or XXX lb." on your vehicle's Tire and Loading label.
2. Determine the combined weight of the driver and passengers that will be riding in your vehicle.
3. Subtract the combined weight of the driver and passengers from XXX kg or XXX lb.
4. The resulting figure equals the available amount of cargo and luggage load capacity. For example, if the "XXX" amount equals 1,400 lb. and there will be five 150 lb. passengers in your vehicle, the amount of available cargo and luggage load capacity is 650 lb. $(1400 - 750 (5 \times 150) = 650 \text{ lb.})$
5. Determine the combined weight of luggage and cargo being loaded on the vehicle. That weight may not safely exceed the available cargo and luggage load capacity calculated in Step 4.
6. If your vehicle will be towing a trailer, load from your trailer will be transferred to your vehicle. Consult this manual to determine how this reduces the available cargo and luggage load capacity of your vehicle.

Helpful examples for calculating the available amount of cargo and luggage load capacity

Suppose your vehicle has a 1400-pound (635-kilogram) cargo and luggage capacity. You decide to go golfing. Is there enough load capacity to carry you, four of your friends and all the golf bags? You and four friends average 220 pounds (99 kilograms) each and the golf bags weigh approximately 30 pounds (13.5 kilograms) each. The calculation would be: $1400 - (5 \times 220) - (5 \times 30) = 1400 - 1100 - 150 = 150$ pounds. Yes, you have enough load capacity in your vehicle to transport four friends and your golf bags. In metric units, the calculation would be: $635 \text{ kilograms} - (5 \times 99 \text{ kilograms}) - (5 \times 13.5 \text{ kilograms}) = 635 - 495 - 67.5 = 72.5$ kilograms.

Suppose your vehicle has a 1400-pound (635-kilogram) cargo and luggage capacity. You and one of your friends decide to pick up cement from the local home improvement store to finish that patio you have been planning for the past two years. Measuring the inside of the vehicle with the rear seat folded down, you have room for twelve 100-pound (45-kilogram) bags of cement. Do you have enough load capacity to transport the cement to your home? If you and your friend each weigh 220 pounds (99 kilograms), the calculation would be: $1400 - (2 \times 220) - (12 \times 100) = 1400 - 440$

Load Carrying

- 1200 = - 240 pounds. No, you do not have enough cargo capacity to carry that much weight. In metric units, the calculation would be: 635 kilograms - (2 x 99 kilograms) - (12 x 45 kilograms) = 635 - 198 - 540 = -103 kilograms. You will need to reduce the load weight by at least 240 pounds (104 kilograms). If you remove three 100-pound (45-kilogram) cement bags, then the load calculation would be: 1400 - (2 x 220) - (9 x 100) = 1400 - 440 - 900 = 60 pounds. Now you have the load capacity to transport the cement and your friend home. In metric units, the calculation would be: 635 kilograms - (2 x 99 kilograms) - (9 x 45 kilograms) = 635 - 198 - 405 = 32 kilograms.

The above calculations also assume that the loads are positioned in your vehicle in a manner that does not overload the front or the rear gross axle weight rating specified for your vehicle on the Safety Compliance Certification label.

Special Loading Instructions for Owners of Pick-up Trucks and Utility-type Vehicles



WARNING: When loading the roof racks, we recommend you evenly distribute the load, as well as maintain a low center of gravity. Loaded vehicles, with higher centers of gravity, may

handle differently than unloaded vehicles. Take extra precautions, such as slower speeds and increased stopping distance, when driving a heavily loaded vehicle.

BED RAMPS (IF EQUIPPED)



WARNING: When sliding the ramp up or down, take care not to get your fingers or hands caught in the mechanism. Failure to follow this instruction could result in personal injury.



WARNING: Make sure that you correctly install the ramp to the tailgate plate. Failure to follow this instruction could result in personal injury.



WARNING: Do not step or sit on the ramp when it is in the stowed position. Failure to follow this instruction could result in personal injury.



WARNING: Only install the ramp within the prescribed ramp angles. Failure to follow this instruction could result in personal injury.

Note: *The ramp maximum capacity is 800 lb (363 kg).*

Note: *Verify the ramp is on stable ground before usage.*

Note: *For loading and unloading equipment, your ramp should be set between 10 degrees upward and 26 degrees downward to avoid damage to the ramp claw and tailgate plate.*

Note: *When using your vehicle for off-road operation, remove the bed ramps from the vehicle and store them in a safe location away from your vehicle.*

Load Carrying

Using the Bed Ramp

1. Remove the front and rear cables.

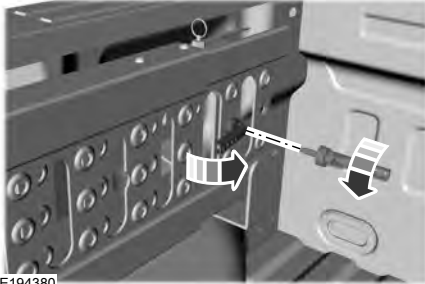

E194380

2. Open the cam lever arms and unscrew the cam bolts.
3. Remove the ramp from the ramp holder.



E211150

4. Rotate the stops at the underside of the ramp to the open position.

Note: You can use a smooth surface tool to rotate the stops.

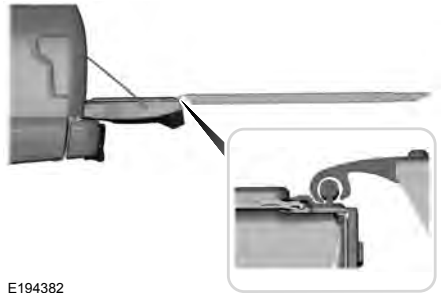

E194382

5. Slide the ramp claw onto the tailgate plate.



E194383

6. Pull the location pin outward and extend the ramp until the pin is seated in the usage position, then set the ramp on even ground.

Load Carrying

Stowing the Bed Ramp

1. Pick up the ramp. Pull the location pin outward.
2. Slide the ramp into the storage position until the location pin locks.

Note: Make sure the proper pin location has been applied for your bed size.

3. Slide the ramp claw off of the tailgate plate.
4. Rotate the stops at the underside of the ramp to the closed position.

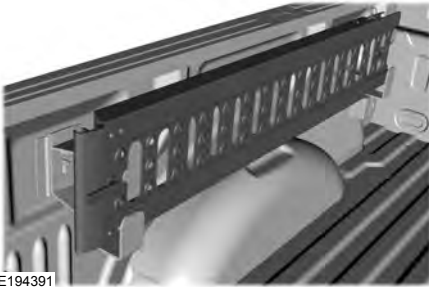

E194391

5. Place the ramp into the ramp holder.
6. Install the cam bolts and close the cam lever arms.
7. Attach the front and rear cables.

Note: Make sure you properly secure the locking cable. If the locking cable is unsecured, you may hear a rattling noise.

Installing the Ramp Holder

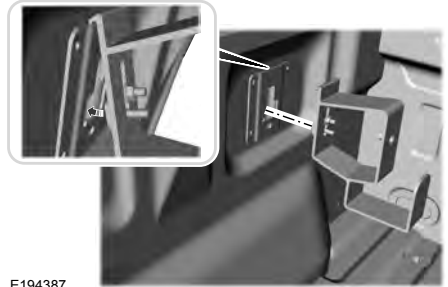

E194387

1. Hook the top of the ramp holder over the mounting plate and rotate the ramp holder into position.

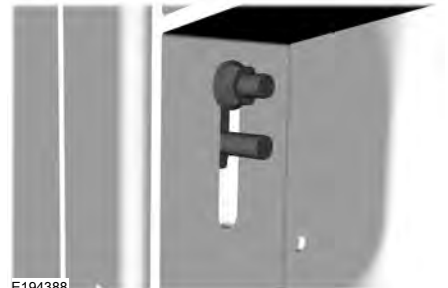

E194388

2. Slide the ramp holder studs upwards into the installed position.
3. Tighten the ramp holder nut.

Note: The nut should be on the upper stud.

Towing

TOWING A TRAILER



WARNING: Do not exceed the GVWR or the GAWR specified on the certification label.



WARNING: Towing trailers beyond the maximum recommended gross trailer weight exceeds the limit of your vehicle and could result in engine damage, transmission damage, structural damage, loss of vehicle control, vehicle rollover and personal injury.



WARNING: Do not exceed the lowest rating capacity for your vehicle or trailer hitch. Overloading your vehicle or trailer hitch can impair your vehicle stability and handling. Failure to follow this instruction could result in the loss of control of your vehicle, personal injury or death.



WARNING: Do not cut, drill, weld or modify the trailer hitch. Modifying the trailer hitch could reduce the hitch rating.

Note: To prevent your trailer from accumulating distance, and the trailer information status appearing when you restart your vehicle after disconnecting your trailer, you must deactivate your trailer. Using the information display, go to the Towing menu and then the Select Trailer option. Select the No active trailer option. See **Information Displays** (page 112).

Your vehicle may have electrical items, such as fuses or relays, related to towing. See **Fuses** (page 334).

Your vehicle may have ability to modify trailer towing features. See **General Information** (page 112).

Your vehicle's load capacity designation is by weight, not by volume, so you cannot necessarily use all available space when loading a vehicle or trailer.

Towing a trailer places an extra load on your vehicle's engine, transmission, axle, brakes, tires and suspension. Inspect these components periodically during, and after, any towing operation.

Towing

Load Placement

To help minimize how trailer movement affects your vehicle when driving:

- Load the heaviest items closest to the trailer floor.
- Load the heaviest items centered between the left and right side trailer tires.
- Load the heaviest items above the trailer axles or just slightly forward toward the trailer tongue. Do not allow the final trailer tongue weight to go above or below 10-15% of the loaded trailer weight.
- Select a ball mount with the correct rise or drop. When both the loaded vehicle and trailer are connected, the trailer frame should be level, or slightly angled down toward your vehicle, when viewed from the side.

When driving with a trailer or payload, a slight takeoff vibration or shudder may be present due to the increased payload weight. Additional information regarding proper trailer loading and setting your vehicle up for towing is located in another chapter of this manual. See **Load Limit** (page 270).

You can also find information in the **RV & Trailer Towing Guide** available at your authorized dealer, or online.

RV & Trailer Towing Guide Online

Website	http://www.fleet.ford.com/towing-guides/
---------	---

Towing

TRAILER REVERSING AIDS (IF EQUIPPED)

Pro Trailer Backup Assist With Trailer Reverse Guidance



WARNING: Driving while distracted can result in loss of vehicle control, crash and injury. We strongly recommend that you use extreme caution when using any device that may take your focus off the road. Your primary responsibility is the safe operation of your vehicle. We recommend against the use of any hand-held device while driving and encourage the use of voice-operated systems when possible. Make sure you are aware of all applicable local laws that may affect the use of electronic devices while driving.



WARNING: This system is an extra driving aid. It does not replace your attention and judgment, or the need to apply the brakes. This system does NOT automatically brake your vehicle. If you fail to press the brake pedal when necessary, you may collide with another vehicle.

This feature helps you to steer your vehicle when reversing with a trailer by:

- Using the control knob with Pro Trailer Backup Assist.
- Using the steering wheel with Trailer Reverse Guidance.

Each trailer you use with your vehicle has to be setup once.

You must take care to follow the setup process accurately to correctly place the sticker or sensor.

Contact your dealership if you need assistance setting up your trailer.

Note: Your vehicle saves the trailer information when you enter it into the system. You can add a maximum of 10 trailers to the system.

Note: The system is not a substitute for safe driving practices.

Note: You must always be aware of your vehicle and trailer combination, and the surrounding environment.

Note: The system does not detect or prevent your vehicle or trailer from making contact with obstacles in the surrounding environment.

Note: Keep in mind that the front end of your vehicle swings out when changing the direction of the trailer.

Note: The system relies on user measurements to determine sticker placement or user installation of a sensor to determine system limits. It is critical to correctly take the key measurements or properly install the sensor. Incorrect measurements or sensor placement can result in the improper function of the system up to and including contact between your vehicle and trailer. Even with correct measurements and sensor placement, the system cannot determine if the trailer body may contact your vehicle. Check the clearance between your vehicle and trailer, especially for sharp turns.

Note: The system limits vehicle speed when backing up. The system is not a replacement for proper use of the throttle and brake pedals.

Note: The system does not support backing up when towing multiple trailers. If you are towing more than one trailer, you must disconnect the additional trailers before using the system.

Towing

Positioning Your Vehicle and Trailer

Hitch your trailer to your vehicle and connect the electrical wiring harness. Check to make sure that the wiring is working. See **Essential Towing Checks** (page 300).



E209759

Park your vehicle and hitched trailer on a level surface.

For best results, make sure that your trailer rides level with the ground when you hitch your vehicle. More information on selecting your towbar is available in the Towing section. See **Towing** (page 277).



E209760

Make sure that the trailer and your vehicle are in line with each other. You can do this by putting the transmission in drive (D) and pulling straight forward.

Setting Up the System



1. Press the button to switch the system on.
2. Use the controls on the steering wheel to select the option to add a trailer in the information display. See **General Information** (page 112).
3. Add a personalized name for the trailer using the screen prompts. Use the down arrow to scroll to the preferred letter and then press the right arrow to advance to the next letter. Press **OK** to continue.
4. Select the **Trailer Brake Type**.
Note: Select **Default Electric/Surge/None** if your trailer has electric, surge or no brakes.
5. Select the **Trailer Brake Effort**.

Towing

Note: The default option is **Low**. We recommend this for most trailers. If the trailer brakes require more initial voltage, or if you prefer more aggressive braking, select **Medium** or **High**.

6. Select the trailer type.

Note: The system may prompt you to setup **Trailer Blind Spot** before continuing the setup process.

7. Select whether you want to add Pro Trailer Backup Assist.

Conventional Trailer Setup (If

Equipped)

The following are examples of conventional trailers.



Placing the Sticker

You must place the sticker in an area visible by the rear view camera.

Note: The cargo and trailer hookup lamps turn on to improve visibility.

Note: An assistant can help to carry out the following procedure.

Note: Make sure nothing can obstruct the rear view camera's view of the sticker. For example, items such as a jack handle or wiring.

Note: Position the sticker on a flat, dry and clean horizontal surface. For best results, apply the sticker when temperatures are above 32°F (0°C).

Note: Do not move stickers after placing them. Do not re-use any stickers if removed.

Note: You can purchase additional stickers through your authorized dealer.

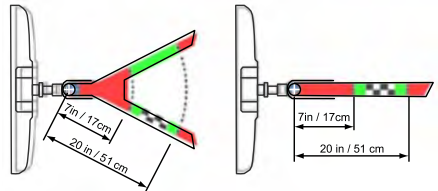

Use the supplied measurement card, a tape measure and pen to carefully mark the area to attach the sticker. The sticker is in the back cover pocket of your quick start guide. Make sure the entire sticker is within the green zone between the two arcs or distance markers on the diagram, and is also visible in the rear view camera display.

Once you have found the correct location, place the sticker.

Taking the Measurements

After you place the sticker on your trailer, you must take some measurements.

Note: You must take accurate measurements for the system to properly operate.

Towing

Note: When rounding in inches, round upward if the measured length is a quarter inch or greater. Round downward if the measured length is less than a quarter inch. For example, 12.25 in (31.11 cm) would be rounded up to 12.50 in (31.75 cm). 12.13 in (30.8 cm) would be rounded down to 12.00 in (30.48 cm).

Note: When rounding in centimeters, round to the nearest whole centimeter. If the measurement is less than 0.2 in (0.5 cm) round downward. If the measurement is more than or equal to 0.2 in (0.5 cm) round upward. For example, 11.9 in (30.3 cm) would be rounded down to 11.8 in (30 cm). 12.0 in (30.5 cm) would be rounded up to 12.2 in (31 cm).

Note: Use consistent metric or imperial units as required by your country or vehicle.

The measurement card requires you to record four key distances: A, B, C and D. Record the trailer name for these measurements.

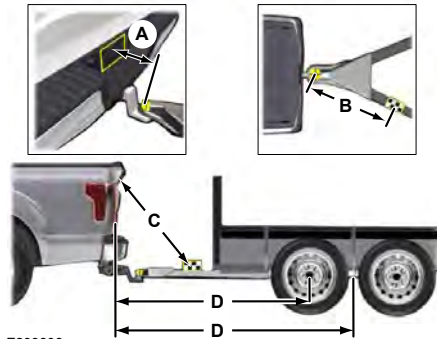

E209806

- A The horizontal distance from the license plate to the center of the ball hitch on the trailer.
- B The horizontal distance from the center of the ball hitch to the center of the sticker.

- C The point to point distance from the rear view camera to the center of the sticker.
- D The horizontal distance from the tailgate to the center of the trailer axle or axles.

Note: Round distance D to the nearest inch.

Note: Distance D is the center of the axles for trailers with more than one axle.

Entering the Measurements

Follow the on-screen prompts to enter each of the measurements. Use the up and down arrows to increase or decrease the numbers, as necessary. Press **OK** to confirm each measurement. When you add the last measurement, the information display shows all the measurements you entered. You can choose to confirm or change the measurements.

Confirming the Sticker Location

Check the rear view camera display to see if the system identifies the sticker. The system marks the sticker with a red circle. Confirm that the red circle shows over the sticker image in the rear view camera display.

Note: If the system cannot locate the sticker, try cleaning the camera lens. Make sure the sticker is within the zone indicated in *Placing the Sticker*.

Calibrating the System

To complete setup, drive your vehicle straight forward between 4–24 mph (6–39 km/h), as directed by the information display.

The information display shows a message during calibration and after calibration is complete

Towing

Note: Calibration steps for conventional trailers, fifth wheel and gooseneck trailers vary. Calibration instructions for fifth wheel and gooseneck trailers are in the following section.

Note: Keep the steering wheel straight during the calibration process. If the steering wheel is in a turned position, the calibration pauses.

Note: For best results, do not calibrate the system at night.

Fifth Wheel and Gooseneck Trailer Setup (If Equipped)

The following are examples of fifth wheel and gooseneck trailers.



Installing the Sensor

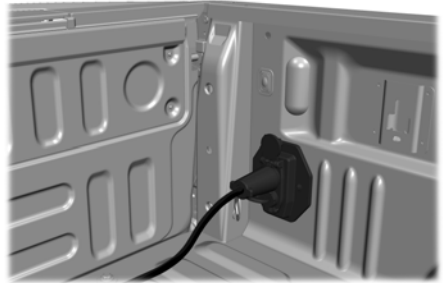

To use the system with a fifth wheel or gooseneck trailer, you must install a sensor. Refer to the instructions in the sensor kit for proper installation.

Note: Make sure the arrows on the sensor housing are facing up. Mount the sensor to a vertical part of the trailer that pivots and moves when you turn your vehicle. Do not mount to a stationary surface or to the truck side of the fifth wheel trailer hitch.

Note: You need to replace the 7/4 way connector in the bumper with the recommended 7/12 pin connector if your vehicle did not come with the fifth wheel prep package. See your authorized dealer.

Towing

Note: If your vehicle has the fifth wheel prep package, you have everything you need. If your vehicle does not have the fifth wheel prep package, see your authorized dealer to purchase the sensor kit and the 7/12 pin connector.

Calibrating the System

During calibration, the system determines the trailer length. The system supports trailer lengths of 10–39 ft (3–11.94 m) distance from the hitch point to the center of the axle or axles.

To calibrate the system, you need an area where you can safely drive forward and turn left or right. An open parking lot is an ideal place to perform the calibration.

Drive straight at approximately 5 mph (8 km/h) to align the trailer behind your vehicle. The information display and center screen provide you with instructions and tells you when the system is ready for a turn. Turn left or right whenever you are ready and in a safe turning area.

Note: You need to turn approximately 90 degrees to calibrate the system.

Note: The information display shows if you are going too slow or fast. Calibration pauses if the speed is outside the required range of 2–16 mph (4–25 km/h).

Using Pro Trailer Backup Assist

To use the system, press the button and watch the information display. Use the controls on the steering wheel to highlight the trailer, then press **OK** to select the trailer.



When the system locates the sticker or confirms the sensor is connected, the display prompts you to shift into reverse (R). The system turns on.

Note: If you use the steering wheel, the system turns off and a warning appears in the information display.

Follow the screen prompts to steer your vehicle and trailer.

Note: You may have to drive forward to straighten the trailer.

Take your hands off the steering wheel and turn the control knob instead. The knob acts as the steering control for the trailer.

Note: The more you turn the knob, the sharper the trailer turns.

Towing



E209812

Turn and hold counterclockwise to make the trailer go left.



E209813

Turn and hold clockwise to make the trailer go right.

Note: Practice maneuvering with the system in a safe open area first.

Note: Try backing up in a straight line and then turning the knob slowly in the direction you want to go.

Note: Quickly turning and releasing the knob results in a jerky movement of the vehicle.



E209814

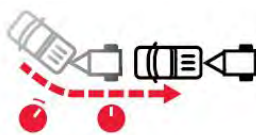

Release the knob when the trailer is moving in the direction you want. Control the accelerator and brakes while the system steers your vehicle automatically to keep the trailer moving straight back.

Note: For fifth wheel and gooseneck trailers, the weight and hitch position of these trailers may make the trailer respond differently to the knob input than conventional trailers. You may need to release the knob early or stop and pull forward to align your truck and trailer when returning to straight backing after making a turn.

Note: Trailer maneuvering performance may be compromised when using a fifth wheel sliding hitch or pivoting pin box since the system does not know the pivot point.

Note: You may have to use the knob to correct the trailer direction when attempting to move the trailer straight back under some conditions.

Note: The system limits the vehicle speed.

Note: When you release the knob or turn it to the center position, your vehicle follows the trailer's path.

Using Trailer Reverse Guidance

This provides information graphics and up to seven camera views to help you backup your trailer when you use the steering wheel. If you do not set up the system, you can still use the camera views.

Note: The hitch angle graphic, automatic view switching and straight backup mode are not available if you do not set up the system.

1. Shift into reverse (R). Press the rear camera button to expand the menu.
2. Press the trailer icon.
3. Select the applicable trailer in the information display.

Towing

4. When in this mode, you can see the camera view on the side your trailer is moving, or both sides when the trailer is straight behind you. When the views change with the trailer direction, it is called auto mode. For example, if you turn the trailer to the right, you see the right side of your vehicle and trailer. You can manually switch this view at any time by using the arrow keys. To return to auto mode, press the auto button.



Straight backup mode. Use this view when you want to keep your trailer completely in line with your truck. In this mode, a steering wheel graphic shows you which way to turn your steering wheel to keep your trailer straight.

Note: *It may be helpful to shift your vehicle into drive (D), pull forward and straighten out the vehicle and trailer before engaging straight backup mode.*

System Camera Views

Use the view that helps you the most when reversing your vehicle and trailer. You can use these views in either mode.

Left and right arrows let you see other views regardless of your trailer angle in rear split view camera and Trailer Reverse Guidance view.

Auto mode is the default view if you have set up Trailer Reverse Guidance.



360 camera. Shows a 360 degree view on the left-hand side of the screen, with the keep out zone on the right-hand side of the screen.



Rear view camera. Use this view when you want to see your trailer hitch or what is directly behind your vehicle.



Rear split view camera. Shows a 180 degree view of behind your vehicle.



Bed camera. Shows the truck bed and can be used for a fifth wheel or gooseneck trailer.



Trailer AUX camera. Shows a rear view camera image of what is behind your trailer. This camera needs to be purchased and separately installed.



Trailer Reverse Guidance view. Shows you a view of the sides of your truck and your trailer. In auto mode, this view moves as your trailer moves so that you do not have to adjust the camera as you turn.



This takes you back to the 360-degree camera system and out of the Trailer Reverse Guidance feature.



Auto. This feature returns you to auto view.

Hitch Angle Graphic

After setting up a trailer, the display shows a small top-view representation of your truck and trailer.

This representation shows two, different-colored lines. A black line shows you where your trailer is in relation to your vehicle. For Trailer Backup Assist, the white line represents the amount the trailer can turn based on knob input. For Trailer Reverse Guidance, the white line represents the amount the trailer can turn based on steering wheel position.

Towing

A small representation shows you two zones to warn you of a possible jackknife condition. The view shows your truck and trailer position and provides visual feedback to help avoid a jackknife condition entirely.

The yellow zone indicates you are approaching the maximum controllable trailer angle for the system. When your trailer enters this zone, it is more difficult to reduce the trailer turn when backing up. It may be necessary to put your vehicle back into drive (D) and pull forward to get the truck and trailer back to an in-line position.

The red zone indicates you have exceeded the maximum controllable trailer angle for the system. Put the truck into drive (D) and pull forward until your trailer is no longer in the red zone.

Troubleshooting - Conventional Trailer

Note: *The system requires a clear view of the sticker placed on the trailer. You must keep the camera lens and sticker clean for the system to operate correctly.*

Setup

The system is designed to be used with a wide variety of trailers. There are some trailers that do not have a proper surface and location to mount the sticker. These trailers are not supported. Attempts to place the sticker on a surface that does not meet the sticker placement requirement listed in Step 3 of the setup instruction or entering inaccurate measurements to proceed through setup can result in improper system function.

Accurate measurements are critical for correct system function. If you need to check measurements entered or change them, you can access them through the instrument cluster. Choose the option to change the sticker from the change trailer settings menu. It is not necessary to remove the sticker if you are just reviewing or changing measurements.

The following menu warnings or difficulties may occur during setup. Tips to resolve them are listed below.

Note: *If you still experience issues with the system's ability to detect the sticker, see the information in the next section regarding sticker lost during system operation.*

Measurement A has reached maximum or minimum value:

- The system is designed to work with drawbars that have a license plate to hitch ball center measurement of 9–20 in (23–52 cm) when installed. Do not attempt to use drawbars that have a length outside this range as the system performance degrades and could cause improper system function.
- Make sure that the measurement being made is the horizontal distance only from license plate to the hitch ball center. A straight line distance that includes any vertical rise or drop increases the measurement and makes it inaccurate. Inaccurate measurements degrade system performance and could cause improper system function. See step 4 of the setup instruction to review measurement instructions.

Towing

Measurement B has reached maximum or minimum value:

- Make sure that the sticker placement instruction in step 3 of the setup has been followed. Stickers placed outside the allowed zone adversely affects the system performance and could cause improper feature function.
- Make sure that the measurement being made is the horizontal distance only from center of sticker to the hitch ball center. A straight line distance that includes any vertical rise or drop increases the measurement and causes an inaccurate value to be entered into the system. See step 4 of the setup for additional measurement instructions.

Measurement C has reached maximum or minimum value:

- Make sure you follow the sticker placement instructions in step 3 of the setup. Stickers placed outside the allowed zone adversely affect the system performance and could cause improper feature function. If you have met all the criteria for sticker placement and you see this message, the sticker is either too far below or too close to the camera to properly recognize the sticker. For the system to operate correctly, the sticker height must be lowered if you receive the minimum warning or the sticker height must be raised if you receive the maximum warning.
- Only one sticker can be placed on the trailer for correct system function. The previous sticker must be removed or covered so only one sticker is visible to the camera.
- Measurement B and C must be measured again if a new sticker is placed on the trailer.

Measurement D has reached maximum or minimum value:

- Make sure that the measurement being made is the horizontal distance only from tailgate to the center of the single axle or the center of all the axles on the trailer. See step 4 of the setup for additional measurement instructions. The system does not support trailer lengths outside the range allowed by the information display.

System is circling something beside the sticker or system cannot find the sticker:

- Make sure the rear camera is clean and the sticker is clearly visible in the camera image. Clean the camera and sticker if necessary.
- The camera system uses the entered measurements to help locate the sticker. Inaccurate sticker measurements degrade the system's ability to locate the sticker. Verify the measurements you enter into the system are accurate.
- Remove the incorrectly circled label or decal if possible.
- If you cannot resolve the issue, try a new sticker location. The sticker location must still meet the requirements noted in step 3 of the setup instructions. Only one sticker can be placed on the trailer for correct system function. The previous sticker must be removed or covered so only one sticker is visible to the camera.

Calibration

The system monitors various vehicle parameters to ensure your vehicle is being driven straight and the trailer is straight behind your vehicle. Any steering input or trailer movement pauses the calibration.

Towing

For best results:

- Use a long, straight, smooth and level road when attempting to calibrate.
- Drive straight forward.
- Drive between 4–24 mph (6–39 km/h).

System Operation

The following warnings or difficulties may occur during feature operation. Tips to resolve them are listed below.

Pro Trailer Backup Assist™ System is Not Available or ***Trailer Reverse Guidance System is Not Available***:

- The system relies on many sub-systems in your vehicle to correctly operate. If those sub-systems are not correctly operating, the system may not be available.
- Low battery voltage is a condition that prevents the system from operating. Please make sure the battery is correctly charged if the system is not available.
- You may need to drive your vehicle straight forward above 25 mph (40 km/h) before the system is available again.
- If the message continues to display, see your authorized dealer for service.

Pro Trailer Backup Assist™ Driving Required to Initialize Steering Press Knob to Exit or ***Trailer Reverse Guidance Driving Required to Initialize Steering Press OK to Exit*** :

- The steering system needs to learn internal parameters to fully enable the feature. Drive your vehicle straight forward above 25 mph (40 km/h) for approximately 5 minutes.
- This may occur when your vehicle is new, the battery voltage is too low, the battery has been disconnected or your steering system has been serviced.

Sticker lost:

- If the system cannot initially find the sticker, it may be necessary for you to change the lighting conditions by moving the vehicle and trailer or waiting until conditions change.
- Check for the following if you receive the lost sticker message while using the system.
- Stop your vehicle as soon as the message displays.
- Make sure the sticker is visible and the pattern is discernable in the rear view camera image.
- Clean the sticker and camera to make sure they are unobstructed.
- Clean the lens with a soft, lint-free cloth and water.
- Clean the sticker with isopropyl rubbing alcohol sprayed directly onto the sticker, and then wipe clean with a soft cloth.
- Remove any items that may be blocking the view of the sticker. Depending on your trailer configuration and any equipment mounted to your trailer, it is possible for the sticker to be blocked from view of the camera as it rotates on the hitch ball but not be blocked during setup. Remove the obstruction if possible. It may be necessary to remove the sticker from its current location if the obstruction cannot be cleared. Place a new sticker that is visible to the camera in all positions of the trailer behind your vehicle.

Towing

- Placing the sticker on a surface angled away from the vehicle reduces performance. Use a drawbar that positions the trailer level to the ground when attached to the vehicle. This typically provides a level surface to mount the sticker. Place the sticker on a bracket or other object when no level surface is available.
- Make sure the entire sticker is on a flat surface that is completely visible to the camera. Do not fold the sticker over an edge on the trailer frame. This can degrade performance.
- Shadows on the sticker may affect tracking performance under some lighting conditions. Moving the sticker to another location within the allowed placement area may improve performance. Use the change sticker option in the information display menu if you move the sticker.
- You can change your sticker location by going into the information display menu, selecting trailer options, selecting change trailer settings and then selecting the change sticker option. The previous sticker must be removed. **ONLY ONE STICKER SHOULD BE PLACED ON THE TRAILER FOR CORRECT SYSTEM FUNCTION.**
- The camera system uses the entered measurements to help locate the sticker. Inaccurate measurements reduce the system's ability to locate the sticker. Check the measurements entered into the system are correct. Refer to step 4 of setup for instructions on measurements.
- You can change your measurement by going into the information display menu, selecting trailer options, selecting change trailer setting and then selecting the change sticker option. Disregard the prompt to remove this sticker and continue to the next step if you only plan to update the measurements for the current sticker location.

System does not reverse straight:

- Factors such as the drawbar connection to the hitch receiver, road camber, road grade and compliance in the trailer suspension can influence how straight the system is able to reverse your trailer when the knob is not turned. You can compensate for the trailer drifting to the right or left by slowly turning the knob until the trailer is following your preferred path and then holding the knob in that position. If you would like to recalibrate the system for straight backing, you can do so with the following procedure.
- Go into the information display menu, select trailer options, select change trailer setting and then select the change sticker option. Your saved measurements display. Do not change them but continue to confirm measurements. Once you confirm the measurements, the system then prompts you to perform the calibration procedure.

Towing

System consistently shows **Pro Trailer Backup Assist™ Stop now Maximum trailer angle Press Knob to Exit:**

- The system uses your measurements to determine sticker position and establish system limits. Accurate sticker placement and trailer measurements provide the best system performance. If you are consistently receiving this warning, it is likely there is an issue with sticker placement or the entered measurements. Make sure that the sticker is placed correctly based on step 3 and the measurements were made correctly according to step 4. The troubleshooting guide for trailer measurements can also be reviewed for help in making measurements.
- To change sticker location or change trailer measurements, go into the information display menu, select trailer options, select change trailer setting and then select the change sticker option.
- If the sticker location needs to be changed, the previous sticker must be removed and a new sticker needs to be placed on the trailer. **ONLY ONE STICKER SHOULD BE PLACED ON THE TRAILER FOR PROPER SYSTEM FUNCTION.**
- Disregard the prompt to remove this sticker and continue to the next step if you only plan to update the measurements for the current sticker location.

System consistently shows **Pro Trailer Backup Assist™ Stop Now Take Control of Steering Wheel:**

- The system displays this warning when it can no longer steer the vehicle and you must take over steering. There are four reasons why this warning displays and additional information regarding the reason for the warning is available on the center display.
- The steering wheel is touched when under system control. Avoid touching the wheel during system operation.
- The maximum speed for feature operation is exceeded. System performance is optimized at slower speeds. Reverse slowly.
- The sticker was lost by the camera system. Once your vehicle is stopped, additional warnings indicate the sticker was lost. Refer to sticker lost troubleshooting tips.
- An internal condition for system operation was not met which requires your vehicle to return to manual control of the steering. Using the system for an extended period of time can cause the steering system to heat up and turn off Pro Trailer Backup Assist steering control to protect itself. The system may require a cool down time of up to 30 minutes. Keep the system off and drive forward at a normal speed or switch the vehicle off.

Note: *The system is designed to be used with the same trailer connection every time the trailer is chosen from the selection menu. When using a different drawbar or a different pin hole on drawbars with more than one, connecting the drawbar to your vehicle affects the trailer measurements. Take the measurements again and update if required.*

Towing

Troubleshooting - Fifth Wheel and Gooseneck Trailer

Setup

The system is designed to be used with a wide variety of trailers. There are some trailers that do not have a proper surface and location to mount the sensor. These trailers are not supported. Attempts to install the sensor in a manner that does not meet the requirements can result in improper system function.

To correctly install the trailer sensor:

- Attach to vertical surface with the arrows pointed straight up.
- If you are not sure, use a level to check that the attachment surface is vertical.
- Securely fasten the sensor so that it is rigidly mounted and does not shake or wobble.
- Install within the range of the 12 way connector so that when the trailer swings the wire harness does not stretch, pinch or pull.

If the system displays **Pro Trailer Backup Assist™ Sensor Not Detected Refer to Owner's Manual Press Knob to Exit** or **Trailer Reverse Guidance Sensor Not Detected Refer to Owner's Manual Press OK to Exit**:

- Check that the 12 way connector is fully inserted into the 12 way socket. The red rubber seal is not visible when the connector is fully inserted.
- Check that the wiring harness sensor connection is fully inserted at the trailer sensor.
- Check for damaged wiring between the 12 way connector and the trailer sensor.
- If you have a 12 way connector inside the bed and in the bumper, ensure that only a single sensor is connected.

Note: *If you did not purchase the fifth wheel prep pack, you need to replace the 7/4 way trailer connector in your bumper with a 7/12 pin connector. See your authorized dealer.*

Calibration

The calibration process is required for the system to determine the trailer length. The system supports trailer lengths of 10–39 ft (3–11.94 m) distance from the hitch point to the center of the axle or axles. The calibration process consists of a straight forward drive followed by a turn. During the straight drive, the system monitors various vehicle parameters to make sure your vehicle is being driven straight and the trailer is straight behind your vehicle. Any steering input or trailer movement during this straight drive pauses the calibration. During the turn, the system monitors various vehicle parameters to make sure your vehicle and trailer are correctly turning.

For best results:

- Use a smooth and level road when attempting to calibrate.
- Steer and smoothly turn and avoid abrupt steering inputs.
- Drive between 2–16 mph (4–25 km/h).
- Make a typical 90 degree corner turn. Turning too shallow does not allow the system to calibrate.

The typical calibration process results in the system displaying messages in the information display. The system also displays additional warnings if the vehicle or trailer motion is not within the calibration limits.

Towing

If the system remains on one message for an extended time, is not progressing through the typical calibration steps or if **Pro Trailer Backup Assist™ Trailer Not Detected. Shift to Park Press Knob to Exit, Pro Trailer Backup Assist™ Trailer Not Detected. Refer to Owner's Manual. Press Knob to Exit or Trailer Reverse Guidance Trailer Not Detected. Refer to Owner's Manual. Press OK to Exit** displays, check the following:

- Verify the sensor is correctly installed. See Fifth Wheel and Gooseneck Trailer Sensor Installation.
- Verify the trailer length is within the allowed range of 10–39 ft (3–11.94 m).
- Verify you are calibrating on a smooth road surface.

Repeat calibration on a different route if you have verified the previous checks.

System Operation

The following warnings or difficulties may occur during system operation. Tips to resolve them are listed in the following section.

Pro Trailer Backup Assist™ System is Not Available or Trailer Reverse Guidance System is Not Available:

- The system relies on many sub-systems in your vehicle to correctly operate. If those sub-systems are not correctly operating, the system may not be available.
- Low battery voltage is a condition that prevents the system from operating. Please make sure the battery is correctly charged if the system is not available.
- If the message continues to display, see your authorized dealer for service.

Pro Trailer Backup Assist™ Driving Required to Initialize Steering Press Knob to Exit or Trailer Reverse Guidance Driving Required to Initialize Steering Press OK to Exit:

- The steering system needs to learn internal parameters to fully enable the feature. Drive your vehicle straight forward above 25 mph (40 km/h) for approximately 5 minutes.
- This may occur when your vehicle is new, the battery voltage is too low, the battery has been disconnected or your steering system has been serviced.

Pro Trailer Backup Assist™ Sensor Not Detected Refer to Owner's Manual Press Knob to Exit or Trailer Reverse Guidance Sensor Not Detected Refer to Owner's Manual Press OK to Exit:

- Check that the 12 way connector is fully inserted into the 12 way socket. The red rubber seal is not visible when the connector is fully inserted.
- Check that the wiring harness sensor connection is fully inserted at the trailer sensor.
- Check for damaged wiring between the 12 way connector and the trailer sensor.
- Only one sensor can be connected to your vehicle at a time. If you have a 7/12 pin connector in the truck bed and in the bumper, check to make sure that only one sensor is connected.

Note: *If you did not purchase the fifth wheel prep pack, you need to replace the 7/4 way trailer connector in your bumper with a 7/12 pin connector. See your authorized dealer.*

Pro Trailer Backup Assist™ Trailer Not Detected. Refer to Owner's Manual. Press Knob to Exit or Trailer Reverse Guidance Trailer Not Detected. Refer to Owner's Manual. Press OK to Exit:

- If the message continues to display, see your authorized dealer for service.

Towing

Pro Trailer Backup Assist™ Trailer Not Detected Pull Forward to Initialize Press Knob to Exit or Trailer Reverse Guidance Trailer Not Detected Pull Forward to Initialize Press OK to Exit:

- If the vehicle has not moved during this key cycle, it must be driven forward to initialize the sensing system.
- Extended operation at speeds below 1 mph (1 km/h) may cause the sensing system to lose the trailer position and the system needs to be re-initialized.
- Drive forward above 2 mph (3 km/h) and the system indicates when it initializes.

System repeatedly displays Pro Trailer Backup Assist™ Stop Now System Not Active Press Knob to Exit:

- System is not fully activated. Select the trailer in the information display by using the controls on the steering wheel and wait until ***Pro Trailer Backup Assist™ Backup Slowly Turn Knob to Steer Press Knob to Exit*** displays before starting to move backward.
- This displays if you backup during the calibration process. Drive forward and complete calibration.

System does not reverse straight:

- Verify sensor is correctly installed. See Fifth Wheel and Gooseneck Trailer Sensor Installation.
- Factors such as the hitch connection, road camber, road slope and compliance in the trailer suspension can influence how straight the system is able to reverse the trailer when the knob is not turned. You can compensate for the trailer drifting to the right or left by slowly turning the knob until the trailer is following your preferred path and then holding the knob in that position.

System consistently shows Pro Trailer Backup Assist™ Stop now Maximum trailer angle Press Knob to Exit:

- Verify sensor is correctly installed. See Fifth Wheel and Gooseneck Trailer Sensor Installation.
- Verify the correct trailer is selected in the information display.
- The system may need to be recalibrated. The system can be recalibrated by using the information display to delete the trailer and repeating the setup process. If the same sensor is installed on another trailer, create a new trailer in the information display and complete the setup and calibration process for the new trailer. If using the same sensor on multiple trailers, disconnect the 7/12 pin connector when switching trailers. See Setting Up The System.

System consistently shows Pro Trailer Backup Assist™ Stop Now Take Control of Steering Wheel:

- The system displays this warning when it can no longer steer the vehicle and you must take over steering. There are four reasons why this warning displays and additional information regarding the reason for the warning is available on the center display.
- The steering wheel is touched when under system control. Avoid touching the wheel during system operation.
- The maximum speed for feature operation is exceeded. System performance is optimized at slower speeds. Reverse slowly.

Towing

- The trailer is not detected. Once your vehicle is stopped, additional warnings indicate the trailer is not detected. Refer to trailer not detected troubleshooting tips.
- An internal condition for system operation was not met which requires your vehicle to return to manual control of the steering. Using the system for an extended period of time can cause the steering system to heat up and turn off Pro Trailer Backup Assist steering control to protect itself. The system may require a cool down time of up to 30 minutes. Keep the system off and drive forward at a normal speed or switch the vehicle off.

TRAILER SWAY CONTROL (IF EQUIPPED)



WARNING: Turning off trailer sway control increases the risk of loss of vehicle control, serious injury or death. Ford does not recommend disabling this feature except in situations where speed reduction may be detrimental (such as hill climbing), the driver has significant trailer towing experience, and can control trailer sway and maintain safe operation.

Note: This feature does not prevent trailer sway, but reduces it once it begins.

Note: This feature cannot stop all trailers from swaying.

Note: In some cases, if vehicle speed is too high, the system may activate multiple times, gradually reducing vehicle speed.

This feature applies your vehicle brakes at individual wheels and, if necessary, reduces engine power. If the trailer begins to sway, the stability control light flashes and the message **TRAILER SWAY REDUCE SPEED** appears in the information display. The first thing to do is slow your vehicle down, then pull safely to the side of the road and check for proper tongue load and trailer load distribution. See **Load Carrying** (page 270).

RECOMMENDED TOWING WEIGHTS



WARNING: You must use the heavy-duty drawbar pin supplied with your vehicle when using the heavy-duty hitch. Failure to follow this instruction could result in the loss of control of your vehicle, personal injury or death.

Note: Vehicles with a 21,200 lb (9,616 kg) hitch and above must use the drawbar pin that came with the vehicle. You can obtain a replacement drawbar pin at your authorized dealer.

Note: Make sure to take into consideration trailer frontal area. Do not exceed 60 ft² (5.6 m²) trailer frontal area for conventional trailers. Do not exceed 75 ft² (6.9 m²) trailer frontal area for fifth wheel and gooseneck trailers.

Towing

Note: Exceeding this limitation may significantly reduce the performance of your towing vehicle. Selecting a trailer with a low aerodynamic drag and rounded front design helps optimize performance and fuel economy.

Note: Your vehicle could have reduced performance when operating at high altitudes and when heavily loaded or towing a trailer. When driving at elevation, in order to match driving performance as perceived at sea level, reduce gross vehicle weight and gross combination weight by 2% per 1,000 ft (300 m) elevation.

Note: Certain states require electric trailer brakes for trailers over a specified weight. Be sure to check state regulations for this specified weight. The maximum trailer weights listed may be limited to this specified weight, as your vehicle's electrical system may not include the wiring connector needed to use electric trailer brakes.

Your vehicle may tow a trailer provided the maximum trailer weight is less than or equal to the maximum trailer weight calculated using the formula following the chart.

Pickup and box delete			
Vehicle	Engine	Rear axle ratio	Maximum GCWR
F-250	6.2L gas	3.73	19,500 lb (8,845 kg)
		4.30	22,000 lb (9,979 kg)
	6.7L diesel	3.31	23,500 lb (10,659 kg)
	6.7L diesel ¹	3.31, 3.55	30,000 lb (13,607 kg)
	7.3L gas	3.55	21,800 lb (9,888 kg)
4.30		26,000 lb (11,793 kg)	
F-350 single rear wheel	6.2L gas	3.73	19,500 lb (8,845 kg)

Towing

Pickup and box delete			
Vehicle	Engine	Rear axle ratio	Maximum GCWR
	6.7L diesel	4.30	23,000 lb (10,433 kg)
		3.31	30,000 lb (13,607 kg)
	7.3L gas	3.55	30,000 lb (13,607 kg)
		3.73	23,500 lb (10,659 kg)
		4.30	27,500 lb (12,473 kg)
F-350 dual rear wheel	6.2L gas	3.73	20,000 lb (9,071 kg)
		4.30	23,500 lb (10,659 kg)
	6.7L diesel	3.55	40,000 lb (18,143 kg)
		4.10	43,400 lb (19,685 kg)
	7.3L gas	3.73	24,000 lb (10,886 kg)
		4.30	28,000 lb (12,700 kg)
F-450	6.7L diesel	4.30	45,300 lb (20,547 kg)

¹ Trailer Tow Package.

Towing

Chassis cab			
Vehicle	Engine	Rear axle ratio	Maximum GCWR
F-350 single rear wheel	6.8L gas	3.73	19,500 lb (8,845 kg)
		4.30	23,000 lb (10,432 kg)
	6.7L diesel	3.73	30,000 lb (13,607 kg)
	7.3L gas	4.30	26,000 lb (11,793 kg)
F-350 dual rear wheel	6.8L gas	3.73	20,000 lb (9,071 kg)
		4.30	23,500 lb (10,659 kg)
	6.7L diesel	3.73	31,500 lb (14,288 kg)
		4.10	32,500 lb (14,741 kg)
	7.3L gas	3.37	22,500 lb (10,205 kg)
		4.30	26,000 lb (11,793 kg)
F-450 dual rear wheel	6.7L diesel	4.10	32,500 lb (14,741 kg)
		4.30	35,000 lb (15,875 kg)
	7.3L gas	4.88	28,000 lb (12,700 kg)

Towing

Chassis cab			
Vehicle	Engine	Rear axle ratio	Maximum GCWR
F-550 dual rear wheel (17500/18000 lb GVWR)	6.7L diesel	4.10	32,500 lb (14,741 kg)
		4.30	37,000 lb (16,782 kg)
	7.3L gas	4.88	28,000 lb (12,700 kg)
F-550 dual rear wheel (19000/19500 lb GVWR)	6.7L diesel	4.88	32,500 lb (14,741 kg)
	7.3L gas		28,000 lb (12,700 kg)
F-600 dual rear wheel	6.7L diesel	4.88	43,000 lb (19,504 kg)
	7.3L gas	4.88	30,000 lb (13,607 kg)

Calculating the Maximum Loaded Trailer Weight for Your Vehicle

- Start with the gross combined weight rating for your vehicle model and axle ratio. See the previous chart.
- Subtract all of the following that apply to your vehicle:
 - Vehicle curb weight.
 - Hitch hardware weight, such as a draw bar, ball, locks or weight distributing hardware.

- Driver weight.
- Passenger(s) weight.
- Payload, cargo and luggage weight.
- Aftermarket equipment weight.

This equals the maximum loaded trailer weight for this combination.

Note: *The trailer tongue load is considered part of the payload for your vehicle. Reduce the total payload by the final trailer tongue weight.*

Towing

Note: Consult an authorized dealer to determine the maximum trailer weight allowed for your vehicle if you are not sure.

For additional information on trailer weights, reference the **RV & Trailer Towing Guide** available at your authorized dealer, or online.

RV & Trailer Towing Guide Online

Website www.fleet.ford.com/towing-guides

ESSENTIAL TOWING CHECKS



WARNING: Do not exceed the maximum vertical load on the tow ball. Failure to follow this instruction could result in the loss of control of your vehicle, personal injury or death.

Follow these guidelines for safe towing:

- Do not tow a trailer until you drive your vehicle at least 1,000 mi (1,600 km).
- Consult your local motor vehicle laws for towing a trailer.
- See the instructions included with towing accessories for the proper installation and adjustment specifications.
- Service your vehicle more frequently if you tow a trailer. See your scheduled maintenance information. See **Scheduled Maintenance** (page 557).
- If you use a rental trailer, follow the instructions the rental agency gives you.

See **Load Limits** in the Load Carrying chapter for load specification terms found on the tire label and Safety Compliance label and instructions on calculating your vehicle's load.

Vehicles with a diesel engine have an engine braking feature. See **General Information** (page 222).

Remember to account for the trailer tongue weight as part of your vehicle load when calculating the total vehicle weight.

Some vehicles will have the ability to modify trailer towing features. See **General Information** (page 112).

Trailer Towing Connector



E163167

When attaching the trailer wiring connector to your vehicle, only use a proper fitting connector that works with the vehicle and trailer functions. Some seven-position connectors may have the SAE J2863 logo, which confirms that it is the proper wiring connector and works correctly with your vehicle.

Towing

Color	Function
Yellow	Left turn signal and stop lamp
White	Ground (-)
Blue	Electric brakes
Green	Right turn signal and stop lamp
Orange	Battery (+)
Brown	Running lights
Grey	Reverse lights

Note: If your vehicle is equipped with a factory brake controller, the Battery (+) Orange wire is powered when you start the engine and you apply the brakes at least once when a trailer with brake lamps is connected. If your vehicle is not equipped with a factory brake controller, relays control the system and it becomes active when you power on your vehicle.

Dynamic Hitching Using the Rear View Camera System

Note: Active guidelines and fixed guidelines are only available when the transmission is in reverse (R).

Use the centerline (B) guideline to assist you in setting your steering wheel properly to help align the trailer hitch and tongue.

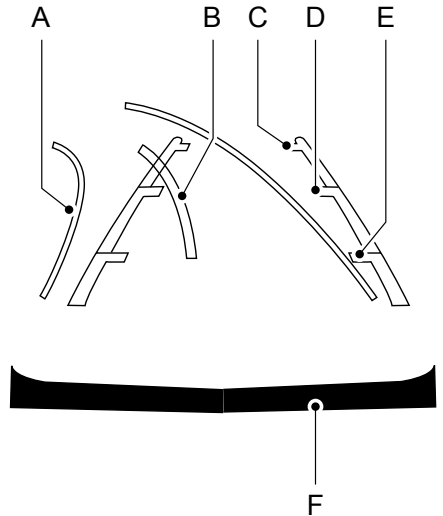

E142436

- A Active guidelines.
- B Centerline.
- C Fixed guideline: Green zone.
- D Fixed guideline: Yellow zone.
- E Fixed guideline: Red zone.
- F Rear bumper.

Fixed guidelines are always shown in the display, but the active guidelines only display when the steering wheel is turned. To use active guidelines, turn the steering wheel to point the guidelines toward an intended path. If the steering wheel position is changed while reversing, your vehicle might deviate from the original intended path.

Towing

The active guidelines fade in and out depending on the steering wheel position. The active guidelines are not shown when the steering wheel position is straight.

Always use caution while reversing. Objects in the red zone are closest to your vehicle and objects in the green zone are farther away. Objects are getting closer to your vehicle as they move from the green zone to the yellow or red zones. Use the side view mirrors and rear view mirror to get better coverage on both sides and rear of your vehicle.

Refer to the Rear View Camera section for additional information. See **Rear View Camera** (page 234).

Hitches

Note: *On pick-up trucks, the trailer hitch provided on this vehicle enhances crash protection for the fuel system. Do not remove!*

Note: *Do not cut, drill, weld or modify trailer hitches. Modifying trailer hitches can reduce hitch rating.*

Do not use a hitch that either clamps onto the bumper or attaches to the axle. You must distribute the load in your trailer so that 10-15% for conventional towing or 15-25% for fifth wheel towing of the total weight of the trailer is on the tongue.

Hitch Components (If Equipped)

The following components are required. Some are provided in certain vehicles.

- A trailer hitch with a 3 inch receiver and a 5/8 inch hitch pin. Check the stamped rating number on the pin to determine the 21,200 lb (9,616 kg) or 24,200 lb (10,976 kg) hitch pin capacity.
- A hitch pin sleeve stored in the glove box to use when mounting the 3 inch drawbar with the 3/4 inch pin hole.
- A cotter pin to help keep the hitch pin in place.

Installing a 3 Inch Drawbar with 3/4 Inch Pin Hole

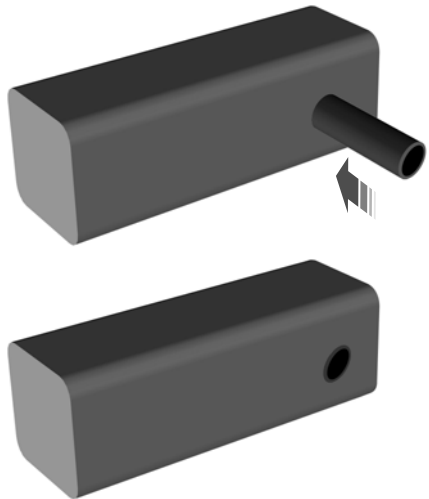

E247903

The pin sleeve should be inserted in the 3/4 inch pin hole of the 3 inch drawbar.

Towing



E247902

Remove reducers before inserting the 3 inch drawbar. Insert the drawbar into hitch receiver.

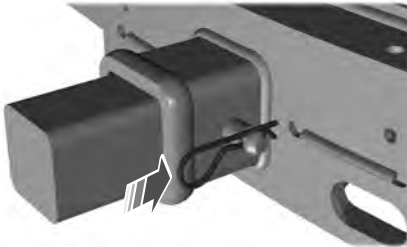

E247909

Put the 5/8 inch hitch pin through pin hole. Place the cotter pin around the neck of hitch pin.

Weight-distributing Hitches

⚠️ WARNING: Do not adjust the spring bars so that your vehicle's rear bumper is higher than before attaching the trailer. Doing so will defeat the function of the weight-distributing hitch, which may cause unpredictable handling, and could result in serious personal injury.

When hooking-up a trailer using a weight-distributing hitch, always use the following procedure:

1. Park the loaded vehicle, without the trailer, on a level surface.
2. Measure the height to the top of your vehicle's front wheel opening on the fender. This is H1.
3. Attach the loaded trailer to your vehicle without the weight-distributing bars connected.
4. Measure the height to the top of your vehicle's front wheel opening on the fender a second time. This is H2.
5. Install and adjust the tension in the weight-distributing bars so that the height of your vehicle's front wheel opening on the fender is approximately halfway between H1 and H2.
6. Check that the trailer is level or slightly nose down toward your vehicle. If not, adjust the ball height accordingly and repeat Steps 2-6.

Once the trailer is level or slightly nose down toward the vehicle:

- Lock the bar tension adjuster in place.
- Check that the trailer tongue securely attaches and locks onto the hitch.
- Install safety chains, lighting, and trailer brake controls as required by law or the trailer manufacturer.

Towing

Fifth-wheel Trailer Hitch (If Equipped)

Note: For a detailed description of installation and other information, see the **Owner's Manual-5th Wheel Trailer Hitch**.

Note: The mounting pads in the bed are specifically designed for certain fifth-wheel trailer hitches and gooseneck ball hitches. Do not use these mounting pads for other purposes.

Note: Contact an authorized dealer to purchase gooseneck and fifth-wheel hitches that are compatible with your vehicle.

Your vehicle may be equipped with a fifth-wheel prep package. This package enables your vehicle to accept certain fifth-wheel trailer hitches and gooseneck ball hitches. The fifth-wheel trailer hitch attaches to the four mounting pads in the pick-up bed. An optional 7-pin trailer wiring connector may be in the bed as well. The gooseneck ball hitch is a separate mounting pad from the fifth-wheel hitch, located in the center of the bed.

Shorter pick-up boxes, such as the 6½-foot box on the F-250 and F-350, provide less clearance between the cab and the fifth-wheel and gooseneck trailer compared to longer box pick-ups, such as an 8-foot box on the F-250 or F-350. When selecting a trailer and tow vehicle, it is critical to check that this combination provides clearance between the front of the trailer and tow vehicle for turns up to 90 degrees. Failure to follow this recommendation could result in the trailer contacting the cab of the tow vehicle during tight turns that are typical during low-speed parking and turning maneuvers. This contact could result in damage to the trailer and tow vehicle.

Safety Chains

Note: Do not attach safety chains to the bumper. Always connect the safety chains to the frame or hook retainers of your trailer hitch.

Install trailer safety chains to the trailer hitch as recommended by the manufacturer. Cross the chains under the trailer tongue and allow enough slack for turning tight corners. Do not allow the chains to drag on the ground.

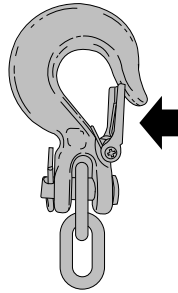

E265060

If the trailer safety chain hook has a latch, make sure the latch is fully closed.

Note: If you install the hook with the latch facing toward the rear of your vehicle, you may not be able to fully close the safety chain hook latch. If this occurs, install the hook with the latch facing toward the front of your vehicle.

Trailer Brakes



WARNING: Do not connect a trailer's hydraulic brake system directly to your vehicle's brake system. Your vehicle may not have enough braking power and your chances of having a collision greatly increase.

Towing

Electric brakes and manual, automatic or surge-type trailer brakes are safe if you install them properly and adjust them to the manufacturer's specifications. The trailer brakes must meet local and federal regulations.

The rating for the tow vehicle's braking system operation is at the gross vehicle weight rating, not the gross combined weight rating.

Separate functioning brake systems are required for safe control of towed vehicles and trailers weighing more than 1500 lb (680 kg) when loaded.

Integrated Trailer Brake Controller (If Equipped)



WARNING: The anti-lock brake system does not control the trailer brakes.



WARNING: Use the integrated trailer brake controller to properly adjust the trailer brakes and check all connections before towing a trailer. Failure to follow this instruction could result in the loss of control of your vehicle, personal injury or death.

Note: The integrated Ford brake controller is compatible with trailers equipped with electric-actuated drum brakes and electric-over-hydraulic brake systems.

Note: The integrated Ford brake controller does not control hydraulic surge-style brakes.

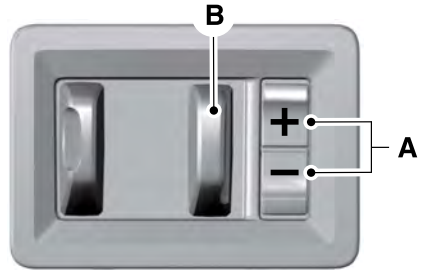

E183395

When used properly, the trailer brake controller assists in smooth and effective trailer braking by powering the trailer's electric or electric-over-hydraulic brakes with a proportional output based on the towing vehicle's brake pressure.

You can adjust the amount of initial trailer brake output by selecting one of three settings through the message center.

Ford has tested the trailer brake controller to be compatible with several major brands of electric-over-hydraulic trailer brakes. Contact an authorized dealer for information on which brands you can use.

The controller user interface consists of the following:

A: + and - (Gain adjustment buttons): Pressing these buttons adjusts the controller's power output to the trailer brakes in 0.5 increments. You can increase the gain setting to 10.0 (maximum trailer braking) or decrease it to 0 (no trailer braking). Pressing and holding a button raises or lowers the setting continuously. The gain setting displays in the message center as follows: **TBC GAIN = XX.X**.

Towing

B: Manual control lever: Slide the control lever to the left to switch on the trailer's electric brakes independent of the tow vehicle's. See the following **Procedure for adjusting gain** section for instructions on proper use of this feature. If you use the manual control while the brake is also applied, the greater of the two inputs determines the power sent to the trailer brakes.

- **Stop lamps:** Using the manual control lever lights both the trailer brake lamps and your vehicle brake lamps.

Trailer brake control messages appear in the information display as follows:

- **TBC GAIN = XX.X NO TRAILER:** Shows the current gain setting.
- **TBC GAIN = XX.X OUTPUT=// // //** //: Displays when braking. The bars indicate the amount of power going to the trailer brakes.
- **TRAILER CONNECTED:** Displays when the system senses a correct trailer wiring connection.
- **TRAILER DISCONNECTED:** Displays when the system senses a trailer disconnection.

Procedure for Setting Trailer Brake Controller Effort

Choose either the electric option for trailers with electromagnetic drum brakes, or the electric over hydraulic option for trailers with these brake systems.

Trailer Brake Effort Setting

The trailer brake controller allows the user to customize how aggressively the trailer brakes engage. The default value is the low setting and is the recommended setting for most trailers. If your trailer's brakes require more initial voltage, or if you prefer more aggressive trailer braking, then select either the medium or the high setting.

Procedure for Setting Trailer Brake Controller Mode

Choose the low, medium or high setting for the required initial trailer brake output.

Procedure for Adjusting Gain

Note: Only perform this procedure in a traffic-free environment at speeds of approximately 20–25 mph (30–40 km/h).

The gain setting adjusts the trailer brake controller for the specific towing condition. You should change the setting as towing conditions change. Changes to towing conditions include trailer load, vehicle load, road conditions and weather.

The gain should be set to provide the maximum trailer braking assistance while making sure the trailer wheels do not lock when using the brakes. Locked trailer wheels may lead to trailer instability.

1. Make sure the trailer brakes are in good working condition, functioning normally and properly adjusted. See your trailer dealer if necessary.
2. Hook up the trailer and make the electrical connections according to the trailer manufacturer's instructions.
3. When you plug in a trailer with electric or electric-over-hydraulic brakes, a confirmation message appears in the information display.
4. Use the gain adjustment (+ and -) buttons to increase or decrease the gain setting to the desired starting point. A gain setting of 6.0 is a good starting point for heavier loads.
5. In a traffic-free environment, tow the trailer on a dry, level surface at a speed of 20–25 mph (30–40 km/h) and squeeze the manual control lever completely.

Towing

6. If the trailer wheels lock up, indicated by squealing tires, reduce the gain setting. If the trailer wheels turn freely, increase the gain setting. Repeat Steps 5 and 6 until the gain setting is at a point just below trailer wheel lock-up. If towing a heavier trailer, trailer wheel lock-up may not be attainable even with the maximum gain setting of 10.

Information Display Warning Messages

Note: *An authorized dealer can diagnose the trailer brake controller to determine exactly which trailer fault has occurred. However, your Ford warranty does not cover this diagnosis if the fault is with the trailer.*

TRAILER BRAKE MODULE FAULT

Displays in response to faults sensed by the trailer brake controller, accompanied by a single tone. If this message appears, contact an authorized dealer as soon as possible for diagnosis and repair. The controller may still function, but with degraded performance.

WIRING FAULT ON TRAILER

Displays when there is a short circuit on the electric brake output wire.

If this message displays, with no trailer connected, the problem is with your vehicle wiring or trailer brake controller. Contact an authorized dealer.

If the message only displays with a trailer connected, the problem is with the trailer wiring. Consult your trailer dealer for assistance. This can be a short to ground (such as a chaffed wire), short to voltage (such as a pulled pin on trailer emergency breakaway battery) or the trailer brakes may be drawing too much current.

Points to Remember

Note: *Do not attempt removal of the trailer brake controller without consulting the Workshop Manual. Damage to the unit may result.*

- Adjust gain setting before using the trailer brake controller.
- Adjust gain setting, using the procedure above, whenever road, weather, trailer or vehicle loading conditions change from when the gain was initially set.
- Only use the manual control lever for proper adjustment of the gain during trailer setup. Misuse, such as application during trailer sway, could cause instability of trailer or tow vehicle.
- Avoid towing in adverse weather conditions. The trailer brake controller does not provide anti-lock control of the trailer wheels. Trailer wheels can lock up on slippery surfaces, resulting in reduced stability of trailer and tow vehicle.
- The trailer brake controller is equipped with a feature that reduces output at vehicle speeds below 11 mph (18 km/h) so trailer and vehicle braking is not jerky or harsh. This feature is only active when applying the brakes using your vehicle's brake pedal, not the controller.
- The controller interacts with the brake control system and powertrain control system of your vehicle to provide the best performance on different road conditions.

Towing

- Your vehicle's brake system and the trailer brake system work independently of each other. Changing the gain setting on the controller does not affect the operation of your vehicle's brakes.
- When you switch the engine off, the controller output is disabled and the display and module shut down.
- When stopped in congested or heavy traffic during hot weather, place the gearshift in park (P) to aid engine and transmission cooling and to help A/C performance.
- Turn off the speed control with heavy loads or in hilly terrain. The speed control may turn off automatically when you are towing on long, steep grades.

Trailer Lamps



WARNING: Never connect any trailer lamp wiring to the vehicle's tail lamp wiring; this may damage the electrical system resulting in fire. Contact your authorized dealer as soon as possible for assistance in proper trailer tow wiring installation. Additional electrical equipment may be required.

Trailer lamps are required on most towed vehicles. Make sure all running lights, brake lights, turn signals and hazard lights are working.

Before Towing a Trailer

Practice turning, stopping and backing up to get the feel of your vehicle-trailer combination before starting on a trip. When turning, make wider turns so the trailer wheels clear curbs and other obstacles.

When Towing a Trailer

- Check your hitch, electrical connections and trailer wheel lug nuts thoroughly after you have traveled 50 mi (80 km).
- Do not drive faster than 70 mph (113 km/h) during the first 500 mi (800 km).
- Do not make full-throttle starts.
- If your vehicle is equipped with Adaptive Steering and you have enabled Tow/Haul, the Adaptive Steering system adjusts the steering response to match your vehicle's load. The system reduces vehicle sensitivity to steering inputs at higher vehicle speeds while it maintains the ease of parking and maneuverability at low speeds.
- If your vehicle is equipped with AdvanceTrac with RSC, this system may turn on during typical cornering maneuvers with a heavily loaded trailer. This is normal. Turning the corner at a slower speed while towing may reduce this tendency.
- If you are towing a trailer frequently in hot weather, hilly conditions, at the gross combined weight rating (or any combination of these factors), consider refilling your rear axle with synthetic gear lubricant (if the axle is not already filled with it). See **Capacities and Specifications** (page 433).

Towing

- Allow more distance for stopping with a trailer attached. Anticipate stops and brake gradually.
- Avoid parking on a grade. However, if you must park on a grade:
 1. Turn the steering wheel to point your vehicle tires away from traffic flow.
 2. Set your vehicle parking brake.
 3. Place the transmission in park (P).
 4. Place wheel chocks in front and back of the trailer wheels. (Chocks not included with vehicle.)

Your vehicle may be equipped with a temporary or conventional spare tire. A "temporary" spare tire is different in size (diameter or width), tread-type (All-Season or All Terrain) or is from a different manufacturer than the road tires on your vehicle. Consult information on the tire label or Safety Compliance label for limitations when using.

Launching or Retrieving a Boat or Personal Watercraft (PWC)

Note: *Disconnect the wiring to the trailer before backing the trailer into the water.*

Note: *Reconnect the wiring to the trailer after you remove the trailer from the water.*

When backing down a ramp during boat launching or retrieval:

- Do not allow the static water level to rise above the bottom edge of the rear bumper.
- Do not allow waves to break higher than 6 in (15 cm) above the bottom edge of the rear bumper.

Exceeding these limits may allow water to enter vehicle components:

- Causing internal damage to the components.
- Affecting driveability, emissions, and reliability.

Replace the rear axle lubricant anytime the rear axle has been submerged in water. Water may have contaminated the rear axle lubricant, which is not normally checked or changed unless a leak is suspected or other axle repair is required.

TOWING THE VEHICLE ON FOUR WHEELS



WARNING: If your vehicle has a steering wheel lock make sure the ignition is in the accessory or on position when being towed.

Emergency Towing

If your vehicle becomes inoperable (without access to wheel dollies, car-hauling trailer, or flatbed transport vehicle), it can be flat-towed (all wheels on the ground, regardless of the powertrain and transmission configuration) under the following conditions:

- Your vehicle is facing forward for towing in a forward direction.
- Place the transmission in neutral (N). If you cannot move the transmission into neutral (N), you may need to override it. See **Transmission** (page 207).
- Maximum speed is 35 mph (56 km/h).
- Maximum distance is 50 mi (80 km).

Recreational Towing

Note: *Put your climate control system in recirculated air mode to prevent exhaust fumes from entering your vehicle. See **Climate Control** (page 142).*

Towing

Follow these guidelines if you have a need for recreational towing, such as towing your vehicle behind a motorhome. We have designed these guidelines to prevent damage to your transmission.

Two-wheel Drive Vehicles

Do not tow your vehicle with any wheels on the ground, as vehicle or transmission damage may occur. You must tow your vehicle with all four (4) wheels off the ground, such as when using a car-hauling trailer.

Four-wheel Drive Vehicles

Only tow a four-wheel drive vehicle that with all wheels on the ground. To do this, place the transfer case in its neutral position and engage the four-wheel-down towing feature.

Perform the steps in the following section after positioning your vehicle behind the tow vehicle and properly securing them together.

Note: Make sure you properly secure your vehicle to the tow vehicle.

Four-wheel-down Towing

1. Put the ignition in the on position, but do not start the engine. If your vehicle has an ignition key, turn the key to on. If your vehicle has intelligent access, press the engine **START/STOP** button once without pressing the brake pedal.
2. Press and hold the brake pedal.
3. Rotate the four-wheel drive switch to **2H**.
4. Shift the transmission to neutral (N).
5. Enable neutral tow through the information display by selecting **Settings** from the cluster menu.
6. Then select **Advanced Settings**.
7. Then select **Vehicle**.

8. Then select **Neutral Tow**. Press and hold the **OK** button. If completed successfully, the information display shows **Neutral Tow Enabled Leave Transmission in Neutral**. This indicates that your vehicle is safe to tow with all wheels on the ground.

Note: If you do not see the message in the display, you must perform the procedure again from the beginning.

Note: You may hear an audible noise as the transfer case shifts into its neutral position. This is normal.

9. Leave the transmission in neutral (N) and turn the ignition as far as it will go toward the off position (it will not turn fully off when the transmission is in neutral). If your vehicle has an ignition key, you must leave the key in the ignition while towing. To lock and unlock your vehicle, use the keyless entry keypad or extra set of keys. If your vehicle has intelligent access, press the engine **START/STOP** button once without pressing the brake pedal. You do not need to leave your keys in the vehicle. You can lock and unlock your vehicle as you normally do.
10. Release the brake pedal.



WARNING: Do not disconnect the battery during recreational towing. It prevents the transfer case from shifting properly and may cause the vehicle to roll, even if the transmission is in park (P).



WARNING: Shifting the transfer case to its neutral position for recreational towing may cause the vehicle to roll, even if the transmission is in park (P). It may injure the driver and others. Make sure you press the foot brake and the vehicle is in a secure, safe position when you shift to neutral (N).

Towing

Note: *Failing to put the transfer case in its neutral position while towing with all four wheels on the ground will damage vehicle components.*

Note: *You can check four-wheel-down towing status at any time by opening the driver's door or turning the ignition to the accessory or on position. A message displays in the information display confirming your vehicle is in neutral tow.*

To exit four-wheel-down towing and return the transfer case to its **2H** position:

1. With your vehicle still properly secured to the tow vehicle, put the ignition in the on position, but do not start the engine. If your vehicle has an ignition key, switch the key to on. If your vehicle has intelligent access, press the engine **START/STOP** button once without pressing the brake pedal.
2. Press and hold the brake pedal.
3. Shift the transmission out of neutral (N) and into any other gear.
4. Release the brake pedal.

Note: *If completed successfully, the instrument cluster displays **2H** and **Neutral Tow Disabled**.*

Note: *If the indicator light and message do not display, you must perform the procedure again from the beginning.*

Note: *You may hear an audible noise as the transfer case shifts out of its neutral position. This is normal.*

Note: *If **Shift Delayed Pull Forward** displays in the instrument cluster, transfer case gear tooth blockage is present. See resolving the shift delayed pull forward message instructions after this section.*

5. Apply the parking brake and disconnect the vehicle from the tow vehicle.

6. Release the parking brake, start the engine and shift the transmission to drive (D) to make sure the transfer case is out of neutral (N).
7. If the transfer case does not successfully shift out of neutral (N), set the parking brake until you can have your vehicle serviced.

Resolving the Shift Delay Pull Forward Message

If the instrument cluster displays **Shift Delayed Pull Forward**. You need to perform the following steps:

1. Press and hold the brake pedal.
2. Put the transmission into neutral (N), and then start the engine.
3. With the engine running, shift the transmission to drive (D) and let the vehicle roll forward, up to 3 ft (1 m). You may hear an audible noise as the transfer case shifts out of its neutral position. This is normal.
4. Make sure the instrument cluster displays **Neutral Tow Disabled**.

Driving Hints

ECONOMICAL DRIVING

Your fuel economy is affected by several things, such as how you drive, the conditions you drive under, and how you maintain your vehicle.

You may improve your fuel economy by keeping these things in mind:

- Accelerate and slow down in a smooth, moderate fashion.
- Drive at steady speeds without stopping.
- Anticipate stops; slowing down may eliminate the need to stop.
- Combine errands and minimize stop-and-go driving.
- Close the windows for high-speed driving.
- Drive at reasonable speeds (traveling at 55 mph [88 km/h] uses 15% less fuel than traveling at 65 mph [105 km/h]).
- Keep the tires properly inflated and use only the recommended size.
- Use the recommended engine oil.
- Perform all regularly scheduled maintenance.

Avoid these actions; they reduce your fuel economy:

- Sudden accelerations or hard accelerations.
- Revving the engine before turning it off.
- Idle for periods longer than one minute.
- Warm up your vehicle on cold mornings.
- Use the air conditioner or front defroster.
- Use the speed control in hilly terrain.
- Rest your foot on the brake pedal while driving.

- Drive a heavily loaded vehicle or tow a trailer.
- Carry unnecessary weight (approximately 1 mpg [0.4 km/L] is lost for every 400 lb [180 kilogram] of weight carried).
- Driving with the wheels out of alignment.

Conditions

- Heavily loading a vehicle or towing a trailer may reduce fuel economy at any speed.
- Adding certain accessories to your vehicle (for example bug deflectors, rollbars, light bars, running boards, ski racks or luggage racks) may reduce fuel economy.
- To maximize the fuel economy, drive with the tonneau cover installed (if equipped).
- Using fuel blended with alcohol may lower fuel economy.
- Fuel economy may decrease with lower temperatures during the first 5–10 mi (12–16 km) of driving.
- Driving on flat terrain offers improved fuel economy as compared to driving on hilly terrain.
- Transmissions give their best fuel economy when operated in the top cruise gear and with steady pressure on the gas pedal.
- Four-wheel-drive operation (if equipped) is less fuel efficient than two-wheel-drive operation.

OFF-ROAD DRIVING (IF EQUIPPED)

Note: *The following off-road driving information applies to Tremor package equipped vehicles only.*

Driving Hints

In addition to providing an excellent on-road driving experience, your vehicle excels at all types of off-road driving. Your vehicle has been designed and equipped to allow you to explore those places where the road doesn't take you, whether it's a forest trail or the open desert. Before going off-roading, consult with your local governmental agencies to determine designated off-road trails and recreation areas. Also, be sure to understand any off-road vehicle registration requirements for the area in which you plan on driving.

Tread Lightly® is an educational program designed to increase public awareness of land-use regulations and responsibilities in our nation's wilderness areas. Ford joins the U.S. Forest Service and Bureau of Land Management in encouraging you to help preserve our national forest and other public and private lands by treading lightly.

Before taking your vehicle off-roading, a basic vehicle inspection should be conducted to make sure that the vehicle is in peak operating condition.

It is always recommended that at least two vehicles are used while off-roading. The buddy system helps make sure that help is close at hand should a vehicle become stuck or damaged. It is also wise to take supplies such as a first aid kit, drinking water, tow strap, cell or satellite phone with you any time an off-road excursion is planned.

Remove the front license plate before off-roading to achieve optimal performance.

Basic Off-road Driving Techniques

- Grip the steering wheel with thumbs on the outside of the rim. This reduces the risk of injury due to abrupt steering wheel motions that occur when negotiating rough terrain. Do not grip the steering wheel with thumbs inside the rim.
- Throttle, brake and steering inputs should be made in a smooth and controlled manner. Sudden inputs to the controls can cause loss of traction or upset the vehicle, especially while on sloped terrain or while crossing obstacles such as rocks or logs.
- Look ahead on your route noting upcoming obstacles, changes to surface texture, color changes and any other factors which may indicate a change in available traction. Adjusting the vehicle speed and route accordingly. During pre-run, mark obstacles with GPS markers to make sure appropriate speeds are used to avoid potential vehicle damage.
- When driving off-road, if the front or rear suspension is bottoming-out and/or excessive contact with the skid-plates is encountered, reduce vehicle speed to avoid potential damage to the vehicle.
- When running with other vehicles, it is recommended that some form of radio communication is used so the lead vehicle can notify others of obstacles that could cause damage.
- Always keep available ground clearance in mind and pick a route that minimizes the risk of catching the underside of the vehicle on an obstacle.

Driving Hints

- When negotiating low speed obstacles, applying light brake pressure in conjunction with the throttle will help prevent the vehicle from lurching and will allow you to negotiate the obstacle in a more controlled manner. Using 4L also assists with this.
- Use and equip supplemental safety equipment.
- Please consult your local off-road group for other helpful tips.
- Off-roading requires a high degree of concentration. Even if your local law does not prohibit alcohol use while driving off-road, Ford strongly recommends against drinking alcohol if you plan to off-road.

Crossing Obstacles

- Review the path ahead before attempting to cross any obstacles. It is best if the obstacles are reviewed from outside the vehicle so that there is a good understanding of the terrain condition both in front of and behind the obstacles.
- Approach obstacles slowly and slowly creep the vehicle over.
- If a large obstacle such as a rock cannot be avoided, choose a path that places the rock directly under the tire rather than the undercarriage of the vehicle. This helps prevent damage to the vehicle.
- Ditches and washouts should be crossed at a 45 degree angle, allowing each wheel to independently cross the obstacle.

Hill Climbing



WARNING: Extreme care should be used when steering the vehicle in reverse down a slope so as not to cause the vehicle to swerve out of control.

- Always attempt to climb a steep hill along the fall line of the slope and not diagonally.
- If the vehicle is unable to make it up the hill, DO NOT attempt to turn back down the slope. Place the vehicle in low range and slowly back down in reverse.
- When descending a steep slope, select low gear and engage trail control. Use the throttle and brake pedals to control your descent speed as described earlier in this section using trail control. Note that trail control is functional in reverse and should be used in this situation.

After Off-Road Driving

It is important to complete a full vehicle inspection after off-road driving. Some items to check include:

- Make sure that tires are inflated to proper tire pressure as indicated on the tire placard.
- Check the wheels and undercarriage for built up mud or debris which can cause vehicle vibration.
- Make sure that the grille and radiator are clear of any obstructions that may affect cooling.
- Make sure that the brakes are in proper working order and free of any mud, stones and debris, which can become trapped around the brake rotor, backing plate and caliper.
- Check that the air filter is clean and dry.
- Inspect for torn or punctured boots on ball joints, half shafts, steering gears.

Driving Hints

- Inspect exhaust system for damage or looseness.
- Inspect undercarriage fasteners. If any are loose or damaged, tighten or replace ensuring that the proper torque specification is used.
- Inspect the tires for any cuts in the tread or sidewall area. Also inspect the sidewall for any bulge indicating damage to the tire.
- Inspect the wheels for dents, cracks, or other damage.
- Refit the front license plate if removed previously.

BREAKING-IN

You need to break in new tires for approximately 300 mi (480 km). During this time, your vehicle may exhibit some unusual driving characteristics.

Avoid driving too fast during the first 1,000 mi (1,600 km). Vary your speed frequently and change up through the gears early. Do not labor the engine.

Drive your new vehicle at least 1,000 mi (1,600 km) before towing a trailer. Make sure you use the specified engine oil. See **Capacities and Specifications** (page 441).

Do not add friction modifier compounds or special break-in oils during the first few thousand miles (kilometers) of operation. These additives may prevent piston ring seating.

DRIVING THROUGH WATER



WARNING: Do not drive through flowing or deep water as you may lose control of your vehicle.

Note: Engine damage can occur if water enters the air filter.

For Vehicles without Tremor Off-Road Package

Note: Driving through standing water can cause vehicle damage.

Note: Drive through water in an emergency only and not as part of normal driving.

Before driving through standing water, check the depth. Never drive through water that is higher than the bottom of the wheel hubs.

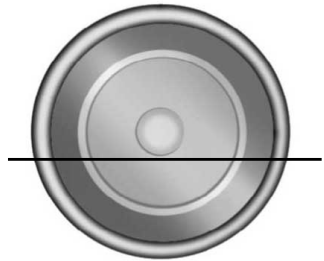

E176913

When driving through standing water, drive very slowly and do not stop your vehicle. Your brake performance and traction may be limited. After driving through water and as soon as it is safe to do so:

- Lightly press the brake pedal to dry the brakes and to check that they work.
- Check that the horn works.
- Check that the exterior lights work.
- Turn the steering wheel to check that the steering power assist works.

Driving Hints

For Vehicles with Tremor Off-Road Package

Your vehicle equipped with Tremor Off-Road package is capable of traveling through water at a maximum depth of 33 in (837 mm). When driving through standing water do not exceed crawl speed of 4 mph (7 km/h).

- Always determine the depth before attempting a water crossing.
- Proceed slowly and avoid splashing water any more than is necessary. As the water depth increases, vehicle speed must be reduced to avoid potential vehicle damage.
- Be aware that obstacles and debris may be beneath the water's surface.
- Keep the doors fully closed during the water crossing.
- Upon completion of the water crossing, slowly drive a short distance and check the brakes for full effectiveness.

SNOW PLOWING

Ford recommends that the Super Duty F-Series used for snow removal include the snowplow package option.

Installing the Snowplow

Weight limits and guidelines for selecting and installing the snowplow are in the Ford Truck Body Builders Layout Book, snowplow section, found at www.fleet.ford.com/truckbbas. A typical installation affects the following:

- Certification to government safety laws such as occupant protection and airbag deployment, braking, and lighting. Look for an Alterer's Label on the vehicle from the snowplow installer certifying that the installation meets all applicable Federal Motor Vehicle Safety Standards (FMVSS).
- The Total Accessory Reserve Capacity (TARC) is on the lower right side of the vehicle's Safety Compliance Certification Label. This applies to Ford-completed vehicles of 10,000 lb (4,536 kg) GVWR or less. This is the weight of permanently-attached auxiliary equipment, such as snowplow frame-mounting hardware, that can be added to the vehicle and satisfy Ford compliance certification to FMVSS. Exceeding this weight may require the auxiliary equipment installer additional safety certification responsibility. The Front Accessory Reserve Capacity (FARC) is for customer convenience.
- Rear ballast weight behind the rear axle may be required to prevent exceeding the FGAWR, and provide front-to-rear weight balance for proper braking and steering.
- Front wheel toe may require re-adjustment to prevent premature uneven tire wear. Specifications are in the Ford Workshop Manual.
- Headlight aim may require re-adjustment.

Driving Hints

- The tire air pressures recommended for general driving are on the vehicle's Safety Certification Label. The maximum cold inflation pressure for the tire and associated load rating is on the tire sidewall. Tire air pressure may require re-adjustment within these pressure limits to accommodate the additional weight of the snowplow installation.
- Federal and some local regulations require additional exterior lamps for snowplow-equipped vehicles. Consult your authorized dealer for additional information.

Operating the Vehicle with the Snowplow Attached

Note: Do not use your vehicle for snow removal until you have driven at least 500 mi (800 km).

Ford recommends vehicle speed does not exceed 45 mph (72 km/h) when snowplowing.

If transporting a snowplow in summertime, cooling system airflow may be blocked by the snowplow. Change the snowplow height or position to improve airflow to the radiator or limit your vehicle speed to a maximum of 45 mph (72 km/h).

The attached snowplow blade restricts airflow to the radiator, and may cause the engine to run at a higher temperature: Attention to engine temperature is especially important when outside temperatures are above freezing. Angle the blade to maximize airflow to the radiator and monitor engine temperature to determine whether a left or right angle provides the best performance.

Follow the severe duty schedule in your Scheduled Maintenance information for engine oil and transmission fluid change intervals.

Snowplowing with your Airbag Equipped Vehicle



WARNING: Do not attempt to service, repair, or modify the supplementary restraint system or associated components. Failure to follow this instruction could result in personal injury or death.



WARNING: All occupants of your vehicle, including the driver, should always properly wear their seatbelts, even when an airbag supplemental restraint system is provided. Failure to properly wear your seatbelt could seriously increase the risk of injury or death.

Note: Additional equipment for example snowplow equipment may affect the performance of the airbag sensors increasing the risk of injury. Please refer to the Body Builders Layout Book for instructions about the appropriate installation of additional equipment.

Your vehicle is equipped with a driver and passenger airbag supplemental restraint system. The supplemental restraint system will activate in certain frontal and offset frontal collisions when the vehicle sustains sufficient frontal deceleration.

Careless or high speed driving while plowing snow that results in sufficient vehicle decelerations can deploy the airbags. Such driving also increases the risk of accidents.

Never remove or defeat the tripping mechanisms designed into the snow removal equipment by its manufacturer. Doing so may cause damage to the vehicle and the snow removal equipment as well as possible airbag deployment.

Driving Hints

Engine temperature while plowing

When driving with a plow, your engine may run at a higher temperature than normal because the attached snowplow blade will restrict airflow to the radiator.

- If you are driving more than 15 mi (24 km) at temperatures above freezing, angle the plow blade either full left or full right to provide maximum airflow to the radiator.
- If you are driving less than 15 mi (24 km) at speeds up to 45 mph (72 km/h) in cold weather, you will not need to worry about blade position to provide maximum airflow.

Transmission operation while plowing



WARNING: Do not spin the wheels at over 34 mph (55 km/h). The tires may fail and injure a passenger or bystander.

- Shift transfer case to **4L** (4WD Low) when plowing in small areas at speeds below 5 mph (8 km/h).
- Shift transfer case to **4H** (4WD High) when plowing larger areas or light snow at higher speeds. Do not exceed 15 mph (24 km/h).
- Do not shift the transmission from a forward gear to **R** (Reverse) until the engine is at idle and the wheels have stopped.

FLOOR MATS



WARNING: Use a floor mat designed to fit the footwell of your vehicle that does not obstruct the pedal area. Failure to follow this instruction could result in the loss of control of your vehicle, personal injury or death.



WARNING: Pedals that cannot move freely can cause loss of vehicle control and increase the risk of serious personal injury.



WARNING: Secure the floor mat to both retention devices so that it cannot slip out of position and interfere with the pedals. Failure to follow this instruction could result in the loss of control of your vehicle, personal injury or death.



WARNING: Do not place additional floor mats or any other covering on top of the original floor mats. This could result in the floor mat interfering with the operation of the pedals. Failure to follow this instruction could result in the loss of control of your vehicle, personal injury or death.



WARNING: Always make sure that objects cannot fall into the driver foot well while your vehicle is moving. Objects that are loose can become trapped under the pedals causing a loss of vehicle control.

Driving Hints



E142666

To install the floor mats, position the floor mat eyelet over the retention post and press down to lock in position.

To remove the floor mat, reverse the installation procedure.

Note: *Regularly check the floor mats to make sure they are secure.*

Roadside Emergencies

ROADSIDE ASSISTANCE

Vehicles Sold in the United States: Getting Roadside Assistance

To fully assist you should you have a vehicle concern, Ford Motor Company offers a complimentary roadside assistance program. This program is separate from the New Vehicle Limited Warranty.

The service is available:

- 24 hours a day, seven days a week.
- For the coverage period supplied with your vehicle.

Roadside Assistance covers:

- A flat tire change with a good spare (except vehicles supplied with a tire inflation kit).
- Battery jump start.
- Lock-out assistance (key replacement cost is the customer's responsibility).
- Fuel delivery — independent service contractors, if not prohibited by state, local or municipal law, shall deliver up to 2 gal (8 L) of gasoline or 5 gal (20 L) of diesel fuel to a disabled vehicle. Roadside Assistance limits fuel delivery service to two no-charge occurrences within a 12-month period.
- Winch out — available within 100 ft (30 m) of a paved or county maintained road, no recoveries.

- Towing — independent service contractors, if not prohibited by state, local or municipal law, shall tow Ford eligible vehicles to an authorized dealer within 35 mi (56 km) of the disablement location or to the nearest authorized dealer. If a member requests a tow to an authorized dealer that is more than 35 mi (56 km) from the disablement location, the member shall be responsible for any mileage costs in excess of 35 mi (56 km).
- Roadside Assistance includes up to \$200 for a towed trailer if the disabled eligible vehicle requires service at the nearest authorized dealer. If the towing vehicle is operational but the trailer is not, then the trailer does not qualify for any roadside services.

Vehicles Sold in the United States: Using Roadside Assistance

Complete the roadside assistance identification card and place it in your wallet for quick reference. This card is in the Owner's Manual kit.

United States vehicle customers who require Roadside Assistance, call 1-800-241-3673.

If you need to arrange roadside assistance for yourself, Ford Motor Company reimburses a reasonable amount for towing to the nearest dealership within 35 mi (56 km). To obtain reimbursement information, United States vehicle customers call 1-800-241-3673. Customers need to submit their original receipts.

Roadside Emergencies

Vehicles Sold in Canada: Getting Roadside Assistance

To fully assist you should you have a vehicle concern, Ford Motor Company of Canada, Limited offers a complimentary roadside assistance program. This program is eligible within Canada or the continental United States.

The service is available 24 hours a day, seven days a week.

This program is separate from the New Vehicle Limited Warranty, but the coverage is concurrent with the powertrain coverage period of your vehicle. Canadian roadside coverage and benefits may differ from the U.S. coverage.

If you require more information, please call us in Canada at 1-800-665-2006, or visit our website at www.ford.ca.

HAZARD FLASHERS

Note: *The hazard flashers operate when the ignition is in any position, or if the key is not in the ignition. If used when the vehicle is not running, the battery loses charge. As a result, there may be insufficient power to restart your vehicle.*



The flasher control is on the instrument panel. Use your hazard flashers when your vehicle is creating a safety hazard for other motorists.

- Press the flasher control and all front and rear direction indicators flash.
- Press the button again to switch them off.

FIRE EXTINGUISHER (IF EQUIPPED)

Every month you should visually inspect it and verify that the indicator and the canister show no damage, the trigger is in good operating condition, and there is no obstruction to removing the extinguisher.

Maintenance of the fire extinguisher is the responsibility of the owner. The operating instructions are on the fire extinguisher. When replacing, make sure the new fire extinguisher is of type dry powder ABC.

Note: *Before use, remove the transparent plastic packaging to prevent obstruction.*

Note: *Make sure you regularly check the expiration date on the fire extinguisher.*

WARNING TRIANGLE (IF EQUIPPED)

You can stow the warning triangle in the rear load floor storage compartment.

FUEL SHUTOFF



WARNING: If your vehicle has been involved in a crash, have the fuel system checked. Failure to follow this instruction could result in fire, personal injury or death.

Note: *When you try to restart your vehicle after a fuel shutoff, the vehicle makes sure that various systems are safe to restart. Once the vehicle determines the systems are safe, then the vehicle allows you to restart.*

Note: *In the event that your vehicle does not restart after your third attempt, contact a qualified technician.*

Roadside Emergencies

The fuel pump shutoff stops the flow of fuel to the engine in the event of a moderate to severe crash. Not every impact causes a shutoff.

Should your vehicle shut off after a crash, you may restart your vehicle.

If your vehicle has a key system:

1. Switch off the ignition.
2. Switch to start position.
3. Switch off the ignition.
4. Switch on the ignition to re-enable the fuel pump.
5. If the vehicle does not start, repeat steps 1 through 4.

If your vehicle has a push button start system:

1. Press **START/STOP** to switch off your vehicle.
2. Press the brake pedal and **START/STOP** to switch on your vehicle.
3. Remove your foot from the brake pedal and press **START/STOP** to switch off your vehicle.
4. You can attempt to start the vehicle by pressing the brake pedal and **START/STOP**, or press **START/STOP** without pressing the brake pedal.
5. If the vehicle does not start, repeat steps 1 through 4.

JUMP STARTING THE VEHICLE



WARNING: Batteries normally produce explosive gases which can cause personal injury. Therefore, do not allow flames, sparks or lighted substances to come near the battery. When working near the battery, always shield your face and protect your eyes. Always provide correct ventilation.



WARNING: Keep batteries out of reach of children. Batteries contain sulfuric acid. Avoid contact with skin, eyes or clothing. Shield your eyes when working near the battery to protect against possible splashing of acid solution. In case of acid contact with skin or eyes, flush immediately with water for a minimum of 15 minutes and get prompt medical attention. If acid is swallowed, call a physician immediately.



WARNING: Use only adequately sized cables with insulated clamps.

Preparing Your Vehicle

Do not attempt to push-start your automatic transmission vehicle.

Note: *Attempting to push-start a vehicle with an automatic transmission may cause transmission damage.*

Note: *Use only a 12-volt supply to start your vehicle.*

Note: *Do not disconnect the battery of the disabled vehicle as this could damage the vehicle electrical system.*

Park the booster vehicle close to the hood of the disabled vehicle, making sure the two vehicles do not touch.

Connecting the Jumper Cables



WARNING: Do not attach the cables to fuel lines, engine rocker covers, the intake manifold or electrical components as grounding points. Stay clear of moving parts. To avoid reverse polarity connections, make sure that you correctly identify the positive (+) and negative (-) terminals on both the disabled and booster vehicles before connecting the cables.

Roadside Emergencies



WARNING: Do not attach the end of the positive cable to the studs or L-shaped eyelet located above the positive (+) terminal of your vehicle's battery. High current may flow through and cause damage to the fuses.



WARNING: Do not connect the end of the second cable to the negative (-) terminal of the battery to be jumped. A spark may cause an explosion of the gases that surround the battery.

Note: In the illustration, the bottom vehicle represents the booster vehicle.

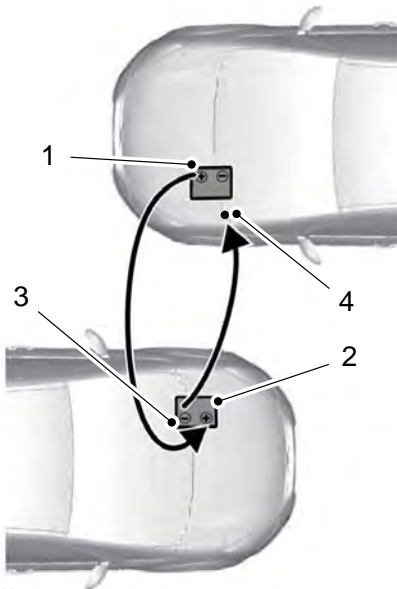

E142664

1. Connect the positive (+) jumper cable to the positive (+) terminal of the discharged battery.

2. Connect the other end of the positive (+) cable to the positive (+) terminal of the booster vehicle battery.
3. Connect the negative (-) cable to the negative (-) terminal of the booster vehicle battery.
4. Make the final connection of the negative (-) cable to an exposed metal part of the stalled vehicle's engine, away from the battery and the fuel injection system, or connect the negative (-) cable to a ground connection point if available.

Jump Starting

1. Start the engine of the booster vehicle and rev the engine moderately, or press the accelerator gently to keep your engine speed between 2000 and 3000 RPM, as shown in your tachometer.
2. Start the engine of the disabled vehicle.
3. Once the disabled vehicle has been started, run both vehicle engines for an additional three minutes before disconnecting the jumper cables.

Removing the Jumper Cables

Remove the jumper cables in the reverse order that they were connected.

Roadside Emergencies

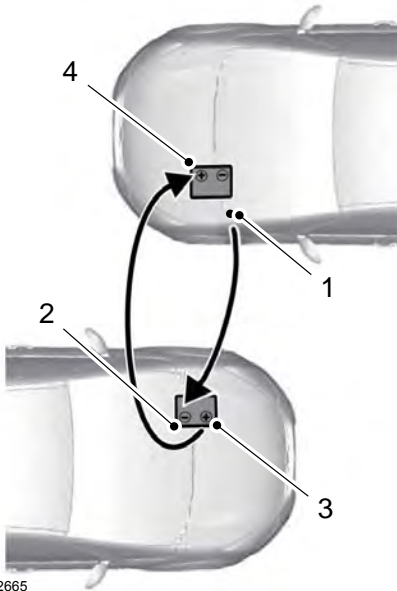

E142665

1. Remove the negative (-) jumper cable from the disabled vehicle.
2. Remove the jumper cable on the negative (-) terminal of the booster vehicle battery.
3. Remove the jumper cable from the positive (+) terminal of the booster vehicle battery.
4. Remove the jumper cable from the positive (+) terminal of the disabled vehicle battery.
5. Allow the engine to idle for at least one minute.

POST-CRASH ALERT SYSTEM

The system flashes the direction indicators and sounds the horn (intermittently) in the event of a serious impact that deploys an airbag (front, side, side curtain or Safety Canopy) or the seatbelt pretensioners.

The horn and indicators turn off when:

- You press the hazard control button.
- You press the panic button on the remote entry transmitter (if equipped).
- Your vehicle runs out of power.
- Sounding of the horn is only enabled in specific markets.

TRANSPORTING THE VEHICLE



WARNING: Block the wheels to help prevent the vehicle from moving.



WARNING: Unexpected and possibly sudden vehicle movement may occur if you do not take these precautions.

Roadside Emergencies

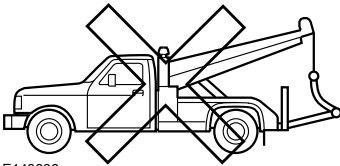
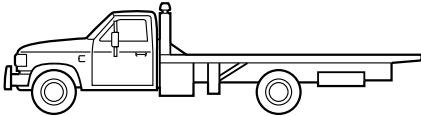
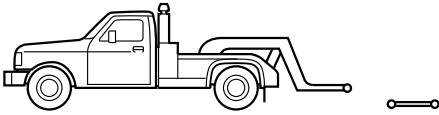

E143886

If you need to tow your vehicle, contact a professional towing service or, if you are a member of a roadside assistance program, your roadside assistance service provider.

We recommend the use of a wheel lift and dollies or flatbed equipment to tow your vehicle. Do not tow with a slingbelt. We do not approve a slingbelt towing procedure. If you tow your vehicle incorrectly, or by any other means, vehicle damage may occur.

We produce a towing manual for all authorized tow truck operators. Have your tow truck operator refer to this manual for proper hook-up and towing procedures for your vehicle.

It is acceptable to have your two-wheel drive vehicle towed with the front wheels on the ground (without dollies) and the rear wheels off the ground.

We recommend towing a four-wheel drive vehicle with all wheels off the ground, such as using a wheel lift and dollies or flatbed equipment. However, it is acceptable to use a wheel lift to raise the rear of your vehicle so long as, depending on vehicle configuration, you perform the following before towing:

- If your vehicle has a manual-shift transfer case, make sure the front wheel hub locks are in the **FREE** position before towing.
- If your vehicle has an electronic shift-on-the-fly transfer case, make sure you switch the four-wheel drive control to the **2H** position before towing.

Note: Towing an electronic shift-on-the-fly four-wheel drive vehicle with the front wheels on the ground without disengaging the front hubs may cause damage to the automatic transmission.

Note: Towing a two-wheel drive vehicle or an electronic shift-on-the-fly four-wheel drive vehicle with the rear wheels on the ground for more than 50 mi (80 km) or faster than 35 mph (56 km/h) may cause damage to the automatic transmission.

Note: Using wheel lift equipment to tow a dual rear wheel vehicle requires removing an outer rear wheel before towing.

TOWING POINTS



WARNING: Using recovery hooks is dangerous and should only be done by a person familiar with proper vehicle recovery safety practices. Improper use of recovery hooks may cause hook failure or separation from the vehicle and could result in serious injury or death.

Roadside Emergencies



WARNING: Always slowly remove the slack from the recovery strap prior to pulling. Failure to do so can introduce significantly higher loads which can cause the recovery hooks to break off, or the recovery strap to fail which can cause serious injury or death.



WARNING: Never link two straps together with a clevis pin. These heavy metal objects could become projectiles if the strap breaks and can cause serious injury or death.

- Always align the tow vehicle and stuck vehicle in a straight line (within 10 degrees).
- Keep bystanders to the **sides** of the vehicle, at a distance of at least twice the length of the recovery strap. This helps avoid injury from the hazard of a recovery hook or strap breaking, or a vehicle lurching into their path.

Your vehicle comes equipped with frame-mounted front recovery hooks. These hooks should never have a load applied to them greater than the gross vehicle weight rating of your vehicle.

Before using recovery hooks:

- Make sure all attaching points are secure and capable of withstanding the applied load.
- Never use chains, cables or tow straps with metal hook ends.
- Only use recovery straps that have a minimum breaking strength two to three times the gross vehicle weight of the stuck vehicle.
- Make sure the recovery strap is in good condition and free of visible cuts, tears or damage.
- Use a damper device such as a tarp, heavy blanket or piece of carpet draped over the recovery strap to help absorb the energy in the event the strap breaks.
- Make sure the stuck vehicle is not loaded heavier than its gross vehicle weight rating specified on the certification label.

Customer Assistance

GETTING THE SERVICES YOU NEED

Warranty repairs to your vehicle must be performed by an authorized dealer. While any authorized dealer handling your vehicle line will provide warranty service, we recommend you return to your selling authorized dealer who wants to ensure your continued satisfaction.

Please note that certain warranty repairs require special training and equipment, so not all authorized dealers are authorized to perform all warranty repairs. This means that, depending on the warranty repair needed, you may have to take your vehicle to another authorized dealer.

A reasonable time must be allowed to perform a repair after taking your vehicle to the authorized dealer. Repairs will be made using Ford or Motorcraft® parts, or remanufactured or other parts that are authorized by Ford.

Away From Home

If you are away from home when your vehicle needs service, contact the Ford Customer Relationship Center or use the online resources listed below to find the nearest authorized dealer.

In the United States:

Mailing address

Ford Motor Company
Customer Relationship Center
P.O. Box 6248
Dearborn, MI 48126

Telephone

1-800-392-3673 (FORD)
(TDD for the hearing impaired:
1-800-232-5952)

If your vehicle is configured as a motorhome please call 1-800-444-3311 for support.

Additional information and resources are available online:

Website
www.owner.ford.com

These are some of the items that can be found online:

- U.S. dealer locator by Dealer Name, City/State or Zip Code.
- Owner Manuals.
- Maintenance Schedules.
- Recalls.
- Ford Extended Service Plans.
- Ford Genuine Accessories.
- Service specials and promotions.

In Canada:

Mailing address

Customer Relationship Centre
Ford Motor Company of Canada, Limited
P.O. Box 2000
Oakville, Ontario L6K 0C8

Telephone

1-800-565-3673 (FORD)
(TDD for the hearing impaired:
1-888-658-6805)

Website
www.ford.ca

Facebook

FordServiceCA (English)
FordServiceQC (Français)

Twitter

@FordServiceCA

Customer Assistance

Additional Assistance

If you have questions or concerns, or are unsatisfied with the service you are receiving, follow these steps:

1. Contact your Sales Representative or Service Advisor at your selling or servicing authorized dealer.
2. If your inquiry or concern remains unresolved, contact the Sales Manager, Service Manager or Customer Relations Manager.
3. If you require assistance or clarification on Ford Motor Company policies, please contact the Ford Customer Relationship Center.

In order to help us serve you better, please have the following information available when contacting a Customer Relationship Center:

- Vehicle Identification Number.
- Your telephone number (home and business).
- The name of the authorized dealer and city where located.
- The vehicle's current odometer reading.

In some states within the United States, you must directly notify Ford in writing before pursuing remedies under your state's warranty laws, and Ford is also allowed a final repair attempt.

Additionally, in some states within the United States, a consumer has the option of submitting a warranty dispute to the BBB Auto Line before taking action under the Magnuson-Moss Warranty Act, or to the extent allowed by state law, before pursuing replacement or repurchase remedies provided by certain state laws. This dispute handling procedure is not required prior to enforcing state created rights or other rights which are independent of the Magnuson-Moss Warranty Act or state replacement or repurchase laws.

IN CALIFORNIA (U.S. ONLY)

California Civil Code Section 1793.2(d) requires that, if a manufacturer or its representative is unable to repair a motor vehicle to conform to the vehicle's applicable express warranty after a reasonable number of attempts, the manufacturer shall be required to either replace the vehicle with one substantially identical or repurchase the vehicle and reimburse the buyer in an amount equal to the actual price paid or payable by the consumer (less a reasonable allowance for consumer use). The consumer has the right to choose whether to receive a refund or replacement vehicle.

California Civil Code Section 1793.22(b) presumes that the manufacturer has had a reasonable number of attempts to conform the vehicle to its applicable express warranties if, within the first 18 months of ownership of a new vehicle or the first 18,000 mi (29,000 km), whichever occurs first:

1. Two or more repair attempts are made on the same non-conformity likely to cause death or serious bodily injury OR
2. Four or more repair attempts are made on the same nonconformity (a defect or condition that substantially impairs the use, value or safety of the vehicle) OR
3. The vehicle is out of service for repair of nonconformities for a total of more than 30 calendar days (not necessarily all at one time).

In the case of 1 or 2 above, the consumer must also notify the manufacturer of the need for the repair of the nonconformity at the following address:

Ford Motor Company
16800 Executive Plaza Drive
Mail Drop 3NE-B
Dearborn, MI 48126

Customer Assistance

You are required to submit your warranty dispute to BBB AUTO LINE before asserting in court any rights or remedies conferred by California Civil Code Section 1793.22(b). You are also required to use BBB AUTO LINE before exercising rights or seeking remedies created by the Federal Magnuson-Moss Warranty Act, 15 U.S.C. sec. 2301 et seq. If you choose to seek redress by pursuing rights and remedies not created by California Civil Code Section 1793.22(b) or the Magnuson-Moss Warranty Act, resort to BBB AUTO LINE is not required by those statutes.

THE BETTER BUSINESS BUREAU (BBB) AUTO LINE PROGRAM (U.S. ONLY)

Your satisfaction is important to Ford Motor Company and to your dealer. If a warranty concern has not been resolved using the three-step procedure outlined earlier in this chapter in the Getting the Services you need section, you may be eligible to participate in the BBB AUTO LINE program.

The BBB AUTO LINE program consists of two parts – mediation and arbitration. During mediation, a representative of the BBB will contact both you and Ford Motor Company to explore options for settlement of the claim. If an agreement is not reached during mediation or you do not want to participate in mediation, and if your claim is eligible, you may participate in the arbitration process. An arbitration hearing will be scheduled so that you can present your case in an informal setting before an impartial person. The arbitrator will consider the testimony provided and make a decision after the hearing.

Disputes submitted to the BBB AUTO LINE program are usually decided within forty days after you file your claim with the BBB. You are not bound by the decision, and may reject the decision and proceed to court where all findings of the BBB Auto Line dispute, and decision, are admissible in the court action. Should you choose to accept the BBB AUTO LINE decision, Ford is then bound by the decision, and must comply with the decision within 30 days of receipt of your acceptance letter.

BBB AUTO LINE Application: Using the information provided below, please call or write to request a program application. You will be asked for your name and address, general information about your new vehicle, information about your warranty concerns, and any steps you have already taken to try to resolve them. A Customer Claim Form will be mailed that will need to be completed, signed and returned to the BBB along with proof of ownership. Upon receipt, the BBB will review the claim for eligibility under the Program Summary Guidelines.

You can get more information by calling BBB AUTO LINE at 1-800-955-5100, or writing to:

**BBB AUTO LINE
3033 Wilson Boulevard, Suite 600
Arlington, Virginia 22201**

BBB AUTO LINE applications can also be requested by calling the Ford Motor Company Customer Relationship Center at 1-800-392-3673.

For additional information refer to the Better Business Bureau website.

Note: *Ford Motor Company reserves the right to change eligibility limitations, modify procedures, or to discontinue this process at any time without notice and without obligation.*

Customer Assistance

UTILIZING THE MEDIATION/ARBITRATION PROGRAM (CANADA ONLY)

For vehicles delivered to authorized Canadian dealers. In those cases where you continue to feel that the efforts by Ford of Canada and the authorized dealer to resolve a factory-related vehicle service concern have been unsatisfactory, Ford of Canada participates in an impartial third party mediation/arbitration program administered by the Canadian Motor Vehicle Arbitration Plan (CAMVAP).

The CAMVAP program is a straight forward and relatively speedy alternative to resolve a disagreement when all other efforts to produce a settlement have failed. This procedure is without cost to you and is designed to eliminate the need for lengthy and expensive legal proceedings.

In the CAMVAP program, impartial third-party arbitrators conduct hearings at mutually convenient times and places in an informal environment. These impartial arbitrators review the positions of the parties, make decisions and, when appropriate, render awards to resolve disputes. CAMVAP decisions are fast, fair, and final as the arbitrator's award is binding on both you and Ford of Canada.

CAMVAP services are available in all Canadian territories and provinces. For more information, without charge or obligation, call your CAMVAP Provincial Administrator directly at 1-800-207-0685 or visit www.camvap.ca.

GETTING ASSISTANCE OUTSIDE THE U.S. AND CANADA

Before exporting your vehicle to a foreign country, contact the appropriate foreign embassy or consulate. These officials can inform you of local vehicle registration regulations and where to find unleaded fuel or petrol/gas engines or the proper sulfur fuel for diesel engines.

If you cannot find the proper fuel recommended for your vehicle, contact our Customer Relationship Center.

The use of improper fuels in your vehicle without proper conversion may damage the effectiveness of your emission control system and may cause engine knocking or serious engine damage. Ford Motor Company or Ford of Canada is not responsible for any damage caused by use of improper fuel. Using improper fuels may also result in difficulty importing your vehicle back into the United States.

If your vehicle must be serviced while you are traveling or living in Asia-Pacific Region, Sub-Saharan Africa, U.S. Virgin Islands and/or Puerto Rico, Central America, the Caribbean, and Israel and the Middle East, contact the nearest authorized dealer. If the authorized dealer cannot help you, contact the corresponding Ford Customer Assistance Center:

FORD MOTOR COMPANY
Customer Relationship Centers in:

Customer Assistance

Customer Relationship Center	Phone	Fax	E-mail
Asia Pacific	N/A	N/A	apemcrc@ford.com
Caribbean and Central America	+1-800-841-3673	N/A	atnclien@ford.com
Middle East	Ford 80004443673	971 4 3327 266	menacac@ford.com
	Lincoln 80004441067		
	UAE 80004441066		
	Saudi Arabia 8008443673		
	Mobily and Zain cell phone users in Saudi 800850078		
Kuwait 22280384			
North Africa	N/A	N/A	nafcrc@ford.com
Puerto Rico and U.S. Virgin Islands	+1-800-841-3673	N/A	atnclien@ford.com
Sub-Saharan Africa	N/A	N/A	ssacrc@ford.com
South Korea	+82-02-1600-6003	N/A	infokr1@ford.com or infokr@lincoln.com

If you buy your vehicle in North America and then relocate to any of the above locations, register your vehicle identification number (VIN) and new address with Ford Global Trade Services by emailing, expcso@ford.com.

If you are in another foreign country, contact the nearest authorized dealer. In the event your inquiry is unresolved, communicate your concern with the dealership's Sales Manager, Service Manager or Customer Relations Manager. If you require additional assistance or clarification, please contact the respective Customer Relationship Center as previously listed.

Customers in the U.S. should call 1-800-392-3673.

Customer Assistance

ORDERING ADDITIONAL OWNER'S LITERATURE

To order the publications in this portfolio, contact Helm, Incorporated at:

HELM, INCORPORATED
47911 Halyard Drive
Plymouth, Michigan 48170
Attention: Customer Service

Or to order a free publication catalog, call toll free: 1-800-782-4356

Monday-Friday 8:00 a.m. - 6:00 p.m. EST

Helm, Incorporated can also be reached by their website:

www.helminc.com

(Items in this catalog may be purchased by credit card, check or money order.)

Obtaining a French Owner's Manual

French Owner's Manual can be obtained from your authorized dealer or by contacting Helm, Incorporated using the contact information listed previously in this section.

REPORTING SAFETY DEFECTS (U.S. ONLY)

If you believe that your vehicle has a defect which could cause a crash or could cause injury or death, you should immediately inform the National Highway Traffic Safety Administration (NHTSA) in addition to notifying Ford Motor Company.

If NHTSA receives similar complaints, it may open an investigation, and if it finds that a safety defect exists in a group of vehicles, it may order a recall and remedy campaign. However, NHTSA cannot become involved in individual problems between you, your dealer, or Ford Motor Company.

To contact NHTSA, you may call the Vehicle Safety Hotline toll-free at 1-888-327-4236 (TTY: 1-800-424-9153); go to www.safercar.gov; or write to:

Administrator

1200 New Jersey Avenue,
Southeast

Washington, D.C. 20590

You can also obtain other information about motor vehicle safety from www.safercar.gov.

REPORTING SAFETY DEFECTS (CANADA ONLY)

If you believe that your vehicle has a defect which could cause a crash or could cause injury or death, you should immediately inform Transport Canada and Ford of Canada.

Customer Assistance

Transport Canada Contact Information	
Website	http://www.tc.gc.ca/eng/motorvehiclesafety/reporting-defects-motor-vehicles.html (English)
Website	http://www.tc.gc.ca/fra/securiteautomobile/signaler-defauts-vehicules-automobiles.html (French)
Phone	1-800-333-0510

Ford of Canada Contact Information	
Website	www.ford.ca
Phone	1-800-565-3673

Fuses

FUSE SPECIFICATION CHART

Engine Compartment Fuse Box



WARNING: Always disconnect the battery before servicing high current fuses.



WARNING: To reduce risk of electrical shock, always replace the cover to the power distribution box before reconnecting the battery or refilling fluid reservoirs.

The engine compartment fuse box is in the engine compartment. It has high-current fuses that protect your vehicle's main electrical systems from overloads.

If you disconnect and reconnect the battery, you need to reset some features. See **Changing the 12V Battery** (page 373).

Replace fuses with the same type and rating. See **Changing a Fuse** (page 340).

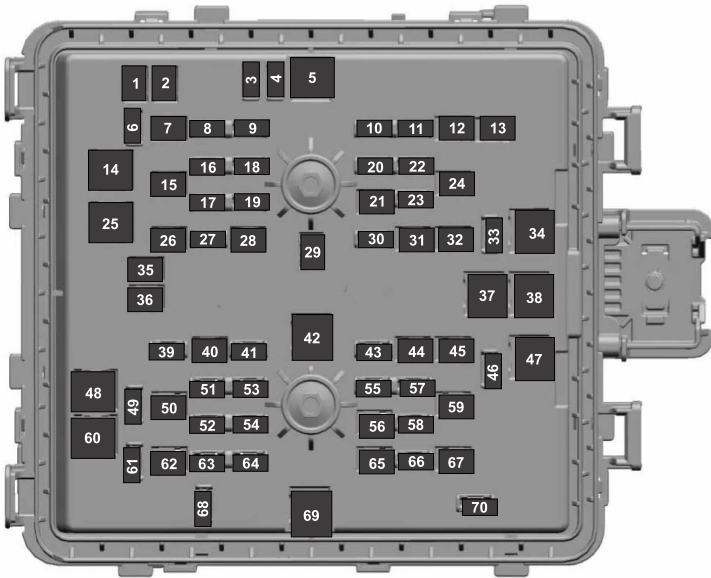

Fuses

Fuse Number	Fuse Rating	Protected Component
1	20 A	Power point 4.
2	20 A	Power point 3.
3	10 A	Spot light module.
4	10 A	Four-wheel drive vacuum solenoid.
5	40 A	Active front steering.
6	10 A	Snow plow.
7	30 A	Trailer tow battery charge.
8	10 A	Anti-lock brake system module.
9	10 A	Electronic power assisted steering module.
10	30 A	Trailer tow park lamps.
11	20 A	Horn.
12	30 A	Torque overlay.
13	30 A	Power sliding rear window.
14	40 A	Body control module - battery power in feed 1.
15	30 A	Passenger seat power.
16	10 A	Powertrain control module. Transmission control module.
17	10 A	Blind spot information system.
18	10 A	Four-wheel drive module.
19	5 A	Adaptive cruise control.
20	15 A	Heated mirrors.
21	40 A	Heated rear window.
22	10 A	On-board diagnostic module. Smart data link connector.
23	15 A	Transmission control module.
24	30 A	Driver power seat.
25	25 A	Voltage quality module.

Fuses

Fuse Number	Fuse Rating	Protected Component
26	30 A	Trailer tow battery charge.
27	20 A	Rear heated seats.
28	25 A	Glow plug (diesel).
	—	Not used (gas).
29	40 A	Electric power assisted steering motor.
30	10 A	Heated wiper park.
31	20 A	Power point 5.
32	25 A	Four-wheel drive module.
33	10 A	Alternator sense line 2.
34	50 A	Electric cooling fan (gas). Supplemental air heater (diesel).
35	20 A	Power point 2.
36	20 A	Power point 1.
37	60 A	Anti-lock brake system pump.
38	60 A	Inverter.
39	25 A	Four-wheel drive module.
40	30 A	Starter motor solenoid.
41	10 A	Tailgate release solenoid.
42	40 A	Blower motor.
43	10 A	Trailer tow backup lamps.
44	40 A	Trailer tow lighting module.
45	30 A	Anti-lock brake system valve.
46	30 A	Compressed natural gas module power.
47	50 A	Supplemental air heater (diesel).
	—	Not used (gas).
48	50 A	Supplemental air heater (diesel).
	—	Not used (gas).

Fuses

Fuse Number	Fuse Rating	Protected Component
49	—	Not used.
50	30 A	Heated and cooled seats.
51	20 A	Powertrain control module.
52	15 A	Compressed natural gas (gas). Fuel rail pressure relief control (diesel).
53	20 A	Exhaust gas recirculation stepper motor (gas). Universal exhaust gas oxygen sensors (gas). Exhaust gas recirculation cooler bypass (diesel). Urea pump motor controller (diesel). Oxygen sensors.
54	20 A	A/C clutch relay power. Fan clutch.
55	5 A	Rain sensor.
56	30 A	Windshield wipers.
57	10 A	Upfitter interface module.
58	10 A	Alternator sense line.
59	30 A	Power running boards.
60	40 A	Body control module - battery power in feed 2.
61	10 A	Telescopic mirror motors.
62	40 A	Trailer brake control. Aftermarket e-brake access.
63	15 A	Multi-contour seats.
64	20 A	Ignition coil (gas). Glow plug module (diesel). Nitrogen oxide module (diesel). Urea level and quality sensor (diesel).
65	30 A	Fuel pump.
66	10 A	A/C clutch solenoid.
67	40 A	Auxiliary lighting module.
68	10 A	Powertrain control module.

Fuses

Fuse Number	Fuse Rating	Protected Component
69	60 A	Body control module power.
70	30 A	Trailer tow stop and turn lamps.

Note: Spare fuse amperage may vary.

Passenger Compartment Fuse Panel

The fuse panel is in the right-hand side of the passenger footwell behind a trim panel. To remove the trim panel, pull it toward you and swing it away from the side. To reinstall it, line up the tabs with the grooves on the panel, and then push it shut.

Note: It may be easier to access the fuse panel if you remove the finish trim piece.

Replace fuses with the same type and rating. See **Changing a Fuse** (page 340).

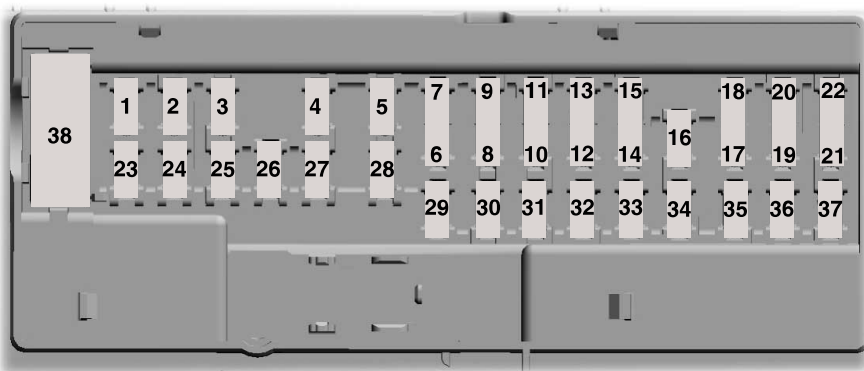

E145984

Fuse Number	Fuse Rating	Protected Component
1	—	Not used.
2	10 A	Driver door pack switch. Power sliding rear window switch.
3	7.5 A	Seat memory switch.

Fuses

Fuse Number	Fuse Rating	Protected Component
		Power lumbar motor. Wireless charging module.
4	—	Not used.
5	—	Not used.
6	10 A	Power telescoping mirrors switch. Front power windows switch.
7	10 A	Brake on-off switch.
8	5 A	Embedded modem.
9	5 A	Combined sensor module.
10	—	Not used.
11	—	Not used.
12	7.5 A	On-board diagnostic module. Smart data link connector. Climate control module.
13	7.5 A	Steering column control module. Instrument cluster.
14	—	Not used.
15	15 A	SYNC. Display.
16	—	Not used.
17	7.5 A	Active front steering module. Park aid module.
18	7.5 A	Selectable drive modes switch. Select shift switch.
19	5 A	Head up display.
20	5 A	Ignition switch. Key inhibit solenoid.
21	5 A	Head up display. In-vehicle temperature and humidity sensor.
22	5 A	Upfitter switches.

Fuses

Fuse Number	Fuse Rating	Protected Component
23	30 A	Driver front door module.
24	30 A	Moonroof.
25	—	Not used.
26	30 A	Passenger front door module.
27	—	Not used.
28	30 A	Amplifier.
29	15 A	Adjustable pedals switch.
30	5 A	Brake on-off output to trailer brake controller and customer access circuits.
31	10 A	Remote keyless entry.
32	20 A	Radio.
33	—	Not used.
34	30 A	Run/start relay.
35	—	Not used.
36	15 A	Camera module. Lane keeping system. Auto-dimming interior mirror. Rear heated seats.
37	20 A	Heated steering wheel.
38	30 A	Power windows.

Note: Spare fuse amperage may vary.

CHANGING A FUSE

Fuses



WARNING: Always replace a fuse with one that has the specified amperage rating. Using a fuse with a higher amperage rating can cause severe wire damage and could start a fire.



E217331

Fuses

If electrical components in the vehicle are not working, a fuse may have blown. Blown fuses are identified by a broken wire within

the fuse. Check the appropriate fuses before replacing any electrical components.

Fuse Types

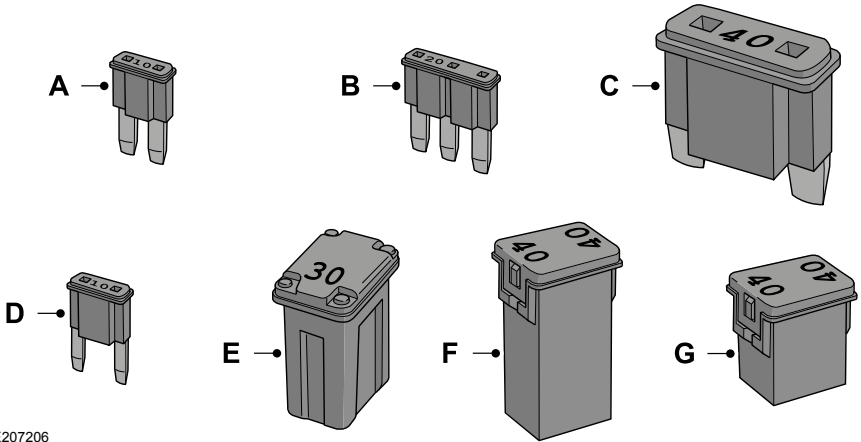

E207206

Callout	Fuse Type
A	Micro 2
B	Micro 3
C	Maxi
D	Mini
E	M Case
F	J Case
G	J Case Low Profile

Maintenance

GENERAL INFORMATION

Have your vehicle serviced regularly to help maintain its roadworthiness and resale value. There is a large network of authorized dealers that are there to help you with their professional servicing expertise. We believe that their specially trained technicians are best qualified to service your vehicle properly and expertly. They are supported by a wide range of highly specialized tools developed specifically for servicing your vehicle.

If your vehicle requires professional service, an authorized dealer can provide the necessary parts and service. Check your warranty information to find out which parts and services are covered.

Use only recommended fuels, lubricants, fluids and service parts conforming to specifications. Motorcraft® parts are designed and built to provide the best performance in your vehicle.

Precautions

- Do not work on a hot engine.
- Make sure that nothing gets caught in moving parts.
- Do not work on a vehicle with the engine running in an enclosed space, unless you are sure you have enough ventilation.
- Keep all open flames and other burning material (such as cigarettes) away from the battery and all fuel related parts.

Working with the Engine Off

1. Set the parking brake and shift the transmission to park (P).
2. Switch off the engine.
3. Block the wheels.

Working with the Engine On



WARNING: To reduce the risk of vehicle damage and personal burn injuries, do not start your engine with the air cleaner removed and do not remove it while the engine is running.

1. Set the parking brake and shift the transmission to park (P).
2. Block the wheels.

OPENING AND CLOSING THE HOOD

1. Inside the vehicle, pull the hood release handle located under the left hand side of the instrument panel.



E166491

2. Go to the front of your vehicle and locate the secondary release lever under the front of the hood near the center of your vehicle.

Maintenance

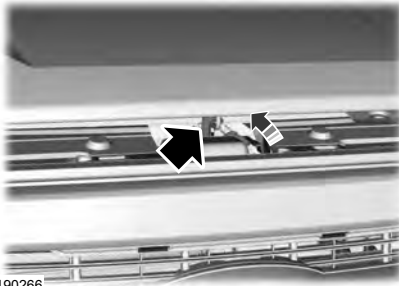

E190266

3. Raise the hood until the lift cylinders hold it open.
4. To close, lower the hood and make sure that it is closed properly and fully latched.

UNDER HOOD OVERVIEW - 6.2L

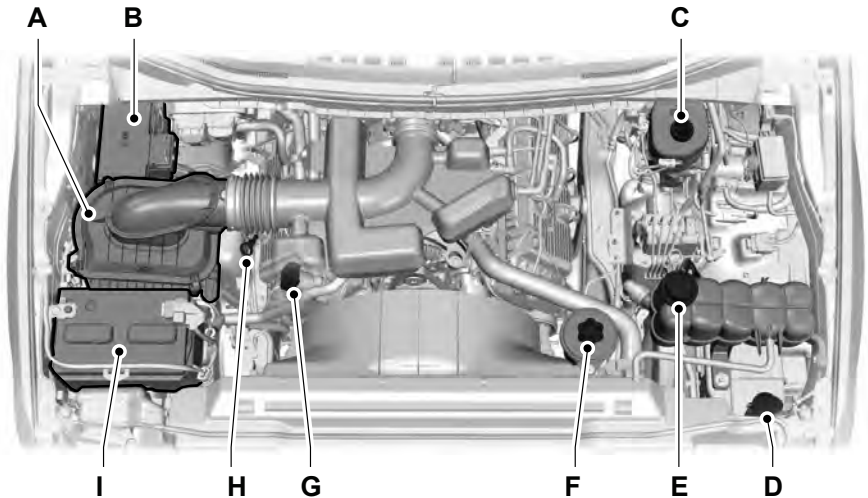

- A. Air filter. See **Changing the Engine Air Filter** (page 351).
- B. Engine compartment fuse box. See **Fuse Specification Chart** (page 334).
- C. Brake fluid reservoir. See **Brake Fluid Check** (page 371).
- D. Windshield washer fluid reservoir. See **Washer Fluid Check** (page 376).
- E. Engine coolant reservoir. See **Engine Coolant Check** (page 358).

Maintenance

- F. Power steering fluid reservoir. See **Power Steering Fluid Check** (page 372).
- G. Engine oil fill cap. See **Engine Oil Check** (page 346).
- H. Engine oil dipstick. See **Engine Oil Dipstick** (page 346).
- I. Battery. See **Changing the 12V Battery** (page 373).

UNDER HOOD OVERVIEW - 6.7L DIESEL

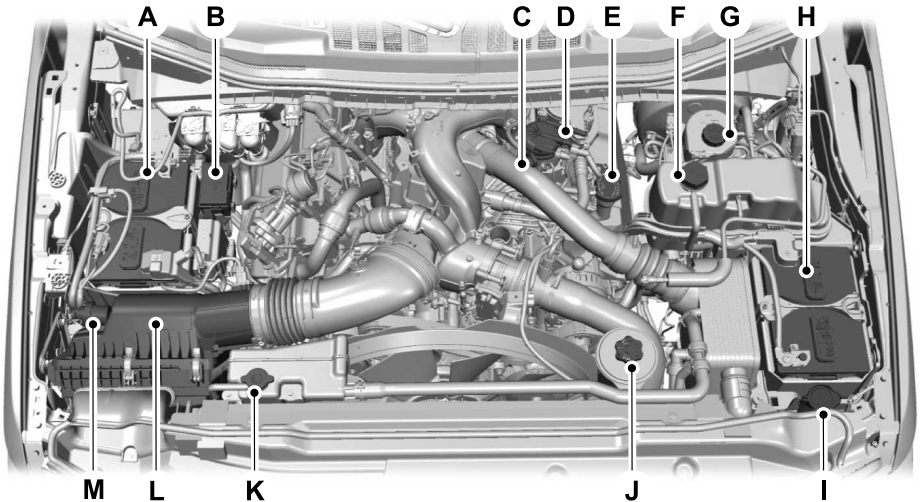

- A. Battery. See **Changing the 12V Battery** (page 373).
- B. Engine compartment fuse box. See **Fuse Specification Chart** (page 334).
- C. Engine oil dipstick. See **Engine Oil Dipstick** (page 346).
- D. Secondary fuel filter. See **Changing the Engine-Mounted and Diesel Fuel Conditioner Module Fuel Filters** (page 380).
- E. Engine oil filler cap. See **Engine Oil Check** (page 347).
- F. Engine cooling system coolant reservoir – primary high-temperature cooling system. See **Engine Coolant Check** (page 358).
- G. Brake fluid reservoir. See **Brake Fluid Check** (page 371).
- H. Battery. See **Changing the 12V Battery** (page 373).

Maintenance

- I Windshield washer fluid reservoir. See **Washer Fluid Check** (page 376).
- J Power steering fluid reservoir. See **Power Steering Fluid Check** (page 372).
- K Secondary cooling system coolant reservoir. See **Engine Coolant Check** (page 358).
- L Air filter assembly. See **Changing the Engine Air Filter** (page 354).
- M Air filter restriction gauge. See **Changing the Engine Air Filter** (page 354).

UNDER HOOD OVERVIEW - 7.3L

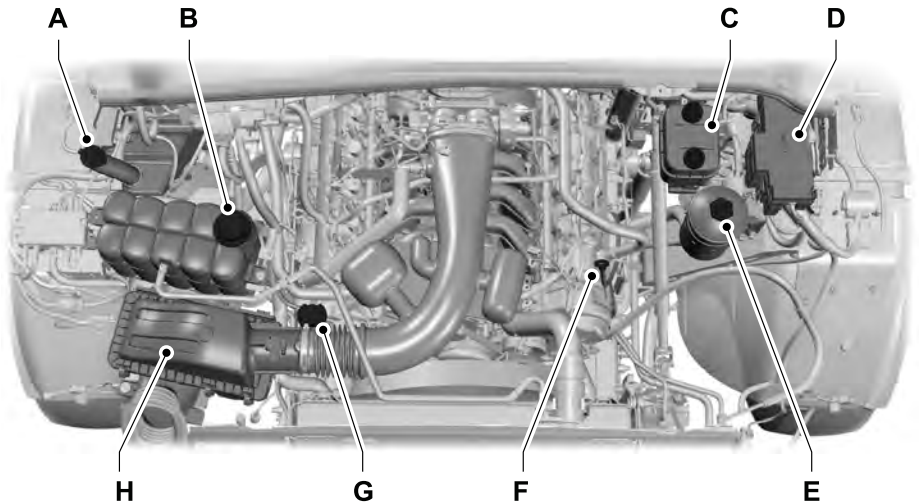

- A. Windshield washer fluid reservoir. See **Washer Fluid Check** (page 376).
- B. Engine coolant reservoir. See **Engine Coolant Check** (page 365).
- C. Brake fluid reservoir. See **Brake Fluid Check** (page 371).
- D. Engine compartment fuse box. See **Fuses** (page 334).
- E. Power steering fluid reservoir. See **Power Steering Fluid Check** (page 372).
- F. Engine oil dipstick. See **Engine Oil Dipstick** (page 346).
- G. Engine oil filler cap. See **Engine Oil Check** (page 348).
- H. Air cleaner assembly. See **Changing the Engine Air Filter** (page 354).

Maintenance

ENGINE OIL DIPSTICK - 6.2L



E161560

- A MIN
- B MAX

ENGINE OIL DIPSTICK - 7.3L

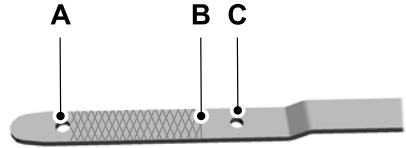

E250320

- A Minimum.
- B Nominal.
- C Maximum.

ENGINE OIL DIPSTICK - 6.7L DIESEL

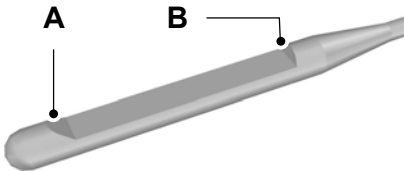

E71362

- A Minimum.
- B Maximum.

ENGINE OIL CHECK - 6.2L

To check the engine oil level consistently and accurately, do the following:

1. Make sure that your vehicle is on level ground.
2. Run engine until it reaches normal operating temperature.
3. Make sure the parking brake is on. Make sure the transmission is in park (P) or neutral (N).
4. Switch the engine off and wait 15 minutes for the oil to drain into the oil pan. Checking the engine oil level too soon after you switch the engine off may result in an inaccurate reading.
5. Open the hood. See **Opening and Closing the Hood** (page 342).
6. Remove the dipstick and wipe it with a clean, lint-free cloth. For 6.2L V8 See **Under Hood Overview** (page 343).

Maintenance

7. Replace the dipstick and remove it again to check the oil level. See **Engine Oil Dipstick** (page 346).
8. Make sure that the oil level is between the maximum and minimum marks. If the oil level is at the minimum mark, add oil immediately. See **Capacities and Specifications** (page 433).
9. If the oil level is correct, replace the dipstick and make sure it is fully seated.

Note: Do not remove the dipstick when the engine is running.

Note: If the oil level is between the maximum and minimum marks, the oil level is acceptable. Do not add oil.

Note: The oil consumption of new engines reaches its normal level after approximately 3,000 mi (5,000 km).

Adding Engine Oil



WARNING: Do not remove the filler cap when the engine is running.

Do not use supplemental engine oil additives because they are unnecessary and could lead to engine damage that may not be covered by the vehicle Warranty.



E142732

Only use oils certified for gasoline engines by the American Petroleum Institute (API). An oil with this trademark symbol conforms to the current engine and emission system protection standards and fuel economy requirements of the International Lubricants Specification Advisory Committee (ILSAC).

To top up the engine oil level do the following:

1. Clean the area surrounding the engine oil filler cap before you remove it.
2. Remove the engine oil filler cap. For 6.2L V8 See **Under Hood Overview** (page 343).
3. Only add engine oil that meets our specifications. See **Capacities and Specifications** (page 433).
4. Recheck the oil level.
5. If the oil level is correct, replace the dipstick and make sure it is fully seated.
6. Replace the engine oil filler cap. Turn it clockwise until you feel a strong resistance.

Note: Do not add oil further than the maximum mark. Oil levels above the maximum mark may cause engine damage.

Note: Make sure you install the oil filler cap correctly.

Note: Soak up any spillage with an absorbent cloth immediately.

ENGINE OIL CHECK - 6.7L DIESEL

To check the engine oil level consistently and accurately, do the following:

1. Make sure the parking brake is on. Make sure the transmission is in park (P) or neutral (N).
2. Run engine until it reaches normal operating temperature.

Maintenance

3. Make sure that your vehicle is on level ground.
4. Switch the engine off and wait 15 minutes for the oil to drain into the oil pan. Checking the engine oil level too soon after you switch the engine off may result in an inaccurate reading.
5. Open the hood. See **Opening and Closing the Hood** (page 342).
6. Remove the dipstick and wipe it with a clean, lint-free cloth. See **Under Hood Overview** (page 344).
7. Replace the dipstick and remove it again to check the oil level. See **Engine Oil Dipstick** (page 346).
8. Make sure that the oil level is between the maximum and minimum marks. If the oil level is at the minimum mark, add oil immediately. See **Capacities and Specifications** (page 450).
9. If the oil level is correct, replace the dipstick and make sure it is fully seated.

Note: Do not remove the dipstick when the engine is running.

Note: If the oil level is between the maximum and minimum marks, the oil level is acceptable. Do not add oil.

Note: The oil consumption of new engines reaches its normal level after approximately 3,000 mi (5,000 km).

Adding Engine Oil



WARNING: Do not remove the filler cap when the engine is running.

Do not use supplemental engine oil additives because they are unnecessary and could lead to engine damage that may not be covered by the vehicle Warranty.

To top up the engine oil level do the following:

1. Clean the area surrounding the engine oil filler cap before you remove it.
2. Remove the engine oil filler cap. See **Under Hood Overview** (page 344). Turn it counterclockwise and remove it.
3. Add engine oil of the proper viscosity and grade that meets Ford specifications. See **Capacities and Specifications** (page 450). You may have to use a funnel to pour the engine oil into the opening.
4. Recheck the oil level.
5. If the oil level is correct, replace the dipstick and make sure it is fully seated.
6. Replace the engine oil filler cap. Turn it clockwise until you feel a strong resistance.

Note: Do not add oil further than the maximum mark. Oil levels above the maximum mark may cause engine damage.

Note: Make sure you install the oil filler cap correctly.

Note: Soak up any spillage with an absorbent cloth immediately.

Engine lubrication for severe service operation

The following conditions define severe operation for which engine operation with SAE 5W-40 oil which meets Ford specification, WSS-M2C171-F1, is recommended. Oil and oil filter change intervals will be determined by the Intelligent Oil Life Monitor™ as noted previously.

ENGINE OIL CHECK - 7.3L

To check the engine oil level consistently and accurately, do the following:

Maintenance

1. Make sure the parking brake is on. Make sure the transmission is in park (P) or neutral (N).
2. Run the engine until it reaches normal operating temperature.
3. Make sure that your vehicle is on level ground.
4. Switch the engine off and wait 15 minutes for the oil to drain into the oil pan. Checking the engine oil level too soon after you switch the engine off may result in an inaccurate reading.
5. Open the hood. See **Maintenance** (page 342).
6. Remove the dipstick and wipe it with a clean, lint-free cloth. See **Maintenance** (page 342).
7. Replace the dipstick and remove it again to check the oil level. See **Maintenance** (page 342).
8. Make sure that the oil level is between the maximum and minimum marks. If the oil level is at the minimum mark, add oil immediately. See **Capacities and Specifications** (page 433).
9. If the oil level is correct, replace the dipstick and make sure it is fully seated.

Note: Do not remove the dipstick when the engine is running.

Note: If the oil level is between the maximum and minimum marks, the oil level is acceptable. Do not add oil.

Note: The oil consumption of new engines reaches its normal level after approximately 3,000 mi (5,000 km).

Adding Engine Oil



WARNING: Do not remove the filler cap when the engine is running.

Do not use supplemental engine oil additives because they are unnecessary and could lead to engine damage that may not be covered by the vehicle Warranty.



E142732

Only use oils certified for gasoline engines by the American Petroleum Institute (API). An oil with this trademark symbol conforms to the current engine and emission system protection standards and fuel economy requirements of the International Lubricants Specification Advisory Committee (ILSAC).

To top up the engine oil level do the following:

1. Clean the area surrounding the engine oil filler cap before you remove it.
2. Remove the engine oil filler cap.
3. Add engine oil that meets the correct specification.
4. Recheck the oil level.
5. If the oil level is correct, replace the dipstick and make sure it is fully seated.
6. Replace the engine oil filler cap. Turn it clockwise until you feel a strong resistance.

Note: Do not add oil further than the maximum mark. Oil levels above the maximum mark may cause engine damage.

Note: Make sure you install the oil filler cap correctly.

Maintenance

Note: Soak up any spillage with an absorbent cloth immediately.

CHANGING THE ENGINE OIL AND OIL FILTER



WARNING: Do not handle a hot oil filter with bare hands.



WARNING: Continuous contact with used motor oil has caused cancer in laboratory mice. Protect your skin by washing with soap and water.

If your vehicle is equipped with a diesel engine, an Intelligent Oil Life Monitor™ calculates the proper oil change service interval. When the information display indicates: OIL CHANGE REQUIRED, change the engine oil and oil filter. See **Information Displays** (page 112).

The engine oil filter protects your engine by filtering harmful, abrasive or sludge particles and particles significantly smaller than most available will-fit filters. See **Motorcraft Parts** (page 435).

1. Unscrew the oil filter and oil pan drain plug and wait for the oil to drain.
2. Replace the filter.
3. Reinstall the oil pan drain plug.
4. Refill the engine with new oil. See **Engine Specifications** (page 433).
5. For diesel engines, you need to reset the Intelligent Oil Life Monitor™. See **Information Displays** (page 112).

Engine lubrication for severe service operation

The following conditions define severe operation for which engine operation with SAE 5W-40 API CJ-4 is recommended. Oil and oil filter change intervals will be determined by the Intelligent Oil Life Monitor™ as noted previously.

- Frequent or extended idling (over 10 minutes per hour of normal driving).
- Low-speed operation/stationary use.
- If vehicle is operated in sustained ambient temperatures below -9°F (-23°C) or above 100°F (38°C).
- Frequent low-speed operation, consistent heavy traffic less than 25 mph (40 km/h).
- Operating in severe dust conditions.
- Operating the vehicle off road.
- Towing a trailer over 1,000 mi (1,600 km).
- Sustained, high-speed driving at Gross Vehicle Weight Rating (maximum loaded weight for vehicle operation).
- Use of fuels with sulfur content other than ultra-low sulfur diesel (ULSD).
- Use of high-sulfur diesel fuel.

OIL CHANGE INDICATOR RESET

Use the information display controls on the steering wheel to reset the oil change indicator.

Maintenance

From the main menu scroll to:

Message	Action and description
Truck Info	Press the down arrow button, then from this menu scroll to the following message.
Maintenance Monitor	Press the OK button.
Oil Life: xxx%	Press the down arrow button, then from this menu scroll to the following message.
Oil Life	Press the OK button.
Oil Life Hold OK to Reset	Press and hold the OK button until the instrument cluster displays the following message. Oil Life: 100% When the oil change indicator resets the instrument cluster displays 100%. Repeat the process if the oil change indicator does not reset.

CHANGING THE ENGINE AIR FILTER - 6.2L



WARNING: To reduce the risk of vehicle damage and personal burn injuries, do not start your engine with the air cleaner removed and do not remove it while the engine is running.

Use the correct specification air filter element. See **Motorcraft Parts** (page 435).

Note: Failure to use the correct air filter element may result in severe engine damage. Resulting component damage may not be covered by the vehicle Warranty.

Change the air filter element at the correct service interval. See **Scheduled Maintenance** (page 557).

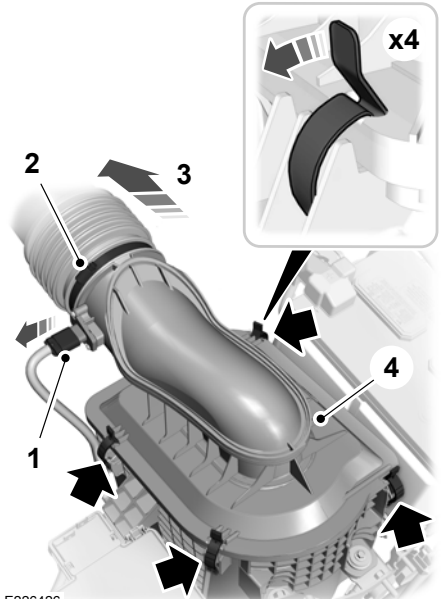

E226426

1. Disconnect the mass air flow sensor electrical connector, if required.
2. Remove the air intake tube securing clamp.
3. Pull the air intake tube away from the air filter housing.
4. Remove the clips that secure the air filter housing cover. Remove the air filter housing cover.

Maintenance

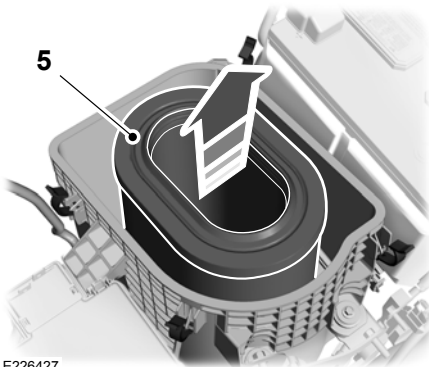

E226427

5. Remove the air filter element from the air filter housing.
6. Install in the reverse order.

CHANGING THE ENGINE AIR FILTER - 6.7L DIESEL



WARNING: To reduce the risk of vehicle damage and personal burn injuries, do not start your engine with the air cleaner removed and do not remove it while the engine is running.

Use the correct specification air filter element. See **Motorcraft Parts** (page 438).

Note: Failure to use the correct air filter element may result in severe engine damage. Resulting component damage may not be covered by the vehicle Warranty.

Change the air filter element at the correct service interval. See **Scheduled Maintenance** (page 557).

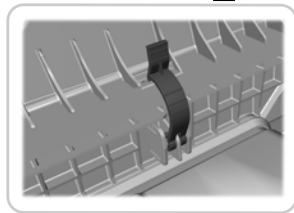
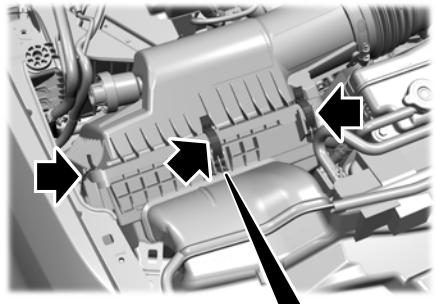

1. Disconnect the mass air flow sensor electrical connector, if required.
2. Remove the clips (x3) that secure the air filter housing cover. Remove the air filter housing cover. Disconnect and pull the air intake tube away, as needed.

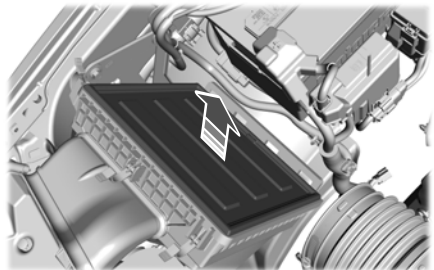

3. Remove the air filter element from the air filter housing.

Maintenance

4. Remove the auxiliary foam filter from the air filter housing.
5. To install, reverse the removal procedure. The housing cover can be oscillated slightly left to right to assist with installation as needed, until positioned such that all three clips can be re-engaged.

Air Filter Restriction Gauge

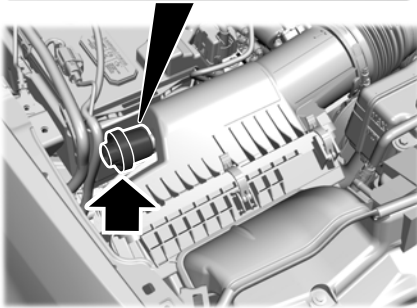
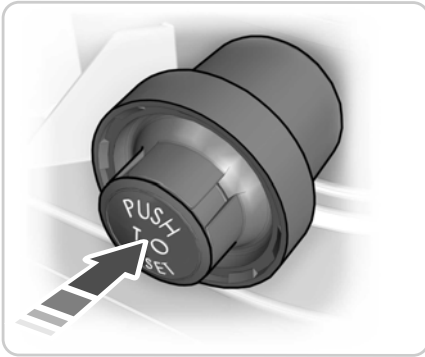

The air filter restriction gauge is in the upper housing of the air filter assembly.

Check the air filter restriction gauge whenever you open the hood to carry out general engine maintenance or at least every 7,500 mi (12,000 km). If you operate your vehicle in extremely dusty conditions, check the gauge at least every 500 mi (800 km) or two weeks, whichever occurs first. Change the air filter element when the restriction gauge reads near the **change filter** line and the gauge is yellow. Allowing the restriction gauge to reach maximum affects engine performance and fuel economy.

Operating your vehicle in heavy snowfall or extreme rain conditions may allow excessive amounts of snow or water into the air intake system. This could restrict air flow and cause the engine to lose power or shut down.

After installing a new air filter element, you must reset the gauge by pressing the reset button.

After operating your vehicle during heavy snowfall or extreme rain, do the following:

- Snow: At the earliest opportunity, open the hood and clear any snow and ice from the air filter housing inlet and reset the air filter restriction gauge.
- Extreme rain: The air filter element dries out after approximately 15–30 minutes of driving at highway speeds. At the earliest opportunity, open the hood and reset the air filter restriction gauge.

Note: Do not remove the foam filter.

Maintenance

CHANGING THE ENGINE AIR FILTER - 7.3L



WARNING: To reduce the risk of vehicle damage and personal burn injuries, do not start your engine with the air cleaner removed and do not remove it while the engine is running.

Note: Operating your vehicle in heavy snowfall or extreme rain conditions may allow excessive amounts of snow or water into the air intake system. This could plug or soak the air filter that could cause the engine to lose power or shut down.

When replacing the air filter element, use a Motorcraft® air filter element. See **Motorcraft Parts** (page 438).

Note: Failure to use the correct air filter element may result in severe engine damage. Resulting component damage may not be covered by the vehicle Warranty.

Change the air filter element at the correct interval. See **Scheduled Maintenance** (page 557).

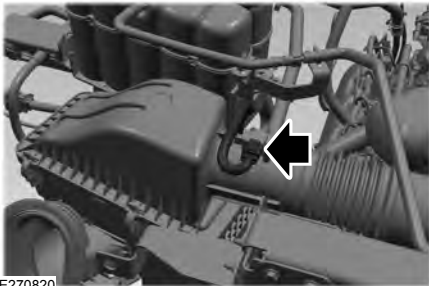

1. Locate the mass air flow sensor electrical connector on the air outlet tube. Disconnect the mass air flow sensor electrical connector.

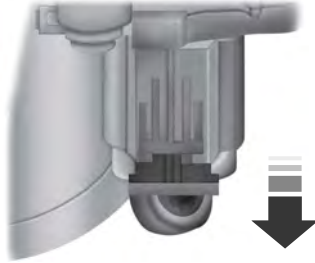

2. Reposition the locking clip on the connector, squeeze the connector and pull it off of the air outlet tube.

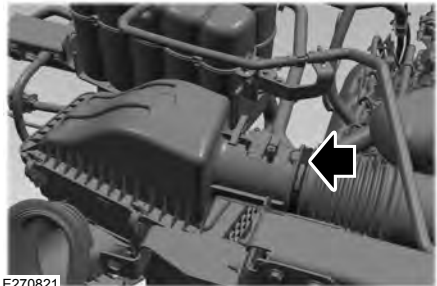

3. Clean the area from around the air tube to the air cover connection to prevent debris from entering the system. Next, loosen the bolt on the air tube clamp so the clamp is no longer snug to the air tube. It is not necessary to completely remove the clamp.
4. Pull the air tube off from the air cleaner housing.

Maintenance

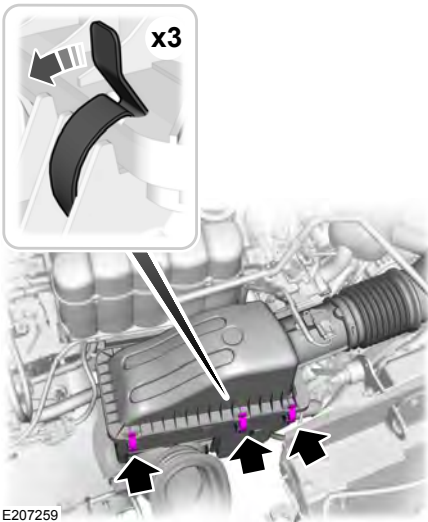

5. Remove the clips that secure the air filter housing cover. Push the air filter cover toward the center of the vehicle and up slightly to release it.
6. Remove the air filter element from the air filter housing.
7. Install the new air filter element.
8. Engage the clips to secure the air filter housing cover to the air filter housing. Be careful not to crimp the filter element edges between the air filter housing and cover. Ensure that you align the tabs on the edge properly into the slots.
9. Slip the air tube onto the air filter housing and tighten the air-tube clamp bolt snugly. Do not over tighten air-tube clamp bolt.

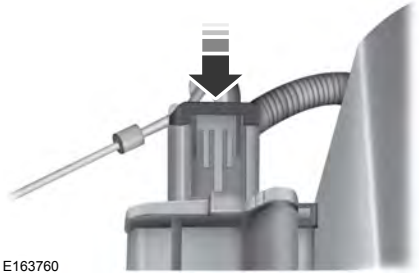

10. Reconnect the mass air flow sensor electrical connector to the outlet tube. Make sure the locking tab on the connector is in the locked position.

DRAINING THE FUEL FILTER WATER TRAP - 6.7L DIESEL

 **WARNING:** Do not dispose of fuel in the household refuse or the public sewage system. Use an authorized waste disposal facility.

Your vehicle has a diesel fuel conditioner module. The module is mounted between the outboard side of the fuel tank and the frame rail.

Note: *The module is at the front of the fuel tank or at the front of the aft-axle fuel tank on some models.*

Maintenance



You should drain water from the module assembly whenever the warning light illuminates or a message appears in the information display advising you to drain the water separator. This occurs when approximately 6.76 fl oz (200 ml) of water accumulates in the module. If you allow the water level

to exceed this level, the water may pass through to the engine and may cause fuel injection equipment damage.

Filter Location

Use the tables below to find the location of your filter.

Pick-up Truck

Cab Type	Box Length	Filter Location
Regular.	8 ft (2.4 m)	Left side of fuel tank.
SuperCab.	6.75 ft (2.057 m)	
	8 ft (2.4 m)	In front of fuel tank.
Super Crew Cab.	6.75 ft (2.057 m)	
	8 ft (2.4 m)	Left side of fuel tank.

Chassis Cab

Cab Type	Fuel Tank Type	Filter Location
Chassis Cab.	Single midship fuel tank	Right side of fuel tank.
Chassis Cab.	Aft axle/midship fuel tanks	Right side of midship fuel tank.
Chassis Cab.	Single aft axle fuel tank	Front of fuel tank.

Draining the Diesel Fuel Conditioner Module

1. Switch the engine off.
2. Access the underside of your vehicle.

Maintenance

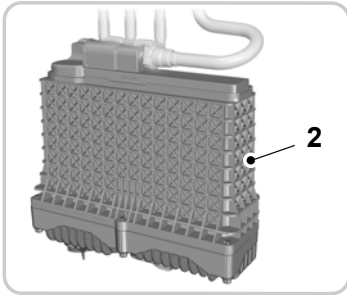
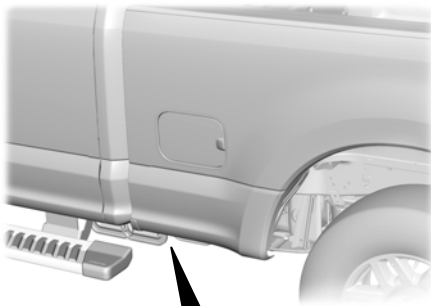

E226475

3. Use the table to find the location of your fuel filter.

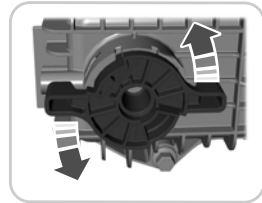
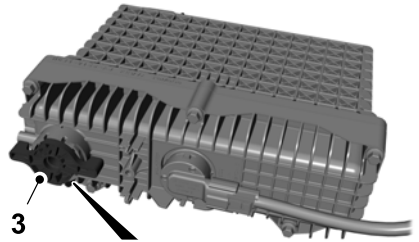

E269861

4. Drain the diesel fuel conditioner module. Turn the drain plug counterclockwise until it stops. Do not use any tools to loosen the drain plug. Drain the filter, approximately 0.5 gal (2 L), into an appropriate container. Do not re-use the fuel drained from the module.
5. Tighten the drain plug, turn it clockwise until it stops and you feel a strong resistance. Do not use any tools to tighten the drain plug.
6. Prime the system by turning the key to the on position for 30 seconds. Turn the key to the off position, then the on position again for another 30 seconds. Repeat this twice.

Maintenance

ENGINE COOLANT CHECK - 6.2L



WARNING: Do not remove the coolant reservoir cap when the engine is on or the cooling system is hot. Wait 10 minutes for the cooling system to cool down. Cover the coolant reservoir cap with a thick cloth to prevent the possibility of scalding and slowly remove the cap. Failure to follow this instruction could result in personal injury.



WARNING: Do not put coolant in the windshield washer reservoir. If sprayed on the windshield, coolant could make it difficult to see through the windshield.



WARNING: To reduce the risk of personal injury, make sure the engine is cool before unscrewing the coolant pressure relief cap. The cooling system is under pressure. Steam and hot liquid can come out forcefully when you loosen the cap slightly.



WARNING: Do not add coolant further than the **MAX** mark.

When the engine is cold, check the concentration and level of the coolant at the intervals listed in the scheduled maintenance information. See **Scheduled Maintenance** (page 557).

Note: Make sure that the coolant level is between the **MIN** and the **MAX** marks on the coolant reservoir.

Note: Coolant expands when it is hot. The level may extend beyond the **MAX** mark.

Maintain coolant concentration within 48% to 50%, which equates to a freeze point between -30°F (-34°C) and -34°F (-37°C). Coolant concentration should be checked using a refractometer. We recommend Robinair® Coolant and Battery Refractometer 75240 (Rotunda tool part number: ROB75240). We do not recommend the use of hydrometers or coolant test strips for measuring coolant concentration.

Note: Automotive fluids are not interchangeable. Do not use coolant or windshield washer fluid outside of its specified function and vehicle location.

Note: Do not use stop leak pellets, cooling system sealants, or additives as they can cause damage to the engine cooling or heating systems. Resulting component damage may not be covered by the vehicle Warranty.

Adding Coolant



WARNING: Do not remove the coolant reservoir cap when the engine is on or the cooling system is hot. Wait 10 minutes for the cooling system to cool down. Cover the coolant reservoir cap with a thick cloth to prevent the possibility of scalding and slowly remove the cap. Failure to follow this instruction could result in personal injury.

It is very important to use prediluted coolant meeting the correct specification in order to avoid plugging the small passageways in the engine cooling system. See **Capacities and Specifications** (page 441). Incorrect prediluted coolant use can cause damage not covered by the vehicle Warranty.

If the coolant level is at or below the minimum mark, add prediluted coolant immediately.

Maintenance

To top up the coolant level do the following:

1. Unscrew the cap slowly. Any pressure escapes as you unscrew the cap.
2. Add prediluted coolant meeting the correct specification. See **Scheduled Maintenance** (page 557).
3. Add enough prediluted coolant to reach the correct level.
4. Replace the coolant reservoir cap. Turn the cap clockwise until it contacts the hard stop.
5. Check the coolant level in the coolant reservoir the next few times you drive your vehicle.

Do not mix different colors or types of prediluted coolant in your vehicle. Mixing of prediluted coolant or using an incorrect prediluted coolant may harm the engine or cooling system components and may not be covered by the vehicle Warranty.

If you have to add more than 1.1 qt (1 L) of engine coolant per month, have your vehicle checked as soon as possible. Operating an engine with a low level of coolant can result in engine overheating and possible engine damage.

In case of emergency, you can add a large amount of water without prediluted coolant in order to reach a vehicle service location. On arrival do the following:

1. Drain the cooling system.
2. Chemically clean the cooling system. We recommend Motorcraft Premium Cooling System Flush.
3. Refill with prediluted coolant as soon as possible.

Water alone, without prediluted coolant, can cause engine damage from corrosion, overheating or freezing.

Do not use the following as a coolant substitute:

- Alcohol.
- Methanol.
- Brine.
- Any coolant mixed with alcohol or methanol antifreeze.

Alcohol and other liquids can cause engine damage from overheating or freezing.

Do not add extra inhibitors or additives to the coolant. These can be harmful and compromise the corrosion protection of the coolant.

Recycled Coolant

We do not recommend the use of recycled coolant as an approved recycling process is not yet available.

Dispose of used engine coolant in an appropriate manner. Follow your community's regulations and standards for recycling and disposing of automotive fluids.

Severe Climates

If you drive in extremely cold climates:

- It may be necessary to increase the coolant concentration above 50%.
- A coolant concentration of 60% provides improved freeze point protection. Coolant concentrations above 60% decrease the overheat protection characteristics of the coolant and may cause engine damage.

Maintenance

If you drive in extremely hot climates:

- It may be necessary to decrease the coolant concentration to 40%.
- A coolant concentration of 40% provides improved overheat protection. Coolant concentrations below 40% decrease the freeze and corrosion protection characteristics of the coolant and may cause engine damage.

Vehicles driven year-round in non-extreme climates should use prediluted coolant for optimum cooling system and engine protection.

Fail-Safe Cooling

Fail-safe cooling allows you to temporarily drive your vehicle before any incremental component damage occurs. The fail-safe distance depends on ambient temperature, vehicle load and terrain.

How Fail-Safe Cooling Works

If the engine begins to overheat, the coolant temperature gauge moves toward the red zone:



A warning lamp illuminates and a message may appear in the information display.



If the engine reaches a preset over-temperature condition, the engine automatically switches to alternating cylinder operation. Each disabled cylinder acts as an air pump and cools the engine.

When this occurs, your vehicle still operates, however:

- Engine power is limited.
- The air conditioning system turns off.

Continued operation increases the engine temperature, causing the engine to completely shut down. Your steering and braking effort increases in this situation.

When the engine temperature cools, you can re-start the engine. Have your vehicle checked as soon as possible to minimize engine damage.

When Fail-Safe Mode Is Activated



WARNING: Fail-safe mode is for use during emergencies only. Operate your vehicle in fail-safe mode only as long as necessary to bring your vehicle to rest in a safe location and seek immediate repairs. When in fail-safe mode, your vehicle will have limited power, will not be able to maintain high-speed operation, and may completely shut down without warning, potentially losing engine power, power steering assist, and power brake assist, which may increase the possibility of a crash resulting in serious injury.



WARNING: Do not remove the coolant reservoir cap when the engine is on or the cooling system is hot. Wait 10 minutes for the cooling system to cool down. Cover the coolant reservoir cap with a thick cloth to prevent the possibility of scalding and slowly remove the cap. Failure to follow this instruction could result in personal injury.

Your vehicle has limited engine power when in the fail-safe mode, drive your vehicle with caution. Your vehicle does not maintain high-speed operation and the engine may operate poorly.

Remember that the engine is capable of automatically shutting down to prevent engine damage. In this situation:

1. Pull off the road as soon as safely possible and switch the engine off.

Maintenance

2. If you are a member of a roadside assistance program, we recommend that you contact your roadside assistance service provider.
3. If this is not possible, wait a short period for the engine to cool.
4. Check the coolant level. If the coolant level is at or below the minimum mark, add prediluted coolant immediately.
5. When the engine temperature cools, you can re-start the engine. Have your vehicle checked as soon as possible to minimize engine damage.

Note: *Driving your vehicle without repair increases the chance of engine damage.*

Engine Coolant Temperature Management (If Equipped)



WARNING: To reduce the risk of crash and injury, be prepared that the vehicle speed may reduce and the vehicle may not be able to accelerate with full power until the coolant temperature reduces.

If you tow a trailer with your vehicle, the engine may temporarily reach a higher temperature during severe operating conditions, for example ascending a long or steep grade in high ambient temperatures.

At this time, you may notice the coolant temperature gauge moves toward the red zone and a message may appear in the information display.

You may notice a reduction in vehicle speed caused by reduced engine power in order to manage the engine coolant temperature. Your vehicle may enter this mode if certain high-temperature and high-load conditions take place. The amount of speed reduction depends on vehicle loading, grade and ambient temperature. If this occurs, there is no need to pull off the road. You can continue to drive your vehicle.

The air conditioning may automatically turn on and off during severe operating conditions to protect the engine from overheating. When the coolant temperature decreases to the normal operating temperature, the air conditioning turns on.

If the coolant temperature gauge moves fully into the red zone, or if the coolant temperature warning or service engine soon messages appear in your information display, do the following:

1. Pull off the road as soon as safely possible and shift the transmission into park (P).
2. Leave the engine running until the coolant temperature gauge needle returns to the normal position. After several minutes, if the temperature does not drop, follow the remaining steps.
3. Switch the engine off and wait for it to cool. Check the coolant level.
4. If the coolant level is at or below the minimum mark, add prediluted coolant immediately.
5. If the coolant level is normal, restart the engine and continue.

Maintenance

ENGINE COOLANT CHECK - 6.7L DIESEL



WARNING: Do not remove the coolant reservoir cap when the engine is on or the cooling system is hot. Wait 10 minutes for the cooling system to cool down. Cover the coolant reservoir cap with a thick cloth to prevent the possibility of scalding and slowly remove the cap. Failure to follow this instruction could result in personal injury.



WARNING: Do not put coolant in the windshield washer reservoir. If sprayed on the windshield, coolant could make it difficult to see through the windshield.



WARNING: To reduce the risk of personal injury, make sure the engine is cool before unscrewing the coolant pressure relief cap. The cooling system is under pressure. Steam and hot liquid can come out forcefully when you loosen the cap slightly.



WARNING: Do not add coolant further than the **MAX** mark.

When the engine is cold, check the concentration and level of the coolant at the intervals listed in the scheduled maintenance information. See **Scheduled Maintenance** (page 557).

Note: Make sure that the coolant level is between the **MIN** and **MAX** marks on the coolant reservoir.

Note: Coolant expands when it is hot. The level may extend beyond the **MAX** mark.

Maintain coolant concentration within 48% to 50%, which equates to a freeze point between -30°F (-34°C) and -34°F (-37°C). Check the coolant concentration using a refractometer. We do not recommend the use of hydrometers or coolant test strips for measuring coolant concentration.

Adding Coolant



WARNING: Do not add engine coolant when the engine is on or the cooling system is hot. Failure to follow this instruction could result in personal injury.



WARNING: Do not remove the coolant reservoir cap when the engine is on or the cooling system is hot. Wait 10 minutes for the cooling system to cool down. Cover the coolant reservoir cap with a thick cloth to prevent the possibility of scalding and slowly remove the cap. Failure to follow this instruction could result in personal injury.

Note: Automotive fluids are not interchangeable. Do not use coolant or windshield washer fluid outside of its specified function and vehicle location.

Note: Do not use stop leak pellets, cooling system sealants, or additives as they can cause damage to the engine cooling or heating systems. Resulting component damage may not be covered by the vehicle Warranty.

Maintenance

It is very important to use prediluted coolant approved to the correct specification to avoid plugging the small passageways in the engine cooling system. See **Capacities and Specifications** (page 450). Do not mix different colors or types of coolant in your vehicle. Mixing of engine coolants or using an incorrect coolant may harm the engine or cooling system components and may not be covered by the vehicle Warranty.

Note: *Coolants marketed for all makes and models may not be approved to our specifications and may cause damage to the cooling system. Resulting component damage may not be covered by the vehicle Warranty.*

If the coolant level is at or below the minimum mark, immediately add prediluted coolant.

For vehicles with overflow coolant systems with a non-pressurized cap on the coolant recovery system, add coolant to the coolant recovery reservoir when the engine is cool. Add prediluted coolant to the maximum level. For all vehicles which have a coolant degas system with a pressurized cap, or if it is necessary to remove the coolant pressure relief cap on the radiator, follow these steps to add engine coolant:

1. Turn the engine off and let it cool.
2. Slowly unscrew the cap. Any pressure escapes as you unscrew the cap.
3. Slowly fill the coolant reservoir with prediluted engine coolant to within the minimum and maximum range on the engine coolant reservoir. If you removed the radiator cap in an overflow system, fill the radiator until the coolant is visible and the radiator is almost full. If you add coolant to bring the level within the minimum and maximum range when the engine is not cold, the system may remain under filled.

4. Replace the coolant reservoir cap. Turn the cap clockwise until it contacts the hard stop.
5. Check the coolant level in the coolant reservoir the next few times you drive your vehicle. If necessary, add enough prediluted engine coolant to bring the coolant level to the proper level.

Note: *If prediluted coolant is not available, use the approved antifreeze concentrate diluting it to 50/50 with distilled water. See **Capacities and Specifications** (page 450). Using water that has not been deionized may contribute to deposit formation, corrosion or plugging of the small cooling system passageways.*

If you have to add more than 1.1 qt (1 L) of engine coolant per month, have your vehicle checked as soon as possible. Operating an engine with a low level of coolant can result in engine overheating and possible engine damage.

In case of emergency, you can add a large amount of water without prediluted coolant in order to reach a vehicle service location. On arrival do the following:

1. Drain the cooling system.
2. Chemically clean the cooling system. We recommend Motorcraft Premium Cooling System Flush.
3. Refill with prediluted coolant as soon as possible.

Water alone, without prediluted coolant, can cause engine damage from corrosion, overheating or freezing.

Do not use the following as a coolant substitute:

- Alcohol.
- Methanol.
- Brine.
- Any coolant mixed with alcohol or methanol antifreeze.

Maintenance

Alcohol and other liquids can cause engine damage from overheating or freezing.

Do not add extra inhibitors or non-specified additives to the coolant. These can be harmful and compromise the corrosion protection of the coolant.

Engine and Secondary Cooling System Refill Procedure

Perform this procedure when refilling the engine or secondary cooling systems after it has been drained or become extremely low:

1. Before you remove the cap, turn the engine off and let it cool.
2. When the engine is cool, wrap a thick cloth around the cap. Slowly turn cap counterclockwise until pressure begins to release.
3. Step back when the pressure releases.
4. When you are sure that all the pressure has been released, use the cloth to turn the cap counterclockwise and then remove it.
5. Slowly add prediluted engine coolant to the coolant reservoir until the coolant level is within the minimum and maximum range as listed on the reservoir.
6. Reinstall the pressure relief cap.
7. Start and run the engine at 2000 rpm for 2 minutes.
8. Shut the engine off, and remove the pressure relief cap as previously outlined.
9. If required, add prediluted engine coolant to the coolant reservoir until the coolant level is within the minimum and maximum range as listed on the reservoir.
10. Engine cooling system: Repeat steps 5 through 9 until the coolant level has stabilized and is no longer dropping after each step and the upper radiator hose at the radiator is warm to the touch, indicating that the engine thermostat is open and coolant is flowing through the radiator.
11. Check the secondary cooling system. Repeat steps 1 through 10 until the coolant level has stabilized and is no longer dropping after each step and the lower passenger side of the secondary radiator is warm to the touch, indicating secondary thermostat is open and coolant is flowing through the entire system.
12. Check the coolant level in both systems before you drive your vehicle the next few times.
13. If necessary, add prediluted engine coolant to the coolant reservoirs until the coolant level is within the minimum and maximum range as listed on the reservoir. After you add coolant, check the coolant concentration.

Recycled Coolant

We do not recommend the use of recycled coolant as an approved recycling process is not yet available.

Dispose of used engine coolant in an appropriate manner. Follow your community's regulations and standards for recycling and disposing of automotive fluids.

Maintenance

Severe Climates

If you drive in extremely cold climates:

- It may be necessary to increase the coolant concentration above 50%.
- A coolant concentration of 60% provides improved freeze point protection. Coolant concentrations above 60% decrease the overheat protection characteristics of the coolant and may cause engine damage.

If you drive in extremely hot climates:

- You can decrease the coolant concentration to 40%.
- Coolant concentrations below 40% decrease the freeze and corrosion protection characteristics of the coolant and may cause engine damage.

Vehicles driven year-round in non-extreme climates should use prediluted engine coolant for optimum cooling system and engine protection.

Coolant Change

Follow the specific mileage intervals, as listed in the scheduled maintenance information, to change the coolant. The information display may display a message to change coolant at this time. Add prediluted coolant approved to the correct specification. See **Capacities and Specifications** (page 433).

Engine-driven Cooling Fan

Your vehicle may have an engine driven cooling fan drive also called a fan clutch. This fan drive changes the fan speed to match the vehicle's changing cooling air flow requirements. Fan speed, fan noise level and fuel consumption all will increase based on the driving conditions that include trailer towing, hill climbing, heavy loads, high speed and high ambient temperature, individually or in combination.

The fan drive is designed to provide the minimum fan speed and resulting minimum fan noise and fuel consumption required to meet the ever-changing vehicle cooling air flow requirements. You can hear the amount of fan noise increasing and decreasing as the engine power requirements and vehicle driving conditions change as you drive. This is normal to the operation of your vehicle. You may also hear high levels of the fan when the engine is first started and should normally decrease after driving for a short time.

ENGINE COOLANT CHECK - 7.3L



WARNING: Do not remove the coolant reservoir cap when the engine is on or the cooling system is hot. Wait 10 minutes for the cooling system to cool down. Cover the coolant reservoir cap with a thick cloth to prevent the possibility of scalding and slowly remove the cap. Failure to follow this instruction could result in personal injury.



WARNING: Do not put coolant in the windshield washer reservoir. If sprayed on the windshield, coolant could make it difficult to see through the windshield.

Maintenance



WARNING: To reduce the risk of personal injury, make sure the engine is cool before unscrewing the coolant pressure relief cap. The cooling system is under pressure. Steam and hot liquid can come out forcefully when you loosen the cap slightly.



WARNING: Do not add coolant further than the **MAX** mark.

When the engine is cold, check the concentration and level of the coolant at the intervals listed in the scheduled maintenance information. See **Scheduled Maintenance** (page 557).

Note: Make sure that the coolant level is between the **MIN** and **MAX** marks on the coolant reservoir.

Note: Coolant expands when it is hot. The level may extend beyond the **MAX** mark.

Maintain coolant concentration within 48% to 50%, which equates to a freeze point between -30°F (-34°C) and -34°F (-37°C). Check the coolant concentration using a refractometer. We do not recommend the use of hydrometers or coolant test strips for measuring coolant concentration.

Adding Coolant



WARNING: Do not add engine coolant when the engine is on or the cooling system is hot. Failure to follow this instruction could result in personal injury.



WARNING: Do not remove the coolant reservoir cap when the engine is on or the cooling system is hot. Wait 10 minutes for the cooling system to cool down. Cover the coolant reservoir cap with a thick cloth to prevent the possibility of scalding and slowly remove the cap. Failure to follow this instruction could result in personal injury.

Note: Automotive fluids are not interchangeable. Do not use coolant or windshield washer fluid outside of its specified function and vehicle location.

Note: Do not use stop leak pellets, cooling system sealants, or non-specified additives as they can cause damage to the engine cooling or heating systems. Resulting component damage may not be covered by the vehicle Warranty.

It is very important to use prediluted coolant approved to the correct specification in order to avoid plugging the small passageways in the engine cooling system. See **Capacities and Specifications** (page 461). Do not mix different colors or types of coolant in your vehicle. Mixing of engine coolants or using an incorrect coolant may harm the engine or cooling system components and may not be covered by the vehicle Warranty.

Note: Coolants marketed for all makes and models may not be approved to our specifications and may cause damage to the cooling system. Resulting component damage may not be covered by the vehicle Warranty.

If the coolant level is at or below the minimum mark, add prediluted coolant immediately.

Maintenance

For vehicles with overflow coolant systems with a non-pressurized cap on the coolant recovery system, add coolant to the coolant recovery reservoir when the engine is cool. Add prediluted coolant to the maximum level. For all vehicles which have a coolant degas system with a pressurized cap, or if it is necessary to remove the coolant pressure relief cap on the radiator, follow these steps to add engine coolant:

1. Turn the engine off and let it cool.
2. Unscrew the cap slowly. Any pressure escapes as you unscrew the cap.
3. Fill the coolant reservoir slowly with prediluted engine coolant to within the minimum and maximum range on the engine coolant reservoir. If you removed the radiator cap in an overflow system, fill the radiator until the coolant is visible and the radiator is almost full. If coolant is added to bring the level within the minimum and maximum range when the engine is not cold, the system may remain underfilled.
4. Replace the coolant reservoir cap. Turn the cap clockwise until it contacts the hard stop.
5. Check the coolant level in the coolant reservoir the next few times you drive your vehicle. If necessary, add enough prediluted engine coolant to bring the coolant level to the proper level.

Note: *If prediluted coolant is not available, use the approved antifreeze concentrate diluting it to 50/50 with distilled water. See **Capacities and Specifications** (page 461). Using water that has not been deionized may contribute to deposit formation, corrosion or plugging of the small cooling system passageways.*

If you have to add more than 1.1 qt (1 L) of engine coolant per month, have your vehicle checked as soon as possible. Operating an engine with a low level of coolant can result in engine overheating and possible engine damage.

Note: *During normal vehicle operation, the coolant may change color from orange to pink or light red. As long as the coolant is clear and uncontaminated, this color change does not indicate the coolant has degraded nor does it require the coolant to be drained, the system to be flushed, or the coolant to be replaced.*

Note: *In case of emergency, you can add a large amount of water without coolant in order to reach a vehicle service location. Water alone, without coolant, can cause engine damage from corrosion, overheating or freezing. When you reach a service location, you must have the cooling system drained, flushed and refilled using the correct specification prediluted coolant or antifreeze concentrate. See **Capacities and Specifications** (page 461).*

Do not use the following as a coolant substitute:

- Alcohol.
- Methanol.
- Brine.
- Any coolant mixed with alcohol or methanol antifreeze.

Alcohol and other liquids can cause engine damage from overheating or freezing.

Do not add extra inhibitors or additives to the coolant. These can be harmful and compromise the corrosion protection of the coolant.

Recycled Coolant

We do not recommend the use of recycled coolant as an approved recycling process is not yet available.

Maintenance

Dispose of used engine coolant in an appropriate manner. Follow your community's regulations and standards for recycling and disposing of automotive fluids.

Severe Climates

If you drive in extremely cold climates:

- It may be necessary to increase the coolant concentration above 50%.
- A coolant concentration of 60% provides improved freeze point protection. Coolant concentrations above 60% decrease the overheat protection characteristics of the coolant and may cause engine damage.

If you drive in extremely hot climates:

- You can decrease the coolant concentration to 40%.
- Coolant concentrations below 40% decrease the freeze and corrosion protection characteristics of the coolant and may cause engine damage.

Vehicles driven year-round in non-extreme climates should use prediluted engine coolant for optimum cooling system and engine protection.

Coolant Change

Change the coolant at specific mileage intervals as listed in the scheduled maintenance information. The information display may display a message to change coolant at this time. Add prediluted coolant approved to the correct specification. See **Capacities and Specifications** (page 433).

Engine-driven Cooling Fan (Fan Clutch)

Your vehicle comes with an engine driven cooling fan drive, also called a fan clutch. This fan drive changes the fan speed to match the vehicle's changing cooling air flow requirements. Fan speed, fan noise level and fuel consumption all will increase based on the driving conditions that include trailer towing, hill climbing, heavy loads, high speed and high ambient temperature, individually or in combination.

The fan drive is designed to provide the minimum fan speed, and resulting minimum fan noise and fuel consumption required to meet the ever changing vehicle cooling air flow requirements. You will hear the amount of fan noise increasing and decreasing as the engine power requirements and vehicle driving conditions change as you drive. This is to be expected as being normal to the operation of your vehicle. High levels of fan noise might also be heard when your engine is first started, and should normally decrease after driving for a short time.

Fail-Safe Cooling

Fail-safe cooling allows you to temporarily drive your vehicle before any incremental component damage occurs. The fail-safe distance depends on ambient temperature, vehicle load and terrain.

How Fail-Safe Cooling Works

If the engine begins to overheat, the coolant temperature gauge moves toward the red zone:



A warning lamp illuminates and a message may appear in the information display.



Maintenance

If the engine reaches a preset over-temperature condition, the engine switches to alternating cylinder operation. Each disabled cylinder acts as an air pump and cools the engine.

When this occurs, your vehicle still operates, however:

- Engine power is limited.
- The air conditioning system turns off.

Continued operation increases the engine temperature, causing the engine to completely shut down. Your steering and braking effort increases in this situation.

When the engine temperature cools, you can re-start the engine. Have your vehicle checked as soon as possible to minimize engine damage.

When Fail-Safe Mode Is Activated



WARNING: Fail-safe mode is for use during emergencies only. Operate your vehicle in fail-safe mode only as long as necessary to bring your vehicle to rest in a safe location and seek immediate repairs. When in fail-safe mode, your vehicle will have limited power, will not be able to maintain high-speed operation, and may completely shut down without warning, potentially losing engine power, power steering assist, and power brake assist, which may increase the possibility of a crash resulting in serious injury.



WARNING: Do not remove the coolant reservoir cap when the engine is on or the cooling system is hot. Wait 10 minutes for the cooling system to cool down. Cover the coolant reservoir cap with a thick cloth to prevent the possibility of scalding and slowly remove the cap. Failure to follow this instruction could result in personal injury.

Your vehicle has limited engine power when in the fail-safe mode, drive your vehicle with caution. Your vehicle does not maintain high-speed operation and the engine may operate poorly.

Remember that the engine is capable of shutting down to prevent engine damage. In this situation:

1. Pull off the road as soon as safely possible and switch the engine off.
2. If you are a member of a roadside assistance program, we recommend that you contact your roadside assistance service provider.
3. If this is not possible, wait a short period for the engine to cool.
4. Check the coolant level. If the coolant level is at or below the minimum mark, add prediluted coolant immediately.
5. When the engine temperature cools, you can re-start the engine. Have your vehicle checked as soon as possible to minimize engine damage.

Note: *Driving your vehicle without repair increases the chance of engine damage.*

Engine Coolant Temperature Management (If Equipped)



WARNING: To reduce the risk of crash and injury, be prepared that the vehicle speed may reduce and the vehicle may not be able to accelerate with full power until the coolant temperature reduces.

If you tow a trailer with your vehicle, the engine may temporarily reach a higher temperature during severe operating conditions, for example ascending a long or steep grade in high ambient temperatures.

Maintenance

At this time, you may notice the coolant temperature gauge moves toward the red zone and a message may appear in the information display.

You may notice a reduction in vehicle speed caused by reduced engine power in order to manage the engine coolant temperature. Your vehicle may enter this mode if certain high-temperature and high-load conditions take place. The amount of speed reduction depends on vehicle loading, grade and ambient temperature. If this occurs, there is no need to pull off the road. You can continue to drive your vehicle.

The air conditioning may turn on and off during severe operating conditions to protect the engine from overheating. When the coolant temperature decreases to the normal operating temperature, the air conditioning turns on.

If the coolant temperature gauge moves fully into the red zone, or if the coolant temperature warning or service engine soon messages appear in your information display, do the following:

1. Pull off the road as soon as safely possible and shift the transmission into park (P).
2. Leave the engine running until the coolant temperature gauge needle returns to the normal position. After several minutes, if the temperature does not drop, follow the remaining steps.
3. Switch the engine off and wait for it to cool. Check the coolant level.
4. If the coolant level is at or below the minimum mark, add prediluted coolant immediately.
5. If the coolant level is normal, restart the engine and continue.

AUTOMATIC TRANSMISSION FLUID CHECK

The automatic transmission does not have a transmission fluid dipstick.

Your transmission is filled for life, and does not need to be checked. Your transmission does not consume fluid. However, if the transmission slips or shifts slowly, or if you notice some sign of fluid leakage, have your vehicle checked as soon as possible.

Do not use supplemental transmission fluid additives, treatments or cleaning agents. The use of these materials may affect transmission operation and result in damage to internal transmission components.

Maintenance

TRANSFER CASE FLUID CHECK (IF EQUIPPED)

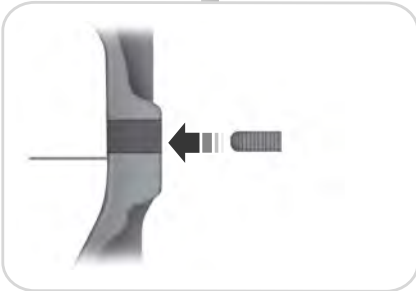
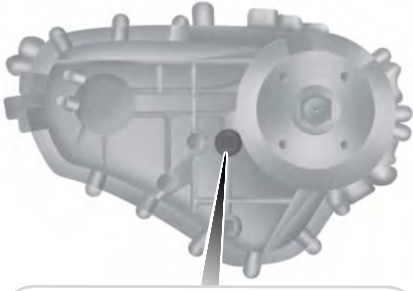

E164246

1. Clean the filler plug.
2. Remove the filler plug and inspect the fluid level.
3. Add only enough fluid through the filler opening so that the fluid level is at the bottom of the opening.

Only use fluid that meets Ford specifications. See **Capacities and Specifications** (page 433).

BRAKE FLUID CHECK

⚠ WARNING: Do not use any fluid other than the recommended brake fluid as this will reduce brake efficiency. Use of incorrect fluid could result in the loss of vehicle control, serious personal injury or death.

⚠ WARNING: Only use brake fluid from a sealed container. Contamination with dirt, water, petroleum products or other materials may result in brake system damage or failure. Failure to adhere to this warning could result in the loss of vehicle control, serious personal injury or death.

⚠ WARNING: Do not allow the fluid to touch your skin or eyes. If this happens, rinse the affected areas immediately with plenty of water and contact your physician.

⚠ WARNING: The brake system could be affected if the brake fluid level is below the **MIN** mark or above the **MAX** mark on the brake fluid reservoir.

Maintenance

For detailed interval information, see Scheduled Maintenance in your Owner's Manual or your local maintenance guide.

POWER STEERING FLUID CHECK

Check the power steering fluid. See **Scheduled Maintenance** (page 557). If adding fluid is necessary, use only MERCON LV ATF

Check the fluid level when it is at ambient temperature.

1. Check the fluid level in the reservoir. It should be between the MIN and MAX range. Do not add fluid if the level is within this range.
2. If the fluid level is low, add fluid to bring the fluid level up to between the MIN and MAX range.
3. Switch the engine on.
4. While the engine idles, turn the steering wheel left and right several times.
5. Switch the engine off.
6. Recheck the fluid level in the reservoir. Do not add fluid if the level is between the MIN and MAX range.
7. If the fluid is low, add fluid in small amounts, continuously checking the level until it is between the MIN and MAX range. For proper fluid type, See **Capacities and Specifications** (page 433). Be sure to put the cap back on the reservoir.



E170684

1. Park your vehicle on a level surface.
2. Look at the brake fluid reservoir to see where the brake fluid level is relative to the **MIN** and the **MAX** marks on the reservoir.

Note: If the brake fluid level is between the **MIN** and the **MAX** marks on the reservoir, it is acceptable.

Note: If the brake fluid level is below the **MIN** mark or above the **MAX** mark, have your vehicle checked as soon as possible.

Note: To avoid fluid contamination, the reservoir cap must remain in place and fully tight, unless you are adding fluid.

Only use fluid that meets our specifications. See **Capacities and Specifications** (page 433).

Brake Fluid Service Interval

Brake fluid absorbs water over time which degrades the effectiveness of the brake fluid. Change the brake fluid at the specified intervals to prevent degraded braking performance.

Maintenance

CHANGING THE 12V BATTERY



WARNING: Batteries normally produce explosive gases which can cause personal injury. Therefore, do not allow flames, sparks or lighted substances to come near the battery. When working near the battery, always shield your face and protect your eyes. Always provide correct ventilation.



WARNING: When lifting a plastic-cased battery, excessive pressure on the end walls could cause acid to flow through the vent caps, resulting in personal injury and damage to the vehicle or battery. Lift the battery with a battery carrier or with your hands on opposite corners.



WARNING: Keep batteries out of reach of children. Batteries contain sulfuric acid. Avoid contact with skin, eyes or clothing. Shield your eyes when working near the battery to protect against possible splashing of acid solution. In case of acid contact with skin or eyes, flush immediately with water for a minimum of 15 minutes and get prompt medical attention. If acid is swallowed, call a physician immediately.



WARNING: Battery posts, terminals and related accessories contain lead and lead compounds, chemicals known to the State of California to cause cancer and reproductive harm. **Wash your hands after handling.**



WARNING: This vehicle may have more than one battery. Removing the battery cables from only one battery does not disconnect your vehicle electrical system. Make sure you disconnect the battery cables from all batteries when disconnecting power. Failure to do so may cause serious personal injury or property damage.

Your vehicle is fitted with a Motorcraft maintenance-free battery which normally does not require additional water.

When a battery replacement is required, you must use a recommended replacement battery that matches the electrical requirements of the vehicle.

Note: *After cleaning or replacing the battery, make sure you reinstall the battery vent tube, battery cover or shield.*

For longer, trouble-free operation, keep the top of the battery clean and dry.

If you see any corrosion on the battery or terminals, remove the cables from the terminals and clean with a wire brush. You can neutralize the acid with a solution of baking soda and water.

Because your vehicle's engine is electronically controlled by a computer, some control conditions are maintained by power from the battery. When the battery is disconnected or a new battery is installed, the engine must relearn its idle and fuel trim strategy for optimum driveability and performance. Flexible fuel vehicles (FFV) must also relearn the ethanol content of the fuel for optimum driveability and performance.

To restore the settings, do the following:

1. Apply the parking brake.
2. Shift into park (P) or neutral (N).
3. Switch off all accessories.

Maintenance

4. Press the brake pedal and start your vehicle.
5. Run the engine until it reaches normal operating temperature. While the engine is warming up, complete the following: Reset the clock. Reset the power windows bounce-back feature. See **Windows and Mirrors** (page 97). Reset the radio station presets. See **Audio System** (page 478).
6. Allow the engine to idle for at least one minute.
7. Drive the vehicle at least 10 mi (16 km) to completely relearn the idle trim and fuel trim strategy.

Note: *If you do not allow the engine to relearn the idle and fuel trim strategy, the idle quality of your vehicle may be adversely affected until the engine computer eventually relearns the idle trim and fuel trim strategy.*

Note: *For flexible fuel vehicles, if you are operating on E85, you may experience poor starts or an inability to start the engine and driveability problems until the fuel trim and ethanol content have been relearned.*

Make sure that you dispose of old batteries in an environmentally friendly way. Seek advice from your local authority about recycling old batteries.

If storing your vehicle for more than 30 days without recharging the battery, we recommend that you disconnect the negative battery cable to maintain battery charge for quick starting.

Battery Management System (if Equipped)

The battery management system monitors battery conditions and takes actions to extend battery life. If excessive battery drain is detected, the system temporarily disables some electrical systems to protect the battery.

Systems included are:

- Heated rear window.
- Heated seats.
- Climate control.
- Heated steering wheel.
- Audio unit.
- Navigation system.

A message may appear in the information displays to alert you that battery protection actions are active. These messages are only for notification that an action is taking place, and not intended to indicate an electrical problem or that the battery requires replacement.

After battery replacement, or in some cases after charging the battery with an external charger, the battery management system requires eight hours of vehicle sleep time to relearn the battery state of charge. During this time your vehicle must remain fully locked with the ignition switched off.

Note: *Prior to relearning the battery state of charge, the battery management system may temporarily disable some electrical systems.*

Electrical Accessory Installation

To make sure the battery management system works correctly, do not connect an electrical device ground connection directly to the battery negative post. This can cause inaccurate measurements of the battery condition and potential incorrect system operation.

Note: *If you add electrical accessories or components to the vehicle, it may adversely affect battery performance and durability. This may also affect the performance of other electrical systems in the vehicle.*

Maintenance

ADJUSTING THE HEADLAMPS

Vertical Aim Adjustment

The headlamps on your vehicle are properly aimed at the assembly plant. If your vehicle has been in an accident, the alignment of your headlamps should be checked by your authorized dealer.

Headlamp Aiming Target

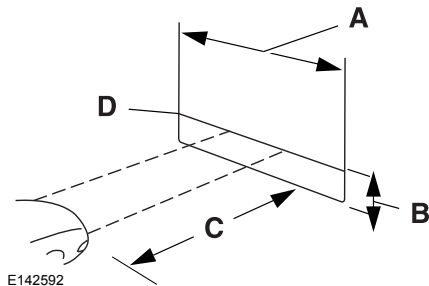

E142592

- A 8 feet (2.4 meters)
- B Center height of lamp to ground
- C 25 feet (7.6 meters)
- D Horizontal reference line

Vertical Aim Adjustment Procedure

1. Park the vehicle directly in front of a wall or screen on a level surface, approximately 25 ft (7.6 m) away.
2. Measure the height of the headlamp bulb center from the ground and mark an 8 ft (2.4 m) horizontal reference line on the vertical wall or screen at this height.

Note: To see a clearer light pattern for adjusting, you may want to block the light from one headlamp while adjusting the other.

3. Turn on the low beam headlamps to illuminate the wall or screen and open the hood.



E142465

4. On the wall or screen you will observe a flat zone of high intensity light located at the top of the right hand portion of the beam pattern. If the top edge of the high intensity light zone is not at the horizontal reference line, the headlamp will need to be adjusted.

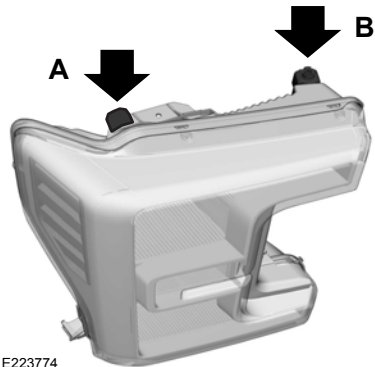

E223774

5. Locate the vertical adjuster on each headlamp. Using a Phillips #2 screwdriver, turn the adjuster either clockwise or counterclockwise in order to adjust the vertical aim of the headlamp.

Note: A. LED headlamp.

Maintenance

B. Halogen headlamp.

- Repeat steps 3 thru 5 to adjust the other headlamp.
- Close the hood and turn off the lamps.

Horizontal Aim Adjustment

Horizontal aim is not required for this vehicle and is not adjustable.

WASHER FLUID CHECK



WARNING: If you operate your vehicle in temperatures below 40°F (5°C), use washer fluid with antifreeze protection. Failure to use washer fluid with antifreeze protection in cold weather could result in impaired windshield vision and increase the risk of injury or accident.

Add fluid to fill the reservoir if the level is low. Only use a washer fluid that meets Ford specifications. See **Capacities and Specifications** (page 433).

State or local regulations on volatile organic compounds may restrict the use of methanol, a common windshield washer antifreeze additive. Washer fluids containing non-methanol antifreeze agents should be used only if they provide cold weather protection without damaging the vehicle's paint finish, wiper blades or washer system.

FUEL FILTER - 6.2L

Your vehicle is equipped with a lifetime fuel filter that is integrated with the fuel tank. Regular maintenance or replacement is not needed.

CHECKING THE WIPER BLADES



E142463

Run the tip of your fingers over the edge of the blade to check for roughness.

Clean the wiper blades with washer fluid or water applied with a soft sponge or cloth.

CHANGING THE WIPER BLADES

You can manually move the wiper arms when the ignition is off. This allows for ease of blade replacement and cleaning under the blades.



E165804

- Pull the wiper blade and arm away from the glass.

Maintenance



E165794

2. Release the wiper blade lock (A) and separate the wiper blade from the wiper arm.
3. Install in the reverse order.

Note: Make sure that the wiper blade locks into place. Lower the wiper arm and blade back on the windshield. The wiper arms will automatically return to their normal position when you turn the ignition on.

- Replace wiper blades at least once per year for optimum performance.
- You can improve poor wiper quality by cleaning the wiper blades and the windshield.

CHANGING A BULB



WARNING: Switch the lamps and the ignition off. Failure to follow this warning could result in serious personal injury.



WARNING: Bulbs can become hot. Let the bulb cool down before removing it. Failure to do so could result in personal injury.

Use the correct specification bulb. See **Bulb Specification Chart** (page 471). Install in the reverse order unless otherwise stated.

Front Park and Direction Indicator Lamp Bulbs

Note: To access the right-hand side bulbs, remove the air intake pipe. See **Changing the Engine Air Filter** (page 351).

To access the left-hand side bulbs, remove the washer reservoir filler tube. Vehicles with diesel engine only.

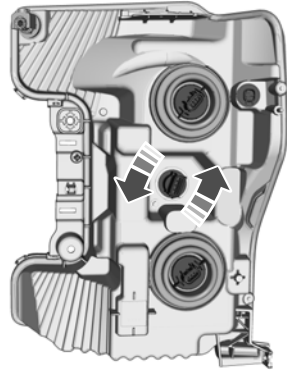

E224990

1. Switch all of the lamps and the ignition off.
2. Disconnect the electrical connector.
3. Turn the bulb holder counterclockwise and remove it.

Note: You cannot separate the bulb from the bulb holder.

Headlamp Bulbs

Note: To access the right-hand side bulbs, remove the air intake pipe. See **Changing the Engine Air Filter** (page 351).

To access the left-hand side bulbs, remove the washer reservoir filler tube. Vehicles with diesel engine only.

Maintenance

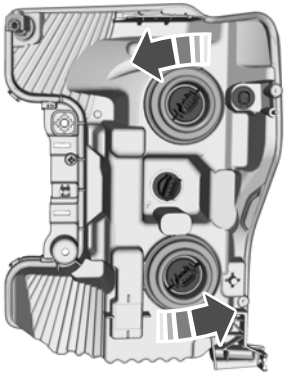

E224991

1. Switch all of the lamps and the ignition off.
2. Disconnect the electrical connector.
3. Turn the bulb holder counterclockwise and remove it.

Note: You cannot separate the bulb from the bulb holder.

Note: Handle a halogen headlamp bulb carefully and keep out of children's reach. Grasp the bulb only by its plastic base and do not touch the glass. The oil from your hand could cause the bulb to break the next time the headlamps are operated.

Fog Lamp Bulbs (If Equipped)

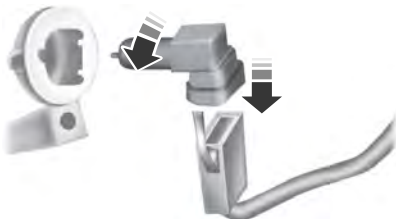

E163826

1. Switch all of the lamps and the ignition off.
2. To access the bulb, reach behind the bumper.
3. Disconnect the electrical connector.
4. Turn the bulb holder counterclockwise and remove it.

Note: You cannot separate the bulb from the bulb holder.

Note: Handle a halogen bulb carefully and keep out of children's reach. Grasp the bulb only by its plastic base and do not touch the glass. The oil from your hand could cause the bulb to break the next time the fog lamps are operated.

Rear Lamps, Brake Lamps, Rear Direction Indicator and Reversing Lamp Bulbs

Pickup Models - Vehicles without Blind Spot Information System

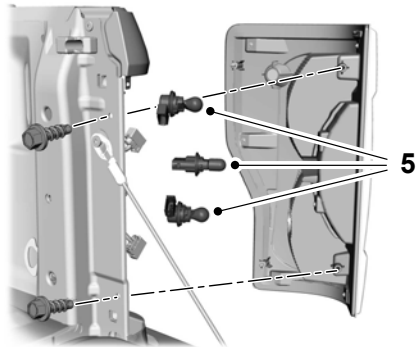

E223775

1. Switch all of the lamps and the ignition off.
2. Open the tailgate to expose the lamp assemblies.

Maintenance

3. Remove the bolts from the tail lamp assembly and carefully pull the lamp assembly from the tailgate pillar by releasing the two retaining tabs.
4. Turn the bulb holder counterclockwise and remove it.
5. Remove the bulb by pulling it straight out.

Pickup Models - Vehicles with Blind Spot Information System

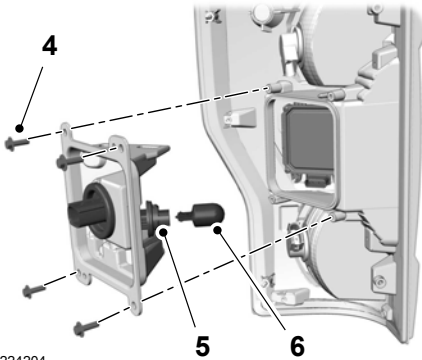

E224204

1. Switch all of the lamps and the ignition off.
2. Open the tailgate to expose the lamp assemblies.
3. Remove the bolts from the tail lamp assembly and carefully pull the lamp assembly from the tailgate pillar by releasing the two retaining tabs.
4. Remove the screws from the blind spot information system module cover.
5. Turn the bulb holder counterclockwise and remove it.
6. Remove the bulb by pulling it straight out.

Chassis Cabs



E163828

1. Switch all of the lamps and the ignition off.
2. Remove the screws and the lamp lens from lamp assembly.
3. Remove the bulb by pulling it straight out.

Cargo Lamp and Central High Mounted Brake Lamp Bulbs

1. Switch all of the lamps and the ignition off.
2. Remove the screws and carefully pull the lamp assembly from the vehicle to expose the bulb sockets.



E187290

3. Turn the bulb holder counterclockwise and remove it.

Maintenance

4. Remove the bulb by pulling it straight out.

License Plate Lamp Bulb

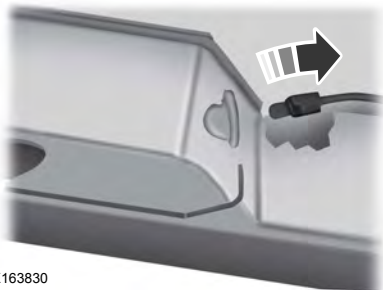

E163830

1. Switch all of the lamps and the ignition off.
2. To access the bulb, reach behind the bumper.
3. Turn the bulb holder counterclockwise and remove it.
4. Remove the bulb by pulling it straight out.

LED Lamps (If Equipped)

LED lamps are not serviceable items. See an authorized dealer if they fail.

The following lamps may be LED:

- Headlamps.
- Front fog lamps.
- Rear lamps.
- High stop lamp and cargo lamp.
- License plate bulb.

CHANGING THE ENGINE-MOUNTED AND DIESEL FUEL CONDITIONER MODULE FUEL FILTERS - 6.7L DIESEL



WARNING: Do not dispose of fuel in the household refuse or the public sewage system. Use an authorized waste disposal facility.

Your vehicle has two fuel filters. The first filter mounts on top of the engine on the left-hand side. The second filter is inside the diesel fuel conditioner module. The module is attached to the fuel tank in different locations depending on the configuration of your truck. See table below for configurations.

Note: *The module is at the front of the fuel tank or at the front of the aft-axle fuel tank on some models.*

Regular fuel filter changes are an important part of engine maintenance; failing to keep with the scheduled maintenance could lead to engine performance issues and fuel injection system damage. See **Scheduled Maintenance** (page 557).

Use only recommended service parts conforming to specifications. See **Motorcraft Parts** (page 437).

Note: *Using fuel that has high levels of impurities may require more frequent filter replacements than the service interval specifies.*

Diesel Fuel Conditioner Module Filter

Filter Location

Use the tables below to find the location of your filter.

Maintenance

Pick-up Truck

Cab Type	Box Length	Filter Location
Regular.	8 ft (2.4 m)	Left side of fuel tank.
SuperCab.	6.75 ft (2.057 m)	
	8 ft (2.4 m)	In front of fuel tank.
Super Crew Cab.	6.75 ft (2.057 m)	Left side of fuel tank.
	8 ft (2.4 m)	

Chassis Cab

Cab Type	Fuel Tank Type	Filter Location
Chassis Cab.	Single midship fuel tank	Right side of fuel tank.
Chassis Cab.	Aft axle/midship fuel tanks	Right side of midship fuel tank.
Chassis Cab.	Single aft axle fuel tank	Front of fuel tank.

Removal

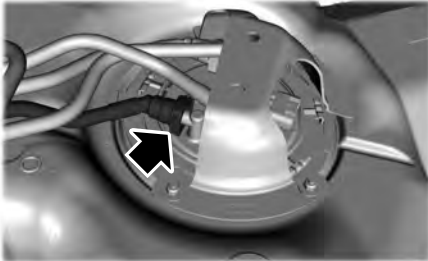

E247666

1. For 2017 models, disconnect the fuel line quick connect coupling from the in tank fuel pump. For 2018 models and later, skip this step but insure that the fuel filler cap is closed before draining the filter. Failure to close the fill cap results in the siphoning of the entire fuel tank contents when you open the drain screw.
2. Locate your filter.

Maintenance

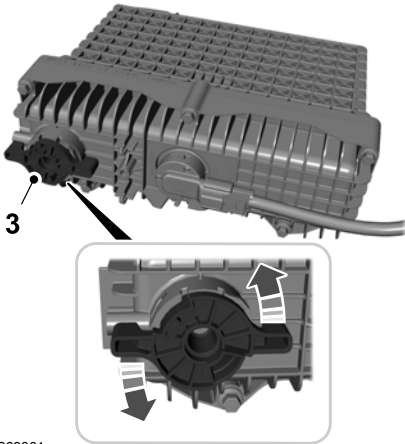

E269861

3. Drain the diesel fuel conditioner module. Turn the drain plug counterclockwise until it stops. Do not use any tools to loosen the drain plug. Drain the filter, approximately 0.53 gal (2 L), into an appropriate container. Do not re-use the fuel drained from the module.

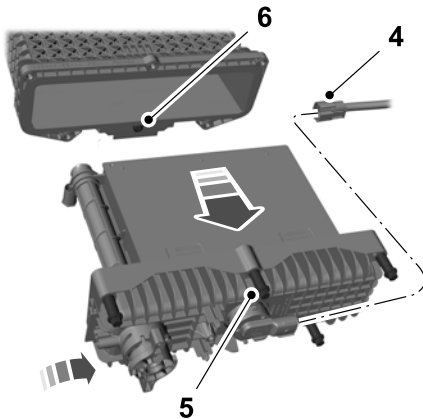

E269862

4. Disconnect the electrical connector.
 5. Fully loosen the bolts securing the lower portion of the diesel fuel conditioner module housing.
- Note:** Do not fully remove the bolts from the lower portion of the diesel fuel conditioner module housing.
6. Remove the lower portion of the diesel fuel conditioner module housing.

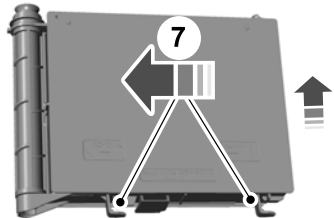

E269863

7. Slide the filter element toward the drain plug to disengage the securing clips.

Installation

1. Slide the filter element into the housing and fully engage the securing clips.
2. Install the lower portion of the housing. Tighten the bolts until you feel a strong resistance. Maximum torque 7 lb.ft (9 Nm).
3. Connect the electrical connector.
4. Tighten the drain plug, turn it clockwise until it stops and you feel a strong resistance. Do not use any tools to tighten the drain plug.

Maintenance

Engine-mounted Fuel Filter

Although the fuel system is not fully pressurized when the vehicle is off, some residual pressure may remain in the fuel system since it can take some time for the pressure to completely bleed off. Therefore, we recommend you place an absorbent cloth below the filter connectors to absorb any fuel that may drain.

The engine-mounted fuel filter is a plastic disposable cartridge.

Removal

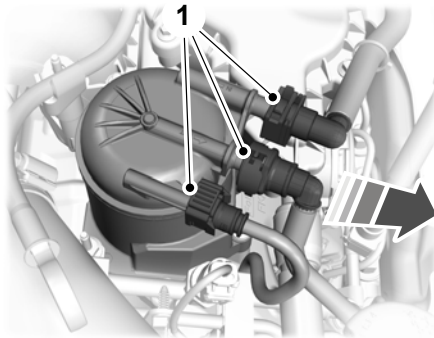

E226215

1. Disconnect the fuel lines by squeezing the connector tabs and pulling the lines straight off.

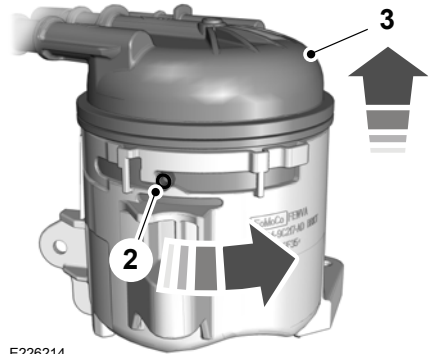

E226214

2. Rotate the filter fully counterclockwise until the peg is at the far end of the slot.
3. Pull the filter straight up from the bracket and discard the filter.

Note: No special air purge is necessary after filter servicing. The fuel system purges the air in the filters.

Installation

1. Install the new filter into the filter bracket. Turn the filter clockwise to lock it in place.
2. Reconnect the fuel lines.
3. Switch the ignition on for 30 seconds and then switch the ignition off. Repeat this operation six times in a row to purge any trapped air from the fuel system.

SPRING U-BOLT CHECK - F-600

Check and tighten the U-bolt nuts after your vehicle has been operated under load for 1,000 mi (1,600 km) or six months, whichever occurs first.

Check and tighten the U-bolt nuts every 37,000 mi (60,000 km).

Maintenance

Check and tighten the U-bolt nuts with your vehicle at curb height and unloaded.

Inspect the U-bolt threads for rust and debris. Clean the threads if contaminated.

U-bolt Nut Torque

Rear Axle

Note: Check and tighten the U-bolt nuts evenly using a criss-cross pattern in the following stages.

Stage	lb.ft (Nm)
1.	70 lb.ft (100 Nm)
2.	150 lb.ft (200 Nm)
3.	220 lb.ft (300 Nm)
4.	300 lb.ft (400 Nm)

Vehicle Care

GENERAL INFORMATION

Your dealer has many quality products available to clean your vehicle and protect its finishes.

CLEANING PRODUCTS

Materials

For best results, use the following products or products of equivalent quality:

Name	Specification
Motorcraft® Bug and Tar Remover, ZC-42 (U.S. & Canada)	
Motorcraft® Custom Bright Metal Cleaner, ZC-15 (U.S. & Canada)	ESR-M5B194-B
Motorcraft® Detail Wash, ZC-3-A (U.S. & Canada)	ESR-M14P4-A
Motorcraft® Engine Shampoo and Degreaser, ZC-20 (U.S.)	ESR-M14P3-A
Motorcraft® Engine Shampoo, CXC-66-A (Canada)	
Motorcraft® Premium Leather and Vinyl Cleaner, ZC-56 (U.S. & Canada)	
Motorcraft® Multi-Purpose Cleaner, CXC-101 (Canada)	
Motorcraft® Premium Windshield Wash Concentrate with Bitterant, ZC-32-B2 (U.S.)	WSS-M14P19-A
Motorcraft® Premium Quality Windshield Washer Fluid, CXC-37-A/B/D/F (Canada)	WSS-M14P19-A
Motorcraft® Professional Strength Carpet & Upholstery Cleaner, ZC-54 (U.S. & Canada)	
Motorcraft® Premium Glass Cleaner, CXC-100 (Canada)	ESR-M14P5-A
Motorcraft® Spot and Stain Remover, ZC-14 (U.S.)	
Motorcraft® Ultra-Clear Spray Glass Cleaner, ZC-23 (U.S.)	ESR-M14P5-A
Motorcraft® Wheel and Tire Cleaner, ZC-37-A (U.S. & Canada)	

CLEANING THE EXTERIOR

Wash your vehicle regularly with cool or lukewarm water and a neutral pH shampoo, we recommend Motorcraft Detail Wash.

- Never use strong household detergents or soap, for example dish washing or laundry liquid. These products can discolor and spot painted surfaces.
- Never wash your vehicle when it is hot to the touch, or during strong or direct sunlight.

Vehicle Care

- Dry your vehicle with a chamois or soft terry cloth towel to eliminate water spotting.
- Immediately remove fuel spillages, bird droppings, insect deposits and road tar. These may cause damage to your vehicle's paintwork or trim over time. We recommend Motorcraft Bug and Tar Remover.
- Remove any exterior accessories, for example antennas, before entering a car wash.
- When filling with AdBlue®, remove any residue on painted surfaces immediately.

Note: *Suntan lotions and insect repellents can damage painted surfaces. If these substances come in contact with your vehicle, wash the affected area as soon as possible.*

Cleaning the Headlamps

Note: *Do not scrape the headlamp lenses or use abrasives, alcoholic solvents or chemical solvents to clean them.*

Note: *Do not wipe the headlamps when they are dry.*

Exterior Chrome Parts

- Apply a high quality-cleaning product to bumpers and other chrome parts. Follow the manufacturer's instructions. We recommend Motorcraft Custom Bright Metal Cleaner.
- Do not apply the cleaning product to hot surfaces. Do not leave the cleaning product on chrome surfaces longer than the time recommended.
- Using non-recommended cleaners can result in severe and permanent cosmetic damage.

Note: *Never use abrasive materials, for example steel wool or plastic pads as they can scratch the chrome surface.*

Note: *Do not use chrome cleaner, metal cleaner or polish on wheels or wheel covers.*

Exterior Plastic Parts

For routine cleaning we recommend Motorcraft Detail Wash. If tar or grease spots are present, we recommend Motorcraft Bug and Tar Remover.

Stripes or Graphics (If Equipped)

Hand washing your vehicle is preferred however, pressure washing may be used under the following conditions:

- Do not use water pressure higher than 2,000 psi (14,000 kPa).
- Do not use water hotter than 179°F (82°C).
- Use a spray with a 40° wide spray angle pattern.
- Keep the nozzle at a 12 in (305 mm) distance and 90° angle to your vehicle's surface.

Note: *Holding the pressure washer nozzle at an angle to the vehicle's surface may damage graphics and cause the edges to peel away from the vehicle's surface.*

Underbody

Regularly clean the underside of your vehicle using water. Keep body and door drain holes free of debris or foreign material.

Under Hood

For removing black rubber marks from under the hood we recommend Motorcraft Wheel and Tire Cleaner or Motorcraft Bug and Tar Remover.

Vehicle Care

WAXING

Regular waxing is necessary to protect your car's paint from the elements. We recommend that you wash and wax the painted surface once or twice a year.

When washing and waxing, park your vehicle in a shaded area out of direct sunlight. Always wash your vehicle before applying wax.

- Use a quality wax that does not contain abrasives.
- Follow the manufacturer's instructions to apply and remove the wax.
- Apply a small amount of wax in a back-and-forth motion, not in circles.
- Do not allow wax to come in contact with any non-body (low-gloss black) colored trim. The wax will discolor or stain the parts over time.
 - Roof racks.
 - Bumpers.
 - Grained door handles.
 - Side moldings.
 - Mirror housings.
 - Windshield cowl area.
- Do not apply wax to glass areas.
- After waxing, your car's paint should feel smooth, and be free of streaks and smudges.

CLEANING THE ENGINE

Engines are more efficient when they are clean because grease and dirt buildup keep the engine warmer than normal.

When washing:

- Take care when using a power washer to clean the engine. The high-pressure fluid could penetrate the sealed parts and cause damage.
- Do not spray a hot engine with cold water to avoid cracking the engine block or other engine components.
- Spray Motorcraft Engine Shampoo and Degreaser on all parts that require cleaning and pressure rinse clean. In Canada, use Motorcraft Engine Shampoo.

Note: *If your vehicle has an engine cover remove the cover before application of Motorcraft Engine Shampoo and Degreaser. Immediately rinse away any over spray.*

- Never wash or rinse the engine while it is hot or running; water in the running engine may cause internal damage.
- Never wash or rinse any ignition coil, spark plug wire or spark plug well, or the area in and around these locations.
- Cover the battery, power distribution box, and air filter assembly to prevent water damage when cleaning the engine.

CLEANING THE EXHAUST - 6.7L DIESEL



WARNING: Failure to maintain the functional holes, in the tailpipe section of the exhaust, clean and free of debris or foreign material may result in the holes becoming blocked or plugged. Do not modify or remove the tail-pipe section. Blocked or plugged holes or removal/modification of the system could result in elevated exhaust gas temperatures which may result in vehicle/property damage or personal injury.

Vehicle Care



WARNING: The normal operating temperature of the exhaust system is very high. Never work around or attempt to repair any part of the exhaust system until it has cooled. Use special care when working around the diesel oxidation catalytic converter and/or the diesel particulate filter (DPF). The diesel oxidation catalytic converter and/or the DPF heats up to a high temperature after only a short period of engine operation and can stay hot even after the engine is turned off. Failure to follow these instructions may result in personal injury.

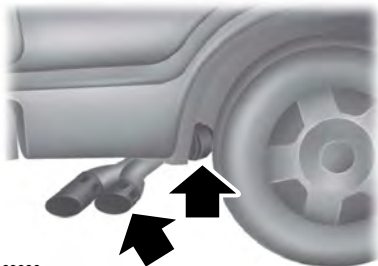

E163380

The visible holes in the exhaust tip and the holes under the shield just inboard of the right rear tire(s) are functional. The holes need to be kept clear of mud/debris or foreign material to maintain proper function of the exhaust system. Clean and remove debris or foreign material if present as needed. Spraying with a hose during regular washing of vehicle should help keep holes clean and clear of debris or foreign material.

CLEANING THE WINDOWS AND WIPER BLADES

Car wash chemicals and environmental fallout can result in windshield and wiper blade contamination. Dirty windshield and wipers will result in poor windshield wiper operation. Keep the windshield and wiper blades clean to maintain windshield wiper performance.

To clean the windshield and wiper blades:

- Clean the windshield with a non-abrasive glass cleaner. When cleaning the interior of the windshield, avoid getting any glass cleaner on the instrument panel or door panels. Wipe any glass cleaner off these surfaces immediately.
- For windshields contaminated with tree sap, chemicals, wax or bugs, clean the entire windshield using steel wool (no greater than 0000 grade) in a circular motion and rinse with water.
- Clean the wiper blades with isopropyl rubbing alcohol or windshield washer concentrate.

Note: Do not use razor blades or other sharp objects to clean or remove decals from the inside of the heated rear window. The vehicle warranty does not cover damage caused to the heated rear window grid lines.

CLEANING THE INTERIOR



WARNING: Do not use cleaning solvents, bleach or dye on the vehicle's seatbelts, as these actions may weaken the belt webbing.

Vehicle Care



WARNING: On vehicles equipped with seat-mounted airbags, do not use chemical solvents or strong detergents. Such products could contaminate the side airbag system and affect performance of the side airbag in a crash.

For fabric, carpets, cloth seats and seats equipped with side airbags:

- Remove dust and loose dirt with a vacuum cleaner.
- Remove light stains and soil with Motorcraft Professional Strength Carpet & Upholstery Cleaner.
- If grease or tar is present on the material, spot-clean the area first with Motorcraft Spot and Stain Remover. In Canada, use Motorcraft Multi-Purpose Cleaner.

- If a ring forms on the fabric after spot cleaning, clean the entire area immediately (but do not oversaturate) or the ring will set.
- Do not use household cleaning products or glass cleaners, which can stain and discolor the fabric and affect the flame retardant abilities of the seat materials.

Note: *Cashmere and microfiber cloth fabric is made of polyester microfiber with micro-porous polyurethane. Using commercially available fabric cleaners can cause permanent damage.*

Note: *Do not use commercially available leather and vinyl cleaning products on cashmere or microfiber cloth fabric.*

Note: *Your vehicle may have cashmere or microfiber cloth fabric on the seats, headliner, floor mats and door panels.*

Depending on the type of stain, use water, lemon juice or pure ethyl alcohol when cleaning. For cleaning microfiber cloth, refer to the following chart:

Type of Stain	Cleaning Procedure
Fruit juice, jam, jelly, syrup or ketchup.	Use lukewarm water and rinse by dabbing with clean water.
Blood, egg, excrement or urine.	Use cold water and rinse by dabbing with clean water. Avoid warm water because it makes these substances coagulate.
Liquor, alcoholic beverages, wine, beer, cola and tea.	Use lukewarm water. If the color remains, treat with lemon juice and then rinse.
Indelible pencil, cocoa, chocolate, pastry with cream or chocolate, ice cream or mustard.	Use lukewarm water and rinse by dabbing with clean water.
Vinegar, hair gel, tomato sauce or coffee with sugar.	Use lemon juice, wipe with lukewarm water and rinse by dabbing with clean water.
Dye transfer and all other stains.	Use ethyl alcohol, then dab with water.

Vehicle Care

CLEANING THE INSTRUMENT PANEL AND INSTRUMENT CLUSTER LENS



WARNING: Do not use chemical solvents or strong detergents when cleaning the steering wheel or instrument panel to avoid contamination of the airbag system.

Note: Follow the same procedure as cleaning leather seats for cleaning leather instrument panels and leather interior trim surfaces. See **Cleaning Leather Seats** (page 390).

Clean the instrument panel and cluster lens with a clean, damp and soft cloth, then use a clean, dry and soft cloth to dry these areas.

- Avoid cleaners or polishes that increase the gloss of the upper portion of the instrument panel. The dull finish in this area helps protect you from undesirable windshield reflection.
- Do not use any household cleaning products or glass cleaners as these may damage the finish of the instrument panel, interior trim and cluster lens.
- Wash or wipe your hands clean if you have been in contact with certain products such as insect repellent and suntan lotion to avoid possible damage to the interior painted surfaces.
- Do not allow air fresheners and hand sanitizers to spill onto interior surfaces. If a spill occurs, wipe off immediately. Your warranty may not cover these damages.

If a staining liquid like coffee or juice has been spilled on the instrument panel or on interior trim surfaces:

1. Wipe up spilled liquid using a clean, soft cloth as quickly as possible.
2. Use Motorcraft Premium Leather and Vinyl Cleaner or a commercially available leather cleaning product for automotive interiors. Test any cleaner or stain remover on an inconspicuous area.
3. Alternatively, wipe the surface with a clean, soft cloth and a mild soap and water solution. Dry the area with a clean, soft cloth.
4. If necessary, apply more soap and water solution or cleaning product to a clean, soft cloth and press it onto the soiled area. Allow this to set at room temperature for 30 minutes.
5. Remove the soaked cloth, then with a clean, damp cloth, use a rubbing motion for 60 seconds on the soiled area.
6. Dry the area with a clean, soft cloth.

CLEANING LEATHER SEATS (IF EQUIPPED)

Without King Ranch Edition

Note: Follow the same procedure as cleaning leather seats for cleaning leather instrument panels and leather interior trim surfaces.

For routine cleaning, wipe the surface with a soft, damp cloth and a mild soap and water solution. Dry the area with a clean, soft cloth.

For cleaning and removing spots and stains such as dye transfer, use Motorcraft Premium Leather and Vinyl Cleaner or a commercially available leather cleaning product for automotive interiors.

Note: Test any cleaner or stain remover on an inconspicuous area.

Vehicle Care

You should:

- Remove dust and loose dirt with a vacuum cleaner.
- Clean and treat spills and stains as soon as possible.

Do not use the following products as these may damage the leather:

- Oil and petroleum or silicone-based leather conditioners.
- Household cleaners.
- Alcohol solutions.
- Solvents or cleaners intended specifically for rubber, vinyl and plastics.

With King Ranch Edition

Your vehicle has seating covered in premium, top-grain leather that is extremely durable, but still requires special care and maintenance in order to preserve longevity and comfort.

Regular cleaning and conditioning maintains the appearance of the leather.

Cleaning

For dirt, use a vacuum cleaner then use a clean, damp cloth or soft brush.

For routine cleaning, wipe the surface with a soft, damp cloth. For more thorough cleaning, wipe the surface with a mild soap and water solution.

- Clean spills as quickly as possible.
- Test any cleaner or stain remover on an inconspicuous part of the leather as cleaners may darken the leather.

- Do not spill coffee, ketchup, mustard, orange juice or oil-based products on the leather as they may permanently stain the leather.
- Do not use household cleaning products, alcohol solutions, solvents or cleaners intended for rubber, vinyl or plastics.

Scratches

Because the leather in the seat comes from genuine steer hides, there may be evidence of naturally occurring markings, such as small scars. These markings give character to the seating covers and are considered to be proof of a genuine leather product.

In order to lessen the appearance of certain scratches and other wear marks, apply conditioner on the affected area following the same instructions as in the **Conditioning** section.

Conditioning

Bottles of King Ranch Leather Conditioner are available at the King Ranch Saddle Shop. Visit the website at www.krsaddleshop.com, or call 1-800-282-KING (5464) in the United States. If you are unable to obtain King Ranch Leather Conditioner, use another premium leather conditioner.

- Clean the surfaces using the steps outlined in the Cleaning section.
- Make sure the leather is dry then apply a nickel-sized amount of conditioner to a clean, dry cloth.
- Rub the conditioner into the leather until it disappears. Allow the conditioner to dry, then repeat the process for the entire interior. If a film appears, wipe it off with a dry, clean cloth.

Vehicle Care

REPAIRING MINOR PAINT DAMAGE

Authorized dealers have touch-up paint to match your vehicle's color. Your vehicle color code is printed on a sticker on the front, left-hand side door jamb. Take your color code to your authorized dealer to make sure you get the correct color.

Before repairing minor paint damage, use a cleaner such as Motorcraft Bug and Tar Remover to remove particles such as bird droppings, tree sap, insect deposits, tar spots, road salt and industrial fallout.

Read the instructions before using cleaning products.

CLEANING THE WHEELS

1. Regularly clean them with a wheel cleaner. We recommend that you use Ford approved wheel cleaner if available.
2. Remove dirt and brake dust with a sponge.
3. Remove tar and grease with a bug and tar remover. We recommend that you use Ford approved bug and tar remover if available.
4. Thoroughly rinse the wheels with water after cleaning.

If you intend on parking your vehicle for an extended period after cleaning the wheels with a wheel cleaner, drive your vehicle for a few minutes before doing so. This reduces the risk of corrosion of the brake discs, brake pads and linings.

Do not clean the wheels when they are hot.

Note: *Some car washes could damage wheel rims and covers.*

Note: *Using non-recommended cleaners, harsh cleaning products, chrome wheel cleaners or abrasive materials could damage wheel rims and covers.*

VEHICLE STORAGE

If you plan on storing your vehicle for 30 days or more, read the following maintenance recommendations to make sure your vehicle stays in good operating condition.

We engineer and test all motor vehicles and their components for reliable, regular driving. Under various conditions, long-term storage may lead to degraded engine performance or failure unless you use specific precautions to preserve engine components.

General

- Store all vehicles in a dry, ventilated place.
- Protect from sunlight, if possible.
- If vehicles are stored outside, they require regular maintenance to protect against rust and damage.

Body

- Wash your vehicle thoroughly to remove dirt, grease, oil, tar or mud from exterior surfaces, rear-wheel housing and the underside of front fenders.
- Periodically wash your vehicle if it is stored in exposed locations.
- Touch-up exposed or primed metal to prevent rust.
- Cover chrome and stainless steel parts with a thick coat of auto wax to prevent discoloration. Re-wax as necessary when you wash your vehicle.
- Lubricate all hood, door and luggage compartment hinges and latches with a light grade oil.

Vehicle Care

- Cover interior trim to prevent fading.
- Keep all rubber parts free from oil and solvents.

Engine

- Change the engine oil and filter prior to storage because used engine oil contains contaminants which may cause engine damage.
- Start the engine every 15 days for a minimum of 15 minutes. Run at fast idle with the climate controls set to defrost until the engine reaches normal operating temperature.
- With your foot on the brake, shift through all the gears while the engine is running.
- We recommend that you change the engine oil before you use your vehicle again.

Fuel system

- Fill the fuel tank with high-quality fuel until the first automatic shutoff of the fuel pump nozzle.

Cooling system

- Protect against freezing temperatures.
- When removing your vehicle from storage, check coolant fluid level. Confirm that there are no cooling system leaks and that fluid is at the recommended level.

Disconnecting Your 12 Volt Battery

- Check and recharge as necessary. Keep connections clean.
- If storing your vehicle for more than 30 days without recharging the battery, we recommend that you disconnect the battery cables to maintain battery charge for quick starting.

Note: *It is necessary to reset memory features if you disconnect the battery cables.*

Brakes

- Make sure the brakes and parking brake release fully.

Tires

- Maintain recommended air pressure.

Miscellaneous

- Make sure all linkages, cables, levers and pins under your vehicle are covered with grease to prevent rust.
- Move vehicles at least 25 ft (7.5 m) every 15 days to lubricate working parts and prevent corrosion.

Removing Vehicle From Storage

When your vehicle is ready to come out of storage, do the following:

- Wash your vehicle to remove any dirt or grease film build-up on window surfaces.
- Check windshield wipers for any deterioration.
- Check under the hood for any foreign material that may have collected during storage such as mice or squirrel nests.
- Check the exhaust for any foreign material that may have collected during storage.
- Check tire pressures and set tire inflation per the Tire Label.
- Check brake pedal operation. Drive your vehicle 15 ft (4.5 m) back and forth to remove rust build-up.

Vehicle Care

- Check fluid levels (including coolant, oil and gas) to make sure there are no leaks, and fluids are at recommended levels.
- If you remove the battery, clean the battery cable ends and check for damage.

Contact an authorized dealer if you have any concerns or issues.

Wheels and Tires

GENERAL INFORMATION

Use only approved wheel and tire sizes, using other sizes could damage your vehicle. If you change the diameter of the tires from that fitted at the factory, the speedometer may not display the correct speed. If you intend to change the size of the wheels from that fitted by the manufacturer, you can check the suitability with an authorized dealer.

Additional information related to the functionality and maintenance of your tires can be found later in this chapter. See **Tire Care** (page 397).

You can find the recommended tire inflation pressures can on the Tire Label, which is on the B-pillar or the edge of the driver door. You can also find this information on the Safety Compliance Certification Label, affixed to either the door hinge pillar, door-latch post, or the door edge that meets the door latch post; next to the driver seating position.

We strongly recommend maintaining these tire pressures at all times. Failure to follow the tire pressure recommendations can cause uneven treadwear patterns, reduced fuel economy, and adversely affect the way your vehicle handles.

Note: *Check and set the tire pressure at the ambient temperature in which you are intending to drive your vehicle and when the tires are cold.*

Note: *Check your tire pressures at least once per month.*

If your vehicle has a spare tire, set the pressure to the highest value given for your vehicle and tire size combination.

Notice to utility vehicle and truck owners



WARNING: Utility vehicles have a significantly higher rollover rate than other types of vehicles.



WARNING: Vehicles with a higher center of gravity (utility and four-wheel drive vehicles) handle differently than vehicles with a lower center of gravity (passenger cars). Avoid sharp turns, excessive speed and abrupt steering in these vehicles. Failure to drive cautiously increases the risk of losing control of your vehicle, vehicle rollover, personal injury and death.



WARNING: In a rollover crash, an unbelted person is significantly more likely to die than a person wearing a seatbelt.



WARNING: Do not become overconfident in the ability of four-wheel drive vehicles. Although a four-wheel drive vehicle may accelerate better than a two-wheel drive vehicle in low traction situations, it won't stop any faster than two-wheel drive vehicles. Always drive at a safe speed.

Utility vehicles and trucks handle differently than passenger cars in the various driving conditions that are encountered on streets, highways and off-road. Utility vehicles and trucks are not designed for cornering at speeds as high as passenger cars any more than low-slung sports cars are designed to perform satisfactorily under off-road conditions.

Wheels and Tires

Study your owner's manual and any supplements for specific information about equipment features, instructions for safe driving and additional precautions to reduce the risk of an accident or serious injury.

Four-wheel drive system (If Equipped)



WARNING: Do not become overconfident in the ability of four-wheel drive vehicles. Although a four-wheel drive vehicle may accelerate better than a two-wheel drive vehicle in low traction situations, it won't stop any faster than two-wheel drive vehicles. Always drive at a safe speed.

A vehicle equipped with four-wheel drive, when selected, has the ability to use all four wheels to power itself. This increases traction which may enable you to safely drive over terrain and road conditions that a conventional two-wheel drive vehicle cannot.

Power is supplied to all four wheels through a transfer case or power transfer unit. Four-wheel drive vehicles allow you to select different modes as necessary. For information on transfer case operation and shifting procedures, See **Four-Wheel Drive** (page 212). For information on transfer case maintenance, See **Maintenance** (page 342). You should become thoroughly familiar with this information before you operate your vehicle.

On some four-wheel drive vehicles, the initial shift from two-wheel to four-wheel drive when the vehicle is moving can cause a momentary clunk and ratcheting sound. These sounds are normal and are not cause for concern.

In four-wheel drive vehicles, the size of the spare tire relative to the remaining tires can have an effect on the 4x4 system. If there is a significant difference between the size of a spare and the remaining tires, four-wheel drive functionality may be limited. See **Using Four-Wheel Drive** (page 212).

How your vehicle differs from other vehicles

Sport utility vehicles and trucks can differ from some other vehicles in a few noticeable ways. Your vehicle may be:

- Higher - to allow higher load carrying capacity and to allow it to travel over rough terrain without getting hung up or damaging underbody components.
- Shorter - to give it the capability to approach inclines and drive over the crest of a hill without getting hung up or damaging underbody components. All other things held equal, a shorter wheelbase may make your vehicle quicker to respond to steering inputs than a vehicle with a longer wheelbase.
- Narrower - to provide greater maneuverability in tight spaces, particularly in off-road use.

As a result of the above dimensional differences, Sport utility vehicles and trucks often have a higher center of gravity and a greater difference in center of gravity between the loaded and unloaded condition. These differences that make your vehicle so versatile also make it handle differently than an ordinary passenger car.

Wheels and Tires

TIRE CARE

Information About Uniform Tire Quality Grading



E142542

Tire Quality Grades apply to new pneumatic passenger car tires. The Quality grades can be found where applicable on the tire sidewall between tread shoulder and maximum section width. For example: **Treadwear 200 Traction AA Temperature A.**

These Tire Quality Grades are determined by standards that the United States Department of Transportation has set.

Tire Quality Grades apply to new pneumatic passenger car tires. They do not apply to deep tread, winter-type snow tires, space-saver or temporary use spare tires, light truck or LT type tires, tires with nominal rim diameters of 10 to 12 inches or limited production tires as defined in Title 49 Code of Federal Regulations Part 575.104 ©)(2).

U.S. Department of Transportation Tire quality grades:

The U.S. Department of Transportation requires Ford Motor Company to give you the following information about tire grades exactly as the government has written it.

Treadwear

The treadwear grade is a comparative rating based on the wear rate of the tire when tested under controlled conditions on a specified government test course. For example, a tire graded 150 would wear one and one-half ($1\frac{1}{2}$) times as well on the government course as a tire graded 100. The relative performance of tires depends upon the actual conditions of their use, however, and may depart significantly from the norm due to variations in driving habits, service practices, and differences in road characteristics and climate.

Traction AA A B C



WARNING: The traction grade assigned to this tire is based on straight-ahead braking traction tests, and does not include acceleration, cornering, hydroplaning or peak traction characteristics.

Wheels and Tires

The traction grades, from highest to lowest are AA, A, B, and C. The grades represent the tire's ability to stop on wet pavement as measured under controlled conditions on specified government test surfaces of asphalt and concrete. A tire marked C may have poor traction performance.

Temperature A B C



WARNING: The temperature grade for this tire is established for a tire that is properly inflated and not overloaded. Excessive speed, underinflation, or excessive loading, either separately or in combination, can cause heat buildup and possible tire failure.

The temperature grades are A (the highest), B and C, representing the tire's resistance to the generation of heat and its ability to dissipate heat when tested under controlled conditions on a specified indoor laboratory test wheel. Sustained high temperature can cause the material of the tire to degenerate and reduce tire life, and excessive temperature can lead to sudden tire failure. The grade C corresponds to a level of performance which all passenger car tires must meet under the

Federal Motor Vehicle Safety Standard No. 139. Grades B and A represent higher levels of performance on the laboratory test wheel than the minimum required by law.

Glossary of Tire Terminology

***Tire label:** A label showing the original equipment tire sizes, recommended inflation pressure and the maximum weight the vehicle can carry.

***Tire Identification Number (TIN):** A number on the sidewall of each tire providing information about the tire brand and manufacturing plant, tire size and date of manufacture. Also referred to as DOT code.

***Inflation pressure:** A measure of the amount of air in a tire.

***Standard load:** A class of P-metric or Metric tires designed to carry a maximum load at set pressure. For example: For P-metric tires 35 psi (2.4 bar) and for Metric tires 36 psi (2.5 bar). Increasing the inflation pressure beyond this pressure will not increase the tire's load carrying capability.

***Extra load:** A class of P-metric or Metric tires designed to carry a heavier maximum load at 42 psi (2.9 bar). Increasing the inflation pressure beyond this pressure will not increase the tire's load carrying capability.

Wheels and Tires

***kPa:** Kilopascal, a metric unit of air pressure.

***PSI:** Pounds per square inch, a standard unit of air pressure.

***Cold tire pressure:** The tire pressure when the vehicle has been stationary and out of direct sunlight for an hour or more and prior to the vehicle being driven for 1 mile (1.6 kilometers).

***Recommended inflation pressure:** The cold inflation pressure found on the Safety Compliance Certification Label (affixed to either the door hinge pillar, door-latch post, or the door edge that meets the door-latch post, next to the driver's seating position), or Tire Label located on the B-pillar or the edge of the driver's door.

B-pillar: The structural member at the side of the vehicle behind the front door.

***Bead area of the tire:** Area of the tire next to the rim.

* **Sidewall of the tire:** Area between the bead area and the tread.

***Tread area of the tire:** Area of the perimeter of the tire that contacts the road when mounted on the vehicle.

***Rim:** The metal support (wheel) for a tire or a tire and tube assembly upon which the tire beads are seated.

Information Contained on the Tire Sidewall

Both United States and Canada Federal regulations require tire manufacturers to place standardized information on the sidewall of all tires. This information identifies and describes the fundamental characteristics of the tire and also provides a U.S. DOT Tire Identification Number for safety standard certification and in case of a recall.

Information on P Type Tires

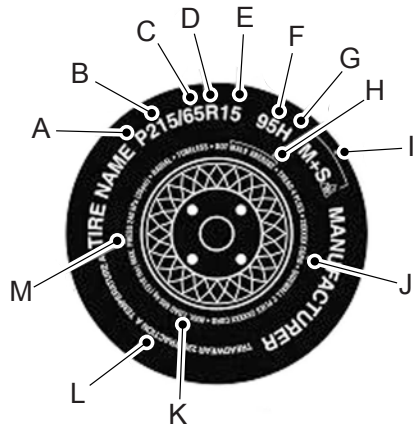

E142543

P215/65R15 95H is an example of a tire size, load index and speed rating. The definitions of these items are listed below. (Note that the tire size, load index and speed rating for your vehicle may be different from this example).

Wheels and Tires

A. **P:** Indicates a tire, designated by the Tire and Rim Association, that may be used for service on cars, sport utility vehicles, minivans and light trucks. **Note:** If your tire size does not begin with a letter this may mean it is designated by either the European Tire and Rim Technical Organization or the Japan Tire Manufacturing Association.

B. **215:** Indicates the nominal width of the tire in millimeters from sidewall edge to sidewall edge. In general, the larger the number, the wider the tire.

C. **65:** Indicates the aspect ratio which gives the tire's ratio of height to width.

D. **R:** Indicates a radial type tire.

E. **15:** Indicates the wheel or rim diameter in inches. If you change your wheel size, you will have to purchase new tires to match the new wheel diameter.

F. **95:** Indicates the tire's load index. It is an index that relates to how much weight a tire can carry. You may find this information in your owner's manual. If not, contact a local tire dealer.

Note: *You may not find this information on all tires because it is not required by federal law.*

G. **H:** Indicates the tire's speed rating. The speed rating denotes the speed at which a tire is designed to be driven for extended periods of time under a standard condition of load and inflation pressure. The tires on your vehicle may operate at different conditions for load and inflation pressure. These speed ratings may need to be adjusted for the difference in conditions. The ratings range from 81 mph (130 km/h) to 186 mph (299 km/h). These ratings are listed in the following chart.

Note: *You may not find this information on all tires because it is not required by federal law.*

Letter rating	mph (km/h)
M	81 (130)
N	87 (140)
Q	99 (159)
R	106 (171)
S	112 (180)
T	118 (190)
U	124 (200)
H	130 (210)
V	149 (240)

Wheels and Tires

Letter rating	mph (km/h)
W	168 (270)
Y	186 (299)

Note: For tires with a maximum speed capability over 149 mph (240 km/h), tire manufacturers sometimes use the letters ZR. For those with a maximum speed capability over 186 mph (299 km/h), tire manufacturers always use the letters ZR.

H. U.S. DOT Tire Identification

Number: This begins with the letters DOT and indicates that the tire meets all federal standards. The next two numbers or letters are the plant code designating where it was manufactured, the next two are the tire size code and the last four numbers represent the week and year the tire was built. For example, the numbers 317 mean the 31st week of 1997. After 2000 the numbers go to four digits. For example, 2501 means the 25th week of 2001. The numbers in between are identification codes used for traceability. This information is used to contact customers if a tire defect requires a recall.

I. **M+S or M/S:** Mud and Snow, or

AT: All Terrain, or

AS: All Season.

J. Tire Ply Composition and

Material Used: Indicates the number of plies or the number of layers of rubber-coated fabric in the tire tread and sidewall. Tire manufacturers also must indicate the ply materials in the tire and the sidewall, which include steel, nylon, polyester, and others.

K. **Maximum Load:** Indicates the maximum load in kilograms and pounds that can be carried by the tire. (affixed to either the door hinge pillar, door-latch post, or the door edge that meets the door-latch post, next to the driver's seating position), or Tire Label located on the B-pillar or the edge of the driver's door.

L. Treadwear, Traction and Temperature Grades:

***Treadwear** The treadwear grade is a comparative rating based on the wear rate of the tire when tested under controlled conditions on a specified government test course. For example, a tire graded 150 would wear 1½ times as well on the government course as a tire graded 100.

***Traction:** The traction grades, from highest to lowest are AA, A, B, and C. The grades represent the tire's ability to stop on wet pavement as measured under controlled conditions on specified government test surfaces of asphalt and concrete. A tire marked C may have poor traction performance.

Wheels and Tires

***Temperature:** The temperature grades are A (the highest), B and C, representing the tire's resistance to the generation of heat and its ability to dissipate heat when tested under controlled conditions on a specified indoor laboratory test wheel.

M. Maximum Inflation

Pressure: Indicates the tire manufacturers' maximum permissible pressure or the pressure at which the maximum load can be carried by the tire. This pressure is normally higher than the vehicle manufacturer's recommended cold inflation pressure which can be found on the Safety Compliance Certification Label (affixed to either the door hinge pillar, door-latch post, or the door edge that meets the door-latch post, next to the driver's seating position), or Tire Label located on the B-pillar or the edge of the driver's door. The cold inflation pressure should never be set lower than the recommended pressure on the vehicle label.

The tire suppliers may have additional markings, notes or warnings such as standard load or radial tubeless.

Additional Information Contained on the Tire Sidewall for LT Type Tires

Note: *Tire Quality Grades do not apply to this type of tire.*

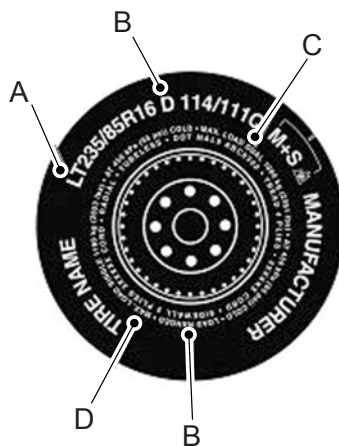

E142544

LT type tires have some additional information beyond those of P type tires. These differences are described below.

A. LT: Indicates a tire, designated by the Tire and Rim Association, that is intended for service on light trucks.

B. Load Range and Load Inflation Limits: Indicates the tire's load-carrying capabilities and its inflation limits.

C. Maximum Load Dual lb (kg) at psi (kPa) cold: Indicates the maximum load and tire pressure when the tire is used as a dual; defined as four tires on the rear axle (a total of six or more tires on the vehicle).

Wheels and Tires

D. Maximum Load Single lb (kg) at psi (kPa) cold: Indicates the maximum load and tire pressure when the tire is used as a single; defined as two tires (total) on the rear axle.

Information on T Type Tires

T145/80D16 is an example of a tire size.

Note: *The temporary tire size for your vehicle may be different from this example. Tire Quality Grades do not apply to this type of tire.*

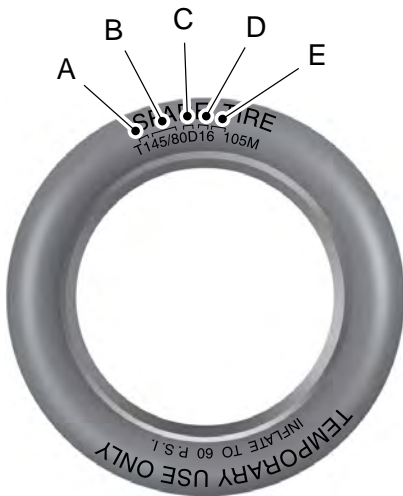

E142545

T type tires have some additional information beyond those of P type tires. These differences are described below:

A. T: Indicates a type of tire, designated by the Tire and Rim Association, that is intended for temporary service on cars, sport utility vehicles, minivans and light trucks.

B. 145: Indicates the nominal width of the tire in millimeters from sidewall edge to sidewall edge. In general, the larger the number, the wider the tire.

C. 80: Indicates the aspect ratio which gives the tire's ratio of height to width. Numbers of 70 or lower indicate a short sidewall.

D. D: Indicates a diagonal type tire.

R: Indicates a radial type tire.

E. 16: Indicates the wheel or rim diameter in inches. If you change your wheel size, you will have to purchase new tires to match the new wheel diameter.

Location of the Tire Label

You will find a Tire Label containing tire inflation pressure by tire size and other important information located on the B-Pillar or the edge of the driver's door.

Wheels and Tires

Inflating Your Tires

Safe operation of your vehicle requires that your tires are properly inflated. Remember that a tire can lose up to half of its air pressure without appearing flat.

Every day before you drive, check your tires. If one looks lower than the others, use a tire gauge to check pressure of all tires and adjust if required.

At least once a month and before long trips, inspect each tire and check the tire pressure with a tire gauge (including spare, if equipped). Inflate all tires to the inflation pressure recommended by Ford Motor Company.

You are strongly urged to buy a reliable tire pressure gauge, as automatic service station gauges may be inaccurate. Ford recommends the use of a digital or dial-type tire pressure gauge rather than a stick-type tire pressure gauge.

Use the recommended cold inflation pressure for optimum tire performance and wear. Under-inflation or over-inflation may cause uneven treadwear patterns.



WARNING: Under-inflation is the most common cause of tire failures and may result in severe tire cracking, tread separation or blowout, with unexpected loss of vehicle control and increased risk of injury. Under-inflation increases sidewall flexing and rolling resistance, resulting in heat buildup and internal damage to the tire. It also may result in unnecessary tire stress, irregular wear, loss of vehicle control and accidents. A tire can lose up to half of its air pressure and not appear to be flat!

Always inflate your tires to the Ford recommended inflation pressure even if it is less than the maximum inflation pressure information found on the tire. The Ford recommended tire inflation pressure is found on the Safety Compliance Certification Label or Tire Label (affixed to either the door hinge pillar, door-latch post, or the door edge that meets the door-latch post, next to the driver's seating position), or Tire Label located on the B-pillar or the edge of the driver's door. Failure to follow the tire pressure recommendations can cause uneven treadwear patterns and adversely affect the way your vehicle handles.

Wheels and Tires

Note: *Do not reduce tire pressure to change the ride characteristics of the vehicle. If you do not maintain the inflation pressure at the levels specified by Ford, your vehicle may experience a condition known as shimmy. Shimmy is a severe vibration and oscillation in the steering wheel after the vehicle travels over a bump or dip in the road that does not dampen out by itself. Shimmy may result from significant under-inflation of the tires, improper tires (load range, size, or type), or vehicle modifications such as lift-kits. In the event that your vehicle experiences shimmy, you should slowly reduce speed by either lifting off the accelerator pedal or lightly applying the brakes. The shimmy will cease as the vehicle speed decreases.*

Maximum Inflation Pressure is the tire manufacturer's maximum permissible pressure and the pressure at which the maximum load can be carried by the tire. This pressure is normally higher than the manufacturer's recommended cold inflation pressure which can be found on the Safety Compliance Certification Label (affixed to either the door hinge pillar, door-latch post, or the door edge that meets the door-latch post, next to the driver's seating position), or Tire Label located on

the B-pillar or the edge of the driver's door. The cold inflation pressure should never be set lower than the recommended pressure on the Safety Compliance Certification Label or Tire Label.

When weather temperature changes occur, tire inflation pressures also change. A 10°F (6°C) temperature drop can cause a corresponding drop of 1 psi (7 kPa) in inflation pressure. Check your tire pressures frequently and adjust them to the proper pressure which can be found on the Safety Compliance Certification Label or Tire Label.

To check the pressure in your tire(s):

1. Make sure the tires are cool, meaning they are not hot from driving even a mile.

Note: *If you are checking tire pressure when the tire is hot, (for example, driven more than 1 mile [1.6 kilometers]), never bleed or reduce air pressure. The tires are hot from driving and it is normal for pressures to increase above recommended cold pressures. A hot tire at or below recommended cold inflation pressure could be significantly under-inflated.*

Wheels and Tires

Note: *If you have to drive a distance to get air for your tire(s), check and record the tire pressure first and add the appropriate air pressure when you get to the pump. It is normal for tires to heat up and the air pressure inside to go up as you drive.*

2. Remove the cap from the valve on one tire, then firmly press the tire gauge onto the valve and measure the pressure.

3. Add enough air to reach the recommended air pressure.

Note: *If you overfill the tire, release air by pressing on the metal stem in the center of the valve. Then recheck the pressure with your tire gauge.*

4. Replace the valve cap.

5. Repeat this procedure for each tire, including the spare.

Note: *Some spare tires operate at a higher inflation pressure than the other tires. For T type mini-spare tires, (see the Dissimilar spare wheel and tire assembly information for a description. Store and maintain at 60 psi (4.15 bar). For full-size and dissimilar spare tires, see the Dissimilar spare wheel and tire assembly information for a description. Store and maintain at the higher of the front and rear inflation pressure as shown on the Safety Compliance Certification Label or Tire Label.*

6. Visually inspect the tires to make sure there are no nails or other objects embedded that could poke a hole in the tire and cause an air leak.

7. Check the sidewalls to make sure there are no gouges, cuts or bulges.

Tire Inflation Information



WARNING: An inflated tire and rim can be very dangerous if improperly used, serviced or maintained. To reduce the risk of serious injury, never attempt to re-inflate a tire which has been run flat or seriously under-inflated without first removing the tire from the wheel assembly for inspection. Do not attempt to add air to tires or replace tires or wheels without first taking precautions to protect persons and property.

All tires with Steel Carcass Plies (if equipped):

This type of tire utilizes steel cords in the sidewalls. As such, they cannot be treated like normal light truck tires. Tire service, including adjusting tire pressure, must be performed by personnel trained, supervised and equipped according to Federal Occupational Safety and Health Administration regulations. For example, during

Wheels and Tires

any procedure involving tire inflation, the technician or individual must utilize a remote inflation device, and ensure that all persons are clear of the trajectory area.

 **WARNING:** Always inflate steel carcass tires with a remote air fill with the person inflating standing at a minimum of 12 ft (3.66 m) away from the wheel and tire assembly.

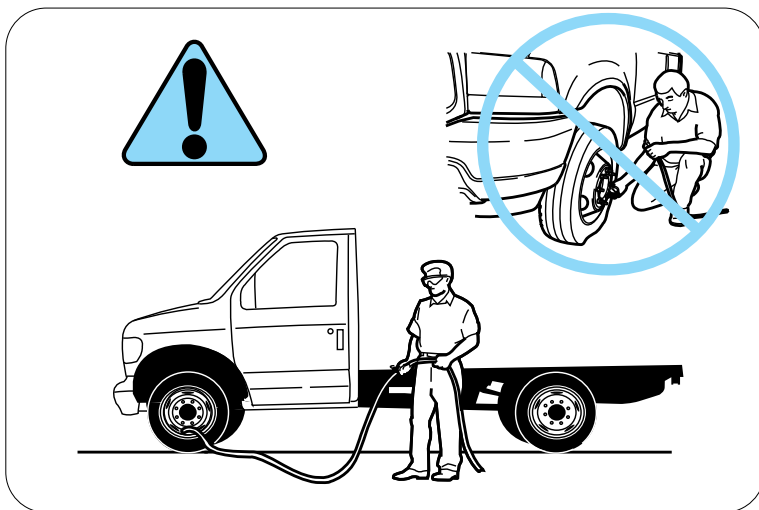

E161437

Inspecting Your Tires and Wheel Valve Stems

Periodically inspect the tire treads for uneven or excessive wear and remove objects such as stones, nails or glass that may be wedged in the tread grooves. Check the tire and valve stems for holes, cracks, or cuts that may permit air

leakage and repair or replace the tire and replace the valve stem. Inspect the tire sidewalls for cracking, cuts, bruises and other signs of damage or excessive wear. If internal damage to the tire is suspected, have the tire demounted and inspected in case

Wheels and Tires

it needs to be repaired or replaced. For your safety, tires that are damaged or show signs of excessive wear should not be used because they are more likely to blow out or fail.

Improper or inadequate vehicle maintenance can cause tires to wear abnormally. Inspect all your tires, including the spare, frequently, and replace them if one or more of the following conditions exist:

Tire Wear

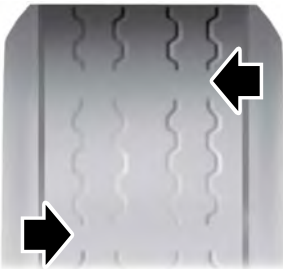

E142546

When the tread is worn down to one sixteenth of an inch (2 millimeters), tires must be replaced to help prevent your vehicle from skidding and hydroplaning. Built-in treadwear indicators, or wear bars, which look like narrow strips of smooth rubber across the tread will appear on the tire when the tread is worn down to one sixteenth of an inch (2 millimeters).

When the tire tread wears down to the same height as these wear bars, the tire is worn out and must be replaced.

Damage

Periodically inspect the tire treads and sidewalls for damage (such as bulges in the tread or sidewalls, cracks in the tread groove and separation in the tread or sidewall). If damage is observed or suspected have the tire inspected by a tire professional. Tires can be damaged during off-road use, so inspection after off-road use is also recommended.

Age



WARNING: Tires degrade over time depending on many factors such as weather, storage conditions, and conditions of use (load, speed, inflation pressure) the tires experience throughout their lives.



WARNING: In general, tires should be replaced after six years regardless of tread wear or even if they have not been used. However, heat caused by hot climates or frequent high-load conditions can accelerate the aging process and may require you to replace tires more frequently.

Wheels and Tires



WARNING: You should replace your spare tire when you replace the road tires or after six years due to aging even if it has not been used.

U.S. DOT Tire Identification Number

Both United States and Canada Federal regulations require tire manufacturers to place standardized information on the sidewall of all tires. This information identifies and describes the fundamental characteristics of the tire and also provides a U.S. DOT Tire Identification Number for safety standard certification and in case of a recall.

This begins with the letters DOT and indicates that the tire meets all federal standards. The next two numbers or letters are the plant code designating where it was manufactured, the next two are the tire size code and the last four numbers represent the week and year the tire was built. For example, the numbers 317 mean the 31st week of 1997. After 2000 the numbers go to four digits. For example, 2501 means the 25th week of 2001. The numbers in between are identification codes used for traceability. This information is used to contact customers if a tire defect requires a recall.

Tire Replacement Requirements

Your vehicle is equipped with tires designed to provide a safe ride and handling capability.



WARNING: Only use replacement tires and wheels that are the same size, load index, speed rating and type (such as P-metric versus LT-metric or all-season versus all-terrain) as those originally provided by Ford. The recommended tire and wheel size may be found on either the Safety Compliance Certification Label (affixed to either the door hinge pillar, door-latch post, or the door edge that meets the door-latch post, next to the driver's seating position), or the Tire Label which is located on the B-Pillar or edge of the driver's door. If this information is not found on these labels, then you should contact your authorized dealer as soon as possible. Use of any tire or wheel not recommended by Ford can affect the safety and performance of your vehicle, which could result in an increased risk of loss of vehicle control, vehicle rollover, personal injury and death.

Wheels and Tires



WARNING: To reduce the risk of serious injury, when mounting replacement tires and wheels, you should not exceed the maximum pressure indicated on the sidewall of the tire to set the beads without additional precautions listed below. If the beads do not seat at the maximum pressure indicated, re-lubricate and try again. When inflating the tire for mounting pressures up to 20 psi (1.38 bar) greater than the maximum pressure on the tire sidewall, the following precautions must be taken to protect the person mounting the tire:

1. Make sure that you have the correct tire and wheel size.
2. Lubricate the tire bead and wheel bead seat area again.
3. Stand at a minimum of 12 ft (3.66 m) away from the wheel and tire assembly.
4. Use both eye and ear protection.



WARNING: For a mounting pressure more than 20 psi (1.38 bar) greater than the maximum pressure, a Ford dealer or other tire service professional should do the mounting.



WARNING: Always inflate steel carcass tires with a remote air fill with the person inflating standing at a minimum of 12 ft (3.66 m) away from the wheel and tire assembly.

Important: Remember to replace the wheel valve stems when the road tires are replaced on your vehicle.

The two front tires or two rear tires should generally be replaced as a pair.

The tire pressure sensors mounted in the wheels are not designed to be used in aftermarket wheels.

The use of wheels or tires not recommended by Ford Motor Company may affect the operation of your tire pressure monitoring system.

If the tire pressure monitoring system indicator is flashing, the system is malfunctioning. Your replacement tire might be incompatible with your tire pressure monitoring system, or some component of the system may be damaged.

Wheels and Tires

Replacing a Tire That is Greenhouse Gas Certified

The tires installed on this vehicle at the factory as original equipment are certified for Greenhouse Gas and Fuel Efficiency regulations. Replacement tires must be of equal or lower rolling resistance level (TRRL or Crr). Consult with your tire supplier(s) for appropriate replacement tires.

Safety Practices



WARNING: If your vehicle is stuck in snow, mud or sand, do not rapidly spin the tires; spinning the tires can tear the tire and cause an explosion. A tire can explode in as little as three to five seconds.



WARNING: Do not spin the wheels at over 34 mph (55 km/h). The tires may fail and injure a passenger or bystander.

Driving habits have a great deal to do with your tire mileage and safety.

- *Observe posted speed limits.
- *Avoid fast starts, stops and turns.
- *Avoid potholes and objects on the road.
- *Do not run over curbs or hit the tire against a curb when parking.

Highway Hazards

No matter how carefully you drive there's always the possibility that you may eventually have a flat tire on the highway. Drive slowly to the closest safe area out of traffic. This may further damage the flat tire, but your safety is more important.

If you feel a sudden vibration or ride disturbance while driving, or you suspect your tire or vehicle has been damaged, immediately reduce your speed. Drive with caution until you can safely pull off the road. Stop and inspect the tires for damage. If a tire is under-inflated or damaged, deflate it, remove wheel and replace it with your spare tire and wheel. If you cannot detect a cause, have the vehicle towed to the nearest repair facility or tire dealer to have the vehicle inspected.

Tire and Wheel Alignment

A bad jolt from hitting a curb or pothole can cause the front end of your vehicle to become misaligned or cause damage to your tires. If your vehicle seems to pull to one side when you're driving, the wheels may be out of alignment. Have an authorized dealer check the wheel alignment periodically.

Wheels and Tires

Wheel misalignment in the front or the rear can cause uneven and rapid treadwear of your tires and should be corrected by an authorized dealer. Front-wheel drive vehicles and those with an independent rear suspension may require alignment of all four wheels.

The tires should also be balanced periodically. An unbalanced tire and wheel assembly may result in irregular tire wear.

Tire Rotation



WARNING: If the tire label shows different tire pressures for the front and rear tires and the vehicle has a tire pressure monitoring system, then you need to update the settings for the system sensors. Always perform the system reset procedure after tire rotation. If you do not reset the system, it may not provide a low tire pressure warning when necessary.

Note: If your tires show uneven wear ask an authorized dealer to check for and correct any wheel misalignment, tire imbalance or mechanical problem involved before tire rotation.

Note: Your vehicle may be equipped with a dissimilar spare wheel and tire assembly. A dissimilar spare wheel and tire assembly is defined as a spare wheel and tire assembly that is different in brand, size or appearance from the road tires and wheels. If you have a dissimilar spare wheel and tire assembly it is intended for temporary use only and should not be used in a tire rotation.

Note: After having your tires rotated, inflation pressure must be checked and adjusted to the vehicle requirements.

Rotating your tires at the recommended interval (as indicated in the Scheduled Maintenance chapter) will help your tires wear more evenly, providing better tire performance and longer tire life. Sometime irregular tire wear can be corrected by rotating the tires.

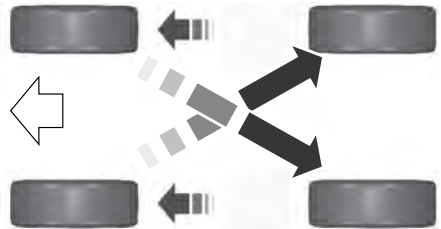

E142548

Rear-wheel drive vehicles and four-wheel drive vehicles (front tires at left of diagram).

Wheels and Tires

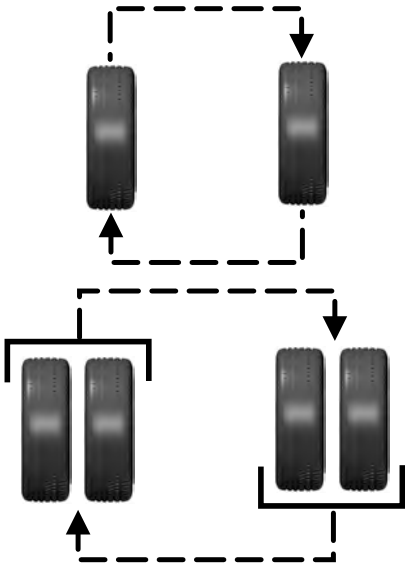

E166988

Dual rear wheel drive vehicle - six tire rotation (front tires at top of diagram).

If your vehicle is equipped with dual rear wheels it is recommended that the front and rear tires (in pairs) be rotated only side to side. We do not recommend splitting up the dual rear wheels. Rotate them side to side as a set. After tire rotation, inflation pressures must be adjusted for the tires new positions in accordance with vehicle requirements.

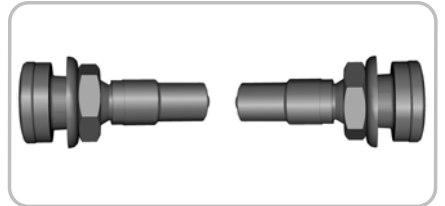

E227387

Note: When installing 17-inch dual rear wheels, align the valve stems facing each other.

USING SNOW CHAINS



WARNING: Snow tires must be the same size, load index and speed rating as those originally provided by Ford. Use of any tire or wheel not recommended by Ford can affect the safety and performance of your vehicle, which could result in an increased risk of loss of control, vehicle rollover, personal injury and death. Additionally, the use of

Wheels and Tires

non-recommended tires and wheels can cause steering, suspension, axle, transfer case or power transfer unit failure.

Follow the Ford recommended tire inflation pressure found on the Safety Compliance Certification Label (on the door hinge pillar, door latch post or the door edge that meets the door latch post, next to the driver seat), or Tire Label on the B-Pillar or the edge of the driver door. Failure to follow the tire pressure recommendations can cause uneven treadwear patterns and adversely affect the way your vehicle handles.



WARNING: Do not use snow chains on snow-free roads.

Note: Do not use snow chains on vehicles with LT275/65R20 or LT 285/75R18 sized tires.

The tires on your vehicle have all-weather treads to provide traction in rain and snow. However, in some climates, you may need to use snow tires and cables. If you need to use cables, we recommend that you use steel wheels of the same size and specification, as cables may chip aluminum wheels.

Note: The suspension insulation and bumpers will help prevent vehicle damage. Do not remove these components from your vehicle when using snow tires and chains.

Follow these guidelines when using snow tires and chains:

- If possible, avoid fully loading your vehicle.
- Use only SAE Class S chains.
- Install chains securely, verifying that the chains do not touch any wiring, brake lines or fuel lines.
- Only install snow chains on the rear axle.

- For Dual Rear Wheel (DRW) vehicles, only install snow chains on the outer wheel of each pair.
- Drive cautiously. If you hear the chains rub or bang against your vehicle, stop and retighten the chains. If this does not work, remove the chains to prevent damage to your vehicle.
- Remove the tire chains when you no longer need them. Do not use tire chains on dry roads.

If you have any questions regarding snow chains or cables, please contact your authorized dealer.

TIRE PRESSURE MONITORING SYSTEM

Vehicle Tire Pressure Monitoring System



WARNING: The tire pressure monitoring system is not a substitute for manually checking tire pressures. You should periodically check tire pressures using a pressure gauge. Failure to correctly maintain tire pressures could increase the risk of tire failure, loss of control, vehicle rollover and personal injury.



Check each tire, including the spare, if provided, monthly when cold and inflated to the inflation pressure recommended by the vehicle manufacturer on the vehicle placard or tire inflation pressure label. If your vehicle has tires of a different size than the size indicated on the vehicle placard or tire inflation pressure label, you should determine the proper tire inflation pressure for those tires.

Wheels and Tires

As an added safety feature, your vehicle has been equipped with a Tire Pressure Monitoring System (TPMS) that illuminates a low tire pressure telltale when one or more of your tires is significantly under-inflated. Accordingly, when the low tire pressure telltale illuminates, you should stop and check your tires as soon as possible, and inflate them to the proper pressure. Driving on a significantly under-inflated tire causes the tire to overheat and can lead to tire failure. Under-inflation also reduces fuel efficiency and tire tread life, and may affect the vehicle's handling and stopping ability.

Please note that the TPMS is not a substitute for proper tire maintenance, and it is the driver's responsibility to maintain correct tire pressure, even if under-inflation has not reached the level to trigger illumination of the TPMS low tire pressure telltale.

Your vehicle has also been equipped with a TPMS malfunction indicator to indicate when the system is not operating properly. The TPMS malfunction indicator is combined with the low tire pressure telltale. When the system detects a malfunction, the telltale flashes for approximately one minute and then remains continuously illuminated. This sequence continues upon subsequent vehicle start-ups as long as the malfunction exists.

When the malfunction indicator is illuminated, the system may not be able to detect or signal low tire pressure as intended. TPMS malfunctions may occur for a variety of reasons, including the installation of replacement or alternate tires or wheels on the vehicle that prevent the TPMS from functioning properly.

Always check the TPMS malfunction telltale after replacing one or more tires or wheels on your vehicle to ensure that the replacement or alternate tires and wheels allow the TPMS to continue to function properly.

This device complies with Part 15 of the FCC Rules and with Industry Canada license-exempt RSS standard(s). Operation is subject to the following two conditions:

- This device may not cause harmful interference.
- This device must accept any interference received, including interference that may cause undesired operation.

Note: *Changes or modifications not expressly approved by the party responsible for compliance could void the user's authority to operate the equipment. The term "IC" before the radio certification number only signifies that Industry Canada technical specifications were met.*

Changing Tires with a Tire Pressure Monitoring System



E142549

Wheels and Tires

Note: Each road tire is equipped with a tire pressure sensor located inside the wheel and tire assembly cavity. The pressure sensor is attached to the valve stem. The pressure sensor is covered by the tire and is not visible unless the tire is removed. Take care when changing the tire to avoid damaging the sensor.

You should always have your tires serviced by an authorized dealer.

Periodically check the tire pressure, at least monthly, using an accurate tire gauge. See *Inflating Your Tires* in this chapter.

Understanding Your Tire Pressure Monitoring System

Single Rear Wheel



Dual Rear Wheel



The tire pressure monitoring system measures pressure in your road tires and sends the tire pressure readings to your vehicle. The low tire pressure warning light turns on if the tire pressure is significantly low. Once the light is illuminated, one or more of your tires are under-inflated and needs to be inflated to the manufacturer's recommended tire pressure. Even if the light turns on and a short time later turns off, your tire pressure still needs to be checked.

When Your Temporary Spare Tire is Installed

When you need to replace one of your road tires with the temporary spare, the system continues to identify an issue to remind you to repair the damaged road wheel and tire assembly and put it back on your vehicle.

To restore the full function of the tire pressure monitoring system, have the damaged road wheel and tire assembly repaired and remounted on your vehicle.

When You Believe Your System is Not Operating Properly

The main function of the tire pressure monitoring system is to warn you when your tires need air. It can also warn you in the event the system is no longer capable of functioning as intended. See the following chart for information concerning your tire pressure monitoring system:

Wheels and Tires

Low Tire Pressure Warning Light	Possible Cause	Customer Action Required
Solid warning light	Tire under inflated	Make sure tires are at the proper pressure. See <i>Inflating Your Tires</i> in this chapter. After inflating your tires to the manufacturer's recommended pressure as shown on the Tire Label, located on the edge of driver door or the B-Pillar, you must drive your vehicle for at least two minutes over 20 mph (32 km/h) before the light turns off.
	Spare tire in use	Repair the damaged road wheel and tire assembly and reinstall it on the vehicle to restore system function. For a description on how the system functions, see <i>When your temporary spare tire is installed</i> in this section.
	Tire pressure monitoring system malfunction	If the tires are properly inflated and the spare tire is not in use but the light remains on, contact your authorized dealer as soon as possible.
	Tire rotation without sensor training	On vehicles with different front and rear tire pressures, the system must be retrained following every tire rotation. See Tire Care (page 397).
Flashing warning light	Spare tire in use	Repair the damaged road wheel and tire assembly and reinstall it on the vehicle to restore system function. For a description on how the system functions, see <i>When your temporary spare tire is installed</i> in this section.
	Tire pressure monitoring system malfunction	If the tires are properly inflated and the spare tire is not in use but the light remains on, contact your authorized dealer as soon as possible.

Wheels and Tires

When Inflating Your Tires

When putting air into your tires, such as at a gas station or in your garage, the tire pressure monitoring system may not respond immediately to the air added to your tires.

It may take up to two minutes of driving over 20 mph (32 km/h) for the light to turn off after you have filled your tires to the recommended inflation pressure.

How Temperature Affects Your Tire Pressure

The tire pressure monitoring system monitors tire pressure in each pneumatic tire. When driving in a normal manner, a typical passenger tire inflation pressure may increase about 2–4 psi (14–28 kPa) from a cold start situation. If the vehicle is stationary overnight with the outside temperature significantly lower than the daytime temperature, the tire pressure may decrease about 3 psi (21 kPa) for a drop of 30°F (17°C) in ambient temperature. This lower pressure value may be detected by the tire pressure monitoring system as being significantly lower than the recommended inflation pressure and activate the system warning light for low tire pressure.

If the low tire pressure warning light is on, visually check each tire to verify that no tire is flat. If one or more tires are flat, repair as necessary. Check the air pressure in the road tires. If any tire is under-inflated, carefully drive the vehicle to the nearest location where air can be added to the tires. Inflate all the tires to the recommended inflation pressure.

Tire Pressure Monitoring System Reset Procedure



WARNING: To determine the required pressure(s) for your vehicle, see the Safety Compliance Certification Label (on the door hinge pillar, door-latch post or the door edge that meets the door-latch post, next to the driver seat) or the Tire Label on the B-Pillar or the edge of the driver door.

Note: You need to perform the tire pressure monitoring system reset procedure after each tire rotation.

To provide the vehicle's load carrying capability, some vehicles require different recommended tire pressures in the front tires as compared to the rear tires. The tire pressure monitoring system equipped on these vehicles is designed to illuminate the low tire pressure warning light at two different pressures; one for the front tires and one for the rear tires.

Since tires need to be rotated to provide consistent performance and maximum tire life, the tire pressure monitoring system needs to know when the tires are rotated to determine which set of tires are on the front and which are on the rear. With this information, the system can detect and properly warn of low tire pressures.

System reset tips:

Wheels and Tires

- To reduce the chances of interference from another vehicle, perform the system reset procedure at least 3 ft (1 m) away from another Ford Motor Company vehicle undergoing the system reset procedure at the same time.
 - Do not wait more than two minutes between resetting each tire sensor or the system can time-out and you have to repeat the entire procedure on all four wheels.
 - A double horn sounds indicating the need to repeat the procedure.
5. Train the tire pressure monitoring system sensors in the tires using the following system reset sequence starting with the left front tire in the following clockwise order: Left front - driver side front tire, Right front - passenger side front tire, Right rear - driver side rear tire.
 6. Remove the valve cap from the valve stem on the left front tire. Decrease the air pressure until the horn sounds.

Note: *The single horn tone confirms that the sensor identification code has been learned by the module for this position. If a double horn is heard, the reset procedure was unsuccessful, and you must repeat it.*

Performing the System Reset Procedure - Single Rear Wheel

Read the entire procedure before attempting.

1. Drive the vehicle above 20 mph (32 km/h) for at least two minutes, then park in a safe location where you can easily get to all four tires and have access to an air pump.
2. Place the ignition in the off position and keep the key in the ignition.
3. Cycle the ignition to the on position with the engine off.
4. Turn the hazard flashers on then off three times. You must accomplish this within 10 seconds. If you successfully enter the reset mode, the horn sounds once, the system indicator flashes and a message shows in the information display. If this does not occur, please try again starting at step 2. If after repeated attempts to enter the reset mode, the horn does not sound, the system indicator does not flash and no message shows in the information display, seek service from your authorized dealer.
7. Remove the valve cap from the valve stem on the right front tire. Decrease the air pressure until the horn sounds.
8. Remove the valve cap from the valve stem on the right rear tire. Decrease the air pressure until the horn sounds.
9. Remove the valve cap from the valve stem on the left rear tire. Decrease the air pressure until the horn sounds. Training is complete after the horn sounds for the last tire trained, driver side rear tire, the system indicator stops flashing, and a message shows in the information display.
10. Turn the ignition off. If two short horn beeps are heard, the reset procedure was unsuccessful and you must repeat it. If after repeating the procedure and two short beeps are heard when the ignition is turned to off, seek assistance from your authorized dealer.

Wheels and Tires

11. Set all four tires to the recommended air pressure as indicated on the Safety Compliance Certification Label, affixed to either the door hinge pillar, door-latch post, or the door edge that meets the door-latch post, next to the driver seating position or Tire Label located on the B-Pillar or the edge of the driver door.
5. Train the tire pressure monitoring system sensors in the tires using the following system reset sequence starting with the left front tire in the following order: Left front - driver side front tire, Right front - passenger side front tire, Right outer rear -passenger side rear outer tire, Right inner rear - passenger side rear inner tire, Left outer rear - driver side rear outer tire, Left inner rear - driver side rear inner tire.

Performing the System Reset Procedure - Dual Rear Wheel

For further information see

Understanding Your Tire Pressure Monitoring System and refer to **Dual Rear Wheel**, earlier in this section.

Read the entire procedure before attempting.

1. Drive the vehicle above 20 mph (32 km/h) for at least two minutes, then park in a safe location where you can easily get to all six tires and have access to an air pump.
 2. Place the ignition in the off position and keep the key in the ignition.
 3. Cycle the ignition to the on position with the engine off.
 4. Turn the hazard flashers on then off three times. You must accomplish this within 10 seconds. If you successfully enter the reset mode, the horn sounds once, the system indicator flashes and a message shows in the information display. If this does not occur, please try again starting at step 2. If after repeated attempts to enter the reset mode, the horn does not sound, the system indicator does not flash and no message shows in the information display, seek service from your authorized dealer.
 5. Remove the valve cap from the valve stem on the left front tire. Decrease the air pressure until the horn sounds.
- Note:** *The single horn chirp confirms that the sensor identification code has been learned by the module for this position. If a double horn is heard, the reset procedure was unsuccessful, and you must repeat it.*
7. Remove the valve cap from the valve stem on the right front tire. Decrease the air pressure until the horn sounds.
 8. Remove the valve cap from the valve stem on the right outer rear tire. Decrease the air pressure until the horn sounds.
 9. Remove the valve cap from the valve stem on the right inner rear tire. Decrease the air pressure until the horn sounds.
 10. Remove the valve cap from the valve stem on the left outer rear tire. Decrease the air pressure until the horn sounds.
 11. Remove the valve cap from the valve stem on the left inner rear tire. Decrease the air pressure until the horn sounds. Training is complete after the horn sounds for the last tire trained, the system indicator stops flashing, and a message is shown in the information display.

Wheels and Tires

- Turn the ignition off. If two short horn beeps are heard, the reset procedure was unsuccessful and you must repeat it. If after repeating the procedure and two short beeps are heard when the ignition is turned off, seek assistance from your authorized dealer.
- Set all six tires to the recommended air pressure as indicated on the Safety Compliance Certification Label, affixed to either the door hinge pillar, door-latch post, or the door edge that meets the door-latch post, next to the driver seating position or Tire Label located on the B-Pillar or the edge of the driver door.

Trailer Tire Pressure Monitoring System (If Equipped)

Note: Additional equipment may be required for your vehicle to support trailer tire pressure monitoring. See your authorized dealer for more information.

Note: The trailer tire pressure monitoring system is not a substitute for proper tire maintenance. It is your responsibility to maintain correct tire pressures at all times.

Note: If a trailer tire is repaired, replaced or broken down for service, the screw and valve on the trailer tire pressure sensor should be replaced. See your authorized dealer for details.

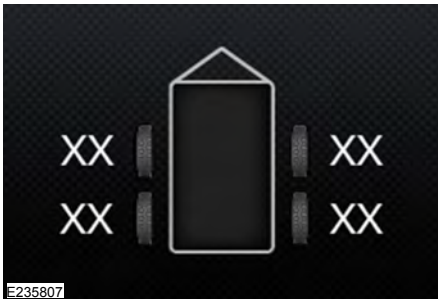

The trailer tire pressure monitoring system is an added safety feature that allows you to view your trailer tire pressures through the information display. See **General Information** (page 112). Tire pressure sensors are mounted into each tire on your trailer. The sensors send a message to your vehicle indicating the current trailer tire pressure.

If the trailer tire pressure monitoring system detects that a tire is low, a warning message appears in the information display. The trailer tire pressure status screen in the information display highlights the tire with a low pressure.

The main function of the trailer tire pressure monitoring system is to warn you when your trailer tires need air. It can also warn you in the event the system is no longer capable of functioning as intended. See **Information Messages** (page 123).

When a Temporary Spare or New Tire is Installed

If you have replaced a trailer tire with a new or spare tire, a warning message appears and pressure readings are no longer displayed for that tire.

To restore the full function of the trailer tire pressure monitoring system:

- Have the damaged wheel and tire assembly repaired and remounted to your trailer.
- Install the trailer tire pressure monitoring sensor into the new wheel and tire assembly.
- Perform the trailer tire pressure monitoring system reset procedure.

Trailer Tire Pressure Monitoring System Reset Procedure

Note: You need to perform the tire pressure monitoring system reset procedure after each tire rotation, or when a new trailer tire pressure sensor is installed into a trailer tire.

Wheels and Tires

The trailer tire pressure monitoring system can be reset through the menu in the information display. See **General Information** (page 112). Performing the trailer setup process also resets the trailer tire pressure monitoring system.

CHANGING A ROAD WHEEL



WARNING: If the tire pressure monitor sensor becomes damaged it may not function.

Note: *If your vehicle is equipped with the tire pressure monitoring system, the indicator light illuminates when the spare tire is in use. To restore the full function of the monitoring system, all road wheels equipped with tire pressure monitoring sensors must be mounted on the vehicle.*

Note: *You should only use tire sealants in roadside emergencies as they may cause damage to the tire pressure monitoring system sensor.*

If you get a flat tire when driving, do not apply the brake heavily. Instead, gradually decrease your speed. Hold the steering wheel firmly and slowly move to a safe place on the side of the road.

If your vehicle is equipped with the tire pressure monitoring system, have a flat serviced by an authorized dealer in order to prevent damage to the system sensors. See **Tire Pressure Monitoring System** (page 414). Replace the spare tire with a road tire as soon as possible. During repairing or replacing of the flat tire, have the authorized dealer inspect the system sensor for damage.

Dissimilar Spare Wheel and Tire Assembly Information



WARNING: Failure to follow these guidelines could result in an increased risk of loss of vehicle control, injury or death.

If you have a dissimilar spare wheel and tire, then it is intended for temporary use only. This means that if you need to use it, you should replace it as soon as possible with a road wheel and tire assembly that is the same size and type as the road tires and wheels that were originally provided by Ford. If the dissimilar spare tire or wheel is damaged, it should be replaced rather than repaired.

A dissimilar spare wheel and tire assembly is defined as a spare wheel and tire assembly that is different in brand, size or appearance from the road tires and wheels.

Full-size dissimilar spare

When driving with the full-size dissimilar spare wheel and tire assembly, do not:

- Exceed 70 mph (113 km/h).
- Use more than one dissimilar spare wheel and tire assembly at a time.
- Use snow chains on the end of the vehicle with the dissimilar spare wheel and tire assembly.

When driving with the full-size dissimilar spare wheel and tire assembly, 4WD functionality may be limited. You may experience the following:

- Additional noise from the transfer case or other drive components.
- Difficulty shifting out of a mechanically locked 4WD mode.

Wheels and Tires

When driving with the full-size dissimilar spare wheel and tire assembly, it is recommended that you do not:

- Exceed 50 mph (80 km/h) in 4WD.
- Engage 4WD unless the vehicle is stationary.
- Use 4WD on dry pavement.

The usage of a full-size dissimilar spare wheel and tire assembly can lead to impairment of the following:

- Handling, stability and braking performance.
- Comfort and noise.
- Ground clearance and parking at curbs.
- Winter weather driving capability.
- Wet weather driving capability.
- Four-wheel drive capability.

When driving with the full-size dissimilar spare wheel and tire assembly additional caution should be given to:

- Towing a trailer.
- Driving vehicles equipped with a camper body.
- Driving vehicles with a load on the cargo rack.

Drive cautiously when using a full-size dissimilar spare wheel and tire assembly and seek service as soon as possible.

Location of the Spare Tire and Tools

If your vehicle is equipped with a spare tire, jack and associated tools, see the following table for their locations:

Item	Location
Spare tire - pick-up trucks only	Under the vehicle, just forward of the rear bumper.
Jack	Fastened to the floor pan behind the rear-most seat on the passenger side.
Jack handle, lug wrench, lug wrench extension - only provided on dual rear wheel vehicles.	Regular Cab: Fastened to floor behind the driver seat. Super Cab and Crew Cab: Fastened to the floor under the rear seat on the driver's side.

Tire Change Procedure



WARNING: The jack supplied with this vehicle is only intended for changing wheels. Do not use the vehicle jack other than when you are changing a wheel in an emergency.

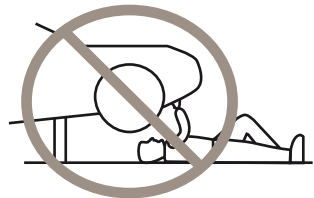

E166722

Wheels and Tires



WARNING: To help prevent your vehicle from moving when changing a wheel, shift the transmission into park (P), set the parking brake and use an appropriate block or wheel chock to secure the wheel diagonally opposite to the wheel being changed. For example, when changing the front left wheel, place an appropriate block or wheel chock on the right rear wheel.



WARNING: Always use the jack provided as original equipment with your vehicle. If using a jack other than the one provided, make sure the jack capacity is adequate for the vehicle weight, including any vehicle cargo or modifications. If you are unsure if the jack capacity is adequate, contact the authorized dealer.



WARNING: Failure to follow these guidelines could result in an increased risk of loss of vehicle control, injury or death.



WARNING: Never place anything between the vehicle jack and your vehicle.



WARNING: Never place anything between the vehicle jack and the ground.



WARNING: Park your vehicle so that you do not obstruct the flow of traffic or place yourself in any danger and set up a warning triangle.



WARNING: Do not work on your vehicle when the jack is the only support as your vehicle could slip off the jack. Failure to follow this instruction could result in personal injury or death.



WARNING: Do not get under a vehicle that is only supported by a vehicle jack.



WARNING: Do not attempt to change a tire on the side of the vehicle close to moving traffic. Pull far enough off the road to avoid the danger of being hit when operating the jack or changing the wheel.



WARNING: Only use the spare wheel carrier to stow the wheel provided with your vehicle. Other wheel sizes could cause the spare wheel carrier to fail if it does not fit securely or is too heavy.

Note: Do not use impact tools or power tools operating at over 200 RPM on the spare wheel carrier winch, which may cause it to malfunction and prevent a secure fit. Override the winch at least three times (there is an audible click each time) to make sure the wheel and tire fit securely.

Note: Passengers should not remain in the vehicle when the vehicle is being jacked.

1. Park the vehicle on a level firm ground and activate the hazard flashers.
2. Apply the parking brake, place the transmission in park (P), switch the engine off.
3. Block the wheel diagonally opposite the flat tire. For example, if the left front tire is flat, block the right rear wheel.

Wheels and Tires

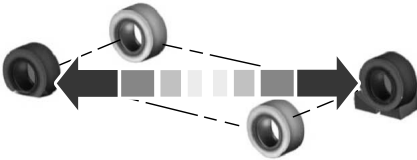

E175447

4. You can find the jack on the floor behind the rear-most seat on the passenger side. Turn the retainers counterclockwise to remove the jack.

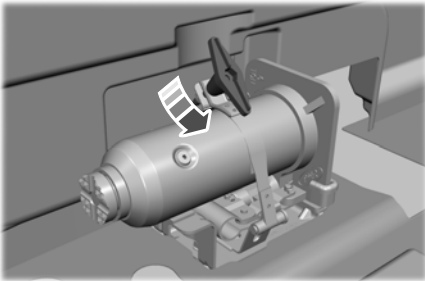

5. You can find the tool kit on the floor under the driver seat for regular cab or under the rear seat on the driver side. Turn the retainers counterclockwise to remove the tool kit.

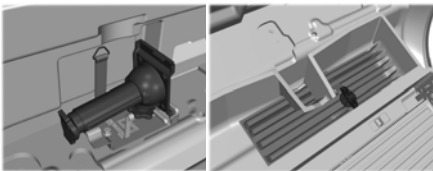

6. Use the ignition key to open the lock at the rear bumper.

7. One or more handle extensions are used to operate the spare tire carrier. To assemble, align the button with the hole and slide the parts together. To disconnect, press the button and pull apart.

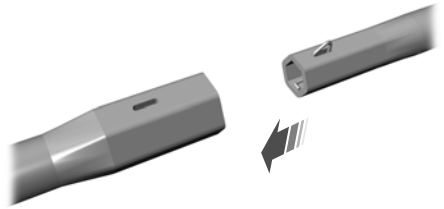

8. The lug wrench is used to turn the handle extensions and the jack handle; slide the square end of the handle extension into the square hold of the lug wrench until it clicks in place.

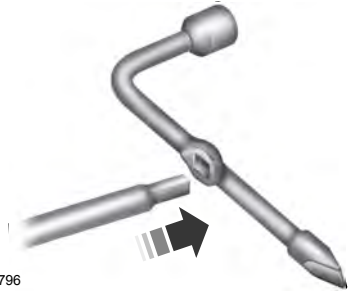

E162796

9. Fully insert the jack handle, with one extension, through the bumper hole and into the guide tube. Additional extensions will be needed if the tailgate is in the lowered position and cannot be raised. Turn the handle counterclockwise and lower the spare tire until you can slide the tire rearward

Wheels and Tires

and the cable is slack. You will feel some resistance when you turn the jack handle assembly. If not replacing the spare or flat tire to the underbody storage area, raise the wheel retainer up into the installed position.

- Slide the retainer through the center of the spare tire wheel and remove the spare tire.



- Remove the wheel trim with lug wrench tip.
- Loosen each wheel lug nut one-half turn counterclockwise, but do not remove them until the wheel is raised off the ground. For dual rear wheel, assemble the lug wrench and extension tool together to access the lug nuts.



- Position the jack under the correct jacking points according to following pictures.

F-250 and F-350 Single Rear Wheel Vehicles



E162801



E162802

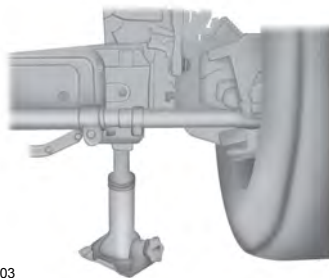

E162803

Wheels and Tires

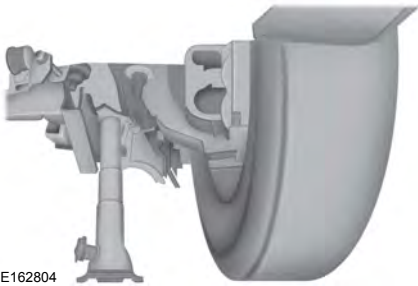

E162804

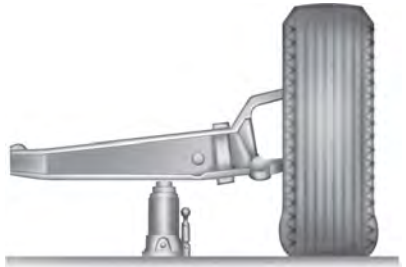

E162813

Front (4x2):F350 Dual rear wheel

Note: Place the jack directly under the I-beam.

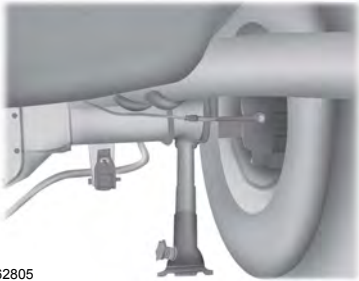

E162805

F-350 Dual Rear Wheel, F-450 and F-550 Vehicles

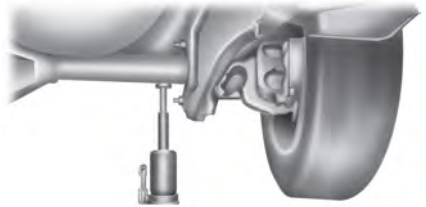

E162815

Front passenger side (4x4): F-350 dual rear wheel



E162812

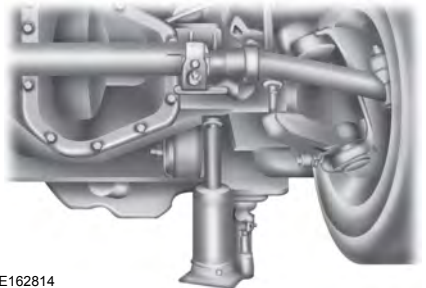

E162814

Front driver side (4x4): F-350 dual rear wheel

Wheels and Tires

Note: Make sure the jack fits onto the flat area on the outboard side of the differential housing.

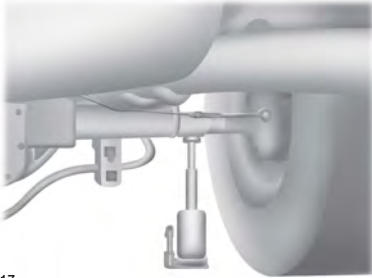

E162817

Rear: F-350 dual rear wheel

Insert the hooked end of the jack handle into the jack and turn the jack handle clockwise. For hydraulic jacks, operate the handle up-and-down until the wheel is completely off the ground and high enough to install the spare tire.

Note: Hydraulic jacks have a pressure relief valve that prevents lifting loads which exceed the jack's rated capacity.

F-250 and F-350 Single Rear Wheel Vehicles



E162811

F-350 Dual Rear Wheel Vehicles

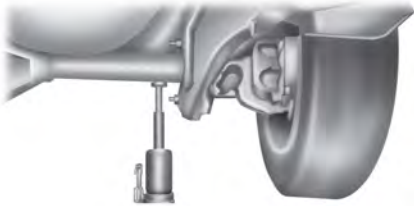

E162816

Front: F-450 and F-550

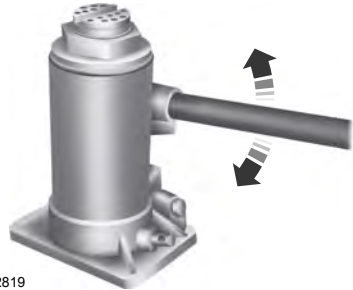

E162819

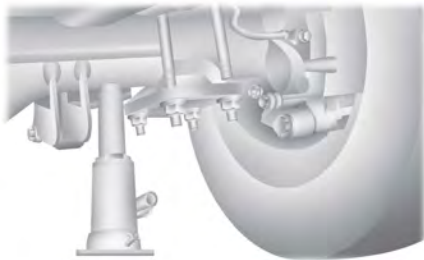

E162818

Rear: F-450 and F-550

Wheels and Tires

Remove the lug nuts with the lug wrench, replace the flat tire with the spare, making sure the valve stem of the spare is facing outward when replacing a front wheel. For the rear wheel position on vehicles with single rear wheel fitments, install the spare with the valve stem facing outward. For vehicles with dual rear wheels, the valve stem of the spare must face outward when replacing an inner wheel, but must face inward when replacing an outboard wheel.

Reinstall the lug nuts until the wheel is snug against the hub. Do not fully tighten the lug nuts until the wheel has been lowered.

Lower the vehicle completely by turning the jack handle counterclockwise until the vehicle is completely lowered.

Note: For F-350 Dual Rear Wheel, F-450 and F-550 Vehicles, insert the notched end of the jack handle to the release valve, open the release valve slightly by turning the handle counterclockwise. Stop turning the release valve when vehicle start to lower. Make sure to close the valve when you completely lower your vehicle.

F-350 Dual Rear Wheel, F-450 and F-550 Vehicles.

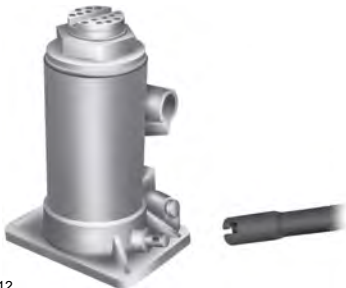

E162812

Installing the lug Nuts and Ornaments



E161441

8-lug nut torque sequence



E169375

10-lug nut torque sequence

Note: When installing the wheel center ornaments, make sure that the ornament retention towers on the back side of the ornament are aligned with the studs or nuts and retain to the flange on the lug nuts.

Wheels and Tires

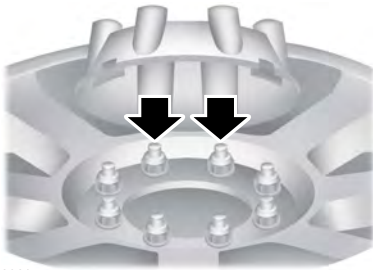

E162820

Note: For dual rear wheel, align the ornament with the lug nuts. A is the clip and B is the flange, make sure all of the retention clips are sitting on the flange of the lug nuts.

Use your hand or a rubber mallet to tap the ornament onto the wheel with in a star pattern until it is retained with an even gap all around between the ornament and the wheel. There should be an even gap between the ornament and the wheel.

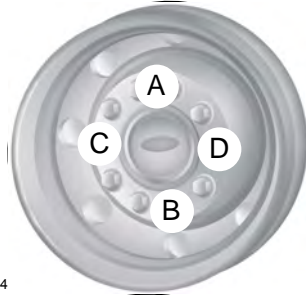

E162824

Stowing the Flat Tire or Spare Tire

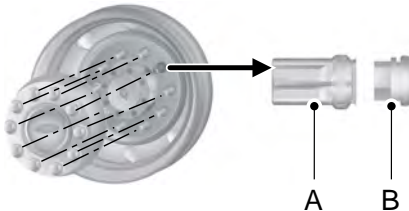

E162822

Note: Be sure to install all the clips on the nuts over the flanges so that there is an even gap all around the retention clips are fully seated.

1. Place the tire on end with the valve stem facing toward the front of the vehicle. Lay the tire on the ground, near the rear of the vehicle, with the valve stem side facing up.

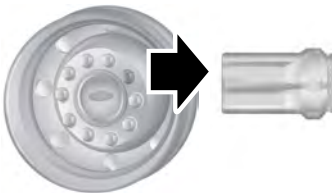

E162823



E162800

Wheels and Tires

- Slide the wheel partially under the vehicle and install the retainer through the wheel center. If equipped, you may have to remove the wheel center cap prior to pushing the retainer through the center of the wheel. To remove the center cap, press it off with the lug wrench tip from the inner side of the wheel. Pull on the cable to align the components at the end of the cable.
- Turn the lug wrench clockwise until the tire is raised to its stowed position underneath the vehicle. The wrench will become harder to turn and the spare tire winch will ratchet or slip when the tire is raised to maximum tightness. You will hear a clicking sound from the winch indicating that the tire is properly stowed. Check that the tire lies flat against the frame and is properly tightened.
- Carefully place all tools back in the tool kit bag.
- Reinstall the tool kit bag and tighten the wing nut.
- Properly reinstall the jack into the bracket and tighten the wing nut.

TECHNICAL SPECIFICATIONS

Wheel Lug Nut Torque Specifications



WARNING: When you install a wheel, always remove any corrosion, dirt or foreign materials present on the mounting surfaces of the wheel or the surface of the wheel hub, brake drum or brake disc that contacts the wheel. Make sure to secure any fasteners that attach the rotor to the hub so they do not interfere with the mounting surfaces of the wheel. Installing wheels without correct metal-to-metal contact at the wheel mounting surfaces can cause the wheel nuts to loosen and the wheel to come off while your vehicle is in motion, resulting in loss of vehicle control, personal injury or death.

Bolt size	lb.ft (Nm)
M14 x 1.5	150 lb.ft (204 Nm)

*Torque specifications are for nut and bolt threads free of dirt and rust. Use only Ford recommended replacement fasteners.

On vehicles equipped with single rear wheels, retighten the lug nuts to the specified torque at 100 miles (160 kilometers) after any wheel disturbance (such as tire rotation, changing a flat tire, wheel removal).

On vehicles equipped with dual rear wheels, retighten the wheel lug nuts to the specified torque at 100 miles (160 kilometers), and again at 500 miles (800 kilometers) of new vehicle operation and after any wheel disturbance (such as tire rotation, changing a flat tire, wheel removal).

It is important to follow the proper wheel mounting and lug nut torque procedures.

Wheels and Tires



E145950

A Wheel pilot bore

Inspect the wheel pilot hole and mounting surface prior to installation. Remove any visible corrosion or loose particles.

Capacities and Specifications

ENGINE SPECIFICATIONS - 6.2L

Engine	6.2L V8 Engine
Displacement.	379 in ³ (6,210 cm ³)
Required fuel.	Minimum 87 octane
Firing order.	1-5-4-8-6-3-7-2
Ignition system.	Coil on plug
Spark plug gap.	0.041 in (1.04 mm) - 0.047 in (1.2 mm)
Compression ratio.	9.8:1

Drivebelt Routing

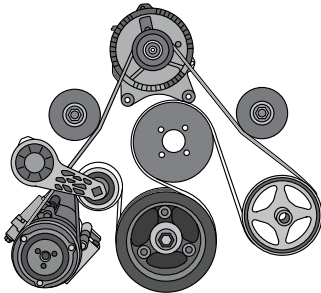

E163761

ENGINE SPECIFICATIONS - 6.7L DIESEL

Engine	6.7L V8 Diesel Engine
Displacement.	406 in ³ (6,651 cm ³)
Required fuel.	Low Sulfur Diesel up to B20
Firing order.	1-3-7-2-6-5-4-8
Compression ratio.	15.8:1

Capacities and Specifications

Drivebelt Routing Single Alternator

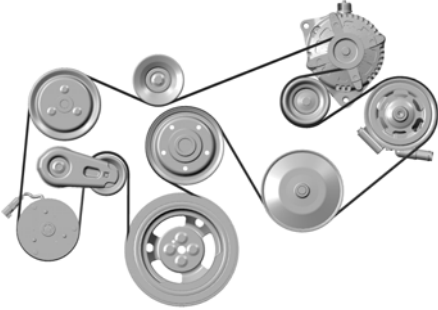

Dual Alternator

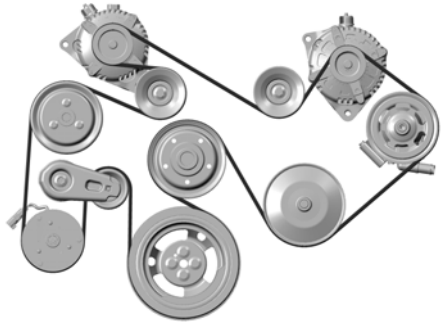

ENGINE SPECIFICATIONS - 7.3L

Engine	7.3L V8 Engine
Displacement.	445 in ³ (7,293 cm ³)
Required fuel.	Minimum 87 octane
Firing order.	1-5-4-8-6-3-7-2
Ignition system.	Coil near spark plug with spark plug wire
Spark plug gap.	0.049 in (1.25 mm) - 0.053 in (1.35 mm)
Compression ratio.	10.5:1

Capacities and Specifications

Drivebelt Routing

Single Alternator

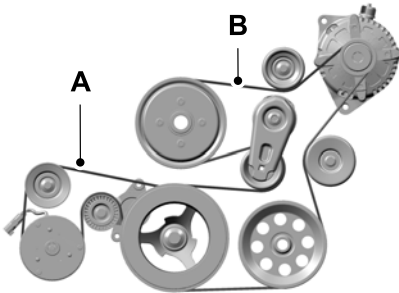

- A Drivebelt closest to the engine.
- B Drivebelt furthest from the engine.

Dual Alternator

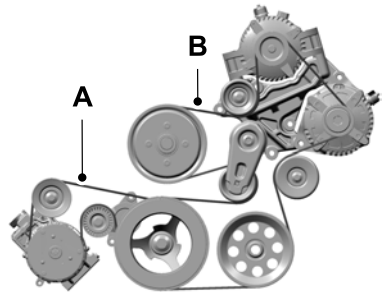

- A Drivebelt closest to the engine.
- B Drivebelt furthest from the engine.

MOTORCRAFT PARTS - 6.2L

Component	Motorcraft Part number
Air filter element.	FA-1950
Battery (XL).	BXT-65-650
Battery (all except XL).	BXT-65-750
Cabin air filter.	FP-79
Engine oil filter. ¹	FL-820-S
Spark plugs. ²	SP-526
Six-speed automatic transmission fluid filter (6R100).	FT-188

Capacities and Specifications

Component	Motorcraft Part number
Ten-speed automatic transmission fluid filter (10R140).	FT-221
Windshield wiper blades.	WW-2248

¹If a Motorcraft® oil filter is not available, use an oil filter that meets industry performance specification SAE/USCAR-36/USC-D.

²For spark plug replacement, contact your authorized dealer. Replace the spark plugs at the recommended intervals. See **Normal Scheduled Maintenance** (page 560).

We recommend Motorcraft® parts that are available at your authorized dealer or at www.fordparts.com. These parts are engineered for your vehicle, and meet or exceed our specifications. Use of other parts could impact vehicle performance, emissions and durability. Your warranty could be void for any damage related to use of other parts.

Capacities and Specifications

MOTORCRAFT PARTS - 6.7L DIESEL

Component	Motorcraft Part number
Air filter.	FA-1951
Foam pre-filter.	FA-1952
Battery (two required).	BXT-65-750
Cabin air filter.	FP-79
Engine oil filter. ¹	FL-2051-S
Fuel filter.	FD-4631
Ten-speed automatic transmission fluid filter (10R140).	FT-221
Windshield wiper blades.	WW-2248

¹If a Motorcraft® oil filter is not available, use an oil filter that meets industry performance specification SAE/USCAR-36/USC-D.

We recommend Motorcraft® parts that are available at your authorized dealer or at www.fordparts.com. These parts are engineered for your vehicle, and meet or exceed our specifications. Use of other parts could impact vehicle performance, emissions and durability. Your warranty could be void for any damage related to use of other parts.

Capacities and Specifications

MOTORCRAFT PARTS - 7.3L

Component	Motorcraft Part Number
Air filter element.	FA-1950
Battery.	BXT-65-750
Cabin air filter.	FP-79
Engine oil filter. ¹	FL-820-S
Spark plugs. ²	SP-586
Ten-speed automatic transmission fluid filter (10R140).	FT-221
Windshield wiper blades.	WW-2248

¹If a Motorcraft® oil filter is not available, use an oil filter that meets industry performance specification SAE/USCAR-36.

²For spark plug replacement, contact your authorized dealer. Replace the spark plugs at the recommended intervals. See **Normal Scheduled Maintenance** (page 560).

We recommend Motorcraft® parts that are available at your authorized dealer or at www.fordparts.com. We engineer these parts for your vehicle to meet or exceed our specifications. Use of other parts could impact vehicle performance, emissions and durability. Your warranty could be void for any damage related to use of other parts.

Capacities and Specifications

VEHICLE IDENTIFICATION NUMBER

The vehicle identification number is located on the left-hand side of the instrument panel.



E142476

Please note that in the graphic, XXXX is representative of your vehicle identification number.

The Vehicle Identification Number contains the following information:

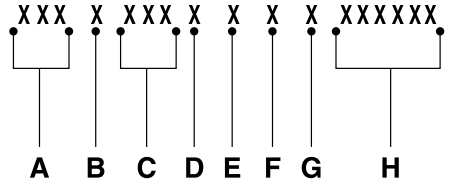

E142477

- A World manufacturer identifier
- B Brake system, Gross Vehicle Weight Rating, Restraint Devices and their locations
- C Make, vehicle line, series, body type
- D Engine type
- E Check digit
- F Model year
- G Assembly plant
- H Production sequence number

Capacities and Specifications

VEHICLE CERTIFICATION LABEL

MFD. BY FORD MOTOR CO.

DATE: XX/XX	GVWR: XXXX KG (XXXX LB)		
FRONT GAWR:	REAR GAWR:		
XXXX KG (XXXX LB)	WITH	XXXX KG (XXXX LB)	WITH
XXXXXXXXXXXXXXXXXX	TIRES	XXXXXXXXXXXXXXXXXX	TIRES
XXXXXX	RIMS	XXXXXX	RIMS
AT XXXX kPa/ XXX PSI COLD	AT	XXXX kPa/ XXX PSI COLD	

THIS VEHICLE CONFORMS TO ALL APPLICABLE FEDERAL MOTOR VEHICLE SAFETY AND THEFT PREVENTION STANDARDS IN EFFECT ON THE DATE OF MANUFACTURE SHOWN ABOVE.

VIN: XXXXXXXXXXXXXXXXXXXX XXXXX
XXXXX

TYPE: XXXX



EXT PNT:	XX	XXXXXX	RC: XX	D50: XXXX
WB	INT TR	TP/PS	TR	AXLE
XXX	XX	XXX	X	XX
			X	XXXX
		XXXXXXXXXXXXXXXXXX	XXX	XXXX-XXXXXX-XX

E167469

The National Highway Traffic Safety Administration Regulations require that a Safety Compliance Certification Label be affixed to a vehicle and prescribe where the Safety Compliance Certification Label may be located. The Safety Compliance Certification Label shall be affixed to either the door hinge pillar, the door latch post, or the edge of the door near the door latch, next to the driver's seating position.

TRANSMISSION CODE DESIGNATION

MFD. BY FORD MOTOR CO.

DATE: XX/XX	GVWR: XXXX KG (XXXX LB)		
FRONT GAWR:	REAR GAWR:		
XXXX KG (XXXX LB)	WITH	XXXX KG (XXXX LB)	WITH
XXXXXXXXXXXXXXXXXX	TIRES	XXXXXXXXXXXXXXXXXX	TIRES
XXXXXX	RIMS	XXXXXX	RIMS
AT XXXX kPa/ XXX PSI COLD	AT	XXXX kPa/ XXX PSI COLD	

THIS VEHICLE CONFORMS TO ALL APPLICABLE FEDERAL MOTOR VEHICLE SAFETY AND THEFT PREVENTION STANDARDS IN EFFECT ON THE DATE OF MANUFACTURE SHOWN ABOVE.

VIN: XXXXXXXXXXXXXXXXXXXX XXXXX
XXXXX

TYPE: XXXX



EXT PNT:	XX	XXXXXX	RC: XX	D50: XXXX
WB	INT TR	TP/PS	TR	AXLE
XXX	XX	XXX	X	XX
			X	XXXX
		XXXXXXXXXXXXXXXXXX	XXX	XXXX-XXXXXX-XX

E167814

The transmission code is on the Safety Compliance Certification Label. The following table shows the transmission code along with the transmission description.

Description	Code
Six-speed automatic transmission 6R100.	S
Ten-speed automatic transmission 10R140.	G

Capacities and Specifications

CAPACITIES AND SPECIFICATIONS - 6.2L

Use oil and fluid that meets the defined specification and viscosity grade.

If you do not use oil and fluid that meets the defined specification and viscosity grade, it could result in:

- Component damage not covered by the vehicle warranty.
- Longer engine cranking periods.
- Increased emission levels.

- Reduced engine performance.
- Reduced fuel economy.
- Reduced brake performance.

Air Conditioning System



WARNING: The air conditioning refrigerant system contains refrigerant under high pressure. Only qualified personnel should service the air conditioning refrigerant system. Opening the air conditioning refrigerant system can cause personal injury.

Capacities

Variant	Refrigerant	Refrigerant Oil
With six-speed automatic transmission (6R100).	27 oz (0.765 kg)	4.1 fl oz (120 ml)
With ten-speed automatic transmission (10R140).	27 oz (0.765 kg)	3.7 fl oz (110 ml)

Materials

Name	Specification
Motorcraft® R-134a Refrigerant(U.S.) R-134a Refrigerant / Frigorigène R-134a(Canada) YN-19(U.S.) CYN-19-R(Canada)	WSH-M17B19-A
Motorcraft® PAG Refrigerant Compressor Oil(U.S.) Motorcraft® PAG Refrigerant Compressor Oil / Huile PAG pour compresseur frigorifique Motor- craft®(Canada) YN-12-D(U.S. & Canada)	WSH-M1C231-B

Capacities and Specifications

Automatic Transmission-Six Speed

Note: Automatic transmissions that require MERCON® LV transmission fluid should only use MERCON® LV transmission fluid. The use of any other fluid could cause transmission damage.

Capacities

Variant	Quantity
Six-speed automatic transmission (6R100).	13.9 qt (13.2 L) ¹

¹ Approximate dry fill capacity. Actual amount could vary during fluid changes.

Materials

Name	Specification
Motorcraft® MERCON® LV Automatic Transmission Fluid (U.S.) Motorcraft® MERCON® LV Automatic Transmission Fluid / Huile pour boîte automatique MERCON® LV Motorcraft® (Canada) XT-10-QLVC (U.S.) CXT-10-LV6 (Canada)	WSS-M2C938-AMERCON® LV,

Automatic Transmission-Ten Speed

Note: Automatic transmissions that require MERCON® ULV transmission fluid should only use MERCON® ULV transmission fluid. The use of any other fluid could cause transmission damage.

Capacities

Variant	Quantity
Ten-speed automatic transmission (10R140).	18.2 qt (17.2 L) ¹

¹ Approximate dry fill capacity. Actual amount could vary during fluid changes.

Capacities and Specifications

Materials

Name	Specification
Motorcraft® MERCON® ULV Automatic Transmission Fluid (U.S.) Motorcraft® MERCON® ULV Automatic Transmission Fluid / MERCON® ULV huile pour boîtes automatique Motorcraft® (Canada) XT-12-QULV (U.S. & Canada)	WSS-M2C949-A, MERCON® ULV

Engine Coolant

Capacities

Variant	Quantity
All.	24.6 qt (23.3 L)

Materials

Name	Specification
Motorcraft® Yellow Prediluted Antifreeze/Coolant (U.S.) Motorcraft® Yellow Prediluted Antifreeze/Coolant / Antigel/liquide de refroidissement prédilué jaune Motorcraft® (Canada) VC-13DL-G (U.S.) CVC-13DL-G (Canada)	WSS-M97B57-A2

Engine Oil



E142732



E276075

Capacities and Specifications

An oil that displays this symbol conforms to current engine, emission system and fuel economy performance standards of ILSAC.

Do not use supplemental engine oil additives because they are unnecessary and could lead to engine damage that your vehicle warranty does not cover.

We recommend Motorcraft® motor oil for your vehicle. If Motorcraft® oil is not available, use motor oils of the recommended viscosity grade that meet API SN PLUS requirements and display the API Certification Mark for gasoline engines.

Capacities

Variant	Including the Oil Filter
All.	7.0 qt (6.6 L)

Materials

Name	Specification
Engine Oil - SAE 5W-30 - Synthetic Blend Motor Oil(U.S.) Engine Oil - SAE 5W-30 - Super Premium Motor Oil / Huile moteur de très haute qualité SAE 5W-30 Motorcraft®(Canada) XO-5W30-Q1SP(U.S.) CXO-5W30-LSP6(Canada)	WSS-M2C946-B1

Alternative Engine Oil for Extremely Cold Climates

To improve engine cold start performance, we recommend that you use the following alternative engine oil in extremely cold climates, where the ambient temperature reaches -22.0°F (-30°C) or below.

Materials

Name	Specification
Engine Oil - SAE 0W-30	WSS-M2C953-B1

Capacities and Specifications

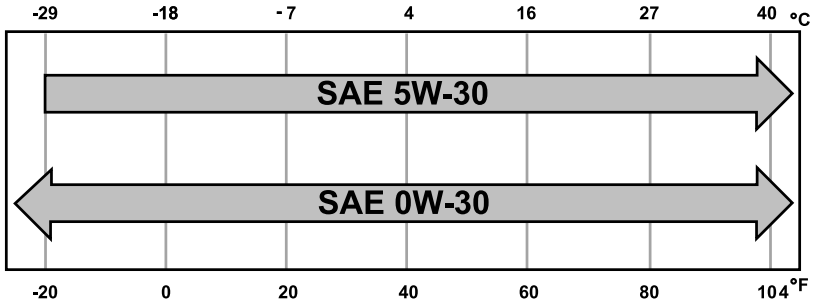

Fuel Tank

Capacities

Variant	Quantity
Complete vehicle-all except 176 inch wheelbase and incomplete vehicles.	34.0 gal (128.7 L)
Complete vehicle-176 inch wheelbase.	48.0 gal (181.7 L)
Incomplete vehicle, aft- axle -location.	40.0 gal (151.4 L)
Incomplete vehicle, middle location.	26.5 gal (100.3 L)

Grease

Capacities and Specifications

Materials

Name	Specification
Motorcraft® High Temperature 4x4 Front Axle and Wheel Bearing Grease(U.S.) Motorcraft® High Temperature 4x4 Front Axle and Wheel Bearing Grease / Graisse haute température pour roulements de roue et ponts avant 4x4 Motorcraft®(Canada) XG-11(U.S. & Canada)	WSS-M1C267-A1
Motorcraft® Multi-Purpose Grease Spray(U.S.) Motorcraft® Multi-Purpose Grease Spray / Graisse tout usage en aérosol Motorcraft®(Canada) XL-5-A(U.S. & Canada)	ESB-M1C93-B
Motorcraft® Premium Long-Life Grease(U.S.) Motorcraft® Premium Long-Life Grease / Graisse longue durée de qualité première Motorcraft®(Canada) XG-1-E1(U.S. & Canada)	ESA-M1C75-B

Hydraulic Brake System

Materials

Name	Specification
Motorcraft® DOT 4 LV High Performance Motor Vehicle Brake Fluid(U.S.) Motorcraft® DOT 4 LV High Performance Motor Vehicle Brake Fluid / Liquide de frein automobile haute performance DOT 4 LV Motorcraft®(Canada) PM-20(U.S. & Canada)	WSS-M6C65-A2

Note: *We recommend using DOT 4 Low Viscosity (LV) High Performance Brake Fluid or equivalent meeting WSS-M6C65-A2. Use of any fluid other than the recommended fluid could cause reduced brake performance and not meet our performance standards. Keep brake fluid clean and dry. Contamination with dirt, water, petroleum products or other materials could result in brake system damage and possible failure.*

Power Steering System

Capacities and Specifications

Materials

Name	Specification
Motorcraft® MERCON® LV Automatic Transmission Fluid(U.S.) Motorcraft® MERCON® LV Automatic Transmission Fluid / Huile pour boîte automatique MERCON® LV Motorcraft®(Canada) XT-10-QLVC(U.S.) CXT-10-LV6(Canada)	WSS-M2C938-AMERCON® LV,

Locks

Materials

Name	Specification
Motorcraft® Penetrating and Lock Lubricant(U.S.) Motorcraft® Penetrating Fluid / Liquide dégrissant Motorcraft®(Canada) XL-1(U.S.) CXC-51-A(Canada)	-

Transfer Case

Capacities

Variant	Quantity
All.	1.9 qt (1.8 L)

Materials

Name	Specification
Motorcraft® MERCON® LV Automatic Transmission Fluid(U.S.) Motorcraft® MERCON® LV Automatic Transmission Fluid / Huile pour boîte automatique MERCON® LV Motorcraft®(Canada) XT-10-QLVC(U.S.) CXT-10-LV6(Canada)	WSS-M2C938-AMERCON® LV,

Capacities and Specifications

Front Axle

Capacities

Variant	Quantity
Four wheel drive.	2.75 qt (2.6 L)

Materials

Name	Specification
Motorcraft® SAE 80W-90 Premium Rear Axle Lubricant(U.S.) Motorcraft® SAE 80W-90 Premium Axle Lubricant / Lubrifiant pour essieux de très haute qualité SAE 80W-90 Motorcraft®(Canada) XY-80W90-QL(U.S.) CXY-80W90-IL(Canada)	WSP-M2C197-A

Rear Axle - 10.5

Capacities

Variant	Quantity
With Electronic Locking Differential.	3.3-3.5 qt (3.1-3.3 L)
Without Electronic Locking Differential.	3.5-3.6 qt (3.3-3.4 L)

Materials

Name	Specification
Motorcraft® SAE 75W-85 Premium Synthetic Hypoid Gear Lubricant(U.S.) Motorcraft® SAE 75W-85 Premium Synthetic Hypoid Gear Lubricant / Huile synthétique de haute qualité pour engrenages hypoides SAE 75W-85 Motorcraft®(Canada) XY-75W85-QL(U.S. & Canada)	WSS-M2C942-A

Capacities and Specifications

Rear Axle - 11.8

Capacities

Variant	Quantity
All.	3.78 qt (3.58 L) ¹

¹ For complete refill of limited slip axles, add 7.1 fl. oz. (210 ml) of Additive Friction Modifier XL-3 or equivalent, meeting Ford Specification EST-M2C118-A. Include this friction modifier in the total lube volume of 3.78 qt (3.58 L).

Materials

Name	Specification
Motorcraft® Additive Friction Modifier(U.S.) Motorcraft® Additive Friction Modifier / Additif modificateur de friction Motorcraft®(Canada) XL-3(U.S.) CXL-3(Canada)	EST-M2C118-A
Motorcraft® SAE 80W-90 Premium Rear Axle Lubricant(U.S.) Motorcraft® SAE 80W-90 Premium Axle Lubricant / Lubrifiant pour essieux de très haute qualité SAE 80W-90 Motorcraft®(Canada) XY-80W90-QL(U.S.) CXY-80W90-1L(Canada)	WSP-M2C197-A

Washer Reservoir

Capacities

Variant	Quantity
All.	Fill as required.

Capacities and Specifications

Materials

Name	Specification
Motorcraft® Premium Windshield Wash Concentrate with Bitterant(U.S.) Motorcraft® Premium Quality Windshield Washer Fluid / Liquide lave-glace de haute qualité Motorcraft®(Canada) ZC-32-B2(U.S.) CXC-37-A/B/D/F(Canada)	WSS-M14P19-A

CAPACITIES AND SPECIFICATIONS - 6.7L DIESEL

Use oil and fluid that meets the defined specification and viscosity grade.

If you do not use oil and fluid that meets the defined specification and viscosity grade, it could result in:

- Component damage not covered by the vehicle warranty.
- Longer engine cranking periods.
- Increased emission levels.
- Reduced engine performance.

- Reduced fuel economy.
- Reduced brake performance.

Note: We recommend an engine block heater at temperatures below -10°F (-23°C).

Air Conditioning System



WARNING: The air conditioning refrigerant system contains refrigerant under high pressure. Only qualified personnel should service the air conditioning refrigerant system. Opening the air conditioning refrigerant system can cause personal injury.

Capacities

Variant	Refrigerant	Refrigerant Oil
All.	27 oz (0.765 kg)	3.7 fl oz (110 ml)

Capacities and Specifications

Materials

Name	Specification
Motorcraft® R-134a Refrigerant(U.S.) R-134a Refrigerant / Frigorigène R-134a(Canada) YN-19(U.S.) CYN-19-R(Canada)	WSH-M17B19-A
Motorcraft® PAG Refrigerant Compressor Oil(U.S.) Motorcraft® PAG Refrigerant Compressor Oil / Huile PAG pour compresseur frigorifique Motor- craft®(Canada) YN-12-D(U.S. & Canada)	WSH-M1C231-B

Automatic Transmission

Note: Only use MERCON® ULV transmission fluid for automatic transmissions that require MERCON® ULV transmission fluid. The use of any other fluid could cause transmission damage.

Capacities

Variant	Quantity
Ten-speed automatic transmission (10R140).	18.1 qt (17.1 L) ¹

¹ Approximate dry fill capacity. Actual amount could vary during fluid changes.

Materials

Name	Specification
Motorcraft® MERCON® ULV Automatic Transmission Fluid(U.S.) Motorcraft® MERCON® ULV Automatic Transmission Fluid / MERCON® ULV huile pour boîtes automatique Motorcraft®(Canada) XT-12-QULV(U.S. & Canada)	WSS-M2C949-A, MERCON® ULV

Capacities and Specifications

Engine Coolant

Capacities

Variant	Quantity
Primary cooling system.	31.7 qt (30 L)
Secondary cooling system.	8.1 qt (7.7 L)

Materials

Name	Specification
Motorcraft® Yellow Prediluted Antifreeze/ Coolant(U.S.) Motorcraft® Yellow Prediluted Antifreeze/Coolant / Antigel/liquide de refroidissement prédilué jaune Motorcraft®(Canada) VC-13DL-G(U.S.) CVC-13DL-G(Canada)	WSS-M97B57-A2

Engine Oil

The use of correct oil viscosities for diesel engines is important for satisfactory operation. Determine which oil viscosity best suits the temperature range you expect to encounter for the next service interval from the following SAE viscosity grade chart.

Capacities and Specifications

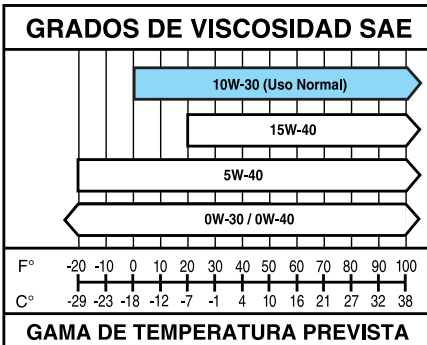
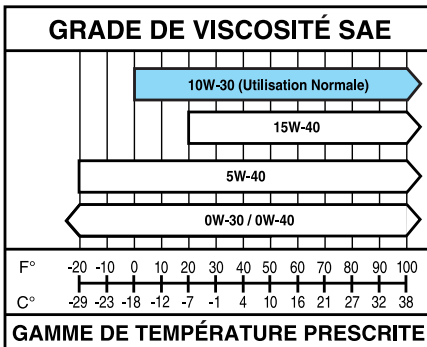
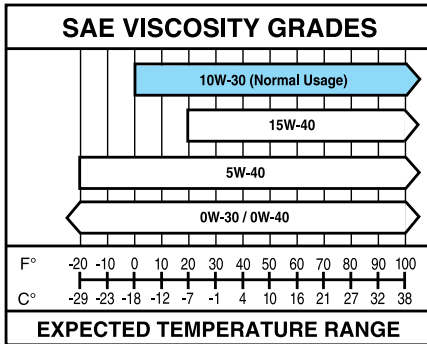

Capacities and Specifications

Capacities

Variant	Including the Oil Filter
All.	13.0 qt (12.3 L)

Materials

Name	Specification
Motorcraft® SAE 10W-30 Super Duty Diesel Motor Oil(U.S.) Motorcraft® Super Duty Motor Oil SAE 10W-30 / Huile moteur Super Duty SAE 10W-30 Motor- craft®(Canada) XO-10W30-QSDF(U.S.) CXO-10W30-LSD12(Canada)	WSS-M2C171-F1

Alternative Engine Oil for Extremely Cold Climates

To improve engine cold start performance, we recommend that you use the following alternative engine oil in extremely cold climates, where the ambient temperature reaches -22.0°F (-30°C) or below.

Materials

Name	Specification
Engine Oil - SAE 0W-40	WSS-M2C171-F1

Alternative Engine Oil for Biodiesel Fuel Blends (B20 max)

Capacities and Specifications

Materials

Name	Specification
Motorcraft® SAE 5W-40 Full Synthetic Diesel Motor Oil (U.S.) (Canada) XO-5W40-5Q3SD (U.S.)	WSS-M2C171-F1
Motorcraft® SAE 15W-40 Super Duty Diesel Motor Oil (U.S.) Motorcraft® Super Duty Motor Oil SAE 15W-40 / Huile moteur Super Duty SAE 15W-40 Motorcraft® (Canada) XO-15W40-QSDF (U.S.) CXO-15W40-LSD12 (Canada)	WSS-M2C171-F1

Alternative Engine Oil for Severe Duty Service

Materials

Name	Specification
Motorcraft® SAE 5W-40 Full Synthetic Diesel Motor Oil (U.S.) (Canada) XO-5W40-5Q3SD (U.S.)	WSS-M2C171-F1

Fuel Tank

Capacities

Variant	Quantity
Complete vehicle-142 inch and 148 inch wheelbase, middle location.	29.0 gal (109.8 L)
Complete vehicle-160 inch and 164 inch wheelbase, middle location.	34.0 gal (128.7 L)
Complete vehicle-176 inch wheelbase, middle location.	48.0 gal (181.7 L)

Capacities and Specifications

Variant	Quantity
Incomplete vehicle, middle location.	26.5 gal (100.3 L)
Incomplete vehicle, aft- axle -location.	40.0 gal (151.4 L)
Incomplete vehicle, middle and aft- axle - locations.	66.5 gal (251.7 L)

Diesel Exhaust Fluid (DEF) Tank

Capacities

Variant	Quantity
Complete vehicle.	7.4 gal (28 L)
Incomplete vehicle.	7.2 gal (27.3 L)

Materials

Name	Specification
Motorcraft® Diesel Exhaust Fluid(U.S.) Motorcraft® Diesel Exhaust Fluid / Fluide pour échappement diesel Motorcraft®(Canada) PM-27-GAL,PM-27-JUG(U.S.) CPM-27-J(Canada)	WSS-M99C130-A

Grease

Capacities and Specifications

Materials

Name	Specification
Motorcraft® High Temperature 4x4 Front Axle and Wheel Bearing Grease(U.S.) Motorcraft® High Temperature 4x4 Front Axle and Wheel Bearing Grease / Graisse haute température pour roulements de roue et ponts avant 4x4 Motorcraft®(Canada) XG-11(U.S. & Canada)	WSS-M1C267-A1
Motorcraft® Multi-Purpose Grease Spray(U.S.) Motorcraft® Multi-Purpose Grease Spray / Graisse tout usage en aérosol Motorcraft®(Canada) XL-5-A(U.S. & Canada)	ESB-M1C93-B
Motorcraft® Premium Long-Life Grease(U.S.) Motorcraft® Premium Long-Life Grease / Graisse longue durée de qualité première Motorcraft®(Canada) XG-1-E1(U.S. & Canada)	ESA-M1C75-B

Hydraulic Brake System

Materials

Name	Specification
Motorcraft® DOT 4 LV High Performance Motor Vehicle Brake Fluid(U.S.) Motorcraft® DOT 4 LV High Performance Motor Vehicle Brake Fluid / Liquide de frein automobile haute performance DOT 4 LV Motorcraft®(Canada) PM-20(U.S. & Canada)	WSS-M6C65-A2

Note: *We recommend using DOT 4 Low Viscosity (LV) High Performance Brake Fluid or equivalent meeting WSS-M6C65-A2. Use of any fluid other than the recommended fluid could cause reduced brake performance and not meet our performance standards. Keep brake fluid clean and dry. Contamination with dirt, water, petroleum products or other materials could result in brake system damage and possible failure.*

Power Steering System

Capacities and Specifications

Materials

Name	Specification
Motorcraft® MERCON® LV Automatic Transmission Fluid(U.S.) Motorcraft® MERCON® LV Automatic Transmission Fluid / Huile pour boîte automatique MERCON® LV Motorcraft®(Canada) XT-10-QLVC(U.S.) CXT-10-LV6(Canada)	WSS-M2C938-AMERCON® LV,

Locks

Materials

Name	Specification
Motorcraft® Penetrating and Lock Lubricant(U.S.) Motorcraft® Penetrating Fluid / Liquide dégrissant Motorcraft®(Canada) XL-1(U.S.) CXC-51-A(Canada)	-

Transfer Case

Capacities

Variant	Quantity
All.	1.9 qt (1.8 L)

Materials

Name	Specification
Motorcraft® MERCON® LV Automatic Transmission Fluid(U.S.) Motorcraft® MERCON® LV Automatic Transmission Fluid / Huile pour boîte automatique MERCON® LV Motorcraft®(Canada) XT-10-QLVC(U.S.) CXT-10-LV6(Canada)	WSS-M2C938-AMERCON® LV,

Capacities and Specifications

Front Axle

Capacities

Variant	Quantity
With Tremor package (with limited slip).	2.75 qt (2.6 L) ¹
Without Tremor package (without limited slip).	2.75 qt (2.6 L)

¹For complete refill of limited slip axles, add 5.4 fl oz. (160 ml) of Additive Friction Modifier XL-3 or equivalent, meeting specification EST-M2C118-A. Include this friction modifier in the total lube volume of 2.75 qt (2.6 L).

Materials

Name	Specification
Motorcraft® Additive Friction Modifier(U.S.) Motorcraft® Additive Friction Modifier / Additif modificateur de friction Motorcraft®(Canada) XL-3(U.S.) CXL-3(Canada)	EST-M2C118-A
Motorcraft® SAE 80W-90 Premium Rear Axle Lubricant(U.S.) Motorcraft® SAE 80W-90 Premium Axle Lubricant / Lubrifiant pour essieux de très haute qualité SAE 80W-90 Motorcraft®(Canada) XY-80W90-QL(U.S.) CXY-80W90-1L(Canada)	WSP-M2C197-A

Rear Axle - 10.5

Capacities

Variant	Quantity
With Electronic Locking Differential.	3.3–3.5 qt (3.1–3.3 L)
Without Electronic Locking Differential.	3.5–3.6 qt (3.3–3.4 L)

Capacities and Specifications

Materials

Name	Specification
Motorcraft® SAE 75W-85 Premium Synthetic Hypoid Gear Lubricant (U.S.) Motorcraft® SAE 75W-85 Premium Synthetic Hypoid Gear Lubricant / Huile synthétique de haute qualité pour engrenages hypoides SAE 75W-85 Motorcraft® (Canada) XY-75W85-QL (U.S. & Canada)	WSS-M2C942-A

Rear Axle - 10.8

Capacities

Variant	Quantity
All.	3.6 qt (3.42 L)

Materials

Name	Specification
Motorcraft® SAE 75W-140 Synthetic Rear Axle Lubricant (U.S.) Motorcraft® SAE 75W-140 Synthetic Rear Axle Lubricant / Lubrifiant synthétique pour pont arrière SAE 75W-140 Motorcraft® (Canada) XY-75W140-QL (U.S.) CXY-75W140-1L (Canada)	WSL-M2C192-A

Rear Axle - 11.8

Capacities

Variant	Quantity
All.	3.78 qt (3.58 L) ¹

¹ For complete refill of limited slip axles, add 7.1 fl oz. (210 ml) of Additive Friction Modifier XL-3 or equivalent, meeting specification EST-M2C118-A. Include this friction modifier in the total lube volume of 3.78 qt (3.58 L).

Capacities and Specifications

Materials

Name	Specification
Motorcraft® Additive Friction Modifier(U.S.) Motorcraft® Additive Friction Modifier / Additif modificateur de friction Motorcraft®(Canada) XL-3(U.S.) CXL-3(Canada)	EST-M2C118-A
Motorcraft® SAE 75W-140 Synthetic Rear Axle Lubricant(U.S.) Motorcraft® SAE 75W-140 Synthetic Rear Axle Lubricant / Lubrifiant synthétique pour pont arrière SAE 75W-140 Motorcraft®(Canada) XY-75W140-QL(U.S.) CXY-75W140-1L(Canada)	WSL-M2C192-A

Washer Reservoir

Capacities

Variant	Quantity
All.	Fill as required.

Materials

Name	Specification
Motorcraft® Premium Windshield Wash Concen- trate with Bitterant(U.S.) Motorcraft® Premium Quality Windshield Washer Fluid / Liquide lave-glace de haute qualité Motor- craft®(Canada) ZC-32-B2(U.S.) CXC-37-A/B/D/F(Canada)	WSS-M14P19-A

CAPACITIES AND SPECIFICATIONS - 7.3L

Use oil and fluid that meets the defined specification and viscosity grade.

If you do not use oil and fluid that meets the defined specification and viscosity grade, it could result in:

- Component damage not covered by the vehicle warranty.
- Longer engine cranking periods.
- Increased emission levels.

Capacities and Specifications

- Reduced engine performance.
- Reduced fuel economy.
- Reduced brake performance.

Air Conditioning System



WARNING: The air conditioning refrigerant system contains refrigerant under high pressure. Only qualified personnel should service the air conditioning refrigerant system. Opening the air conditioning refrigerant system can cause personal injury.

Capacities

Variant	Refrigerant	Refrigerant Oil
All.	27 oz (0.765 kg)	3.7 fl oz (110 ml)

Materials

Name	Specification
Motorcraft® R-134a Refrigerant(U.S.) R-134a Refrigerant / Frigorigène R-134a(Canada) YN-19(U.S.) CYN-19-R(Canada)	WSH-M17B19-A
Motorcraft® PAG Refrigerant Compressor Oil(U.S.) Motorcraft® PAG Refrigerant Compressor Oil / Huile PAG pour compresseur frigorifique Motor- craft®(Canada) YN-12-D(U.S. & Canada)	WSH-M1C231-B

Automatic Transmission

Note: Only use **MERCON® ULV** transmission fluid for automatic transmissions that require **MERCON® ULV** transmission fluid. The use of any other fluid could cause transmission damage.

Capacities

Variant	Quantity
Ten-speed automatic transmission (10R140).	18.2 qt (17.2 L) ¹

¹Approximate dry fill capacity. Actual amount could vary during fluid changes.

Capacities and Specifications

Materials

Name	Specification
Motorcraft® MERCON® ULV Automatic Transmission Fluid (U.S.) Motorcraft® MERCON® ULV Automatic Transmission Fluid / MERCON® ULV huile pour boîtes automatique Motorcraft® (Canada) XT-12-QULV (U.S. & Canada)	WSS-M2C949-A, MERCON® ULV

Engine Coolant

Capacities

Variant	Quantity
All.	22.5 qt (21.3 L)

Materials

Name	Specification
Motorcraft® Yellow Prediluted Antifreeze/Coolant (U.S.) Motorcraft® Yellow Prediluted Antifreeze/Coolant / Antigel/liquide de refroidissement prédilué jaune Motorcraft® (Canada) VC-13DL-G (U.S.) CVC-13DL-G (Canada)	WSS-M97B57-A2

Engine Oil



E142732



E276075

Capacities and Specifications

An oil that displays this symbol conforms to current engine, emission system and fuel economy performance standards of ILSAC.

Do not use supplemental engine oil additives because they are unnecessary and could lead to engine damage that your vehicle warranty does not cover.

We recommend Motorcraft® motor oil for your vehicle. If Motorcraft® oil is not available, use motor oils of the recommended viscosity grade that meet API SN PLUS requirements and display the API Certification Mark for gasoline engines.

Capacities

Variant	Including the Oil Filter
All.	8.0 qt (7.57 L)

Materials

Name	Specification
Engine Oil - SAE 5W-30 - Synthetic Blend Motor Oil(U.S.) Engine Oil - SAE 5W-30 - Super Premium Motor Oil / Huile moteur de très haute qualité SAE 5W-30 Motorcraft®(Canada) XO-5W30-Q1SP(U.S.) CXO-5W30-LSP6(Canada)	WSS-M2C946-B1

Alternative Engine Oil for Extremely Cold Climates

To improve engine cold start performance, we recommend that you use the following alternative engine oil in extremely cold climates, where the ambient temperature reaches -22.0°F (-30°C) or below.

Materials

Name	Specification
Engine Oil - SAE 0W-30	WSS-M2C953-B1

Capacities and Specifications

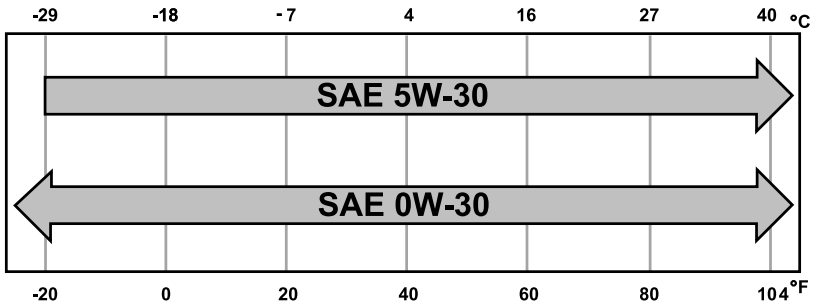

Fuel Tank

Capacities

Variant	Quantity
Complete vehicle-all except 176 inch wheelbase and incomplete vehicles.	34.0 gal (128.7 L)
Complete vehicle-176 inch wheelbase.	48.0 gal (181.7 L)
Incomplete vehicle, aft- axle -location.	40.0 gal (151.4 L)
Incomplete vehicle, middle location.	26.5 gal (100.3 L)

Grease

Capacities and Specifications

Materials

Name	Specification
Motorcraft® High Temperature 4x4 Front Axle and Wheel Bearing Grease(U.S.) Motorcraft® High Temperature 4x4 Front Axle and Wheel Bearing Grease / Graisse haute température pour roulements de roue et ponts avant 4x4 Motorcraft®(Canada) XG-11(U.S. & Canada)	WSS-M1C267-A1
Motorcraft® Multi-Purpose Grease Spray(U.S.) Motorcraft® Multi-Purpose Grease Spray / Graisse tout usage en aérosol Motorcraft®(Canada) XL-5-A(U.S. & Canada)	ESB-M1C93-B
Motorcraft® Premium Long-Life Grease(U.S.) Motorcraft® Premium Long-Life Grease / Graisse longue durée de qualité première Motorcraft®(Canada) XG-1-E1(U.S. & Canada)	ESA-M1C75-B

Hydraulic Brake System

Materials

Name	Specification
Motorcraft® DOT 4 LV High Performance Motor Vehicle Brake Fluid(U.S.) Motorcraft® DOT 4 LV High Performance Motor Vehicle Brake Fluid / Liquide de frein automobile haute performance DOT 4 LV Motorcraft®(Canada) PM-20(U.S. & Canada)	WSS-M6C65-A2

Note: We recommend using DOT 4 Low Viscosity (LV) High Performance Brake Fluid or equivalent meeting WSS-M6C65-A2. Use of any fluid other than the recommended fluid could cause reduced brake performance and not meet our performance standards. Keep brake fluid clean and dry. Contamination with dirt, water, petroleum products or other materials could result in brake system damage and possible failure.

Power Steering System

Capacities and Specifications

Materials

Name	Specification
Motorcraft® MERCON® LV Automatic Transmission Fluid(U.S.) Motorcraft® MERCON® LV Automatic Transmission Fluid / Huile pour boîte automatique MERCON® LV Motorcraft®(Canada) XT-10-QLVC(U.S.) CXT-10-LV6(Canada)	WSS-M2C938-AMERCON® LV,

Locks

Materials

Name	Specification
Motorcraft® Penetrating and Lock Lubricant(U.S.) Motorcraft® Penetrating Fluid / Liquide dégrissant Motorcraft®(Canada) XL-1(U.S.) CXC-51-A(Canada)	-

Transfer Case

Capacities

Variant	Quantity
All.	1.9 qt (1.8 L)

Materials

Name	Specification
Motorcraft® MERCON® LV Automatic Transmission Fluid(U.S.) Motorcraft® MERCON® LV Automatic Transmission Fluid / Huile pour boîte automatique MERCON® LV Motorcraft®(Canada) XT-10-QLVC(U.S.) CXT-10-LV6(Canada)	WSS-M2C938-AMERCON® LV,

Capacities and Specifications

Front Axle

Capacities

Variant	Quantity
With Tremor package (with limited slip).	2.75 qt (2.6 L) ¹
Without Tremor package (without limited slip).	2.75 qt (2.6 L)

¹ For complete refill of limited slip axles, add 5.4 fl oz. (160 ml) of Additive Friction Modifier XL-3 or equivalent, meeting specification EST-M2C118-A. Include this friction modifier in the total lube volume of 2.75 qt (2.6 L).

Materials

Name	Specification
Motorcraft® Additive Friction Modifier(U.S.) Motorcraft® Additive Friction Modifier / Additif modificateur de friction Motorcraft®(Canada) XL-3(U.S.) CXL-3(Canada)	EST-M2C118-A
Motorcraft® SAE 80W-90 Premium Rear Axle Lubricant(U.S.) Motorcraft® SAE 80W-90 Premium Axle Lubricant / Lubrifiant pour essieux de très haute qualité SAE 80W-90 Motorcraft®(Canada) XY-80W90-QL(U.S.) CXY-80W90-1L(Canada)	WSP-M2C197-A

Rear Axle - 10.5

Capacities

Variant	Quantity
With Electronic Locking Differential.	3.3–3.5 qt (3.1–3.3 L)
Without Electronic Locking Differential.	3.5–3.6 qt (3.3–3.4 L)

Capacities and Specifications

Materials

Name	Specification
Motorcraft® SAE 75W-85 Premium Synthetic Hypoid Gear Lubricant (U.S.) Motorcraft® SAE 75W-85 Premium Synthetic Hypoid Gear Lubricant / Huile synthétique de haute qualité pour engrenages hypoides SAE 75W-85 Motorcraft® (Canada) XY-75W85-QL (U.S. & Canada)	WSS-M2C942-A

Rear Axle - 10.8

Capacities

Variant	Quantity
All.	3.6 qt (3.42 L)

Materials

Name	Specification
Motorcraft® SAE 75W-140 Synthetic Rear Axle Lubricant (U.S.) Motorcraft® SAE 75W-140 Synthetic Rear Axle Lubricant / Lubrifiant synthétique pour pont arrière SAE 75W-140 Motorcraft® (Canada) XY-75W140-QL (U.S.) CXY-75W140-1L (Canada)	WSL-M2C192-A

Rear Axle - 11.8 (With HD Tow Option)

Capacities

Variant	Quantity
All.	3.78 qt (3.58 L) ¹

¹ For complete refill of limited slip axles, add 7.1 fl oz. (210 ml) of Additive Friction Modifier XL-3 or equivalent, meeting specification EST-M2C118-A. Include this friction modifier in the total lube volume of 3.78 qt (3.58 L).

Capacities and Specifications

Materials

Name	Specification
Motorcraft® Additive Friction Modifier(U.S.) Motorcraft® Additive Friction Modifier / Additif modificateur de friction Motorcraft®(Canada) XL-3(U.S.) CXL-3(Canada)	EST-M2C118-A
Motorcraft® SAE 75W-140 Synthetic Rear Axle Lubricant(U.S.) Motorcraft® SAE 75W-140 Synthetic Rear Axle Lubricant / Lubrifiant synthétique pour pont arrière SAE 75W-140 Motorcraft®(Canada) XY-75W140-QL(U.S.) CXY-75W140-1L(Canada)	WSL-M2C192-A

Rear Axle - 11.8 (Without HD Tow Option)

Capacities

Variant	Quantity
All.	3.78 qt (3.58 L) ¹

¹ For complete refill of limited slip axles, add 7.1 fl. oz. (210 ml) of Additive Friction Modifier XL-3 or equivalent, meeting specification EST-M2C118-A. Include this friction modifier in the total lube volume of 3.78 qt (3.58 L).

Materials

Name	Specification
Motorcraft® Additive Friction Modifier(U.S.) Motorcraft® Additive Friction Modifier / Additif modificateur de friction Motorcraft®(Canada) XL-3(U.S.) CXL-3(Canada)	EST-M2C118-A
Motorcraft® SAE 80W-90 Premium Rear Axle Lubricant(U.S.) Motorcraft® SAE 80W-90 Premium Axle Lubricant / Lubrifiant pour essieux de très haute qualité SAE 80W-90 Motorcraft®(Canada) XY-80W90-QL(U.S.) CXY-80W90-1L(Canada)	WSP-M2C197-A

Capacities and Specifications

Washer Reservoir

Capacities

Variant	Quantity
All.	Fill as required.

Materials

Name	Specification
Motorcraft® Premium Windshield Wash Concentrate with Bitterant (U.S.) Motorcraft® Premium Quality Windshield Washer Fluid / Liquide lave-glace de haute qualité Motorcraft® (Canada) ZC-32-B2 (U.S.) CXC-37-A/B/D/F (Canada)	WSS-M14P19-A

BULB SPECIFICATION CHART

Replacement bulbs are specified in the chart below. Headlamp bulbs must be marked with an authorized D.O.T. marking for North America to make sure they have the proper lamp performance, light brightness, light pattern and safe visibility. The correct bulbs will not damage the lamp assembly or void the lamp assembly warranty and will provide quality bulb illumination time.

Exterior Lamps

Lamp	Specification	Power (Watt)
Headlamp.	H13/9008	60/55
Headlamp.	LED	LED
Front side marker lamp.	W5W	5
Front fog lamp.	9140	40
Front fog lamp. ³	LED	LED

Capacities and Specifications

Lamp	Specification	Power (Watt)
Front direction indicator and parking lamp.	T20/7444NA	28/8
Rear lamp, brake lamp, and rear side marker lamp. Low/Mid series. ¹	3157K	27/7
Rear direction indicator lamp. Low/Mid series. ¹	WTY21W	21
Rear lamp, brake lamp, rear direction indicator, rear side marker lamp and reverse lamp. High series. ¹	LED	LED
Rear lamp, brake lamp, rear direction indicator and rear side marker lamp. ²	3157K	27/7
Reversing lamp. Low/Mid series.	WT21W	21
License plate lamp. Low series.	168	5
License plate lamp. High series.	LED	LED
Central high mounted cargo lamp.	912	12.8
Central high mounted cargo lamp.	LED	LED
Side direction indicator and mirror clearance lamp.	LED	LED
Front clearance lamp.	LED	LED
Rear clearance lamp.	LED	LED
Front identification lamp.	LED	LED
Rear identification lamp.	LED	LED
Underhood lamp.	LED	LED

¹Pickup only.

²Chassis cab only.

³U.S. and Canada only

Note: LED lamps are not serviceable. See an authorized dealer if they fail.

Capacities and Specifications

Interior Lamps

Lamp	Specification	Power (Watt)
Map lamp.	LED	LED
Glove compartment lamp.	LED	LED
Interior lamp.	LED	LED
Overhead console lamp.	LED	LED

Note: LED lamps are not serviceable. See an authorized dealer if they fail.

Network Connectivity (If Equipped)

CONNECTING THE VEHICLE TO A MOBILE NETWORK

What Is the Modem

The modem allows you to connect your vehicle to the Internet to use when you are on the road.

If you enable the modem using the FordPass app, you can access the following services:

- Locating and remotely starting, locking and unlocking your vehicle. See the information in FordPass app.
- Automatic system updates.

Enabling the Modem Using FordPass

1. Open the FordPass app on your device and log in.

2. Select your vehicle.
3. Select the option for vehicle details.
4. Select the option to activate your vehicle.
5. Switch the ignition on.
6. Make sure that the name on the screen matches the name shown in your FordPass account.
7. Confirm the association of your vehicle with your FordPass account.

Enabling the Modem Using the Touchscreen



Select the settings option on the feature bar.

1. Select **FordPass Connect**.
2. Select **Connectivity Settings**.
3. Switch connectivity features on.

Network Connectivity (If Equipped)

NETWORK CONNECTIVITY – TROUBLESHOOTING

Wi-Fi Network

Symptom	Possible Cause and Resolution
I cannot connect to a Wi-Fi network.	<ul style="list-style-type: none">– Password error.<ul style="list-style-type: none">• Enter the correct network password.– Weak network signal.<ul style="list-style-type: none">• Move your vehicle closer to the Wi-Fi hotspot or to a place where the network signal is not obstructed.– Multiple access points in range with the same SSID.<ul style="list-style-type: none">• Use a unique name for your SSID. Do not use the default name unless it contains a unique identifier, for example as part of the MAC address.
The Wi-Fi connection disconnects after successful connection.	<ul style="list-style-type: none">– Weak network signal.<ul style="list-style-type: none">• Move your vehicle closer to the Wi-Fi hotspot or to a place where the network signal is not obstructed.
I am close to a Wi-Fi hotspot but the network signal strength is weak.	<ul style="list-style-type: none">– Obstructed network signal.<ul style="list-style-type: none">• If your vehicle has a heated windshield, position your vehicle so that the windshield is not facing the Wi-Fi hotspot.• If your vehicle has metallic tinting on the windows but not on the windshield, position your vehicle so that the windshield is facing the Wi-Fi hotspot or open the windows that are facing the hotspot.• If your vehicle has metallic tinting on the windows and the windshield, open the windows that are facing the hotspot.• If your vehicle is in a garage and you have the garage door closed, open the garage door.
I cannot see a network in the list of available networks that I expect to see.	<ul style="list-style-type: none">– Hidden network.<ul style="list-style-type: none">• Make the network visible and try again.

Network Connectivity (If Equipped)

Symptom	Possible Cause and Resolution
I cannot see the Wi-Fi Hotspot name when I search for Wi-Fi networks on my cell phone or other device.	<ul style="list-style-type: none"> – System limitation. <ul style="list-style-type: none"> • Make sure Wi-Fi hotspot visibility is on. • The system does not provide a Wi-Fi hotspot at this time.
Software downloads take too long.	<ul style="list-style-type: none"> – Weak network signal <ul style="list-style-type: none"> • Move your vehicle closer to the Wi-Fi hotspot or to a place where the network signal is not obstructed. – Wi-Fi hotspot in high demand or has a slow Internet connection. <ul style="list-style-type: none"> • Use an more reliable Wi-Fi hotspot.
The system seems to connect to a Wi-Fi network and the signal strength is excellent but the software does not update.	<ul style="list-style-type: none"> – No software update available. – Wi-Fi network requires a subscription or acceptance of terms and conditions. <ul style="list-style-type: none"> • Test the connection using another device. If the network requires a subscription or acceptance of terms and conditions, contact the network service provider.

Mobile Network

Symptom	Possible Cause and Resolution
I cannot confirm the connection of the modem with the FordPass account.	<ul style="list-style-type: none"> – Modem is not enabled. <ul style="list-style-type: none"> • Switch connectivity features on. – Weak network signal. <ul style="list-style-type: none"> • Move your vehicle closer to a place where the network signal is not obstructed.

Vehicle Wi-Fi Hotspot (If Equipped)

CREATING A VEHICLE WI-FI HOTSPOT

You can create a Wi-Fi hotspot in your vehicle and allow devices to connect to it for access to the Internet.



Press the button to enter the settings menu.

1. Select **Connectivity Features**.
2. Select **Vehicle Hotspot**.
3. Select **Settings**.
4. Make sure that you have Wi-Fi visibility switched on.

Note: The Wi-Fi Visibility default setting is on.

Finding the Wi-Fi Hotspot Name and Password



Press the button to enter the settings menu.

1. Select **Connectivity Features**.
 2. Select **Vehicle Hotspot**.
 3. Select **Settings**.
- Note:** The SSID is the hotspot name.
4. Scroll to **Hide password**.
 5. Uncheck the box.

Connecting a Device to the Wi-Fi Hotspot

1. On your device, turn on Wi-Fi and select the hotspot from the list of available Wi-Fi networks.
2. When prompted, enter the password.

Purchasing a Data Plan

1. Connect a device to the hotspot.

Note: The vehicle network carrier's portal opens on your device.

2. If the portal does not open on your device, open a website and it redirects to the vehicle network carrier's portal.

Note: Secure websites do not redirect.

Note: If you have an active plan, the system does not redirect to the vehicle network carrier's portal when you connect a device. Visit the vehicle network carrier's website to purchase more data.

Note: If data usage information is available in the vehicle hotspot menu, it is approximate.

Note: If you carry out a master reset, the system does not remove your vehicle from your vehicle network carrier's account. To remove your vehicle from the account, contact your vehicle network carrier.

Note: The vehicle network carrier provides Vehicle Hotspot services, subject to your vehicle network carrier agreement, coverage and availability.

CHANGING THE VEHICLE WI-FI HOTSPOT NAME OR PASSWORD



Press the button to enter the settings menu.

1. Select **Connectivity Features**.
2. Select **Vehicle Hotspot**.
3. Select **Settings**.
4. Select **SSID: ____**.
5. Enter your required SSID.
6. Select **Done**.
7. Select **Password: ____**.
8. Enter your required password.
9. Select **Done**.

Audio System

GENERAL INFORMATION



WARNING: Driving while distracted can result in loss of vehicle control, crash and injury. We strongly recommend that you use extreme caution when using any device that may take your focus off the road. Your primary responsibility is the safe operation of your vehicle. We recommend against the use of any

hand-held device while driving and encourage the use of voice-operated systems when possible. Make sure you are aware of all applicable local laws that may affect the use of electronic devices while driving.

Radio Frequencies and Reception Factors

Note: *Listening to loud audio for long periods of time could damage your hearing.*

Radio Reception Factors

Distance and strength	The further you travel from an AM or FM station, the weaker the signal and the weaker the reception.
Terrain	Hills, mountains, tall buildings, bridges, tunnels, freeway overpasses, parking garages, dense tree foliage and thunderstorms can interfere with the reception.
Station overload	When you pass a ground-based broadcast repeating tower, a stronger signal may overtake a weaker one and result in the audio system muting.

AUDIO UNIT - VEHICLES WITH: AM/FM/TOUCHSCREEN DISPLAY/SYNC 3



WARNING: Driving while distracted can result in loss of vehicle control, crash and injury. We strongly recommend that you use extreme caution when using any device that may take your focus off the road. Your primary responsibility is the safe operation of your vehicle. We recommend against the use of any

hand-held device while driving and encourage the use of voice-operated systems when possible. Make sure you are aware of all applicable local laws that may affect the use of electronic devices while driving.



E291384

Note: *Depending on your vehicle option package, the controls could look different from what you see here.*

Audio System

Note: Some features, such as satellite radio, may not be available in your location. Check with an authorized dealer.

Note: The touchscreen system controls most of the audio features.

Adjusting the Volume

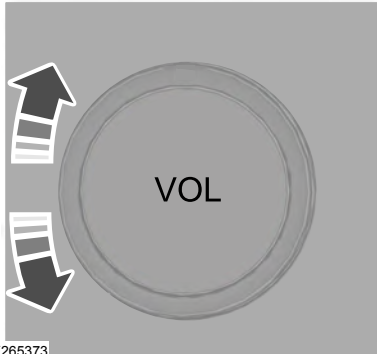

E265373

Turn to adjust the volume.

Changing Radio Stations

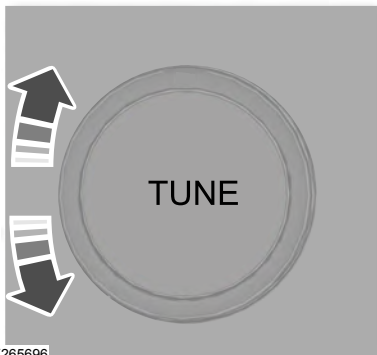

E265696

In radio mode, turn to search through the radio frequency band.

In satellite radio mode, turn to find the previous or next available satellite radio station.

Selecting the Audio Modes

MEDIA Press and release the button to access different audio modes, for example AM and FM.

Setting a Memory Preset

Tune to a station, then press and hold one of the memory preset buttons on the touchscreen. The audio briefly mutes while the system saves the station and returns once the station is stored.

Switching the Audio Unit On and Off

 Press and release the button.

Using Seek, Fast Forward and Reverse



In radio mode, select a frequency band and press and release either button. The system stops at the first station it finds in that direction.

In satellite radio mode, press and release to select the next or previous satellite radio station. If you select a specific category, such as jazz, rock or news, press to find the next or previous station in that category.

Audio System

AUDIO UNIT - VEHICLES WITH: SYNC



WARNING: Driving while distracted can result in loss of vehicle control, crash and injury. We strongly recommend that you use extreme caution when using any device that may take your focus off the road. Your primary responsibility is the safe operation of your vehicle. We recommend against the use of any hand-held device while driving and encourage the use of voice-operated systems when possible. Make sure you are aware of all applicable local laws that may affect the use of electronic devices while driving.



E291383

Note: Depending on your vehicle option package, the controls may look different from what you see here.

Note: Some features, such as satellite radio, may not be available in your location. Check with an authorized dealer.

Accessing the Apps Menu



Press and release the button to access the apps menu. Follow the on-screen prompts to make your selection.

Accessing the Clock Settings



Press and release the button to access the clock setting. Use the center arrow controls to change the hours and minutes.

Accessing the Media Source Menu



Press and release the button to open the media source menu.

You can press this multiple times to change to a SYNC-Media device or scroll through the media sources using the arrow buttons. Press **OK** to select a source.

Accessing the Phone Features



Press and release the button to access the phone features of the SYNC system.

Accessing the Sound Settings



Press and release the button to access settings for Treble, Midrange, Bass, Fade and Balance.

Accessing the Settings Menu



Press and release the button to access the settings menu. Follow the on-screen prompts to make your selection.

Audio System

Adjusting the Volume

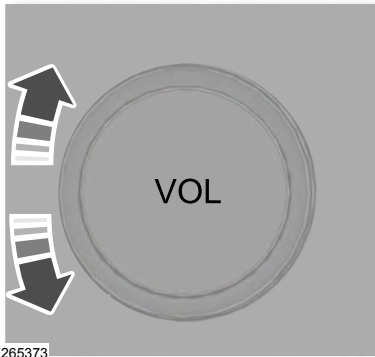

E265373

Turn to adjust the volume.

Changing Radio Stations

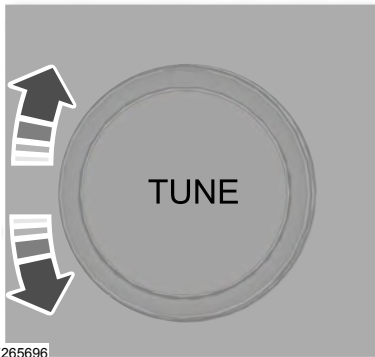

E265696

In radio mode, turn to search through the radio frequency band.

In satellite radio mode, turn to find the previous or next available satellite radio station.

Listening to the Radio

RADIO Press and release the button to listen to the radio or change radio stations.

Playing or Pausing Media

 Press and release the button to either play or pause current media source.

Switching the Audio Unit On and Off

 Press and release the button.

Switching the Display On and Off

 Press and release the button.

Switching Radio Text On and Off

 Press and release the button to display extra information, for example, artist name.

Note: *Extra information may not always be available.*

Switching Repeat Mode On and Off

 Press and release the button to repeat the current media source.

Switching Shuffle Mode On and Off

 Press and release the button to shuffle the current media source.

Audio System

Using the Display Control

Use the up and down arrow buttons to select the various settings. When you make your selection, press the left and right arrow buttons to change the settings.

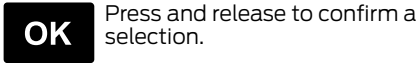

Press and release to confirm a selection.

Press and release the function buttons below the display to select different functions of the audio system depending on which mode you are in.

Using the Number Block

In radio mode, store and recall your favorite radio stations. To store a favorite station, press and hold until the sound returns. In phone mode, enter a phone number.

Using Seek, Fast Forward and Reverse



In radio mode, select a frequency band and press and release either button. The system stops at the first station it finds in that direction.

In satellite radio mode, press and release to select the next or previous satellite radio station. If you select a specific category, such as jazz, rock or news, press to find the next or previous station in that category.

DIGITAL RADIO (IF EQUIPPED)

Note: *HD Radio broadcasts are not available in all markets.*

HD Radio technology is the digital evolution of analog AM/FM radio. Your system has a special receiver that allows it to receive digital broadcasts, where available, in addition to the analog broadcasts, it already receives. Digital broadcasts provide a better sound quality than analog broadcasts with free, crystal-clear audio and no static or distortion. For more information, and a guide to available stations and programming, please visit www.hdradio.com.

When HD Radio is on and you tune to a station broadcasting HD Radio technology, you may notice the HD Radio logo on your screen. When this logo is available, you may also see Title and Artist fields on-screen.

The multicast indicator appears in FM mode, only, if the current station is broadcasting multiple digital broadcasts. The highlighted numbers signify available digital channels where new or different content is available. HD1 signifies the main programming status and is available in analog and digital broadcasts. Other multicast stations, HD2 through HD7, are only available digitally.

When HD Radio broadcasts are active, you can access the following functions:

- **Memory presets** allow you to save an active channel as a memory preset. Touch and hold a memory preset slot until the sound returns. There is a brief mute while the radio saves the station. Sound returns when finished. When switching to an HD2 or HD3 memory preset, the sound mutes before the digital audio plays, because the system has to reacquire the digital signal.

Note: *As with any saved radio station, you cannot access the saved station if your vehicle is outside the station's reception area.*

Audio System

HD Radio Reception and Station Troubleshooting

Potential reception issues	
Reception area	If you are listening to a multicast station and you are on the fringe of the reception area, the station may mute due to weak signal strength.
	If you are listening to HD1, the system switches back to the analog broadcast until the digital broadcast is available again. However, if you are listening to any of the possible HD2-HD7 multicast channels, the station mutes and stays muted unless it is able to connect to the digital signal again.
Station blending	When the system first receives a station, aside from HD2-HD7 multicast stations, it first plays the station in the analog version. Once the receiver verifies the station is an HD Radio station, it shifts to the digital version. Depending on the station quality, you may hear a slight sound change when the station changes from analog to digital. Blending is the shift from analog to digital sound or digital back to analog sound.

In order to provide the best possible experience, use the contact form to report any station issues found while listening to a station broadcasting with HD Radio technology. Independent entities own and operate each station. These stations are responsible for the accuracy of all audio streams and data fields.

Audio System

Potential station issues		
Issues	Cause	Action
Echo, stutter, skip or repeat in audio. Increase or decrease in audio volume.	This is poor time alignment by the radio broadcaster.	No action required. This is a broadcast issue.
Sound fading or blending in and out.	The radio is shifting between analog and digital audio.	No action required. The reception issue may clear up as you continue to drive.
There is an audio mute delay when selecting HD2 or HD3, multicast preset or Direct Tune .	The digital multicast is not available until the HD Radio broadcast is decoded. Once decoded, the audio is available.	No action required. This is normal behavior. Wait until the audio is available.
Cannot access HD2 or HD3 multicast channel when recalling a preset or from a direct tune.	The previously stored multicast preset or direct tune is not available in your current reception area.	No action required. The station is not available in your current location.
Text information does not match currently playing audio.	Data service issue by the radio broadcaster.	Fill out the station issue form at website listed below. ¹
There is no text information shown for currently selected frequency.	Data service issue by the radio broadcaster.	Fill out the station issue form at website listed below. ¹

¹ <http://hdradio.com/stations/feedback>

HD Radio Technology manufactured under license from iBiquity Digital Corporation and foreign patents. HD Radio and the HD and HD Radio logos are proprietary trademarks of DTS Ford Motor Company and DTS are not responsible for the content sent using HD Radio technology. Content may be changed, added or deleted at any time at the station owner's discretion.

SATELLITE RADIO (IF EQUIPPED)

SiriusXM® Satellite Radio broadcasts a variety of music, news, sports, weather, traffic and entertainment satellite radio channels. For more information and a complete list of SiriusXM satellite radio channels, visit www.siriusxm.com in the United States, www.siriusxm.ca in Canada, or call SiriusXM at 1-888-539-7474.

Audio System

Note: This receiver includes the eCos real-time operating system. eCos is published under the eCos License.

Satellite Radio Reception Factors

Potential satellite radio reception issues	
Antenna obstructions	For optimal reception performance, keep the antenna clear of snow and ice build-up and keep luggage and other material as far away from the antenna as possible.
Terrain	Hills, mountains, tall buildings, bridges, tunnels, freeway overpasses, parking garages, dense tree foliage and thunderstorms can interfere with your reception.
Station overload	When you pass a ground-based broadcast-repeating tower, a stronger signal may overtake a weaker one and the audio system may mute.
Satellite radio signal interference	Your display may show ACQUIRING . . . to indicate the interference and the audio system may mute.

SiriusXM Satellite Radio Service

Note: *SiriusXM reserves the unrestricted right to change, rearrange, add or delete programming including canceling, moving or adding particular channels, and its prices, at any time, with or without notice to you. Ford Motor Company shall not be responsible for any such programming changes.*



E208625

SiriusXM satellite radio is a subscription-based satellite radio service that broadcasts a variety of music, sports, news, weather, traffic and entertainment programming. Your factory-installed SiriusXM satellite radio system includes hardware and a limited subscription term, which begins on the date of sale or lease of your vehicle. See an authorized dealer for availability.

For more information on extended subscription terms (a service fee is required), the online media player and a complete list of SiriusXM satellite radio channels, and other features, please visit www.siriusxm.com in the United States, www.siriusxm.ca in Canada, or call SiriusXM at 1-888-539-7474.

Satellite Radio Electronic Serial Number (ESN)

You need your ESN to activate, modify or track your satellite radio account.

Audio System

Locating Your ESN

With satellite radio as the source, use the touchscreen to select the following:

1. Select **Settings**. See **Settings** (page 535).
2. Select **SiriusXM**.
3. Select **SiriusXM information**.

Troubleshooting

Message	Condition	Action
Acquiring...	Radio requires more than two seconds to produce audio for the selected channel.	No action required. This message should disappear shortly.
Satellite antenna fault SIRIUS system failure	There is an internal module or system failure present.	If this message does not clear shortly, or with an ignition key cycle, your receiver may have a fault. See an authorized dealer for service.
Invalid Channel	The channel is no longer available.	Tune to another channel or choose another preset.
Unsubscribed Channel	Your subscription does not include this channel.	Contact SiriusXM at 1-888-539-7474 to subscribe to the channel, or tune to another channel.
No Signal	The signal is lost from the SiriusXM satellite or SiriusXM tower to your vehicle antenna.	The signal is blocked. When you move into an open area, the signal should return.
Updating...	Update of channel programming in progress.	No action required. The process may take up to three minutes.
Questions? Call 1-888-539-7474	Your satellite service is no longer available.	Contact SiriusXM at 1-888-539-7474 to resolve subscription issues.
None found Check Channel Guide	All the channels in the selected category are either skipped or locked.	Use the channel guide to turn off the Lock or Skip function on that station.
Subscription Updated	SiriusXM has updated the channels available for your vehicle.	No action required.

Audio System

USB PORT



WARNING: Driving while distracted can result in loss of vehicle control, crash and injury. We strongly recommend that you use extreme caution when using any device that may take your focus off the road. Your primary responsibility is the safe operation of your vehicle. We recommend against the use of any hand-held device while driving and encourage the use of voice-operated systems when possible. Make sure you are aware of all applicable local laws that may affect the use of electronic devices while driving.

USB A



USB C



The USB port allows you to plug in media playing devices, memory sticks and charge devices.

Note: We recommend using only USB-IF certified cables and adapters. Non-certified cables and adapters may not work.

Locating the USB Ports

The USB ports may be in the following locations:

- Inside the media bin.
- Inside the center console.
- On the lower instrument panel.

Note: The number and type of USB ports may vary depending on your vehicle.

Note: Not all USB ports in your vehicle have data transfer capabilities. See **Auxiliary Power Points** (page 167).

GENERAL INFORMATION

SYNC is an in-vehicle communications system that works with your Bluetooth enabled cellular phone and portable media player. This allows you to:

- Make and receive calls.
- Access and play music from your portable music player.
- Use 911 Assist or Emergency Assistance and applications via SYNC AppLink.*
- Access phonebook contacts and music using voice commands.
- Stream music from your connected phone.
- Text message.
- Use the advanced voice recognition system.
- Charge your USB device (if your device supports this).

*These features are not available in all markets and may require activation. Available AppLink enabled apps vary by market.

Make sure that you review your device's manual before using it with SYNC.

Support

SYNC support is available at your regional Ford website. See **SYNC™ Troubleshooting** (page 496).

SYNC Owner Account

Why do I need a SYNC owner account?

- Essential for keeping up with the latest software downloads available for SYNC.
- Access to customer support for any questions you may have.

Driving Restrictions

For your safety, certain features are speed-dependent and restricted when your vehicle is traveling over 3 mph (5 km/h).

Safety Information



WARNING: Driving while distracted can result in loss of vehicle control, crash and injury. We strongly recommend that you use extreme caution when using any device that may take your focus off the road. Your primary responsibility is the safe operation of your vehicle. We recommend against the use of any hand-held device while driving and encourage the use of voice-operated systems when possible. Make sure you are aware of all applicable local laws that may affect the use of electronic devices while driving.

When using SYNC:

- Do not operate playing devices if the power cords or cables are broken, split or damaged. Place cords and cables out of the way, so they do not interfere with the operation of pedals, seats, compartments or safe driving abilities.
- Do not leave playing devices in your vehicle during extreme conditions as it could cause them damage. See your device's manual for further information.
- Do not attempt to service or repair the system. See an authorized dealer.

Privacy Information

When a cellular phone is connected to SYNC, the system creates a profile within your vehicle that is linked to that cellular phone. This profile is created in order to offer you more cellular features and to operate more efficiently. Among other things, this profile may contain data about your cellular phone book, text messages

(read and unread), and call history, including history of calls when your cellular phone was not connected to the system. In addition, if you connect a media device, the system creates and retains an index of supported media content. The system also records a short development log of approximately 10 minutes of all recent system activity. The log profile and other system data may be used to improve the system and help diagnose any problems that may occur.

The cellular profile, media device index, and development log will remain in the vehicle unless you delete them and are generally accessible only in the vehicle when you connect the cellular phone or media player. If you no longer plan to use the system or the vehicle, we recommend you perform a Master Reset to erase all stored information.

No one can access system data without special equipment and access to the vehicle's SYNC module. Ford Motor Company and Ford of Canada will not access the system data for any purpose other than as described absent consent, a

court order, or where required by law enforcement, other government authorities, or other third parties acting with lawful authority. Other parties may seek to access the information independently of Ford Motor Company and Ford of Canada. For further privacy information, see the section on 911 Assist. See **SYNC™ Applications and Services** (page 492).

USING VOICE RECOGNITION

This system helps you control many features using voice commands. This allows you to keep your hands on the wheel and focus on what is around you.

Initiating a Voice Session



Press the voice button. A list of available voice commands appears in the display.

Global Voice Commands

These voice commands are always available. You can say them at any time.

Global voice commands	
Help	Gives you available commands you can use on the current screen.
List of Commands	Gives you a list of possible voice commands.
Cancel	This command ends the voice session. You can also cancel a session by pressing seek up, seek down, or holding the voice button for two or more seconds.

Helpful Hints

- Make sure the interior of your vehicle is as quiet as possible. Wind noise from open windows and road vibrations may prevent the system from correctly recognizing spoken commands.
- Before giving a voice command, wait for the system announcement to finish, followed by a single tone. Any command spoken before this does not register with the system.
- Speak naturally, without long pauses between words.
- You can interrupt the system at any time while it is speaking by pressing the voice button. You can cancel a voice session by pressing and holding the voice button.

System Interaction and Feedback

The system provides feedback through audible tones, prompts, questions and spoken confirmations depending on the situation and the chosen level of interaction. You can customize the voice recognition system to provide more or less instruction and feedback.

The default setting is to a higher level of interaction in order to help you learn to use the system. You can change these settings at any time.

Adjusting the Interaction Level



Press the voice button. When prompted, say:

Voice Command	Action and Description
Interaction Mode Standard	Provides more detailed interaction and guidance. (Recommended for first time users.)
Interaction Mode Advanced	Provides less audible interaction and guidance.

Phone Confirmation

Using phone confirmations the system asks you to verify before placing any calls.

To adjust this setting press the voice button, when prompted say:

Voice Command	Action and Description
Phone Confirmation Off	When enabled, this feature will prompt you to confirm any voice initiated call command prior to the call being placed.
Phone Confirmation On	The system will make a best guess; you may still occasionally be asked to confirm settings.

USING SYNC™ WITH YOUR PHONE

Hands-free calling is one of the main features of SYNC. While the system supports a variety of features, many are dependent on your cellular phone's functionality. At a minimum, most cellular phones with Bluetooth wireless technology support the following functions:

- Answering an incoming call.
- Ending a call.
- Dialing a number.
- Redialing.
- Call waiting notification.
- Caller ID.

Other features, such as text messaging using Bluetooth and automatic phonebook download, are phone-dependent features.

Pairing a Phone

Wirelessly pairing your phone with SYNC allows you to make and receive hands-free calls.

Note: *Make sure to switch on the ignition and the radio. Shift the transmission into park (P) for automatic transmission or first gear for manual transmission.*

Using the Audio System

Note: *To scroll through the menus, press the up and down arrows on your audio system.*

1. Make sure to switch on your phone's Bluetooth feature before starting the search. See your device's manual if necessary.
2. Press the **Settings** button.
3. Select Bluetooth from the menu.
4. Press the **OK** button.
5. Select the option to add. This starts the pairing process.

6. When a message to begin pairing appears in the audio display, search for SYNC on your device.

Depending on your phone's capability and your market, the system may prompt you with questions, such as setting the current phone as the primary phone and downloading your phonebook.

Using Voice Commands



Make sure to switch on your phone's Bluetooth feature before starting the search. See your device's manual if necessary.

Press the voice button and when prompted say:

Voice Command	Action and Description
Pair Phone	Follow the instructions on the audio display.

Phone Voice Commands



Press the voice button. You can do things like place a phone call and access text messages. When prompted, say a command. See the following table for examples of commands.

Voice Command
___ List of Commands
Help
Call ___
Dial ___
Text Messages

__ is a dynamic listing, meaning that it could be the name of anything, such as a contact or phone number.

Phone Controls

Use the phone buttons on your steering wheel to answer, reject, or hang up a call.

Accessing Features through the Phone Menu

You can access your call history, phonebook, sent text messages, as well as access phone and system settings.

1. Press the **PHONE** button to enter the phone menu.
2. Scroll through the menu to view contacts, text messages, and the phone dialer.

SYNC™ APPLICATIONS AND SERVICES

- 911 Assist: Can alert 911 in the event of an emergency.
- SYNC AppLink: Allows you to connect to and use certain applications (if your phone is compatible).

These features may require activation. Available AppLink enabled apps vary by market.

911 Assist



WARNING: Unless the 911 Assist setting is set on before a crash, the system will not dial for help which could delay response time, potentially increasing the risk of serious injury or death after a crash.



WARNING: Do not wait for 911 Assist to make an emergency call if you can do it yourself. Dial emergency services immediately to avoid delayed response time which could increase the risk of serious injury or death after a crash. If you do not hear 911 Assist within five seconds of the crash, the system or phone may be damaged or non-functional.



WARNING: Always place your phone in a secure location in your vehicle so it does not become a projectile or get damaged in a crash. Failure to do so may cause serious injury to someone or damage the phone which could prevent 911 Assist from working properly.

Note: The SYNC 911 Assist feature must be set on before the incident.

Note: The SYNC 911 Assist feature only operates in the U.S., Canada or in a territory in which 911 is the emergency number.

Note: Before setting this feature on, make sure that you read the 911 Assist Privacy Notice later in this section for important information.

Note: If any user switches 911 Assist to on or off, that setting applies for all paired phones. If 911 Assist is switched off, either a voice message plays or a display message or an icon comes on when your vehicle is started and after a previously paired phone connects.

Note: Every phone operates differently. While SYNC 911 Assist works with most cellular phones, some may have trouble using this feature.

If a crash deploys an airbag (excluding knee airbags and rear inflatable safety belts [if equipped]) or activates the fuel pump shut-off, your SYNC-equipped vehicle may be able to contact emergency services by dialing 911 through a paired and connected Bluetooth-enabled phone.

See **Supplementary Restraints System** (page 45). Important information about airbag deployment is in this chapter.

See **Roadside Emergencies** (page 320). Important information about the fuel pump shut-off is in this chapter.

Setting 911 Assist On or Off

Press the Settings button then select:

Menu Item	Action and Description
911 Assist	Select the desired option, on or off.

To make sure that 911 Assist works properly:

- SYNC must be powered and working properly at the time of the incident and throughout feature activation and use.
- The 911 Assist feature must be set on before the incident.
- You must pair and connect a Bluetooth enabled and compatible cell phone to SYNC.
- A connected Bluetooth enabled phone must have the ability to make and maintain an outgoing call at the time of the incident.
- A connected Bluetooth enabled phone must have adequate network coverage, battery power and signal strength.
- The vehicle must have battery power and be located in the U.S., Canada or in a territory in which 911 is the emergency number.

In the Event of a Crash

Not all crashes deploy an airbag or activate the fuel pump shut-off (the triggers for 911 Assist). If a connected cell phone sustains damage or loses its connection to SYNC during a crash, SYNC searches for and tries to connect to a previously paired cell phone; SYNC then attempts to call the emergency services.

Before making the call:

- SYNC provides a short window of time (about 10 seconds) to cancel the call. If you fail to cancel the call, SYNC attempts to dial 911.
- SYNC says the following, or a similar message: "SYNC will attempt to call 911, to cancel the call, press Cancel on your screen or press and hold the phone button on your steering wheel".

If you do not cancel the call, and SYNC makes a successful call, a pre-recorded message plays for the 911 operator, and then the occupant(s) in your vehicle are able to talk with the operator. Be prepared to provide your name, phone number and location immediately, because not all 911 systems are capable of receiving this information electronically.

911 Assist May Not Work If

- Your cellular phone or 911 Assist hardware sustains damage in a crash.
- The vehicle's battery or the SYNC system has no power.
- The phone(s) thrown from your vehicle are the ones paired and connected to the system.

911 Assist Privacy Notice

When you switch on 911 Assist, it may disclose to emergency services that your vehicle has been in a crash involving the deployment of an airbag or activation of the fuel pump shut-off. Certain versions or updates to 911 Assist may also be capable of electronically or verbally disclosing to 911 operators your vehicle location or other details about your vehicle or crash to assist 911 operators to provide the most appropriate emergency services. If you do not want to disclose this information, do not switch the feature on.

SYNC Mobile Apps

The system enables voice and steering wheel control of SYNC AppLink enabled smartphone apps. When an app is running through AppLink, you can control main features of the app through voice commands and steering wheel controls.

Note: You must pair and connect your smartphone to SYNC to access AppLink.

Note: Android users need to connect the phone to SYNC using Bluetooth.

To Access Using Voice Commands

Press the voice button, then when prompted say:

Voice Command	Action and Description
Mobile Applications	Say the name of the application after the tone. The app should start. When an app is running through SYNC, you can press the voice button and speak commands specific to the app, for example "Play Playlist Road Trip".
List Applications	SYNC lists all of the currently available mobile apps.
Find Applications	Searches your connected mobile device for SYNC-compatible mobile apps.
Help	Use this command to discover the available voice commands.

Note: For information on available apps, supported smartphone devices and troubleshooting tips please visit the Ford website

Note: Availability of SYNC AppLink enabled Apps will vary by region.

Note: Make sure you have an active account for the app that you have downloaded. Some apps work automatically with no setup. Other apps want you to configure your personal settings and personalize your experience by creating stations or favorites. We recommend you do this at home or outside of your vehicle.

To Access Using the SYNC Menu

Press the Mobile Apps button to access the menu on-screen. Then select:

Menu Item	Action and Description
Find Mobile Apps	Scroll through the list of available applications and select a particular app.

Note: If you cannot find a compatible SYNC AppLink app, make sure the required app is running on the mobile device.

App Permissions

App permissions are organized by groups. You can grant these group permissions individually. You can change a permission group status any time when not driving, by using the settings menu.

When you launch an app using SYNC, the system may ask you to grant certain permissions, for example:

- To allow your vehicle to provide vehicle information to the app such as, but not limited to: Fuel level, fuel economy, fuel consumption, engine speed, rain sensor, odometer, VIN, external temperature, gear position, tire pressure, and head lamp status.
- To allow your vehicle to provide driving characteristic information such as, but not limited to: MyKey, seat belt status, engine revolutions per minute, gear position, braking events, steering wheel angle, and accelerator pedal position.
- To allow your vehicle to provide location information, including: GPS and speed.
- To allow the app to send push notifications using the vehicle display and voice capabilities while running in a background state. Push notifications may be particularly useful for news or location based apps.

Note: *You only need to grant permissions the first time you use an app with SYNC.*

Note: *Ford is not responsible or liable for any damages or loss of privacy relating to usage of an app, or dissemination of any vehicle data that you approve Ford to provide to an app.*

Enabling SYNC Mobile Apps

In order to enable mobile apps, SYNC requires user consent to send and receive app authorization information and updates using the data plan associated with the connected device.

Data is sent to Ford in the United States through the connected device. The information is encrypted and includes your VIN, SYNC module number, anonymous usage statistics and debugging information. Updates may take place.

Note: *You must enable mobile apps for each connected device the first time you select a mobile app using the system.*

Note: *Standard data rates apply. Ford is not responsible for any additional charges you may receive from your service provider, when your vehicle sends or receives data through the connected device. This includes any additional charges incurred due to driving in areas when roaming out of a home network.*

USING SYNC™ WITH YOUR MEDIA PLAYER

SYNC supports digital media sources including: iPod, Bluetooth devices, and most USB drives. SYNC also supports audio formats, such as MP3, WMA, WAV and ACC.

Media Sources

The **AUX** or **MEDIA** button allows you to view and select available media sources.

Press the **AUX** or **MEDIA** button to view your sources. Use the directional arrows and OK button to select your source. You can also use the steering wheel audio controls.

Audio Voice Commands



Press the voice button. You can do things like play a specific song or album, or tune to a radio station. When prompted, say a command. See the following table for example commands. Not all commands may be available on your vehicle.

Command
___ List of Commands
Help
Pause
Play
AM ___
FM ___
CD Player
Sirius Channel ___
USB
Bluetooth Audio

___ is a dynamic listing, meaning that it could be the name of anything, such as an artist, station, or media source.

SYNC™ TROUBLESHOOTING

Your SYNC system is easy to use. However, should questions arise, see the tables below.

Use your regional Ford website at any time to check your phone's compatibility, register your account and set preferences as well as access a customer representative via an online chat (during certain hours).

Market	Website(s)
North America	www.SYNCMyRide.com www.SYNCMyRide.ca www.sync-maroute.ca

Phone issues		
Issue	Possible cause(s)	Possible solution(s)
There is excessive background noise during a phone call.	The audio control settings on your phone may be affecting SYNC performance.	Review your phone's manual about audio adjustments.
During a call, I can hear the other person but they cannot hear me.	This may be a possible phone malfunction.	Try turning off the device, resetting the device, removing the device's battery, then trying again.
SYNC is not able to download my phonebook.	This is a phone-dependent feature.	Go to the website to review your phone's compatibility.

SYNC™ (If Equipped)

Phone issues		
Issue	Possible cause(s)	Possible solution(s)
	This may be a possible phone malfunction.	<p>Try turning off the device, resetting the device or removing the device's battery, then trying again.</p> <p>Try pushing your phonebook contacts to SYNC by using the Add Contacts feature.</p> <p>Use the SYNCmyphone feature available on the website.</p>
The system says Phonebook Downloaded but the phonebook in SYNC is empty or missing contacts.	This may be a limitation on your phone's capability.	<p>Try pushing your phonebook contacts to SYNC by using the Add Contacts feature.</p> <p>If the missing contacts are stored on your SIM card, try moving them to the device memory.</p> <p>Remove any pictures or special ring tones associated with the missing contact.</p> <p>Depending upon your phone, you may have to grant SYNC permission to access your phonebook contacts. Make sure to confirm when prompted by your phone during the phonebook download.</p>
I am having trouble connecting my phone to SYNC.	This is a phone-dependent feature.	<p>Go to the website to review your phone's compatibility.</p> <p>Try turning off the device, resetting the device or removing the device's battery, then trying again.</p>

SYNC™ (If Equipped)

Phone issues		
Issue	Possible cause(s)	Possible solution(s)
	This may be a possible phone malfunction.	<p>Try deleting your device from SYNC, deleting SYNC from your device and trying again.</p> <p>Check the security and auto accept and prompt always settings relative to the SYNC Bluetooth connection on your phone.</p> <p>Update your device's firm-ware.</p> <p>Turn off the Auto phone-book download setting.</p>
Text messaging is not working on SYNC.	<p>This is a phone-dependent feature.</p> <p>This may be a possible phone malfunction.</p>	<p>Go to the website to review your phone's compatibility.</p> <p>Try turning off the device, resetting the device or removing the device's battery, then trying again.</p>
I cannot return to the Phone menu when selecting a contact.	You are on the Select a Character screen.	Press the Phone button to return to the Phone menu.

USB and media issues		
Issue	Possible cause(s)	Possible solution(s)
I am having trouble connecting my device.	This may be a possible device malfunction.	<p>Try turning off the device, resetting the device, removing the device's battery, then trying again.</p> <p>Make sure you are using the manufacturer's cable.</p> <p>Make sure you insert the USB cable correctly into the device and the USB port.</p>

SYNC™ (If Equipped)

USB and media issues		
Issue	Possible cause(s)	Possible solution(s)
		Make sure that the device does not have an auto-install program or active security settings.
SYNC does not recognize my device when I turn on the car.	This is a device limitation.	Make sure you are not leaving the device in your vehicle during very hot or cold temperatures.
Bluetooth audio does not stream.	This is a phone-dependent feature. The device is not connected.	Review the device compatibility chart on the SYNC website to confirm your phone supports the Bluetooth audio streaming function. Make sure you correctly connect the device to SYNC, and that you have pressed play on your device.
SYNC does not recognize music that is on my device.	Your music files may not contain the correct artist, song title, album or genre information. The file may be corrupted. The song may have copy-right protection, which does not allow it to play.	Make sure that all song details are populated. Some devices require you to change the USB settings from mass storage to MTP class.
I cannot change the Sirius station.	Sirius Replay is active.	Switch radio bands and return to Sirius or switch the feature off. You can then change the Sirius station using the directional buttons.

SYNC™ (If Equipped)

Voice command issues		
Issue	Possible cause(s)	Possible solution(s)
<p>SYNC does not understand what I am saying.</p>	<p>You may be using the wrong voice commands.</p> <p>You may be speaking too soon or at the wrong time.</p>	<p>Review the phone voice commands and the media voice commands at the beginning of their respective sections.</p> <p>After pressing the voice icon, wait until after the tone sounds and Listening appears before saying a command. Any command spoken before this does not register with the system.</p>
<p>SYNC does not understand the name of a song or artist.</p>	<p>You may be using the wrong voice commands.</p> <p>You may be saying the name differently than the way you saved it.</p> <p>The system may not be reading the name the same way you are saying it.</p>	<p>Review the media voice commands at the beginning of the media section.</p> <p>Say the song or artist exactly as listed. If you say "Play Artist Prince", the system does not play music by Prince and the Revolution or Prince and the New Power Generation.</p> <p>Make sure you are saying the complete title, such as "California remix featuring Jennifer Nettles".</p> <p>If the song titles are in all CAPS, you have to spell them. LOLA requires you to say "L-O-L-A".</p> <p>Do not use special characters in the title. The system does not recognize them.</p>
<p>SYNC does not understand or is calling the wrong contact when I want to make a call.</p>	<p>You may be using the wrong voice commands.</p>	<p>Review the Phone voice commands at the beginning of the phone section.</p>

SYNC™ (If Equipped)

Voice command issues		
Issue	Possible cause(s)	Possible solution(s)
	<p>You may be saying the name differently than the way you saved it.</p> <p>The system may not be reading the name the same way you are saying it.</p> <p>Contacts in your phonebook may be very short and similar, or they may contain special characters.</p> <p>Your phonebook contacts may be in CAPS.</p>	<p>Make sure you are saying the contacts exactly as they are listed. For example, if you save a contact as Joe Wilson, say "Call Joe Wilson".</p> <p>Using the SYNC phone menu, open the phonebook and scroll to the name SYNC is having trouble understanding. SYNC will read the name to you, giving you some idea of the pronunciation SYNC is expecting.</p> <p>The system works better if you list full names, such as "Joe Wilson" rather than "Joe".</p> <p>Do not use special characters, such as 123 or ICE, as the system does not recognize them.</p> <p>If a contact is in CAPS, you have to spell it. JAKE requires you to say "Call J-A-K-E".</p>

AppLink issues		
Issue	Possible cause(s)	Possible solution(s)
<p>AppLink Mobile Applications: When I select "Find New Apps," SYNC does not find any applications.</p>	<p>An AppLink capable phone is not connected to SYNC.</p>	<p>Ensure you have a compatible smartphone; an Android with OS 2.3 or higher or an iPhone 3GS or newer with iOS 5.0 or higher. Additionally, ensure your phone is paired and connected to</p>

SYNC™ (If Equipped)

AppLink issues		
Issue	Possible cause(s)	Possible solution(s)
		<p>SYNC in order to find AppLink-capable apps on your device. iPhone users must also connect to SYNC's USB port with an Apple USB cable.</p>
<p>My phone is connected, but I still cannot find any apps.</p>	<p>AppLink-enabled apps are not installed and running on your mobile device.</p>	<p>Ensure you have downloaded and installed the latest version of the app from your phone's app store. Ensure the app is running on your phone. Some apps require you to register or login on the app on the phone before using them with AppLink. Also, some may have a "Ford SYNC" setting, so check the app's settings menu on the phone.</p>
<p>My phone is connected, my app(s) are running, but I still cannot find any apps.</p>	<p>Sometime apps do not properly close and re-open their connection to SYNC, over ignition cycles, for example.</p>	<p>Closing and restarting apps may help SYNC find the application if you cannot discover it inside the vehicle. On an Android device, if apps have an "Exit" or "Quit" option, select that then restart the app. If the app does not have that option, you can also manually "Force Close" the app by going to the phone's settings menu, selecting 'Apps.' then finding the particular app and choosing 'Force stop.' Don't forget to restart the app afterwards, then select "Find New Apps" on SYNC.</p>

SYNC™ (If Equipped)

Applink issues		
Issue	Possible cause(s)	Possible solution(s)
		On an iPhone with iOS7+, to force close an app, double tap the home button then swipe up on the app to close it. Tab the home button again, then select the app again to restart it. After a few seconds, the app should then appear in SYNC's Mobile App's Menu.
My Android phone is connected, my app(s) are running, I restarted them, but I still cannot find any apps.	There is a Bluetooth bug on some older versions of the Android operating system that may cause apps that were found on your previous vehicle drive to not be found again if you have not turned off Bluetooth.	Reset the Bluetooth on your phone by turning it off and then turning Bluetooth back on. If you are in your vehicle, SYNC should be able to automatically re-connect to your phone if you press the "Phone" button.

SYNC™ (If Equipped)

AppLink issues		
Issue	Possible cause(s)	Possible solution(s)
My iPhone phone is connected, my app is running, I restarted the app but I still cannot find it on SYNC.	The USB connection to SYNC may need to be reset.	Unplug the USB cable from the phone, wait a moment, and plug the USB cable back in to the phone. After a few seconds, the app should appear in SYNC's Mobile Apps Menu. If not, "Force Close" the application and restart it.
I have an Android phone. I found and started my media app on SYNC, but there is no sound or the sound is very low.	The bluetooth volume on the phone may be low.	Try increasing the Bluetooth volume of the device by using the device's volume control buttons which are most often found on the side of the device.
I can only see some of the AppLink apps running on my phone listed in SYNC's Mobile Apps Menu.	Some Android devices have a limited number of bluetooth ports apps can use to connect. If you have more AppLink apps on your phone than the number of available Bluetooth ports, you will not see all of your apps listed in SYNC's mobile apps menu.	Force close or uninstall the apps you do not want SYNC to find. If the app has a "Ford SYNC" setting, disable that setting in the app's settings menu on the phone.

SYNC System Reset

The SYNC system in your vehicle has System Reset feature that can be performed if the function of a SYNC feature is lost. This reset is intended to restore functionality and will not erase any information previously stored in the system (Such as paired devices, phonebook, call history, text messages, or user settings). To perform a System Reset, press and hold the Seek Up (>>) button while pressing and holding the Radio Power button. Release both buttons after 2-3 seconds. Please allow a few minutes for the reset to complete. After a few minutes has passed you can resume using the SYNC system.

GENERAL INFORMATION



WARNING: Driving while distracted can result in loss of vehicle control, crash and injury. We strongly recommend that you use extreme caution when using any device that may take your focus off the road. Your primary responsibility is the safe operation of your vehicle. We recommend against the use of any hand-held device while driving and encourage the use of voice-operated systems when possible. Make sure you are aware of all applicable local laws that may affect the use of electronic devices while driving.

About SYNC

The system allows you to interact with the entertainment, information and communication systems on your vehicle using voice commands and a touchscreen. The system provides easy interaction with audio, phone, navigation, mobile apps and settings.

Note: You can switch the system on and use it for up to an hour without switching the ignition on.

Note: You can use the system after you switch the ignition off for up to 10 minutes or until you open a door.

Note: For your safety, some features are speed-dependent. Their use is limited to when your vehicle speed is less than 3 mph (5 km/h).

Using the Touchscreen

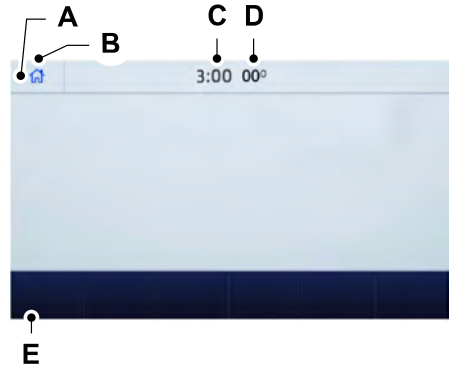

- A Status bar.
- B Home screen.
- C Clock. See **Settings** (page 535).
- D Outside air temperature.
- E Feature bar.

Status Bar

-  Cell phone microphone muted.
-  Audio system muted.
-  Software update installed.
-  Wi-Fi connected.
-  Cell phone roaming.
-  Text message received.



Automatic crash notification system off.



Cell phone network signal strength.



Vehicle data sharing on.



Vehicle location sharing on.



Vehicle data and vehicle location sharing on.



Wireless charger active.

Feature Bar



Select to use the radio, a USB, a media player or a Bluetooth device. See **Entertainment** (page 513).



Select to adjust climate settings. See **Climate** (page 523).



Select to make calls and access the phonebook on your cell phone. See **Phone** (page 525).



Select to use the navigation system. See **Navigation** (page 527).



Select to search for and use compatible apps on your iOS or Android device. See **Apps** (page 532).



Select to adjust system settings. See **Settings** (page 535).

Cleaning the Touchscreen

See **Cleaning the Interior** (page 388).

Updating the System

Updating the System Using a USB Drive

Downloading an Update

1. Go to the SYNC update page on the local Ford website.
2. Download the update.

Note: *The website notifies you if an update is available.*

3. Insert a USB drive into your computer.

Note: *The USB drive needs to be empty and meet the minimum requirements detailed on the website.*

4. Follow the instructions provided to download the update to the USB drive.

Installing an Update

Note: *You can use the system when an installation is in progress.*

1. Disconnect all other USB devices from the USB ports.
2. Connect the USB drive with the update to a USB port.

Note: *Installation starts automatically within 10 minutes.*

Updating the System Using a Wi-Fi Network Connection

Connecting to a Wi-Fi Network



Select the settings option on the feature bar.

1. Select **Automatic Updates**.
2. Select **System Wi-Fi**.
3. Switch **System Wi-Fi** on.
4. Select **Available Wi-Fi Networks**.
5. Select an available Wi-Fi network.

Note: *Enter the network password to connect to a secure network.*

Switching Automatic System Updates On



Select the settings option on the feature bar.

1. Select **Automatic Updates**.
2. Switch **Automatic System Updates** on.

The system is now set to check for and receive system updates when it is connected to a Wi-Fi network.

Note: You can use the system when a download is in progress.

Note: If the system is disconnected from the Wi-Fi network when a download is in progress, the download continues the next time the system is connected to a Wi-Fi network.

Additional Information and Assistance

For additional information and assistance, we recommend that you contact an authorized dealer or refer to the local Ford website.

USING VOICE RECOGNITION

The system allows you to interact with the entertainment, information and communication systems on your vehicle using voice commands. This allows you to keep your hands on the steering wheel and focus on what is in front of you.



Press the voice control button on the steering wheel and wait for the voice prompt.

Note: Press the voice control button again to interrupt a voice prompt and begin speaking.

Note: Turn the volume control when a voice prompt plays to adjust the volume.

Note: Press and hold the voice control button on the steering wheel to use Siri on your iOS device.

The following voice commands are designed to help you from any screen:

- **List of Commands**
- **Help**

The following tables list some of the more frequently used voice commands. For a complete list of voice commands, refer to our website.

General

Voice Command	Description
___ List of Commands	Get a list of voice commands for a specific feature. ¹
Cancel	Cancel an active voice session.
___ Help	Get a list of voice commands for a specific feature. ¹
Go back	Return to the previous screen.
Main Menu	Go to the main menu.

SYNC™ 3 (If Equipped)

Voice Command	Description
Next Page	Go to the next page.
Previous Page	Go to the previous page.

¹ Add the name of the feature to the command.

Entertainment

Audio Source

Voice Command	Description
Radio	Use the radio.
CD Player	Use the CD player.
Bluetooth Stereo	Use a Bluetooth device.
USB	Use a USB or media player.

Radio

Voice Command	Description
AM	Listen to AM radio.
AM ____	Tune to a specific AM frequency. ¹
Sirius Channel ____	Listen to SiriusXM radio. ²
FM	Listen to FM radio.
FM ____	Tune to a specific FM frequency. ¹

¹ Add the radio frequency to two decimal places to the command.

² You can say the Sirius channel name or number such as "Sirius Channel 16" or "Sirius The Pulse".

SYNCTM 3 (If Equipped)

USB and Media Player

Voice Command	Description
Play Album ___	Play your music by category. ¹
Play Artist ___	
Play Genre ___	
Play Playlist ___	
Play Song ___	
Play Audiobook ___	
Play Podcast ___	
Browse All Albums	Browse music on a USB device.
Browse All Artists	
Browse All Audiobooks	
Browse All Genres	
Browse All Playlists	
Browse All Podcasts	
Browse All Songs	
Browse Album ___	Browse your music by category on a USB device. ¹
Browse Artist ___	
Browse Audiobook ___	
Browse Genre ___	
Browse Playlist ___	
Browse Podcast ___	

¹ Add an album name, artist name, audiobook name, genre name, playlist name, podcast name or track name to the command. Say the name exactly as it appears on your device.

Climate (If Equipped)

You can control the temperature of the vehicle using voice commands.

___ is a dynamic listing, meaning that for climate voice commands it can be the desired degrees for the temperature setting.

SYNC™ 3 (If Equipped)

To adjust the temperature, say:

Voice command	Description
Set Temperature ___	Adjust the temperature between 60–85°F (15.5–29.5°C).

Phone

Voice Command	Description
Pair Phone	Pair a cell phone or Bluetooth enabled device.
Redial	Redial the last number that you dialed.
Dial ___	Dial a number. ¹
Call ___	Call a specific contact from your phonebook. ²
Call ___ ___	Call a specific contact from your phonebook at a specific location. ³
Listen to Message	Listen to a text message.
Listen to Message ___	Listen to a specific text message from a list of text messages.
Reply to Message	Reply to the last text message.

¹ Add the number you want to dial to the command.

² Add a contact name from your phonebook to the command. Say the first and last name of your contact exactly as it appears on your device.

³ Add a contact name and location from your phonebook to the command. Say the first and last name of your contact exactly as it appears on your device.

SYNCTM 3 (If Equipped)

Navigation (If Equipped)

Setting a Destination

Voice Command	Description
Find an Address	Enter a destination address. When prompted, provide the house number, the street and city.
Find a Place	Search for a point of interest by name or by category.
Find the Next ___	Search for a nearby point of interest by category. ¹
Find a POI Category	Search for a point of interest category. ¹
Drive Home	Set your saved home address as your destination.
Drive to Work	Set your saved place of work as your destination.
Show Previous Destinations	Display and select from a list of previous destinations.
Show Favorites	Display and select from a list of favorite destinations.

¹ Add a point of interest category or the name of a major brand or chain to the command.

Route Guidance

Voice Command	Description
Cancel Route	Cancel the current route.
Detour	Select an alternate route.
Repeat Instruction	Repeat the last guidance prompt.
Show Route	Display an overview of the route.
Show Traffic	Display a list of traffic events on your route.
Show Map	Display the map on the touchscreen.
North Up	Display a two-dimensional map with north toward the top of the touchscreen.
Heading Up	Display a two-dimensional map with the direction you are traveling toward the top of the touchscreen.
Show 3D	Display a three-dimensional map with the direction you are traveling toward the front.

SYNC™ 3 (If Equipped)

Apps

General

Voice Command	Description
Mobile Applications	Start an app. The system prompts you for the app name.
List Applications	Get a list of apps running on your device.
Find Applications	Search and connect to apps running on your device.

Active App

Voice Command	Description
___ Help	Get a list of voice commands for a specific app. ¹
Exit ___	Close an app. ¹

¹Add an app name to the command.

SiriusXM Traffic and Travel Link (If Equipped)

Voice command	Description
Show Traffic	Displays a list of traffic incidents.
Show Weather Map	Displays the current weather map.
Show Fuel Prices	Displays a list of fuel prices.
Show 5 Day Forecast	Displays the 5 day weather forecast.

Voice Settings

Voice Command	Description
Voice Settings	Go to the voice settings menu.
Interaction Mode Novice	Switch long voice prompts on.
Interaction Mode Advanced	Switch short voice prompts on.
Phone Confirmation On	Switch call confirmation on. The system prompts you to confirm before making a call.
Phone Confirmation Off	Switch call confirmation off. The system does not prompt you to confirm before making a call.
Voice Command Lists On	Switch the display of voice commands on.
Voice Command Lists Off	Switch the display of voice commands off.

Automatic Blower Motor Speed Reduction

If necessary, the system decreases the blower motor speed when you are using voice commands to reduce the amount of background noise in your vehicle. It returns to normal when you are done.

Switching Automatic Blower Motor Speed Reduction Off

Simultaneously press the **A/C** and recirculated air buttons.

ENTERTAINMENT

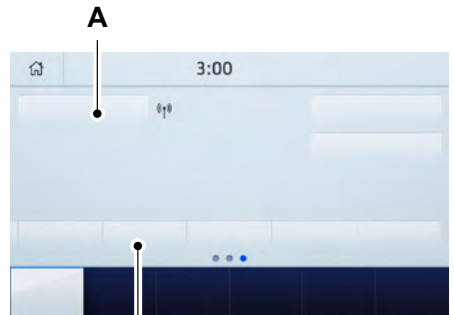

- A Audio source. Select to choose a different audio source.
- B Presets. Swipe left to view more presets.

You can access these options using the touchscreen or voice commands.

SYNC™ 3 (If Equipped)

Sources

Press this button to select the source of media you want to listen to.

Menu Item	
AM	
FM	
SIRIUS ¹	
CD ¹	
USB	The name of the USB that is plugged in displays here.
Bluetooth Stereo	
Apps	If you have SYNC 3 compatible apps on your connected smart phone, they display here as individual source selections.

¹ This feature may not be available in all markets and requires an active subscription.

AM/FM Radio

Tuning a Station

You can use the tune or seek controls on the radio bezel to select a station.

To tune a station using the touchscreen, select:

Menu Item
Direct Tune

A pop up appears, allowing you to type in the frequency of a station. You can only enter a valid station for the source you are currently listening to.

You can press the backspace button to delete the previously entered number.

Once you have entered the station's call numbers, you can select:

Menu Item	Action and Description
Enter	Press to begin playing the station you have entered.
Cancel	Press to exit without changing the station.

Presets

To set a new preset, tune to the station and then press and hold one of the memory preset buttons. The audio mutes briefly while the system saves the station and then returns.

You may be able to add additional preset pages using the settings option on the feature bar.

SYNCTM 3 (If Equipped)

SiriusXM® Satellite Radio (If Activated)

Note: This feature may not be available in all markets and requires an active subscription.



E234451

SiriusXM satellite radio is a subscription-based satellite radio service that broadcasts a variety of music, sports, news, weather, traffic and entertainment programming. Your factory-installed SiriusXM satellite radio system includes hardware and a limited subscription term that begins on the date of sale or lease of your vehicle. See an authorized dealer for availability.

For more information on extended subscription terms (a service fee is required), the online media player and a list of SiriusXM satellite radio channels, and other features, please visit www.siriusxm.com in the United States, www.siriusxm.ca in Canada, or call SiriusXM at 1-888-539-7474.

Note: SiriusXM reserves the unrestricted right to change, rearrange, add or delete programming. This includes canceling, moving or adding particular channels, and its prices, at any time, with or without notice to you. We are not responsible for any such programming changes.

Note: This receiver includes the eCos real-time operating system. eCos is published under the eCos License.

The following buttons are available for SiriusXM:

Menu Item	Action and Description	
Browse	Touch this button to see a list of available stations.	
Direct Tune	A pop-up appears, allowing you to type in the call numbers of a station. Once you enter the stations call numbers, you can select:	
	Enter	The system tunes to the station you select.
	Cancel	You exit the pop-up and the current station continues to play.
	You can press the backspace button to delete the previous number.	

SYNC™ 3 (If Equipped)

Menu Item	Action and Description	
Replay	Replay audio on the current channel. You can replay approximately 45 minutes of audio as long as you remain tuned to the current station. Changing stations erases the previous audio.	
	Live	When you are in replay mode, you are not able to select a different preset until you return to live audio. Pressing this button returns you to the live broadcast.
ALERT	Save the current song, artist, or team as a favorite. The system alerts you when it plays again on any channel. Selecting this button allows you to enable and edit alerts. See Settings (page 535).	

Memory Presets

To set a preset, tune to the station then press and hold one of the memory preset buttons. The audio mutes briefly while the system saves the station and returns once the station is stored.

You may be able to add additional preset pages using the settings option on the feature bar.

SiriusXM Satellite Radio Reception Factors and Troubleshooting

Potential Reception Issues	
Antenna obstructions	For optimal reception performance, keep the antenna clear of snow and ice build-up and keep luggage and other materials as far away from the antenna as possible.
Terrain	Hills, mountains, tall buildings, bridges, tunnels, freeway overpasses, parking garages, dense tree foliage and thunderstorms can interfere with your reception.
Station overload	When you pass a ground-based broadcast-repeating tower, a stronger signal may overtake a weaker one and the audio system may mute.
Satellite radio signal interference	Your display may show ACQUIRING... to indicate the interference and the audio system may mute.

SYNCTM 3 (If Equipped)

Troubleshooting Tips		
Message	Cause	Action
Acquiring Signal	Radio requires more than two seconds to produce audio for the selected channel.	No action required. This message should disappear shortly.
Satellite antenna fault SIRIUS system failure	There is an internal module or system failure present.	If this message does not clear shortly, or with an ignition key cycle, your receiver may have a fault. See an authorized dealer for service.
Invalid Channel	The channel is no longer available.	Tune to another channel or choose another preset.
Unsubscribed Channel	Your subscription does not include this channel.	Contact SiriusXM at 1-888-539-7474 to subscribe to the channel, or tune to another channel.
Satellite acquiring signal...	The signal is lost from the SiriusXM satellite or SiriusXM tower to your vehicle antenna.	The signal is blocked. When you move into an open area, the signal should return.
Updating...	Update of channel programming in progress.	No action required. The process may take up to three minutes.
Questions? Call 1-888-539-7474	Your satellite service is no longer available.	Contact SiriusXM at 1-888-539-7474 to resolve subscription issues.
None found. Check channel guide.	All the channels in the selected category are either skipped or locked.	Use the channel guide or the Sirius XM Settings tile to turn off the Lock or Skip function on that station.
SIRIUS Subscription updated	SiriusXM has updated the channels available for your vehicle.	No action required.

HD Radio™ Information (If Available)

To activate HD radio, please see the Radio Settings in the Settings Chapter. See **Settings** (page 535).

Note: *HD Radio broadcasts are not available in all markets.*

SYNC™ 3 (If Equipped)

HD Radio technology is the digital evolution of analog AM/FM radio. Your system has a special receiver that allows it to receive digital broadcasts (where available) in addition to the analog broadcasts, it already receives. Digital broadcasts provide a better sound quality than analog broadcasts with free, crystal-clear audio and no static or distortion. For more information, and a guide to available stations and programming, please visit:

Website
www.hdradio.com

When HD Radio is on and you tune to a station broadcasting HD Radio technology, you may notice the following indicators on your screen:



E142616

When HD Radio broadcasts are active, you can access the following functions:

Message	Action and Description
Presets	Allows you to save an active channel as a memory preset. Touch and hold a memory preset slot until the sound returns. There is a brief mute while the radio saves the station. Sound returns when the channel saves. When switching to an HD2 or HD3 memory preset, the sound mutes before the digital audio plays, because the system has to reacquire the digital signal.

Note: As with any station you save, you cannot access the saved station if your vehicle is outside the station's reception area.

The HD logo is grey when acquiring a digital station, and then changes to orange when digital audio is playing. When this logo is available, you may also see Title and Artist fields on-screen.

The multicast indicator appears in FM mode (only) if the current station is broadcasting multiple digital broadcasts. The highlighted numbers signify available digital channels where new or different content is available. HD1 signifies the main programming status and is available in analog and digital broadcasts. Other multicast stations (HD2 through HD7) are only available digitally.

Note: There is also an additional feature for stations that have more than 1 HD multicast (For example, HD1 or HD2). The HD logo and Radio text appears as a button. Pressing this button allows you to cycle through all of the HD stations on that specific frequency. For example, if you are on 101.1 and it has HD1, HD2, HD3, pressing the button repeatedly causes the radio to cycle through the HD stations in a cyclic increasing order.

SYNCTM 3 (If Equipped)

HD Radio Reception and Station Troubleshooting

Potential Reception Issues	
Reception area	<p>If you are listening to a multicast station and you are on the fringe of the reception area, the station may mute due to weak signal strength.</p> <p>If you are listening to HD1, the system changes back to the analog broadcast until the digital broadcast is available again. However, if you are listening to any of the possible HD2-HD7 multicast channels, the station mutes and stays muted unless it is able to connect to the digital signal again.</p>
Station blending	<p>When the system first receives a station (aside from HD2-HD7 multicast stations), it first plays the station in the analog version. Once the receiver verifies the station is an HD Radio station, it shifts to the digital version. Depending on the station quality, you may hear a slight sound change when the station changes from analog to digital. Blending is the shift from analog to digital sound or digital back to analog sound.</p>

In order to provide the best possible experience, use the contact form to report any station issues found while listening to a station broadcasting with HD Radio technology. Independent entities own and operate each station. These stations are responsible for ensuring all audio streams and data fields are accurate.

Potential Station Issues		
Issues	Cause	Action
Echo, stutter, skip or repeat in audio. Increase or decrease in audio volume.	This is poor time alignment by the radio broadcaster.	No action required. This is a broadcast issue.
Sound fading or blending in and out.	The radio is shifting between analog and digital audio.	No action required. The reception issue may clear up as you continue to drive.
There is an audio mute delay when selecting HD2 or HD3, multicast preset or Direct Tune.	The digital multicast is not available until the HD Radio broadcast is decoded. Once decoded, the audio is available.	No action required. This is normal behavior. Wait until the audio is available.

SYNC™ 3 (If Equipped)

Potential Station Issues		
Issues	Cause	Action
Cannot access HD2 or HD3 multicast channel when recalling a preset or from a direct tune.	The previously stored multicast preset or direct tune is not available in your current reception area.	No action required. The station is not available in your current location.
Text information does not match currently playing audio.	Data service issue by the radio broadcaster.	Fill out the station issue form. ¹
There is no text information shown for currently selected frequency.	Data service issue by the radio broadcaster.	Fill out the station issue form. ¹

¹ You can find the form here:

Website
http://hdradio.com/stations/feedback

HD Radio Technology manufactured under license from iBiquity Digital Corporation and foreign patents. HD Radio and the HD and HD Radio logos are proprietary trademarks of DTS. The vehicle manufacturer and DTS are not responsible for the content sent using HD Radio technology. Content may be changed, added or deleted at any time at the station owner's discretion.

CD (If equipped)

Once you select this option, the system returns you to the main audio screen.

The current audio information appears on the screen.

The following buttons are also available:

Button	Function
Browse	You can use the browse button to select a track.
Repeat	Select this button and a small number one displays to indicate the track is set to repeat.

SYNC™ 3 (If Equipped)

Button	Function
	For MP3 CDs, this button allows you to toggle through repeat off, repeat one track (a small number one displays), and repeat current folder (a small folder displays).
Shuffle	Select the shuffle symbol to have the audio on the disk play in random order.

You can use the forward, reverse, pause or play buttons to control the audio playback.

Bluetooth Stereo or USB

Bluetooth Stereo and USB allow you to access media that you store on your Bluetooth device or USB device such as music, audio books or podcasts.

The following buttons are available for Bluetooth and USB:

Button	Function
Repeat	Pressing the repeat button toggles the repeat setting through three modes: repeat off (button not highlighted), repeat all (button highlighted) and repeat track (button highlighted with a small number one).
Shuffle	Play the tracks in random order.

You can use the forward, reverse, pause or play buttons to control the audio playback.

To get more information about the currently playing track, press the cover art or Info button.

For some devices, SYNC 3 is able to provide 30-second skip buttons when you listen to audio books or podcasts. These buttons allow you to skip forward or backward within a track.

While playing audio from a USB device you can look for certain music by selecting the following:

Button	Function
Browse	If available, displays the list of tracks in the Now Playing playlist.
New Search	This option, which is available under browse, allows you to play all tracks or to filter the available media into one of the below categories.
	Play All

SYNC™ 3 (If Equipped)

Button	Function
	Playlists
	Artist
	Albums
	Songs
	Genres
	Podcasts
	Audio books
	Composers
A-Z Jump	This button allows you to choose a specific letter to view within the category you are browsing.
Explore Device	If available, this allows you to browse the folders and files on your USB device.

USB Ports

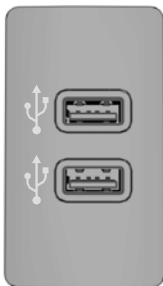

E211463

The USB ports are in the center console or behind a small access door in the instrument panel.

This feature allows you to plug in USB media devices, memory sticks, flash drives or thumb drives, and charge devices if they support this feature.

Select this option to play audio from your USB device.

Apps

The system supports the use of certain audio apps such as iHeartRadio through a USB or Bluetooth enabled device.

Each app gives you different on-screen options depending on the app's content. See **Apps** (page 532).

Supported Media Players, Formats and Metadata Information

The system is capable of hosting nearly any digital media player, including iPod, iPhone, and most USB drives.

Supported audio formats include MP3, WMA, WAV, AAC, and FLAC.

Supported audio file extensions include MP3, WMA, WAV, M4A, M4B, AAC, and FLAC.

SYNC™ 3 (If Equipped)

Supported USB file systems include: FAT, exFAT, and NTFS.

SYNC 3 is also able to organize the media from your USB device by metadata tags. Metadata tags, which are descriptive software identifiers embedded in the media files, provide information about the file.

If your indexed media files contain no information embedded in these metadata tags, SYNC 3 may classify the empty metadata tags as unknown.

SYNC 3 is capable of indexing up to 50,000 songs per USB device, for up to 10 devices.

CLIMATE

Touch the climate button on the touchscreen to access your climate control features.

Note: You can switch temperature units between Fahrenheit and Celsius. See **Settings** (page 535).

Accessing the Climate Control Menu



Touch the button to access additional controls for the front climate system.

Directing the Airflow



Touch the button to direct airflow to the windshield air vents and de-mister.



Touch the button to direct airflow to the instrument panel air vents.



Touch the button to direct airflow to the footwell air vents.

You can direct air through any combination of these air vents.

Setting the Blower Motor Speed



Touch up or down to increase or decrease the volume of air that circulates in your vehicle.

Setting the Temperature

Touch up or down on the left-hand temperature control to set the left-hand temperature.

Note: This control also adjusts the right-hand side temperature when you switch off dual zone mode.

Touch up or down on the right-hand temperature control to set the right-hand temperature.

Switching Auto Mode On and Off



Touch the button to switch on automatic operation, then set the temperature.

The system adjusts the blower motor speed, air distribution, air conditioning operation, and outside or recirculated air to reach and maintain the temperature you have set.

Switching the Air Conditioning On and Off



A pop-up appears on the screen to display the air conditioning options.

MAX A/C: Touch the button to activate and maximize cooling. The driver and passenger temperatures are set to LO, recirculated air flows through the instrument panel vents, air conditioning automatically turns on and the fan automatically adjusts to the highest speed.

A/C: Touch to switch the air conditioning on or off. Use A/C with recirculated air to improve cooling performance and efficiency.

Note: In certain conditions, such as maximum defrost, the air conditioning compressor may continue to operate even though you switch off the air conditioning.

Switching the Climate Control On and Off



Touch the button.

Switching the Climate Controlled Seats On and Off



Touch the button to cycle through the various climate controlled seat settings.

Switching Dual Zone Mode On and Off



Touch the button to switch on temperature control for the right-hand side of the vehicle.

Switching the Heated Exterior Mirrors On and Off



Touch the button.

Switching the Heated Windshield On and Off



Touch the button to clear the windshield of thin ice and fog. The heated windshield turns off after a short period of time.

Switching the Heated Rear Window On and Off



Touch the button to clear the rear window of thin ice and fog.

Switching the Heated Seats On and Off



Touch the button to cycle through the various heat settings.

Switching the Heated Steering Wheel On and Off



Touch the button.

Switching Maximum Air Conditioning On and Off



Touch the button for maximum cooling.

Recirculated air flows through the instrument panel air vents, air conditioning turns on and the blower motor adjusts to the highest speed.

Switching Maximum Defrost On and Off



Touch the button for maximum defrosting.

Air flows through the windshield air vents, and the blower motor adjusts to the highest speed.

You can also use this setting to defog and clear the windshield of a thin covering of ice.

Note: To prevent window fogging, you cannot select recirculated air when maximum defrost is on.

SYNC™ 3 (If Equipped)

Note: The heated rear window also turns on when you select maximum defrost.

Switching Recirculated Air On and Off



Touch the button to switch between outside air and recirculated air.

The air currently in the passenger compartment recirculates. This may reduce the time needed to cool the interior, when used with **A/C**, and reduce unwanted odors from entering your vehicle.

Note: Recirculated air may turn off, or prevent you from switching on, in all air flow modes except **MAX A/C** to reduce the risk of fogging. Recirculation may also turn on and off in various air distribution control combinations during hot weather to improve cooling efficiency.

Switching the Ventilated Seats On and Off



Touch the button to cycle through the various ventilated seat settings.

Accessing Rear Climate Controls



Touch the button to access additional controls for the rear climate system.

Rear Climate Control Lock Indicator



Touch the button.

When on, you can only operate the rear passenger settings through the front controls.

Switching Rear Auto Mode On and Off



Touch the button to switch on rear automatic operation, then set the temperature.

Switching the Rear Climate Controlled Seats On and Off



Touch the button to cycle through the various climate controlled seat settings.

Switching the Rear Heated Seats On and Off



Touch the button to cycle through the various heat settings.

Switching the Rear Ventilated Seats On and Off



Touch the button to cycle through the various ventilated seat settings.

PHONE

 **WARNING:** Driving while distracted can result in loss of vehicle control, crash and injury. We strongly recommend that you use extreme caution when using any device that may take your focus off the road. Your primary responsibility is the safe operation of your vehicle. We recommend against the use of any hand-held device while driving and encourage the use of voice-operated systems when possible. Make sure you are aware of all applicable local laws that may affect the use of electronic devices while driving.

Check the compatibility of your device on the regional website.

Pairing Your Cell Phone for the First Time

Go to the settings menu on your cell phone and switch Bluetooth on.



Select the phone option on the feature bar.

1. Select **Add Phone**.

Note: A prompt alerts you to search for your vehicle on your cell phone.

2. Select your vehicle on your cell phone.

Note: A number appears on your cell phone and on the touchscreen.

3. Confirm that the number on your cell phone matches the number on the touchscreen.

Note: The touchscreen indicates that you have successfully paired your cell phone.

4. Download the phonebook from your cell phone when you are prompted.

Note: If you pair more than one cell phone, use the phone settings to specify the primary phone. You can change this setting at any time.

Using Your Cell Phone

Recent Call List

Display and select an entry from a list of previous calls.

Contacts

Display a smart search form to look up your contacts. Use the List button to alphabetically sort your contacts.

Change Phone

Display the list of paired or connected devices that you can select.

Phone Settings

Change ring tones, alerts or pair another phone.

Do Not Disturb

Reject incoming calls and switch ring tones and alerts off.

Phone Keypad

Directly dial a number.

Mute

Mute the microphone when in a call or voice recognition session.

Text Messaging

Setting Text Message Notification

iOS

1. Go to the settings menu on your cell phone.
2. Select Bluetooth.
3. Select the information icon to the right of your vehicle.
4. Switch text message notification on.

Android

1. Go to the settings menu on your cell phone.
2. Select Bluetooth.
3. Select the profiles option.
4. Select the phone profile.
5. Switch text message notification on.

SYNCTM 3 (If Equipped)

Using Text Messaging

Menu Item	Description
Hear It	Hear the text message.
View	View the text message.
Call	Call the sender.
Reply	Reply to the text message with a standard text message.

Apple CarPlay (If Equipped)

1. Connect your device to a USB port.
2. Follow the instructions on the touchscreen.

Note: Certain features of the system are not available when you are using Apple CarPlay.

Switching Apple CarPlay Off



Select the settings option on the feature bar.

1. Select **Apple CarPlay Preferences**.
2. Switch **Apple CarPlay** off.

Android Auto (If Equipped)

1. Connect your device to a USB port.
2. Follow the instructions on the touchscreen.

Note: You might need to enable Android Auto from the settings menu.

Note: Certain features of the system are not available when you are using Android Auto.

Switching Android Auto Off



Select the settings option on the feature bar.

1. Select **Android Auto**.

2. Switch **Android Auto** off.

NAVIGATION (IF EQUIPPED)

Note: For more information, refer to our website.



Select the navigation option on the feature bar.



- A Map view menu.
- B Zoom out.
- C Zoom in.
- D Route guidance menu.
- E Destination entry menu.

Setting a Destination

Destination Entry Menu

Item	Description
Search	Enter a destination address.
Previous Destinations	Display and select from a list of previous destinations.
Home	Set your saved home address as your destination
Work	Set your saved place of work as your destination.
Favorites	Display and select from a list of favorite destinations.

Setting a Destination Using the Text Entry Screen

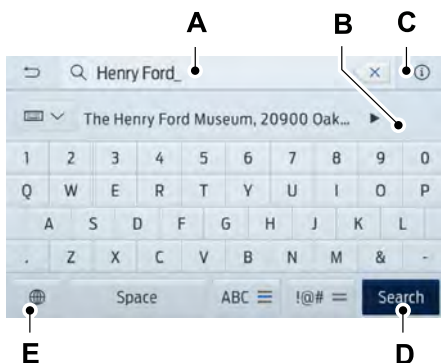

- A Text entry field.
- B Automatic suggestions based on the text you enter.
- C Information icon.
- D Search.
- E Keyboard settings.

You can search by entering all or part of the destination, such as the Address, POI Category or Name, Intersection, City, Latitude/Longitude, etc. Tips: If you do not specify a location, the system will use the current vehicle location. You can specify a location by address, city, state or zip code. For additional search support, please visit: support.ford.com.

Note: Press the button in the top right-hand corner of the main map to display estimated time of arrival, remaining travel time or distance to destination.

Note: Select one of the suggestions to copy the detail to the text entry field.

Setting a Destination Using the Map Screen

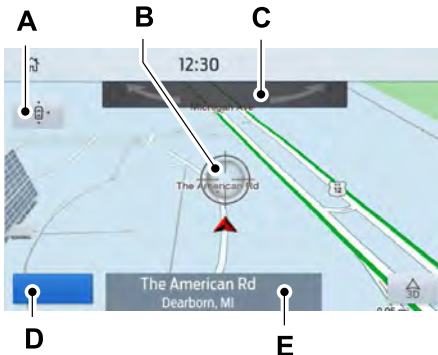

- A Re-center the map.
- B Selected location.
- C 3D map rotation. Swipe left or right.
- D Start route guidance.
- E Destination name.

Select the location on the map.

Select **Start** to begin route guidance.

Changing the Format of the Map

Display the map in one of the following formats:

- A two-dimensional map with the direction you are traveling toward the top of the screen.
- A two-dimensional map with north toward the top of the screen.
- A three-dimensional map with the direction you are traveling toward the front.

Zoom

Display more or less detail on the map.

Note: You can use pinch gestures to zoom in and out. Place two fingers on the screen and move them apart to zoom in. Place two fingers on the screen and bring them together to zoom out.

Route Guidance

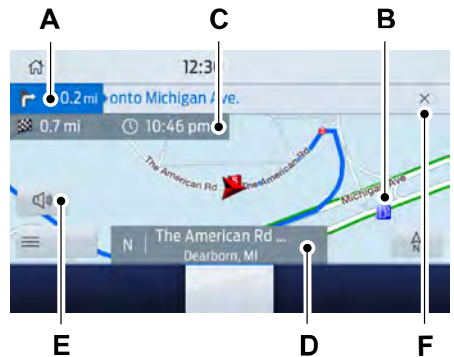

- A Turn indicator. Select to hear the last voice prompt.
- B Point of interest.
- C Estimated time of arrival, distance to destination or time to destination.
- D Current road.
- E Mute guidance prompts.
- F Cancel route guidance.

Note: To change guidance prompt volume, turn the volume control when a guidance prompt plays.

Route Guidance Menu

Menu Item	Description
Screen View	Adjust your map preferences for when route guidance is active.
Full Map	View a full screen map when route guidance is active.
Highway Exit Info	View highway exit information for your current route.
Turn List	View the turn list for your current route. Select a road to avoid it.
Traffic List	You can find the SiriusXM Traffic and Travel Link information by pressing this button. This information requires an active subscription to SiriusXM Traffic and Travel Link. When a route is not active, a list of nearby traffic incidents displays. When a route is active, you can choose to display a list of traffic nearby or on the route.
Navigation Settings	Adjust navigation settings. See Settings (page 535).
Where Am I?	View information about your current location.
Cancel Route	Cancel route guidance.
View Route	View the entire current route on the map.
Detour	View an alternative route compared to your current one.
Edit Waypoints	Change the order or remove waypoints.
Optimize Order	The system determines the order of waypoints for you.
Go	Go to the next screen and start the new route.

Adjusting the Guidance Prompt Volume

Turn the volume control when a guidance prompt plays to adjust the volume.

Note: *If you have inadvertently adjusted the volume to zero, press the turn indicator button to play the last voice prompt and then adjust the volume to the desired level.*

Muting Guidance Prompts



Select the mute option on the screen to mute guidance prompts.

Note: *The system mutes the next and all future guidance prompts.*

Adding Waypoints

You can add a waypoint to a navigation route as a destination along your route. You can add up to five waypoints.

1. Select the search option on the map.
2. Set a destination.
3. Select **Add Waypoint**.
4. Select **Go**.

Canceling Route Guidance



Select the route guidance menu option on the active guidance screen.

Select **Cancel Route**.

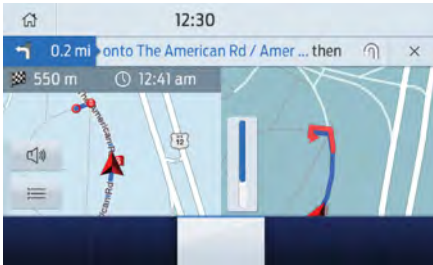

Note: The route guidance menu option is always in the bottom right-hand corner of the main map.

cityseeker (If Equipped)

Note: cityseeker point of interest (POI) information is limited to approximately 1,110 cities (1,049 in the United States, 36 in Canada and 15 in Mexico).

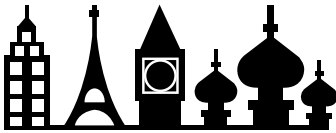

cityseeker

E225487

cityseeker, when available, is a service that provides more information about certain points of interest such as restaurants, hotels and attractions.

When you have selected a point of interest, the location and information appear, such as address, phone number and a star rating.

Press **More Information** to see a photo, a review, a list of services and facilities, the average room or meal price and the web address. This screen displays the point of interest icons.

For restaurants, cityseeker can provide information such as star rating, average cost, review, handicap access, hours of operation, and website address.

For hotels, cityseeker can provide information such as star rating, price category, review, check-in and checkout times, hotel service icons and website address. Hotel service icons include:

- Restaurant
- Business center
- Handicap facilities
- Laundry
- Refrigerator
- 24 hour room service
- Fitness center
- Internet access
- Pool
- Wi-Fi

Attractions include nearby landmarks, amusement parks, historic buildings and more. cityseeker can provide information such as star rating, reviews, hour of operation and admission price.

SiriusXM Traffic and Travel Link (If Equipped)

SiriusXM Traffic and Travel Link is available on vehicles equipped with navigation and only in select markets. You must activate and subscribe to receive SiriusXM Traffic and Travel Link information. It helps you locate the best gas prices, find movie listings, get current traffic alerts, view the weather map, get accurate ski conditions and see current sports scores.

The system calculates a reasonable efficient route based on available speed limits, traffic, and road conditions. You may know a local short cut that is more efficient at a given time than the route provided by SYNC 3, but you should expect a slight difference in minutes or miles with the SYNC 3 route.

Michelin Travel Guide (If Equipped)

The Michelin travel guide is a service which provides additional information about certain places of interest, for example restaurants, hotels and tourist sites. Points of interest that have Michelin travel guide information display a button to show you more information. Push the button to see the additional information. If you have paired your phone with the system, you can press the phone button to directly establish a call with the selected point of interest.

Navigation Map Accuracy and Updates

HERE is the digital map provider for the navigation application. If you find map data errors, you may report them directly to HERE by going to www.here.com. HERE evaluates all reported map errors and responds with the result of their investigation by e-mail.

The navigation system map data may contain inaccurate or incomplete information due to the passage of time, changing circumstances, sources used and the nature of collecting comprehensive geographic data, any of which may lead to incorrect results. Inaccurate speed limit information, turn restrictions and other road attributes may affect the determined route and associated guidance

Annual navigation map updates are available for purchase through your dealership. Depending on your purchase agreement, you might be eligible for free Map update. You can choose to download the Map data update onto a USB, order a USB, or use Wi-Fi to deliver automatic updates. To update your Map data over Wi-Fi, your vehicle must be connected to a Wi-Fi access point. Map Data files are large, so it is highly recommended to perform the update when free Wi-Fi is available otherwise high data rates may apply. For USB updates, free map update eligibility, and other details, contact dealers at 1-866-462-8837 in the United States and Canada or 01-800-557-5539 in Mexico or visit our local website for more information.

APPS

The system allows you interact with select mobile apps while keeping your eyes on the road. Voice commands, your steering wheel buttons, or a quick tap on your touchscreen give you advanced control of compatible mobile apps. You can also stream your favorite music or podcasts, share your time of arrival with friends, and keep connected safely.

When you start an app through the system for the first time, you could be asked to grant certain permissions. You can review and change the permissions that you have granted at any time when your vehicle is not moving. We recommend that you check your data plan before using your apps through the system. Using them could result in additional charges. We also recommend that you check the app provider's terms and conditions and privacy policy before using their app. Make sure that you have an active account for apps that you want to use through the system. Some apps will work with no setup. Others require you to configure some personal settings before you can use them.

Note: For more information about available apps, visit catalog.ford.com.

Using Apps on an iOS Device



Select the apps option on the feature bar.

1. If your device is connected via USB, switch Apple CarPlay off. See **Phone** (page 525).
2. Connect your device to a USB port or pair and connect using Bluetooth.
3. If prompted to enable CarPlay, select **Disable**.
4. Start the apps on your device that you want to use through SYNC.

Note: If you close the apps on your device, you will not be able to use them through the system.

5. Select the app that you want to use on the touchscreen.

Note: Connect your device to a USB port if you want to use a navigation app. When using a navigation app, keep your device unlocked and the app open.

Using Apps on an Android Device



Select the apps option on the feature bar.

1. If your device is connected via USB, switch Android Auto off. See **Phone** (page 525).
2. Pair your device. See **Phone** (page 525).
3. Start the apps on your device that you want to use through SYNC.

Note: If you close the apps on your device, you will not be able to use them through the system.

4. Select **Find Mobile Apps**.

Note: The system searches and connects to compatible apps that are running on your device.

5. Select the app that you want to use on the touchscreen.

Note: Mobile Apps on your device use the USB port to establish a connection with SYNC. Some devices may lose the ability to play music over USB when Mobile Apps are enabled.

Using Mobile Navigation on an Android Device

1. Connect your device to a USB port.
2. Switch Android Auto off. See **Phone** (page 525).
3. Switch on **Enable Mobile Apps via USB** in the Mobile Apps Settings tile.
4. Select the apps option on the feature bar.
5. Select the navigation app that you want to use on the touchscreen.

Note: When using a navigation app, keep your device unlocked and the app open.

SYNC™ 3 (If Equipped)

SiriusXM Traffic and Travel Link (If Equipped)



WARNING: Driving while distracted can result in loss of vehicle control, crash and injury. We strongly recommend that you use extreme caution when using any device that may take your focus off the road. Your primary responsibility is the safe operation of your vehicle. We recommend against the use of any hand-held device while driving and encourage the use of voice-operated systems when possible. Make sure you are aware of all applicable local laws that may affect the use of electronic devices while driving.

Note: SiriusXM Traffic and Travel Link may not be available in all markets.

Note: In order to use SiriusXM Traffic and Travel Link, your vehicle must have navigation.

Note: A paid subscription is required to access and use these features. Go to www.siriusxm.com/travellink for more information.

Note: Visit www.siriusxm.com/traffic and click on Coverage map and details for a complete listing of all traffic areas covered by SiriusXM Traffic and Travel Link.

Note: Neither Sirius nor Ford is responsible for any errors or inaccuracies in the SiriusXM Traffic and Travel Link services or its use in vehicles.

When you subscribe to SiriusXM Traffic and Travel Link, it can help you locate the best gas prices, find movie listings, get current traffic alerts, view the current weather map, get accurate ski conditions and see scores to current sports games.

Menu Item	Action and Description	
Traffic on Route	Touch these buttons to identify traffic incidents on your route, near your vehicle's current location or near any of your favorite places, if programmed.	
Traffic Nearby		
Fuel Prices	Touch this button to view fuel prices at stations close to your vehicle's location or on an active navigation route.	
Movie Listings	Touch this button to view nearby movie theaters and their show times, if available.	
Weather	Touch this button to view the nearby weather, current weather, or the five-day forecast for the chosen area.	
	Map	Select to see the weather map, which can show storms, radar information, charts and winds.

SYNCTM 3 (If Equipped)

Menu Item	Action and Description	
	Area	Select to choose from a listing of weather locations.
Sports Info	Touch this button to view scores and schedules from a variety of sports. You can also save up to 10 favorite teams for easier access. The score automatically refreshes when a game is in progress.	
Ski Conditions	Touch this button to view ski conditions for a specific area.	

SETTINGS



Press the button to enter the settings menu.



Once you select a tile, press the button next to a menu item to view an explanation of the feature or setting.

Sound

Select this tile to adjust sound the settings.

Clock

Select this tile to adjust the clock settings.

Bluetooth

Select this tile to switch Bluetooth on and off and adjust the settings.

Phone

Select this tile to connect, disconnect, and manage the connected device settings.

Audio

Select this tile to adjust the audio settings.

Driver Assist (If Equipped)

Select this tile to adjust Driver Assist features like Parking Aids, Lane Keeping System, Pedestrian Detection, and Auto-Start-Stop.

Vehicle

Select this tile to adjust vehicle settings like windows, alarm, lighting, and MyKey settings.

FordPass

Select this tile to adjust the FordPass settings

General

Select this tile to adjust settings like language, measurement units, or to reset the system.

911 Assist (If Equipped)

Select this tile to switch 911 Assist on and off.

Automatic Updates

Select this tile to adjust the automatic update settings.

Mobile Apps

Select this tile to adjust permissions, enable, disable, and update mobile apps.

SYNC™ 3 (If Equipped)

Display

Select this tile to adjust display settings like brightness and auto dim.

Charge Settings (If Equipped)

Select this tile to adjust the electric vehicle charge settings.

Voice Control

Select this tile to adjust voice control settings like command confirmations and displayed lists.

Navigation (If Equipped)

Select this tile to adjust navigation settings like map preferences and route guidance.

Multi Contour Seats (If Equipped)

Select this tile to adjust the position and massage function of your multi contour seats.

Seats (If Equipped)

Select this tile to adjust the lumbar function of your seats.

Message Center (If Equipped)

Select this tile to view vehicle messages.

Personal Profiles (If Equipped)

Select this tile to adjust recalled memory features when using personal profiles.

Valet Mode (If Equipped)

Select this tile to enable and disable valet mode.

Ambient Lighting (If Equipped)

Select this tile to change the color or intensity of the interior lighting.

SYNC™ 3 TROUBLESHOOTING

Voice Recognition

Symptom	Possible Cause and Resolution
<p>The system does not understand what I am saying.</p>	<ul style="list-style-type: none"> – You are using the wrong voice commands. <ul style="list-style-type: none"> • See Using Voice Recognition (page 507). • For a complete list of voice commands, refer to our website. – You are speaking too soon. <ul style="list-style-type: none"> • Wait for the voice prompt before you speak.
<p>The system does not understand the name of a track or artist.</p>	<ul style="list-style-type: none"> – Device limitation. Bluetooth does not support voice commands. <ul style="list-style-type: none"> • Connect your device to a USB port. • If you have an iOS device, press and hold the voice control button on the steering wheel to use Siri to play specific tracks. – You are using the wrong voice commands. <ul style="list-style-type: none"> • See Using Voice Recognition (page 507). • For a complete list of voice commands, refer to our website. – You are not saying the name exactly as it appears on your device. <ul style="list-style-type: none"> • Say the name of the track or artist exactly as it appears on your device. Spell out any abbreviations in the name. <p>The song or artist name may have some special characters that are not being recognized by the system.</p> – The name contains special characters, for example *, - or +. <ul style="list-style-type: none"> • Rename the files on your device or use the touchscreen to select and play the track.

SYNC™ 3 (If Equipped)

Symptom	Possible Cause and Resolution
The system does not understand the name of a contact in the phonebook on my device and calls the wrong contact.	<ul style="list-style-type: none">– You are not saying the name exactly as it appears on your device.<ul style="list-style-type: none">• Say the first and last name of the contact exactly as it appears on your device. Spell out any abbreviations in the name.– The name contains special characters, for example *, - or +.<ul style="list-style-type: none">• Rename the contact on your device or use the touchscreen to select and call the contact.
The system does not understand foreign names of contacts in the phonebook on my device.	<ul style="list-style-type: none">– You are not saying the name exactly as it appears on your device.<ul style="list-style-type: none">• Say the first and last name of the contact exactly as it appears on your device. The system applies phonetic pronunciation rules of the selected language to the names of contacts in the phonebook on your device. Select the name of the contact on the touchscreen and use the Hear it option to get an idea of how the system expects you to pronounce it.
The system voice prompts and the pronunciation of some words does not seem to be very accurate.	<ul style="list-style-type: none">– Device limitation.<ul style="list-style-type: none">• The system uses text-to-speech technology and uses a synthetically generated voice rather than pre-recorded human voice.

USB and Bluetooth Audio

Symptom	Possible Cause and Resolution
I cannot connect my device.	<ul style="list-style-type: none">– Device malfunction.<ul style="list-style-type: none">• Disconnect your device. Switch your device off, reset it and try again.– Cable connection issue.<ul style="list-style-type: none">• Correctly connect the cable to your device and the vehicle USB port.– Incompatible cable.<ul style="list-style-type: none">• Use the cable recommended by the manufacturer of your device.

SYNCTM 3 (If Equipped)

Symptom	Possible Cause and Resolution
	<ul style="list-style-type: none"> – Incorrect device settings. <ul style="list-style-type: none"> • Make sure that your device does not have an auto-install program or active security settings. • Check that your device is not set only to charge. – Device lock screen enabled. <ul style="list-style-type: none"> • Unlock your device before connecting it.
<p>The system does not recognize my device.</p>	<ul style="list-style-type: none"> – Device limitation. <ul style="list-style-type: none"> • Do not leave your device in your vehicle during very hot or very cold weather conditions. – Cable connection issue. <ul style="list-style-type: none"> • Correctly connect the cable to your device and the vehicle USB port. – Incompatible cable. <ul style="list-style-type: none"> • Use the cable recommended by the manufacturer of your device.
<p>The system does not understand the name of a track or artist.</p>	<ul style="list-style-type: none"> – Device limitation. Bluetooth does not support voice commands. <ul style="list-style-type: none"> • Connect your device to a USB port. • If you have an iOS device, press and hold the voice control button on the steering wheel to use Siri to play specific tracks.
<p>I cannot stream audio from my Bluetooth device.</p>	<ul style="list-style-type: none"> – Incompatible device. <ul style="list-style-type: none"> • Check the compatibility of your device on our website. – Device not connected. <ul style="list-style-type: none"> • Pair your device. See Phone (page 525). – Media player not running. <ul style="list-style-type: none"> • Start the media player on your device.
<p>The system does not recognize the music on my device.</p>	<ul style="list-style-type: none"> – Missing or incorrect audio file metadata, for example artist, song title, album or genre. <ul style="list-style-type: none"> • Repair the files on your device. – Corrupt files. <ul style="list-style-type: none"> • Repair the files on your device.

SYNC™ 3 (If Equipped)

Symptom	Possible Cause and Resolution
	<ul style="list-style-type: none"> – Copyright protected files. <ul style="list-style-type: none"> • Use a device that contains files that are not copyright protected. – Unsupported file format. <ul style="list-style-type: none"> • Repair or convert the files to a supported format. See Entertainment (page 513). – Device indexing required. <ul style="list-style-type: none"> • Re-index your device. See Settings (page 535). – Device lock screen enabled. <ul style="list-style-type: none"> • Unlock your device before connecting it.
Sometimes I cannot hear a track playing on my device.	<ul style="list-style-type: none"> – Device malfunction. <ul style="list-style-type: none"> • Disconnect your device. Switch your device off, reset it and try again.
When I disconnect my iOS device the audio volume is set to maximum.	<ul style="list-style-type: none"> – Device limitation. <ul style="list-style-type: none"> • Turn the volume down on your device
The system does not play the tracks on my USB drive in the correct order.	<p>If the system does not play the tracks on your USB device in the correct order, the following information could help:</p> <ul style="list-style-type: none"> – If you are selecting USB as the audio source when the system is still indexing, SYNC plays tracks sorted alphabetically by file name in the root directory. – If you are selecting USB as the audio source after the system has finished indexing, SYNC plays all tracks sorted alphabetically by the title in the ID3 tag regardless of where they are located. SYNC uses the file name if the title in the ID3 Tag does not exist. – If you are selecting the option to play all tracks from the browsing menu, SYNC plays all tracks sorted alphabetically by the title in the ID3 tag regardless of where they are located. SYNC uses the file name if the title in the ID3 Tag does not exist. – If you are selecting a track when using the explore device option, SYNC plays tracks sorted alphabetically by file name in the folder you have selected. SYNC then plays all tracks in any subfolders in the folder you have selected.

SYNCTM 3 (If Equipped)

Phone

Symptom	Possible Cause and Resolution
During a call, I can hear excessive background noise.	<ul style="list-style-type: none"> – Incorrect cell phone settings. <ul style="list-style-type: none"> • Check and adjust the audio settings on your cell phone. Refer to your cell phone's user manual.
During a call, I can hear the other person but they cannot hear me.	<ul style="list-style-type: none"> – Cell phone malfunction. <ul style="list-style-type: none"> • Switch your cell phone off, reset it and try again. – Cell phone microphone muted. <ul style="list-style-type: none"> • Unmute your cell phone microphone.
During a call, I cannot hear the other person and they cannot hear me.	<ul style="list-style-type: none"> – System restart required. <ul style="list-style-type: none"> • Restart the system. Switch the ignition off and open the door. Close the door and lock the vehicle. Wait until the touchscreen is off and any illuminated USB ports are not illuminated. Unlock the vehicle, switch the ignition on and try again.
I cannot download phone-book.	<ul style="list-style-type: none"> – Incompatible cell phone. <ul style="list-style-type: none"> • Check the compatibility of your cell phone on our website. – Incorrect cell phone settings. <ul style="list-style-type: none"> • Allow the system to retrieve contacts from your cell phone. Refer to your cell phone's user manual. – Incorrect system settings. <ul style="list-style-type: none"> • Switch automatic phonebook download on. See Settings (page 535). – Cell phone malfunction. <ul style="list-style-type: none"> • Switch your cell phone off, reset it and try again.
A message displays suggesting that my phone-book has downloaded but it is empty or it has missing contacts.	<ul style="list-style-type: none"> – Incorrect cell phone settings. <ul style="list-style-type: none"> • Allow the system to retrieve contacts from your cell phone. Refer to your cell phone's user manual. • Check the location of the missing contacts on your cell phone. If they are stored on the SIM card, move them to the cell phone memory. – Incorrect system settings. <ul style="list-style-type: none"> • Switch automatic phonebook download on. See Settings (page 535).

SYNC™ 3 (If Equipped)

Symptom	Possible Cause and Resolution
I cannot connect my cell phone.	<ul style="list-style-type: none">– Incompatible cell phone.<ul style="list-style-type: none">• Check the compatibility of your cell phone on our website.– Cell phone malfunction.<ul style="list-style-type: none">• Switch your cell phone off, reset it and try again.• Install the latest cell phone firmware.• Delete your device from system and delete SYNC from your device and try again.• Switch automatic phonebook download off. See Settings (page 535).
Text messaging does not work.	<ul style="list-style-type: none">– You did not switch on text message notifications.<ul style="list-style-type: none">• Switch text message notifications on. See Phone (page 525).– Incompatible cell phone.<ul style="list-style-type: none">• Check the compatibility of your cell phone on our website.– Cell phone malfunction.<ul style="list-style-type: none">• Switch your cell phone off, reset it and try again.
I cannot hear text messages.	<ul style="list-style-type: none">– Device message sharing is not enabled.<ul style="list-style-type: none">• Check the permissions on your device to ensure text message sharing is enabled.– Incompatible cell phone.<ul style="list-style-type: none">• Check the compatibility of your cell phone on our website.

SYNCTM 3 (If Equipped)

Navigation (If Equipped)

Symptom	Possible Cause and Resolution
I cannot enter a street name when I am abroad.	<ul style="list-style-type: none">- Incorrect entry method.<ul style="list-style-type: none">• Enter the street name with the country.
The system does not recognize coordinates.	<ul style="list-style-type: none">- You are using the wrong coordinates format.<ul style="list-style-type: none">• Use the format ##. #####, ##. ##### (for N/S, E/W). Add a minus before coordinates if the direction is West and keep a positive value if the direction is East, for example 12.5412 means East and -12.5412 means West.

SYNC™ 3 (If Equipped)

Apps

Symptom	Possible Cause and Resolution
The system cannot find any apps.	<ul style="list-style-type: none">- Incompatible device.<ul style="list-style-type: none">• You will need an Android device with OS 4.3 or higher or an iOS device with iOS 8.0 or higher. Pair and connect your Android device to find AppLink compatible apps. Connect your iOS device to a USB port or pair and connect using Bluetooth.
I have a compatible device and it is correctly connected but the system still cannot find any apps.	<ul style="list-style-type: none">- AppLink compatible apps not installed on your device.<ul style="list-style-type: none">• Download and install the latest version of the app.- AppLink compatible apps not running on your device.<ul style="list-style-type: none">• Start the apps to allow the system to find them and make sure you sign in to any apps if required.- Incorrect app settings.<ul style="list-style-type: none">• Check and adjust the app settings on your device and allow SYNC to access the app if required.
I have a compatible device, it is correctly connected and my apps are running but the system still cannot find any apps.	<ul style="list-style-type: none">- Apps failed to fully close.<ul style="list-style-type: none">• Restart the apps and try again.• If you have an Android device with apps that have an exit or quit option, use this and then restart the apps. Alternatively, use the force stop option in the settings menu on your device.• If you have an iOS device with iOS 7.0 or higher, tap the home button on your device twice and then swipe the app upward to close it.
I have an Android device that is correctly connected, I have restarted my apps and they are running but the system still cannot find them.	<ul style="list-style-type: none">- An issue on some older versions of the Android operating system could result in apps not being found.<ul style="list-style-type: none">• Switch Bluetooth off and on again to force the system to reconnect to your device.

SYNCTM 3 (If Equipped)

Symptom	Possible Cause and Resolution
I have an iOS device that is correctly connected, I have restarted my apps and they are running but the system still cannot find them.	<ul style="list-style-type: none">– Cable connection issue.<ul style="list-style-type: none">• Disconnect the cable from your device, wait for a moment and then connect it again to force the system to reconnect to your device.
I have an Android device running a media app which the system has found but I cannot hear the sound or the sound is very quiet.	<ul style="list-style-type: none">– Device volume is low.<ul style="list-style-type: none">• Turn the volume up on your device.
I have an Android device running a number of compatible apps but the system cannot find all of them.	<ul style="list-style-type: none">– Device limitation. Some Android devices have a limited number of Bluetooth ports that apps can use to connect. If you have more apps running on your device than the number of available Bluetooth ports, the system cannot find all of them.<ul style="list-style-type: none">• Close some of the apps to allow the system to find those that you want to use.

Wi-Fi Connectivity

Symptom	Possible Cause and Resolution
I cannot connect to a Wi-Fi network.	<ul style="list-style-type: none"> – Password error. <ul style="list-style-type: none"> • Enter the correct network password. – Weak network signal. <ul style="list-style-type: none"> • Move your vehicle closer to the Wi-Fi hotspot or to a place where the network signal is not obstructed. – Multiple access points in range with the same SSID. <ul style="list-style-type: none"> • Use a unique name for your SSID,. Do not use the default name unless it contains a unique identifier, for example as part of the MAC address.
The Wi-Fi connection disconnects after successful connection.	<ul style="list-style-type: none"> – Weak network signal. <ul style="list-style-type: none"> • Move your vehicle closer to the Wi-Fi hotspot or to a place where the network signal is not obstructed.
I am close to a Wi-Fi hotspot but the network signal strength is weak.	<ul style="list-style-type: none"> – Obstructed network signal. <ul style="list-style-type: none"> • If your vehicle has a heated windshield, position your vehicle so that the windshield is not facing the Wi-Fi hotspot. • If your vehicle has metallic tinting on the windows but not on the windshield, position your vehicle so that the windshield is facing the Wi-Fi hotspot or open the windows that are facing the hotspot. • If your vehicle has metallic tinting on the windows and the windshield, open the windows that are facing the hotspot. • If your vehicle is in a garage and you have the garage door closed, open the garage door.
I cannot see a network in the list of available networks that I expect to see.	<ul style="list-style-type: none"> – Hidden network. <ul style="list-style-type: none"> • Make the network visible and try again.

SYNC™ 3 (If Equipped)

Symptom	Possible Cause and Resolution
I cannot see SYNC when I search for Wi-Fi networks on my cell phone or other device.	<ul style="list-style-type: none"> – System limitation. <ul style="list-style-type: none"> • SYNC does not provide a Wi-Fi hotspot at this time.
Software downloads take too long.	<ul style="list-style-type: none"> – Weak network signal <ul style="list-style-type: none"> • Move your vehicle closer to the Wi-Fi hotspot or to a place where the network signal is not obstructed. – Wi-Fi hotspot in high demand or has a slow Internet connection. <ul style="list-style-type: none"> • Use a more reliable Wi-Fi hotspot.
The system seems to connect to a Wi-Fi network and the signal strength is excellent but the software does not update.	<ul style="list-style-type: none"> – No software update available. – Wi-Fi network requires a subscription or acceptance of terms and conditions. <ul style="list-style-type: none"> • Test the connection using another device. If the network requires a subscription or acceptance of terms and conditions, contact the network service provider.

Personal Profiles (If Equipped)

Symptom	Possible Cause and Solution
I cannot create a profile.	You have not set up Personal Profiles.
	You entered an invalid profile.
	You did not select a memory button when prompted.
	You did not have the ignition on or in park (P), or you shifted out park (P) when creating a profile.
	Personal Profiles has been switched off.
I cannot link a remote control.	You did not select the lock button on the remote control.
	The remote control selected was already associated with another profile and the system declined to overwrite.
	The system performed a profile recall when linking a remote control.
	You did not have the ignition on or in park (P), or you shifted out park (P) when creating a profile.

SYNC™ 3 (If Equipped)

Symptom	Possible Cause and Solution
	You are using the old linking method.
My personalized settings do not save.	Personal Profiles does not support your unsaved settings.
	A different personal profile is active.
	Another user changed the settings for the wrong personal profile.
My profile will not recall.	You did not create a personal profile.
	Personal Profiles is turned off.
	The profile you requested is already active.
	You did not link the memory button you are using to a profile.
	You did not link the remote control you are using to a profile.
	You are using the wrong remote control.
	You are pressing a button other than the unlock or remote start on a linked remote control.
You deleted the personal profile.	
My preset positions recall, but my profile does not.	You switched the personal profiles off.
My profile recalls but my preset positions do not.	The vehicle is in motion.
	The preset positions are the same as the guest or previously active profile.
I lost a remote control.	Unlink and relink your remote control in the Personal Profiles menu. You may need to see your authorized dealer.
I lost all profiles.	You erased and reprogrammed the remote controls. This could happen if you let a dealership add a new remote control to replace a lost one.
	Someone performed a master reset without your knowledge.

Resetting the System

1. Simultaneously press and hold the seek up and the audio unit power buttons until the screen goes black.
2. Wait three minutes to allow the system to complete the reset.
3. Press the audio unit power button to switch the system on.

Note: *You can reset the system to restore functionality that has stopped working. The system reset is designed to restore functionality and not delete any data that you have stored.*

Additional Information and Assistance

For additional information and assistance, we recommend that you contact an authorized dealer or refer to our website.

Accessories

For a complete listing of the accessories that are available for your vehicle, please contact your authorized dealer or visit the online store web site:

Web Address (United States)

www.Accessories.Ford.com
--

Web Address (Canada)

www.Accessories.Ford.ca
--

We will repair or replace any properly authorized dealer-installed Ford Original Accessory found to be defective in factory-supplied materials or workmanship during the warranty period, as well as any component damaged by the defective accessories.

We will warrant your Ford Original Accessory through the warranty that provides the greatest benefit:

- 24 months, unlimited mileage.
- The remainder of your new vehicle limited warranty.

Contact an authorized dealer for details and a copy of the warranty.

*Ford Licensed Accessories. The accessory manufacturer designs, develops and therefore warrants Ford Licensed Accessories, and does not design or test these accessories to Ford Motor Company engineering requirements. Contact an authorized Ford dealer for the manufacturer's limited warranty details, and request a copy of the Ford Licensed Accessories product limited warranty from the accessory manufacturer.

For maximum vehicle performance, keep the following information in mind when adding accessories or equipment to your vehicle:

- When adding accessories, equipment, passengers and luggage to your vehicle, do not exceed the total weight capacity of the vehicle or of the front or rear axle (GVWR or GAWR as indicated on the Safety Compliance Certification label). Ask an authorized dealer for specific weight information.
- The Federal Communications Commission (FCC) and Canadian Radio Telecommunications Commission (CRTC) regulate the use of mobile communications systems that are equipped with radio transmitters, for example two-way radios, telephones and theft alarms. Any such equipment installed in your vehicle should comply with Federal Communications Commission (FCC) and Canadian Radio Telecommunications Commission (CRTC) regulations and should be installed only by an authorized dealer.
- An authorized dealer needs to install mobile communications systems. Improper installation may harm the operation of your vehicle, particularly if the manufacturer did not design the mobile communication system specifically for automotive use.
- If you or an authorized Ford dealer add any non-Ford electrical or electronic accessories or components to your vehicle, you may adversely affect battery performance and durability. In addition, you may also adversely affect the performance of other electrical systems in the vehicle.

Accessories

AUXILIARY SWITCHES

For maximum vehicle performance, keep the following information in mind when adding accessories or equipment to your vehicle:

- When adding accessories, equipment, passengers and luggage to your vehicle, do not exceed the total weight capacity of the vehicle or of the front or rear axle (GVWR or GAWR as indicated on the Safety Compliance Certification label). Ask an authorized dealer for specific weight information.
- The Federal Communications Commission (FCC) and Canadian Radio Telecommunications Commission (CRTC) regulate the use of mobile communications systems equipped with radio transmitters, for example, two-way radios, telephones and theft alarms. Any such equipment installed in your vehicle should comply with Federal Communications Commission (FCC) and Canadian Radio Telecommunications Commission (CRTC) regulations, and should be installed by an authorized dealer.
- An authorized dealer needs to install mobile communications systems. Improper installation may harm the operation of your vehicle, particularly if the manufacturer did not design the mobile communication system specifically for automotive use.
- If you or an authorized Ford dealer add any non-Ford electrical or electronic accessories or components to your vehicle, you may adversely affect battery performance and durability. In addition, you may also adversely affect the performance of other electrical systems in the vehicle.



E220728

The auxiliary switch option package provides six switches mounted in the overhead console. These switches operate when the vehicle is running or from battery power, depending on the switchable fuse AUXF4's location in the upfitter relay box. We recommend, however, that the engine remain running to maintain battery charge when using the auxiliary switches for extended periods of time or higher current draws.

Note: *When your vehicle has a diesel engine, use the auxiliary switches only when the engine is running. The glow plugs also drain battery power when the ignition key is in the on position. Using the auxiliary switches, even for limited amounts of time, can cause your battery to drain quickly and prevent your vehicle from restarting.*

When switched on, the auxiliary switches provide electrical battery power for a variety of personal or commercial uses. Switches 1 through 4 provide 25 amps. Switches 5 and 6 provide 40 amps.

The relay box for the auxiliary switches is in the engine compartment. See your authorized dealer for service.

The relays are coded as shown:

Accessories

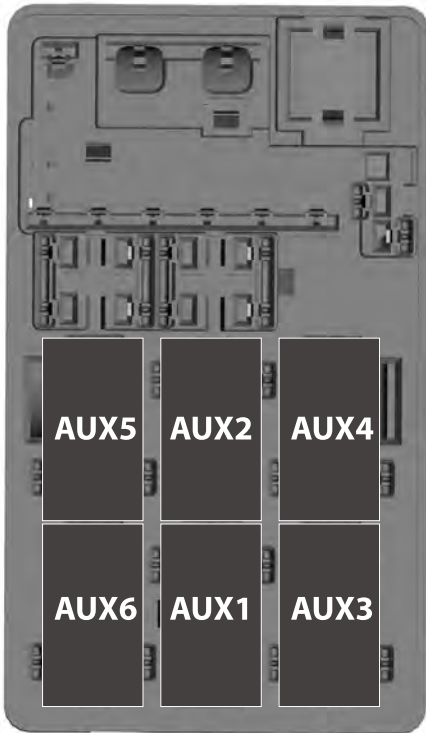

Each switch includes a blunt-cut, sealed wire. The wires are under the instrument panel on the right-hand side of the passenger footwell.

E220729

Accessories

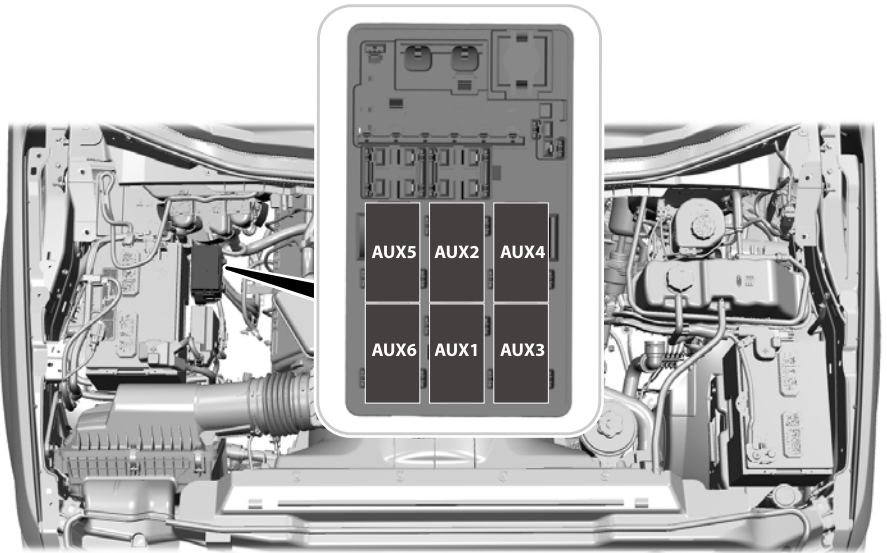

The power leads are coded as shown:

Switch	Circuit Number	Wire Color	Fuse Amp Rating
AUX 1	CB117A	Brown with green trace	25A
AUX 2	CB114A	Violet with orange trace	25A
AUX 3	CB116A	Blue with green trace	25A
AUX 4	CB113A	Gray with brown trace	25A
AUX 5	CB115A	Brown with blue trace	40A
AUX 6	CB118A	Gray with orange trace	40A

Accessories

Upfitter Interface Module (If Equipped)

The Upfitter Interface Module (UIM) is an electronic control module that operates equipment (such as lift buckets, cranes, motors, salt spreaders and snow plows) with external relays.

If you replace the module, it will require additional programming by the upfitter. Obtain this data directly from the upfitter company. The upfitter contact information is in the vehicle door opening.

For more information on the Upfitter Interface Module and the auxiliary switches, contact your upfitter.

Ford Protect

PROTECT YOURSELF FROM THE RISING COST OF VEHICLE REPAIRS WITH A FORD PROTECT EXTENDED SERVICE PLAN.

Ford Protect Extended Service Plans (U.S. Only)

Ford Protect extended service plan means peace of mind. It's the extended service plan backed by Ford Motor Company, and provides more protection beyond the New Vehicle Limited Warranty coverage. When you visit your Ford Dealer, Insist on Ford Protect extended service plans!

Ford Protect Can Quickly Pay for Itself

One trip to the Service Center could easily exceed the price of your Ford Protect extended service plan. With Ford Protect extended service plan you minimize your risk for unexpected repair bills and rising repair costs.

Up to 1,000+ Covered Vehicle Components

There are four mechanical Ford Protect extended service plans with different levels of coverage. Ask your authorized dealer for details.

1. PremiumCARE - Our most comprehensive coverage. With over 1,000 covered components, this plan is so complete it's probably easier to list what's not covered.
2. ExtraCARE - Covers 113 components, and includes many high-tech items.
3. BaseCARE - Covers 84 components.
4. PowertrainCARE - Covers 29 critical components.

Ford Protect extended service plans are honored by all authorized Ford dealers in the U.S., Canada and Mexico.

That means you get:

- Reliable, quality service at any Ford or Lincoln dealership.
- Repairs performed by factory trained technicians, using genuine parts.

Rental Car Reimbursement

1st day Rental Benefit

If you bring your car into your dealer for service, we'll give you a loaner to use for the day.

Extended Rental Benefits

If your vehicle is kept overnight for covered repairs, you are eligible for rental car coverage, including warranty repairs, and Field Service Actions.

Roadside Assistance

Exclusive 24/7 roadside assistance, including:

- Towing, flat-tire change and battery jump starts.
- Out of fuel and lock-out assistance.
- Travel expense reimbursement for lodging, meals and rental car.
- Assistance for taxi, shuttle, rental car coverage or other transportation.

Transferable Coverage

If you sell your vehicle before your Ford Protect extended service plan coverage expires, you can transfer any remaining coverage to the new owner. Which should give you and your potential buyer a little more peace of mind.

Ford Protect

Less Cost to Properly Maintain Your Vehicle

Ford Protect extended service plan also offers a Premium Maintenance Plan that covers all scheduled maintenance, and selected wear items. The coverage is prepaid, so you never have to worry about the cost of your vehicle's maintenance.

Covered maintenance includes:

- Windshield wiper blades.
- Spark plugs.
- The clutch disc (if equipped).
- Brake pads and linings.
- Shock absorbers.
- Struts.
- Engine Belts.
- Engine coolant hoses, clamps and o-rings.
- Diesel exhaust fluid replenishment (if equipped).
- Cabin air filter replacement every 20,000 mi (32,000 km) (electric vehicles only).

Interest Free Finance Options

Just a 5% down payment will provide you with an affordable, no interest, no fee payment program allowing you all the security and benefits Ford Protect extended service plan has to offer while paying over time. You are pre-approved with no credit check or hassles. To learn more, call our Ford Protect extended service plan specialists at 800-367-3377.

Ford Protect Extended Service Plan
P.O. Box 321067
Detroit, MI 48232

Ford Protect Extended Service Plan (CANADA ONLY)

You can get more protection for your vehicle by purchasing a Ford Protect extended service plan. Ford Protect extended service plan is the only service contract backed by Ford Motor Company of Canada, Limited. Depending on the plan you purchase, Ford Protect extended service plan provides benefits such as:

- Rental reimbursement.
- Coverage for certain maintenance and wear items.
- Protection against repair costs after your New Vehicle Limited Warranty Coverage expires.
- Roadside Assistance benefits.

There are several Ford Protect extended service plans available in various time, distance and deductible combinations. Each plan is tailored to fit your own driving needs, including reimbursement for towing and rental. When you purchase Ford Protect extended service plan, you receive added peace-of-mind protection throughout Canada, the United States and Mexico, provided by a network of participating authorized Ford Motor Company dealers.

Note: *Repairs performed outside of Canada and the United States are not eligible for Ford Protect extended service plan coverage.*

This information is subject to change. For more information; visit your local Ford of Canada dealer or www.ford.ca to find the Ford Protect extended service plan that is right for you.

Scheduled Maintenance

GENERAL MAINTENANCE INFORMATION

Why Maintain Your Vehicle?

Carefully following the maintenance schedule helps protect against major repair expenses resulting from neglect or inadequate maintenance and may help to increase the value of your vehicle when you sell or trade it. Keep all receipts for completed maintenance with your vehicle.

We have established regular maintenance intervals for your vehicle based upon rigorous testing. It is important that you have your vehicle serviced at the proper times. These intervals serve two purposes; one is to maintain the reliability of your vehicle and the second is to keep your cost of owning your vehicle down.

It is your responsibility to have all scheduled maintenance performed and to make sure that the materials used meet the specifications identified in this owner's manual. See **Capacities and Specifications** (page 433).

Failure to perform scheduled maintenance invalidates warranty coverage on parts affected by the lack of maintenance.

Why Maintain Your Vehicle at Your Dealership?

Factory-Trained Technicians

Service technicians participate in extensive factory-sponsored certification training to help them become experts on the operation of your vehicle. Ask your dealership about the training and certification their technicians have received.

Our Genuine Replacement Parts

Dealerships stock our parts and our authorized branded re-manufactured replacement parts. These parts meet or exceed our specifications. Parts installed at your dealership carry a nationwide 24-month or unlimited mile (kilometer) parts and labor limited warranty.

If you do not use our authorized parts they may not meet our specifications and depending on the part, it could affect emissions compliance.

Convenience

Many dealerships have extended evening and Saturday hours to make your service visit more convenient and they offer one stop shopping. They can perform any services that are required on your vehicle, from general maintenance to collision repairs.

Note: *Not all dealers have extended hours or body shops. Please contact your dealer for details.*

Protecting Your Investment

Maintenance is an investment that pays dividends in the form of improved reliability, durability and resale value. To maintain the proper performance of your vehicle and its emission control systems, make sure you have scheduled maintenance performed at the designated intervals.

Your vehicle comes with the Intelligent Oil-Life Monitor system, which displays a message in the information display at the proper oil change interval. This interval may be up to one year or 10,000 mi (16,000 km).

Scheduled Maintenance

When the oil change message appears in the information display, it is time for an oil change. Make sure you perform the oil change within two weeks or 500 mi (800 km) of the message appearing. Make sure you reset the Intelligent Oil-Life Monitor after each oil change. See **Oil Change Indicator Reset** (page 350).

If your information display resets prematurely or becomes inoperative, you should perform the oil change interval at six months or 5,000 mi (8,000 km) from your last oil change. Never exceed one year or 10,000 mi (16,000 km) between oil change intervals.

You can drive high performance vehicles in such a way that may lead to higher oil consumption this includes extended time at high engine speeds, high loads, engine braking, hard cornering maneuvers, track and off-road usage. Under these conditions, oil consumption of approximately 1 quart per 500 miles (1 liter per 800 km) is possible. As a result, you need to check the engine oil level at every refueling and adjust to maintain proper levels to avoid engine damage.

Your vehicle is very sophisticated and built with multiple, complex, performance systems. Every manufacturer develops these systems using different specifications and performance features. That is why it is important to rely upon your dealership to properly diagnose and repair your vehicle.

We have recommended maintenance intervals for various parts and component systems based upon engineering testing. We rely upon this testing to determine the most appropriate mileage for replacement of oils and fluids to protect your vehicle at the lowest overall cost to you and recommends against maintenance schedules that deviate from the scheduled maintenance information.

We strongly recommend the use of only our genuine or our authorized re-manufactured replacement parts engineered for your vehicle.

Additives and Chemicals

This owner's manual and our Workshop Manual list the recommended additives and chemicals for your vehicle. We do not recommend using chemicals or additives not approved by us as part of your vehicle's normal maintenance. Please consult your warranty information.

Oils, Fluids and Flushing

In many cases, fluid discoloration is a normal operating characteristic and, by itself, does not necessarily indicate a concern or that the fluid needs to be changed. However, a qualified expert, such as the factory-trained technicians at your dealership, should inspect discolored fluids that also show signs of overheating or foreign material contamination immediately.

Make sure to change your vehicle's oils and fluids at the specified intervals or in conjunction with a repair. Flushing is a viable way to change fluid for many vehicle sub-systems during scheduled maintenance. It is critical that systems are flushed only with new fluid that is the same as that required to fill and operate the system or using our approved flushing chemical.

Owner Checks and Services

Make sure you perform the following basic maintenance checks and inspections every month or at six-month intervals.

Scheduled Maintenance

Check Every Month
Air filter restriction gauge. ¹
Engine oil level.
Function of all interior and exterior lights.
Tires including the spare for wear and proper pressure.
Windshield washer fluid level.
Fuel and water separator. Drain if necessary or if indicated by the information display. ¹
Holes and slots in the tail pipe to make sure they are functional and clear of debris. ¹

¹ Diesel vehicles only.

Check Every Six Months
Battery connections. Clean if necessary.
Body and door drain holes for obstructions. Clean if necessary.
Cooling system fluid level and coolant strength.
Door weatherstrips for wear. Lubricate if necessary.
Hinges, latches and outside locks for proper operation. Lubricate if necessary.
Parking brake for proper operation.
Safety belts and seat latches for wear and function.
Safety warning lamps, brake, ABS, airbag and safety belt for operation.
Washer spray and wiper operation. Clean or replace blades as necessary.

Scheduled Maintenance

Multi-Point Inspection

In order to keep your vehicle running right, it is important to have the systems on your vehicle checked regularly. This can help identify potential issues and prevent major

problems. We recommend having the following multi-point inspection performed at every scheduled maintenance interval to help make sure your vehicle keeps running great.

Multi-Point Inspection	
Accessory drive belt or belts	Hazard warning system operation
Battery performance	Horn operation
Engine air filter	Radiator, cooler, heater and air conditioning hoses
Exhaust system	Suspension components for leaks or damage
Exterior lamps operation	Steering and linkage
Fluid levels ¹ ; fill if necessary	Tires including the spare for wear and proper pressure ²
For oil and fluid leaks	Windshield for cracks, chips or pits
Half-shaft dust boots	Washer spray and wiper operation

¹ Brake, coolant recovery reservoir and window washer.

² If your vehicle is equipped with a temporary mobility kit, check the tire sealant expiration Use By date on the canister. Replace as needed.

Be sure to ask your dealership service advisor or technician about the multi-point vehicle inspection. It is a comprehensive way to perform a thorough inspection of your vehicle. Your checklist gives you immediate feedback on the overall condition of your vehicle.

NORMAL SCHEDULED MAINTENANCE

Intelligent Oil-Life Monitor

Your vehicle has an Intelligent Oil-Life Monitor that determines when you should change the engine oil based on how you use your vehicle. By using several important factors in its calculations, the monitor helps reduce the cost of owning your vehicle and reduces environmental waste at the same time.

Scheduled Maintenance

This means you do not have to remember to change the oil on a mileage-based schedule. Your vehicle lets you know when an oil change is due by displaying a message in the information display.

The following table provides examples of vehicle use and its impact on oil change intervals. It is a guideline only. Actual oil change intervals depend on several factors and generally decrease with severity of use.

When to Expect the Message Prompting You to Change Your Oil	
mi (km)	Vehicle Use and Example
7,500–10,000 mi (12,000–16,000 km)	Normal
	Normal commuting with highway driving. No, or moderate, load or towing. Flat to moderately hilly roads. No extended idling.
5,000–7,500 mi (8,000–12,000 km)	Severe
	Moderate to heavy load or towing. Mountainous or off-road conditions. Extended idling, 200-300 hours. Extended hot or cold operation.
2,500–5,000 mi (4,000–8,000 km)	Extreme
	Maximum load or towing. Extreme hot or cold operation. Use of high sulfur diesel fuel.

Note: Use the appropriate special operating condition for maintenance information when using high sulfur diesel fuels, operating your vehicle off-road or in dusty conditions, such as unpaved roads.

Note: For every hour that your vehicle idles, it accumulates the equivalent of approximately 25 mi (40 km).

Scheduled Maintenance

Gasoline Engine

Normal Maintenance Intervals

10,000 mi (16,000 km) / 450 Engine Hours or 12 Months - Whichever Comes First
Change the engine oil and filter. ¹
Rotate the tires, inspect tire wear and measure the tread depth. ²
Inspect the wheels and related components for abnormal noise, wear, looseness or drag.
Perform multi-point inspection - recommended.
Inspect the brake pads, shoes, rotors, drums, brake linings, hoses and the parking brake.
Inspect the engine coolant concentration, freeze-point protection, level and the hoses.
Inspect the exhaust system and heat shields.
Inspect the front axle and U-joints. If applicable, lubricate the grease fittings. Four-wheel drive vehicles.
Inspect the steering linkage, ball joints, suspension, tie-rod ends, driveshaft and the U-joints. If applicable, lubricate the grease fittings.

¹ Reset the Intelligent Oil-Life Monitor after engine oil and filter changes.

² Rotate the front wheels on vehicles with dual rear wheels when specified. Only rotate the rear wheels if you notice unusual wear.

Brake Fluid Maintenance¹	
Every 3 Years	Change the brake fluid. ²

¹ Perform this maintenance item every 3 years. Do not exceed the designated time for the interval.

² Brake fluid servicing requires special equipment available at your authorized dealer.

Scheduled Maintenance

Other Maintenance Items	
Every 20,000 mi (32,180 km)	Replace the cabin air filter.
Every 30,000 mi (48,000 km)	Replace the engine air filter.
Every 60,000 mi (96,000 km)	Replace the front wheel bearing grease and grease seal, if you use non-sealed bearings.
Every 100,000 mi (160,934 km)	Replace the spark plugs.
Every 100,000 mi (160,934 km)	Inspect the accessory drive belt or belts. ¹
Every 150,000 mi (240,000 km)	Change the automatic transmission fluid and filter on 6-speed transmission. Consult dealer for requirements.
	Replace the accessory drive belt or belts if not replaced within the last 100,000 mi (160,000 km).
	Replace the front wheel bearings and seals if you use non-sealed bearings.
	Change the axle(s) fluid. See exceptions.
	Change the transfer case fluid, if applicable.
At 200,000 mi (320,000 km)	Change the engine coolant. ²

¹ If not replaced, inspect the belt or belts every 15,000 mi (24,000 km).

² Initial replacement at ten years or 200,000 mi (320,000 km), then every five years or 100,000 mi (160,000 km).

Diesel Engine

Electronic Air Filter Maintenance Minder

Diesel engines have an electronic air filter maintenance minder that indicates the status of the engine air filter. You can find this information within the Vehicle Maintenance menu, in the information displays. One of three indications are possible:

Scheduled Maintenance

Engine Air Filter Status Message	Result
Filter OK	Indicates the engine air filter is performing as expected.
Check filter ¹	Indicates that there is a higher than expected restriction across the engine air filter, which could represent an air filter at full useful life or a filter with an obstruction. When this displays, inspect the engine air filter and replace if necessary. After the inspection or engine air filter replacement, you must reset the system in order to change the status from Check Filter to Filter OK.
System fault	Indicates that there is an error within the electronic air filter maintenance minder system requiring service.

¹ Reset the engine air filter information monitor after you replace the air filter.

Normal Maintenance Intervals

At Every Oil Change Interval as Indicated by the Information Display ¹
Change the engine oil and filter. ²
Fuel and water separator. Drain if necessary or if indicated by the information display.
Refill the diesel exhaust fluid tank.
Rotate the tires, inspect the tires for wear and measure the tread depth. ⁴
Perform a multi-point inspection, recommended.
Inspect the air filter restriction gauge. Replace the air filter if necessary. ³
Inspect the brake pads, shoes, rotors, drums, brake linings, hoses and the parking brake.
Inspect the engine and secondary cooling system coolant concentration freeze-point protection, level and the hoses.
Inspect the exhaust system and heat shields.

Scheduled Maintenance

At Every Oil Change Interval as Indicated by the Information Display¹

Inspect the front axle and U-joints. Lubricate any grease fittings. Four-wheel drive vehicles.

Inspect the steering linkage, ball joints, suspension, tie-rod ends, driveshaft and the U-joints. Lubricate any grease fittings.

¹ Do not exceed one year/10,000 mi (16,000 km) or 350 engine hours between service intervals.

² Reset the Intelligent Oil-Life Monitor after engine oil and filter changes.

³ Reset the engine air filter information monitor after you replace the air filter.

⁴ Rotate the front wheels on vehicles with dual rear wheels when specified. Only rotate the rear wheels if you notice unusual wear.

Brake Fluid Maintenance¹

Every 3 Years

Change the brake fluid.²

¹ Perform this maintenance item every 3 years. Do not exceed the designated time for the interval.

² Brake fluid servicing requires special equipment available at your authorized dealer.

Other Maintenance Items¹

Every 20,000 mi
(32,000 km)

Replace the cabin air filter.

Every 30,000 mi
(48,000 km)

Replace the engine air filter.²
Replace the engine-mounted and frame-mounted fuel filters. Inspect the engine and secondary cooling system coolant concentration freeze-point protection, additive corrosion inhibitor strength, coolant level, and hoses. Add coolant additive if necessary.

Every 50,000 mi
(80,467 km)

Replace the engine air inlet foam filter.

Every 60,000 mi
(96,000 km)

Replace the front wheel bearing grease and grease seal if using non-sealed bearings. Two-wheel drive vehicles.

At 90,000 mi
(144,000 km)

Inspect the accessory drive belt or belts.³

Scheduled Maintenance

Other Maintenance items ¹	
Every 150,000 mi (240,000 km)	Change the automatic transmission fluid and filter. Consult dealer for requirements.
	Replace the accessory drive belt or belts if not replaced within the last 100,000 mi (160,000 km)
	Replace the front wheel bearings and seals if using non-sealed bearings. Two-wheel drive vehicles.
	Change the axle(s) fluid. See exceptions.
	Change the transfer case fluid, if equipped.
At 200,000 mi (320,000 km)	Change the engine and secondary cooling system coolant. ⁴

¹You can perform these maintenance items within 3,000 mi (4,800 km) of the last oil change. Do not exceed the designated distance for the interval.

²Reset the engine air filter information monitor after you replace the air filter.

³Perform follow-up inspections every 15,000 mi (24,000 km) after the initial inspection. Replace the belt or belts at 150,000 mi (240,000 km).

⁴Initial replacement at ten years or 200,000 mi (320,000 km), then every five years or 100,000 mi (160,000 km).

SPECIAL OPERATING CONDITIONS SCHEDULED MAINTENANCE

Gasoline Engine

If you operate your vehicle primarily in any of the following conditions, you need to perform extra maintenance as indicated.

If you operate your vehicle occasionally under any of these conditions, it is not necessary to perform the extra maintenance. For specific recommendations, see your dealership service advisor or technician.

Scheduled Maintenance

Towing a Trailer or Using a Car-top Carrier	
Inspect frequently, service as required	Inspect and lubricate the U-joints grease fittings - if applicable.
	See the axle maintenance items under Exceptions .
Every 5,000 mi (8,000 km)	Inspect the wheels and related components for abnormal noise, wear, looseness or drag.
	Rotate tires, inspect tires for wear and measure tread depth. ¹
Every 5,000 mi (8,000 km) or six months.	Change the engine oil and filter.
	Inspect and lubricate the U-joints grease fittings. - if applicable.
Every 30,000 mi (48,000 km)	Replace the front wheel bearing grease and grease seals if you use non-sealed bearings.
Every 60,000 mi (96,000 km)	Change the transfer case fluid, four-wheel drive vehicles.
	Replace the spark plugs.

¹ Rotate the front wheels on vehicles with dual rear wheels when specified. Only rotate the rear wheels if you notice unusual wear.

Extensive Idling or Low-speed Driving for Long Distances, as in Heavy Commercial Use - Such as Delivery, Taxi, Patrol Car or Livery	
Inspect frequently, service as required	Replace the engine air filter.
	Replace the cabin air filter.
Every 5,000 mi (8,000 km)	Inspect the brake system.
	Inspect the wheels and related components for abnormal noise, wear, looseness or drag.
	Lubricate the control arm and steering ball joints grease fittings - if applicable.
	Rotate the tires, inspect tires for wear and measure the tread depth. ¹
Every 5,000 mi (8,000 km) or six months	Inspect and lubricate the U-joints grease fittings - if applicable.

Scheduled Maintenance

Extensive Idling or Low-speed Driving for Long Distances, as in Heavy Commercial Use - Such as Delivery, Taxi, Patrol Car or Livery	
Every 5,000 mi (8,000 km) or six months or 200 engine hours.	Change the engine oil and filter.
Every 30,000 mi (48,000 km)	Replace the front wheel bearing grease and grease seals if you use non-sealed bearings.
Every 60,000 mi (96,000 km)	Replace the spark plugs.

¹ Rotate the front wheels on vehicles with dual rear wheels when specified. Only rotate the rear wheels if you notice unusual wear.

Operating in Dusty or Sandy Conditions - Such as Unpaved or Dusty Roads	
Inspect frequently, service as required	Replace engine air filter.
	Replace cabin air filter.
Every 5,000 mi (8,000 km)	Inspect the wheels and related components for abnormal noise, wear, looseness or drag.
	Rotate tires, inspect tires for wear and measure tread depth. ¹
Every 5,000 mi (8,000 km) or six months	Change engine oil and filter.
	Inspect and lubricate U-joints if equipped with grease fittings.
Every 30,000 mi (48,000 km)	Replace front wheel bearing grease and grease seals if non-sealed bearings are used.

¹ Rotate the front wheels on vehicles with dual rear wheels when specified. Only rotate the rear wheels if you notice unusual wear.

Off-road operation	
Inspect frequently, service as required	Inspect the steering linkage, ball joints and the U-joints, Lubricate grease fittings - if applicable.
	Replace the engine air filter.
Every 5,000 mi (8,000 km) or six months	Change the engine oil and filter.
	Replace the cabin air filter.

Scheduled Maintenance

Off-road operation	
	Inspect the wheels and related components for abnormal noise, wear, looseness or drag.
	Rotate tires, inspect tires for wear and measure the tread depth. ¹
Every 30,000 mi (48,000 km)	Replace front wheel bearing grease and grease seals if you use non-sealed bearings.

¹ Rotate the front wheels on vehicles with dual rear wheels when specified. Only rotate the rear wheels if you notice unusual wear.

Exclusive use of E85 - Flex Fuel Vehicles Only	
Every oil change interval	If ran exclusively on E85, fill the fuel tank full with regular unleaded fuel.

Diesel Engine

If you operate your vehicle primarily in any of the following conditions, you need to perform extra maintenance as indicated. If you operate your vehicle occasionally under any of these conditions, it is not necessary to perform the extra maintenance. For specific recommendations, see your dealership service advisor or technician.

Towing a Trailer or Using a Car-top Carrier	
As required	Change the engine oil and filter as indicated by the information display, and perform the services listed in the scheduled maintenance chart.
	See the axle maintenance items under Exceptions .
Every 15,000 mi (24,000 km) or six months, 600 engine hours	Replace the engine-mounted and frame-mounted fuel filters.

Scheduled Maintenance

Towing a Trailer or Using a Car-top Carrier

Every 30,000 mi (48,000 km)	Replace the wheel bearing grease and grease seals if you use non-sealed bearings. Two-wheel drive vehicles
Every 60,000 mi (96,000 km) or 2400 engine hours	Flush and refill the coolant. Do not add coolant additive.

Note: After the initial coolant flush and fill at 60,000 mi (96,000 km) or 2400 engine hours, flush and fill every 45,000 mi (72,000 km) or 1800 engine hours thereafter.

Frequent or Extended Idling - Over 10 Minutes Per Hour of Normal Driving or Frequent Low-speed Operation if you use your Vehicle for Stationary Operation

As required	Change the engine oil and filter as indicated by the information display, and perform the services listed in the scheduled maintenance chart.
Every 15,000 mi (24,000 km), six months or 600 engine hours	Replace the engine-mounted and frame-mounted fuel filters.
Every 60,000 mi (96,000 km) or 2400 engine hours	Flush and refill the coolant. Do not add coolant additive.

Note: After the initial coolant flush and fill at 60,000 mi (96,000 km) or 2400 engine hours, flush and fill every 45,000 mi (72,000 km) or 1800 engine hours thereafter.

Frequent Low-speed Operation, Consistent Heavy Traffic Under 25 mph (40 km/h) or Long Rush-hour Traffic

As required	Change the engine oil and filter as indicated by the information display, and perform the services listed in the scheduled maintenance chart.
Every 15,000 mi (24,000 km), six months or 600 engine hours	Replace the engine-mounted and frame-mounted fuel filters.
Every 60,000 mi (96,000 km) or 2400 engine hours	Flush and refill the coolant. Do not add coolant additive.

Note: After the initial coolant flush and fill at 60,000 mi (96,000 km) or 2400 engine hours, flush and fill every 45,000 mi (72,000 km) or 1800 engine hours thereafter.

Scheduled Maintenance

Sustained High-speed Driving at Gross Vehicle Weight Rating - Maximum Loaded Weight for Vehicle Operation	
As required	Change the engine oil and filter as indicated by the information display, and perform the services listed in the scheduled maintenance chart.
Every 15,000 mi (24,000 km), six months or 600 engine hours	Replace the engine-mounted and frame-mounted fuel filters.
Every 30,000 mi (48,000 km)	Replace the wheel bearing grease and grease seals if you use non-sealed bearings. Two-wheel drive vehicles.
Every 60,000 mi (96,000 km) or 2400 engine hours	Flush and refill the coolant. Do not add coolant additive.

Note: After the initial coolant flush and fill at 60,000 mi (96,000 km) or 2400 engine hours, flush and fill every 45,000 mi (72,000 km) or 1800 engine hours thereafter.

Operating in Sustained Ambient Temperatures Below -9°F (-23°C) or Above 100°F (38°C)	
As required	Change the engine oil and filter as indicated by the information display, and perform the services listed in the scheduled maintenance chart.
Every 15,000 mi (24,000 km), six months or 600 engine hours	Replace the engine-mounted and frame-mounted fuel filters.
Every 30,000 mi (48,000 km)	Replace the wheel bearing grease and grease seals if using non-sealed bearings. (Two-wheel drive vehicles)

Operating in Dusty or Sandy Conditions (Such as Unpaved or Dusty Roads)	
Every 7,500 mi (12,000 km)	Rotate the tires, inspect the tires for wear and measure tread depth. ¹
	Inspect the brake system pads and rotors.
	Inspect the air filter restriction gauge. Replace the air filter if necessary. ²
	Inspect the steering, suspension ball joints and the tie rods. Lubricate any grease fittings.

Scheduled Maintenance

Operating in Dusty or Sandy Conditions (Such as Unpaved or Dusty Roads)	
Every 7,500 mi (12,000 km), six months or 300 engine hours	Change the engine oil and filter. ³
	Inspect and lubricate the U-joints.
Every 15,000 mi (24,000 km), 6 months or 600 engine hours	Replace the engine-mounted and frame-mounted fuel filters.
Every 30,000 mi (48,000 km)	Replace the air inlet foam filter.
	Replace the wheel bearing grease and grease seals if you use non-sealed bearings. Two-wheel drive vehicles.

¹ Rotate the front wheels on vehicles with dual rear wheels when specified. Only rotate the rear wheels if you notice unusual wear.

² Reset the engine air filter information monitor after you replace the air filter.

³ Reset the Intelligent Oil-Life Monitor after engine oil and filter changes.

Off-road Operation	
As required	Inspect the functional holes in each leg of the twin exhaust tips and the holes under the shield just inboard of the right rear tire to make sure they are clean and clear of debris or foreign materials. Refer to the Vehicle Care chapter of your owner's manual for more information.
	Inspect the steering, suspension ball joints and the tie rods. Lubricate any grease fittings.
Every 7,000 mi (12,000 km), six months or 300 engine hours	Rotate the tires, inspect the tires for wear and measure the tread depth. ¹
	Inspect the brake system pads and rotors.
	Inspect the air filter restriction gauge. Replace the air filter if necessary. ²
Every 7,000 mi (12,000 km) or 300 engine hours	Change the engine oil and filter. ³
Every 15,000 mi (24,000 km), six months or 600 engine hours	Replace the engine-mounted and frame-mounted fuel filters.
Every 30,000 mi (48,000 km)	Replace the air inlet foam filter.

Scheduled Maintenance

Off-road Operation	
	Replace the wheel bearing grease and grease seals if you use non-sealed bearings. Two-wheel drive vehicles.
Every 50,000 mi (80,000 km)	Change the rear axle fluid. Dana rear axles only - some F-350s; all F-450s and F-550s.
	Change the transfer case fluid. Four-wheel drive vehicles.
	Inspect the front axle fluid. Four-wheel drive vehicles.

¹ Rotate the front wheels on vehicles with dual rear wheels when specified. Only rotate the rear wheels if you notice unusual wear.

² Reset the engine air filter information monitor after you replace the air filter.

³ Reset the Intelligent Oil-Life Monitor after engine oil and filter changes.

Using Biodiesel, up to and Including 20% Biodiesel (B20)	
As required	Change the engine oil and filter as indicated by the information display, and perform the services listed in the scheduled maintenance chart.
Every 15,000 mi (24,000 km), six months or 300 engine hours	Replace the engine-mounted and frame-mounted fuel filters.

Using Fuel Other Than Ultra-low Sulfur Diesel Fuel - Vehicles Operated Where Ultra-low Sulfur Diesel Fuel is not Required or Available	
Every 2,500 mi (4,000 km) or three months (if using high sulfur fuel with more than 500 ppm sulfur)	Change the engine oil and filter.
Every 5,000 mi (8,000 km) or six months (if using high sulfur fuel with fewer than 500 ppm sulfur)	Change the engine oil and filter.

Scheduled Maintenance

Exceptions

Axle and Transfer Case Maintenance

Axle(s) and transfer case, 4X4 only, fluid changes or level checks are not required unless a leak is suspected or the assembly has been submerged in water. During long periods of trailer towing with outside temperatures above 70°F (21°C) or at wide-open throttle for long periods above 45 mph (72 km/h), change the rear axle fluid every 30,000 mi (48,000 km) if the rear axle is filled with non-synthetic fluid. This interval can be waived and the 150,000 mi (240,000 km) service interval can continue if the rear axle is filled with 75W140 synthetic gear fluid meeting Ford specification WSL-M2C192-A, part number XY-75W140-QL, or equivalent. Add friction modifier XL-3 (EST-M2C118-A) or equivalent for complete refill of Traction-Lok rear axles. See **Capacities and Specifications** (page 433).

Additional Axle Maintenance for Dual Rear Wheels

Change the rear axle fluid every 250,000 mi (400,000 km) under normal driving conditions on all commercial applications. When you operate your vehicle at or near maximum gross vehicle weights, change the rear axle fluid every 60,000 mi (96,000 km). In addition, follow this 60,000 mi (96,000 km) schedule when you operate your vehicle under the special operating conditions where noted.

California Fuel Filter Replacement

If you register your vehicle in California, the California Air Resources Board has determined that the failure to perform this maintenance item does not nullify the emission warranty or limit recall liability before the completion of your vehicle's useful life. Ford Motor Company, however, urges you to have all recommended maintenance services performed at the specified intervals and to record all vehicle service.

Hot Climate Oil Change Intervals

Vehicles operating in the Middle East, North Africa, Sub-Saharan Africa or locations with similar climates using an American Petroleum Institute (API) Certified for Gasoline Engines (Certification mark) oil of SM or SN quality, the normal oil change interval is 3,000 mi (5,000 km).

If the available API SM or SN oils are not available, then the oil change interval is 2,000 mi (3,000 km).

Engine Air Filter and Cabin Air Filter Replacement

The life of the engine air filter and cabin air filter is dependent on exposure to dusty and dirty conditions. Vehicles operated in these conditions require frequent inspection and replacement of the engine air filter and cabin air filter.

Diesel Particulate Filter

Over time, a slight amount of ash builds up in the diesel particulate filter, which is not removed during the regeneration process. The filter may need to be replaced with a new or remanufactured part at approximately 250,000 mi (400,000 km). Actual mileage varies depending on engine and vehicle operating conditions.

Scheduled Maintenance

In this case, the engine control system illuminates a service light , wrench icon, to inform you to bring your vehicle to the dealer for service. If there are any issues with the oxidation catalyst or particulate filter system, the engine control system illuminates a service light, wrench or engine icon to inform you to bring your vehicle into a dealer for service.

SCHEDULED MAINTENANCE RECORD

After the scheduled maintenance services are performed, record the Repair Order #, Distance and Engine Hours in the boxes provided.

<input type="radio"/> Repair Order #:	Dealer stamp
<input type="radio"/> Distance:	
<input type="radio"/> Engine hours (optional):	
<input type="radio"/> Multi-point inspection (recommended): <input type="checkbox"/>	
<input type="radio"/> Signature:	

<input type="radio"/> Repair Order #:	Dealer stamp
<input type="radio"/> Distance:	
<input type="radio"/> Engine hours (optional):	
<input type="radio"/> Multi-point inspection (recommended): <input type="checkbox"/>	
<input type="radio"/> Signature:	

Scheduled Maintenance

<input type="radio"/> Repair Order #:	Dealer stamp
<input type="radio"/> Distance:	
<input type="radio"/> Engine hours (optional):	
<input type="radio"/> Multi-point inspection (recommended): <input type="checkbox"/>	
<input type="radio"/> Signature:	

<input type="radio"/> Repair Order #:	Dealer stamp
<input type="radio"/> Distance:	
<input type="radio"/> Engine hours (optional):	
<input type="radio"/> Multi-point inspection (recommended): <input type="checkbox"/>	
<input type="radio"/> Signature:	

Scheduled Maintenance

<input type="radio"/> Repair Order #:	<p>Dealer stamp</p>
<input type="radio"/> Distance:	
<input type="radio"/> Engine hours (optional):	
<input type="radio"/> Multi-point inspection (recommended): <input type="checkbox"/>	
<input type="radio"/> Signature:	

<input type="radio"/> Repair Order #:	<p>Dealer stamp</p>
<input type="radio"/> Distance:	
<input type="radio"/> Engine hours (optional):	
<input type="radio"/> Multi-point inspection (recommended): <input type="checkbox"/>	
<input type="radio"/> Signature:	

Scheduled Maintenance

<input type="radio"/> Repair Order #:	Dealer stamp
<input type="radio"/> Distance:	
<input type="radio"/> Engine hours (optional):	
<input type="radio"/> Multi-point inspection (recommended): <input type="checkbox"/>	
<input type="radio"/> Signature:	

<input type="radio"/> Repair Order #:	Dealer stamp
<input type="radio"/> Distance:	
<input type="radio"/> Engine hours (optional):	
<input type="radio"/> Multi-point inspection (recommended): <input type="checkbox"/>	
<input type="radio"/> Signature:	

Scheduled Maintenance

<input type="radio"/> Repair Order #:	<p>Dealer stamp</p>
<input type="radio"/> Distance:	
<input type="radio"/> Engine hours (optional):	
<input type="radio"/> Multi-point inspection (recommended): <input type="checkbox"/>	
<input type="radio"/> Signature:	

<input type="radio"/> Repair Order #:	<p>Dealer stamp</p>
<input type="radio"/> Distance:	
<input type="radio"/> Engine hours (optional):	
<input type="radio"/> Multi-point inspection (recommended): <input type="checkbox"/>	
<input type="radio"/> Signature:	

Scheduled Maintenance

<input type="radio"/> Repair Order #:	Dealer stamp
<input type="radio"/> Distance:	
<input type="radio"/> Engine hours (optional):	
<input type="radio"/> Multi-point inspection (recommended): <input type="checkbox"/>	
<input type="radio"/> Signature:	

<input type="radio"/> Repair Order #:	Dealer stamp
<input type="radio"/> Distance:	
<input type="radio"/> Engine hours (optional):	
<input type="radio"/> Multi-point inspection (recommended): <input type="checkbox"/>	
<input type="radio"/> Signature:	

Scheduled Maintenance

<input type="radio"/> Repair Order #:	Dealer stamp
<input type="radio"/> Distance:	
<input type="radio"/> Engine hours (optional):	
<input type="radio"/> Multi-point inspection (recommended): <input type="checkbox"/>	
<input type="radio"/> Signature:	

<input type="radio"/> Repair Order #:	Dealer stamp
<input type="radio"/> Distance:	
<input type="radio"/> Engine hours (optional):	
<input type="radio"/> Multi-point inspection (recommended): <input type="checkbox"/>	
<input type="radio"/> Signature:	

Scheduled Maintenance

<input type="radio"/> Repair Order #:	<p>Dealer stamp</p>
<input type="radio"/> Distance:	
<input type="radio"/> Engine hours (optional):	
<input type="radio"/> Multi-point inspection (recommended): <input type="checkbox"/>	
<input type="radio"/> Signature:	

<input type="radio"/> Repair Order #:	<p>Dealer stamp</p>
<input type="radio"/> Distance:	
<input type="radio"/> Engine hours (optional):	
<input type="radio"/> Multi-point inspection (recommended): <input type="checkbox"/>	
<input type="radio"/> Signature:	

Scheduled Maintenance

<input type="radio"/> Repair Order #:	<p>Dealer stamp</p>
<input type="radio"/> Distance:	
<input type="radio"/> Engine hours (optional):	
<input type="radio"/> Multi-point inspection (recommended): <input type="checkbox"/>	
<input type="radio"/> Signature:	

<input type="radio"/> Repair Order #:	<p>Dealer stamp</p>
<input type="radio"/> Distance:	
<input type="radio"/> Engine hours (optional):	
<input type="radio"/> Multi-point inspection (recommended): <input type="checkbox"/>	
<input type="radio"/> Signature:	

Scheduled Maintenance

<input type="radio"/> Repair Order #:	Dealer stamp
<input type="radio"/> Distance:	
<input type="radio"/> Engine hours (optional):	
<input type="radio"/> Multi-point inspection (recommended): <input type="checkbox"/>	
<input type="radio"/> Signature:	

<input type="radio"/> Repair Order #:	Dealer stamp
<input type="radio"/> Distance:	
<input type="radio"/> Engine hours (optional):	
<input type="radio"/> Multi-point inspection (recommended): <input type="checkbox"/>	
<input type="radio"/> Signature:	

Appendices

ELECTROMAGNETIC COMPATIBILITY



WARNING: Do not place objects or mount equipment on or near the airbag cover, on the side of the front or rear seatbacks, or in areas that may come into contact with a deploying airbag. Failure to follow these instructions may increase the risk of personal injury in the event of a crash.



WARNING: Do not fasten antenna cables to vehicle wiring, fuel pipes and brake pipes.



WARNING: Keep antenna and power cables at least 4 in (10 cm) from any electronic modules and airbags.

Note: We test and certify your vehicle to meet electromagnetic compatibility legislation. It is your responsibility to make sure that any equipment an authorized dealer installs on your vehicle complies with applicable local legislation and other requirements. Installation of some aftermarket electronic devices could degrade the performance of vehicle functions, which use radio frequency signals such as broadcast radio receiver, tire pressure monitoring system, push button start, Bluetooth connectivity or satellite navigation.

Note: Any radio frequency transmitter equipment in your vehicle (such as cellular telephones and amateur radio transmitters) must keep to the parameters in the following illustrations and table. We do not provide any other special provisions or conditions for installations or use.

Car

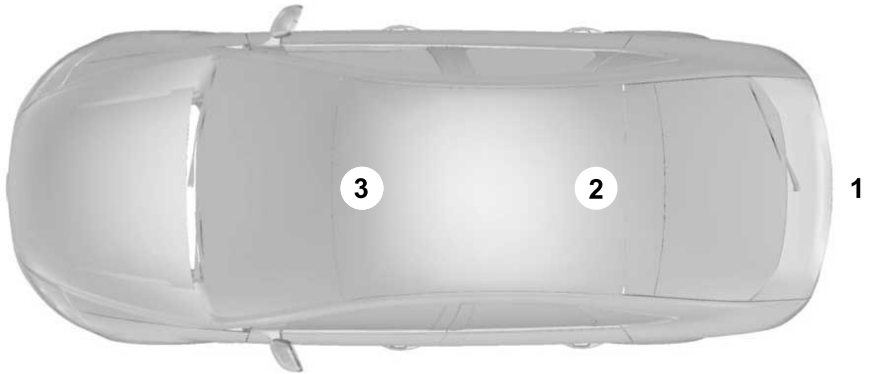

E239120

Appendices

Van



E239122

Truck

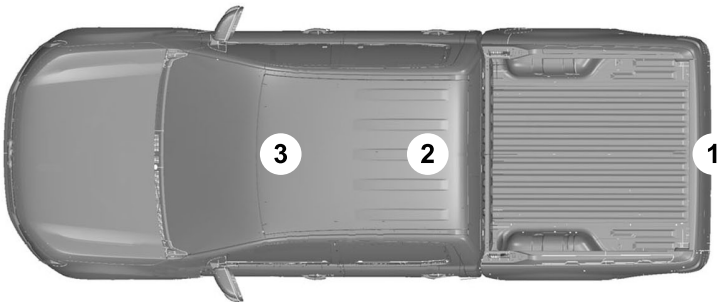

E239121

Appendices

Frequency Band MHz	Maximum output power Watt (Peak RMS)	Antenna Positions
1-30	50	1
50-54	50	2, 3
68-88	50	2, 3
142-176	50	2, 3
380-512	50	2, 3
806-870	10	2, 3

Appendices

END USER LICENSE AGREEMENT

VEHICLE SOFTWARE END USER LICENSE AGREEMENT (EULA)

- You ("You" or "Your" as applicable) have acquired a vehicle having several devices, including SYNC ® and various control modules, ("DEVICES") that include software licensed or owned by Ford Motor Company and its affiliates ("FORD MOTOR COMPANY"). Those software products of FORD MOTOR COMPANY origin, as well as associated media, printed materials, and "online" or electronic documentation ("SOFTWARE") are protected by international intellectual property laws and treaties. The SOFTWARE is licensed, not sold. All rights reserved.
- The SOFTWARE may interface with and/or communicate with, or may be later upgraded to interface with and/or communicate with additional software and/or systems provided by FORD MOTOR COMPANY.

IF YOU DO NOT AGREE TO THIS END USER LICENSE AGREEMENT ("EULA") DO NOT USE THE DEVICES OR COPY THE SOFTWARE. ANY USE OF THE SOFTWARE, INCLUDING BUT NOT LIMITED TO USE ON THE DEVICES, WILL CONSTITUTE YOUR AGREEMENT TO THIS EULA (OR RATIFICATION OF ANY PREVIOUS CONSENT).

GRANT OF SOFTWARE LICENSE: This EULA grants you the following license:

- You may use the SOFTWARE as installed on the DEVICES and as otherwise interfacing with systems and/or services provide by or through FORD MOTOR COMPANY or its third party software and service providers.

Description of Other Rights and Limitations

- **Speech Recognition:** If the SOFTWARE includes speech recognition component(s), you should understand that speech recognition is an inherently statistical process and that recognition errors are inherent in the process. Neither FORD MOTOR COMPANY nor its suppliers shall be liable for any damages arising out of errors in the speech recognition process. It is your responsibility to monitor any speech recognition functions included in the system.
- **Limitations on Reverse Engineering, Decompilation and Disassembly:** You may not reverse engineer, decompile, translate, disassemble or attempt to discover any source code or underlying ideas or algorithms of the SOFTWARE nor permit others to reverse engineer, decompile or disassemble the SOFTWARE, except and only to the extent that such activity is expressly permitted by applicable law notwithstanding this limitation or to the extent as may be permitted by the licensing terms governing use of any open source components included with the SOFTWARE.
- **Limitations on Distributing, Copying, Modifying and Creating Derivative Works:** You may not distribute, copy, make modifications to or create derivative works based on the SOFTWARE, except and only to the extent that such activity is expressly permitted by applicable law notwithstanding this limitation or to the extent as may be permitted by the licensing terms governing use of any open source components included with the SOFTWARE.

Appendices

- **Single EULA:** The end user documentation for the DEVICES and related systems and services may contain multiple EULAs, such as multiple translations and/or multiple media versions (e.g., in the user documentation and in the software). Even if you receive multiple EULAs, you are licensed to use only one (1) copy of the SOFTWARE.
- **SOFTWARE Transfer:** You may permanently transfer your rights under this EULA only as part of a sale or transfer of the DEVICES, provided you retain no copies, you transfer all of the SOFTWARE (including all component parts, the media and printed materials, any upgrades, and, if applicable, the Certificate(s) of Authenticity), and the recipient agrees to the terms of this EULA. If the SOFTWARE is an upgrade, any transfer must include all prior versions of the SOFTWARE.
- **Termination:** Without prejudice to any other rights, FORD MOTOR COMPANY may terminate this EULA if you fail to comply with the terms and conditions of this EULA.
- **Internet-Based Services Components:** The SOFTWARE may contain components that enable and facilitate the use of certain Internet-based services. You acknowledge and agree that FORD MOTOR COMPANY, third party software and service suppliers, its affiliates and/or its designated agent may automatically check the version of the SOFTWARE and/or its components that you are utilizing and may provide upgrades or supplements to the SOFTWARE that may be automatically downloaded to your DEVICES.
- **Additional Software/Services:** The SOFTWARE may permit FORD MOTOR COMPANY, third party software and service suppliers, its affiliates and/or its designated agent to provide or make available to you SOFTWARE updates, supplements, add-on components, or Internet-based services components of the SOFTWARE after the date you obtain your initial copy of the SOFTWARE ("Supplemental Components".) SOFTWARE updates may cause you to incur additional charges from your wireless service provider. If FORD MOTOR COMPANY or third party software and services suppliers provide or make available to you Supplemental Components and no other EULA terms are provided along with the Supplemental Components, then the terms of this EULA shall apply. FORD MOTOR COMPANY, its affiliates and/or its designated agent reserve the right to discontinue without liability any Internet-based services provided to you or made available to you through the use of the SOFTWARE.

Appendices

- **Links to Third Party Sites:** The SOFTWARE may provide you with the ability to link to third party sites. The third party sites are not under the control of FORD MOTOR COMPANY, its affiliates and/or its designated agent. Neither FORD MOTOR COMPANY nor its affiliates nor its designated agent are responsible for (i) the contents of any third party sites, any links contained in third party sites, or any changes or updates to third party sites, or (ii) webcasting or any other form of transmission received from any third party sites. If the SOFTWARE provides links to third party sites, those links are provided to you only as a convenience, and the inclusion of any link does not imply an endorsement of the third party site by FORD MOTOR COMPANY, its affiliates and/or its designated agent.
- **Obligation to Drive Responsibly:** You recognize your obligation to drive responsibly and keep attention on the road. You will read and abide with the DEVICES operating instructions particularly as they pertain to safety and you agree to assume any risk associated with the use of the DEVICES.

UPGRADES AND RECOVERY MEDIA:

If the SOFTWARE is provided by FORD MOTOR COMPANY separate from the DEVICES on media such as a ROM chip, CD ROM disk(s) or via web download or other means, and is labeled "For Upgrade Purposes Only" or "For Recovery Purposes Only" you may install one (1) copy of such SOFTWARE onto the DEVICES as a replacement copy for the existing SOFTWARE, and use it in accordance with this EULA, including any additional EULA terms accompanying the upgrade SOFTWARE.

INTELLECTUAL PROPERTY RIGHTS:

All title and intellectual property rights in and to the SOFTWARE (including but not limited to any images, photographs, animations, video, audio, music, text and "applets" incorporated into the SOFTWARE), the accompanying printed materials, and any copies of the SOFTWARE, are owned by FORD MOTOR COMPANY, or its affiliates or suppliers. The SOFTWARE is licensed, not sold. You may not copy the printed materials accompanying the SOFTWARE. All title and intellectual property rights in and to the content which may be accessed through use of the SOFTWARE is the property of the respective content owner and may be protected by applicable copyright or other intellectual property laws and treaties. This EULA grants you no rights to use such content outside its intended use. All rights not specifically granted under this EULA are reserved by FORD MOTOR COMPANY, its affiliates, and third party software and service providers and suppliers. Use of any on-line services which may be accessed through the SOFTWARE may be governed by the respective terms of use relating to such services. If this SOFTWARE contains documentation that is provided only in electronic form, you may print one copy of such electronic documentation.

EXPORT RESTRICTIONS: You acknowledge that the SOFTWARE is subject to U.S. and European Union export jurisdiction. You agree to comply with all applicable international and national laws that apply to the SOFTWARE, including the U.S. Export Administration Regulations, as well as end-user, end-use and destination restrictions issued by U.S. and other governments.

Appendices

TRADEMARKS: This EULA does not grant you any rights in connection with any trademarks or service marks of FORD MOTOR COMPANY, its affiliates, and third party software and service providers.

PRODUCT SUPPORT: Please refer to FORD MOTOR COMPANY instructions provided in the documentation for the DEVICES product support, such as the vehicle owner guide.

Should you have any questions concerning this EULA, or if you desire to contact FORD MOTOR COMPANY for any other reason, please refer to the address provided in the documentation for the DEVICES.

No Liability for Certain Damages: EXCEPT AS PROHIBITED BY LAW, FORD MOTOR COMPANY, ANY THIRD PARTY SOFTWARE OR SERVICES SUPPLIERS, AND THEIR AFFILIATES SHALL HAVE NO LIABILITY FOR ANY INDIRECT, SPECIAL, CONSEQUENTIAL OR INCIDENTAL DAMAGES ARISING FROM OR IN CONNECTION WITH THE USE OR PERFORMANCE OF THE SOFTWARE. THIS LIMITATION SHALL APPLY EVEN IF ANY REMEDY FAILS OF ITS ESSENTIAL PURPOSE. THERE ARE NO WARRANTIES OTHER THAN THOSE THAT MAY BE EXPRESSLY PROVIDED FOR YOUR NEW VEHICLE.

SYNC® Automotive Important Safety Information Read and follow instructions:

- Before using your SYNC® system, read and follow all instructions and safety information provided in this end user manual ("Owner Guide".) Not following precautions found in the Owner Guide can lead to an accident or other serious injuries.

General Operation

- **Voice Command Control:** Certain functions within the SYNC® system may be accomplished using voice commands. Using voice commands while driving helps you to operate the system without removing your hands from the wheel or eyes from the road.
- **Prolonged Views of Screen:** Do not access any function requiring a prolonged view of the screen while you are driving. Pull over in a safe and legal manner before attempting to access a function of the system requiring prolonged attention.
- **Volume Setting:** Do not raise the volume excessively. Keep the volume at a level where you can still hear outside traffic and emergency signals while driving. Driving while unable to hear these sounds could cause an accident.
- **Navigation Features:** Any navigation features included in the system are intended to provide turn by turn instructions to get you to a desired destination. Please make certain all persons using this system carefully read and follow instructions and safety information fully.
- **Distraction Hazard:** Any navigation features may require manual (non-verbal) setup. Attempting to perform such set-up or insert data while driving can distract your attention and could cause an accident or other serious injury. Stop the vehicle in a safe and legal manner before attempting these operations.
- **Let Your Judgment Prevail:** Any navigation features are provided only as an aid. Make your driving decisions based on your observations of local conditions and existing traffic regulations. Any such feature is not a

Appendices

substitute for your personal judgment. Any route suggestions made by this system should never replace any local traffic regulations or your personal judgment or knowledge of safe driving practices.

- **Route Safety:** Do not follow the route suggestions if doing so would result in an unsafe or illegal maneuver, if you would be placed in an unsafe situation, or if you would be directed into an area that you consider unsafe. The driver is ultimately responsible for the safe operation of the vehicle and therefore, must evaluate whether it is safe to follow the suggested directions.
- **Potential Map Inaccuracy:** Maps used by this system may be inaccurate because of changes in roads, traffic controls or driving conditions. Always use good judgment and common sense when following the suggested routes.
- **Emergency Services:** Do not rely on any navigation features included in the system to route you to emergency services. Ask local authorities or an emergency services operator for these locations. Not all emergency services such as police, fire stations, hospitals and clinics are likely to be contained in the map database for such navigation features.

Your Responsibilities and Assumptions of Risk

- You agree to each of the following: (a) Any use of the SOFTWARE while driving an automobile or other vehicle in violation of applicable law or otherwise driving in an unsafe manner presents a significant risk of distracted driving and should not be attempted under any circumstances; (b) Use of the SOFTWARE at excessive volume poses a significant risk of hearing damage and should not be attempted under any circumstances; (c) The SOFTWARE may not be compatible with new or different versions of an operating system, third party software, or third party services, and the SOFTWARE may potentially cause a critical failure of an operating system, third party software, or third party service. (d) Any third party service accessed by or third party software used with the SOFTWARE (i) may charge an additional fee for access, (ii) may not work correctly, on an uninterrupted basis, or error free, (iii) may change streaming formats or discontinue operation, (iv) may contain adult, profane or offensive content; and (v) may contain inaccurate, false or misleading traffic, weather, financial or safety information or other content; and (e) Use of the SOFTWARE may cause you to incur additional charges from your wireless service provider (WSP) and any data or minute calculators that may be included in the software program are for reference only, are not warranted in any way and should not be relied upon in anyway.
- When using the SOFTWARE, you agree to be responsible for and assume the entire risk to the items set forth in Section (a) – (e) above.

Appendices

Disclaimer of Warranty

YOU EXPRESSLY ACKNOWLEDGE AND AGREE THAT USE OF THE DEVICES AND SOFTWARE IS AT YOUR SOLE RISK AND THAT THE ENTIRE RISK AS TO SATISFACTORY QUALITY, PERFORMANCE, COMPATIBILITY, ACCURACY AND EFFORT IS WITH YOU. TO THE MAXIMUM EXTENT PERMITTED BY APPLICABLE LAW, THE SOFTWARE AND ANY THIRD PARTY SOFTWARE OR THIRD-PARTY SERVICES ARE PROVIDED "AS IS" AND "AS AVAILABLE", WITH ALL FAULTS AND WITHOUT WARRANTY OF ANY KIND, AND FORD MOTOR COMPANY HEREBY DISCLAIMS ALL WARRANTIES AND CONDITIONS WITH RESPECT TO THE SOFTWARE, THIRD PARTY SOFTWARE, AND THIRD-PARTY SERVICES, EITHER EXPRESS, IMPLIED OR STATUTORY, INCLUDING, BUT NOT LIMITED TO, THE IMPLIED WARRANTIES AND/OR CONDITIONS OF MERCHANTABILITY, OF SATISFACTORY QUALITY, OF FITNESS FOR AN PARTICULAR PURPOSE, OF ACCURACY, OF QUIET ENJOYMENT, AND NON-INFRINGEMENT OF THIRD-PARTY RIGHTS. FORD MOTOR COMPANY DOES NOT WARRANT (a) AGAINST INTERFERENCE WITH YOUR ENJOYMENT OF THE SOFTWARE, THIRD PARTY SOFTWARE, OR THIRD-PARTY SERVICES, (b) THAT THE SOFTWARE, THIRD PARTY SOFTWARE, OR THIRD-PARTY SERVICES WILL MEET YOUR REQUIREMENTS, (c) THAT THE OPERATION OF THE SOFTWARE, THIRD PARTY SOFTWARE, OR THIRD-PARTY SERVICES WILL BE UNINTERRUPTED OR ERROR-FREE, (d) OR THAT DEFECTS IN THE SOFTWARE, THIRD PARTY SOFTWARE, OR THIRD-PARTY SERVICES WILL BE CORRECTED. NO ORAL OR WRITTEN INFORMATION OR ADVICE GIVEN BY FORD MOTOR COMPANY OR ITS AUTHORIZED REPRESENTATIVE SHALL

CREATE A WARRANTY. SHOULD THE SOFTWARE, THIRD PARTY SOFTWARE, OR THIRD-PARTY SERVICES PROVE DEFECTIVE, YOU ASSUME THE ENTIRE COST OF ALL NECESSARY SERVICING, REPAIR OR CORRECTION. SOME JURISDICTIONS DO NOT ALLOW THE DISCLAIMER OF IMPLIED WARRANTIES OR LIMITATIONS ON APPLICABLE STATUTORY RIGHTS OF A CONSUMER, SO THE ABOVE DISCLAIMER MAY NOT FULLY APPLY TO YOU. THE SOLE WARRANTY PROVIDED BY FORD MOTOR COMPANY SHALL BE FOUND IN THE WARRANTY INFORMATION INCLUDING WITH YOUR OWNER GUIDE. TO THE EXTENT THAT THERE IS ANY CONFLICT BETWEEN THE TERMS OF THIS SECTION AND THE WARRANTY BOOKLET, THE WARRANTY BOOKLET SHALL CONTROL.

Applicable Law, Venue, Jurisdiction

- The laws of the State of Michigan govern this EULA and Your use of the SOFTWARE. Your use of the SOFTWARE may also be subject to other local, state, national, or international laws. Any litigation arising out of or related to this EULA shall be brought and maintained exclusively in a court of the State of Michigan located in Wayne County or in the United States District Court for the Eastern District of Michigan. You hereby consent to submit to the personal jurisdiction of a court in the State of Michigan located in Wayne County and the United States District Court for the Eastern District of Michigan for any dispute arising out of or relating to this EULA.

Appendices

Binding Arbitration and Class Action Waiver

(a) Application. This Section applies to any dispute EXCEPT IT DOES NOT INCLUDE A DISPUTE RELATING TO COPYRIGHT INFRINGEMENT, OR TO THE ENFORCEMENT OR VALIDITY OF YOUR, FORD MOTOR COMPANY, OR ANY OF FORD MOTOR COMPANY'S LICENSORS' INTELLECTUAL PROPERTY RIGHTS. Dispute means any dispute, action, or other controversy between You and FORD MOTOR COMPANY, other than the exceptions listed above, concerning the SOFTWARE (including its price) or this EULA, whether in contract, warranty, tort, statute, regulation, ordinance, or any other legal or equitable basis.

(b) Notice of Dispute. In the event of a Dispute, You or FORD MOTOR COMPANY must give the other a "Notice of Dispute", which is a written statement of the name, address, and contact information of the party giving it, the facts giving rise to the dispute, and the relief requested. You and FORD MOTOR COMPANY will attempt to resolve any dispute through informal negotiation within 60 days from the date the Notice of Dispute is sent. After 60 days, You or FORD MOTOR COMPANY may commence arbitration.

(c) Small claims court. You may also litigate any dispute in small claims court in your county of residence or FORD MOTOR COMPANY'S principal place of business, if the dispute meets all requirements to be heard in the small claims court. You may litigate in small claims court whether or not You negotiated informally first.

(d) Binding arbitration. If You and FORD MOTOR COMPANY, do not resolve any dispute by informal negotiation or in small claims court, any other effort to resolve the dispute will be conducted exclusively by binding arbitration. You are giving up

the right to litigate (or participate in as a party or class member) all disputes in court before a judge or jury. Instead, all disputes will be resolved before a neutral arbitrator, whose decision will be final except for a limited right of appeal under the Federal Arbitration Act. Any court with jurisdiction over the parties may enforce the arbitrator's award.

(e) Class action waiver. Any proceedings to resolve or litigate any dispute in any forum will be conducted solely on an individual basis. Neither you nor FORD MOTOR COMPANY, will seek to have any dispute heard as a class action, as a private attorney general action, or in any other proceeding in which any party acts or proposes to act in a representative capacity. No arbitration or proceeding will be combined with another without the prior written consent of all parties to all affected arbitrations or proceedings.

(f) Arbitration procedure. Any arbitration will be conducted by the American Arbitration Association (the "AAA"), under its Commercial Arbitration Rules. If You are an individual and use the SOFTWARE for personal or vehicle use, or if the value of the dispute is \$75,000 or less whether or not You are an individual or how You use the SOFTWARE, the AAA Supplementary Procedures for Consumer-Related Disputes will also apply. To commence arbitration, submit a Commercial Arbitration Rules Demand for Arbitration form to the AAA. You may request a telephonic or in-person hearing by following the AAA rules. In a dispute involving \$10,000 or less, any hearing will be telephonic unless the arbitrator finds good cause to hold an in-person hearing instead. For more information, see adr.org or call 1-800-778-7879. You agree to commence arbitration only in your county of residence or FORD MOTOR COMPANY'S principal place of business. The arbitrator

Appendices

may award the same damages to You individually as a court could. The arbitrator may award declaratory or injunctive relief only to You individually, and only to the extent required to satisfy Your individual claim.

(g) Arbitration fees and incentives.

- I. Disputes involving \$75,000 or less. FORD MOTOR COMPANY will promptly reimburse your filing fees and pay the AAA's and arbitrator's fees and expenses. If you reject FORD MOTOR COMPANY'S last written settlement offer made before the arbitrator was appointed ("last written offer"), your dispute goes all the way to an arbitrator's decision (called an "award"), and the arbitrator awards you more than the last written offer, FORD MOTOR COMPANY will give you three incentives: (1) pay the greater of the award or \$1,000; (2) pay twice your reasonable attorney's fees, if any; and (3) reimburse any expenses (including expert witness fees and costs) that your attorney reasonably accrues for investigating, preparing, and pursuing your claim in arbitration. The arbitrator will determine the amounts.
- ii. Disputes involving more than \$75,000. The AAA rules will govern payment of filing fees and the AAA's and arbitrator's fees and expenses.
- iii. Disputes involving any amount. In any arbitration you commence, FORD MOTOR COMPANY will seek its AAA or arbitrator's fees and expenses, or Your filing fees it reimbursed, only if the arbitrator finds the arbitration frivolous or brought for an improper purpose. In any arbitration FORD MOTOR COMPANY commences, it will pay all

filing, AAA, and arbitrator's fees and expenses. It will not seek its attorney's fees or expenses from you in any arbitration. Fees and expenses are not counted in determining how much a dispute involves.

(h) Claims or disputes must be filed within one year. To the extent permitted by law, any claim or dispute under this EULA to which this Section applies must be filed within one year in small claims court (Section c) or in arbitration (Section d). The one-year period begins when the claim or dispute first could be filed. If such a claim or dispute is not filed within one year, it is permanently barred.

(i) Severability. If the class action waiver (Section e) is found to be illegal or unenforceable as to all or some parts of a dispute, then that portion of Section e will not apply to those parts. Instead, those parts will be severed and proceed in a court of law, with the remaining parts proceeding in arbitration. If any other provision of that portion Section e is found to be illegal or unenforceable, that provision will be severed with the remainder of Section e remaining in full force and effect.

Telenav Software End User License Agreement

Please read these terms and conditions carefully before you use the TeleNav Software. Your use of the TeleNav Software indicates that you accept these terms and conditions. If you do not accept these terms and conditions, do not break the seal of the package, launch, or otherwise use the TeleNav Software. TeleNav may revise this Agreement and the privacy policy at any time, with or without notice to you. You agree to visit <http://www.telenav.com> from time to time to review the then current version of this Agreement and of the privacy policy.

Appendices

1. Safe and Lawful Use

You acknowledge that devoting attention to the TeleNav Software may pose a risk of injury or death to you and others in situations that otherwise require your undivided attention, and you therefore agree to comply with the following when using the TeleNav Software:

- (a) observe all traffic laws and otherwise drive safely;
- (b) use your own personal judgment while driving. If you feel that a route suggested by the TeleNav Software instructs you to perform an unsafe or illegal maneuver, places you in an unsafe situation, or directs you into an area that you consider to be unsafe, do not follow such instructions;
- (c) do not input destinations, or otherwise manipulate the TeleNav Software, unless your vehicle is stationary and parked;
- (d) do not use the TeleNav Software for any illegal, unauthorized, unintended, unsafe, hazardous, or unlawful purposes, or in any manner inconsistent with this Agreement;
- (e) arrange all GPS and wireless devices and cables necessary for use of the TeleNav Software in a secure manner in your vehicle so that they will not interfere with your driving and will not prevent the operation of any safety device (such as an airbag).

You agree to indemnify and hold TeleNav harmless against all claims resulting from any dangerous or otherwise inappropriate use of the TeleNav Software in any moving vehicle, including as a result of your failure to comply with the directions above.

2. Account Information

You agree: (a) when registering the TeleNav Software, to provide TeleNav with true, accurate, current, and complete information about yourself, and (b) to inform TeleNav promptly of any changes to such information, and to keep it true, accurate, current and complete.

3. Software License

- Subject to your compliance with the terms of this Agreement, TeleNav hereby grants to you a personal, non-exclusive, non-transferable license (except as expressly permitted below in connection with your permanent transfer of the TeleNav Software license), without the right to sublicense, to use the TeleNav Software (in object code form only) in order to access and use the TeleNav Software. This license shall terminate upon any termination or expiration of this Agreement. You agree that you will use the TeleNav Software only for your personal business or leisure purposes, and not to provide commercial navigation services to other parties.

3.1 License Limitations

- **(a)** reverse engineer, decompile, disassemble, translate, modify, alter or otherwise change the TeleNav Software or any part thereof; **(b)** attempt to derive the source code, audio library or structure of the TeleNav Software without the prior express written consent of TeleNav; **(c)** remove from the TeleNav Software, or alter, any of TeleNav's or its suppliers' trademarks, trade names, logos, patent or copyright notices, or other notices or markings; **(d)**

Appendices

distribute, sublicense or otherwise transfer the TeleNav Software to others, except as part of your permanent transfer of the TeleNav Software; or **(e)** use the TeleNav Software in any manner that

- i. infringes the intellectual property or proprietary rights, rights of publicity or privacy or other rights of any party,
- ii. violates any law, statute, ordinance or regulation, including but not limited to laws and regulations related to spamming, privacy, consumer and child protection, obscenity or defamation, or
- iii. is harmful, threatening, abusive, harassing, tortuous, defamatory, vulgar, obscene, libelous, or otherwise objectionable; and (f) lease, rent out, or otherwise permit unauthorized access by third parties to the TeleNav Software without advanced written permission of TeleNav.

4. Disclaimers

- To the fullest extent permissible pursuant to applicable law, in no event will TeleNav, its licensors and suppliers, or agents or employees of any of the foregoing, be liable for any decision made or action taken by you or anyone else in reliance on the information provided by the TeleNav Software. TeleNav also does not warrant the accuracy of the map or other data used for the TeleNav Software. Such data may not always reflect reality due to, among other things, road closures, construction, weather, new roads and other changing conditions. You are responsible for the entire risk arising out of your use of the TeleNav Software. For example but without limitation, you agree not to rely on the TeleNav Software for critical navigation in areas where the well-being or survival of you or others

is dependent on the accuracy of navigation, as the maps or functionality of the TeleNav Software are not intended to support such high risk applications, especially in more remote geographical areas.

- TELENAV EXPRESSLY DISCLAIMS AND EXCLUDES ALL WARRANTIES IN CONNECTION WITH THE TELENAV SOFTWARE, WHETHER STATUTORY, EXPRESS OR IMPLIED, INCLUDING ALL WARRANTIES WHICH MAY ARISE FROM COURSE OF DEALING, CUSTOM OR TRADE AND INCLUDING, BUT NOT LIMITED TO, THE IMPLIED WARRANTIES OF MERCHANTABILITY, FITNESS FOR A PARTICULAR PURPOSE AND NON-INFRINGEMENT OF THIRD PARTY RIGHTS WITH RESPECT TO THE TELENAV SOFTWARE.
- Certain jurisdictions do not permit the disclaimer of certain warranties, so this limitation may not apply to you.

5. Limitation of Liability

- TO THE EXTENT PERMITTED UNDER APPLICABLE LAW, UNDER NO CIRCUMSTANCES SHALL TELENAV OR ITS LICENSORS AND SUPPLIERS BE LIABLE TO YOU OR TO ANY THIRD PARTY FOR ANY INDIRECT, INCIDENTAL, CONSEQUENTIAL, SPECIAL OR EXEMPLARY DAMAGES (INCLUDING IN EACH CASE, BUT NOT LIMITED TO, DAMAGES FOR THE INABILITY TO USE THE EQUIPMENT OR ACCESS DATA, LOSS OF DATA, LOSS OF BUSINESS, LOSS OF PROFITS, BUSINESS INTERRUPTION OR THE LIKE) ARISING OUT OF THE USE OF OR INABILITY TO USE THE TELENAV SOFTWARE, EVEN IF TELENAV HAS BEEN ADVISED OF THE POSSIBILITY OF SUCH DAMAGES. NOTWITHSTANDING ANY DAMAGES THAT YOU MIGHT INCUR FOR ANY

Appendices

REASON WHATSOEVER (INCLUDING, WITHOUT LIMITATION, ALL DAMAGES REFERENCED HEREIN AND ALL DIRECT OR GENERAL DAMAGES IN CONTRACT, TORT (INCLUDING NEGLIGENCE) OR OTHERWISE), THE ENTIRE LIABILITY OF TELENAV AND OF ALL OF TELENAV'S SUPPLIERS SHALL BE LIMITED TO THE AMOUNT ACTUALLY PAID BY YOU FOR THE TELENAV SOFTWARE. SOME STATES AND/OR JURISDICTIONS DO NOT ALLOW THE EXCLUSION OR LIMITATION OF INCIDENTAL OR CONSEQUENTIAL DAMAGES, SO THE ABOVE LIMITATIONS OR EXCLUSIONS MAY NOT APPLY TO YOU.

6. Arbitration and Governing Law

- You agree that any dispute, claim or controversy arising out of or relating to this Agreement or the TeleNav Software shall be settled by independent arbitration involving a neutral arbitrator and administered by the American Arbitration Association in the County of Santa Clara, California. The arbitrator shall apply the Commercial Arbitration Rules of the American Arbitration Association, and the judgment upon the award rendered by the arbitrator may be entered by any court having jurisdiction. Note that there is no judge or jury in an arbitration proceeding and the decision of the arbitrator shall be binding upon both parties. You expressly agree to waive your right to a jury trial. This Agreement and performance hereunder will be governed by and construed in accordance with the laws of the State of California, without giving effect to its conflict of law provisions. To the extent judicial action is necessary in connection with the binding arbitration, both TeleNav and you agree to submit

to the exclusive jurisdiction of the courts of the County of Santa Clara, California. The United Nations Convention on Contracts for the International Sale of Goods shall not apply.

7. Assignment

- You may not resell, assign, or transfer this Agreement or any of your rights or obligations, except in totality, in connection with your permanent transfer of the TeleNav Software, and expressly conditioned upon the new user of the TeleNav Software agreeing to be bound by the terms and conditions of this Agreement. Any such sale, assignment or transfer that is not expressly permitted under this paragraph will result in immediate termination of this Agreement, without liability to TeleNav, in which case you and all other parties shall immediately cease all use of the TeleNav Software. Notwithstanding the foregoing, TeleNav may assign this Agreement to any other party at any time without notice, provided the assignee remains bound by this Agreement.

8. Miscellaneous

8.1

This Agreement constitutes the entire agreement between TeleNav and you with respect to the subject matter hereof.

8.2

Except for the limited licenses expressly granted in this Agreement, TeleNav retains all right, title and interest in and to the TeleNav Software, including without limitation all related intellectual property rights. No licenses or other rights which are not expressly granted in this Agreement are intended to, or shall be, granted or

Appendices

conferred by implication, statute, inducement, estoppel or otherwise, and TeleNav and its suppliers and licensors hereby reserve all of their respective rights other than the licenses explicitly granted in this Agreement.

8.3

By using the TeleNav Software, you consent to receive from TeleNav all communications, including notices, agreements, legally required disclosures or other information in connection with the TeleNav Software (collectively, "Notices") electronically. TeleNav may provide such Notices by posting them on TeleNav's Website or by downloading such Notices to your wireless device. If you desire to withdraw your consent to receive Notices electronically, you must discontinue your use of the TeleNav Software.

8.4

TeleNav's or your failure to require performance of any provision shall not affect that party's right to require performance at any time thereafter, nor shall a waiver of any breach or default of this Agreement constitute a waiver of any subsequent breach or default or a waiver of the provision itself.

8.5

If any provision herein is held unenforceable, then such provision will be modified to reflect the intention of the parties, and the remaining provisions of this Agreement will remain in full force and effect.

8.6

The headings in this Agreement are for convenience of reference only, will not be deemed to be a part of this Agreement, and will not be referred to in connection with the construction or interpretation of this Agreement. As used in this Agreement, the words "include" and "including" and variations thereof, will not be deemed to be terms of limitation, but rather will be deemed to be followed by the words "without limitation".

9. Other Vendors Terms and Conditions

- The Telenav Software utilizes map and other data licensed to Telenav by third party vendors for the benefit of you and other end users. This Agreement includes end-user terms applicable to these companies (included at the end of this Agreement), and thus your use of the Telenav Software is also subject to such terms. You agree to comply with the following additional terms and conditions, which are applicable to Telenav's third party vendor licensors::

9.1 End User Terms Required by HERE North America, LLC

The data ("Data") is provided for your personal, internal use only and not for resale. It is protected by copyright, and is subject to the following terms and conditions which are agreed to by you, on the one hand, and Telenav ("Telenav") and its licensors (including their licensors and suppliers) on the other hand.

© 2013 HERE. All rights reserved.

The Data for areas of Canada includes information taken with permission from Canadian authorities, including: © Her Majesty the Queen in Right of Canada, © Queen's Printer for Ontario, © Canada Post Corporation, GeoBase®, © Department of Natural Resources Canada.

Appendices

HERE holds a non-exclusive license from the United States Postal Service® to publish and sell ZIP+4® information.

©United States Postal Service® 2014. Prices are not established, controlled or approved by the United States Postal Service®. The following trademarks and registrations are owned by the USPS: United States Postal Service, USPS, and ZIP+4

The Data for Mexico includes certain data from Instituto Nacional de Estadística y Geografía.

9.2 End User Terms Required by NAV2 (Shanghai) Co., Ltd

The data (“Data”) is provided for your personal, internal use only and not for resale. It is protected by copyright, and is subject to the following terms and conditions which are agreed to by you, on the one hand, and NAV2 (Shanghai) Co., Ltd (“NAV2”) and its licensors (including their licensors and suppliers) on the other hand. 20xx. All rights reserved

Terms and Conditions

Permitted Use. You agree to use this Data together with the Telenav Software solely for the internal business and personal purposes for which you were licensed, and not for service bureau, time-sharing or other similar purposes. Accordingly, but subject to the restrictions set forth in the following paragraphs, you agree not to otherwise reproduce, copy, modify, decompile, disassemble, create any derivative works of, or reverse engineer any portion of this Data, and may not transfer or distribute it in any form, for any purpose, except to the extent permitted by mandatory laws.

Restrictions. Except where you have been specifically licensed to do so by Telenav, and without limiting the preceding paragraph, you may not use this Data (a) with any products, systems, or applications installed or otherwise connected to or in communication with vehicles, capable of vehicle navigation, positioning, dispatch, real time route guidance, fleet management or similar applications; or (b) with or in communication with any positioning devices or any mobile or wireless-connected electronic or computer devices, including without limitation cellular phones, palmtop and handheld computers, pagers, and personal digital assistants or PDAs.

Warning. The Data may contain inaccurate or incomplete information due to the passage of time, changing circumstances, sources used and the nature of collecting comprehensive geographic data, any of which may lead to incorrect results.

No Warranty. This Data is provided to you “as is,” and you agree to use it at your own risk. Telenav and its licensors (and their licensors and suppliers) make no guarantees, representations or warranties of any kind, express or implied, arising by law or otherwise, including but not limited to, content, quality, accuracy, completeness, effectiveness, reliability, fitness for a particular purpose, usefulness, use or results to be obtained from this Data, or that the Data or server will be uninterrupted or error-free.

Disclaimer of Warranty: TELENAV AND ITS LICENSORS (INCLUDING THEIR LICENSORS AND SUPPLIERS) DISCLAIM ANY WARRANTIES, EXPRESS OR IMPLIED, OF QUALITY, PERFORMANCE, MERCHANTABILITY, FITNESS FOR A

Appendices

PARTICULAR PURPOSE OR NON-INFRINGEMENT. Some States, Territories and Countries do not allow certain warranty exclusions, so to that extent the above exclusion may not apply to you.

Disclaimer of Liability: TELENV AND ITS LICENSORS (INCLUDING THEIR LICENSORS AND SUPPLIERS) SHALL NOT BE LIABLE TO YOU: IN RESPECT OF ANY CLAIM, DEMAND OR ACTION, IRRESPECTIVE OF THE NATURE OF THE CAUSE OF THE CLAIM, DEMAND OR ACTION ALLEGING ANY LOSS, INJURY OR DAMAGES, DIRECT OR INDIRECT, WHICH MAY RESULT FROM THE USE OR POSSESSION OF THE INFORMATION; OR FOR ANY LOSS OF PROFIT, REVENUE, CONTRACTS OR SAVINGS, OR ANY OTHER DIRECT, INDIRECT, INCIDENTAL, SPECIAL OR CONSEQUENTIAL DAMAGES ARISING OUT OF YOUR USE OF OR INABILITY TO USE THIS INFORMATION, ANY DEFECT IN THE INFORMATION, OR THE BREACH OF THESE TERMS OR CONDITIONS, WHETHER IN AN ACTION IN CONTRACT OR TORT OR BASED ON A WARRANTY, EVEN IF TELENV OR ITS LICENSORS HAVE BEEN ADVISED OF THE POSSIBILITY OF SUCH DAMAGES. Some States, Territories and Countries do not allow certain liability exclusions or damages limitations, so to that extent the above may not apply to you.

Export Control. You shall not export from anywhere any part of the Data or any direct product thereof except in compliance with, and with all licenses and approvals required under, applicable export laws, rules and regulations, including but not limited to the laws, rules and regulations administered by the Office of Foreign Assets Control of the U.S. Department of Commerce and the Bureau of Industry and Security of the U.S. Department of Commerce. To the extent that any such

export laws, rules or regulations prohibit HERE from complying with any of its obligations hereunder to deliver or distribute Data, such failure shall be excused and shall not constitute a breach of this Agreement.

Entire Agreement. These terms and conditions constitute the entire agreement between Telenav (and its licensors, including their licensors and suppliers) and you pertaining to the subject matter hereof, and supersedes in their entirety any and all written or oral agreements previously existing between us with respect to such subject matter.

Governing Law. The above terms and conditions shall be governed by the laws of the State of Illinois [insert "Netherlands" where European HERE Data is used], without giving effect to (i) its conflict of laws provisions, or (ii) the United Nations Convention for Contracts for the International Sale of Goods, which is explicitly excluded. You agree to submit to the jurisdiction of the State of Illinois [insert "The Netherlands" where European HERE Data is used] for any and all disputes, claims and actions arising from or in connection with the Data provided to you hereunder.

Government End Users. If the Data is being acquired by or on behalf of the United States government or any other entity seeking or applying rights similar to those customarily claimed by the United States government, this Data is a "commercial item" as that term is defined at 48 C.F.R. ("FAR") 2.101, is licensed in accordance with these End-User Terms, and each copy of Data delivered or otherwise furnished shall be marked and embedded as appropriate with the following "Notice of Use," and shall be treated in accordance with such Notice:

Appendices

NOTICE OF USE

CONTRACTOR (MANUFACTURER/
SUPPLIER) NAME: HERE

CONTRACTOR (MANUFACTURER/
SUPPLIER) ADDRESS: c/o Nokia, 425
West Randolph Street, Chicago, Illinois
60606

This Data is a commercial item as
defined in FAR 2.101 and is subject to
these End-User Terms under which this
Data was provided.

© 1987 – 2014 HERE – All rights reserved.

If the Contracting Officer, federal government agency, or any federal official refuses to use the legend provided herein, the Contracting Officer, federal government agency, or any federal official must notify HERE prior to seeking additional or alternative rights in the Data.

I. US/Canada Territory

A. United States Data. The End-User Terms for any Application containing Data for the United States shall contain the following notices:

“HERE holds a non-exclusive license from the United States Postal Service® to publish and sell ZIP+4® information.”

“©United States Postal Service® 20XX. Prices are not established, controlled or approved by the United States Postal Service®. The following trademarks and registrations are owned by the USPS: United States Postal Service, USPS, and ZIP+4.”

B. Canada Data. The following provisions apply to the Data for Canada, which may include or reflect data from third party licensors (“Third Party Data”), including Her Majesty the Queen in Right of Canada (“Her Majesty”), Canada Post Corporation (“Canada Post”) and the Department of Natural Resources of Canada (“NRCan”):

1. Disclaimer and Limitation: Client agrees that its use of the Third Party Data is subject to the following provisions:

a. Disclaimer: The Third Party Data is licensed on an “as is” basis. The licensors of such data, including Her Majesty, Canada Post and NRCan, make no guarantees, representations or warranties respecting such data, either express or implied, arising by law or otherwise, including but not limited to, effectiveness, completeness, accuracy or fitness for a particular purpose.

b. Limitation on Liability: The Third Party Data licensors, including Her Majesty, Canada Post and NRCan, shall not be liable: (i) in respect of any claim, demand or action, irrespective of the nature of the cause of the claim, demand or action alleging any loss, injury or damages, direct or indirect, which may result from the use or possession of such Data; or (ii) in any way for loss of revenues or contracts, or any other consequential loss of any kind resulting from any defect in the Data.

Appendices

2. Copyright Notice: In connection with each copy of all or any portion of the Data for the Territory of Canada, Client shall affix in a conspicuous manner the following copyright notice on at least one of: (i) the label for the storage media of the copy; (ii) the packaging for the copy; or (iii) other materials packaged with the copy, such as user manuals or end user license agreements: "This data includes information taken with permission from Canadian authorities, including © Her Majesty the Queen in Right of Canada, © Queen's Printer for Ontario, © Canada Post Corporation, GeoBase®, © The Department of Natural Resources Canada. All rights reserved!"

3. End-User Terms: Except as otherwise agreed by the parties, in connection with the provision of any portion of the Data for the Territory of Canada to End-Users as may be authorized under the Agreement, Client shall provide such End-Users, in a reasonably conspicuous manner, with terms (set forth with other end user terms required to be provided under the Agreement, or as otherwise may be provided, by Client) which shall include the following provisions on behalf of the Third Party Data licensors, including Her Majesty, Canada Post and NRCan:

The Data may include or reflect data of licensors, including Her Majesty the Queen in the Right of Canada ("Her Majesty"), Canada Post Corporation ("Canada Post") and the Department of Natural Resources Canada ("NRCan"). Such data is licensed on an "as is" basis. The licensors, including Her Majesty, Canada Post and NRCan, make no guarantees, representations or warranties respecting such data,

either express or implied, arising by law or otherwise, including but not limited to, effectiveness, completeness, accuracy or fitness for a particular purpose. The licensors, including Her Majesty, Canada Post and NRCan, shall not be liable in respect of any claim, demand or action, irrespective of the nature of the cause of the claim, demand or action alleging any loss, injury or damages, direct or indirect, which may result from the use or possession of the data or the Data. The licensors, including Her Majesty, Canada Post and NRCan, shall not be liable in any way for loss of revenues or contracts, or any other consequential loss of any kind resulting from any defect in the data or the Data.

End User shall indemnify and save harmless the licensors, including Her Majesty, Canada Post and NRCan, and their officers, employees and agents from and against any claim, demand or action, irrespective of the nature of the cause of the claim, demand or action, alleging loss, costs, expenses, damages or injuries (including injuries resulting in death) arising out of the use or possession of the data or the Data.

4. Additional Provisions: The terms contained in this Section are in addition to all of the rights and obligations of the parties under the Agreement. To the extent that any of the provisions of this Section are inconsistent with, or conflict with, any other provisions of the Agreement, the provisions of this Section shall prevail.

Appendices

II. Mexico. The following provision applies to the Data for Mexico, which includes certain data from the Instituto Nacional de Estadística y Geografía (“INEGI”):

A. Any and all copies of the Data and/or packaging containing Data for Mexico shall contain the following notice: “Fuente: INEGI (Instituto Nacional de Estadística y Geografía)”

III. Latin America Territory

A. Third Party Notices. Any and all copies of the Data and/or packaging relating thereto shall include the respective Third Party Notices set forth below and used as described below corresponding to the Territory (or portion thereof) included in such copy:

Territory Notice

Argentina IGN “INSTITUTO GEOGRAFICO NACIONAL ARGENTINO”

Ecuador “INSTITUTO GEOGRAFICO MILITAR DEL ECUADOR AUTORIZACION N° IGM-2011-01- PCO-01 DEL 25 DE ENERO DE 2011”
“source: © IGN 2009 - BD TOPO ®”

Guadeloupe, French Guiana and Martinique Mexico “Fuente: INEGI (Instituto Nacional de Estadística y Geografía)”

IV. Middle East Territory

A. Third Party Notices. Any and all copies of the Data and/or packaging relating thereto shall include the respective Third Party Notices set forth below and used as described below corresponding to the Territory (or portion thereof) included in such copy:

Country Notice

Jordan “© Royal Jordanian Geographic Centre”. The foregoing notice requirement for Jordan Data is a material term of the Agreement. If Client or any of its permitted sublicensees (if any) fail to meet such requirement, HERE shall have the right to terminate Client’s license with respect to the Jordan Data.

B. Jordan Data. Client and its permitted sublicensees (if any) are restricted from licensing and/or otherwise distributing HERE’s database for the country of Jordan (“Jordan Data”) for use in Enterprise Applications to (i) non-Jordanian entities for use of the Jordan Data solely in Jordan or (ii) Jordan-based customers. In addition, Client, its permitted sublicensees (if any) and End-Users are restricted from using the Jordan Data in Enterprise Applications if such party is (i) a non-Jordanian entity using the Jordan Data solely in Jordan or (ii) a Jordan-based customer. For purposes of the foregoing, “Enterprise Applications” shall mean Geomarketing applications, GIS applications, mobile business asset management applications, call center applications, telematics applications, public organization Internet applications or for providing geocoding services.

Appendices

V. Europe Territory

A. Use of Certain Traffic Codes in Europe

1. General Restrictions Applicable to Traffic Codes. Client acknowledges and agrees that in certain countries of the Europe Territory, Client will need to obtain rights directly from third party RDS-TMC code providers to receive and use the Traffic Codes in the Data and to deliver to End-Users Transactions in any way derived from or based on such Traffic Codes. For such countries, HERE shall deliver the Data incorporating Traffic Codes to Client only after receiving certification from Client of its having obtained such rights.

2. Display of Third Party Rights Legends for Belgium. Client shall, for each Transaction that uses Traffic Codes for Belgium, provide the following notice to the End-User: "Traffic Codes for Belgium are provided by the Ministerie van de Vlaamse Gemeenschap and the Ministère de l'Équipement et des Transports."

B. Paper Maps. With respect to any license granted to Client relating to making, selling or distributing paper maps (i.e., a map fixed on a paper or paper-like medium): (a) such license with respect to Data for the Territory of Great Britain is conditioned on Client's entering into and complying with a separate written agreement with the Ordnance Survey ("OS") to create and sell paper maps, Client's paying to the OS any and all applicable paper map royalties, and Client's complying with the OS copyright notice requirements; (b) such license for selling or otherwise distributing for charge with respect to Data for the Territory of Czech Republic

is conditioned on Client's obtaining prior written consent from Kartografie a.s.; (c) such license for selling or distributing with respect to Data for the Territory of Switzerland is conditioned on Client's obtaining a permit from Bundesamt für Landestopografie of Switzerland; (d) Client is restricted from using Data for the Territory of France to create paper maps with a scale between 1:5,000 and 1:250,000; and (e) Client is restricted from using any Data to create, sell or distribute paper maps that are the same or substantially similar, in terms of data content and specific use of color, symbols and scale, to paper maps published by the European national mapping agencies, including without limitation, Landvermessungämter of Germany, Topografische Dienst of the Netherlands, Nationaal Geografisch Instituut of Belgium, Bundesamt für Landestopografie of Switzerland, Bundesamt für Eich-und Vermessungswesen of Austria, and the National Land Survey of Sweden.

C. OS Enforcement. Without limiting Section IV(B) above, with respect to Data for the Territory of Great Britain, Client acknowledges and agrees that the Ordnance Survey ("OS") may bring a direct action against Client to enforce compliance with the OS copyright notice (see Section IV(D) below) and paper map requirements (see Section IV(B) above) contained in this Agreement.

D. Third Party Notices. Any and all copies of the Data and/or packaging relating thereto shall include the respective Third Party Notices set forth below and used as described below corresponding to the Territory (or portion thereof) included in such copy:

Country(ies) Notice

Appendices

Austria	“© Bundesamt für Eich- und Vermessungswesen”	Spain	“Información geográfica propiedad del CNIG”
Croatia		Sweden	“Based upon electronic data © National Land Survey Sweden.”
Cyprus,		Switzerland	“Topografische Grundlage: © Bundesamt für Landestopographie.
Estonia,			E. Respective Country Distribution. Client acknowledges that HERE has not received approvals to distribute map data for the following countries in such respective countries: Albania, Belarus, Kyrgyzstan, Moldova and Uzbekistan. HERE may update such list from time to time. The license rights granted to Client under this TL with respect to the Data for such countries are contingent upon Client’s compliance with all applicable laws and regulations, including, without limitation, any required licenses or approvals to distribute the Application incorporating such Data in such respective countries.
Latvia,	“© EuroGeographics”		
Lithuania,			
Moldova,			
Poland,			
Slovenia			
and/or			
Ukraine			
France	“source: © IGN 2009 – BD TOPO ®”		
Germany	“Die Grundlagendaten wurden mit Genehmigung der zuständigen Behörden entnommen”		
Great Britain	“Contains Ordnance Survey data © Crown copyright and database right 2010 Contains Royal Mail data © Royal Mail copyright and database right 2010”		
Greece	“Copyright Geomatics Ltd.”	VI. Australia Territory	
Hungary	“Copyright © 2003; Top-Map Ltd.”		A. Third Party Notices. Any and all copies of the Data and/or packaging relating thereto shall include the respective Third Party Notices set forth below and used as described below corresponding to the Territory (or portion thereof) included in such copy:
Italy	“La Banca Dati Italiana è stata prodotta usando quale riferimento anche cartografia numerica ed al tratto prodotta e fornita dalla Regione Toscana.”		Copyright. Based on data provided under license from PSMA Australia Limited (www.pasma.com.au).
Norway	“Copyright © 2000; Norwegian Mapping Authority”		
Portugal	“Source: IgeoE – Portugal”		

Appendices

Product incorporates data which is © 20XX Telstra Corporation Limited, GM Holden Limited, Intelomatics Australia Pty Ltd and Continental Pty Ltd.

B. Third Party Notices for Australia. In addition to the foregoing, the End-User Terms for any Application containing RDS-TMC Traffic Codes for Australia shall contain the following notice: “Product incorporates traffic location codes which is © 20XX Telstra Corporation Limited and its licensors.”

AT&T Vehicle Network Carrier Telematics Disclosure

END USER FOR PURPOSES OF THIS SECTION MEANS YOU AND YOUR HEIRS, EXECUTORS, LEGAL PERSONAL REPRESENTATIVES AND PERMITTED ASSIGNS. FOR PURPOSES OF THIS SECTION “UNDERLYING WIRELESS SERVICE CARRIER” INCLUDES ITS AFFILIATES AND CONTRACTORS AND THEIR RESPECTIVE OFFICERS, DIRECTORS, EMPLOYEES, SUCCESSORS AND ASSIGNS. END USER HAS NO CONTRACTUAL RELATIONSHIP WITH THE UNDERLYING WIRELESS SERVICE CARRIER AND END USER IS NOT A THIRD PARTY BENEFICIARY OF ANY AGREEMENT BETWEEN FORD AND UNDERLYING CARRIER. END USER UNDERSTANDS AND AGREES THAT THE UNDERLYING CARRIER HAS NO LEGAL, EQUITABLE, OR OTHER LIABILITY OF ANY KIND TO END USER. IN ANY EVENT, REGARDLESS OF THE FORM OF THE ACTION, WHETHER FOR BREACH OF CONTRACT, WARRANTY, NEGLIGENCE, STRICT LIABILITY IN TORT OR OTHERWISE, END USER'S EXCLUSIVE REMEDY FOR CLAIMS ARISING IN ANY WAY IN CONNECTION WITH THIS AGREEMENT, FOR ANY CAUSE WHATSOEVER, INCLUDING BUT NOT LIMITED TO ANY FAILURE OR

DISRUPTION OF SERVICE PROVIDED HEREUNDER, IS LIMITED TO PAYMENT OF DAMAGES IN AN AMOUNT NOT TO EXCEED THE AMOUNT PAID BY END USER FOR THE SERVICES DURING THE TWO-MONTH PERIOD PRECEDING THE DATE THE CLAIM AROSE.

(ii) END USER AGREES TO INDEMNIFY AND HOLD HARMLESS THE UNDERLYING WIRELESS SERVICE CARRIER AND ITS OFFICERS, EMPLOYEES, AND AGENTS AGAINST ANY AND ALL CLAIMS, INCLUDING WITHOUT LIMITATION CLAIMS FOR LIBEL, SLANDER, OR ANY PROPERTY DAMAGE, PERSONAL INJURY OR DEATH, ARISING IN ANY WAY, DIRECTLY OR INDIRECTLY, IN CONNECTION WITH THIS AGREEMENT OR THE USE, FAILURE TO USE, OR INABILITY TO USE THE DEVICE EXCEPT WHERE THE CLAIMS RESULT FROM THE UNDERLYING CARRIER'S GROSS NEGLIGENCE OR WILLFUL MISCONDUCT. THIS INDEMNITY WILL SURVIVE THE TERMINATION OF THE AGREEMENT.

(iii) END USER HAS NO PROPERTY RIGHT IN ANY NUMBER ASSIGNED TO THE DEVICE.

(iv) END USER UNDERSTANDS THAT FORD AND THE UNDERLYING CARRIER CANNOT GUARANTEE THE SECURITY OF WIRELESS TRANSMISSIONS, AND WILL NOT BE LIABLE FOR ANY LACK OF SECURITY RELATING TO THE USE OF THE SERVICES

THE SERVICE IS FOR [END USER'S] USE ONLY AND END USER MAY NOT RESELL THE SERVICE TO ANY OTHER PARTY END USER UNDERSTANDS THAT THE UNDERLYING CARRIER DOES NOT GUARANTEE ANY END USER UNINTERRUPTED SERVICE OR COVERAGE. THE UNDERLYING CARRIER DOES NOT WARRANT THAT END USERS CAN OR WILL BE LOCATED USING THE SERVICE. THE UNDERLYING CARRIER

Appendices

MAKES NO WARRANTY, EXPRESS OR IMPLIED, OF MERCHANTABILITY OR FITNESS FOR A PARTICULAR PURPOSE, SUITABILITY, OR PERFORMANCE REGARDING ANY SERVICES OR GOODS, AND IN NO EVENT SHALL AT&T BE LIABLE, WHETHER OR NOT DUE TO ITS OWN NEGLIGENCE, FOR ANY: (A) ACT OR OMISSION OF A THIRD PARTY; (B) MISTAKES, OMISSIONS, INTERRUPTIONS, ERRORS, FAILURES TO TRANSMIT, DELAYS, OR DEFECTS IN THE SERVICE PROVIDED BY OR THROUGH THE UNDERLYING CARRIER; (C) DAMAGE OR INJURY CAUSED BY SUSPENSION OR TERMINATION BY THE UNDERLYING CARRIER; OR (D) DAMAGE OR INJURY CAUSED BY A FAILURE OR DELAY IN CONNECTING A CALL TO ANY ENTITY, INCLUDING 911 OR ANY OTHER EMERGENCY SERVICE. TO THE FULL EXTENT ALLOWED BY LAW, THE END USER RELEASES, INDEMNIFIES AND HOLDS THE UNDERLYING CARRIER HARMLESS FROM AND AGAINST ANY AND ALL CLAIMS OF ANY PERSON OR ENTITY FOR DAMAGES OF ANY NATURE ARISING IN ANY WAY FROM OR RELATING TO, DIRECTLY OR INDIRECTLY, SERVICES PROVIDED BY THE UNDERLYING CARRIER OR ANY PERSON'S USE THEREOF, INCLUDING CLAIMS ARISING IN WHOLE OR IN PART FROM THE ALLEGED NEGLIGENCE OF THE UNDERLYING CARRIER.

VII. China Territory

Personal Use Only

You agree to use this Data together with [insert name of Client Application] for the solely personal, non-commercial purposes for which you were licensed, and not for service bureau, time-sharing or other similar purposes. Accordingly, but subject to the restrictions set forth in the following paragraphs, you may copy this Data only as necessary for your personal use to (i)

view it, and (ii) save it, provided that you do not remove any copyright notices that appear and do not modify the Data in any way. You agree not to otherwise reproduce, copy, modify, decompile, disassemble or reverse engineer any portion of this Data, and may not transfer or distribute it in any form, for any purpose, except to the extent permitted by mandatory laws.

Restrictions

Except where you have been specifically licensed to do so by NAV2, and without limiting the preceding paragraph, you may not (a) use this Data with any products, systems, or applications installed or otherwise connected to or in communication with vehicles, capable of vehicle navigation, positioning, dispatch, real time route guidance, fleet management or similar applications; or (b) with or in communication with any positioning devices or any mobile or wireless-connected electronic or computer devices, including without limitation cellular phones, palmtop and handheld computers, pagers, and personal digital assistants or PDAs. You agree to cease using this Data if you fail to comply with these terms and conditions.

Limited Warranty

NAV2 warrants that (a) the Data will perform substantially in accordance with the accompanying written materials for a period of ninety (90) days from the date of receipt, and (b) any support services provided by NAV2 shall be substantially as described in applicable written materials provided to you by NAV2, and NAV2's support engineers will make commercially reasonable efforts to solve any problem issues.

Appendices

rigCustomer Remedies

NAV2 and its suppliers' entire liability and your exclusive remedy shall be, at NAV2's sole discretion, either (a) return of the price paid, if any, or (b) repair or replacement of the Data that do not meet NAV2's Limited Warranty and that are returned to NAV2 with a copy of your receipt. This Limited Warranty is void if failure of the Data has resulted from accident, abuse, or misapplication. Any replacement Data will be warranted for the remainder of the original warranty period or thirty (30) days, whichever is longer. Neither these remedies nor any product support services offered by NAV2 are available without proof of purchase from an authorized international source.

No Other Warranty:

EXCEPT FOR THE LIMITED WARRANTY SET FORTH ABOVE AND TO THE EXTENT PERMITTED BY APPLICABLE LAW, NAV2 AND ITS LICENSORS (INCLUDING THEIR LICENSORS AND SUPPLIERS) DISCLAIM ANY WARRANTIES, EXPRESS OR IMPLIED, OF QUALITY, PERFORMANCE, MERCHANTABILITY, FITNESS FOR A PARTICULAR PURPOSE, OWNERSHIP OR NON-INFRINGEMENT. Certain warranty exclusions may not be permitted under applicable law, so to that extent the above exclusion may not apply to you.

Limited Liability:

TO THE EXTENT PERMITTED BY APPLICABLE LAW, NAV2 AND ITS LICENSORS (INCLUDING THEIR LICENSORS AND SUPPLIERS) SHALL NOT BE LIABLE TO YOU: IN RESPECT OF ANY CLAIM, DEMAND OR ACTION, IRRESPECTIVE OF THE NATURE OF THE CAUSE OF THE CLAIM, DEMAND OR ACTION ALLEGING ANY LOSS, INJURY OR DAMAGES, DIRECT OR INDIRECT, WHICH MAY RESULT FROM THE USE OR POSSESSION OF THE INFORMATION; OR

FOR ANY LOSS OF PROFIT, REVENUE, CONTRACTS OR SAVINGS, OR ANY OTHER DIRECT, INDIRECT, INCIDENTAL, SPECIAL OR CONSEQUENTIAL DAMAGES ARISING OUT OF YOUR USE OF OR INABILITY TO USE THIS INFORMATION, ANY DEFECT IN THE INFORMATION, OR THE BREACH OF THESE TERMS OR CONDITIONS, WHETHER IN AN ACTION IN CONTRACT OR TORT OR BASED ON A WARRANTY, EVEN IF NAV2 OR ITS LICENSORS HAVE BEEN ADVISED OF THE POSSIBILITY OF SUCH DAMAGES. UNDER NO CIRCUMSTANCES SHALL NAV2'S OR ITS SUPPLIERS' LIABILITY HEREUNDER EXCEED THE PRICE PAID. Certain liability exclusions may not be permitted under applicable law, so to that extent the above exclusion may not apply to you.

Export Control

You agree not to export to anywhere any part of the Data provided to you or any direct product thereof except in compliance with, and with all licenses and approvals required under, applicable export laws, rules and regulations.

IP Protection

The Data are owned by NAV2 or its suppliers and are protected by applicable copyright and other intellectual property law and treaties. The Data are provided solely on the basis of a license to use, not sale.

Entire Agreement

These terms and conditions constitute the entire agreement between NAV2 (and its licensors, including their licensors and suppliers) and you pertaining to the subject matter hereof, and supersedes in their entirety any and all written or oral agreements previously existing between us with respect to such subject matter.

Appendices

Governing Law.

The above terms and conditions shall be governed by the laws of the People's Republic of China, without giving effect to (i) its conflict of laws provisions, or (ii) the United Nations Convention for Contracts for the International Sale of Goods, which is explicitly excluded. Any dispute arising from or in connection with the Data provided to you hereunder shall be submitted to the Shanghai International Economic and Trade Arbitration Commission for arbitration.

Gracenote® Copyright

CD and music-related data from Gracenote, Inc., copyright©

2000-2007 Gracenote. Gracenote Software, copyright © 2000-2007 Gracenote. This product and service may practice one or more of the following U.S. Patents 5,987,525; 6,061,680; 6,154,773; 6,161,132; 6,230,192; 6,230,207; 6,240,459; 6,330,593 and other patents issued or pending. Some services supplied under license from Open Globe, Inc. for U.S. Patent 6,304,523.

Gracenote and CDDB are registered trademarks of Gracenote. The Gracenote logo and logotype, and the "Powered by Gracenote™" logo are trademarks of Gracenote.

Gracenote® End User License Agreement (EULA)

This device contains software from Gracenote, Inc. of 2000 Powell Street Emeryville, California 94608 ("Gracenote").

The software from Gracenote (the "Gracenote Software") enables this device to do disc and music file identification and obtain music-related information, including name, artist, track, and title information ("Gracenote Data") from online servers

("Gracenote Servers"), and to perform other functions. You may use Gracenote Data only by means of the intended End User functions of this device. This device may contain content belonging to Gracenote's providers. If so, all of the restrictions set forth herein with respect to Gracenote Data shall also apply to such content and such content providers shall be entitled to all of the benefits and protections set forth herein that are available to Gracenote. You agree that you will use the content from Gracenote ("Gracenote Content"), Gracenote Data, the Gracenote Software, and Gracenote Servers for your own personal, non-commercial use only. You agree not to assign, copy, transfer or transmit the Gracenote Content, Gracenote Software or any Gracenote Data (except in a Tag associated with a music file) to any third party. YOU AGREE NOT TO USE OR EXPLOIT GRACENOTE CONTENT, GRACENOTE DATA, THE GRACENOTE SOFTWARE, OR GRACENOTE SERVERS, EXCEPT AS EXPRESSLY PERMITTED HEREIN.

You agree that your non-exclusive licenses to use the Gracenote Content, Gracenote Data, the Gracenote Software, and Gracenote Servers will terminate if you violate these restrictions. If your licenses terminate, you agree to cease any and all use of the Gracenote Content, Gracenote Data, the Gracenote Software, and Gracenote Servers.

Gracenote, respectively, reserve all rights in Gracenote Data, the Gracenote Software, and the Gracenote Servers and Gracenote Content, including all ownership rights. Under no circumstances will either Gracenote become liable for any payment to you for any information that you provide,

Appendices

including any copyrighted material or music file information. You agree that Gracenote may enforce its respective rights, collectively or separately, under this agreement against you, directly in each company's own name.

Gracenote uses a unique identifier to track queries for statistical purposes. The purpose of a randomly assigned numeric identifier is to allow Gracenote to count queries without knowing anything about who you are. For more information, see the web page at www.gracenote.com for the Gracenote Privacy Policy.

THE GRACENOTE SOFTWARE, EACH ITEM OF GRACENOTE DATA AND THE GRACENOTE CONTENT ARE LICENSED TO YOU "AS IS". NEITHER GRACENOTE MAKES ANY REPRESENTATIONS OR WARRANTIES, EXPRESS OR IMPLIED, REGARDING THE ACCURACY OF ANY GRACENOTE DATA FROM THE GRACENOTE SERVERS OR GRACENOTE CONTENT. GRACENOTE COLLECTIVELY AND SEPARATELY RESERVE THE RIGHT TO DELETE DATA AND/OR CONTENT FROM THE COMPANIES' RESPECTIVE SERVERS OR, IN THE CASE OF GRACENOTE, CHANGE DATA CATEGORIES FOR ANY CAUSE THAT GRACENOTE DEEMS SUFFICIENT. NO WARRANTY IS MADE THAT EITHER GRACENOTE CONTENT OR THE GRACENOTE SOFTWARE OR GRACENOTE SERVERS ARE ERROR-FREE OR THAT THE FUNCTIONING OF THE GRACENOTE SOFTWARE OR GRACENOTE SERVERS WILL BE UNINTERRUPTED. GRACENOTE IS NOT OBLIGATED TO PROVIDE YOU WITH ANY ENHANCED OR ADDITIONAL DATA TYPES THAT GRACENOTE MAY CHOOSE TO PROVIDE IN THE FUTURE AND IS FREE TO DISCONTINUE ITS ONLINE SERVICES AT ANY TIME. GRACENOTE DISCLAIM ALL WARRANTIES EXPRESS OR IMPLIED, INCLUDING, BUT NOT LIMITED TO,

IMPLIED WARRANTIES OF MERCHANTABILITY, FITNESS FOR A PARTICULAR PURPOSE, TITLE, AND NON-INFRINGEMENT. NEITHER GRACENOTE WARRANTS THE RESULTS THAT WILL BE OBTAINED BY YOUR USE OF THE GRACENOTE SOFTWARE OR ANY GRACENOTE SERVER. IN NO CASE WILL GRACENOTE BE LIABLE FOR ANY CONSEQUENTIAL OR INCIDENTAL DAMAGES OR FOR ANY LOST PROFITS OR LOST REVENUES FOR ANY REASON WHATSOEVER. © Gracenote 2007.

Radio Frequency Statement

FCC ID: ACJ-SYNCG3-L

IC: 216B-SYNCG3-L

This device complies with Part 15 of the FCC Rules and with RSS-210 of Industry Canada. Operation is subject to the following two conditions:

- (1)** This device may not cause harmful interference, and
- (2)** this device must accept any interference received, including interference that may cause undesired operation.



WARNING: Changes or modifications not expressly approved by the party responsible for compliance could void the user's authority to operate the equipment. The term "IC:" before the radio certification number only signifies that Industry Canada technical specifications were met.

The antenna used for this transmitter must not be co-located or operating in conjunction with any other antenna or transmitter.

Appendices

Taiwan Territory

Note: In accordance with the management approach of low-power radio wave radiation motors:

Article 12: For approved and certified low-power radiation motor models, companies, firms or users must not alter the frequency, increase the power or change the characteristics and functions of the original design without authorization.

Article 14: The usage of low-power radio-frequency motors must not affect aviation safety and interfere with legal telecommunications. Should interference be detected, immediately stop using the device and only resume usage after ensuring that there is no longer any interference. For the legal telecommunication and wireless telecommunication of the telco, the low-power radio frequency motor must be able to tolerate legal limits of interference from telecommunication, industrial, scientific and radio wave equipment.

SUNA TRAFFIC CHANNEL – TERMS AND CONDITIONS

By activating, using and/or accessing the SUNA Traffic Channel, SUNA Predictive or other content or material provided by Intelematics (together, **SUNA Products and/or Services**), you must accept certain terms and conditions. The following is a brief summary of the terms and conditions that apply to you. To view the full terms and conditions relevant to your use of the SUNA Products and/or Services, please consult:

Website
www.sunatrafic.com.au/termsandconditions/

1. Acceptance

By using SUNA Products and/or Services, you will be deemed to have accepted and agreed to be bound by the terms and conditions fully detailed at:

Website
www.sunatrafic.com.au/termsandconditions/

2. Intellectual Property

SUNA Products and/or Services are for your personal use. You may not record, or retransmit the content, nor use the content in association with any other traffic information or route guidance service or device not approved by Intelematics. You obtain no right of ownership in any Intellectual Property Rights (including copyright) in the data that is used to provide SUNA Products and/or Services.

3. Appropriate Use

SUNA Products and/or Services are intended as an aid to personal motoring and travel planning, and do not provide comprehensive or accurate information on all occasions. On occasions, you may experience additional delay as a result of using SUNA Products and/or Services. You acknowledge that it is not intended, or suitable, for use in applications where time of arrival or driving directions may impact the safety of the public or yourself.

4. Use of SUNA Products and Services while driving

You, and other authorised drivers of the vehicle in which SUNA Products and/or Services are available or installed and active, remain at all times responsible for observing all relevant laws and codes of safe driving. In particular, you agree to only actively operate SUNA Products and/or Services when the Vehicle is at a complete stop and it is safe to do so.

Appendices

5. Service Continuity and Reception of the SUNA Traffic Channel

We will use reasonable endeavours to provide the SUNA Traffic Channel 24 hours a day, 365 days a year. The SUNA Traffic Channel may occasionally be unavailable for technical reasons or for planned maintenance. We will try to perform maintenance at times when congestion is light. We reserve the right to withdraw SUNA Products and/or Services at any time.

Also, we cannot assure the uninterrupted reception of the SUNA Traffic Channel RDS-TMC signal at any particular location.

6. Limitation of Liability

Neither Intelematics (nor its suppliers or the manufacturer of your device (the “**Suppliers**”)) shall be liable to you or to any third party for any damages either direct, indirect, incidental, consequential or otherwise arising out of the use of or inability to use SUNA Products and/or Services even if Intelematics or a Supplier has been advised of the possibility of such damages. You also acknowledge that the neither Intelematics nor any Supplier guarantees nor make any warranties that relate to the availability, accuracy or

completeness of SUNA Products and/or Services, and to the extent which it is lawful to do so, both Intelematics and each Supplier excludes any warranties which might otherwise be implied by any State or Federal legislation in relation to SUNA Products and/or Services.

7. Please Note

Great care has been taken in preparing this manual. Constant product development may mean that some information is not entirely up-to-date. The information in this document is subject to change without notice.

DECLARATION OF CONFORMITY

Your vehicle could have components that transmit and receive radio waves and are therefore subject to government regulation.

These components must accept any interference received, including interference that could cause undesired operation. For certification labels and declarations of conformity, visit www.wirelessconformity.ford.com.

DECLARATION OF CONFORMITY - VEHICLES WITH: SYNC 3

Radio Frequency Statement

SYNC Version	FCC Identification Number	IC Identification Number
3.0	ACJ-SYNCG3-L	216B-SYNCG3-L
3.1	ACJ-FA-170-BCARHS	216B-FA170BCARHS
3.2	ACJ-FG-185-SG32MH	216B-FG185SG32MH

Appendices



WARNING: Changes or modifications not expressly approved by the party responsible for compliance could void the user's authority to operate the equipment. The term "IC:" before the radio certification number only signifies that Industry Canada technical specifications were met.

These devices comply with Part 15 of the FCC Rules and with RSS-210 of Industry Canada. Operation is subject to the following two conditions:

1. The device does not cause harmful interference.
2. The device accepts any interference received, including interference that could cause undesired operation.

Index

3

360 Degree Camera.....	237
Advanced Camera Views.....	237
Auxiliary Camera.....	239
Bed View Camera.....	239
Camera Views.....	237
Front Camera.....	238
Keep Out Zone.....	238
Side Camera.....	239

4

4WD	
See: Four-Wheel Drive.....	212

A

A/C	
See: Climate Control.....	142
About This Manual.....	9
ABS	
See: Brakes.....	222
ABS driving hints	
See: Hints on Driving With Anti-Lock Brakes.....	224
Accessories.....	550
Accessories	
See: Replacement Parts Recommendation.....	16
ACC	
See: Using Adaptive Cruise Control.....	242
Adjustable Pedals.....	86
Adjusting the Headlamps.....	375
Horizontal Aim Adjustment.....	376
Vertical Aim Adjustment.....	375
Adjusting the Pedals.....	86
Adjusting the Steering Wheel - Vehicles With: Manual Adjustable Steering Column.....	82
Adjusting the Steering Wheel - Vehicles With: Power Adjustable Steering Column.....	82
End of Travel Position.....	83
Memory Feature.....	83
Airbag Disposal.....	54
Air Conditioning	
See: Climate Control.....	142

Air Filter	
See: Changing the Engine Air Filter - 6.2L.....	351
See: Changing the Engine Air Filter - 6.7L Diesel.....	352
See: Changing the Engine Air Filter - 7.3L.....	354
Alarm	
See: Anti-Theft Alarm.....	78
Ambient Lighting.....	93
Adjusting the Brightness.....	93
Switching Ambient Lighting Off.....	93
Switching Ambient Lighting On.....	93
Anti-Theft Alarm.....	78
Arming the Alarm.....	79
Disarming the Alarm.....	79
Using the System.....	79
Appendices.....	585
Apps.....	532
SiriusXM Traffic and Travel Link.....	534
Using Apps on an Android Device.....	533
Using Apps on an iOS Device.....	533
Using Mobile Navigation on an Android Device.....	533
At a Glance.....	20
Audible Warnings and Indicators.....	111
Headlamps On Warning Chime.....	111
Key in Ignition Warning Chime.....	111
Keyless Warning Alert.....	111
Parking Brake On Warning Chime.....	111
Audio Control.....	84
You can operate the following functions with the control:.....	84
Audio System.....	478
General Information.....	478
Audio Unit - Vehicles With: AM/FM/ Touchscreen Display/SYNC 3.....	478
Adjusting the Volume.....	479
Changing Radio Stations.....	479
Selecting the Audio Modes.....	479
Setting a Memory Preset.....	479
Switching the Audio Unit On and Off.....	479
Using Seek, Fast Forward and Reverse.....	479
Audio Unit - Vehicles With: SYNC.....	480
Accessing the Apps Menu.....	480
Accessing the Clock Settings.....	480
Accessing the Media Source Menu.....	480

Index

Accessing the Phone Features.....	480
Accessing the Settings Menu.....	480
Accessing the Sound Settings.....	480
Adjusting the Volume.....	481
Changing Radio Stations.....	481
Listening to the Radio.....	481
Playing or Pausing Media.....	481
Switching Radio Text On and Off.....	481
Switching Repeat Mode On and Off.....	481
Switching Shuffle Mode On and Off.....	481
Switching the Audio Unit On and Off.....	481
Switching the Display On and Off.....	481
Using Seek, Fast Forward and Reverse.....	482
Using the Display Control.....	482
Using the Number Block.....	482
Autolamps.....	90
Windshield Wiper Activated Headlamps.....	90
Automatic Climate Control.....	143
Directing the Airflow.....	143
Setting the Blower Motor Speed.....	144
Setting the Temperature.....	144
Switching Auto Mode On and Off.....	144
Switching Dual Zone Mode On and Off.....	144
Switching Maximum Air Conditioning On and Off.....	144
Switching Maximum Defrost On and Off.....	144
Switching Recirculated Air On and Off.....	145
Switching the Air Conditioning On and Off.....	144
Switching the Climate Control On and Off.....	144
Automatic High Beam Control.....	95
Automatic High Beam Control Indicators.....	95
Automatic Transmission.....	207
Brake-Shift Interlock.....	209
For F350, F450, F550 and F600 Chassis Cab Vehicles.....	209
If Your Vehicle Gets Stuck in Mud or Snow.....	211
Understanding the Shift Positions of Your Automatic Transmission.....	207
Understanding Your SelectShift Automatic™ Transmission.....	208
Automatic Transmission Fluid Check.....	370
Autowipers.....	87
Auxiliary Power Points.....	167
400 Watt AC Power Point.....	167
DC Power Point.....	167
Locations.....	168
Auxiliary Switches.....	551
Upfitter Interface Module.....	554
B	
Battery	
See: Changing the 12V Battery.....	373
Bed Extender.....	73
Grocery mode.....	75
Tailgate mode.....	74
Bed Ramps.....	274
Installing the Ramp Holder.....	276
Stowing the Bed Ramp.....	276
Using the Bed Ramp.....	275
Blind Spot Information System.....	253
Blind Spot Information System with Trailer Tow.....	255
Switching the System Off and On.....	257
System Errors.....	257
Using the System.....	254
BLIS	
See: Blind Spot Information System.....	253
Bonnet Lock	
See: Opening and Closing the Hood.....	342
Booster Seats.....	33
Types of Booster Seats.....	34
Brake Fluid Check.....	371
Brake Fluid Service Interval.....	372
Brakes.....	222
General Information.....	222
Breaking-In.....	315
Bulb Specification Chart.....	471
C	
Canceling the Set Speed.....	230
Capacities and Specifications - 6.2L.....	441
Air Conditioning System.....	441

Index

Alternative Engine Oil for Extremely Cold Climates.....	444	Front Axle.....	448
Automatic Transmission-Six Speed.....	442	Fuel Tank.....	445
Automatic Transmission-Ten Speed.....	442	Grease.....	445
Engine Coolant.....	443	Hydraulic Brake System.....	446
Engine Oil.....	443	Locks.....	447
Front Axle.....	448	Power Steering System.....	446
Fuel Tank.....	445	Rear Axle - 10.5.....	448
Grease.....	445	Rear Axle - 11.8.....	449
Hydraulic Brake System.....	446	Transfer Case.....	447
Locks.....	447	Washer Reservoir.....	449
Power Steering System.....	446	Capacities and Specifications - 6.7L	
Rear Axle - 10.5.....	448	Diesel.....	450
Rear Axle - 11.8.....	449	Air Conditioning System.....	450
Transfer Case.....	447	Alternative Engine Oil for Biodiesel Fuel Blends (B20 max).....	454
Washer Reservoir.....	449	Alternative Engine Oil for Extremely Cold Climates.....	454
Capacities and Specifications - 6.7L		Alternative Engine Oil for Severe Duty Service.....	455
Diesel.....	450	Automatic Transmission.....	451
Air Conditioning System.....	450	Diesel Exhaust Fluid (DEF) Tank.....	456
Alternative Engine Oil for Biodiesel Fuel Blends (B20 max).....	454	Engine Coolant.....	452
Alternative Engine Oil for Extremely Cold Climates.....	454	Engine Oil.....	452
Alternative Engine Oil for Severe Duty Service.....	455	Front Axle.....	459
Automatic Transmission.....	451	Fuel Tank.....	455
Diesel Exhaust Fluid (DEF) Tank.....	456	Grease.....	456
Engine Coolant.....	452	Hydraulic Brake System.....	457
Engine Oil.....	452	Locks.....	458
Front Axle.....	459	Power Steering System.....	457
Fuel Tank.....	455	Rear Axle - 10.5.....	459
Grease.....	456	Rear Axle - 10.8.....	460
Hydraulic Brake System.....	457	Rear Axle - 11.8.....	460
Locks.....	458	Transfer Case.....	458
Power Steering System.....	457	Washer Reservoir.....	461
Rear Axle - 10.5.....	459	Capacities and Specifications -	
Rear Axle - 10.8.....	460	7.3L.....	461
Rear Axle - 11.8.....	460	Air Conditioning System.....	462
Transfer Case.....	458	Alternative Engine Oil for Extremely Cold Climates.....	464
Washer Reservoir.....	461	Automatic Transmission.....	462
Capacities and Specifications -		Engine Coolant.....	463
7.3L.....	461	Engine Oil.....	463
Air Conditioning System.....	462	Front Axle.....	468
Alternative Engine Oil for Extremely Cold Climates.....	464	Fuel Tank.....	465
Automatic Transmission.....	462	Grease.....	465
Engine Coolant.....	463	Hydraulic Brake System.....	466
Engine Oil.....	463	Locks.....	467
Front Axle.....	468	Power Steering System.....	466
Fuel Tank.....	465	Rear Axle - 10.5.....	468
Grease.....	465	Rear Axle - 10.8.....	469
Hydraulic Brake System.....	466	Rear Axle - 11.8 (With HD Tow Option).....	469
Locks.....	467	Rear Axle - 11.8 (Without HD Tow Option).....	470
Power Steering System.....	466	Transfer Case.....	467
Rear Axle - 10.5.....	468	Washer Reservoir.....	471
Rear Axle - 10.8.....	469	Capacities and Specifications.....	433
Rear Axle - 11.8 (With HD Tow Option).....	469	Cargo Lamps.....	93
Rear Axle - 11.8 (Without HD Tow Option).....	470	Car Wash	
Transfer Case.....	467	See: Cleaning the Exterior.....	385
Washer Reservoir.....	471	Catalytic Converter.....	195
Capacities and Specifications.....	433	On-Board Diagnostics (OBD-II).....	196
Cargo Lamps.....	93	Readiness for Inspection and Maintenance (I/M) Testing.....	197
Car Wash		Center Console.....	171
See: Cleaning the Exterior.....	385	Changing a Bulb.....	377
Catalytic Converter.....	195	Cargo Lamp and Central High Mounted Brake Lamp Bulbs.....	379
On-Board Diagnostics (OBD-II).....	196	Fog Lamp Bulbs.....	378
Readiness for Inspection and Maintenance (I/M) Testing.....	197	Front Park and Direction Indicator Lamp Bulbs.....	377
Center Console.....	171	Headlamp Bulbs.....	377
Changing a Bulb.....	377	LED Lamps.....	380
Cargo Lamp and Central High Mounted Brake Lamp Bulbs.....	379	License Plate Lamp Bulb.....	380
Fog Lamp Bulbs.....	378	Rear Lamps, Brake Lamps, Rear Direction Indicator and Reversing Lamp Bulbs.....	378
Front Park and Direction Indicator Lamp Bulbs.....	377	Changing a Fuse.....	340
Headlamp Bulbs.....	377	Fuses.....	340
LED Lamps.....	380	Changing a Road Wheel.....	422
License Plate Lamp Bulb.....	380	Dissimilar Spare Wheel and Tire Assembly Information.....	422
Rear Lamps, Brake Lamps, Rear Direction Indicator and Reversing Lamp Bulbs.....	378	Location of the Spare Tire and Tools.....	423
Changing a Fuse.....	340	Stowing the Flat Tire or Spare Tire.....	430
Fuses.....	340	Tire Change Procedure.....	423
Changing a Road Wheel.....	422	Changing the 12V Battery.....	373
Dissimilar Spare Wheel and Tire Assembly Information.....	422	Battery Management System.....	374
Location of the Spare Tire and Tools.....	423	Changing the Engine Air Filter -	
Stowing the Flat Tire or Spare Tire.....	430	6.2L.....	351
Tire Change Procedure.....	423		
Changing the 12V Battery.....	373		
Battery Management System.....	374		
Changing the Engine Air Filter -			
6.2L.....	351		

Index

Changing the Engine Air Filter - 6.7L Diesel.....	352
Air Filter Restriction Gauge.....	353
Changing the Engine Air Filter - 7.3L.....	354
Changing the Engine-Mounted and Diesel Fuel Conditioner Module Fuel Filters - 6.7L Diesel.....	380
Diesel Fuel Conditioner Module Filter.....	380
Engine-mounted Fuel Filter.....	383
Changing the Engine Oil and Oil Filter.....	350
Engine lubrication for severe service operation.....	350
Changing the Vehicle Wi-Fi Hotspot Name or Password.....	477
Changing the Wiper Blades.....	376
Checking MyKey System Status.....	64
MyKey Distance.....	64
Number of Admin Keys.....	64
Number of MyKeys.....	64
Checking the Wiper Blades.....	376
Child Restraint and Seatbelt Maintenance.....	44
Child Restraint Positioning.....	35
Child Safety.....	22
General Information.....	22
Child Safety Locks.....	37
Left-Hand Side.....	37
Right-Hand Side.....	37
Cleaning Leather Seats.....	390
With King Ranch Edition.....	391
Without King Ranch Edition.....	390
Cleaning Products.....	385
Materials.....	385
Cleaning the Engine.....	387
Cleaning the Exhaust - 6.7L Diesel.....	387
Cleaning the Exterior.....	385
Cleaning the Headlamps.....	386
Exterior Chrome Parts.....	386
Exterior Plastic Parts.....	386
Stripes or Graphics.....	386
Underbody.....	386
Under Hood.....	386
Cleaning the Instrument Panel and Instrument Cluster Lens.....	390
Cleaning the Interior.....	388
Cleaning the Wheels.....	392
Cleaning the Windows and Wiper Blades.....	388
Clearing All MyKeys.....	64
Climate.....	523
Accessing Rear Climate Controls.....	525
Accessing the Climate Control Menu.....	523
Directing the Airflow.....	523
Rear Climate Control Lock Indicator.....	525
Setting the Blower Motor Speed.....	523
Setting the Temperature.....	523
Switching Auto Mode On and Off.....	523
Switching Dual Zone Mode On and Off.....	524
Switching Maximum Air Conditioning On and Off.....	524
Switching Maximum Defrost On and Off.....	524
Switching Rear Auto Mode On and Off.....	525
Switching Recirculated Air On and Off.....	525
Switching the Air Conditioning On and Off.....	523
Switching the Climate Controlled Seats On and Off.....	524
Switching the Climate Control On and Off.....	524
Switching the Heated Exterior Mirrors On and Off.....	524
Switching the Heated Rear Window On and Off.....	524
Switching the Heated Seats On and Off.....	524
Switching the Heated Steering Wheel On and Off.....	524
Switching the Heated Windshield On and Off.....	524
Switching the Rear Climate Controlled Seats On and Off.....	525
Switching the Rear Heated Seats On and Off.....	525
Switching the Rear Ventilated Seats On and Off.....	525
Switching the Ventilated Seats On and Off.....	525
Climate Control.....	142

Index

Connecting the Vehicle to a Mobile Network.....	474
Enabling the Modem Using FordPass.....	474
Enabling the Modem Using the Touchscreen.....	474
What Is the Modem.....	474
Coolant Check	
See: Engine Coolant Check - 6.2L.....	358
See: Engine Coolant Check - 6.7L Diesel.....	362
See: Engine Coolant Check - 7.3L.....	365
Crash Sensors and Airbag Indicator.....	53
Creating a MyKey.....	63
Programming or Changing Configurable Settings.....	63
Creating a Vehicle Wi-Fi Hotspot.....	477
Connecting a Device to the Wi-Fi Hotspot.....	477
Finding the Wi-Fi Hotspot Name and Password.....	477
Cross Traffic Alert.....	258
Cross Traffic Alert Behavior When Trailer is Attached.....	260
Cross Traffic Alert Indicator.....	260
Cross Traffic Alert Information Messages.....	260
Cross Traffic Alert System Limitations.....	259
Cross Traffic Alert System Sensors.....	259
Switching the System On and Off.....	260
Using Cross Traffic Alert.....	258
Cruise Control.....	241
Cruise Control Indicators.....	242
Cruise Control - Vehicles With: Adaptive Cruise Control.....	85
Cruise Control - Vehicles With: Cruise Control.....	84
Customer Assistance.....	327
D	
Data Recording.....	12
Comfort, Convenience and Entertainment Data.....	14
Event Data.....	13
Service Data.....	13
Services That Third Parties Provide.....	14
Services That We Provide.....	14
Vehicles With a Modem.....	14
Vehicles With an Emergency Call System.....	15
Vehicles With SYNC.....	15
Daytime Running Lamps - Vehicles With: Configurable Daytime Running Lamps.....	90
Daytime Running Lamps - Vehicles With: Daytime Running Lamps (DRL).....	91
Declaration of Conformity.....	613
Declaration of Conformity - Vehicles With: SYNC 3.....	613
Radio Frequency Statement.....	613
Diesel Particulate Filter.....	202
Oxidation Catalytic Converter and Diesel Particulate Filter System.....	202
Regeneration.....	202
Digital Radio.....	482
HD Radio Reception and Station Troubleshooting.....	483
Direction Indicators.....	92
Doors and Locks.....	66
Draining the Fuel Filter Water Trap - 6.7L Diesel.....	355
Draining the Diesel Fuel Conditioner Module.....	356
Filter Location.....	356
Drive Control.....	267
Selectable Drive Modes.....	267
Driver Alert.....	249
Using Driver Alert.....	249
Driver and Passenger Airbags.....	46
Children and Airbags.....	51
Passenger Airbag On and Off Switch.....	46
Proper Driver and Front Passenger Seating Adjustment.....	50
Driving Aids.....	249
Driving Hints.....	312
Driving Through Water.....	315
For Vehicles without Tremor Off-Road Package.....	315
For Vehicles with Tremor Off-Road Package.....	316

Index

DRL	
See: Daytime Running Lamps - Vehicles With: Configurable Daytime Running Lamps.....	90
See: Daytime Running Lamps - Vehicles With: Daytime Running Lamps (DRL).....	91
E	
Economical Driving.....	312
Electromagnetic Compatibility.....	585
Electronic Locking Differential.....	220
Activating the Electronic Locking Differential.....	220
Operating ELD With a Spare or Mismatched Tires.....	221
Electronic Tailgate.....	71
With the Outside Control Button.....	71
With the Remote Control.....	71
Emission Law.....	194
Noise Emissions Warranty, Prohibited Tampering Acts and Maintenance.....	195
Tampering With a Noise Control System.....	194
End User License Agreement.....	588
VEHICLE SOFTWARE END USER LICENSE AGREEMENT (EULA)	588
Engine Block Heater.....	182
Using the Engine Block Heater.....	183
Engine Coolant Check - 6.2L.....	358
Adding Coolant.....	358
Engine Coolant Temperature Management.....	361
Fail-Safe Cooling.....	360
Recycled Coolant.....	359
Severe Climates.....	359
Engine Coolant Check - 6.7L Diesel.....	362
Adding Coolant.....	362
Coolant Change.....	365
Engine and Secondary Cooling System Refill Procedure.....	364
Engine-driven Cooling Fan.....	365
Recycled Coolant.....	364
Severe Climates.....	365
Engine Coolant Check - 7.3L.....	365
Adding Coolant.....	366
Coolant Change.....	368
Engine Coolant Temperature Management.....	369
Engine-driven Cooling Fan (Fan Clutch).....	368
Fail-Safe Cooling.....	368
Recycled Coolant.....	367
Severe Climates.....	368
Engine Emission Control.....	194
Engine Idle Shutdown.....	182
Engine Immobilizer	
See: Passive Anti-Theft System.....	76
Engine Oil Check - 6.2L.....	346
Adding Engine Oil.....	347
Engine Oil Check - 6.7L Diesel.....	347
Adding Engine Oil.....	348
Engine lubrication for severe service operation	348
Engine Oil Check - 7.3L.....	348
Adding Engine Oil.....	349
Engine Oil Dipstick - 6.2L.....	346
Engine Oil Dipstick - 6.7L Diesel.....	346
Engine Oil Dipstick - 7.3L.....	346
Engine Specifications - 6.2L.....	433
Drivebelt Routing.....	433
Engine Specifications - 6.7L Diesel.....	433
Drivebelt Routing.....	434
Engine Specifications - 7.3L.....	434
Drivebelt Routing.....	435
Entertainment.....	513
AM/FM Radio.....	514
Apps.....	522
Bluetooth Stereo or USB.....	521
CD (If equipped).....	520
HD Radio™ Information (If Available).....	517
SiriusXM® Satellite Radio (If Activated).....	515
Sources.....	514
Supported Media Players, Formats and Metadata Information.....	522
USB Ports.....	522
Environment.....	19
Essential Towing Checks.....	300
Before Towing a Trailer.....	308
Dynamic Hitching Using the Rear View Camera System.....	301
Hitches.....	302
Integrated Trailer Brake Controller.....	305

Index

Launching or Retrieving a Boat or Personal Watercraft (PWC).....	309
Safety Chains.....	304
Trailer Brakes.....	304
Trailer Lamps.....	308
Trailer Towing Connector.....	300
When Towing a Trailer.....	308
Event Data Recording	
See: Data Recording.....	12
Export Unique Options.....	18
Exterior Mirrors.....	98
Blind Spot Information System.....	101
Clearance Lamps.....	100
Direction Indicator Mirrors.....	100
Fold-Away Exterior Mirrors.....	98
Heated Exterior Mirrors.....	100
Memory Mirrors.....	100
Power Exterior Mirrors.....	98
PowerScope™ Power Telescoping Mirrors.....	99
Puddle Lamps.....	100
Spot Lamps.....	100
Telescoping Mirrors.....	99
Trailer Towing Camera System.....	100
F	
Fastening the Seatbelts.....	39
Fastening the Cinch Tongue.....	40
Seatbelt Locking Modes.....	41
Using Seatbelts During Pregnancy.....	40
Using the Seatbelt with Cinch Tongue (Front Center Seat on Super Cab and Crew Cab).....	39
Fire Extinguisher.....	321
Flat Tire	
See: Changing a Road Wheel.....	422
Floor Mats.....	318
Fog Lamps - Front	
See: Front Fog Lamps.....	91
Foot Pedals	
See: Adjusting the Pedals.....	86
Ford Credit.....	16
US Only.....	16
Ford Protect.....	555
Ford Protect Extended Service Plan (CANADA ONLY).....	556
Ford Protect Extended Service Plans (U.S. Only).....	555
Four-Wheel Drive.....	212
Front Fog Lamps.....	91
Front Fog Lamp Indicator.....	91
Switching the Front Fog Lamps On or Off.....	91
Fuel and Refueling.....	184
Fuel Consumption.....	193
Advertised Capacity.....	193
Fuel Economy.....	193
Fuel Filter - 6.2L.....	376
Fuel Quality - Diesel.....	187
Biodiesel.....	188
Diesel Fuel Additives.....	189
Fuel Requirements - Choosing The Right Fuel: Vehicles Operated Where Ultra Low Sulfur Diesel Fuel Is Not Required.....	187
Fuel Requirements - Choosing The Right Fuel: Vehicles Operated Where Ultra Low Sulfur Diesel Fuel Is Required (United States/Canada/Puerto Rico/U.S. Virgin Islands And Other Locales).....	187
Fuel Quality - E85.....	185
Choosing the Right Fuel - Flex Fuel Vehicles.....	185
Switching Between E85 and Gasoline.....	186
Fuel Quality - Gasoline.....	186
Choosing the Right Fuel.....	186
Fuel Shutoff.....	321
Fuses.....	334
Fuse Specification Chart.....	334
Engine Compartment Fuse Box.....	334
Passenger Compartment Fuse Panel.....	338
G	
Garage Door Opener.....	163
Garage Door Opener	
See: Universal Garage Door Opener.....	163
Gauges.....	104
DEF Gauge.....	106
Engine Coolant Temperature Gauge.....	106
Engine Oil Pressure Gauge.....	106
Fuel Gauge.....	106

Index

- Transmission Fluid Temperature
 - Gauge.....106
 - Turbo Boost Gauge.....106
 - Type 1 and 2.....104
 - Type 3.....105
- Gearbox
 - See: Transmission.....207
- General Information on Radio
 - Frequencies.....55
 - Intelligent Access.....55
- General Maintenance Information.....557
 - Multi-Point Inspection.....560
 - Owner Checks and Services.....558
 - Protecting Your Investment.....557
 - Why Maintain Your Vehicle?.....557
 - Why Maintain Your Vehicle at Your Dealership?.....557
- Getting Assistance Outside the U.S. and Canada.....330
- Getting the Services You Need.....327
 - Away From Home.....327
- Global Opening.....98
 - Opening the Windows.....98
- H**
- Handbrake
 - See: Parking Brake.....224
- Hazard Flashers.....321
- HDC
 - See: Using Hill Descent Control.....231
- Headlamp Adjusting
 - See: Adjusting the Headlamps.....375
- Headrest
 - See: Head Restraints.....150
- Head Restraints.....150
 - Adjusting the Head Restraint.....151
- Heated Exterior Mirrors.....147
- Heated Rear Window.....147
- Heated Seats.....159
 - Rear Heated Seats.....159
- Heated Steering Wheel.....85
- Heated Windshield.....147
 - Windshield Wiper De-Icer.....147
- Heating
 - See: Climate Control.....142
- Hill Start Assist.....224
 - Switching the System On and Off.....225
 - Using Hill Start Assist.....225
- Hints on Controlling the Interior Climate - Vehicles With: Automatic Temperature Control.....145
 - Defogging the Side Windows in Cold Weather.....146
 - General Hints.....145
 - Quickly Cooling the Interior.....146
 - Quickly Heating the Interior.....145
 - Recommended Settings for Cooling.....146
 - Recommended Settings for Heating.....146
- Hints on Controlling the Interior Climate - Vehicles With: Manual Temperature Control.....146
 - Defogging the Side Windows in Cold Weather.....147
 - General Hints.....146
 - Quickly Cooling the Interior.....146
 - Quickly Heating the Interior.....146
 - Recommended Settings for Cooling.....146
 - Recommended Settings for Heating.....146
 - Vehicle Stationary for Extended Periods During Extreme High Ambient Temperatures.....147
- Hints on Driving With Anti-Lock Brakes.....224
- Hood Lock
 - See: Opening and Closing the Hood.....342
- Horn.....85
- How Does the Rear Occupant Alert System Work.....161
- I**
- Ignition Switch.....174
- In California (U.S. Only).....328
- Information Display Control.....85
- Information Displays.....112
 - General Information.....112
- Information Messages.....123
 - 4WD.....140
 - Active Park.....123
 - Adaptive Cruise Control.....124
 - Adaptive Steering.....125
 - AdvanceTrac and Traction Control.....125
 - Airbag.....126
 - Alarm and Security.....126
 - Automatic Engine Shutdown.....126

Index

Battery and Charging System.....	127	Instrument Panel.....	20
Blind Spot Information and Cross Traffic Alert System.....	127	Interior Air Quality.....	149
Diesel Messages.....	128	Interior Lamps.....	92
Doors and Locks.....	130	Front Interior Lamp.....	92
Driver Alert.....	131	Rear Interior Lamps.....	93
Drivetrain.....	131	Interior Mirror.....	101
Engine.....	131	Auto-Dimming Mirror.....	101
Fuel.....	132	Manual Dimming Mirror.....	101
Keys and Remote Controls.....	132	Introduction.....	9
Lane Keeping System.....	133	J	
Maintenance.....	133	Jump Starting the Vehicle.....	322
MyKey.....	134	Connecting the Jumper Cables.....	322
Off Road.....	134	Jump Starting.....	323
Park Aid.....	135	Preparing Your Vehicle.....	322
Park Brake.....	135	Removing the Jumper Cables.....	323
Power Steering.....	136	K	
Pre-Collision Assist.....	136	Keyless Entry.....	69
Remote Start.....	137	SECURICODE™ KEYLESS ENTRY KEYPAD.....	69
Seats.....	137	Keyless Starting.....	175
Starting System.....	137	Keys and Remote Controls.....	55
Tailgate.....	137	L	
Tire Pressure Monitoring System.....	138	Lane Keeping System.....	250
Trail Control.....	138	Switching the System On and Off.....	251
Trailer.....	139	System Display.....	251
Installing Child Restraints.....	24	System Settings.....	251
Child Seats.....	24	Troubleshooting.....	252
Combining Seatbelt and LATCH Lower Anchors for Attaching Child Restraints.....	30	Lighting Control.....	89
Front Seat Tether Strap Attachment (Regular Cab).....	31	Flashing the Headlamp High Beam.....	90
Rear Seat Tether Strap Attachment (Crew Cab and Super Cab).....	32	Headlamp High Beam.....	89
Use of Inboard Lower Anchors from the Outboard Seating Positions (Center Seating Use).....	29	Lighting.....	89
Using Lap and Shoulder Belts (Except Front Center Position of Super Cab and Crew Cab).....	24	General Information.....	89
Using Lap and Shoulder Belts (Front Center Position of Super Cab and Crew Cab).....	26	Limited Slip Differential.....	220
Using Lower Anchors and Tethers for Children (LATCH).....	28	Load Carrying.....	270
Using Tether Straps.....	30	Load Limit.....	270
Instrument Cluster.....	104	Special Loading Instructions for Owners of Pick-up Trucks and Utility-type Vehicles.....	274
Instrument Lighting Dimmer.....	90	Vehicle Loading - with and without a Trailer.....	270
		Locating the Cabin Air Filter.....	149

Index

Locking and Unlocking.....	66
Activating Intelligent Access.....	66
Autolock.....	68
Battery Saver.....	68
Illuminated Entry.....	68
Power Door Locks.....	66
Remote Control.....	66
Smart Unlock.....	67
Smart Unlocks for Intelligent Access Keys.....	67
Lug Nuts See: Changing a Road Wheel.....	422

M

Maintenance.....	342
General Information.....	342
Manual Climate Control.....	142
Directing the Airflow.....	142
Setting the Blower Motor Speed.....	142
Setting the Temperature.....	142
Switching Maximum Air Conditioning On and Off.....	143
Switching Maximum Defrost On and Off.....	143
Switching Recirculated Air On and Off.....	143
Switching the Air Conditioning On and Off.....	142
Switching the Climate Control On and Off.....	143
Manual Seats.....	152
Manual Lumbar	153
Moving the Seat Backward and Forward.....	153
Recline Adjustment.....	153
Memory Function.....	156
Easy Entry and Exit Feature.....	157
Linking a PreSet Position to your Remote Control or Intelligent Access Key Fob	156
Recalling a Preset Position.....	156
Saving a Preset Position.....	156
Message Center See: Information Displays.....	112
Mirrors See: Windows and Mirrors.....	97

Mobile Communications Equipment.....	18
Moonroof.....	102
Bounce-Back.....	103
Opening and Closing the Moonroof.....	102
Motorcraft Parts - 6.2L.....	435
Motorcraft Parts - 6.7L Diesel.....	437
Motorcraft Parts - 7.3L.....	438
MyKey – Troubleshooting.....	64
MyKey™.....	62
Principle of Operation.....	62

N

Navigation.....	527
Changing the Format of the Map.....	529
cityseeker.....	531
Michelin Travel Guide.....	532
Navigation Map Accuracy and Updates.....	532
Route Guidance.....	529
Setting a Destination.....	528
SiriusXM Traffic and Travel Link.....	532
Zoom.....	529
Network Connectivity.....	474
Connecting the Vehicle to a Mobile Network.....	474
Network Connectivity – Troubleshooting.....	475
Normal Scheduled Maintenance.....	560
Diesel Engine.....	563
Gasoline Engine.....	562
Intelligent Oil-Life Monitor.....	560

O

Off-Road Driving.....	312
After Off-Road Driving.....	314
Basic Off-road Driving Techniques.....	313
Crossing Obstacles.....	314
Hill Climbing.....	314
Oil Change Indicator Reset.....	350
Oil Check See: Engine Oil Check - 6.2L.....	346
See: Engine Oil Check - 6.7L Diesel.....	347
See: Engine Oil Check - 7.3L.....	348
Opening and Closing the Hood.....	342

Index

Ordering Additional Owner's Literature.....	332
Obtaining a French Owner's Manual.....	332
Overhead Console.....	171
Overriding Automatic High Beam Control.....	95
P	
Parking Aids.....	233
Principle of Operation.....	233
Parking Brake.....	224
Passive Anti-Theft System.....	76
SecuriLock®.....	76
PATS	
See: Passive Anti-Theft System.....	76
Perchlorate.....	16
Phone.....	525
Android Auto.....	527
Apple CarPlay.....	527
Pairing Your Cell Phone for the First Time.....	526
Text Messaging.....	526
Using Your Cell Phone.....	526
Post-Crash Alert System.....	324
Power Door Locks	
See: Locking and Unlocking.....	66
Power Running Boards.....	80
Power Seats.....	153
Adjusting the Lumbar Support.....	154
Adjusting the Multi-Contour Front Seats With Active Motion	154
Power Steering Fluid Check.....	372
Power Take-Off.....	211
Split Shaft Capability.....	211
Power Windows.....	97
Accessory Delay.....	98
Bounce-Back.....	97
One-Touch Up or Down.....	97
Window Lock.....	98
Pre-Collision Assist.....	263
Adjusting the Pre-Collision Assist Settings.....	265
Blocked Sensors.....	266
Distance Indication and Alert.....	264
Using the Pre-Collision Assist System.....	263
Protecting the Environment.....	19
Puncture	
See: Changing a Road Wheel.....	422
R	
Rear Axle.....	220
Rear Occupant Alert System Audible Warnings.....	162
Rear Occupant Alert System Indicators - Vehicles With: SYNC 3.....	162
Rear Occupant Alert System Indicators - Vehicles With: SYNC.....	162
Rear Occupant Alert System Limitations.....	161
Rear Occupant Alert System Precautions.....	161
Rear Occupant Alert System.....	161
Rear Parking Aid.....	233
Obstacle Distance Indicator.....	234
Rear Seats.....	157
Folding Up the Rear Seat Cushion	157
Rear Under Seat Storage.....	158
Returning the Seat to the Seating Position.....	158
Rear View Camera.....	234
Camera Guidelines.....	235
Obstacle Distance Indicator.....	236
Rear Camera Delay.....	236
Using the Rear View Camera System.....	235
Rear View Camera	
See: Rear View Camera.....	234
Recommended Towing Weights.....	295
Calculating the Maximum Loaded Trailer Weight for Your Vehicle.....	299
Refueling - Diesel.....	190
Dual Fuel Tanks.....	192
Fueling Tips.....	191
Refueling.....	191
Refueling - Gasoline.....	189
Fuel Filler Cap.....	190
Remote Control.....	55
Car Finder.....	60
Integrated Keyhead Transmitter.....	55
Intelligent Access Key.....	56
Memory Feature.....	59
Remote Start.....	60
Replacing the Battery.....	57
Sounding the Panic Alarm.....	60

Index

Remote Start.....	147
Automatic Settings.....	148
Removing the Tailgate.....	72
Repairing Minor Paint Damage.....	392
Replacement Parts	
Recommendation.....	16
Collision Repairs.....	16
Scheduled Maintenance and Mechanical Repairs.....	16
Warranty on Replacement Parts.....	16
Replacing a Lost Key or Remote Control.....	61
Replacing the Cabin Air Filter.....	149
Reporting Safety Defects (Canada Only).....	332
Reporting Safety Defects (U.S. Only).....	332
Resuming the Set Speed.....	242
Roadside Assistance.....	320
Vehicles Sold in Canada: Getting Roadside Assistance.....	321
Vehicles Sold in the United States: Getting Roadside Assistance.....	320
Vehicles Sold in the United States: Using Roadside Assistance.....	320
Roadside Emergencies.....	320
Running-In	
See: Breaking-In.....	315
Running Out of Fuel.....	189

S

Safety Canopy™.....	52
Safety Precautions.....	184
Satellite Radio.....	484
Satellite Radio Electronic Serial Number (ESN).....	485
Satellite Radio Reception Factors.....	485
SiriusXM Satellite Radio Service.....	485
Troubleshooting.....	486
Scheduled Maintenance Record.....	575
Scheduled Maintenance.....	557
Seatbelt Extensions.....	44
Seatbelt Height Adjustment.....	42
Seatbelt Reminder.....	43
Belt-Minder™.....	43
Seatbelts.....	38
Principle of Operation.....	38

Seatbelt Warning Lamp and Indicator Chime.....	42
Conditions of operation.....	42
Seats.....	150
Security.....	76
Selective Catalytic Reductant System - Diesel.....	197
Contaminated Diesel Exhaust Fluid or Inoperative Selective Catalytic Reduction System.....	201
Diesel Exhaust Fluid Guidelines and Information.....	200
Diesel Exhaust Fluid Level.....	197
Diesel Exhaust Fluid Warning Messages and Vehicle Operations.....	199
Filling the Diesel Exhaust Fluid Tank.....	198
Settings.....	535
911 Assist.....	535
Ambient Lighting.....	536
Audio.....	535
Automatic Updates.....	535
Bluetooth.....	535
Charge Settings.....	536
Clock.....	535
Display.....	536
Driver Assist.....	535
FordPass.....	535
General.....	535
Message Center.....	536
Mobile Apps.....	535
Multi Contour Seats.....	536
Navigation.....	536
Personal Profiles.....	536
Phone.....	535
Seats.....	536
Sound.....	535
Valet Mode.....	536
Vehicle.....	535
Voice Control.....	536
Setting the Cruise Control Speed.....	241
Changing the Set Speed.....	241
Setting the Trail Control Speed.....	230
Side Airbags.....	51
Sitting in the Correct Position.....	150
Sliding Windows.....	101
Power Sliding Back Window.....	101
Snow Chains	
See: Using Snow Chains.....	413

Index

Snow Plowing.....	316	Failure to Start.....	176
Engine temperature while plowing.....	318	Guarding Against Exhaust Fumes.....	177
Installing the Snowplow.....	316	Important Ventilating Information.....	177
Operating the Vehicle with the Snowplow Attached.....	317	Stopping the Engine When Your Vehicle is Moving.....	176
Snowplowing with your Airbag Equipped Vehicle.....	317	Stopping the Engine When Your Vehicle is Stationary.....	176
Transmission operation while plowing.....	318	Vehicles with an Ignition Key.....	175
Spare Wheel		Vehicles with Keyless Start.....	176
See: Changing a Road Wheel.....	422	Starting and Stopping the Engine.....	174
Special Notices.....	17	General Information.....	174
New Vehicle Limited Warranty.....	17	Steering.....	261
Notice to Owners of Pickup Trucks and Utility Type Vehicles.....	17	Adaptive Learning.....	262
On Board Diagnostics Data Link Connector.....	17	Adaptive Steering.....	262
Special Instructions.....	17	Electronic Torque Overlay Steering.....	261
Using Your Vehicle as an Ambulance.....	18	Hydraulic Power Steering.....	261
Using Your Vehicle With a Snowplow.....	18	Steering Wheel.....	82
Special Operating Conditions Scheduled		Storage Compartments.....	171
Maintenance.....	566	Sunroof	
Diesel Engine.....	569	See: Moonroof.....	102
Exceptions.....	574	Sun Visors.....	102
Gasoline Engine.....	566	Illuminated Vanity Mirror.....	102
Speed Control		Supplementary Restraints System.....	45
See: Cruise Control.....	241	Principle of Operation.....	45
Spot Lamps.....	92	Switching Automatic High Beam Control On and Off.....	95
Spring U-Bolt Check - F-600.....	383	Activating the Automatic High Beam Control.....	95
U-bolt Nut Torque.....	384	Switching Cruise Control On and Off.....	241
Stability Control.....	227	Switching Cruise Control Off.....	241
Principle of Operation.....	227	Switching Cruise Control On.....	241
Starter Switch		Switching Off the Engine - 6.7L Diesel.....	182
See: Ignition Switch.....	174	Switching Rear Occupant Alert System On and Off - Vehicles With: SYNC 3.....	161
Starting a Diesel Engine - 6.7L		Switching Rear Occupant Alert System On and Off - Vehicles With: SYNC.....	161
Diesel.....	177	Switching Trail Control On and Off.....	230
Automatic Engine Shutdown.....	179	Symbols Glossary.....	10
Cold Weather Operation.....	179	SYNC™ 3.....	505
Cold Weather Starting.....	179	General Information.....	505
Diesel Engine Fast Start Glow Plug System.....	178	SYNC™ 3 Troubleshooting.....	537
Vehicles with an Ignition Key.....	178	Additional Information and Assistance.....	549
Vehicles with Keyless Start.....	178	Apps.....	544
Starting a Gasoline Engine - 6.2L/ 7.3L.....	175		
Automatic Engine Shutdown.....	176		
Cold Weather Starting (Flexible Fuel Vehicles Only).....	177		

Index

Navigation.....	543	Towing the Vehicle on Four Wheels.....	309
Personal Profiles.....	547	Emergency Towing.....	309
Phone.....	541	Recreational Towing.....	309
Resetting the System.....	549	Towing.....	277
USB and Bluetooth Audio.....	538	Traction Control.....	226
Voice Recognition.....	537	Principle of Operation.....	226
Wi-Fi Connectivity.....	546	Trail Control Indicators.....	230
SYNC™ Applications and Services.....	492	Trail Control.....	230
911 Assist.....	492	Trailer Reversing Aids.....	279
SYNC Mobile Apps.....	494	Conventional Trailer Setup.....	281
SYNC™.....	488	Fifth Wheel and Gooseneck Trailer Setup.....	283
General Information.....	488	Positioning Your Vehicle and Trailer.....	280
SYNC™ Troubleshooting.....	496	Pro Trailer Backup Assist With Trailer Reverse Guidance.....	279
T		Setting Up the System.....	280
Tailgate Lock.....	71	Troubleshooting - Conventional Trailer.....	287
Tailgate Step.....	72	Troubleshooting - Fifth Wheel and Gooseneck Trailer.....	292
Closing the Step.....	73	Using Pro Trailer Backup Assist.....	284
Opening the Step.....	73	Using Trailer Reverse Guidance.....	285
Tailgate.....	71	Trailer Sway Control.....	295
Technical Specifications		Transfer Case Fluid Check.....	371
See: Capacities and Specifications.....	433	Transmission Code Designation.....	440
Terrain Control.....	231	Transmission.....	207
Principle of Operation.....	231	Transporting the Vehicle.....	324
The Better Business Bureau (BBB) Auto Line Program (U.S. Only).....	329	U	
Tire Care.....	397	Under Hood Overview - 6.2L.....	343
Glossary of Tire Terminology.....	398	Under Hood Overview - 6.7L Diesel.....	344
Information About Uniform Tire Quality Grading.....	397	Under Hood Overview - 7.3L.....	345
Information Contained on the Tire Sidewall.....	399	Under Seat Storage.....	171
Temperature A B C.....	398	Front Under Seat Storage Compartment - Vehicles With Locking Storage.....	172
Traction AA A B C.....	397	Front Under Seat Storage Compartment - Vehicles Without Locking Storage.....	171
Treadwear.....	397	Rear Under Seat Storage.....	172
Tire Pressure Monitoring System.....	414	Universal Garage Door Opener.....	163
Trailer Tire Pressure Monitoring System.....	421	HomeLink Wireless Control System.....	163
Vehicle Tire Pressure Monitoring System.....	414	USB Port.....	487
Tires		Locating the USB Ports.....	487
See: Wheels and Tires.....	395	Using Adaptive Cruise Control.....	242
Towing a Trailer.....	277	Automatic Cancellation.....	245
Load Placement.....	278	Blocked Sensor.....	247
Towing Points.....	325		

Index

Canceling the Set Speed.....	245	Using SYNC™ With Your Phone.....	491
Changing the Set Speed.....	245	Accessing Features through the Phone	
Detection Issues.....	246	Menu.....	492
Following a Vehicle.....	243	Pairing a Phone.....	491
Hilly Condition and Trailer Tow		Phone Controls.....	492
Usage.....	245	Phone Voice Commands.....	491
Overriding the Set Speed.....	245	Using Traction Control.....	226
Resuming the Set Speed.....	245	Switching the System Off.....	226
Setting the Adaptive Cruise Speed.....	243	System Indicator Lights and	
Setting the Gap Distance.....	244	Messages.....	226
Switching Adaptive Cruise Control		Using Voice Recognition.....	489
Off.....	246	Apps.....	512
Switching Adaptive Cruise Control		Automatic Blower Motor Speed	
On.....	243	Reduction.....	513
Switching to Normal Cruise Control.....	248	Climate.....	509
System Not Available.....	247	Entertainment.....	508
Using Four-Wheel Drive.....	212	General.....	507
4WD Indicator Lights.....	212	Initiating a Voice Session.....	489
Driving Off-Road With Truck and Utility		Navigation.....	511
Vehicles.....	215	Phone.....	510
Electronic Shift-On-the-Fly (ESOF) 4WD		SiriusXM Traffic and Travel Link.....	512
system.....	212	System Interaction and Feedback.....	490
Entering and Exiting Rock Crawl Mode with		Voice Settings.....	513
Tremor Package.....	214	Utilizing the Mediation/Arbitration	
How Your Vehicle Differs from Other		Program (Canada Only).....	330
Vehicles.....	215		
Operating 4WD Vehicles with Spare or			
Mismatched Tires.....	214		
Using the Electronic Shift on the Fly 4WD			
system.....	213		
Using Hill Descent Control.....	231		
Hill descent modes.....	231		
Using MyKey With Remote Start			
Systems.....	64		
Using Power Running Boards.....	80		
Automatic Power Deploy.....	80		
Automatic Power Stow.....	80		
Bounce-back.....	81		
Enabling and Disabling.....	81		
Manual Power Deploy.....	80		
Using Snow Chains.....	413		
Using Stability Control.....	228		
AdvanceTrac® with Roll Stability Control™			
(RSC®).....	228		
Using SYNC™ With Your Media			
Player.....	495		
Audio Voice Commands.....	496		
Media Sources.....	495		
Using SYNC™ With Your Phone.....	491		
Accessing Features through the Phone			
Menu.....	492		
Pairing a Phone.....	491		
Phone Controls.....	492		
Phone Voice Commands.....	491		
Using Traction Control.....	226		
Switching the System Off.....	226		
System Indicator Lights and			
Messages.....	226		
Using Voice Recognition.....	489		
Apps.....	512		
Automatic Blower Motor Speed			
Reduction.....	513		
Climate.....	509		
Entertainment.....	508		
General.....	507		
Initiating a Voice Session.....	489		
Navigation.....	511		
Phone.....	510		
SiriusXM Traffic and Travel Link.....	512		
System Interaction and Feedback.....	490		
Voice Settings.....	513		
Utilizing the Mediation/Arbitration			
Program (Canada Only).....	330		

V

Vehicle Care.....	385
General Information.....	385
Vehicle Certification Label.....	440
Vehicle Identification Number.....	439
Vehicle Storage.....	392
Body.....	392
Brakes.....	393
Cooling system.....	393
Disconnecting Your 12 Volt Battery.....	393
Engine.....	393
Fuel system.....	393
General.....	392
Miscellaneous.....	393
Removing Vehicle From Storage.....	393
Tires.....	393
Vehicle Wi-Fi Hotspot.....	477
Ventilated Seats.....	160
Ventilation	
See: Climate Control.....	142

Index

VIN	
See: Vehicle Identification Number.....	439
Voice Control.....	84
W	
Warning Lamps and Indicators.....	107
Adaptive Cruise Control.....	107
Adaptive Steering.....	107
Anti-Lock Braking System.....	107
Automatic High Beam.....	107
Battery.....	108
Blind Spot Monitor.....	108
Brake System Warning Lamp.....	108
Check 4X4.....	108
Check Fuel Cap.....	108
Cruise Control.....	108
Diesel Engine Brake.....	108
Diesel Exhaust Fluid.....	108
Direction Indicator.....	109
Door Ajar.....	109
Electronic Locking Differential.....	109
Engine Coolant Temperature.....	109
Engine Oil.....	109
Fasten Seatbelt.....	109
Four-Wheel Drive Indicators.....	111
Front Airbag.....	109
Front Fog Lamps.....	109
High Beam.....	109
Hill Descent.....	109
Low Fuel Level.....	109
Low Tire Pressure Warning.....	109
Powertrain Malfunction/Reduced Power/Electronic Throttle Control.....	110
Service Engine Soon.....	110
Stability Control.....	110
Stability Control Off.....	110
Tailgate Ajar.....	110
Transmission Tow/Haul.....	110
Wait To Start.....	110
Water In Fuel.....	110
Warning Triangle.....	321
Washer Fluid Check.....	376
Washers	
See: Cleaning the Exterior.....	385
See: Wipers and Washers.....	87
Waxing.....	387
What Is Automatic High Beam Control.....	95
What Is Cruise Control.....	241
What Is the Cabin Air Filter.....	149
What is the Rear Occupant Alert System.....	161
What Is Trail Control.....	230
Wheel Nuts	
See: Changing a Road Wheel.....	422
Wheels and Tires.....	395
General Information.....	395
Technical Specifications.....	431
Windows and Mirrors.....	97
Windshield Washers.....	88
Windshield Wipers.....	87
Speed Dependent Wipers.....	87
Wiper Blades	
See: Checking the Wiper Blades.....	376
Wipers and Washers.....	87
Wireless Accessory Charging.....	168