



# OWNER'S MANUAL.

MINI COUPE.

MINI ROADSTER.

MINI CONVERTIBLE.

## Contents

### A-Z





**COOPER  
COOPER S  
JOHN COOPER  
WORKS**

## **Owner's Manual for Vehicle**

Thank you for choosing a MINI.

The more familiar you are with your vehicle, the better control you will have on the road. We therefore strongly suggest:

Read this Owner's Manual before starting off in your new MINI. It contains important information on vehicle operation that will help you make full use of the technical features available in your MINI. The manual also contains information designed to enhance operating reliability and road safety, and to contribute to maintaining the value of your MINI.

Supplementary information can be found in the additional brochures in the onboard literature.

We wish you a safe and enjoyable drive.

BMW AG

© 2012 Bayerische Motoren Werke  
Aktiengesellschaft  
Munich, Germany  
Reprinting, including excerpts, only with the written  
consent of BMW AG, Munich.  
US English II/13, 03 13 500  
Printed on environmentally friendly paper, bleached  
without chlorine, suitable for recycling.

# CONTENTS

The fastest way to find information on a particular topic or item is by using the index, refer to page 280.

6 Notes

## AT A GLANCE

- 12 Cockpit
- 18 Onboard monitor
- 24 Voice activation system

## CONTROLS

- 30 Opening and closing
- 53 Adjusting
- 59 Transporting children safely
- 64 Driving
- 74 Displays
- 85 Lamps
- 90 Safety
- 101 Driving stability control systems
- 105 Driving comfort
- 108 Climate
- 114 Interior equipment
- 118 Storage compartments

## DRIVING TIPS

- 124 Things to remember when driving
- 128 Loading
- 131 Saving fuel

## NAVIGATION

- 136 Navigation system
- 138 Destination entry
- 147 Destination guidance
- 155 What to do if...

## ENTERTAINMENT

- 158 Tone
- 160 Radio
- 168 CD/multimedia

## COMMUNICATION

- 182 Bluetooth hands-free system
- 192 Bluetooth mobile phone preparation package
- 204 Office
- 212 MINI Connected

## MOBILITY

- 218 Refueling
- 220 Fuel
- 222 Wheels and tires
- 236 Engine compartment
- 238 Engine oil
- 240 Coolant
- 241 Maintenance
- 243 Replacing components
- 254 Breakdown assistance
- 259 Care

## REFERENCE

- 266 Technical data
- 274 Short commands for voice activation system
- 280 Everything from A to Z

# NOTES

## USING THIS OWNER'S MANUAL

The fastest way to find information on a particular topic is by using the index.

An initial overview of the vehicle is provided in the first chapter.

### Additional sources of information

Should you have any questions, your service center will be glad to advise you at any time.

Information on MINI, e.g., on technology, is available on the Internet: [www.mini.com](http://www.mini.com)

## SYMBOLS

 Indicates precautions that must be followed precisely in order to avoid the possibility of personal injury and serious damage to the vehicle.

◀ Marks the end of a specific item of information.

"..." Identifies Control Display texts used to select individual functions.

>...< Verbal instructions to use with the voice activation system.

>>...<< Identifies the answers generated by the voice activation system.

 Refers to measures that can be taken to help protect the environment.

### Symbols on vehicle components

 Indicates that you should consult the relevant section of this Owner's Manual for information on a particular part or assembly.

## VEHICLE EQUIPMENT

The manufacturer of your MINI is the Bayerische Motoren Werke Aktiengesellschaft, BMW AG.

This Owner's Manual describes all models, all series equipment, as well as country-specific and special equipment offered in the model series. Therefore, this Owner's Manual also describes and depicts equipment that may not be contained in your vehicle because of the selected special equipment or country version, for example.

This also applies to safety-related functions and systems.

For options and equipment not described in this Owner's Manual, please refer to the Supplementary Owner's Manuals.

On right-hand drive vehicles, some controls are arranged differently than shown in the illustrations.

## STATUS OF THIS OWNER'S MANUAL AT TIME OF PRINTING

The manufacturer of your vehicle pursues a policy of constant development that is conceived to ensure that our vehicles continue to embody the highest quality and safety standards. In rare cases, therefore, the features described in this Owner's Manual may differ from those in your vehicle.

## FOR YOUR OWN SAFETY

### Maintenance and repairs

Advanced technology, e.g., the use of modern materials and high-performance electronics, requires suitable maintenance and repair methods.

Therefore, have this work performed only by a MINI service center or a workshop that works according to MINI repair procedures with appropriately trained personnel.

If this work is not carried out properly, there is the danger of subsequent damage and related safety hazards.

### Parts and accessories

For your own safety, use genuine parts and accessories approved by the manufacturer of the MINI. When you purchase accessories tested and approved by the manufacturer of the MINI and Original MINI Parts, you simultaneously acquire the assurance that they have been thoroughly tested by the manufacturer of the MINI to ensure optimum performance when installed on your vehicle. The manufacturer of the MINI warrants these parts to be free from defects in material and workmanship. The manufacturer of the MINI will not accept any liability for damage resulting from installation of parts and accessories not approved by the manufacturer of the MINI. The manufacturer of the MINI cannot test every product made by other manufacturers to verify if it can be used on a MINI safely and without risk to either the vehicle, its operation, or its occupants. Original MINI Parts, MINI Accessories and other products approved by the manufacturer of the MINI, together with professional advice on using these items, are available from all MINI Dealers. Installation and operation of non-MINI approved accessories such as alarms, radios, amplifiers, radar detectors, wheels, suspension components, brake dust shields, telephones, including operation of any mobile phone from within the vehicle with-

out using an externally mounted antenna, or transceiver equipment, for instance, CBs, walkie-talkies, ham radios or similar accessories, may cause extensive damage to the vehicle, compromise its safety, interfere with the vehicle's electrical system or affect the validity of the MINI Limited Warranty. See your MINI Dealer for additional information. Maintenance, replacement, or repair of the emission control devices and systems may be performed by any automotive repair establishment or individual using any certified automotive part.

### California Proposition 65 Warning

California laws require us to state the following warning:

Engine exhaust and a wide variety of automobile components and parts, including components found in the interior furnishings in a vehicle, contain or emit chemicals known to the State of California to cause cancer and birth defects and reproductive harm. In addition, certain fluids contained in vehicles and certain products of component wear contain or emit chemicals known to the State of California to cause cancer and birth defects or other reproductive harm. Battery posts, terminals and related accessories contain lead and lead compounds. Wash your hands after handling. Used engine oil contains chemicals that have caused cancer in laboratory animals. Always protect your skin by washing thoroughly with soap and water.

### Service and warranty

We recommend that you read this publication thoroughly. Your vehicle is covered by the following warranties:

- ▷ New Vehicle Limited Warranty.
- ▷ Rust Perforation Limited Warranty.
- ▷ Federal Emissions System Defect Warranty.
- ▷ Federal Emissions Performance Warranty.
- ▷ California Emission Control System Limited Warranty.

Detailed information about these warranties is listed in the Service and Warranty Information Booklet for US models or in the Warranty and Service Guide Booklet for Canadian models.

Your vehicle has been specifically adapted and designed to meet the particular operating conditions and homologation requirements in your country and continental region in order to deliver the full driving pleasure while the vehicle is operated under those conditions. If you wish to operate your vehicle in another country or region, you may be required to adapt your vehicle to meet different prevailing operating conditions and homologation requirements. You should also be aware of any applicable warranty limitations or exclusions for such country or region. In such case, please contact Customer Relations for further information.

## Maintenance

Maintain the vehicle regularly to sustain the road safety, operational reliability and the New Vehicle Limited Warranty.

Specifications for required maintenance measures:

- ▷ MINI Maintenance system
- ▷ Service and Warranty Information Booklet for US models
- ▷ Warranty and Service Guide Booklet for Canadian models

If the vehicle is not maintained according to these specifications, this could result in serious damage to the vehicle. Such damage is not covered by the MINI New Vehicle Limited Warranty.

## DATA MEMORY

Numerous electronic components in your vehicle contain data memories that store technical information on the vehicle condition, events and faults, either temporarily or permanently. This technical information generally documents

the state of a component, a module, a system or the environment.

- ▷ Operating conditions of system components, such as filling levels.
- ▷ Status messages from the vehicle and its individual components, such as wheel rpm/speed, motion delay, transverse acceleration.
- ▷ Malfunctions and defects in important system components, such as lights and brakes.
- ▷ Vehicle responses to special driving situations, such as airbag deployment, use of the stability control systems.
- ▷ Ambient conditions, such as the temperature.

These data are of a technical nature only and are used to detect and eliminate faults and to optimize vehicle functions. Travel profiles of routes driven with the vehicle cannot be created from these data. If services are used, for instance in the event of repairs, service processes, warranty cases, quality assurance, etc., this technical information can be read out from the event and fault data memories by service personnel, including the manufacturer, using special diagnosis tools. This service personnel can provide you with more information if needed. After troubleshooting, the information in the fault memory is cleared or overwritten continuously.

Situations are conceivable during the use of the vehicle in which these technical data could become associated with a specific person in combination with other information, such as an accident report, damage to the vehicle, witness accounts, etc., possibly with the involvement of an authorized expert.

Additional functions that are contractually agreed with the customer, such as vehicle localization in the event of an emergency, permit the transfer of certain vehicle data out of the vehicle.





## REPORTING SAFETY DEFECTS

### For US customers

The following only applies to vehicles owned and operated in the US.

If you believe that your vehicle has a defect which could cause a crash or could cause injury or death, you should immediately inform the National Highway Traffic Safety Administration NHTSA, in addition to notifying BMW of North America, LLC, P.O. Box 1227, Westwood, New Jersey 07675-1227, Telephone 1-800-831-1117.

If NHTSA receives similar complaints, it may open an investigation, and if it finds that a safety defect exists in a group of vehicles, it may order a recall and remedy campaign.

However, NHTSA cannot become involved in individual problems between you, your dealer, or BMW of North America, LLC.

To contact NHTSA, you may call the Vehicle Safety Hotline toll-free at 1-888-327-4236 (TTY: 1-800-424-9153); go to <http://www.safercar.gov>; or write to: Administrator, NHTSA, 400 Seventh Street, SW., Washington, DC 20590. You can also obtain other information about motor vehicle safety from <http://www.safercar.gov>

### For Canadian customers

Canadian customers who wish to report a safety-related defect to Transport Canada, Defect Investigations and Recalls, may telephone the toll-free hotline 1-800-333-0510. You can also obtain other information about motor vehicle safety from <http://www.tc.gc.ca/roadsafety>.

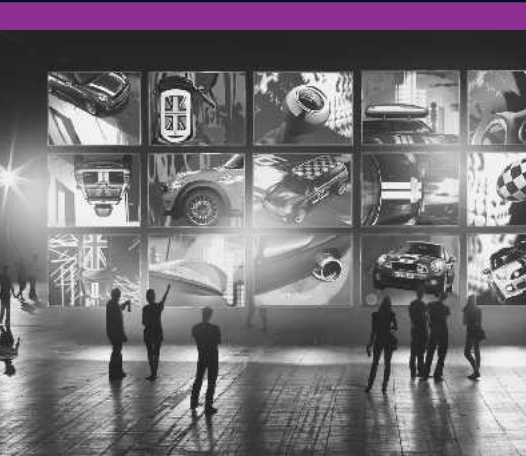

**AT A GLANCE**

**CONTROLS**

**DRIVING TIPS**

**NAVIGATION**

**ENTERTAINMENT**

**COMMUNICATION**

**MOBILITY**

**REFERENCE**

# COCKPIT

## VEHICLE EQUIPMENT

This chapter describes all series equipment as well as country-specific and special equipment offered for this model series. Therefore, it also

describes equipment that may not be found in your vehicle, for instance due to the selected special equipment or the country version. This also applies to safety-related functions and systems.

## ALL AROUND THE STEERING WHEEL

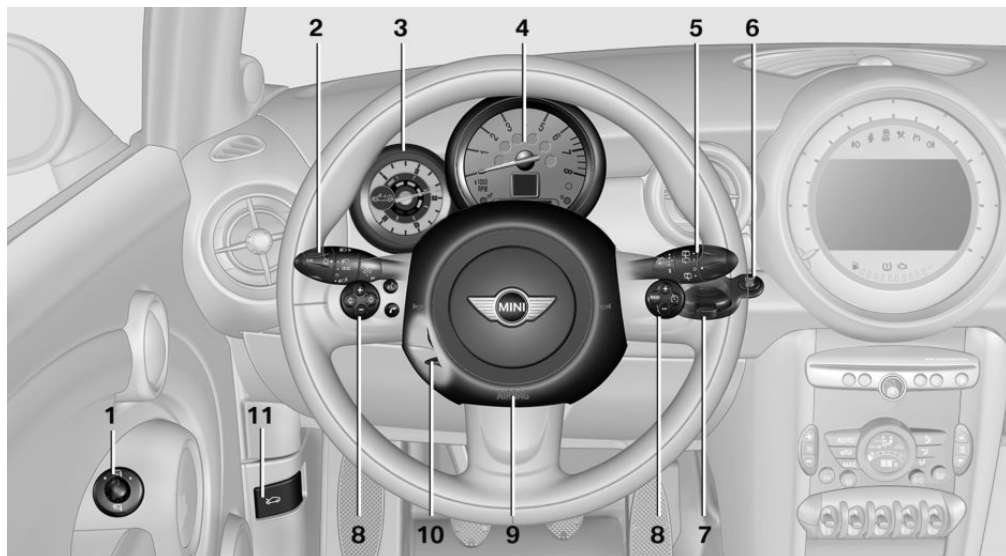

1 Setting the exterior mirror, folding it in and out 57

2  Parking lamps 85



Low beams 85



Automatic headlamp control 85

Adaptive Light Control 87



Turn signal 67



High beams 67



Headlamp flasher 67













Roadside parking lamps 86



Computer 75

3 MINI Roadster, MINI Convertible: Always Open Timer 77

4 Tachometer 75

-  Instrument lighting [88](#)
-  Trip odometer [74](#)
- 5**  Windshield wipers [67](#)
- 6**  Start/stop the engine and switch the ignition on/off [64](#)
- 7** Ignition lock [64](#)
- 8** Steering wheel buttons, right
-  Resuming cruise control [106](#)
-  Storing the speed and accelerating or slowing down [106](#)
-  Activating/deactivating cruise control [105](#)
- Steering wheel buttons, left
-  Volume
-  Bluetooth hands-free system [182](#)
- Bluetooth mobile phone preparation package [192](#)
-  Activate/deactivate the voice activation system [24](#)
-  Microphone on the steering column
-  Change the radio station  
Select a music track
-  Scroll through the radial list
- 9** Horn, the entire surface
- 10** Adjust the steering wheel [58](#)
- 11** Releasing the hood [237](#)

## DISPLAYS

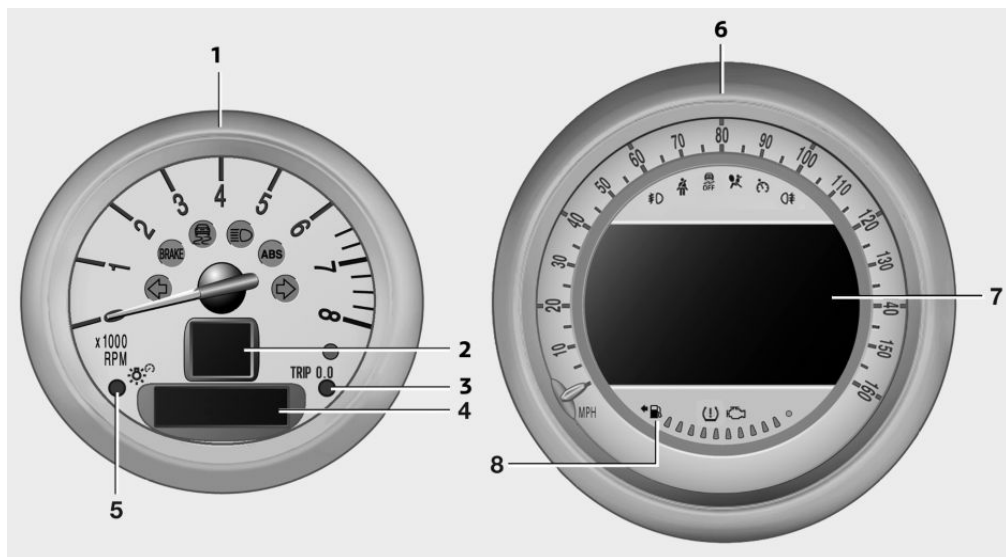

- |                                                                                                                                                                                                                                                                                                                                                                                                                                          |                                                                                                                                                                                                                                                                                                                                                                                                              |
|------------------------------------------------------------------------------------------------------------------------------------------------------------------------------------------------------------------------------------------------------------------------------------------------------------------------------------------------------------------------------------------------------------------------------------------|--------------------------------------------------------------------------------------------------------------------------------------------------------------------------------------------------------------------------------------------------------------------------------------------------------------------------------------------------------------------------------------------------------------|
| <p><b>1</b> Tachometer 75<br/>with indicator and warning lamps 15</p> <p><b>2</b> Display for</p> <ul style="list-style-type: none"> <li>▷ Current speed 74</li> <li>▷ Indicator/warning lamps 15</li> </ul> <p><b>3</b> Resetting the trip odometer 74</p> <p><b>4</b> Display for</p> <ul style="list-style-type: none"> <li>▷ Automatic transmission position 71</li> <li>▷ Computer 75</li> <li>▷ Service requirements 81</li> </ul> | <ul style="list-style-type: none"> <li>▷ Odometer and trip odometer 74</li> <li>▷ Flat Tire Monitor 93</li> <li>▷ Tire Pressure Monitor 93</li> <li>▷ Settings and information 77</li> <li>▷ Personal Profile settings 31</li> </ul> <p><b>5</b> Instrument lighting 88</p> <p><b>6</b> Speedometer with indicator and warning lamps 15</p> <p><b>7</b> Control Display 18</p> <p><b>8</b> Fuel gauge 75</p> |
|------------------------------------------------------------------------------------------------------------------------------------------------------------------------------------------------------------------------------------------------------------------------------------------------------------------------------------------------------------------------------------------------------------------------------------------|--------------------------------------------------------------------------------------------------------------------------------------------------------------------------------------------------------------------------------------------------------------------------------------------------------------------------------------------------------------------------------------------------------------|

## INDICATOR/WARNING LAMPS

### The concept

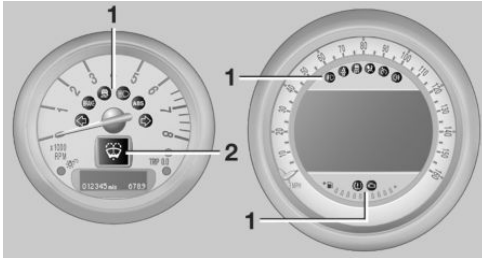

The indicator and warning lamps can light up in a variety of combinations and colors in display area 1 or 2.

Several of the lamps are checked for proper functioning when the engine is started or the ignition is switched on, and light up briefly.

### Text messages

Text messages at the upper edge of the Control Display explain the meaning of the displayed indicator and warning lamps.









### Supplementary text messages

You can call up more information, e.g., on the cause of a malfunction and on how to respond, via Check Control, refer to page 82.

In urgent cases, this information will be shown as soon as the corresponding lamp comes on.

### Indicator lamps without text messages

The following indicator lamps notify you that certain functions are active:

Symbol	Function or system
	Turn signal, refer to page 67
	
	High beams/headlamp flasher, refer to page 67
	Front fog lamps, refer to page 87
	Rear fog lamp, refer to page 88
	DSC or DTC is regulating the propulsive forces in order to maintain driving stability, refer to page 101
	The handbrake is set, refer to page 66
	Engine malfunction with adverse effect on emissions, refer to page 242
	Cruise control, refer to page 105

## ALL AROUND THE CENTER CONSOLE

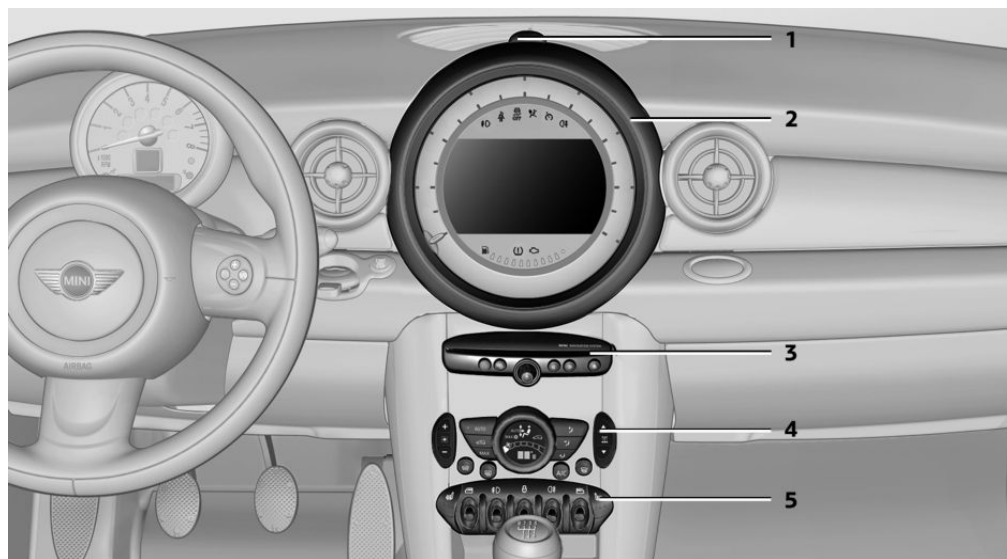

- 1 Hazard warning system
- 2 Speedometer with Control Display 14
- 3 Radio 160  
CD/multimedia 160
- 4 Air conditioning, automatic climate control 108
- 5 Buttons on the center console



Seat heating 55



Power windows 41



Rear fog lamp 88



MINI Convertible: central power window switch 42



Front fog lamps 87



Central locking, inside 35



## ALL AROUND THE HEAD-LINER



- 1 Indicator/warning lamps for the front passenger airbags [92](#)
- 2 Switch panel



Reading lamps [88](#)



MINI Roadster: interior lamps/reading lamps [88](#)



Ambient lighting color [89](#)



MINI Coupe, MINI Roadster: extending and retracting the spoiler manually [103](#)



MINI Convertible: opening and closing the sliding sunroof or convertible top [42](#)

MINI Roadster: opening and closing the convertible top [50](#)



Interior lamps [88](#)

## ALL AROUND THE SHIFT/SELECTOR LEVER

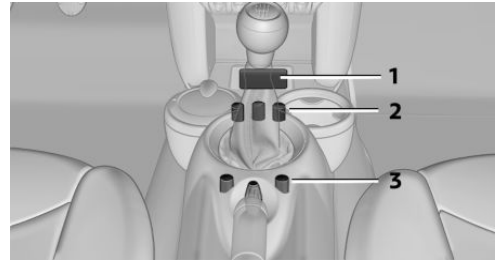

- 1 USB audio interface [172](#)
- 2 Buttons in the center console



Sport button [103](#)



Driving stability control systems [101](#)

- 3 MINI joystick with buttons [18](#)

# ONBOARD MONITOR

## VEHICLE EQUIPMENT

This chapter describes all series equipment as well as country-specific and special equipment offered for this model series. Therefore, it also describes equipment that may not be found in your vehicle, for instance due to the selected special equipment or the country version. This also applies to safety-related functions and systems.

## THE CONCEPT

The onboard monitor combines the functions of a large number of different switches. Thus, these functions can be operated from a central location.

 Using the onboard monitor during a trip  
To avoid becoming distracted and posing an unnecessary hazard to your vehicle's occupants and to other road users, never attempt to use the controls or enter information unless traffic and road conditions allow this. ◀

## CONTROLS AT A GLANCE

### Controls

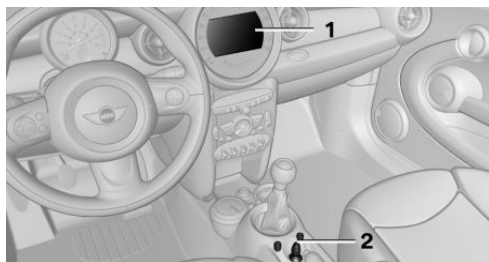

- 1 Control Display
- 2 MINI joystick with buttons

The buttons can be used to open the menus directly. The MINI joystick can be used to select menu items and create settings.

## Control Display

### Notes

- ▷ To clean the Control Display, follow the care instructions, refer to page 263.
- ▷ Do not place objects close to the Control Display; otherwise, the Control Display can be damaged.

### Switching off

1. Move the MINI joystick repeatedly to the right until the "Options" menu appears.
2. "Switch off control display"

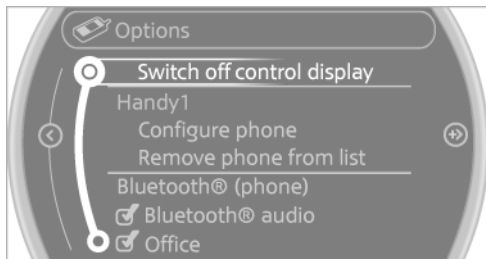

### Switching on

Press the MINI joystick to switch on.

## MINI joystick with buttons

Select menu items and create settings.

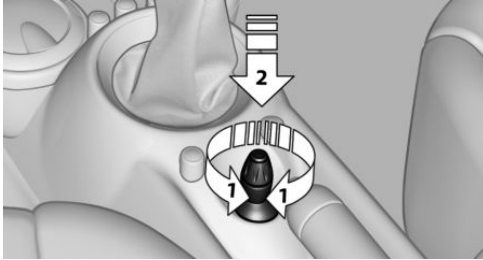

1. Turn, arrow 1.

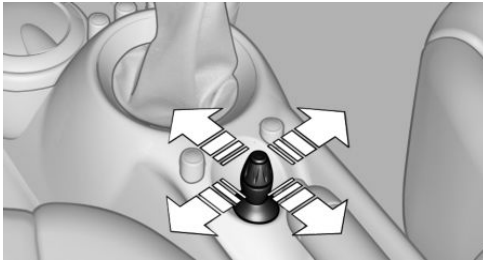

2. Press, arrow 2.
3. Move in four directions.



## Buttons on the MINI joystick

Press the button	Function
	Opens the main menu.
	Changes to another menu.

## OPERATING CONCEPT

### Start screen

In the radio ready state and higher, the following message appears on the Control Display:

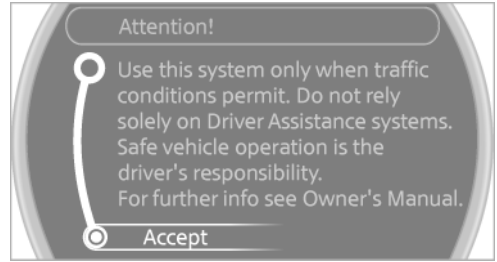

To hide the message: press the MINI joystick. The main menu is displayed.

The message is automatically hidden after approx. 10 seconds.

## Opening the main menu

 Press the button.

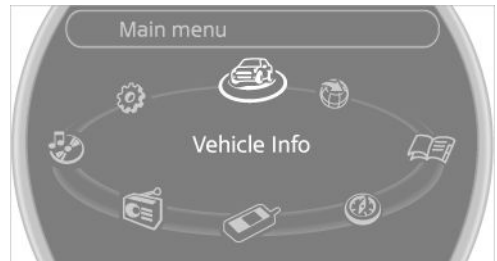

The main menu is displayed.

All onboard monitor functions can be called up via the main menu.

## Selecting menu items

Menu items shown in white can be selected.

1. Turn the MINI joystick until the desired menu item is highlighted.

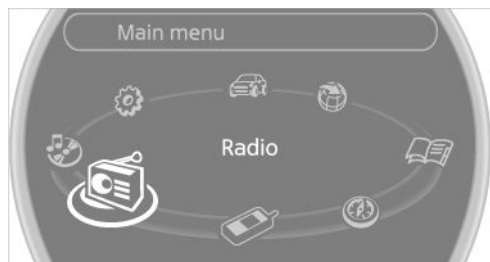

2. Press the MINI joystick.

A new menu is displayed or the function is performed.

With the button on the MINI joystick:



Press the button.

The menu items of the main menu can be opened consecutively by pressing the button repeatedly.

## Menu items in the Owner's Manual

In the Owner's Manual, menu items that can be selected are set in quotation marks, e.g., "Settings".

## Changing between panels

After a menu item is selected, e.g., "Radio", a new panel is displayed. Panels can overlap.

- ▷ Move the MINI joystick to the left.
 

The current panel is closed and the previous panel is displayed.
- ▷ Move the MINI joystick to the right.
 

A new panel is opened on top of the previous display.

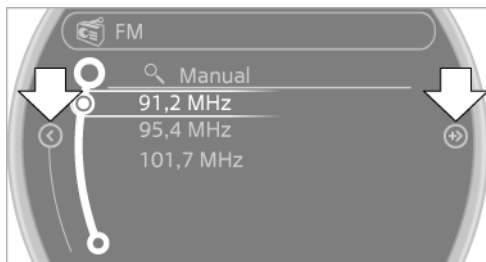

Arrows pointing to the left or right indicate that additional panels can be opened.

## View of an opened menu

When a menu is opened, it generally opens with the panel that was last selected in that menu. To display the first panel of a menu:

Move the MINI joystick to the left repeatedly until the first panel is displayed.

## Opening the Options menu

Move the MINI joystick repeatedly to the right until the "Options" menu appears.



## Options menu

The "Options" menu consists of various areas:

- ▷ Screen settings, e.g., "Switch off control display".
- ▷ Control options for the selected main menu, e.g., for "Radio".
- ▷ If applicable, further operating options for the selected menu, for instance "Store station".

## Changing settings

1. Select a field.
2. Turn the MINI joystick until the desired setting is displayed.

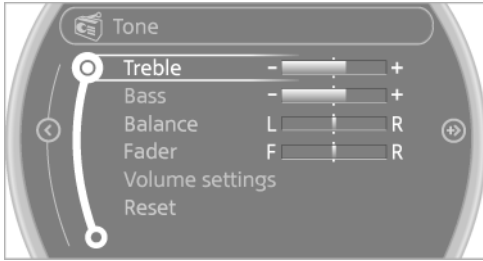

3. Press the MINI joystick to confirm the setting.

## Activating/deactivating the functions

Several menu items are preceded by a checkbox. It indicates whether the function is activated or deactivated. Selecting the menu item activates or deactivates the function.

- The function is activated.
- The function is deactivated.

## EXAMPLE: SETTING THE CLOCK

### Setting the clock

1.  Press the button. The main menu is displayed.
2. Turn the MINI joystick until "Settings" is highlighted and press the MINI joystick.

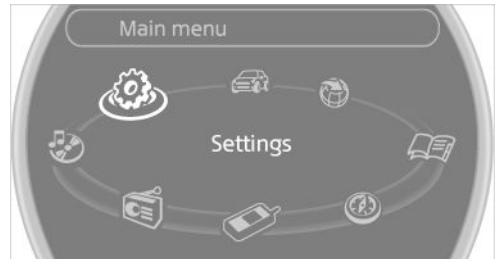

3. If necessary, move the MINI joystick to the left to display "Time/Date".
4. Turn the MINI joystick until "Time/Date" is highlighted and press the MINI joystick.

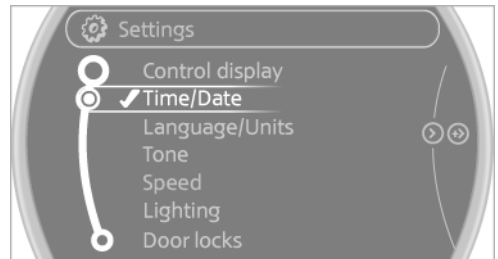

5. Turn the MINI joystick to set the hours and press the MINI joystick.
6. Turn the MINI joystick to set the minutes and press the MINI joystick.

## STATUS INFORMATION

### Status field

The following information is displayed in the status field at the top right:



- ▷ Time.
- ▷ Current entertainment source.
- ▷ Sound output, on/off.
- ▷ Wireless network reception strength.
- ▷ Telephone status.
- ▷ Traffic bulletin reception.

Check Control messages and entries using the voice activation system temporarily hide the status information.







### Status field symbols

The symbols are grouped into various categories.



### Radio symbols



Symbol	Meaning
	HD Radio™ is switched on.
	Satellite radio is switched on.

### Telephone symbols

Symbol	Meaning
	Incoming or outgoing call.
	Wireless network reception strength Symbol flashes: searching for network.
	Wireless network is not available.
	Bluetooth is switched on.
	Roaming is active.
	Text message, e-mail was received.

### Entertainment symbols

Symbol	Meaning
	CD player.
	AUX-IN port.

Symbol	Meaning
	USB audio interface.
	Music interface for smartphones.

### Additional symbols



Symbol	Meaning
	Spoken instructions are switched off.

## ENTERING LETTERS AND NUMBERS

### General information

1. Turn the MINI joystick: select letters or numbers.
2. Select additional letters or numbers if needed.
3. "OK": confirm the entry.



Symbol	Function
	Press the MINI joystick: delete the letter or number.
	Press the MINI joystick for an extended period: delete all letters or numbers.
	Enter a blank space.

### Switching between letters and numbers

Depending on the menu, you can switch between entering letters and numbers.

Symbol	Function
<b>A<sup>B</sup>C</b>	Enter the letters.
<b>1@+</b>	Enter the numbers.

### Switching between upper and lower case letters

Depending on the menu, you can switch between entering uppercase and lowercase letters.

Symbol	Function
<b>▲ abc</b>	Move the MINI joystick forward: switch from upper to lower case letters.
<b>▲ ABC</b>	Move the MINI joystick forward: switch from lower to upper case letters.

### Entry comparison

Entry of names and addresses: the selection is narrowed down every time a letter is entered and letters may be added automatically.

The entries are continuously compared to the data stored in the vehicle.

- ▷ Only those letters are offered during the entry for which data is available.
- ▷ Destination search: town/city names can be entered using the spelling of language available on the Control Display.

# VOICE ACTIVATION SYSTEM

## VEHICLE EQUIPMENT

This chapter describes all series equipment as well as country-specific and special equipment offered for this model series. Therefore, it also describes equipment that may not be found in your vehicle, for instance due to the selected special equipment or the country version. This also applies to safety-related functions and systems.

## THE CONCEPT

- ▷ Most functions that are displayed on the Control Display can be operated with the voice activation system using spoken commands. The system prompts you to make your entries.
- ▷ Functions that can only be used when the vehicle is stationary cannot be operated using the voice activation system.
- ▷ The system uses a special microphone in the headliner on the driver's side.
- ▷ ›...‹ Verbal instructions in the Owner's Manual to use with the voice activation system.



## REQUIREMENTS

Via the Control Display, set a language that is also supported by the voice activation system so that the spoken commands can be identified.

Set the language, refer to page 80.

## USING VOICE ACTIVATION

### Activating the voice activation system

1.  Press the button on the steering wheel.
2. Wait for the signal.
  -  This symbol on the Control Display indicates that the voice activation system is active.



3. Say the command.
  - The command appears on the Control Display.

If no other commands are available, operate the function via the onboard monitor in this case.

### Terminating the voice activation system

-  Briefly press the button on the steering wheel or ›Cancel‹.

## POSSIBLE COMMANDS

Most menu items on the Control Display can be voiced as commands.

The available commands depend on the menu that is currently displayed on the Control Display.



The functions of the main menu have short commands.

Some list items, such as the phone book entries, can also be selected via the voice activation system. Say the list items exactly as they are displayed on the list.

### Having possible commands read aloud

You can have the system read possible commands aloud: ›Voice commands‹.

For example, if the "CD" menu is displayed, the commands for the operating the CD player are read out loud.

### Executing functions using short commands

Functions on the main menu can be performed directly by means of short commands, usually irrespective of which menu item is currently selected, for instance ›Vehicle status‹.

List of short commands of the voice activation system, refer to page 274.

### Help dialog for the voice activation system

Calling up help dialog: ›Help‹



Additional commands for the help dialog:

- ▶ ›Help with examples‹: information about the current operating options and the most important commands for them are announced.
- ▶ ›Help with voice activation‹: information about the principle of operation for the voice activation system is announced.

## EXAMPLE: PLAYING BACK A CD

### Via the main menu

The commands of the menu items are spoken out loud, in the same way as they are selected via the MINI joystick.

1. Switch on the Entertainment sound output if necessary.
2.  Press the button on the steering wheel.
3. ›C D and multimedia‹  
The medium last played is played back.
4. ›C D‹
5. ›C D drive‹  
The CD is played back.
6.  Press the button on the steering wheel again to select a specific track.
7. ›Track ...‹ e.g., CD track 4.

### Via short commands

Playback of the CD can also be started using a short command.

1. Switch on the Entertainment sound output if necessary.
2.  Press the button on the steering wheel.
3. ›C D drive Track ...‹ e.g., CD track 4.

## SETTING THE VOICE DIALOG

You can set whether the system should use the standard dialog or a shorter version.

In the shorter variant of the voice dialog, the announcements from the system are issued in an abbreviated form.

On the Control Display:

1. "Settings"
2. "Language/Units"
3. "Speech mode:"
4. Select the setting.

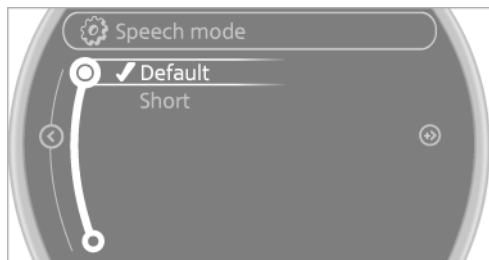

- ▷ Always say commands in the language of the voice activation system.
- ▷ Keep the doors and windows closed to prevent noise interference.
- ▷ Avoid making other noise in the vehicle while speaking.

## ADJUSTING THE VOLUME

Turn the volume knob while giving an instruction until the desired volume is set.

- ▷ The volume remains constant even if the volume of other audio sources is changed.
- ▷ The volume is stored for the remote control currently in use.

## NOTES ON EMERGENCY REQUESTS

Do not use the voice activation system to initiate an Emergency Request. In stressful situations, the voice and vocal pitch can change. This can unnecessarily delay the establishment of a telephone connection.

## ENVIRONMENTAL CONDITIONS

- ▷ Say the commands, numbers, and letters smoothly and with normal volume, emphasis, and speed.



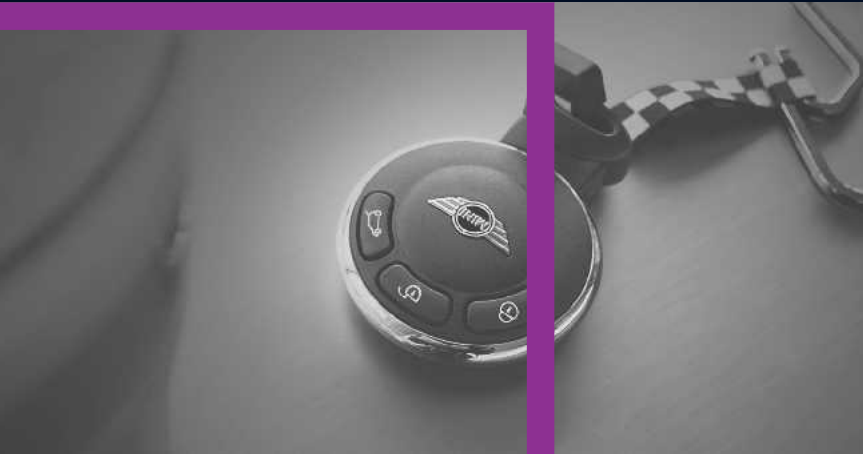

**AT A GLANCE**

**CONTROLS**

**DRIVING TIPS**

**NAVIGATION**

**ENTERTAINMENT**

**COMMUNICATION**

**MOBILITY**

**REFERENCE**

# OPENING AND CLOSING

## VEHICLE EQUIPMENT

This chapter describes all series equipment as well as country-specific and special equipment offered for this model series. Therefore, it also describes equipment that may not be found in your vehicle, for instance due to the selected special equipment or the country version. This also applies to safety-related functions and systems.

## REMOTE CONTROL/KEY

### Buttons on the remote control

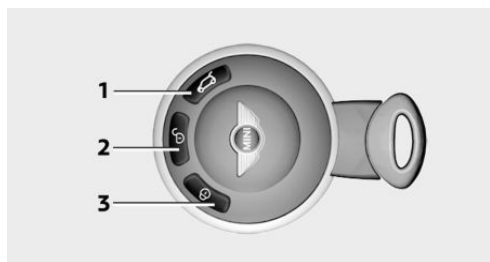

- 1 Opening tailgate
- 2 Unlocking
- 3 Locking

### General information

Each remote control contains a rechargeable battery that is automatically recharged when it is in the ignition lock while the car is being driven. Use each remote control at least twice a year for longer road trips in order to maintain the batteries' charge status. In vehicles equipped with Comfort Access, the remote control contains a replaceable battery, refer to page 39.

The settings called up and implemented when the vehicle is unlocked depend on which re-

mote control is used to unlock the vehicle, Personal Profile, refer to page 31.

In addition, information about service requirements is stored in the remote control, Service data in the remote control, refer to page 241.

### Integrated key

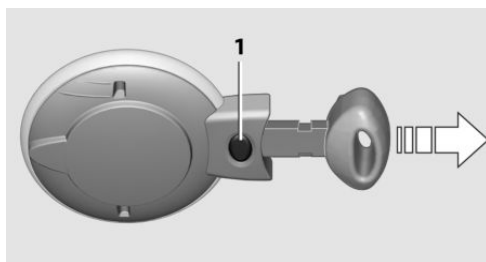

Press button 1 to unlock the key.

The integrated key fits the following locks:

- ▷ Driver's door, refer to page 34.
- ▷ MINI Convertible, MINI Roadster: glove compartment, refer to page 118.
- ▷ MINI Convertible: lock of rear seat backrest, refer to page 116.
- ▷ MINI Coupe, MINI Roadster: through-loading opening, refer to page 117.

### New remote controls

You can obtain new remote controls from your service center.

### Loss of the remote controls

Lost remote controls can be blocked by your service center.

## PERSONAL PROFILE

### The concept

You can set several of your vehicle's functions to suit your personal needs and preferences.

- ▷ Through Personal Profile, most of these settings are stored for the remote control currently in use.
- ▷ While the vehicle is being unlocked, the remote control is recognized and the settings stored with it are called up and implemented.
- ▷ Your personal settings will be recognized and called up again even if the vehicle has been used in the meantime by someone else with another remote control.
- ▷ The individual settings are stored for no more than three remote controls.

### Personal Profile settings

The following functions and settings can be stored in a profile.

More information on the settings can be found under:

- ▷ Response of the central locking system when the car is being unlocked, refer to page 32.
- ▷ Automatic locking of the vehicle, refer to page 35.
- ▷ Triple turn signal activation, refer to page 67.
- ▷ Settings for the displays on the onboard monitor, in the speedometer, and in the tachometer:
  - ▷ 12h/24h clock format, refer to page 79.
  - ▷ Date format, refer to page 80.
  - ▷ Brightness of the Control Display, refer to page 80.
  - ▷ Language on the Control Display, refer to page 80.

- ▷ Units of measure for fuel consumption, distance covered/remaining distances, and temperature, refer to page 78.
- ▷ Light settings:
  - ▷ Headlamp courtesy delay feature, refer to page 86.
  - ▷ Daytime running lights, refer to page 86.
- ▷ Automatic climate control, refer to page 110: AUTO program, activating/deactivating the cooling function, setting the temperature, air volume, and air distribution.
- ▷ Entertainment:
  - ▷ Tone settings, refer to page 158.
  - ▷ Volume, refer to page 158.

## CENTRAL LOCKING SYSTEM

### The concept

The central locking system becomes active when the driver's door is closed.

The system simultaneously engages and releases the locks on the following:

- ▷ Doors.
- ▷ Tailgate.
- ▷ Fuel filler flap.

### Operating from the outside

- ▷ Via the remote control.
- ▷ Via the door lock.
- ▷ In cars with Comfort Access, via the door handles on the driver's and front passenger sides.

The following takes place simultaneously when locking/unlocking the vehicle via the remote control:

- ▷ Depending on the vehicle equipment, the anti-theft protection is switched on and off as well. The anti-theft protection makes it

impossible to unlock the doors using the lock buttons or door handles.

- ▷ The welcome lamps, interior lamps, and ambient lighting are switched on and off.
- ▷ The alarm system is armed or disarmed, refer to page 39.

### Operating from the inside

Via the button for the central locking system, refer to page 35.

In an accident of the necessary severity, the central locking system unlocks automatically.

The hazard warning system and interior lamps come on.

## OPENING AND CLOSING: FROM THE OUTSIDE

### Using the remote control

#### General information

 Take the remote control with you. People or animals left unattended in a parked vehicle can lock the doors from the inside. Always take the remote control with you when leaving the vehicle so that the vehicle can then be opened from the outside. ◀

#### Unlocking

 Press the button. The vehicle is unlocked.

The welcome lamps and interior lamps are switched on.

You can set how the vehicle is to be unlocked.

The setting is stored for the remote control currently in use.

#### 1. "Settings"



#### 2. "Door locks"

#### 3. "Unlock button"

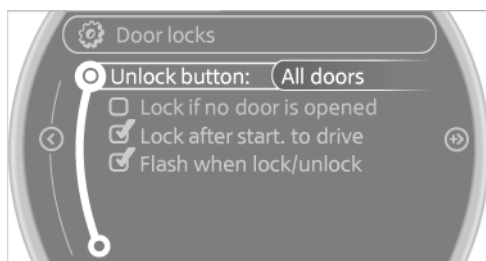

#### 4. Select the desired function:

##### ▷ "All doors"

 Press the button once: the entire vehicle unlocks.

##### ▷ "Driver's door only"

 Pressing the button once unlocks only the driver's door and the fuel filler flap. Pressing twice unlocks the entire vehicle.

#### Convenient opening

 Press and hold the button on the remote control.

The power windows are opened. In the MINI Convertible, the sliding sunroof is opened as well.



To open the convertible top and the rear windows in the MINI Convertible: release the button and then press and hold it again until the convertible top is fully open. The side windows remain open.

MINI Convertible with Comfort Access:

 Hold the button down.

When you are close to the vehicle, the side windows move up after the convertible top is opened.

## Convenient closing

MINI Convertible:

The convertible top, sliding sunroof, and windows can be closed using the remote control for Comfort Access when you are close to the vehicle.

 Hold the button down.

The convertible top and windows are closed.

 Monitor the closing process  
Watch during the closing process to be sure that no one is injured. Removing the hand from the door handle immediately stops the closing process. ◀

MINI Coupe, MINI Roadster:

Convenient closing with the remote control is not possible.

## Locking

 Press the button.

 Locking from the outside  
Do not lock the vehicle from the outside if there are people in it, as the vehicle cannot be unlocked from inside without special knowledge. ◀

## Setting the confirmation signals

Have unlocking or locking of the vehicle confirmed.

1. "Settings"
2. "Door locks"
3. "Flash when lock/unlock"

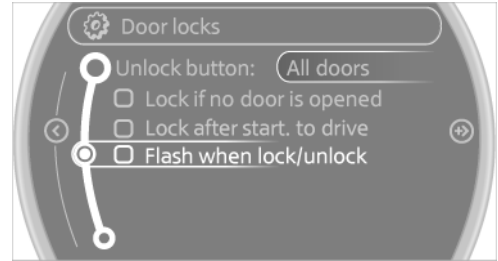

4. Press the MINI joystick.

## Switching on the interior lamps

When the vehicle is locked:

 Press the button.

You can also use this function to locate your vehicle in parking garages, etc.

## Unlocking the tailgate

 Press the button for approx. 1 second and then release it.

The tailgate pivots back and up when it opens. Ensure that adequate clearance is available before opening.

## Malfunctions

The function of the remote control may be impaired by local radio waves. If this occurs, unlock and lock the vehicle at the door lock with the integrated key.

If it should become impossible to lock the vehicle with a remote control, the battery in the remote control is discharged. Use this remote control on an extended trip to recharge the battery, refer to page 30.

## For US owners only

The transmitter and receiver units comply with part 15 of the FCC/Federal Communication Commission regulations. Operation is governed by the following:

FCC ID:

LX8766S

LX8766E

LX8CAS

Compliance statement:

This device complies with part 15 of the FCC Rules. Operation is subject to the following two conditions:

- ▷ This device may not cause harmful interference, and
- ▷ this device must accept any interference received, including interference that may cause undesired operation.

Any unauthorized modifications or changes to these devices could void the user's authority to operate this equipment.

## Using the door lock

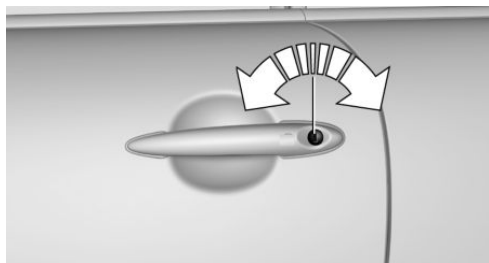

Sets how the vehicle is to be unlocked, refer to page 32.

In some vehicle equipment versions, only the driver's door can be unlocked and locked via the door lock.



Locking from the outside

Do not lock the vehicle from the outside if there are people in it, as the vehicle cannot be unlocked from inside without special knowledge. ◀

## Locking the doors and tailgate at once

To lock all doors, the fuel filler flap, and the tailgate at once:

1. With the doors closed, lock the vehicle using the button for the central locking system in the interior, refer to page 35.
2. Unlock and open the driver's or front passenger door, refer to page 35.
3. To lock the vehicle:
  - ▷ Lock the driver's door using the integrated key in the door lock, or
  - ▷ Press down the lock button of the front passenger door and close the door from the outside.

## Convenient opening and closing

In vehicles with an alarm system or Comfort Access, the windows can be operated via the door lock.

MINI Convertible: sliding sunroof and convertible top operation in addition.

## Opening/closing

Turn the key to the unlock or lock position and hold it there.

In the MINI Convertible, the convertible top is closed, followed by the sliding sunroof and side windows.



Keep the closing area clear

Watch during the opening and closing process to be sure that no one becomes trapped. Releasing the key stops the motion. ◀

## Manual operation

If an electrical malfunction occurs, the driver's door can be unlocked or locked by turning the integrated key to the end positions of the door lock.

## OPENING AND CLOSING: FROM THE INSIDE

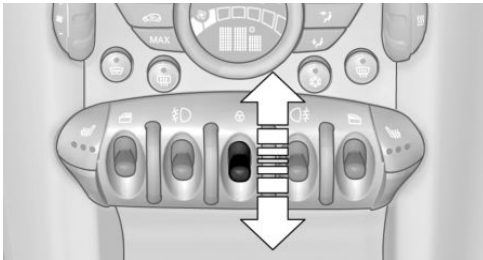

The switch can be used to lock or unlock the doors and tailgate when the doors are closed, but they are not theft-protected. The fuel filler flap remains unlocked.

## Unlocking and opening doors

- ▶ Using the switch for the central locking system, unlock all of the doors at once and then pull the door opener above the armrest, or
- ▶ Pull the door handle on each door twice: the door is unlocked the first time and opened the second time.

## Locking

- ▶ Press the switch or
- ▶ Push down the lock button of a door. To avoid locking yourself out by accident, the driver's door cannot be locked at the lock button while the door is open.

## Automatic locking

In addition, it is possible to set the situations in which the vehicle locks. The setting is stored for the remote control in use.

1. "Settings"
2. "Door locks"
3. Select a menu item:
  - ▶ "Lock if no door is opened"
 

The central locking system locks after a short period if no door is opened.
  - ▶ "Lock after start. to drive"
 

The central locking system locks when you start driving.

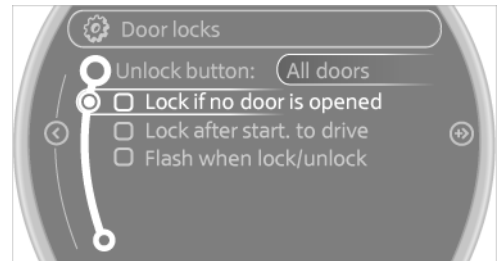

- ⚠ Take the remote control with you
 

People or animals left unattended in a parked vehicle can lock the doors from the inside. Always take the remote control with you when leaving the vehicle so that the vehicle can then be opened from the outside. ◀

## TAILGATE

### Opening

The tailgate pivots back and up when it opens. Ensure that adequate clearance is available before opening.

 Provide edge protection  
Sharp or angular objects can hit the rear window while driving and damage the heating wires of the rear window. Provide edge protection. ◀

In some market-specific versions, the tailgate can only be unlocked using the remote control if the vehicle was unlocked first.



 Press and hold the button of the remote control or the button in the handle, arrow. The tailgate is unlocked and can be opened.

### MINI Convertible



The open tailgate can be loaded with a maximum weight of 175 lbs/80 kg.

### Manual release

In the event of an electrical malfunction, the tailgate can be unlocked manually.

MINI Coupe, MINI Roadster:

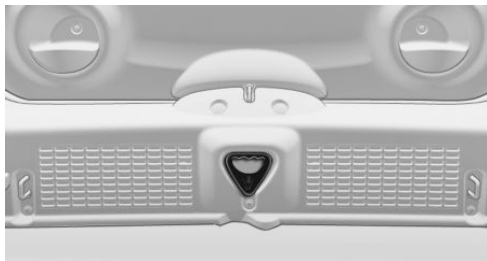

Pull the handle. The tailgate is unlocked.

MINI Convertible:

1. Using the integrated key, unlock the lock of the rear seat backrests 1.

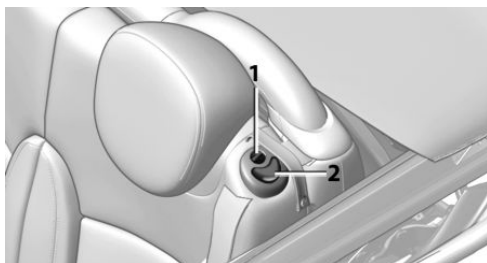

2. Press button 2 and fold the rear seat backrest forward while guiding the safety belt.

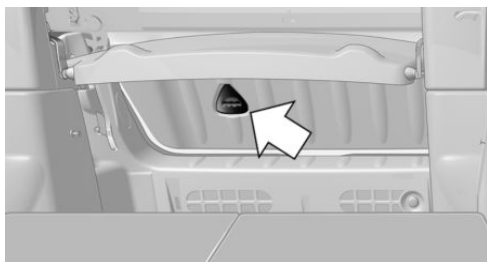

3. Pull the handle, see arrow. The tailgate is unlocked.

### MINI Convertible, MINI Roadster: emergency unlocking



Pull the handle in the cargo area. The tailgate is unlocked.

### Closing

**!** Keep the closing area clear  
Make sure that the closing area of the tailgate is clear; otherwise, injuries or damage may result. ◀

**!** Take the remote control with you  
Always take the remote control with you when leaving the vehicle and do not place it in the cargo area; otherwise, the remote control may be locked into the vehicle when the tailgate is closed. ◀

### MINI Coupe



Recessed grips on the inside trim of the tailgate can be used to conveniently pull down the tailgate.

### MINI Roadster

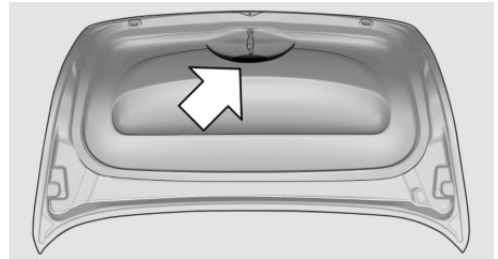

Recessed grips on the inside trim of the tailgate can be used to conveniently pull down the tailgate.

## COMFORT ACCESS

### The concept

The vehicle can be accessed without activating the remote control. All you need to do is to have the remote control with you, e.g., in your jacket pocket. The vehicle automatically detects the remote control when it is nearby or in the passenger compartment.

Comfort Access supports the following functions:

- ▷ Unlocking/locking of the vehicle.
- ▷ Unlocking of the tailgate separately.
- ▷ Starting the engine.
- ▷ MINI Convertible: Convenient closing and convertible top operation with the remote control for Comfort Access.
- ▷ MINI Coupe, MINI Roadster: closing the side windows.

### Functional requirements

- ▷ There are no external sources of interference in the vicinity.
- ▷ To lock the vehicle, the remote control must be located outside of the vehicle.
- ▷ The next unlocking and locking cycle is not possible until after approx. 2 seconds.

- ▶ The engine can only be started if the remote control is inside the vehicle.
- ▶ The doors and tailgate must be closed to operate the windows.

### Comparison with ordinary remote control

The functions can be controlled by pressing the buttons or via Comfort Access.

Notes on opening and closing, refer to page 30.

If you notice a brief delay while opening or closing the windows or convertible top, the system is checking whether a remote control is inside the vehicle. Repeat the opening or closing procedure, if necessary.

### Unlocking



Press button 1.

Depending on the setting, either only the driver's door or the entire vehicle is unlocked, refer to page 32.

Pressing the button again locks the entire vehicle again.

Convenient opening with the remote control, refer to page 32.

### Locking

Press button 1.

### MINI Convertible, MINI Roadster: windows and convertible top operation

In the radio ready state and beyond, the windows and the electrical convertible top can be

opened and closed when a remote control is located inside the vehicle.

### Unlocking the tailgate separately

Press the button on the exterior of the tailgate.

This corresponds to pressing the following but-

ton on the remote control:  .

If a remote control accidentally left in the cargo area is detected in the locked vehicle after the tailgate is closed, the tailgate opens again slightly. The hazard warning system flashes and an acoustic signal sounds.

### Power windows

When the engine is switched off, the windows can be operated as long as neither the doors nor the tailgate are open.

When the door and tailgate are closed again and the remote control is detected inside the vehicle, the windows can be operated again.

Insert the remote control into the ignition lock to be able to operate the windows while the engine is switched off and the doors are open.

### Switching on the radio ready state

Press the Start/Stop button to switch on the radio ready state, refer to page 64.

Do not depress the brake or the clutch; otherwise, the engine will start.

### Starting the engine

The engine can be started or the ignition can be switched on, refer to page 64, when a remote control is inside the vehicle. It is not necessary to insert a remote control into the ignition lock.

### Switching off the engine in cars with automatic transmission

The engine can only be switched off with the selector lever in position P, refer to page 70.

To switch off the engine with the selector lever in position N, the remote control must be inserted in the ignition lock.

### Before driving a vehicle with automatic transmission into a car wash

1. Insert the remote control into the ignition switch.
2. Depress the brake pedal.
3. Move the selector lever to position N.
4. Switch the engine off.

The vehicle can roll.

### Malfunction

The Comfort Access functions can be disturbed by local radio waves, such as by a mobile phone in the immediate vicinity of the remote control or when a mobile phone is being charged in the vehicle.

If this occurs, open or close the vehicle using the buttons on the remote control or use the integrated key in the door lock.

To start the engine afterward, insert the remote control into the ignition switch.

### Warning lamps



The warning lamp in the instrument cluster lights up when you attempt to start the engine: the engine cannot be started.

The remote control is not in the vehicle or has a malfunction. Take the remote control with you inside the vehicle or have it checked. If necessary, insert another remote control into the ignition switch.



The warning lamp in the instrument cluster lights up while the engine is running: the remote control is no longer inside the vehicle.

After switching off the engine, the engine can only be started again within approx. 10 seconds if no door has been opened.



The indicator lamp lights up and a message appears on the Control Display: replace the remote control battery.

### Replacing the battery

The remote control for Comfort Access contains a battery that will need to be replaced from time to time.

1. Remove the cover.

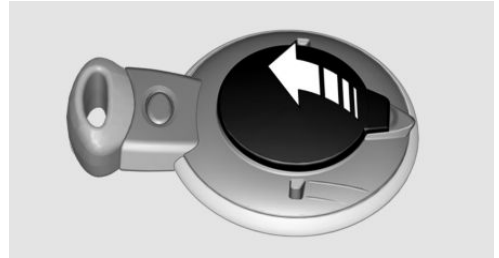

2. Insert a new battery with the positive side facing upwards.
3. Press the cover closed.



Return used battery to a recycling center or to your service center.

## ALARM SYSTEM

### The principle

The alarm system, when activated, reacts if:

- ▷ A door, the engine compartment lid or the tailgate are opened.
- ▷ There is movement inside the car.
- ▷ The car's inclination changes, for instance if an attempt is made to jack it up and steal the wheels or to raise it prior to towing away.
- ▷ There is an interruption in the power supply from the battery

The alarm system briefly indicates unauthorised entry or tampering by means of:

- ▷ An acoustic alarm.
- ▷ Switching on the hazard warning flashers.

## Arming and disarming

### General information

Whenever the car is locked or unlocked, the alarm system is armed or disarmed.

### Door lock and armed alarm system

Unlocking via the door lock will trigger the alarm on some market-specific versions.

To stop this alarm, unlock the vehicle with the remote control or switch on the ignition.

### Tailgate with armed alarm system

The tailgate can also be opened when the alarm system is armed.



Press the button on the remote control.

When you subsequently close the tailgate it is again locked and monitored.

### Switching off an alarm

- ▷ Unlock the car with the remote control.
- ▷ Insert the key fully into the ignition lock.
- ▷ In cars with convenient access, press the button on the door lock.

### Display on the revolution counter

When the system is armed, all LEDs pulse. After approx. 16 minutes one LED flashes.

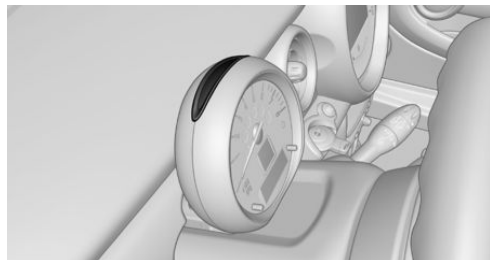

- ▷ LEDs pulse or LED flashes: system is armed.
- ▷ One LED flashes at short intervals:

Doors, engine compartment lid or tailgate are not properly closed. Even if these are not closed fully, the remaining items are locked and the LEDs pulse after approx. 10 seconds for approx. 16 minutes. Afterwards, one LED flashes.

The interior movement detector is not activated.

- ▷ LEDs go out after the vehicle is unlocked: no attempt was made to tamper with the car.
- ▷ LEDs flash after unlocking until the key is inserted in the ignition, but for no longer than approx. 5 minutes: an attempt was made to tamper with the car.

### Panic mode

You can trigger the alarm system if you find yourself in a dangerous situation.



Press the button for at least two seconds.

To switch off the alarm: press any button on the remote control.

### Tilt alarm sensor

The vehicle's inclination is monitored. The alarm is triggered, for instance, if an attempt is made to steal the car's wheels or tow it away.

### Interior movement detector

#### MINI Coupe

Before the interior movement detector can operate correctly, the windows must be closed.

#### MINI Convertible, MINI Roadster

The interior of the car is monitored up to the height of the seat cushions. Thus the alarm system is armed together with the interior motion sensor even if the convertible top is open. An



alarm can be triggered unintentionally by falling objects such as leaves, refer to Avoiding unintentional alarms.

### Avoiding false alarms

The tilt alarm sensor and the interior movement detector can be switched off together.

- ▷ In duplex garages.
- ▷ When being transported on car-carrying trains, ferries or trailers.
- ▷ If pets are to remain inside the car.

### Switching off the tilt alarm sensor and interior movement detector

- ▷  Press the button on the remote control twice in succession.
- ▷ Lock the vehicle twice with the integrated key.

LEDs flash in short succession for approx. 2 seconds. The tilt alarm sensor and the interior movement detector are switched off until the car is next unlocked and locked.

## POWER WINDOWS

### General information

-  Take the remote control with you when leaving the vehicle so that children, for example, cannot operate the power windows and injure themselves. ◀

If, after having been opened and closed a number of times in close succession, a window can only be closed, the system is overheated. Let the system cool down for several minutes with the ignition switched on or the engine running.

### Opening

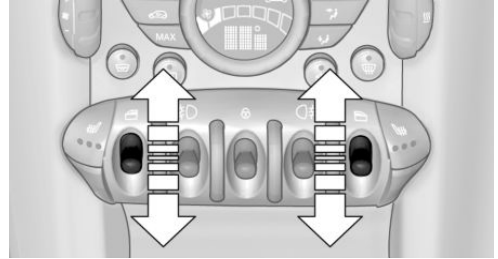

- ▷ Press the switch downward.  
The window opens until the switch is released.
- ▷ Press the switch downward briefly.  
In the radio ready state and higher, the window opens automatically. Press again briefly to stop the opening procedure.

To open the window by a crack, briefly press the switch downward twice in close succession.

### Closing

-  Danger of pinching  
Monitor the closing process and make sure that the closing path of the window is clear; otherwise, injuries may result. ◀

To close, press the switch upward. The window closes until the switch is released.

### Initializing the power windows

If the battery was disconnected, for example to change the battery or to put the vehicle into storage, reinitialize the power windows; otherwise, the windows will not be lowered.

1. Close the doors.
2. Open both windows.
3. Close both windows.

Please contact your service center in the event of a malfunction.

### MINI Convertible: central power windows switch

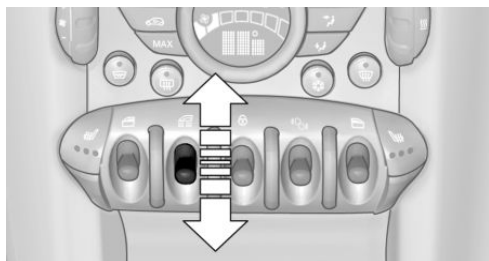

- ▷ Press the switch downward.  
The rear and front windows open consecutively until the switch is released.
- ▷ Press the switch downward briefly.  
With the ignition switched on: the rear and front windows open automatically. Press again briefly to stop the opening procedure.

To close the windows, press the switch upward and hold it.

Do not close the windows until the closing procedure of the convertible top is completed; otherwise, it cannot be ensured that the side windows will form a tight seal with the rubber seals of the convertible top. Convertible top, refer to page 43.

### After the ignition is switched off

The windows can be operated for approx. 1 minute after the remote control is removed or the ignition is switched off.

- ⚠ Take the remote control with you  
Take the remote control with you when leaving the vehicle so that children, for example, cannot operate the power windows and injure themselves. ◀

## MINI CONVERTIBLE: CONVERTIBLE TOP WITH INTEGRATED SLIDING SUN- ROOF

If possible, conserve the battery by only operating the convertible top while the engine is running.

Before closing the convertible top, remove all foreign objects from the windshield frame as these could prevent the top from closing properly.

### Opening and closing the sliding sunroof

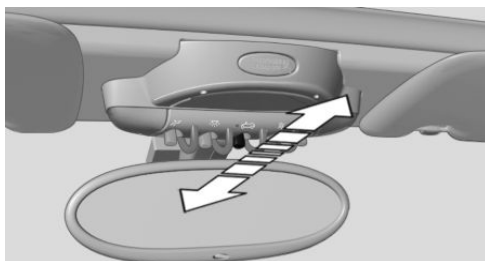

To open:

Press the switch back until the desired position or the end position is reached.

To close:

Press the switch forward.

The sliding sunroof can be opened or closed at vehicle speeds up to 74 mph/120 km/h.

### Electrical convertible top

The fully-automatic convertible top combines reliable weather protection with simple and convenient operation.

To ensure that you will continue to enjoy your MINI Convertible, here are a few tips:

- ▷ It is advisable that you close the convertible top when you park the vehicle. Not only does the closed convertible top protect the vehicle interior against unanticipated weather damage, it also offers a certain

amount of theft protection. However, even when the convertible top is closed, valuables should only be stored in the locked cargo area.

- ▷ Do not attach roof rack systems to the convertible top.
- ▷ If you open the convertible top while it is wet, e.g., after driving in the rain, water may drip into the cargo area. If necessary, remove items from the cargo area beforehand to avoid water stains or soiling.



Safety notes on the convertible top

- ▷ At temperatures below +10 °F/-12 °C, do not move the convertible top or else damage could result.
- ▷ Do not leave the convertible top open for longer than one day while it is wet; otherwise, damage could be caused by the moisture.
- ▷ Do not place any objects on the convertible top; otherwise, they could fall during operation of the convertible top and cause damage or injury.
- ▷ The convertible top pivots up when it is opened and closed. When moving the convertible top in places like garages, ensure that there is a minimum height of 79 inches/2 meters; otherwise, damage could result.
- ▷ When the rollover protection system is extended, do not move the convertible top under any circumstances.
- ▷ Always carry out the convertible top movement to the end. Driving when the convertible top is not fully opened or closed may result in damage or injury.
- ▷ During opening and closing, ensure that people cannot be injured by the convertible top frame or other moving parts. Keep children away from the opening path of the convertible top.

- ▷ For safety reasons, only move the convertible top while the vehicle is stationary, if possible.
- ▷ Do not place any objects on the convertible top; otherwise, they could fall during operation of the convertible top and cause damage or injury. ◀

### Before opening and closing

- ▷ Follow the above-mentioned safety instructions.
- ▷ Ensure that the cargo cover is in the lower position, refer to page 116; otherwise, the convertible top cannot be opened.
- ▷ Ensure that cargo does not push against the cargo cover from underneath.
- ▷ Ensure that the tailgate is closed.

### Opening and closing the convertible top

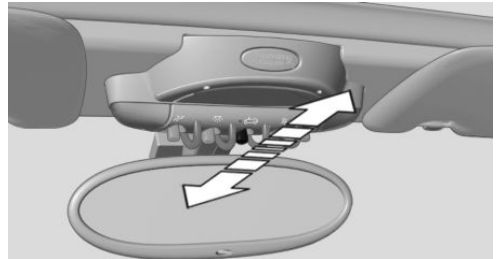

To open:

Press the switch back to open the sliding sunroof. Press it again to open the convertible top.

To close:

Press the switch forward.

### Operation while driving

The convertible top can be opened or closed while driving at vehicle speeds up to approx. 20 mph/30 km/h.



Pay close attention to the traffic

When operating the convertible top while driving, pay extra attention to the traffic to avoid an accident. If possible, do not move the convertible top while driving in reverse because your view to the rear is severely limited during the procedure. Do not operate the convertible top while the vehicle is moving through curves, on uneven road surfaces, or in wind. ◀

### For better control

- ▷ The LED lights up while the convertible top is activated until the top is fully opened or closed.
- ▷ The LED flashes after the switch is released. The opening or closing procedure is not yet fully completed. The sequence can be continued in the desired direction by pushing or pulling the switch.
- ▷ The "convertible top not locked" indicator lamp lights up and a message appears on the Control Display.

### Interruption



Danger

A convertible top that is not fully opened or closed is a source of danger. ◀

The automatic sequence of movements is interrupted immediately if the switch for convertible top operation is released. The sequence can be continued in the desired direction by pushing or pulling the switch.

When the opening or closing procedure is interrupted because the switch is released, the convertible top remains in the position in which it stopped for a few seconds before it slowly moves to a stable position. The sequence can be continued using the switch.

The opening or closing procedure is also interrupted when it is blocked mechanically. To be

able to reactivate the convertible top in this case:

1. Switch the ignition off and on again.
2. Press the switch to continue the sequence in the desired direction.

### Opening and closing procedure



Do not interrupt the closing procedure

Do not interrupt and resume the closing procedure several times in close succession as this could damage the convertible top mechanism. ◀

If, after having been activated a number of times in close succession, the convertible top can only be moved in one direction, the convertible top system is overheated. Let the system cool for approx. 4 minutes.

If the battery was disconnected, for example to change the battery or to put the vehicle into storage, reinitialize, refer to page 41, the power windows; otherwise, the windows will not be lowered, and it will not be possible to open the convertible top.

### Convenient opening and closing

Convenient operation is possible via the remote control, refer to page 32, and the door lock, refer to page 34.

### Manual closing in case of electrical malfunction



Only close the convertible top manually if there is an electrical malfunction

Only close the convertible top manually if this is absolutely necessary; never open it manually. Damage may occur if incorrectly operated. The closing procedure must be fully completed; otherwise, there is a risk of injury or damage. ◀

### Before closing

1. Take the hex key and screwdriver out of the onboard vehicle tool kit, refer to page 243.

2. Pry out the trunk lamp in the left side trim using the screwdriver, arrow.

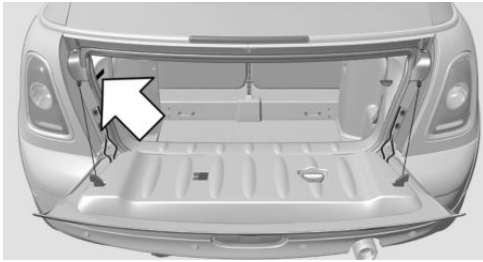

3. Pull the sensor out of the cover, arrow, and set it down on the inside side trim.

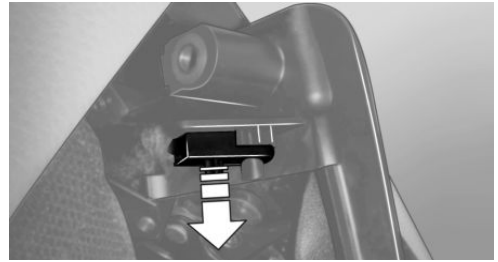

3. Using the screwdriver, unscrew the gold-colored screw by approx. one and a half turns.

4. Release the second screw, arrow, using the hex key to unlock the convertible top.

### Unlocking the convertible top

1. Release the screw, arrow, using the hex key and take it out.

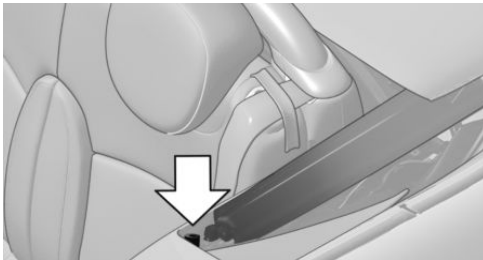
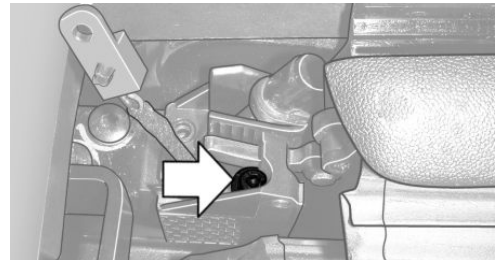

5. Take out the screw.
6. Lift the side frame slightly, arrow 1, and pull the sensor and cable forward out of the guide.
7. Pivot the cable out sideways, arrow 2. When setting it down, ensure that the cable is not pinched.

2. Slide the cover in the direction of travel, arrow 1, and twist it out sideways, arrow 2. If necessary, push the plastic trim, arrow 3, inward slightly.

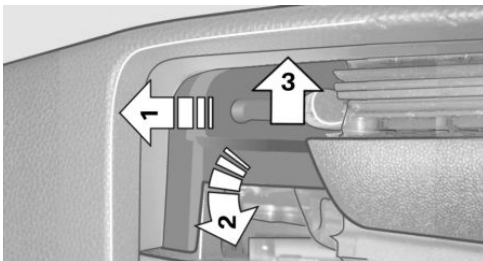
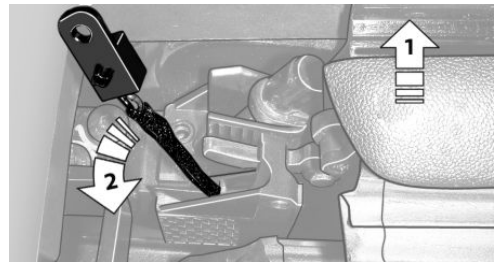

8. Unlock the second side frame.

### Closing the convertible top

1. Hold on to the convertible top on the respective side frames with both hands.

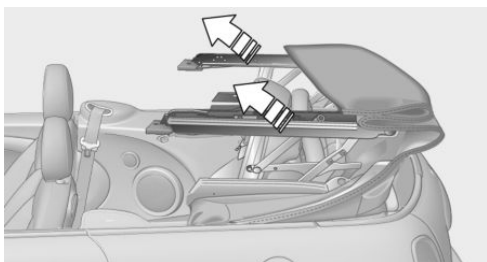

2. Lift it out on both sides and pivot it forward onto the cowl.
3. In the vehicle, pry out the cover in the middle of the roof using the screwdriver.

### Closing the sliding sunroof

1. Insert the hex key into the opening designed for this purpose in the middle of the roof and press upward, arrow 1.

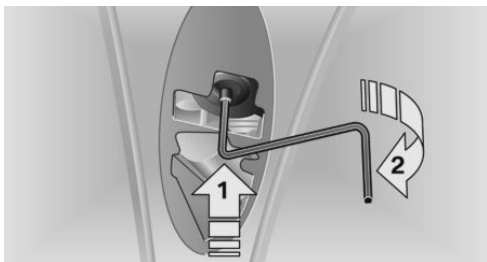

2. Turn the hex key in the direction of arrow 2.
3. Open the two locks and take off the locking pieces.

Ensure that the locking pieces do not fall onto the vehicle, as this could cause damage.

4. Insert the pins into the respective mount on the cowl, arrow.

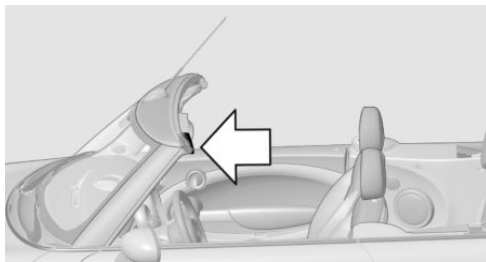

### Locking the convertible top

Turn the hex key opposite to the direction of arrow 2 until the convertible top is locked.

Please contact your service center to eliminate the malfunction.

## MINI CONVERTIBLE: WIND DEFLECTOR

The wind deflector keeps air movements in the passenger compartment to a minimum when the convertible top is open and provides an even more comfortable ride, even at high speeds.

Do not allow pointed object to come into contact with the wind deflector as these may damage the net. Do not place any objects on the installed wind deflector. When stowing, make sure that the wind deflector is not damaged by objects.

### Before installing

1. Take the wind deflector out of the pouch.

2. Unfold the wind deflector, see arrows.

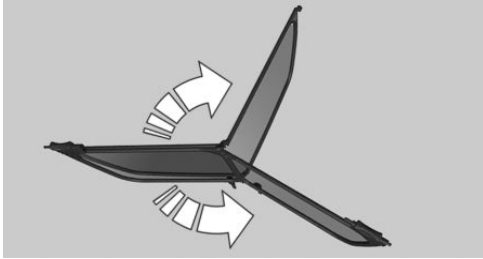

3. Push together the catches until they engage, see arrows.

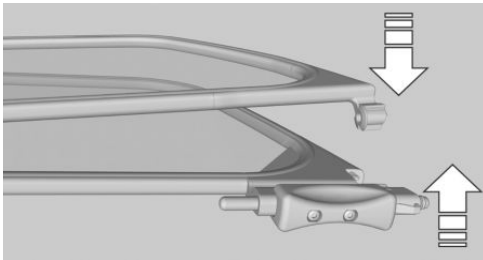

### Mounting and unfolding

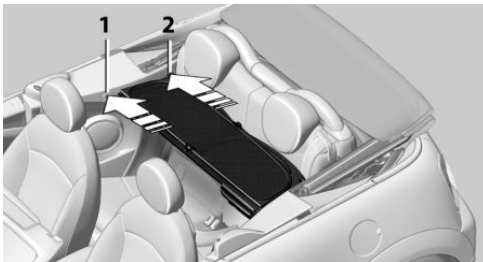

1. Push out retaining pin 2 on one side until it engages.
2. Insert the retaining pins of the wind deflector into the provided openings 1 and 2 on this side of the vehicle.
3. Push back retaining pin 1 against the spring force on the other side of the vehicle and insert it in the provided opening.

4. Push out retaining pin 2 until it engages.
5. Fold up the upper part of the wind deflector.

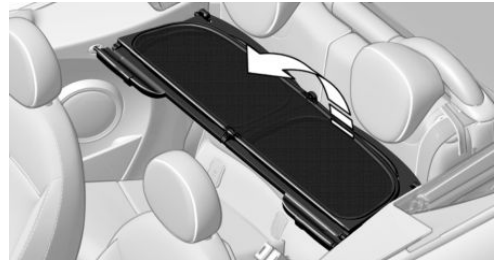

**!** Do not damage the wind deflector  
In the rearmost seat position, do not incline the backrest too far back; otherwise, the wind deflector could be damaged. ◀

### Removing and folding up

The unit is removed in the reverse order from which it was mounted.

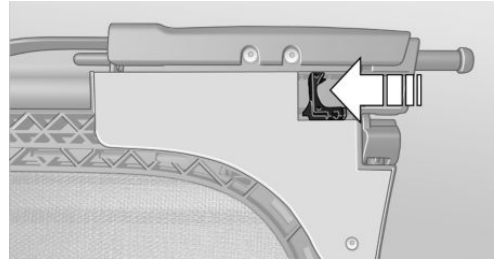

Push the unlocking lever to the middle of the wind deflector and fold up both halves.

## MINI ROADSTER: MANUAL CONVERTIBLE TOP

### General information

The fabric convertible top combines reliable weather protection with simple and convenient operation.

To ensure that you will continue to enjoy your MINI Convertible, here are a few tips:

- ▷ It is advisable that you close the convertible top when you park the vehicle. Not only does the closed convertible top protect the vehicle interior against unanticipated weather damage, it also offers a certain amount of theft protection. However, even when the convertible top is closed, valuables should only be stored in the locked cargo area.
- ▷ Do not attach roof rack systems to the convertible top.



#### Safety notes on the convertible top

- ▷ Do not leave the convertible top open for longer than one day while it is wet; otherwise, damage could be caused by the moisture.
- ▷ Do not place any objects on the convertible top; otherwise, they could fall during operation of the convertible top and cause damage or injury.
- ▷ The convertible top pivots up when it is opened and closed. When moving the convertible top in places like garages, ensure that there is a minimum height of 79 inches/2 meters; otherwise, damage could result.
- ▷ Always carry out the convertible top movement to the end. Driving when the convertible top is not fully opened or closed may result in damage or injury.
- ▷ During opening and closing, ensure that people cannot be injured by the convertible top frame or other moving parts. Keep children away from the opening path of the convertible top.
- ▷ For safety reasons, only move the convertible top while the vehicle is stationary, if possible.

- ▷ Do not place any objects on the convertible top; otherwise, they could fall during operation of the convertible top and cause damage or injury. ◀

## Opening

1. Fold out the handle and turn it all the way to the end, arrow.



2. Push the unlocked convertible top upward at the handle and open it about a hand's width.
3. Exit the vehicle.
4. Guide the convertible top to the rear.

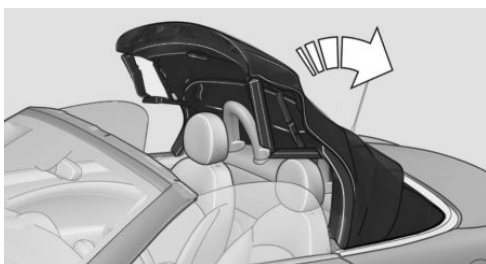

5. Push down on the convertible top with some momentum until it engages audibly.

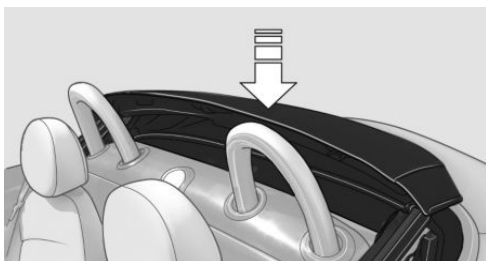



## Closing

1. Switch the ignition on so that the windows can be slightly lowered automatically. Remove the wind deflector if necessary.

2. Press button 1.

The convertible top is unlocked and moves up slightly.

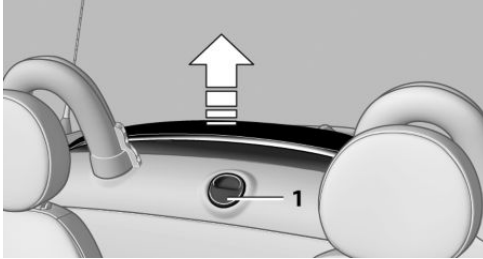

3. Exit the vehicle.
4. Guide the convertible top forward.
5. Pull the convertible top onto the windshield frame.
6. Turn the handle clockwise until it engages audibly.

The convertible top is locked.

If the convertible top was open for a lengthy period, it may be necessary to apply greater force when locking the top.

7. Fold the handle back in.

## MINI ROADSTER: SEMI-AUTOMATIC CONVERTIBLE TOP

### General information

The fabric convertible top combines reliable weather protection with simple and convenient operation.

To ensure that you will continue to enjoy your MINI Convertible, here are a few tips:

- ▷ It is advisable that you close the convertible top when you park the vehicle. Not only does the closed convertible top protect the

vehicle interior against unanticipated weather damage, it also offers a certain amount of theft protection. However, even when the convertible top is closed, valuables should only be stored in the locked cargo area.

- ▷ Do not attach roof rack systems to the convertible top.



Safety notes on the convertible top

- ▷ At temperatures below +14 °F/-10 °C, do not move the convertible top or else damage could result.
- ▷ Do not leave the convertible top open for longer than one day while it is wet; otherwise, damage could be caused by the moisture.
- ▷ Do not place any objects on the convertible top; otherwise, they could fall during operation of the convertible top and cause damage or injury.
- ▷ The convertible top pivots up when it is opened and closed. When moving the convertible top in places like garages, ensure that there is a minimum height of 79 inches/2 meters; otherwise, damage could result.
- ▷ When the rollover protection system is extended, do not move the convertible top under any circumstances.
- ▷ Always carry out the convertible top movement to the end. Driving when the convertible top is not fully opened or closed may result in damage or injury.
- ▷ During opening and closing, ensure that people cannot be injured by the convertible top frame or other moving parts. Keep children away from the opening path of the convertible top.
- ▷ For safety reasons, only move the convertible top while the vehicle is stationary, if possible. ◀

## Operation while driving

The convertible top can be opened or closed while driving at vehicle speeds up to approx. 20 mph/30 km/h.

 Pay close attention to the traffic

When operating the convertible top while driving, pay extra attention to the traffic to avoid an accident. If possible, do not move the convertible top while driving in reverse because your view to the rear is severely limited during the procedure. Do not operate the convertible top while the vehicle is moving through curves, on uneven road surfaces, or in wind. ◀

## For better control

 The indicator lamp lights up. Movement of the convertible top is completed. The convertible top is fully opened.

 The indicator lamp lights up. Movement of the convertible top is completed. Close the convertible top using the handle.

## Malfunction

The "convertible top not locked" indicator lamp lights up and a message appears on the Control Display.

## Interruption

 **Danger**  
A convertible top that is not fully opened or closed is a source of danger. ◀

The automatic sequence of movements is interrupted immediately if the switch for convertible top operation is released. The sequence can be continued in the desired direction by pushing or pulling the switch.

When the opening or closing procedure is interrupted because the switch is released, the convertible top remains in the position in which

it stopped. The sequence can be continued using the switch.

The opening or closing procedure is also interrupted when it is blocked mechanically. To be able to reactivate the convertible top in this case:

1. Switch the ignition off and on again.
2. Press the switch to continue the sequence in the desired direction.

## Opening and closing the convertible top

Switch on the radio ready state or the ignition, refer to page 64.

If possible, conserve the battery by only operating the convertible top while the engine is running.

Before closing the convertible top, remove all foreign objects from the windshield frame that could prevent the top from closing properly.

## Opening

1. Fold out the handle and turn it all the way to the end, arrow.



2. Push the unlocked convertible top upward at the handle and open it about a hand's width.

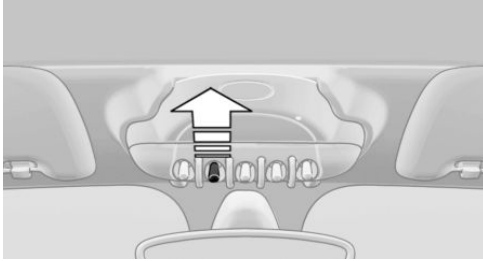

3. Press the switch back to open the convertible top. The windows opens during this procedure.

### Closing

1. Press the switch forward.

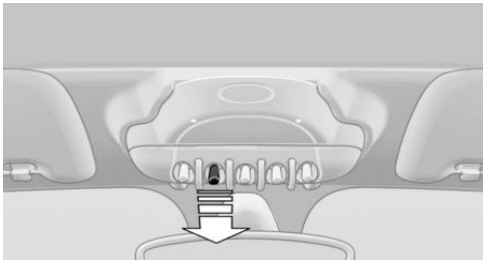

2. Pull the convertible top onto the windshield frame.
3. Turn the handle clockwise until it engages audibly.

The convertible top is locked.

If the convertible top was open for a lengthy period, it may be necessary to apply greater force when locking the top.

4. Fold the handle back in.
5. Close the windows if necessary.

### Manual closing in case of electrical malfunction

 Only close the convertible top manually if there is an electrical malfunction

Only close the convertible top manually if this is absolutely necessary; never open it manually. Damage may occur if incorrectly operated. The closing procedure must be fully completed; otherwise, there is a risk of injury or damage. ◀

### Before closing

Lower the side windows slightly, switch off the engine, and switch off the ignition.

1. Take out the cover plate, refer to page 116.
2. Take out the cargo area insert, arrow.

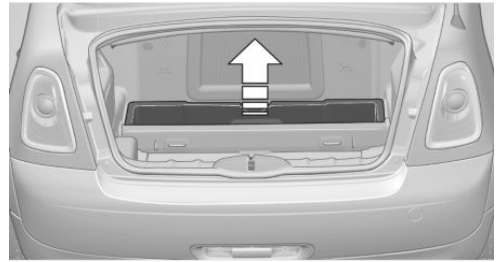

3. Using the hex key from the onboard vehicle tool kit, unscrew the gold-colored screw, see arrow, all the way to the stop, approx. four to five turns.

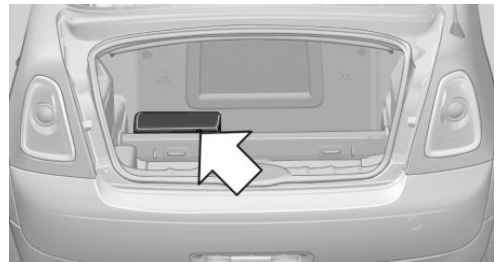

## Closing

1. Hold on to the convertible top frame and guide it to the windshield frame.
2. Fold out the handle and turn it counter-clockwise all the way to the stop.
3. Pull the convertible top onto the windshield frame.
4. Turn the handle clockwise until it engages audibly.

The convertible top is locked.

## MINI ROADSTER: WIND DEFLECTOR

The wind deflector keeps air movements in the passenger compartment to a minimum when the convertible top is open and provides a comfortable ride, even at high speeds.

Do not allow pointed object to come into contact with the wind deflector as these may damage the net.

### Before installing

1. Take the wind deflector out of the storage pouch.
2. Unfold the wind deflector, arrow.

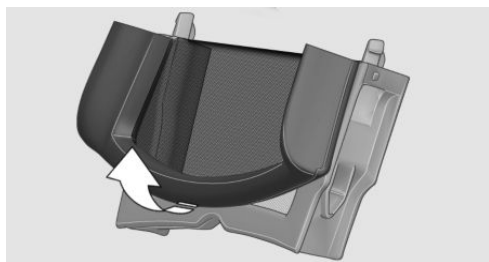

## Installation

1. Insert the wind deflector with parts 1 facing back into the holders 2 on the rollover bars.

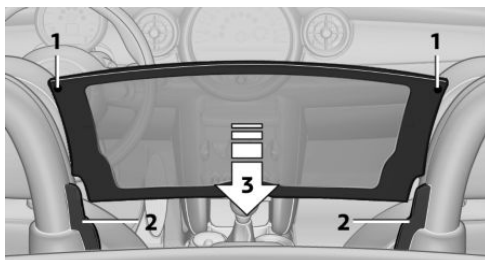

2. Push the wind deflector down until it engages, arrow 3.



Attach the wind deflector properly

The wind deflector must be firmly engaged; otherwise, it may come lose from the fixations at high speeds. ◀

## Removing

The unit is removed in the reverse order from which it was mounted. Pull the wind deflector upward out of the holders.

## Storage

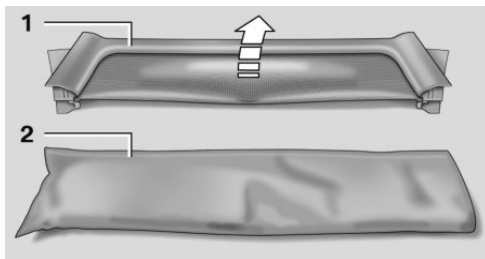

Fold up the wind deflector 1 and slide it into the storage pouch 2.

The wind deflector can be stored on the rear storage shelf behind the seats, refer to page 120.

# ADJUSTING

## VEHICLE EQUIPMENT

This chapter describes all series equipment as well as country-specific and special equipment offered for this model series. Therefore, it also describes equipment that may not be found in your vehicle, for instance due to the selected special equipment or the country version. This also applies to safety-related functions and systems.

## SITTING SAFELY

The ideal seating position can make a vital contribution to relaxed, fatigue-free driving.

The seating position plays an important role in an accident in combination with:

- ▷ Safety belts, refer to page 55.
- ▷ Head restraints, refer to page 56.
- ▷ Airbags, refer to page 90.

## SEATS

### Note before adjusting

 Do not adjust the seat while driving. Never attempt to adjust the driver's seat while driving. The seat could respond with unexpected movement and the ensuing loss of vehicle control could lead to an accident. ◀

 Do not incline the backrest too far to the rear

Do not incline the backrest on the front passenger side too far to the rear during driving. Otherwise, there is the danger of sliding under the safety belt in an accident. This would eliminate the protection normally provided by the belt. ◀

### Seat adjustment

#### Forward/backward



Pull the lever, arrow 1, and slide the seat into the desired position, arrows 2.

After releasing the lever, move the seat forward or back slightly to make sure it engages properly.

#### Height

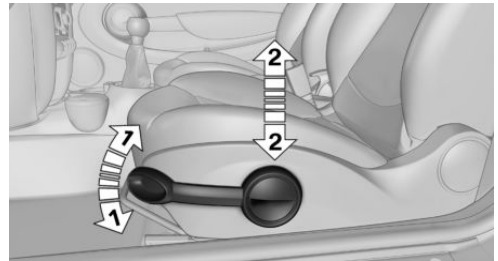

Pull the lever up or push it down repeatedly, arrows 1, until the desired height is reached, arrows 2.

## Backrest tilt

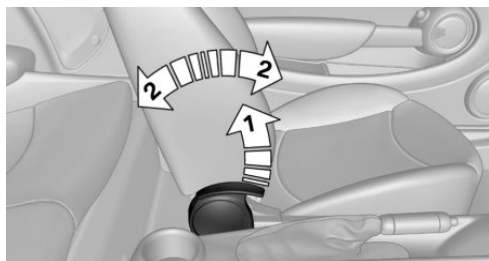

Pull the lever, arrow 1, and apply your weight to the backrest or lift it off, as necessary, arrows 2.

## Lumbar support

You can also adjust the contour of the backrest to obtain additional support in the lumbar region.

The upper hips and spinal column receive supplementary support to help you maintain a relaxed, upright sitting position.

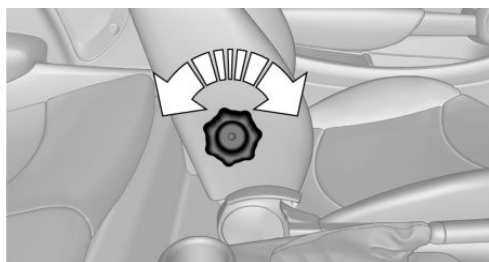

Turn the wheel to increase or decrease the curvature.

## Entry in the rear

MINI Convertible: entry in the rear.

MINI Coupe, MINI Roadster: access to the rear storage shelf.

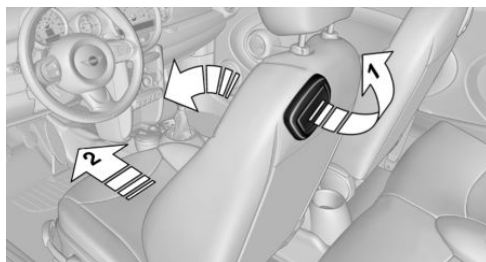

1. Pull the lever on the back of the seat upward, arrow 1.  
The backrest folds forward.
2. Push against the backrest to move the seat forward, arrow 2.

## Restoring the original seat position

The driver's seat has a mechanical memory function for the forward/backward seat setting and the backrest setting.

1. Push the seat back to the original position.  
Do not fold back the backrest until the seat is in its original position; otherwise, the seat will engage in its current position. If this happens, adjust the forward/backward position manually, refer to page 53.
2. Fold back the backrest to lock the seat.

 Note the following when moving back the seat

When moving back the seat, ensure that persons cannot be injured and objects cannot be damaged. Lock the front seats and front backrests before driving away; otherwise, there is the risk of an accident if the seat or backrest moves unexpectedly. ◀

## Seat heating

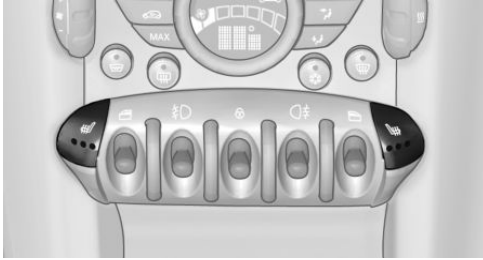

### Switching on

The temperature setting progresses one step through its control sequence each time you press the button. The maximum temperature is reached when three LEDs are lit.

If the trip is continued within approx. 15 minutes, the seat heating is activated automatically with the temperature set last.

The temperature is reduced, if need be, down to no heat in order to reduce the load on the battery. The LEDs remain lit.

### Switching off

Press the button longer.

## SAFETY BELTS

### Number of safety belts

Your vehicle has been fitted with safety belts for the safety of you and your passengers:

- ▷ MINI Coupe, MINI Roadster: two safety belts.
- ▷ MINI Convertible: four safety belts.

### Notes

Always make sure that safety belts are being worn by all occupants before driving away.

Although airbags enhance safety by providing added protection, they are not a substitute for safety belts.

The shoulder strap's anchorage point will be correct for adult seat occupants of every build if the seat is correctly adjusted.



One person per safety belt

Never allow more than one person to wear a single safety belt. Never allow infants or small children to ride on a passenger's lap. ◀



Putting on the belt

Lay the belt, without twisting, snugly across the lap and shoulders, as close to the body as possible. Make sure that the belt lies low around the hips in the lap area and does not press on the abdomen. Otherwise, the belt can slip over the hips in the lap area in a frontal impact and injure the abdomen.

The safety belt must not lie across the neck, rub on sharp edges, be routed over solid or breakable objects, or be pinched. ◀



Reduction of restraining effect

Avoid wearing clothing that prevents the belt from fitting properly, and pull the shoulder belt periodically to readjust the tension across your lap; otherwise, the retention effect of the safety belt may be reduced. ◀

### Buckling the belt

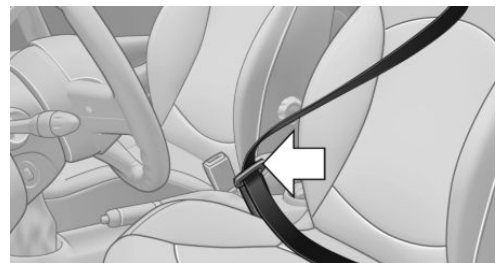

Make sure you hear the latch plate engage in the belt buckle.

The shoulder strap's anchorage point will be correct for adult seat occupants of every build if the seat is correctly adjusted, refer to page 53.

## Unbuckling the belt

1. Hold the belt firmly.
2. Press the red button in the belt buckle.
3. Guide the belt back into its reel.

## MINI Convertible: rear belt guide

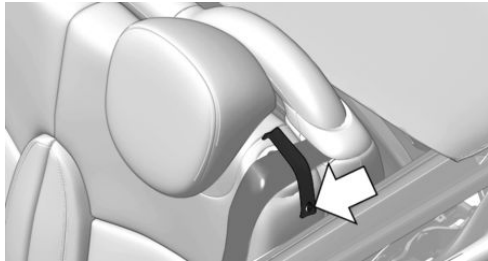

When fastening the safety belts on the rear seats, ensure that the belt guide loop, arrow, is closed.

## Safety belt reminder for driver's seat and front passenger seat



The indicator lamps light up and a signal sounds. In addition, a message appears on the Control Display. Check whether the safety belt has been fastened correctly.



## Damage to safety belts

In the case of strain caused by accidents or damage:

Have the safety belts, including the safety belt tensioners, replaced and have the belt anchors checked.



Checking and replacing safety belts  
Have the work performed only by your service center; otherwise, it cannot be ensured that this safety feature will function properly. ◀

## HEAD RESTRAINTS

### Correctly set head restraint

A correctly adjusted head restraint reduces the risk of spinal injury in the event of an accident.



Adjusting the head restraint

Correctly adjust the head restraints of all occupied seats; otherwise, there is an increased risk of injury in an accident. ◀

### Height

Adjust the head restraint so that its center is approx. at ear level.

### Distance

Adjust the distance so that the head restraint is as close as possible to the back of the head.

### Height adjustment

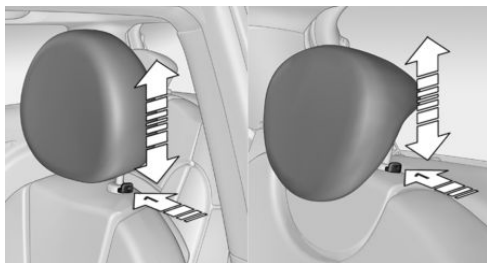

To raise: pull.

To lower: press the button, arrow 1, and push the head restraint down.

### Removing

Only remove the head restraint if no one will be sitting in the seat in question.

1. Pull upward as far as possible.
2. Press the button, arrow 1, and pull the head restraint out completely.

To remove the head restraint, fold the backrest forward if necessary.





Before transporting passengers

Reinstall the head restraint before transporting anyone in the seat; otherwise, the protective function of the head restraint is unavailable. ◀

## MIRRORS

### Exterior mirrors

#### General information

The mirror on the passenger side is more curved than the driver's mirror.



Estimating distances correctly

Objects reflected in the mirror are closer than they appear. Do not estimate the distance to the traffic behind you based on what you see in the mirror, as this will increase your risk of an accident. ◀

#### At a glance



- 1 Setting the left or right exterior mirror
- 2 Folding the mirror in and out

#### Adjusting electrically

1. Select the mirror by turning the knob to the respective position 1.
2. To adjust the mirror, move the knob in the desired direction: to the front, rear, left, or right.

#### Adjusting manually

If an electrical malfunction occurs, for example, press the edges of the mirror glass.

#### Folding the mirror in and out

Turn the knob past the resistance point in direction 2.

The mirror can be folded in up to a vehicle speed of approx. 20 mph/30 km/h.

For example, this is advantageous

- ▷ In car washes.
- ▷ In narrow streets.
- ▷ For folding back mirrors that were folded away manually.



Fold in the mirror in a car wash

Before entering an automatic car wash, fold in the exterior mirrors by hand or with the button; otherwise, they could be damaged, depending on the width of the vehicle. ◀

#### Automatic heating

Both exterior mirrors are heated automatically while the engine is running or the ignition is switched on when the external temperature is below a certain value.

#### Interior rearview mirror



To reduce the blinding effect from the rear when driving at night: turn the knob.

## Interior rearview and exterior mirrors, automatic dimming feature

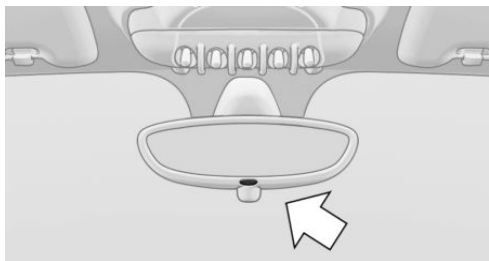

Two photocells are used for control:

- ▷ In the mirror frame, see arrow.
- ▷ On the back of the mirror.

For proper operation:

- ▷ Keep the photocells clean.
- ▷ Do not cover the area between the inside rearview mirror and the windshield.
- ▷ Do not apply stickers to the windshield in front of the mirror.

2. Move the steering wheel to the preferred height and angle to suit your seating position.
3. Fold the lever back.



Do not use force to swing the lever back. Do not use force to swing the lever back up; otherwise, the mechanism will be damaged. ◀

## STEERING WHEEL

### Adjusting



Do not adjust while driving. Do not adjust the steering wheel while driving; otherwise, an unexpected movement could result in an accident. ◀

1. Fold the lever down.

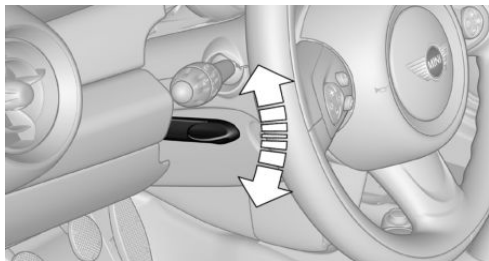

# TRANSPORTING CHILDREN SAFELY

## VEHICLE EQUIPMENT

This chapter describes all series equipment as well as country-specific and special equipment offered for this model series. Therefore, it also describes equipment that may not be found in your vehicle, for instance due to the selected special equipment or the country version. This also applies to safety-related functions and systems.

## THE RIGHT PLACE FOR CHILDREN

### Notes

 Children in the vehicle

Do not leave children unattended in the vehicle; otherwise, they could endanger themselves and other persons, e.g., by opening the doors. ◀

### MINI Convertible: children should always be in the rear

Accident research shows that the safest place for children is on the rear seat.

 Transporting children in the rear

Transport children younger than 13 years of age or shorter than 5 ft/150 cm in the rear only, using child restraint fixing systems suitable for the age, weight, and height of the child; otherwise, there is an increased risk of injury in an accident.

Children 13 years of age or older must wear a safety belt as soon as a suitable child restraint fixing system can no longer be used, due to their age, weight and size. ◀

 Installing child seats

Only install child seats in the rear when the rear seat backrest is folded all the way back and engaged; otherwise, there is an increased risk of injury in an accident. ◀

### Children on the front passenger seat

#### Front passenger airbags

Should it be necessary to use a child restraint fixing system on the front passenger seat, make sure that the front and side airbags on the front passenger side are deactivated, refer to page 91.

 Deactivating the front passenger airbags

If a child restraint fixing system is used in the front passenger seat, the front passenger airbags must be deactivated; otherwise, there is an increased risk of injury to the child when the airbags are triggered, even with a child restraint fixing system. ◀

## INSTALLING CHILD RESTRAINT FIXING SYSTEMS

### Notes

 Manufacturer's information for child restraint fixing systems

To select, mount and use child restraint fixing systems, observe the information provided by the system manufacturer; otherwise, the protective effect can be impaired. ◀

### On the front passenger seat

#### Deactivating the airbags

After installing a child restraint fixing system on the front passenger seat, ensure that the front

and side airbags on the front passenger side are deactivated.

**⚠** Deactivating the front passenger airbags

If a child restraint fixing system is used in the front passenger seat, the front passenger airbags must be deactivated; otherwise, there is an increased risk of injury to the child when the airbags are triggered, even with a child restraint fixing system. ◀

### Seat position and height

Before installing a child restraint fixing system, move the front passenger seat as far back as possible and adjust its height to the highest position to obtain the best possible position for the belt and to offer optimal protection in the event of an accident.

Do not change this seat position once it has been set.

### Child seat security

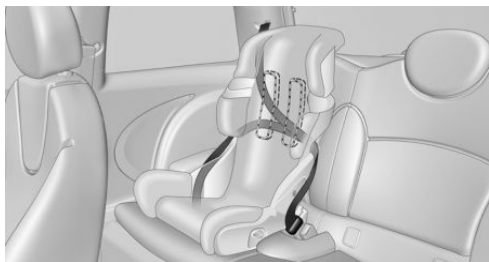

### MINI Coupe, MINI Roadster



The safety belt for the passenger can be locked to prevent it from being pulled out when it is used to secure child restraint systems.

### MINI Convertible

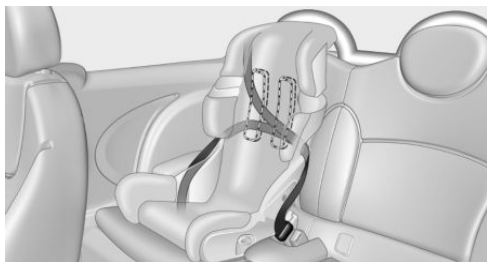

All rear safety belts and the safety belt for the front passenger can be locked to prevent extension in order to permit attachment of child restraint fixing systems.

### To lock the safety belt

1. Secure the child restraint fixing system with the belt.
2. Pull out the belt webbing completely.
3. Allow the belt webbing to be pulled in and pull it taut against the child restraint fixing system.

The safety belt is locked.

### To unlock the safety belt

1. Open the belt buckle.
2. Remove the child restraint fixing system.

3. Allow the belt webbing to be pulled in completely.  
Pass the safety belt to the holder on the headliner.

## MINI CONVERTIBLE: LATCH CHILD RESTRAINT FIXING SYSTEM

LATCH: Lower Anchors and Tethers for Children.

### Notes

 Manufacturer's information for LATCH child restraint fixing systems

To mount and use the LATCH child restraint fixing systems, observe the operating and safety information from the system manufacturer; otherwise, the level of protection may be reduced. ◀

### Mounts for the lower LATCH anchors

The lower anchors may be used to attach the CRS to the vehicle seat up to a combined child and CRS weight of 65 lb/30 kg when the child is restrained by the internal harnesses.

 Correctly engage the lower LATCH anchors

Make sure that the lower LATCH anchors have properly engaged and that the child restraint fixing system is resting snugly against the backrest; otherwise, the degree of protection offered may be reduced. ◀

Before installing the child seat, pull the belt out of the area for the child restraint fixing system.

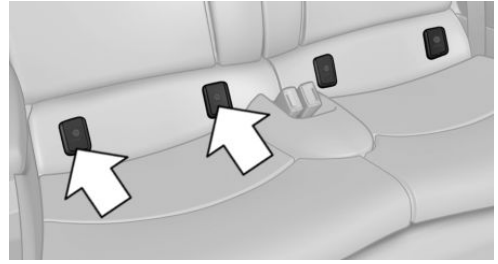

The mounts for the lower LATCH anchors are located behind the indicated cover caps.

### Mounting LATCH child restraint fixing systems

1. Mount the child restraint fixing system; refer to the operating instructions of the system.
2. Ensure that both LATCH anchors are properly connected.

## CHILD RESTRAINT FIXING SYSTEM WITH A TETHER STRAP

### Mounting points

 LATCH mounting eyes  
Only use the mounting eyes for the upper LATCH retaining strap to secure child restraint fixing systems; otherwise, the mounting eyes could be damaged. ◀

MINI Coupe



There is one additional mounting point for child restraint fixing systems with a tether strap, arrow.

MINI Convertible:

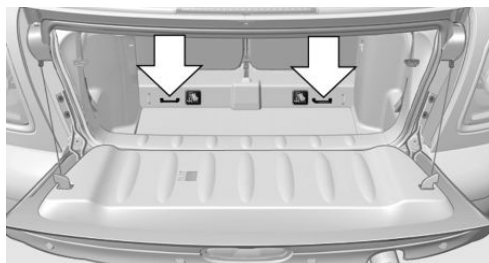

There are two additional mounting points for child restraint fixing systems with a tether strap, arrows.

### Guide of the upper LATCH retaining strap

 Retaining strap

Make sure the upper retaining strap does not run over sharp edges and is not twisted as it passes to the top anchor. Otherwise, the strap will not properly secure the child restraint fixing system in the event of an accident. ◀

MINI Coupe:

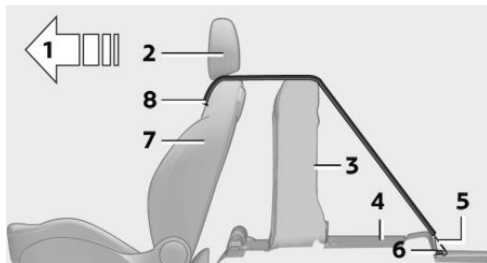

- 1 Direction of travel
- 2 Head restraint
- 3 Separating wall
- 4 Cargo area floor
- 5 Hook for the tether strap
- 6 Mounting point
- 7 Backrest
- 8 Tether strap of the child restraint fixing system

MINI Convertible:

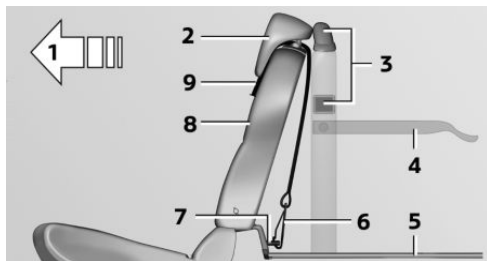

- 1 Direction of travel
- 2 Head restraint
- 3 Rollover protection system with crossbar
- 4 Cargo cover
- 5 Cargo area floor
- 6 Hook for the tether strap
- 7 Mounting point
- 8 Backrest
- 9 Tether strap of the child restraint fixing system

## Attaching the upper retaining strap to the mounting point

### MINI Coupe

1. Remove the front cargo cover, refer to page 115.
2. Slide the head restraint upward.
3. Guide the tether strap between the head restraint supports.
4. Hook in the tether strap on the mounting point with the hook.
5. Slide the head restraint into the bottom position.
6. Pull the tether strap taut.

### MINI Convertible

Ensure that the upper retaining strap 9 is passed between backrest 8 and rollover protection system with crossbar 3; otherwise, it will be unable to properly restrain the child restraint fixing system.

1. Slide the head restraint upward.
2. Unlock the backrest and fold it forward slightly, refer to page 117.
3. Guide the tether strap between the head restraint supports.
4. Hook in the tether strap on the mounting point with the hook.
5. Fold back the backrest and lock it. Slide the head restraint down as far as possible.
6. Pull the tether strap taut.

# DRIVING

## VEHICLE EQUIPMENT

This chapter describes all series equipment as well as country-specific and special equipment offered for this model series. Therefore, it also describes equipment that may not be found in your vehicle, for instance due to the selected special equipment or the country version. This also applies to safety-related functions and systems.

## IGNITION LOCK

### Insert the remote control into the ignition lock

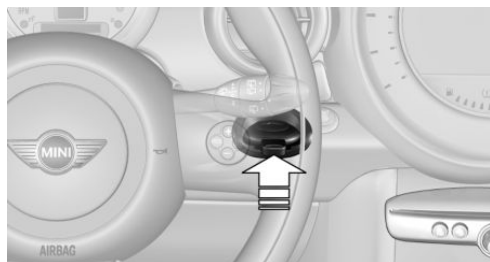

Insert the remote control all the way into the ignition lock.

Radio ready state is switched on. Individual electrical consumers can operate.

### Removing the remote control from the ignition lock

 Do not forcibly pull the remote control out of the ignition lock

Do not forcibly pull the remote control out of the ignition lock as this may cause damage. ◀

Before removing the remote control, push it all the way in to release the locking mechanism.

The ignition is switched off if it was on.

### Automatic transmission

You can only take out the remote control if transmission position P is engaged: interlock.

## START/STOP BUTTON

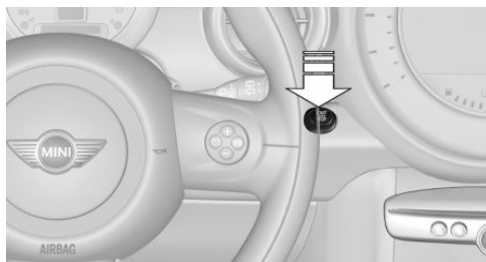

Pressing the Start/Stop button switches the ignition on or off and starts the engine.

The engine starts when the Start/Stop button is pressed and:

- ▷ Manual transmission: the clutch is depressed.
- ▷ Automatic transmission: the brake is depressed.

### Radio ready state

Individual electrical consumers can operate.

Radio ready state is switched off automatically:

- ▷ When the remote control is removed from the ignition lock.
- ▷ With Comfort Access, refer to page 37, by pressing the button on the door handle or the  button on the remote control.
- ▷ After a certain period of time.

### Ignition on

All electrical consumers can operate. Most indicator and warning lamps light up for different lengths of time.



To save battery power when the engine is off, switch off the ignition and any unnecessary electronic systems/power consumers.

### Radio ready state and ignition off

All indicator and warning lamps in the displays go out.

The ignition switches off automatically when the driver's door is opened. Pressing the Start/Stop button again switches the ignition back on.

For example, the ignition is not switched off in the following situations:

- ▷ Depress the clutch or brake pedal.
- ▷ The low beams are switched on

## STARTING THE ENGINE

### General information



#### Enclosed areas

Do not let the engine run in enclosed areas; otherwise, breathing of exhaust fumes may lead to loss of consciousness and death. The exhaust gases contain carbon monoxide, an odorless and colorless but highly toxic gas. ◀



#### Unattended vehicle

Do not leave the car unattended with the engine running; otherwise, it presents a potential source of danger.

Before leaving the car with the engine running, shift to neutral or engage transmission position P and set the handbrake firmly; otherwise, the vehicle may begin to roll. ◀



#### Frequent starting in quick succession

Avoid repeated futile attempts at starting the car and avoid starting the car frequently in quick succession. Otherwise, the fuel is not burned or is inadequately burned, and there is the danger of overheating and damaging the catalytic converter. ◀

Do not wait for the engine to warm-up while the vehicle remains stationary; start driving right away, but at moderate engine speeds.

Do not depress the accelerator when starting the engine.

### Starting the engine

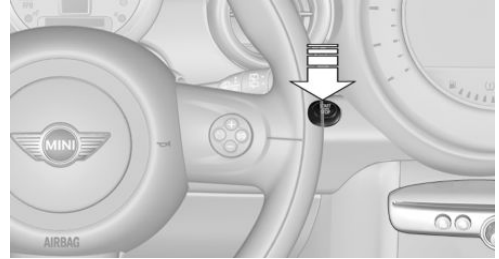

### Manual transmission

Remote control in the ignition lock or, with Comfort Access, inside the vehicle, refer to page 37.

1. Depress the brake pedal.
2. Depress the clutch pedal.
3. Press the Start/Stop button.

The ignition is activated automatically for a certain time and is stopped as soon as the engine starts.

### Automatic transmission

Remote control in the ignition lock or, with Comfort Access, inside the vehicle, refer to page 37.

1. Depress the brake pedal.
2. Move the selector lever to position P or N.
3. Press the Start/Stop button.

The ignition is activated automatically for a certain time and is stopped as soon as the engine starts.

## ENGINE STOP

### General information

 Take the remote control with you when leaving the vehicle so that children, for example, cannot operate the windows and injure themselves. ◀

 Set the handbrake and further secure the vehicle as required

Set the handbrake firmly when parking; otherwise, the vehicle may roll. On steep upward and downward inclines, further secure the vehicle, for example, by turning the steering wheel in the direction of the curb. ◀

### Before driving into a car wash

To make it possible for the vehicle to roll in an automatic car wash, follow the information on Washing in automatic car washes, refer to page 259.

### Switching off the engine

#### Manual transmission

1. With the vehicle at a standstill, press the Start/Stop button.
2. Shift into first gear or reverse.
3. Set the handbrake firmly.
4. Remove the remote control from the ignition lock.

#### Automatic transmission

1. Engage transmission position P with the vehicle stopped.
2. Press the Start/Stop button.
3. Set the handbrake firmly.
4. Remove the remote control from the ignition lock.

## HANDBRAKE

### The concept

The handbrake is primarily intended to prevent the vehicle from rolling while parked; it brakes the rear wheels.

Also follow the instructions under Switching off the engine, refer to page 66.

### Setting

The lever engages automatically.

### Releasing

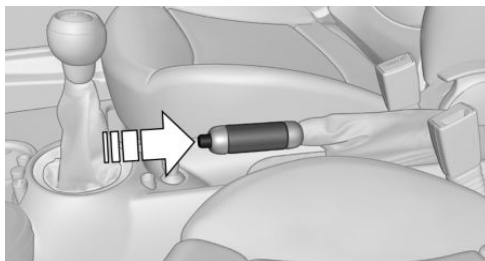

Pull up slightly, press the button, and lower the lever.

### Notes

 Using the handbrake while driving  
If it should become necessary to use the handbrake while driving, do not pull the handbrake too forcefully. Keep the button on the handbrake lever pressed at all times.

Excessive application of the handbrake can block the rear wheels and lead to fishtailing of the vehicle. ◀

The brake lamps do not light up when the handbrake is pulled.

## TURN SIGNAL, HIGH BEAMS, HEADLAMP FLASHER

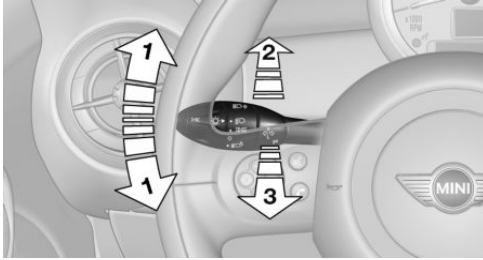

- 1 Turn signal
- 2 Switching on the high beams
- 3 Switching off the high beams/headlamp flasher

### Turn signal

Press the lever beyond the resistance point.  
To switch off manually, press the lever to the resistance point.  
Unusually rapid flashing of the indicator lamp indicates that a turn signal bulb has failed.

### Signaling a turn briefly

Press the lever to the resistance point and hold it there for as long as you want the turn signal to flash.

### Triple turn signal activation

Press the lever to the resistance point.  
The turn signal flashes three times.  
This function can be activated or deactivated:

1. "Settings"
2. "Lighting"

### 3. "Triple turn signal"

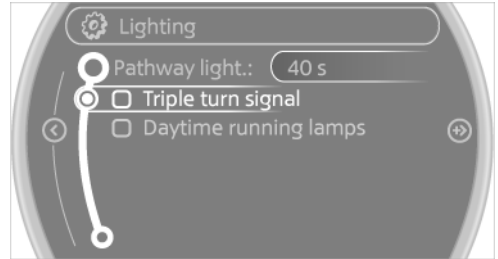

The setting is stored for the remote control currently in use.

## WASHER/WIPER SYSTEM

### Notes

 Do not switch on the wipers if frozen  
Do not switch on the wipers if they are frozen onto the windshield; otherwise, the wiper blades and the windshield wiper motor may be damaged. ◀

 Do not use the wipers on a dry windshield  
Do not use the wipers on a dry windshield; otherwise, the wiper blades may wear more rapidly or become damaged. ◀

### At a glance

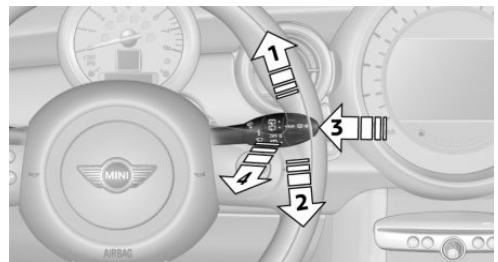

- 1 Switching on wipers
- 2 Switching off wipers or brief wipe

- 3 Activating/deactivating intermittent wipe or the rain sensor
- 4 Cleaning the windshield and headlamps

### Switching on wipers

Press the wiper lever upward, arrow 1.

The lever automatically returns to its initial position when released.

### Normal wiper speed

Press up once.

The system switches to operation in the intermittent mode when the vehicle is stationary.

### Fast wiper speed

Press up twice or press once beyond the resistance point.

The system switches to normal speed when the vehicle is stationary.

### Switching off wipers or brief wipe

Press the wiper lever down, arrow 2.

The lever automatically returns to its initial position when released.

- ▷ Brief wipe: press down once.
- ▷ To switch off normal wipe: press down once.
- ▷ To switch off fast wipe: press down twice.

### Intermittent wipe or rain sensor

If the car is not equipped with a rain sensor, the intermittent-wipe time is a preset.

If the car is equipped with a rain sensor, the time between wipes is controlled automatically and depends on the intensity of the rainfall.

The rain sensor is mounted on the windshield, directly in front of the interior rearview mirror.



Deactivate the rain sensor in car washes

Deactivate the rain sensor when passing through an automatic car wash; otherwise, damage could be caused by undesired wiper activation. ◀

### Activating intermittent wipe or rain sensor

Press the button, arrow 3.



The symbol is shown in the tachometer.

### Setting the sensitivity of the rain sensor

1. Switch on the ignition, refer to page 64.
2. Press the button on the turn indicator lever repeatedly until "SET/INFO" is displayed.

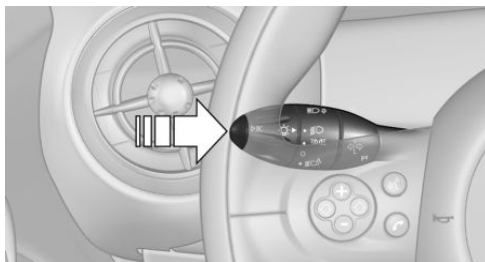

3. Press and hold the button until the display changes.
4. Press the button repeatedly until the symbol and "SET" are displayed.

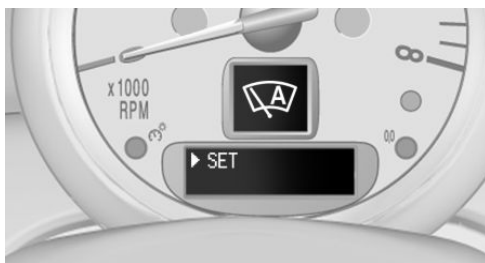

- Press and hold the button until the display changes.



- Press the button to select the desired sensitivity.
- Wait or hold the button until the display changes.

The settings were stored.

### Deactivating intermittent wipe or rain sensor

Press the button again, arrow 3.

### Cleaning the windshield and headlamps

Pull the lever, arrow 4.

The system sprays washer fluid on the windshield and activates the wipers briefly.

When the vehicle lighting system is switched on, the headlamps are cleaned at regular and appropriate intervals.

 Do not use the washer system at freezing temperatures

Do not use the washers if there is any danger that the fluid will freeze on the windshield; otherwise, your vision could be obscured. For this reason, use antifreeze.

Avoid using the washer when the reservoir is empty; otherwise, you could damage the pump. ◀



Do not use the washing facilities when the hood is open

Only use the washing facilities when the hood is fully locked; otherwise, the headlamp washer system may become damaged. ◀

### Windshield washer nozzles

The windshield washer nozzles are heated automatically while the engine is running or the ignition is switched on.

## WASHER FLUID

### General information



Antifreeze for washer fluid

Antifreeze is flammable and can cause injuries if used improperly.

Therefore, keep it away from sources of ignition.

Only keep it in the closed original container and inaccessible to children.

Follow the notes and instructions on the container.

United States: The washer fluid mixture ratio is regulated by the U.S. EPA and many individual states; do not exceed the allowable washer fluid dilution ratios limits that apply. Follow the usage instructions on the washer fluid container. Use BMW's Windshield Washer Concentrate or the equivalent. ◀

### Washer fluid reservoir



Adding washer fluid

Only add washer fluid when the engine is cool, and then close the cover completely to avoid contact between the washer fluid and hot engine parts.

Otherwise, there is the danger of fire and a risk to personal safety if the fluid is spilled. ◀

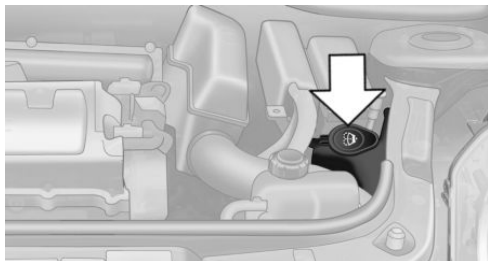

All washer nozzles are supplied from one reservoir.

Fill with a mixture of window washing concentrate and water; if needed, add antifreeze according to the manufacturer instructions.

Mix the washer fluid before adding to maintain the correct mixing ratio.

Do not fill in undiluted window washing concentrate and do not fill in pure water; this could damage the washer system.

Do not mix window washing concentrate from different manufacturers; this could cause the washer nozzles to clog.

### Capacity

Approx. 2.6 US quarts/2.5 liters.

With headlamp washer system:  
4.7 US quarts/4.5 liters.

## MANUAL TRANSMISSION

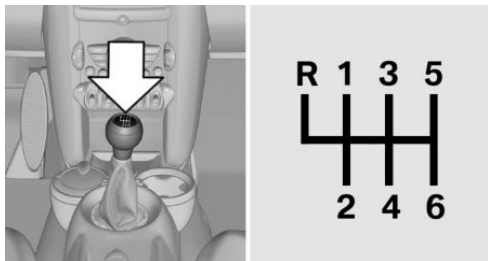

Pay attention to the shift plane

When shifting into 5th or 6th gear, push the gearshift lever to the right; otherwise inadvertent shifting into the 3rd or 4th gear could lead to engine damage. ◀

### Reverse gear

Select only when the vehicle is stationary. When the gearshift lever is pressed to the left, a slight resistance needs to be overcome.

## AUTOMATIC TRANSMISSION WITH STEPTRONIC

In addition to the fully automatic mode, gears can also be shifted manually using Steptronic, refer to page 71.

### Parking the vehicle



Secure the vehicle

Before leaving the vehicle with the engine running, move the selector lever to position P and set the handbrake; otherwise, the vehicle will begin moving. ◀

### Disengaging the remote control

To remove the remote control from the ignition lock, first move the selector lever to position P and switch off the engine: interlock. Remove the remote control from the ignition lock, refer to page 64.

### Selector lever positions

P R N D M/S + -

## Displays in the tachometer

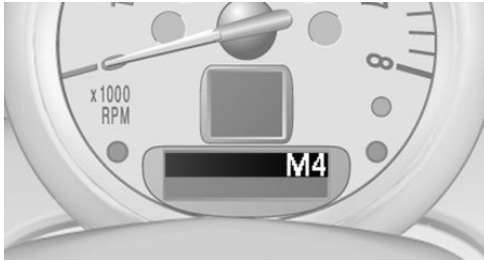

The selector lever position is displayed and the engaged gear, such as M4, is displayed in manual mode.

## Changing selector lever positions

- With the ignition switched on or the engine running, the selector lever can be moved out of position P.
- When the vehicle is stationary, step on the brake before shifting out of P or N; otherwise, the selector lever is locked: shiftlock.



Press on the brake pedal until you start driving

To prevent the vehicle from creeping after you select a driving position, maintain pressure on the brake pedal until you are ready to start. ◀



A lock prevents accidental shifting into selector lever positions R and P.

To override the lock, press the button on the front of the selector lever, see arrow.

## P Park

Select only when the vehicle is stationary. The front wheels are blocked.

## R is Reverse

Select only when the vehicle is stationary.

## N is Neutral

For example, engage this position in a car wash. The vehicle can roll.

## D Drive, automatic position

Position for normal vehicle operation. All forward gears are selected automatically.

Under normal operating conditions, fuel consumption is lowest when you are driving in position D.

## Kickdown

Kickdown is used to achieve maximum driving performance. Press on the accelerator beyond the resistance point at the full throttle position.

## Sport program and manual mode M/S

### Activating the Sport program



Move the selector lever from position D toward the left into the M/S shifting slot.

The Sport program is activated and DS is displayed. This position is recommended for a performance-oriented driving style.

To deactivate the Sport program or manual mode M/S, move the selector lever to the right into position D.

### Activating the M/S manual mode

Move the selector lever from position D toward the left into the M/S shifting slot.

Push the selector lever forward or backward.

Manual mode becomes active and the gear is changed.

The tachometer displays the engaged gear, e. g. M1.

- ▷ To shift up: press the selector lever backward.
- ▷ To shift down: press the selector lever forward.

The vehicle only shifts up or down at appropriate engine and road speeds, e.g., it does not shift down if the engine speed is too high. The selected gear is briefly displayed in the instrument panel, followed by the current gear.

### Shifting gears using the shift paddles on the steering wheel

The shift paddles on the steering wheel allow you to shift gears quickly while keeping both hands on the steering wheel.

- ▷ When the shift paddles on the steering wheel are used to shift gears while in automatic mode, the transmission switches to manual mode.
- ▷ If the shift paddles are not used to accelerate or shift gears for a certain amount of time, the transmission switches back to automatic mode.

If the selector lever is in the M/S gear plane, manual mode remains active.

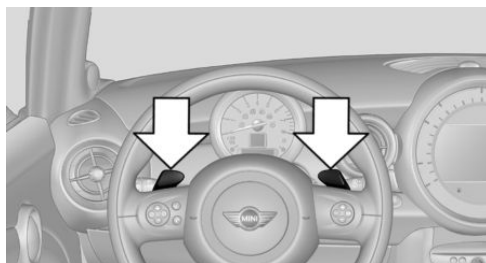

- ▷ Pull one of the two shift paddles:  
The transmission shifts up.
- ▷ Press one of the two shift paddles:  
The transmission shifts down.

The vehicle only shifts up or down at appropriate engine and road speeds, e.g., it does not shift down if the engine speed is too high. The selected gear is briefly displayed in the instrument panel, followed by the current gear.

### Manually unlocking the selector lever lock

If the selector lever is locked in position P although the ignition is switched on, the brake is depressed, and the button on the selector lever is pressed, the selector lever lock can be overridden:

1. Switch off the ignition.
2. Unclip the sleeve of the selector lever.
3. Pull the sleeve up over the selector lever until the sleeve is inside out.

Pull off the plug-in cable connector if necessary.

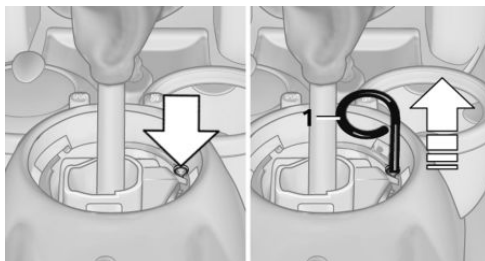



4. Insert the pulling hook 1 from the onboard vehicle tool kit into the loop on the passenger side.
5. Pull the loop upward.
6. Move the selector lever into the desired position, pressing the button on the front of the selector lever.



#### Set the handbrake

Before manually unlocking the selector lever lock, pull the handbrake firmly; otherwise, the vehicle may roll away and cause personal injury or property damage. ◀

# DISPLAYS

## VEHICLE EQUIPMENT

This chapter describes all series equipment as well as country-specific and special equipment offered for this model series. Therefore, it also describes equipment that may not be found in your vehicle, for instance due to the selected special equipment or the country version. This also applies to safety-related functions and systems.

## ODOMETER, EXTERNAL TEMPERATURE DISPLAY, CLOCK

### At a glance

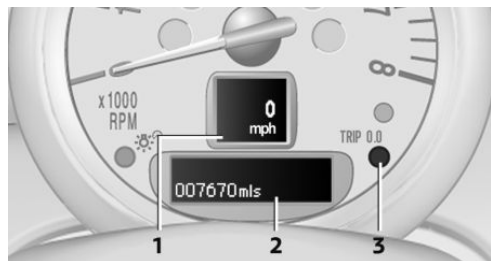

- 1 Current speed
- 2 Odometer, trip odometer, external temperature, time
- 3 Resetting the trip odometer

Press the button on the turn indicator lever to open information in display area 2.

The following information is displayed consecutively:

- ▷ Trip odometer
- ▷ Time
- ▷ External temperature

### Trip odometer

To display the trip odometer: briefly press knob 3.

To reset the trip odometer: press knob 3 while the trip odometer is being displayed and the ignition is switched on.

### Time

Set the time, refer to page 79.

### External temperature, external temperature warning

If the display drops to  $+37^{\circ}\text{F}/+3^{\circ}\text{C}$ , a signal sounds and a warning lamp lights up. There is the increased danger of ice.



#### Ice on roads

Even at temperatures above  $+37^{\circ}\text{F}/+3^{\circ}\text{C}$ , there can be a risk of ice on roads.

Therefore, drive carefully on bridges and shady roads, for example, to avoid the increased danger of an accident. ◀

### Units of measure

To set the respective units of measure, miles or km for the odometer and  $^{\circ}\text{C}$  or  $^{\circ}\text{F}$  for the external temperature, refer to page 78.

## TACHOMETER



It is imperative that you avoid engine speeds in the red warning field. In this range, the fuel supply is interrupted to protect the engine.

## COOLANT TEMPERATURE

A warning lamp will come on if the coolant, and therefore the engine, becomes too hot. In addition, a message will appear on the Control Display.

Check the coolant level, refer to page 240.

## FUEL GAUGE

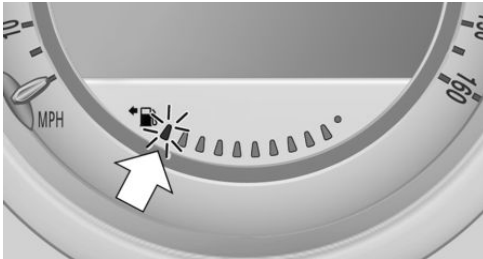

The arrow next to the fuel pump symbol on the fuel gauge indicates the side of the vehicle with the fuel filler flap.

The vehicle inclination may cause the display to vary.

Notes on refueling, refer to page 218.

Filling capacities, refer to page 273.

## Range

After the reserve range is reached:

- ▷ The remaining LEDs change from orange to red, arrow.
- ▷ A message is briefly displayed on the Control Display.
- ▷ The remaining range is shown on the tachometer.
- ▷ When a dynamic driving style is used, such as when corners are taken rapidly, engine functions are not ensured.

The message appears continuously below a range of approx. 30 miles/50 km.



Refuel promptly

At the latest, refuel at a range below 30 miles/50 km; otherwise, the engine function is not ensured and damage may occur. ◀

## COMPUTER

### Opening information in the tachometer

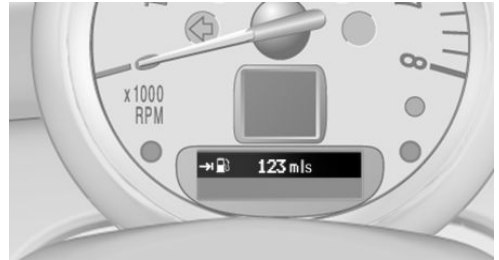

Press the button on the turn indicator lever.

### Overview of the information

The following information is displayed consecutively by repeatedly pressing the button on the turn indicator lever:

- ▷ Range.
- ▷ Average fuel consumption.
- ▷ Current fuel consumption.

- ▷ Average speed.
- ▷ MINI Roadster, MINI Convertible: Always Open Timer.

To set the corresponding units of measure, refer to page 78.

## Information in detail

### Range

Displays the estimated cruising range available with the remaining fuel.

It is calculated based on your driving style over the last 18 miles/30 km.

### Average fuel consumption

This is calculated for the period during which the engine is running.

With the trip computer, refer to page 76, the average consumption can be displayed for an additional distance.

To reset the average consumption: press the button on the turn indicator lever for approx. 2 seconds.

### Current fuel consumption

Displays the current fuel consumption. You can check whether you are currently driving in an efficient and environmentally-friendly manner.

### Average speed

Periods in which the vehicle was parked and the engine was switched off manually are not included in the average speed calculations.

With the trip computer, refer to page 76, the average speed can be displayed for an additional distance.

To reset the average speed: press the button on the turn indicator lever for approx. 2 seconds.

## Displays on the Control Display

Display the computer or trip computer on the Control Display.

1. "Vehicle Info"
2. "Onboard info" or "Trip computer"

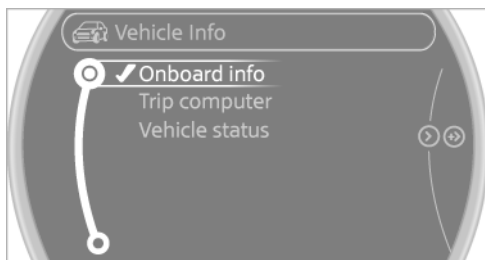

Displays on the "Onboard info":

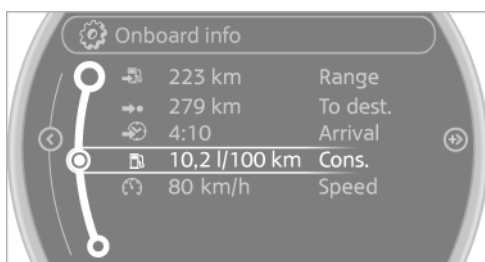

- ▷ Range.
- ▷ Distance to destination.
- ▷ Estimated time of arrival if a destination was entered in the navigation system.

Displays on the "Trip computer":

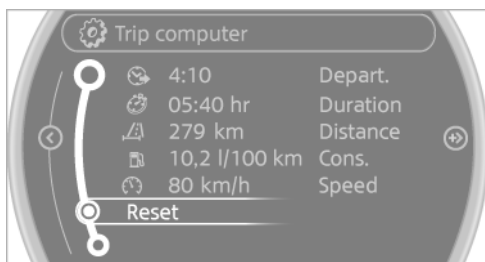

- ▷ Departure time.
- ▷ Trip duration.
- ▷ Trip distance.

Both displays show:

- ▷ Average fuel consumption.
- ▷ Average speed.

### Resetting the fuel consumption and speed

Resetting the values for average speed and average fuel consumption:

1. Select the respective menu item and press the MINI joystick.
2. Press the MINI joystick again to confirm your selection.

### Resetting the trip computer

Resetting all values:

1. "Vehicle Info"
2. "Trip computer"
3. "Reset"

## ALWAYS OPEN TIMER

### Digital Always Open Timer

In the MINI Convertible and MINI Roadster, the driving times with the convertible top open can be digitally displayed in the tachometer. Press the button on the turn indicator lever repeatedly until the driving times are displayed.

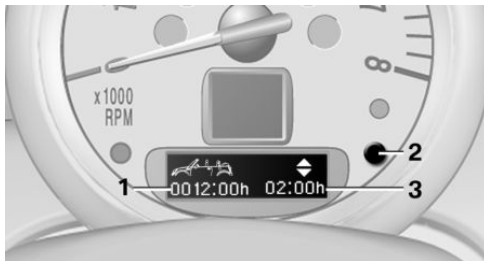

- 1 Total driving time
- 2 Resetting
- 3 Current driving time

To reset the current driving time: press the button on the turn indicator lever or button 2 for approx. 2 seconds while the driving times are displayed.

To reset the total driving time, contact the service center.

### Analog Always Open Timer

The analog Always Open Timer indicates the hours and minutes that were driven with the convertible top open. A maximum of 6 hours and 59 minutes can be displayed.

The total driving time is displayed digitally in the tachometer.

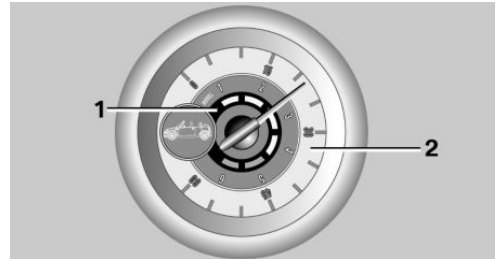

- 1 Hours display LED
- 2 Minutes display

## SETTINGS AND INFORMATION

### Operating concept

Some settings and information can only be created or opened while the ignition is switched on, the vehicle is standing, and the doors are closed.

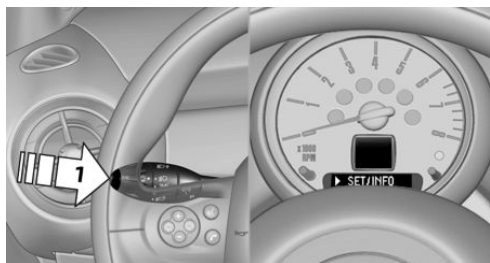

### 1 Button for:

- ▷ Selecting the display.
- ▷ Setting values.
- ▷ Confirming the selected display or set values.
- ▷ Calling up computer information [75](#).

Symbol	Function
	Set the rain sensor, refer to page <a href="#">68</a> .
	
	Open Check-Control, refer to page <a href="#">82</a> .
	
	Exit the menu.
	



## Exiting displays

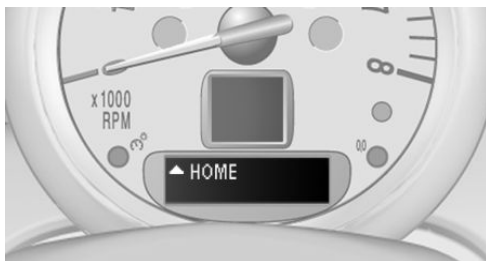

1. Press the button on the turn indicator lever repeatedly until "HOME" is displayed.

2. Hold the button down.

The current speed is displayed again.

Displays are also exited if no entries are made within approx. 8 seconds.

## Next setting or information

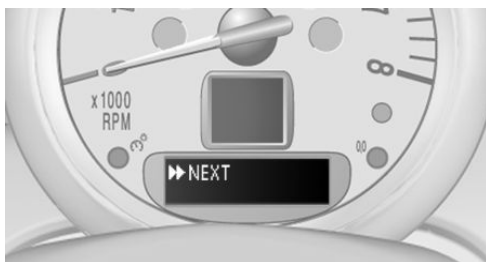

1. Within a setting or information display, press the button on the turn indicator lever repeatedly until "NEXT" is displayed.

2. Hold the button down.

Direct change to the next setting or piece of information.

## UNITS OF MEASURE

The units of measure, such as for fuel consumption, route/distance, and temperature, can be

changed. The settings are stored for the remote control currently in use.

1. "Settings"
2. "Language/Units"



3. Select the desired menu item.
4. Select the desired unit.

## CLOCK

### Setting the time

1. "Settings"

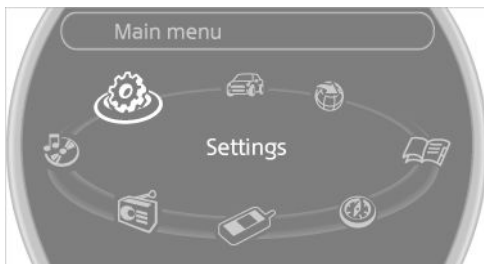

2. "Time/Date"

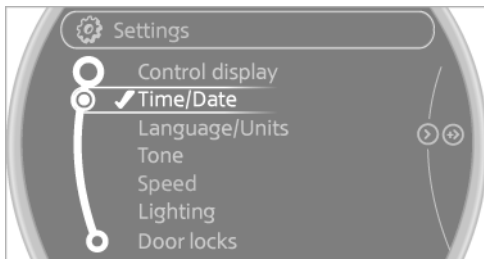

3. "Time:"

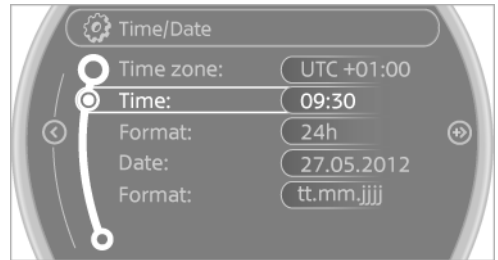

4. Turn the MINI joystick to set the hours and press the MINI joystick.
5. Turn the MINI joystick to set the minutes and press the MINI joystick.

The time is stored.

### Setting the time format

1. "Settings"
2. "Time/Date"
3. "Format:"
4. Select the desired format.

The time format is stored.

The settings are stored for the remote control currently in use.

### Setting the time zone

1. "Settings"
2. "Time/Date"
3. "Time zone:"
4. Turn the MINI joystick until the desired time zone is displayed and press the MINI joystick.

The time zone is stored.

## DATE

### Setting the date

1. "Settings"
2. "Time/Date"

3. "Date:"
4. Turn the MINI joystick until the desired day is displayed and press the MINI joystick.
5. Make the necessary settings for the month and year.

The date is stored.

### Setting the date format

1. "Settings"
2. "Time/Date"
3. "Format:"
4. Select the desired format.

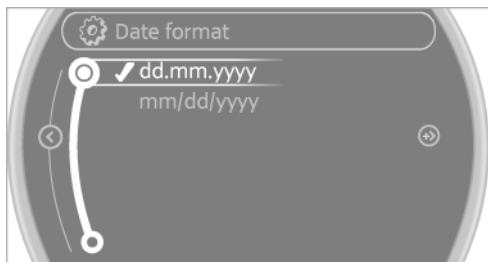

The settings are stored for the remote control currently in use.

## SETTINGS ON THE CONTROL DISPLAY

### Language

#### Setting the language

1. "Settings"
2. "Language/Units"

3. "Language:"

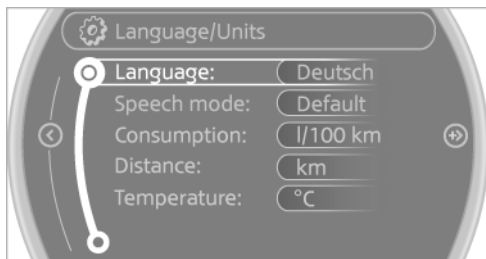

4. Select the desired language.

The setting is stored for the remote control currently in use.

#### Setting the voice dialog

Voice dialog for the voice activation system, refer to page 25.

### Brightness

The brightness is automatically adapted to the ambient lighting conditions. However, the basic setting can be changed when the low beams are switched on.

1. "Settings"
2. "Control display"
3. "Brightness"

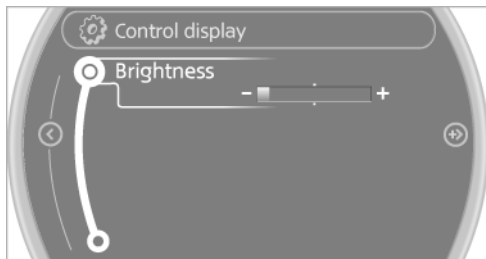

4. Turn the MINI joystick until the desired setting is selected.
5. Press the MINI joystick.

The setting is stored for the remote control currently in use.

Depending on the light conditions, the brightness control may not be clearly visible.



## SERVICE REQUIREMENTS



The remaining driving distance and the date of the next scheduled service are displayed briefly immediately after you start the engine or switch on the ignition.

The current service requirements can be read out from the remote control by the service specialist.

### Detailed information on service requirements

More information on the scope of service required can be displayed on the Control Display.

1. "Vehicle Info"
2. "Vehicle status"

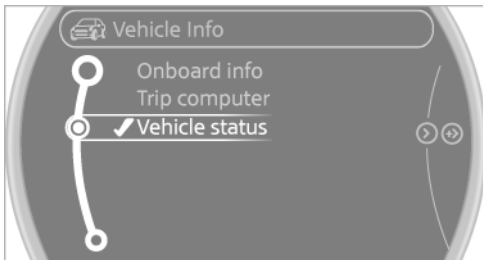

3. "Service required"

Required maintenance procedures and legally mandated inspections are displayed.

Additional information can be displayed on each entry:

Select the entry and press the MINI joystick.

To exit from the menu:

Move the MINI joystick to the left.

## Symbols

Symbols	Description
	No service is currently required.
	The deadline for service or a legally mandated inspection is approaching.
	The service deadline has already passed.

## Entering appointment dates

Enter the dates for the required inspections.

Make sure the date on the Control Display is set correctly.

1. "Vehicle Info"
2. "Vehicle status"
3. "Service required"

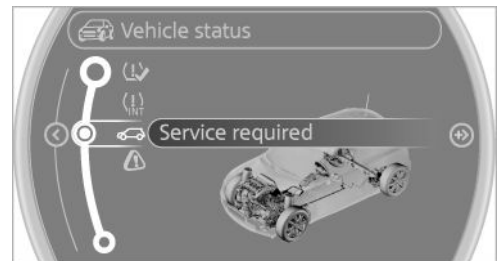

4. "§ Vehicle inspection"

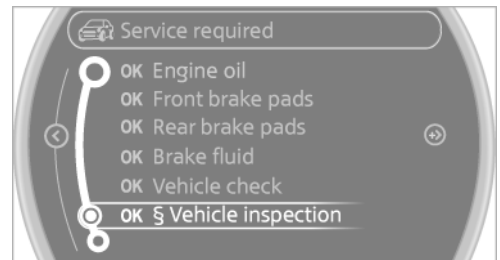

5. Open the menu for entering the deadline.
6. "Date:"

7. Create the settings.
8. Press the MINI joystick to apply the setting. The year is highlighted.
9. Turn the MINI joystick to create the setting.
10. Press the MINI joystick to apply the setting. The date entry is stored.

To exit from the menu:

Move the MINI joystick to the left.

## CHECK CONTROL

### The concept

The Check Control monitors vehicle functions and alerts you to any malfunctions in the systems being monitored.

A Check Control message consists of indicator and warning lamps in the instrument cluster and, in some circumstances, an acoustic signal and text messages at the top of the Control Display.

### Indicator/warning lamps

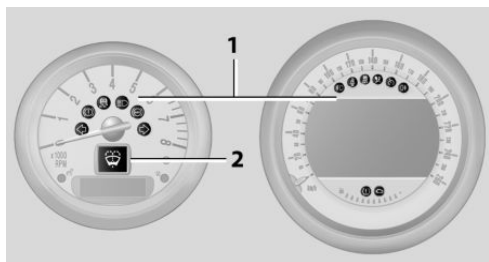

The indicator and warning lamps can light up in a variety of combinations and colors in display area 1 or 2.

Several of the lamps are checked for proper functioning and light up temporarily when the engine is started or the ignition is switched on.

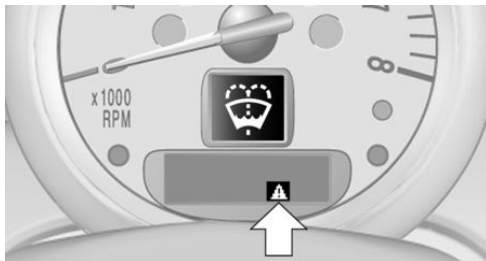

⚠ The symbol indicates that Check Control messages have been stored. The Check Control messages can be displayed later.

### Text messages

Text messages at the upper edge of the Control Display in combination with a symbol in the instrument cluster explain a Check Control message and the meaning of the indicator and warning lamps.

### Supplementary text messages

Additional information, such as on the cause of a fault or the required action, can be called up via Check Control.

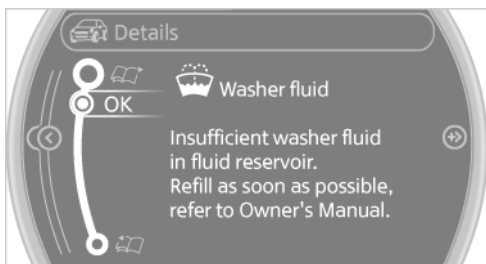

In urgent cases, this information will be shown as soon as the corresponding lamp comes on.

## Hiding Check Control messages

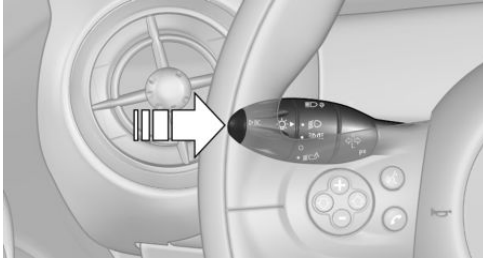

Press the button on the turn indicator lever.

Some Check Control messages are displayed continuously and are not cleared until the malfunction is eliminated. If several malfunctions occur at once, the messages are displayed consecutively.



They are marked with the symbol shown here.

Other Check Control messages are hidden automatically after approx. 20 seconds. However, they are stored and can be displayed again later.



They are marked with the symbol shown here.

## Viewing stored Check Control messages

The stored Check Control messages can only be displayed while the driver's door is closed.

1. Press the button on the turn indicator lever repeatedly until "SET/INFO" is displayed.

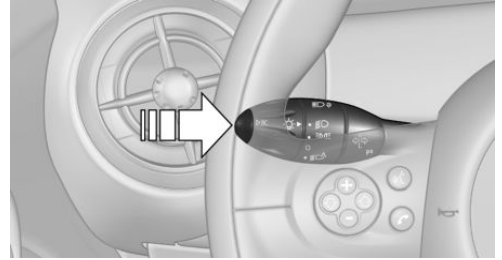

2. Press and hold the button until the display changes.
3. Press the button repeatedly until the corresponding symbol and "CHECK INFO" appear on the display.



4. Press and hold the button.  
If there is no Check Control message, this is indicated by "CHECK OK".  
If a Check Control message has been stored, the corresponding message is displayed.  
The text message is also displayed on the Control Display.
5. Press the button to check for other messages.

## Displaying on the Control Display

1. "Vehicle Info"
2. "Vehicle status"
3. "Check Control"

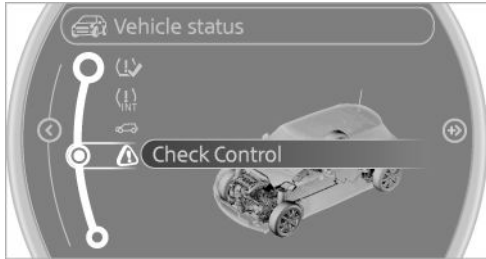

4. Select the text message.

# LAMPS

## VEHICLE EQUIPMENT

This chapter describes all series equipment as well as country-specific and special equipment offered for this model series. Therefore, it also describes equipment that may not be found in your vehicle, for instance due to the selected special equipment or the country version. This also applies to safety-related functions and systems.

## AT A GLANCE

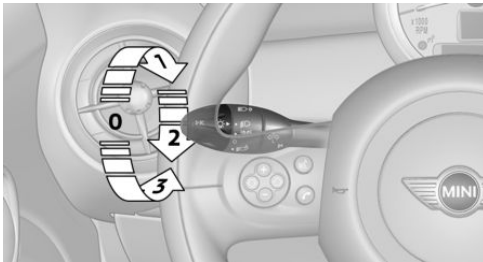

- 0** Lamps off / daytime running lights
- 1** Parking lamps and daytime running lights
- 2** Low-beam headlamps and welcome lamps
- 3** Automatic headlamp control, Adaptive Light Control, daytime running lights, and welcome lamps

## PARKING LAMPS/LOW BEAMS, HEADLAMP CONTROL

### General information

When the driver's door is opened with the ignition switched off, the exterior lighting is automatically switched off when the light switch is in position 0, 2, or 3.

Switch on the parking lamps if necessary, switch position 1.

### Parking lamps

Switch position 1: the vehicle lamps light up on all sides.

Do not use the parking lamps for extended periods; otherwise, the battery may become discharged and it would then be impossible to start the engine.

When parking, it is preferable to switch on the one-sided roadside parking lamps, refer to page 86.

### Low beams

Switch position 2: the low beams are lit when the ignition is switched on.

### Automatic headlamp control

Switch position 3: the low beams are switched on and off automatically depending on the ambient light, e.g., in tunnels, in twilight, or if there is precipitation. Adaptive Light Control is active.

A blue sky with the sun low on the horizon can cause the lights to be switched on.

The low beams remain switched on independent of the ambient lighting conditions when you switch on the front fog lamps.



### Personal responsibility

The automatic headlamp control cannot serve as a substitute for your personal judgment in determining when the lamps should be switched on in response to ambient lighting conditions.

For example, the sensors are unable to detect fog or hazy weather. To avoid safety risks, you should always switch on the lamps manually under these conditions. ◀

When the daytime running lights are activated, the low beams are always switched on in switch position 3 when the ignition is switched on.

The exterior lighting goes out automatically after the vehicle is switched off.

### High beams/roadside parking lamps

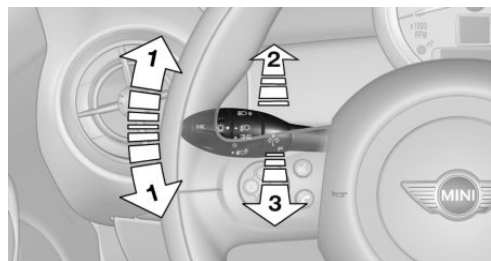

- 1 Turn signal/roadside parking lamp
- 2 Switching on the high beams
- 3 Switching off the high beams/headlamp flasher

To assist in parking, the vehicle can be illuminated on one side; note the country-specific regulations.

The roadside parking lamps drain the battery. Therefore, do not leave them on for unduly long periods of time; otherwise, the battery might not have enough power to start the engine.

### Switching on the roadside parking lamp

To switch on the roadside parking lamp on the left or right, press the turn indicator lever up or down after switching off the vehicle, arrow 1.

### Switching off the roadside parking lamp

Press the lever up or down to the resistance point.

### Daytime running lights

The daytime running lights light up in switch position 0, 1, or 3 when the ignition is switched on.

The exterior lighting goes out automatically after the vehicle is switched off.

In switch position 1, the parking lamps light up after the ignition is switched off.

### Activating/deactivating

1. "Settings"
2. "Lighting"
3. "Daytime running lamps"

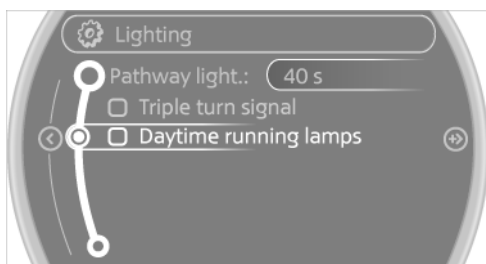

The setting is stored for the remote control currently in use.

### Welcome lamps

If the light switch stays in switch position 2 or 3 after the vehicle is switched off, the parking lamps and the interior lamps light up for a certain period when the vehicle is unlocked.

### Headlamp courtesy delay feature

The low beams stay lit for a short while after the ignition is switched off, if the lamps are switched off and the headlamp flasher is switched on.

### Setting the duration

1. "Settings"
2. "Lighting"

### 3. "Pathway light.: s"

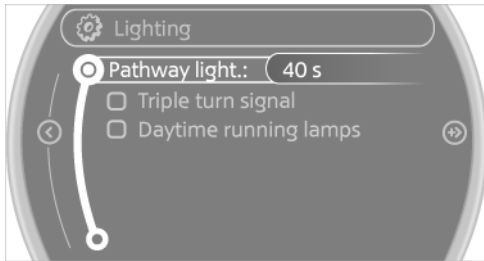

### 4. Set the duration.

The setting is stored for the remote control currently in use.

## ADAPTIVE LIGHT CONTROL

### The concept

Adaptive Light Control is a variable headlamp control system that enables dynamic illumination of the road surface.

Depending on the steering angle and other parameters, the light from the headlamp follows the course of the road.

### Activating

With the ignition switch on, turn the light switch to position 3, refer to page 85.

To avoid blinding oncoming traffic, the Adaptive Light Control does not swivel to the driver's side when the vehicle is at a standstill.

When driving in reverse, Adaptive Light Control is not active.

### Malfunction



The warning lamp lights up. A message appears on the Control Display. Adaptive Light Control is malfunctioning or has failed. Have the system checked as soon as possible.

## FOG LAMPS

### MINI Coupe, MINI Roadster

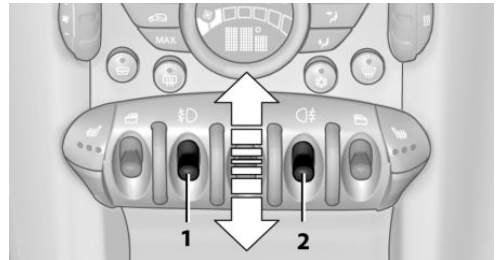

1 Fog lamps

2 Rear fog lamp

To switch on/off, press the respective button.

### MINI Convertible

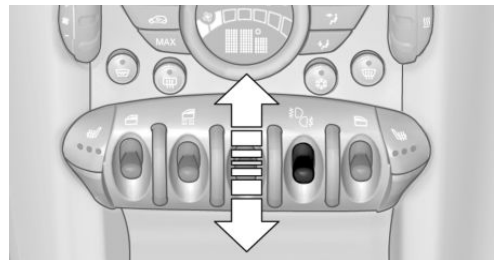

▷ To switch on the front fog lamps:

Press the switch upward.

▷ To switch on the rear fog lamp:

Press the switch downward.

To switch off, press the respective switch upward or downward again.

### Fog lamps

The parking lamps or low beams must be switched on. The green indicator lamp lights up when the front fog lamps are switched on.

Depending on the vehicle equipment, the front fog lamps are switched off when the headlamp flasher or the high beams are activated.

If the automatic headlamp control is activated, refer to page 85, the low beams are switched on automatically when the front fog lamps are switched on.

### Rear fog lamp

The low beams or parking lamps with front fog lamps must be switched on. The yellow indicator lamp lights up when the rear fog lamp is switched on.

## INSTRUMENT LIGHTING

The parking lamps or low beams must be switched on to adjust the brightness. The brightness is increased to a certain limit and is then reduced again.

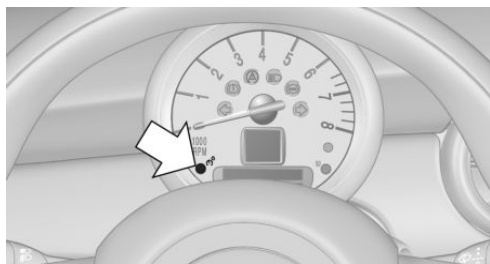

- ▷ Press the button briefly: the brightness changes in stages.
- ▷ Press and hold the button: the brightness changes continuously.

## INTERIOR LAMPS

The interior lamps, the footwell lamps and the cargo area lamp are controlled automatically.

To avoid draining the battery, all lamps inside the vehicle are switched off some time after the ignition is switched off.

### Switching interior lamps on/off manually

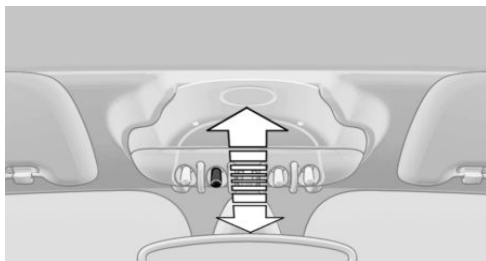

To switch the interior lamps on/off: press the switch.

If the interior lamps are to remain switched off, press the switch for approx. 3 seconds.

### Reading lamps

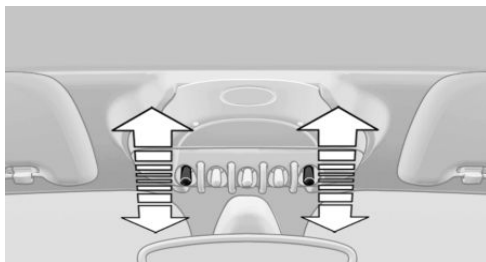

Switching the reading lamps on/off  
Press the switch.

### MINI Roadster with semi-automatic convertible top

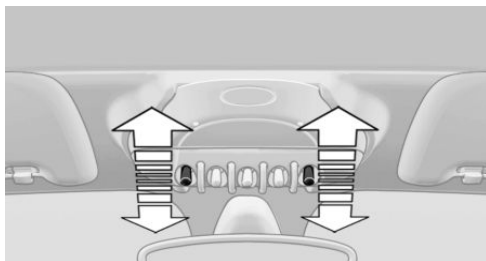

To switch on the interior lamps: press the switch back.



To switch on the reading lamps: press the switch forward.

To switch off, press the respective switch forward or back again.

### Ambient lighting

The color and brightness of the ambient lighting can be changed.

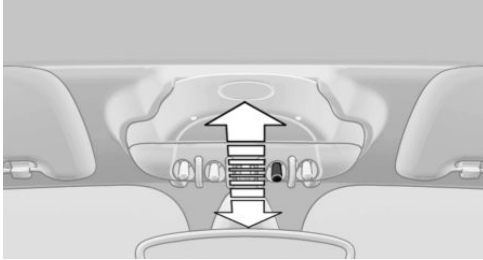

Press the switch forward: the color changes in steps.

Press the switch back: the brightness changes in steps.

Intermediate settings and intermediate colors are possible.

For continuously changing colors of the ambient lighting, press the switch forward for more than 10 seconds.

# SAFETY

## VEHICLE EQUIPMENT

This chapter describes all series equipment as well as country-specific and special equipment offered for this model series. Therefore, it also describes equipment that may not be found in your vehicle, for instance due to the selected special equipment or the country version. This also applies to safety-related functions and systems.

## AIRBAGS

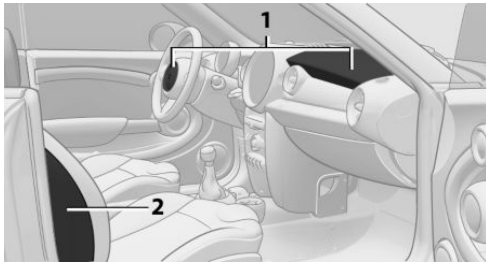

- 1 Front airbags
- 2 Side/head airbags in the seat backrests

### Front airbags

Front airbags help protect the driver and front passenger by responding to frontal impacts in which safety belts alone cannot provide adequate restraint.

### Combined side/head airbag

The combined side/head airbag supports the side of the body in the chest area and the head.

### Protective action

Airbags are not triggered in every impact situation, e.g., in less severe accidents or rear-end collisions.



Information on how to ensure the optimal protective effect of the airbags

- ▷ Keep at a distance from the airbags.
- ▷ Always grasp the steering wheel on the steering wheel rim, holding your hands at the 3 o'clock and 9 o'clock positions, to keep the danger of injury to your hands or arms as low as possible if the airbag is triggered.
- ▷ There should be no people, animals, or objects between an airbag and a person.
- ▷ Do not use the cover of the front airbag on the front passenger side as a storage area.
- ▷ Keep the dashboard and window on the front passenger side clear, i.e., do not cover with adhesive labels or coverings, and do not attach holders such as for navigation instruments and mobile phones.
- ▷ Make sure that the front passenger is sitting correctly, i.e., keeps his or her feet and legs in the footwell; otherwise, leg injuries can occur if the front airbag is triggered.
- ▷ Do not place slip covers, seat cushions or other objects on the front passenger seat that are not approved specifically for seats with integrated side airbags.
- ▷ Do not hang pieces of clothing, such as jackets, over the backrests.
- ▷ Make sure that occupants keep their heads away from the side airbag and do not rest against the head airbag; otherwise, injuries can occur if the airbags are triggered.
- ▷ Do not remove the airbag restraint system.
- ▷ Do not remove the steering wheel.
- ▷ Do not apply adhesive materials to the airbag cover panels, cover them or modify them in any way.

- ▶ Never modify either the individual components or the wiring in the airbag system. This also applies to steering wheel covers, the dashboard, the seats, the roof pillars and the sides of the headliner. ◀

Even when all instructions are followed closely, injury from contact with the airbags cannot be ruled out in certain situations.

The ignition and inflation noise may lead to short-term and, in most cases, temporary hearing impairment in sensitive individuals.

 In the case of a malfunction, deactivation and after triggering of the airbags

Do not touch the individual components immediately after the system has been triggered; otherwise, there is the danger of burns.

Only have the airbags checked, repaired or dismantled and the airbag generator scrapped by your service center or a workshop that has the necessary authorization for handling explosives.

Non-professional attempts to service the system could lead to failure in an emergency or undesired triggering of the airbag, either of which could result in injury. ◀

Warning notices and information about the airbags can also be found on the sun visors.

### Automatic deactivation of the front passenger airbags

The occupation of the seat is detected by evaluating the impression on the occupied seat surface of the front passenger seat.

The front and side airbags on the front passenger side are activated or deactivated accordingly by the system.

The indicator lamp above the interior rearview mirror, refer to page 92, shows the current status of the front passenger airbags, deactivated or activated.



Leave feet in the footwell

Make sure that the front passenger keeps his or her feet in the footwell; otherwise, the front passenger airbags may not function properly. ◀



Child restraint fixing system in the front passenger seat

Before transporting a child on the front passenger seat, read the safety and operating instructions under Transporting children safely, refer to page 59. ◀

### Malfunction of the automatic deactivation system

When transporting older children and adults, the front passenger airbags may be deactivated in certain sitting positions. In this case, the indicator lamp for the front passenger airbags lights up.

In this case, change the sitting position so that the front passenger airbags are activated and the indicator lamp goes out.

If it is not possible to activate the airbags, have the person sit in the rear.

To make sure that occupation of the seat cushion can be detected correctly:

- ▶ Do not attach seat covers, seat cushion padding, ball mats, or other items to the front passenger seat unless they are specifically recommended by the manufacturer of your MINI.
- ▶ Do not place any objects on the front passenger seat.
- ▶ Do not place objects under the seat that could press against the seat from below.

## Indicator lamp for the front passenger airbags

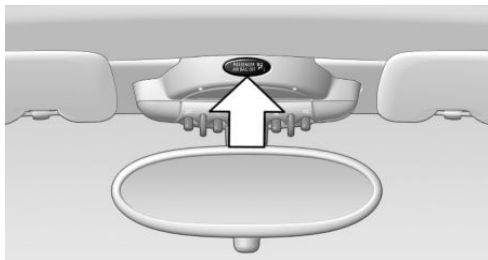

The indicator lamp for the front passenger airbags indicates the operating state of the front passenger airbags.

The lamp indicates whether the airbags are activated or deactivated.



- ▷ The indicator lamp lights up when a child in a child restraint fixing system intended for the purpose is properly detected on the seat. The airbags on the front passenger side are not activated.

- ▷ The indicator lamp does not light up when, for example, a correctly seated person of sufficient size is detected on the seat. The airbags on the front passenger side are activated.
- ▷ The indicator lamp does not light up when the seat is empty. However, the airbags on the front passenger side are not activated.

Most child seats are detected by the system, Especially the child seats required by NHTSA at the time that the vehicle was manufactured. After installing a child seat, make sure that the indicator lamp for the front passenger airbags lights up. This indicates that the child seat has been detected and the front passenger airbags are not activated.

## Operational readiness of airbag system

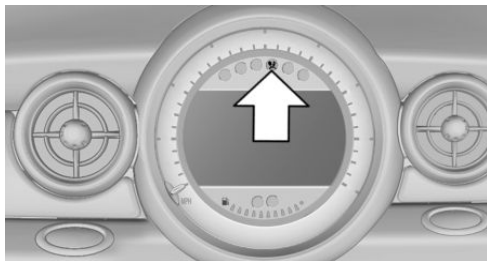

In the radio ready state and beyond, refer to page 64, the warning lamp lights up briefly to indicate that the entire airbag system and the belt tensioners are operational.



### Airbag system malfunction

- ▷ Warning lamp does not light up in the radio ready state.
- ▷ Warning lamp remains permanently on.



Have the airbag system checked without delay if there is a malfunction

In the event of a malfunction in the airbag system, have it checked without delay; otherwise, there is the risk that the system will not function as intended even if a sufficiently severe accident occurs. ◀

## MINI CONVERTIBLE: ROLL-OVER PROTECTION SYSTEM

The rollover protection system is automatically activated in a sufficiently severe accident or when the inclination of the longitudinal axis is extremely high. The protective bars behind the rear head restraints extend within fractions of a second.

The rollover protection system increases the safety of the vehicle occupants in addition to the reinforced windshield frame.



Do not obstruct the area of movement

Always keep the area of movement of the rollover protection system clear. In light accidents, you are protected by the fastened safety belt and, depending on the severity of the accident, the belt tightener and the multi-level air bag restraint system. ◀

## Lowering

Have the service center check the rollover protection system after it is deployed unexpectedly.



General instructions on the rollover protection system

When the rollover protection system is extended, do not move the convertible top under any circumstances.

Do not modify the individual components of the rollover protection system or the wiring in any way.

Work on the rollover protection system should only be performed by a MINI service center.

Non-professional work on the system could lead to failure or a malfunction.

To check the system and to ensure that the system will operate properly over the long-term, it is imperative that you adhere to the specified service intervals. ◀

## FTM FLAT TIRE MONITOR

### The concept

The system does not measure the actual inflation pressure in the tires.

The system detects a pressure loss in a tire by comparing the rotational speeds of the individual wheels while moving.

In the event of a pressure loss, the diameter and therefore the rotational speed of the corresponding wheel change. This is detected and reported as a flat tire.

### Functional requirements

The system must have been initialized when the tire inflation pressure was correct; otherwise, reliable signaling of a flat tire is not ensured.

Initialize the system after each correction of the tire inflation pressure and after every tire or wheel change.

### System limits



Sudden tire damage

Sudden serious tire damage caused by external influences cannot be indicated in advance. ◀

A natural, even pressure loss in all four tires cannot be detected. Therefore, check the tire inflation pressure regularly.

The system could be delayed or malfunction in the following situations:

- ▷ When the system has not been initialized.
- ▷ When driving on a snowy or slippery road surface.
- ▷ Sporty driving style: slip in the drive wheels, high lateral acceleration.
- ▷ When driving with snow chains.

When the vehicle is driven with a compact wheel, refer to page 250, the Flat Tire Monitor is not functional.

### Status display

The current status of the Flat Tire Monitor can be displayed on the Control Display, e.g., whether or not the FTM is active.

1. "Vehicle Info"
2. "Vehicle status"

### 3. "Flat Tire Monitor"

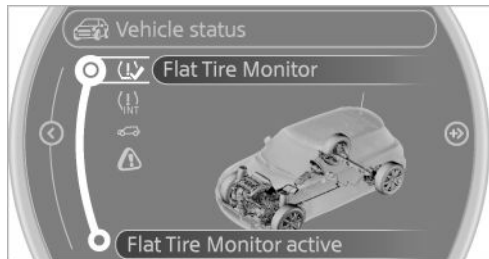

The status is displayed.

#### Initialization

The initialization process adopts the set inflation tire pressures as reference values for the detection of a flat tire. Initialization is started by confirming the inflation pressures.

Do not initialize the system when driving with snow chains.

1. "Vehicle Info"
2. "Vehicle status"
3. "Reset"

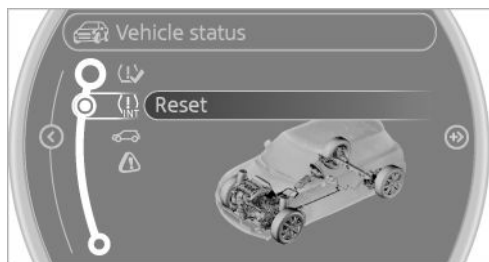

4. Start the engine, but do not start driving.
5. Start the initialization with "Reset".
6. Drive away.

The initialization is completed while driving, which can be interrupted at any time. The initialization automatically continues when driving resumes.

#### Indication of a flat tire

(!) The warning lamps come on in yellow and red. A message appears on the Control Display. In addition, a signal sounds.

There is a flat tire or a major loss in tire inflation pressure.

1. Reduce your speed and stop cautiously. Avoid sudden braking and steering maneuvers.
2. Check whether the vehicle is fitted with regular tires or run-flat tires.

Run-flat tires, refer to page 232, are labeled with a circular symbol containing the letters RSC marked on the tire sidewall.

 Do not continue driving without run-flat tires

Do not continue driving if the vehicle is not equipped with run-flat tires; continued driving may result in serious accidents. ◀

When a flat tire is indicated, DSC Dynamic Stability Control is switched on if necessary.

#### Actions in the event of a flat tire

##### Normal tires

1. Identify the damaged tire.  
Do this by checking the inflation pressure in all four tires.  
The tire pressure gauge of the Mobility System, refer to page 233, can be used for this purpose.  
If the tire inflation pressure in all four tires is correct, the Flat Tire Monitor may not have been initialized. In this case, initialize the system.  
If an identification is not possible, please contact the service center.
2. Rectify the flat tire using the Mobility System, refer to page 233, or replace the damaged wheel, refer to page 249.

## Run-flat tires

You can continue driving with a damaged tire at speeds up to 50 mph/80 km/h.

## Continued driving with a flat tire

If continuing to drive with a damaged tire:

1. Avoid sudden braking and steering maneuvers.
2. Do not exceed a speed of 50 mph/80 km/h.
3. At the next opportunity, check the inflation pressure in all four tires.

If the tire inflation pressure in all four tires is correct, the Flat Tire Monitor may not have been initialized. In this case, initialize the system.

Possible driving distance with complete loss of tire inflation pressure:

The possible driving distance after a loss of tire inflation pressure depends on the cargo load and the driving style and conditions.

For a vehicle containing an average load, the possible driving distance is approx. 50 miles/80 km.

When the vehicle is driven with a damaged tire, its handling characteristics change, e.g., reduced lane stability during braking, a longer braking distance, and altered self-steering properties. Adjust your driving style accordingly. Avoid abrupt steering maneuvers or driving over obstacles, e. g., curbs, potholes, etc.

Because the possible driving distance depends on how the vehicle is used during the trip, the actual distance may be smaller or greater depending on the driving speed, road conditions, external temperature, cargo load, etc.



Continued driving with a flat tire

Drive moderately and do not exceed a speed of 50 mph/80 km/h.

A loss of tire inflation pressure results in a change in the handling characteristics, e.g., reduced lane stability during braking, a longer braking distance and altered self-steering properties. ◀



Final tire failure

Vibrations or loud noises while driving can indicate the final failure of the tire. Reduce speed and stop; otherwise, pieces of the tire could come loose and cause an accident. Do not continue driving, and contact your service center. ◀

## TIRE PRESSURE MONITOR TPM

### The concept

The tire inflation pressure is measured in the four mounted tires. The system notifies you if there is a significant loss of pressure in one or more tires.

### Functional requirements

The system must have been reset while the inflation pressure was correct; otherwise, reliable signaling of a flat tire is not ensured.

Always use wheels with TPM electronics to ensure that the system will operate properly.

Reset the system after each correction of the tire inflation pressure and after every tire or wheel change.

### System limits



Sudden tire damage

Sudden serious tire damage caused by external influences cannot be indicated in advance. ◀

The system does not operate correctly if it has not been reset. For example, a flat tire may be indicated despite correct tire inflation pressures.

The system is inactive and cannot indicate a flat tire:

- ▷ If a wheel without TPM electronics is mounted, e.g., compact wheel.
- ▷ For a mounted wheel without TPM electronics.
- ▷ When the TPM is disturbed by other systems or devices with the same radio frequency.

### Status display

1. "Vehicle Info"
2. "Vehicle status"
3. "Tire Pressure Monitor - TPM"

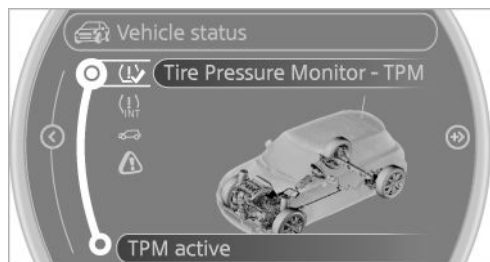

The status is displayed.

### Status indicator on the Control Display

The tire and system status is indicated by the color of the tires.

A change in the tire inflation pressure during driving is taken into account.

A correction is only necessary if this is indicated by the TPM

### Wheels, green

The tire inflation pressure is equal to the target state.

"TPM active" is displayed on the onboard monitor.

### One wheel is yellow

A flat tire or major drop in inflation pressure in the indicated tire.

### All wheels are yellow

- ▷ A flat tire or major drop in inflation pressure in several tires.
- ▷ The system was not reset after a wheel change and thus issues a warning based on the inflation pressures initialized last.
- ▷ A flat tire in one or more tires while the system is being reset.

### Wheels, gray

The system cannot detect a flat tire.

Reasons for this may be:

- ▷ TPM is being reset.
- ▷ Disturbance by systems or devices with the same radio frequency.
- ▷ Malfunction.

### Resetting the system

Reset the system after each correction of the tire inflation pressure and after every tire or wheel change.

1. "Vehicle Info"
2. "Vehicle status"
3. "Reset"

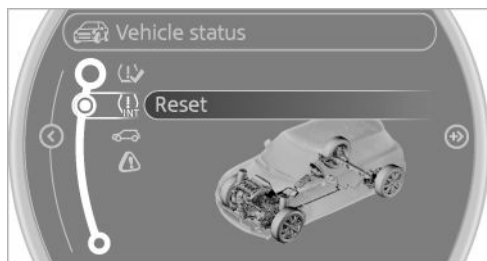

4. Start the engine - do not drive away.
5. Start the initialization with "Reset".
6. Drive away.

The tires are shown in gray and "Resetting TPM..." is displayed.

After driving a few minutes, the set inflation pressures in the tires are accepted as the target values to be monitored. The resetting process is



completed automatically as you drive. On the Control Display, the tires are shown in green and "Status: TPM active" is displayed again.

The trip can be interrupted at any time. If you drive away again, the process resumes automatically.

If a flat tire is detected while the system is resetting, all tires on the Control Display are displayed in yellow. The message "Low tire!" is shown.

### Low tire pressure message



The warning lamps come on in yellow and red. A message is displayed on the onboard monitor. In addition, a signal sounds.



- ▶ There is a flat tire or substantial loss of inflation pressure on the indicated wheel.
  - ▶ The system was not reset after a wheel change and thus issues warnings based on the inflation pressures initialized last.
1. Reduce your speed and stop cautiously. Avoid sudden braking and steering maneuvers.
  2. Check whether the vehicle is fitted with regular tires or run-flat tires.

Run-flat tires, refer to page 232, are labeled with a circular symbol containing the letters RSC marked on the tire sidewall.



Do not continue driving without run-flat tires

Do not continue driving if the vehicle is not equipped with run-flat tires; continued driving may result in serious accidents. ◀

When a low inflation pressure is indicated, DSC Dynamic Stability Control is switched on if necessary.

### Actions in the event of a flat tire

#### Normal tires

1. Identify the damaged tire.

Do this by checking the air pressure in all four tires. The tire pressure gauge of the Mobility System, refer to page 233, can be used for this purpose.

If the tire inflation pressure in all four tires is correct, the Tire Pressure Monitor may not have been reset. Reset the system.

If an identification is not possible, please contact the service center.

2. Rectify the flat tire using the Mobility System, refer to page 233, or replace the damaged wheel, refer to page 249.

Use of tire sealant, e.g., the Mobility System, may damage the TPM wheel electronics. In this case, have the electronics checked at the next opportunity and have them replaced if necessary.

### Run-flat tires

You can continue driving with a damaged tire at speeds up to 50 mph/80 km/h.



Do not continue driving without run-flat tires

Do not continue driving if the vehicle is not equipped with run-flat tires; continued driving may result in serious accidents. ◀

### Continued driving with a flat tire

If continuing to drive with a damaged tire:

1. Avoid sudden braking and steering maneuvers.
2. Do not exceed a speed of 50 mph/80 km/h.
3. Check the air pressure in all four tires at the next opportunity.

If the tire inflation pressure in all four tires is correct, the Tire Pressure Monitor may not have been reset. Reset the system.

Possible driving distance with complete loss of tire inflation pressure:

The possible driving distance after a loss of tire inflation pressure depends on the cargo load and the driving style and conditions.

For a vehicle containing an average load, the possible driving distance is approx. 50 miles/80 km.

When the vehicle is driven with a damaged tire, its handling characteristics change, e.g., reduced lane stability during braking, a longer braking distance, and altered self-steering properties. Adjust your driving style accordingly. Avoid abrupt steering maneuvers or driving over obstacles, e. g., curbs, potholes, etc.

Because the possible driving distance depends on how the vehicle is used during the trip, the actual distance may be smaller or greater depending on the driving speed, road conditions, external temperature, cargo load, etc.

#### Continued driving with a flat tire

Drive moderately and do not exceed a speed of 50 mph/80 km/h.

A loss of tire inflation pressure results in a change in the handling characteristics, e.g., reduced lane stability during braking, a longer braking distance and altered self-steering properties. ◀

#### Final tire failure

Vibrations or loud noises while driving can indicate the final failure of the tire. Reduce speed and stop; otherwise, pieces of the tire could come loose and cause an accident. Do not continue driving, and contact your service center. ◀

### Message when not reset

 The yellow warning lamp lights up. A message is displayed on the onboard monitor.

The system detected a wheel change but was not yet reset. Warnings regarding the current tire inflation pressure are not reliable.

Check the tire inflation pressure and reset the system, refer to page 96.

### Malfunction

 The small warning lamp flashes in yellow and then lights up continuously; the larger warning lamp comes on in yellow.



On the onboard monitor, the tires are shown in gray and a message appears.

No flat tire can be detected.

Display in the following situations:

- ▶ A wheel without TPM electronics is mounted:  
Have the system checked by the service center if necessary.
- ▶ Malfunction:  
Have the system checked.
- ▶ TPM could not be fully reset; reset the system again.

 The small warning lamp flashes in yellow and then lights up continuously; the larger warning lamp comes on in yellow.



On the onboard monitor, the tires are shown in gray and a message appears.

No flat tire can be detected.

Display in the following situation:

- ▶ Disturbance by other systems or devices with the same radio frequency  
After leaving the area of the disturbance, the system automatically becomes active again.

### Declaration according to NHTSA/FMVSS 138 Tire Pressure Monitoring Systems

Each tire, including the spare (if provided) should be checked monthly when cold and inflated to the inflation pressure recommended by the vehicle manufacturer on the vehicle placard or tire inflation pressure label (If your vehicle has tires of a different size than the size indicated on the vehicle placard or tire inflation

pressure label, you should determine the proper tire inflation pressure for those tires.).

As an added safety feature, your vehicle has been equipped with a tire pressure monitoring system (TPMS) that illuminates a low tire pressure telltale when one or more of your tires is significantly under-inflated. Accordingly, when the low tire pressure telltale illuminates, you should stop and check your tires as soon as possible, and inflate them to the proper pressure. Driving on a significantly under-inflated tire causes the tire to overheat and can lead to tire failure. Under-inflation also reduces fuel efficiency and tire tread life, and may affect the vehicle's handling and stopping ability.

Please note that the TPMS is not a substitute for proper tire maintenance, and it is the driver's responsibility to maintain correct tire pressure, even if under-inflation has not reached the level to trigger illumination of the TPMS low tire pressure telltale.

Your vehicle has also been equipped with a TPMS malfunction indicator to indicate when the system is not operating properly. The TPMS malfunction indicator is combined with the low tire pressure telltale. When the system detects a malfunction, the telltale will flash for approximately one minute and then remain continuously illuminated. This sequence will continue upon subsequent vehicle startups as long as the malfunction exists. When the malfunction indicator is illuminated, the system may not be able to detect or signal low tire pressure as intended. TPMS malfunctions may occur for a variety of reasons, including the installation of replacement or alternate tires or wheels on the vehicle that prevent the TPMS from functioning properly. Always check the TPMS malfunction telltale after replacing one or more tires or wheels on your vehicle to ensure that the replacement or alternate tires and wheels allow the TPMS to continue to function properly.

## SPEED LIMIT

### The concept

Enter a speed for which a Check Control message will be displayed when the speed is reached. This enables you to receive warnings if you exceed a speed limit in an urban area, for example.

You are only warned of reaching this speed a second time if your vehicle speed falls below it again by at least 3 mph/5 km/h.

### Displaying, setting or changing the limit

1. "Settings"
2. "Speed"
3. "Warning at:"

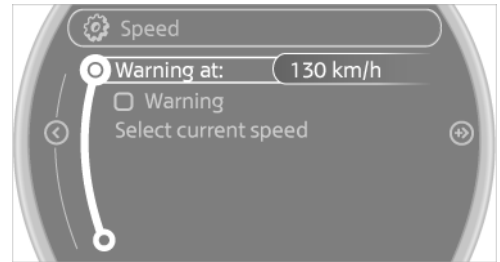

4. Turn the MINI joystick to accept the setting.
5. Press the MINI joystick to apply the setting.

The limit is stored.

### Applying your current speed as the limit

1. "Settings"
2. "Speed"

### 3. "Select current speed"

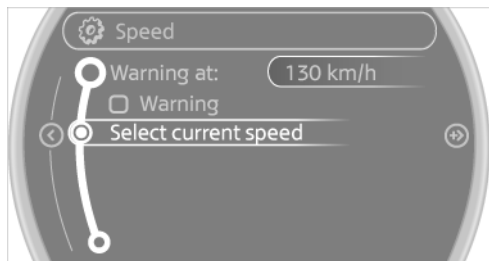

### 4. Press the MINI joystick.

The system adopts your current speed as the limit.

## Activating/deactivating the limit

1. "Settings"
2. "Speed"
3. "Warning"



### 4. Press the MINI joystick.

# DRIVING STABILITY CONTROL SYSTEMS

## VEHICLE EQUIPMENT

This chapter describes all series equipment as well as country-specific and special equipment offered for this model series. Therefore, it also describes equipment that may not be found in your vehicle, for instance due to the selected special equipment or the country version. This also applies to safety-related functions and systems.

## ANTILOCK BRAKE SYSTEM ABS

ABS prevents locking of the wheels during braking.

Steerability is maintained even during full braking. This increases active driving safety.

ABS is operational every time you start the engine.

### Electronic brake-force distribution EBV

The system controls the brake pressure in the rear wheels to ensure stable braking behavior.

### CBC Cornering Brake Control

When braking in curves or during a lane change, driving stability and steering response are improved further.

## BRAKE ASSISTANT

When the brakes are applied rapidly, this system automatically produces the maximum braking force boost. In this way, the system helps keep the braking distance as short as possible. This system utilizes all of the benefits provided by ABS.

Do not reduce the pressure on the brake pedal for the duration of full braking.

## DYNAMIC STABILITY CONTROL DSC

### The concept

DSC prevents traction loss in the driving wheels when driving away and accelerating.

DSC also recognizes unstable vehicle conditions, such as fishtailing or nose-diving. Subject to physical limits, DSC helps to keep the vehicle on a steady course by reducing engine speed and by applying brakes to the individual wheels.

DSC is operational every time you start the engine.



Adjust your driving style to the situation

An appropriate driving style is always the responsibility of the driver.

The laws of physics cannot be repealed, even with DSC.

Do not reduce the additional safety margin with a risky driving style, as otherwise there is a risk of an accident. ◀

### Deactivating DSC

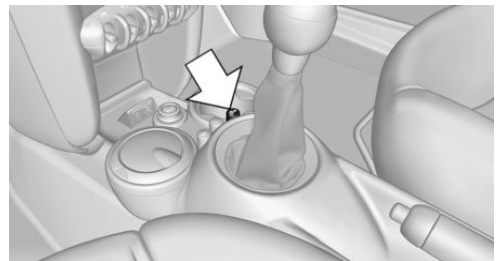



Press the button until the DSC OFF indicator lamp lights up in the speedometer and DSC OFF appears in the tachometer. DSC is deactivated. Intervening measures to stabilize the vehicle and give it forward momentum are no longer executed.

When driving with snow chains or to rock the vehicle free of snow, it may be useful to deactivate DSC temporarily.

To increase vehicle stability, activate DSC again as soon as possible.

### Activating DSC

Press the button again; the DSC indicator lamps in the display elements go out.

### Indicator/warning lamps



The indicator lamp in the tachometer flashes: DSC is controlling the drive forces and brake forces.

The indicator lamp lights up: DSC and DTC has failed.



The indicator lamp in the speedometer lights up and DSC OFF appears in the tachometer.

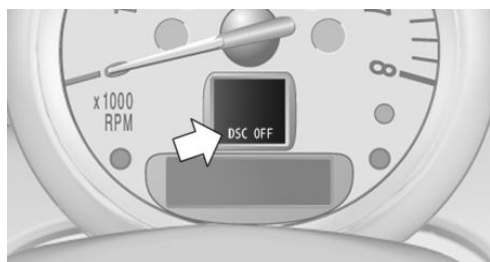

DSC and DTC deactivated.

## DYNAMIC TRACTION CONTROL DTC

### The concept

The DTC system is a version of the DSC in which forward momentum is optimized.

The system ensures maximum forward momentum on special road conditions, e.g., unplowed snowy roads, but driving stability is limited.

It is therefore necessary to drive with appropriate caution.

You may find it useful to briefly activate DTC under the following special circumstances:

- ▷ When driving in sand, on snowy inclines, in slush, or on unplowed, snow-covered road surfaces
- ▷ When rocking a vehicle free or starting off in deep snow, sand, or on loose ground
- ▷ When driving with snow chains.

### Activating DTC

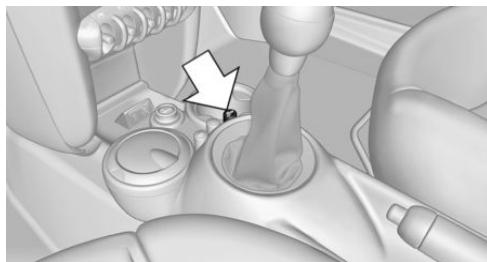

Press the button; the DSC OFF indicator lamp lights up in the speedometer and TRACTION appears in the tachometer. Dynamic Stability Control DSC is deactivated, Dynamic Traction Control DTC is activated.

### Deactivating DTC

Press the button again; the DSC OFF indicator lamp in the speedometer and TRACTION in the tachometer go out.

## Indicator/warning lamps



The indicator lamp in the tachometer flashes: DTC is controlling the drive forces and brake forces.

The indicator lamp lights up: DSC and DTC has failed.



The indicator lamp in the speedometer lights up and TRACTION appears in the tachometer.

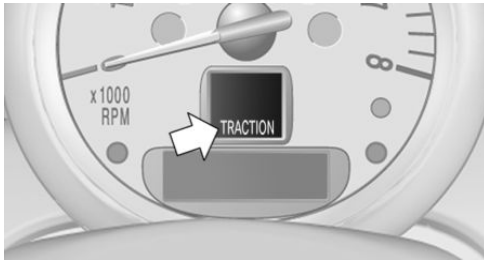

DTC is activated.

## HILL DRIVE-OFF ASSISTANT

This system supports driving away on gradients. The handbrake is not required.

1. Hold the vehicle in place with the foot brake.
2. Release the foot brake and drive away without delay.



Driving off without delay

After releasing the foot brake, start driving without delay, since the drive-off assistant will not hold the vehicle in place for more than approx. 2 seconds and the vehicle will begin rolling back. ◀

## SPORT BUTTON

When this button is pressed, the vehicle responds in an even sportier manner.

- ▷ The engine responds more spontaneously to accelerator movements.
- ▷ The steering responds more directly.
- ▷ Cooper S, John Cooper Works: the engine sounds sportier when coasting.
- ▷ For automatic transmissions: more rapid gear changes in the Sport program.

## Activating the system

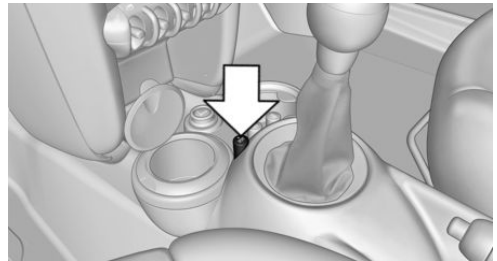

Press the button; the LED in the button lights up and SPORT is displayed briefly in the tachometer.

## Deactivating the system

- ▷ Press the button again.
- ▷ Switch the engine off.

## MINI COUPE, MINI ROADSTER: AUTOMATIC REAR SPOILER

### General information

The automatic rear spoiler increases the driving stability of the vehicle.



Note the area of movement

Make sure that the area of movement of the rear spoiler is clear; otherwise, damage or injuries may result. ◀

Do not use the rear spoiler for pushing, or else it could be damaged.

Notes on the car washes and care, refer to page 259.

### Automatic operation

If the rear spoiler is retracted, it is in automatic mode when the engine is started. In this case, the system is initialized when the vehicle is set into motion; this may cause a short noise to be heard.

Automatic extension:

When the vehicle exceeds a speed of approx. 50 mph/80 km/h.

Automatic retraction:

When the vehicle drops below a speed of approx. 38 mph/60 km/h.

The rear spoiler cannot be manually retracted in automatic mode at speeds above 38 mph/60 km/h.

### Manual mode

Manual mode can, for example, be used to clean the rear spoiler when the ignition is switched on or the engine is running. In manual mode, the LED in the switch is lit.

If the rear spoiler stops in an intermediate position after it is extended and retracted multiple times, the system is overheated. The rear spoiler can be operated again after a short cooling period.

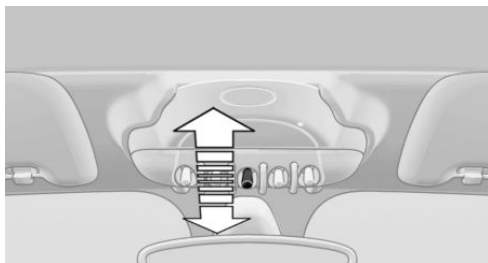

### Extending the rear spoiler

Press the switch back.

### Retracting the rear spoiler

If the rear spoiler was manually extended and a speed of 50 mph/80 km/h has not been exceeded, the rear spoiler can be retracted again. Otherwise, it can only be retracted after the speed drops to below 38 mph/60 km/h.

- ▷ Speed range between 12 mph/20 km/h and 50 mph/80 km/h: press the switch forward briefly or hold.
- ▷ Speed below 12 mph/20 km/h: press the switch forward and hold.

### Malfunction



The indicator lamp lights up briefly when the ignition is switched on and an acoustic signal is issued. A message appears on the Control Display.

Display in the following situations:

- ▷ The rear spoiler is extended.  
Retract the rear spoiler manually, or it is retracted again automatically at approx. 12 mph/20 km/h.
- ▷ The rear spoiler cannot be extended from the rear spoiler box.  
Check whether the rear spoiler is free of snow or ice, for example. Clear the rear spoiler or de-ice it.



The warning lamp lights up and an acoustic signal is issued a number of times. A message appears on the Control Display.

Display in the following situation:

The rear spoiler cannot be fully extended; refrain from exceeding a speed of 50 mph/80 km/h. Have the system checked.

If a malfunction occurs, Dynamic Stability Control DSC is activated at speeds greater than 30 mph/50 km/h.



# DRIVING COMFORT

## VEHICLE EQUIPMENT

This chapter describes all series equipment as well as country-specific and special equipment offered for this model series. Therefore, it also describes equipment that may not be found in your vehicle, for instance due to the selected special equipment or the country version. This also applies to safety-related functions and systems.

## CRUISE CONTROL

### The concept

The system is functional at speeds beginning at approx. 20 mph/30 km/h.

The vehicle stores and maintains the speed specified using the controls on the steering wheel.



Do not use cruise control

Do not use the system if unfavorable conditions make it impossible to drive at a constant speed, for instance:

- ▷ On curvy roads.
- ▷ In heavy traffic.
- ▷ On slippery roads, in fog, snow or rain, or on a loose road surface.

Otherwise, you could lose control of the vehicle and cause an accident. ◀

## Controls

### At a glance

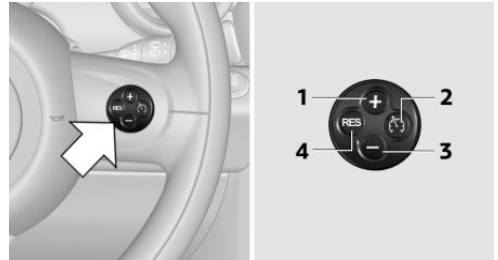

- 1 Maintaining, storing, and increasing the speed
- 2 Activating/deactivating cruise control
- 3 Maintaining, storing, and reducing the speed
- 4 Resuming cruise control

### Switching on

Press button 2.



The indicator lamp lights up in the speedometer. Cruise control is ready to operate and can be activated.

### Switching off

Press button 2.

- ▷ When activated: press twice.
- ▷ When interrupted: press once.

The displays go out. The stored target speed is cleared.

### Interrupting

Press button 2.

The system is interrupted automatically if

- ▷ The brakes are applied.
- ▷ The clutch pedal is depressed.

- ▷ The transmission position D is disengaged.
- ▷ DSC intervenes.

### Maintaining, storing the current speed

Press button 1 or button 3.

The current speed is maintained and stored. It is displayed briefly in the tachometer.

On downhill gradients, it may prove impossible to maintain the set speed if the engine braking power is insufficient. On uphill gradients, it may prove impossible to maintain the set speed if the engine power output is insufficient.

### Increasing speed

- ▷ Press button 1 repeatedly until the desired speed is reached.

Each time the button is pressed, the speed increases by approx. 1 mph/1 km/h.

- ▷ Press and hold button 1 until the desired speed is reached.

The vehicle accelerates without pressure on the accelerator pedal. After the button is released, the achieved speed is maintained and stored.

### Decreasing speed

Press button 3 repeatedly or hold it until the desired speed is reached.

The functions are the same those when the speed is increased, only that the speed is reduced.

### Resuming a speed stored beforehand

Press button 4.

The last stored speed is resumed and maintained.

The stored speed is cleared when the ignition is switched off.

### Display in the tachometer



The selected speed is displayed briefly.

If the display --- mph or --- km/h appears briefly, conditions may not be adequate to operate the system.

### For better control



The indicator lamp lights up in the speedometer. Cruise control is ready to operate and can be activated.

### Malfunction



The warning lamp in the tachometer lights up. A message appears on the Control Display. The system is malfunctioning or has failed.

## PARK DISTANCE CONTROL PDC

### The concept

PDC provides support when parking in reverse. Signal tones and a visual display indicate that the vehicle is approaching an object behind it. Measurements are made by four ultrasound sensors in the bumpers.

The range of these sensors is approx. 6 ft/2 m.

An acoustic warning is first given:

- ▷ By the two corner sensors at approx. 24 in/60 cm.

- ▷ By the rear middle sensors at approx. 5 ft/1.50 m.



Avoid driving quickly with PDC

PDC is a parking aid that can display objects when the vehicle approaches them slowly, as is the case during parking maneuvers. Avoid driving toward an object quickly as the system may then be too late in issuing a warning for technical reasons. ◀

### Automatic operation

The system is activated after approx. one second when reverse gear or selector lever position R is engaged while the engine is running or the ignition is switched on. Await this short period before setting the vehicle into motion.

### Signal tones

The closer the vehicle is to the object, the shorter the intervals become. If the distance to a detected object is less than approx. 12 in/30 cm, a continuous tone is sounded.

If the distance remains constant, for example when driving parallel to a wall, the signal tone is stopped after approx. 3 seconds.

### PDC with visual warning

Displaying the approach to an object on the Control Display. The contours of distant objects are displayed on the Control Display before a signal tone is output. The display is shown on the Control Display as soon as reverse gear or selector lever position R is engaged.

### System limits



Check the traffic situation as well

PDC cannot serve as a substitute for the driver's personal judgment of the traffic situation. Check the traffic situation around the vehicle with your own eyes. Otherwise, an accident could result from road users or objects located outside of the PDC detection range.

Loud noises from outside and inside the vehicle may prevent you from hearing the PDC's signal tone. ◀

### Malfunction



The warning lamp lights up. A message appears on the Control Display. PDC is malfunctioning or has failed. Have the system checked.

To ensure full functionality of the sensors, keep the sensors clean and free of ice. When using high-pressure washers, do not spray the sensors for long periods and maintain a distance of at least 12 in/30 cm.

# CLIMATE

## VEHICLE EQUIPMENT

This chapter describes all series equipment as well as country-specific and special equipment offered for this model series. Therefore, it also

describes equipment that may not be found in your vehicle, for instance due to the selected special equipment or the country version. This also applies to safety-related functions and systems.

## AIR CONDITIONING

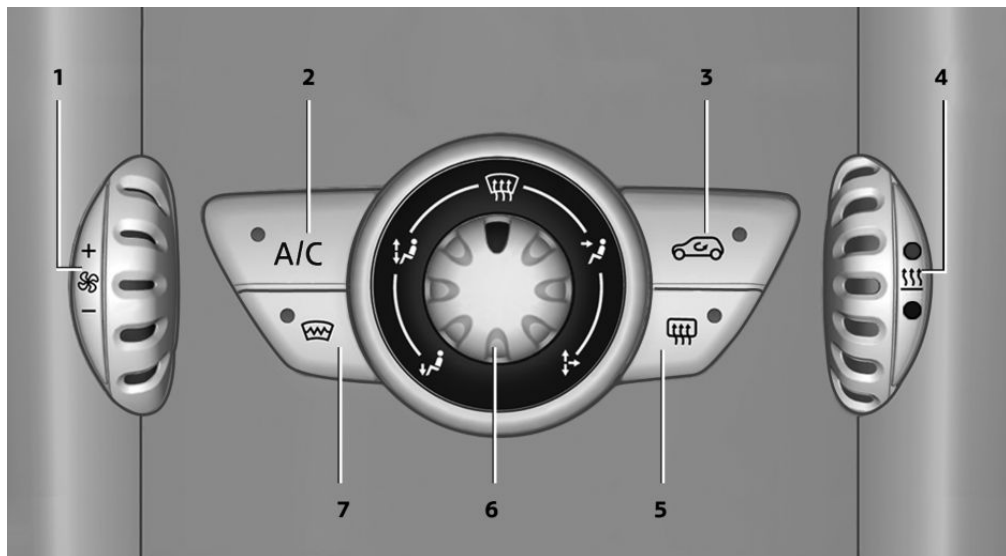

- |   |                       |   |                       |
|---|-----------------------|---|-----------------------|
| 1 | Air volume            | 5 | Rear window defroster |
| 2 | Cooling function      | 6 | Vent settings         |
| 3 | Recirculated air mode | 7 | Windshield heating    |
| 4 | Temperature           |   |                       |

### Air volume



Vary the air volume. The higher the rate, the more effective the heating or cooling will be.

The air flow rate may be reduced or the blower may be switched

off entirely to save on battery power.

### Switching the system on/off

Turn the rotary switch for the air volume to 0. The blower and air conditioner are completely switched off and the air supply is cut off.

Set any air volume to switch on the air conditioning.

## Cooling function



The passenger compartment can only be cooled with the engine running.

The cooling function cools and dehumidifies the incoming air before reheating it as required, according to the temperature setting.

The cooling function helps to prevent condensation on the windows or to remove it quickly.

Depending on the weather, the windshield may fog up briefly when the engine is started.

To cool the air faster and more intensively when external temperatures are high, switch on the recirculated air mode.

## Recirculated air mode



If the air outside the car has an unpleasant odor or contains pollutants, shut off the supply to the interior of the car temporarily.

The system then recirculates the air currently within the vehicle.

Should the windows fog up in the recirculated-air mode, press the AUTO button or switch off the recirculated-air mode and increase the air volume if necessary. Make sure that air can flow onto the windshield.

Recirculated air mode is automatically deactivated at low external temperatures.

 Only use recirculated air mode for a limited period

The recirculated air mode should not be used continuously for lengthy periods; otherwise, the quality of the air inside the car will gradually deteriorate. ◀

## Temperature



Turn upward, red, to raise the temperature.

Turn downward, blue, to lower the temperature.

## Rear window defroster





The rear window defroster switches off automatically after a certain period of time.

The rear window defroster power may be lowered or even switched off entirely to save on battery power.

## Vent settings



Direct the flow of air to the windows  , to the upper body area  , or to the footwell  . Intermediate positions are possible.

## Windshield heating



The windshield heating switches off automatically after some time.

The windshield heating may be reduced or even switched off entirely to save on battery power.

## Defrosting and defogging windows

1. Set the maximum air volume.
2. Air distribution in position  .  
By switching on the cooling function, the windows are defogged more rapidly.
3. Set the highest temperature, red.
4. Deactivate recirculated air mode.
5. Switch on the windshield heating if necessary.
6. Switch on the rear window defroster if necessary.

### Microfilter

The microfilter traps dust and pollen. The microfilter is changed by the service center during routine maintenance work.

### Microfilter/activated-charcoal filter

The microfilter traps dust and pollen. The activated-charcoal filter provides additional protec-

tion by filtering gaseous pollutants from the outside air. The service center replaces this combined filter during routine maintenance.

## AUTOMATIC CLIMATE CONTROL

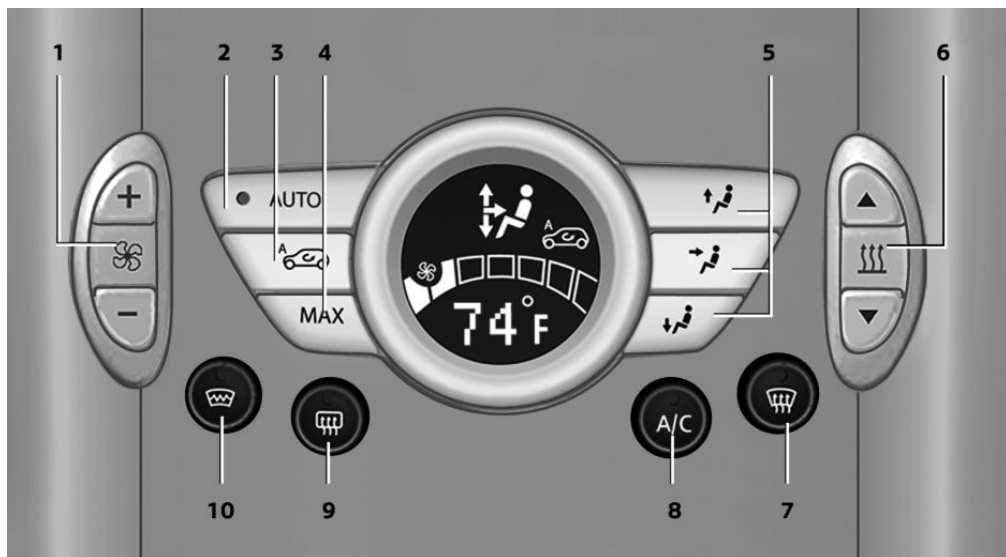

- |                                                                                                                                                                                                                      |                                                                                                                                                                                              |
|----------------------------------------------------------------------------------------------------------------------------------------------------------------------------------------------------------------------|----------------------------------------------------------------------------------------------------------------------------------------------------------------------------------------------|
| <ul style="list-style-type: none"> <li>1 Air volume, manual</li> <li>2 AUTO program</li> <li>3 Recirculated air mode</li> <li>4 Maximum cooling</li> <li>5 Manual air distribution</li> <li>6 Temperature</li> </ul> | <ul style="list-style-type: none"> <li>7 Defrosting windows and removing condensation</li> <li>8 Cooling function</li> <li>9 Rear window defroster</li> <li>10 Windshield heating</li> </ul> |
|----------------------------------------------------------------------------------------------------------------------------------------------------------------------------------------------------------------------|----------------------------------------------------------------------------------------------------------------------------------------------------------------------------------------------|

### Comfortable interior climate

The AUTO program offers the optimum air distribution and air volume for virtually all conditions, refer to AUTO program below. Select a comfortable interior temperature only.

The following sections contain more detailed information on the available setting options. Most of these settings are stored for the remote control in use, Personal Profile settings, refer to page 31.

## Air volume, manual



Press the – button to reduce the air volume. Press the + button to increase the air volume.

The automatic mode for the air volume can be switched on again using the AUTO button.

The air flow rate may be reduced or the blower may be switched off entirely to save on battery power. The display remains the same.

## Switching the system on/off

Reduce the air volume by pressing the – button until the system is switched off. All displays go out.

Press the AUTO button to switch the automatic climate control back on.

## AUTO program



The AUTO program automatically adjusts the air distribution to the windshield and side windows, toward the upper body area, and into the footwell. The

air volume and your specifications for the temperature are adjusted to outside influences due to the seasons, e. g., solar radiation.

The cooling function is switched on automatically with the AUTO program.

The program is switched off if the air distribution is manually adjusted or the button is pressed again.

## Convertible program

When the convertible top is open, the convertible program is activated. In the convertible program, the automatic climate control is optimized for driving with the convertible top open. In addition, the air flow rate is increased as vehicle speed increases.

The effectiveness of the convertible program can be enhanced considerably by installing the wind deflector.

## Recirculated air mode



If the air outside the car has an unpleasant odor or contains pollutants, shut off the supply to the interior of the car temporarily.

The system then recirculates the air currently within the vehicle.

Should the windows fog up in the recirculated-air mode, press the AUTO button or switch off the recirculated-air mode and increase the air volume if necessary. Make sure that air can flow onto the windshield.

Recirculated air mode is automatically deactivated at low external temperatures.

 Only use recirculated air mode for a limited period

The recirculated air mode should not be used continuously for lengthy periods; otherwise, the quality of the air inside the car will gradually deteriorate. ◀

## Maximum cooling



Automatic climate control switches to the lowest temperature, a high air volume, and recirculated air mode.

For maximum cooling, open the vents for the upper body area.

The air is cooled as quickly as possible:

- ▷ At an external temperature above 32 °F/0 °C.
- ▷ When the engine is running.

## Manual air distribution



The flow of air is directed, as selected, to the windows, to the upper body area, or to the footwell.

The automatic mode for the air distribution can be switched back on using the AUTO button.

## Temperature



Set the desired temperature individually.

The automatic climate control achieves this temperature as quickly as possible regardless of

the season, using maximum cooling or heating power if necessary, and then maintains it.

When switching between different temperature settings in rapid succession, the automatic climate control does not have sufficient time to adjust the set temperature.

## Rear window defroster



The rear window defroster switches off automatically after a certain period of time.

## Defrosting and defogging windows



Quickly removes ice and condensation from the windshield and front side windows. For this purpose, also switch on the cooling function.

The windshield heating switches on automatically.

## Windshield heating



The windshield heating switches off automatically after some time.

## Cooling function



The cooling function cools and dehumidifies the incoming air before reheating it as required, according to the temperature setting. The passenger compartment can only be cooled with the engine running.

The cooling function helps to prevent condensation on the windows or to remove it quickly.

Depending on the weather, the windshield may fog up briefly when the engine is started. Recirculated air mode is switched on automatically if necessary.

The cooling function is switched on automatically when the AUTO button is pressed.

## Microfilter/activated-charcoal filter

The microfilter traps dust and pollen. The activated-charcoal filter provides additional protection by filtering gaseous pollutants from the outside air. The service center replaces this combined filter during routine maintenance.



## VENTILATION

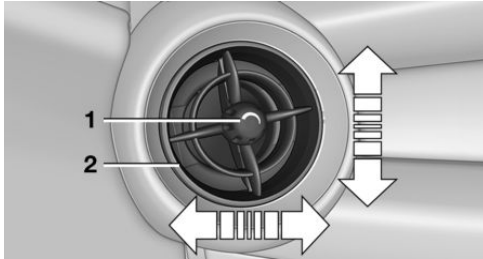

- 1 Knob for continuous opening and closing
- 2 Nozzle for direction of air flow

### Opening/closing

Turn the knob.

### Direction of air flow

Pivot the entire nozzle.

# INTERIOR EQUIPMENT

## VEHICLE EQUIPMENT

This chapter describes all series equipment as well as country-specific and special equipment offered for this model series. Therefore, it also describes equipment that may not be found in your vehicle, for instance due to the selected special equipment or the country version. This also applies to safety-related functions and systems.

## CUPHOLDERS AND ASHTRAY/LIGHTER



### Cupholders

Two cupholders are located in the center console in the front and another at the end of the center console in the rear.

 Shatter-proof containers and no hot drinks

Use light and shatter-proof containers and do not transport hot drinks. Otherwise, there is the increased danger of injury in an accident. ◀

 Unsuitable containers  
Do not forcefully push unsuitable containers into the cupholders. This may result in damage. ◀

### Ashtray

The ashtray is located in one of the cupholders in the center console at the front.

### Emptying

Take out the entire ashtray, arrow.

### Lighter

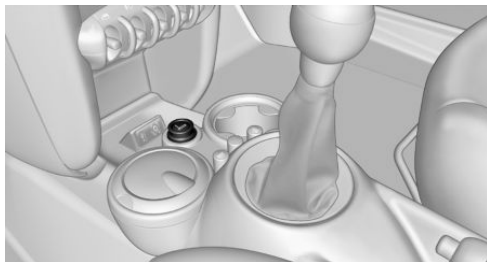

With the engine running or the ignition switched on, press in the cigarette lighter.

The lighter can be removed as soon as it pops back out.

 Danger of burns  
Only hold the hot lighter by its head; otherwise, there is the danger of getting burned.  
Switch off the ignition and take the remote control with you when leaving the vehicle so that children cannot use the lighter and burn themselves. ◀

## CONNECTING ELECTRICAL DEVICES

The lighter socket can be used as a socket for electrical equipment while the engine is running or when the ignition is switched on. The total load of all sockets must not exceed 140 watts at 12 volt.

Avoid damaging the sockets by attempting to insert plugs of unsuitable shape or size.

 Do not connect the charger to the socket  
Do not connect the battery charger to the socket installed in the vehicle at the factory as this could damage the battery. ◀

 Replace the cover after use  
Replace the lighter or socket cover after use; otherwise, objects that fall into the lighter socket or power socket could cause a short circuit. ◀

### Socket in the center console

Remove the cover or lighter, refer to page 114, from the socket.

### Socket in the cargo area

#### MINI Coupe, MINI Roadster

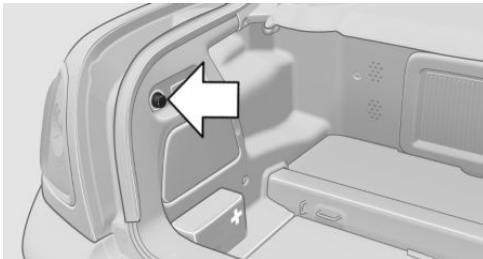

Take out the cover.

#### MINI Convertible

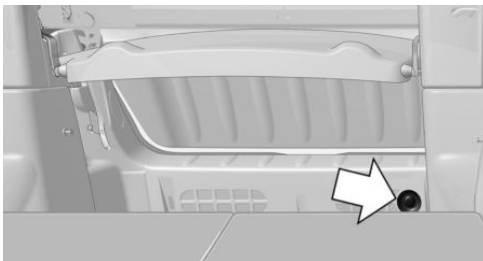

Take out the cover.

## CARGO AREA

### MINI Coupe: cargo cover

 Do not place objects on the covers  
Do not place objects on the cover; if you do so, they may pose a danger to vehicle occupants during braking or evasive maneuvers or damage the cover. ◀

The MINI Coupe is equipped with two cargo covers. When the tailgate is opened, the rear cargo cover is raised.

The covers can be removed individually.

#### Front cover

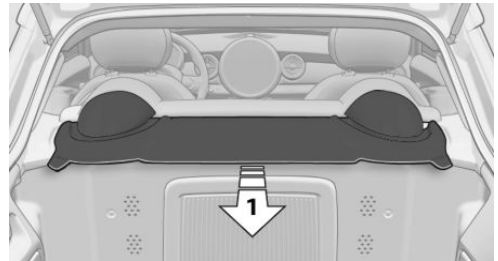

Pull the cover backwards out of the brackets, arrow 1.

#### Rear cover

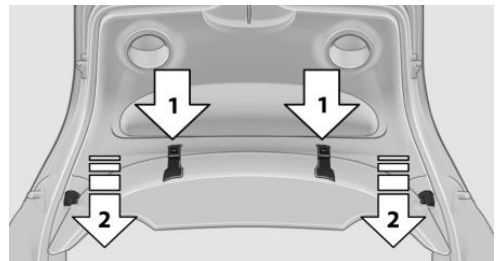

1. Pull the releases, arrow 1, on the left and right.
2. Pull the cover down out of the brackets, arrow 2.

## MINI Coupe, MINI Roadster: through-loading opening

### Securing cargo

Always secure transported snowboards or similar objects as they could otherwise endanger occupants during braking or swerving. ◀

1. Fold the seat forward if necessary, refer to page 54.
2. Unlock the lock using the integrated key, refer to page 30.

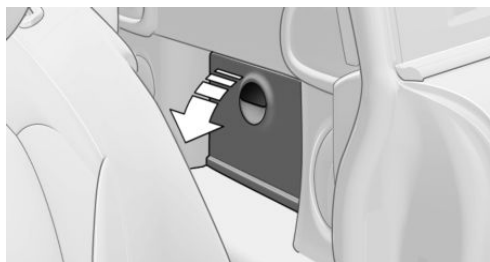

3. Pull the handle and fold down the lid.

## MINI Coupe, MINI Roadster: storage compartment in cargo area

The front of the cargo area contains a storage compartment under a cover panel.



The figure shows an example of the cargo area of the MINI Coupe.

1. Open the through-loading opening from the passenger compartment.
2. Fold up the cover panel, arrow 1.

## MINI Convertible: cargo area

 Do not place objects on the cargo cover  
Do not place objects on the cargo cover; otherwise, the cover or the convertible top could be damaged. ◀

### Loading aid

When the convertible top is closed, unlocking and folding up the convertible top may make it easier to load the vehicle.

1. Unlock the convertible top with the handles, see arrows 1.

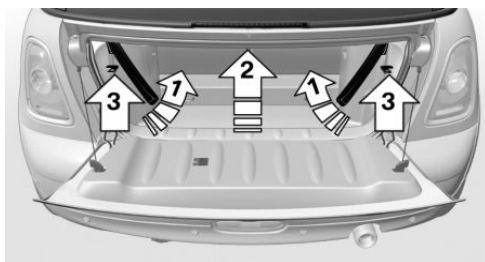

2. Raise the convertible top, see arrow 2.
3. Fold back the handles and rest them on the brackets 3.

### Enlarging the cargo area

When the convertible top is closed, the cargo area can be enlarged.

1. Fold the convertible top upward, refer to Loading aid.

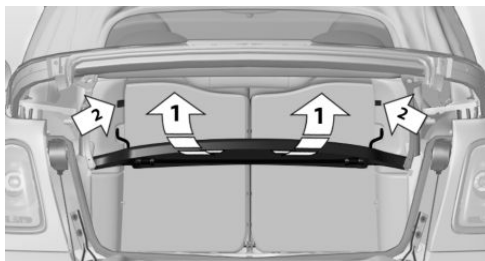

2. Pull the trunk cover backwards out of the lower holders and swing up, see arrows 1.

3. Slide into the upper holders, arrows 2, and set down horizontally.

Move the trunk cover back into the lower position so that the convertible top can be operated.

### Through-loading system

To enable the transport of larger objects, the rear seat backrest can be folded down.

1. Using the integrated key, unlock the lock 1 of the rear seat backrest.
2. Press button 2 and fold the rear seat backrest forward while guiding the safety belt.

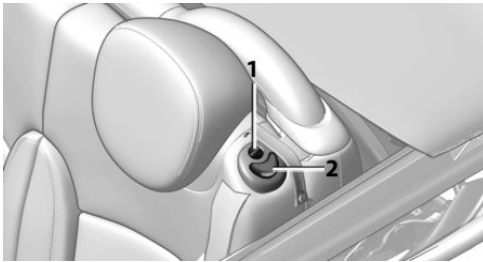

3. Fold down the backrest.



#### Locking the backrest

Before taking along passengers in the rear, fold back the backrests. When folding back, ensure that the locks engage properly; otherwise, cargo could be catapulted forward into the passenger compartment during braking maneuvers and swerving, endangering the occupants.

The belt guide loop must be closed. ◀

# STORAGE COMPARTMENTS

## VEHICLE EQUIPMENT

This chapter describes all series equipment as well as country-specific and special equipment offered for this model series. Therefore, it also describes equipment that may not be found in your vehicle, for instance due to the selected special equipment or the country version. This also applies to safety-related functions and systems.

## NOTES

 No loose objects in the passenger compartment

Do not stow any objects in the passenger compartment without securing them; otherwise, they may present a danger to occupants for instance during braking and avoidance maneuvers. ◀

 No non-slip mats on the dashboard  
Do not use non-slip materials, such as non-slip mats, on the dashboard, or it could be damaged by the substances in the materials. ◀

## STORAGE COMPARTMENTS

### Interior

- ▷ Glove compartment, refer to page 118.
- ▷ Center armrest, refer to page 119.
- ▷ Storage compartment on the passenger side, refer to page 119.
- ▷ Compartments in the center console.
- ▷ Compartments in the doors.
- ▷ Compartments next to the rear seats.
- ▷ MINI Coupe, MINI Roadster: rear storage shelf behind the seats, refer to page 120.

- ▷ Nets on the back of the front seat backrests and in the front passenger footwell.
- ▷ Cupholder, refer to page 114.

### Cargo area

- ▷ Net on the cargo area floor and on the side trim.
- ▷ Lashing eyes, refer to page 129.
- ▷ MINI Coupe, MINI Roadster: storage compartment in the cargo area, refer to page 116.

## GLOVE COMPARTMENT

### Opening

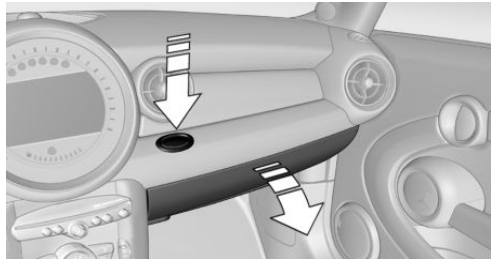

Press the button to open the lid.

The light in the glove compartment switches on.

### Closing

Fold up the cover.

 Close the glove compartment again immediately

Close the glove compartment immediately after use while driving; otherwise, injury may occur during accidents. ◀

### MINI Convertible, MINI Roadster: locking

Lock the glove compartment using the integrated key of the remote control, refer to page 30.

### Ventilation

Depending on the vehicle's equipment, the glove compartment can be ventilated and, if the cooling function is switched on, cooled.

### Opening

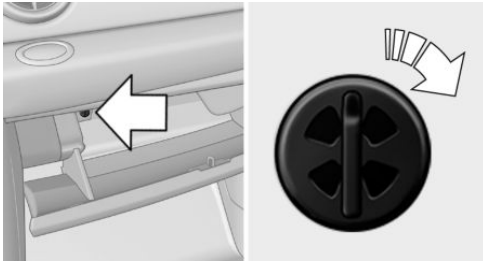

Turn the switch in the direction of the arrow.

### Closing

Move the switch to the vertical position by turning it in the opposite direction of the arrow.

### USB interface for data transfer

Updating the navigation data, refer to page 136, from the USB medium via the USB interface in the glove compartment.

Observe the following when connecting:

- Do not use force when plugging the connector into the USB interface.
- Do not connect devices such as fans or lamps to the USB interface.
- Do not connect USB hard drives.
- Do not use the USB interface to recharge external devices.

## CENTER ARMREST

The center armrest between the front seats contains a storage compartment or a cover for the snap-in adapter, refer to page 202, depending on the version.



### Opening

The lid is mounted on rails and can be fully opened by sliding it back and lifting.

### Closing

Slide the lid forward.

## STORAGE COMPARTMENT ON THE PASSENGER SIDE

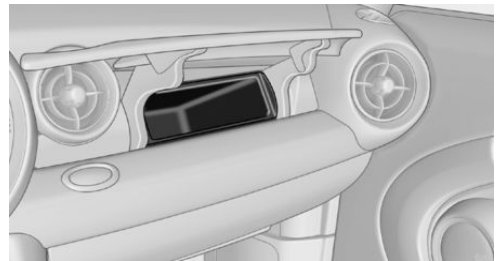

### Opening

Briefly press the bottom edge of the cover panel.

### Closing

Push back the cover panel to the initial position.

 Close the storage compartment again immediately after use.

Close the storage compartment again immediately after use while driving; otherwise, injury may occur during accidents. ◀

### MINI Convertible, MINI Roadster

The storage compartment cannot be locked.

## MINI COUPE, MINI ROADSTER: REAR STORAGE SHELF BEHIND THE SEATS

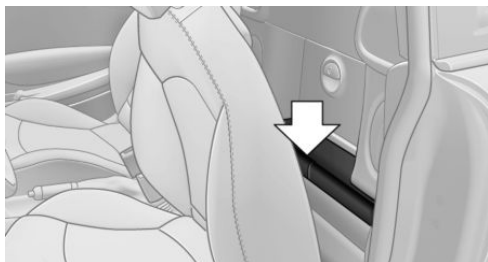

This space can be used to store briefcases, for example.

 No heavy objects

Only transport light and small objects on the rear storage shelf; otherwise, braking maneuvers and swerving may lead to a safety hazard due to objects flying about the passenger compartment. Only transport heavy luggage in the cargo area if it has been appropriately secured. ◀

## CONNECTION FOR AN EXTERNAL AUDIO DEVICE

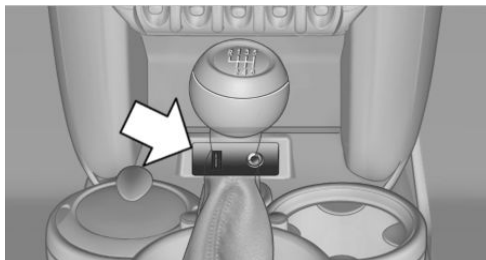

This can be used to connect an external audio device, refer to page 171, such as a CD or MP3 player.





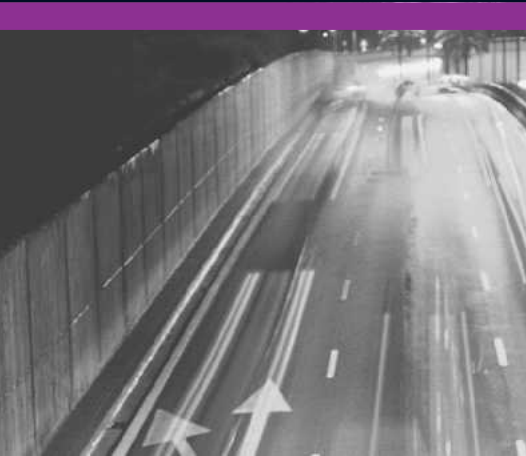

**AT A GLANCE**

**CONTROLS**

**DRIVING TIPS**

**NAVIGATION**

**ENTERTAINMENT**

**COMMUNICATION**

**MOBILITY**

**REFERENCE**

# THINGS TO REMEMBER WHEN DRIVING

## VEHICLE EQUIPMENT

This chapter describes all series equipment as well as country-specific and special equipment offered for this model series. Therefore, it also describes equipment that may not be found in your vehicle, for instance due to the selected special equipment or the country version. This also applies to safety-related functions and systems.

## BREAKING-IN PERIOD

### General information

Moving parts need to be broken in to adjust to each other.

The following instructions will help achieve a long vehicle life and good economy.

### Engine and differential

Always obey all official speed limits.

### Up to 1,200 miles/2,000 km

Drive at various engine and vehicle speeds, but do not exceed:

- ▷ For a gasoline engine, 4,500 rpm and 100 mph/160 km/h.

Avoid full-throttle operation and use of the transmission's kickdown mode for the initial miles.

### From 1,200 miles/2,000 km

The engine and vehicle speed can gradually be increased.

### Tires

Due to technical factors associated with their manufacture, tires do not achieve their full trac-

tion potential until after an initial breaking-in period.

Drive conservatively for the first 200 miles/300 km.

### Brake system

Brakes require an initial break-in period of approx. 300 miles/500 km to achieve optimized contact and wear patterns between brake pads and discs. Drive cautiously during this break-in period.

### Clutch

The clutch requires an initial break-in period of approx. 300 miles/500 km to function at an optimal level.

During this break-in period, engage the clutch gently.

### Following part replacement

The same breaking in procedures should be observed if any of the components mentioned above have to be renewed in the course of the vehicle's operating life.

## GENERAL DRIVING NOTES

### Ground clearance



Ensure adequate ground clearance

Ensure adequate ground clearance, e.g., when driving into underground garages, when driving over curbs, or when driving in winter; otherwise, damage may occur to the vehicle. ◀

## Closing the tailgate



Drive with the tailgate closed

Only drive with the tailgate closed; otherwise, passengers and other road users may be endangered or the vehicle may be damaged if an accident occurs or during braking or swerving. In addition, exhaust fumes may enter the passenger compartment. ◀

If, despite this, the vehicle must be driven with the tailgate open:

- ▷ Drive moderately.
- ▷ Coupe: close all windows.
- ▷ Switch off recirculated air mode and greatly increase the blower speed.

## Hot exhaust system



Hot exhaust system

High temperatures are generated in the exhaust system.

Do not remove the heat shields installed and never apply undercoating to them. Make sure that flammable materials, e. g. hay, leaves, grass, etc. do not come in contact with the hot exhaust system during driving, while in idle position mode, or when parked. Such contact could lead to a fire, and with it the risk of serious personal injury as well as property damage.

Do not touch hot exhaust pipes; otherwise, there is the danger of getting burned. ◀

## Mobile communication devices in the vehicle



Mobile communication devices in the vehicle

It is not recommended to use mobile phones, such as mobile phones without a direct connection to an external aerial in the vehicle's passenger compartment. Otherwise, the vehicle electronics and mobile communication devices can interfere with each other. In addition, there is no assurance that the radiation gener-

ated during transmission will be discharged from the vehicle interior. ◀

## Hydroplaning

On wet or slushy roads, a wedge of water can form between the tires and road surface.

This phenomenon is referred to as hydroplaning. It is characterized by a partial or complete loss of contact between the tires and the road surface, ultimately undermining your ability to steer and brake the vehicle.



Hydroplaning

When driving on wet or slushy roads, reduce your speed to prevent hydroplaning. ◀

The risk of hydroplaning increases as the tire tread depth decreases. Minimum tread depth, refer to page 230.

## Driving through water

Drive through calm water only if it is not deeper than 12 inches/30 cm and at this height, no faster than walking speed, up to 6 mph/10 km/h.



Adhere to water depth and speed limitations

Do not exceed this water depth and walking speed; otherwise, the vehicle's engine, the electrical systems and the transmission may be damaged. ◀

## Using the handbrake on inclines



Using the handbrake

On inclines, do not hold the vehicle stationary with a slipping clutch for extended period; use the handbrake instead. Otherwise, the clutch will be subject to increased wear. ◀

Support from the hill drive-off assistant, refer to page 103.

## Braking safely

The vehicle is equipped with ABS as a standard feature.

Applying the brakes fully is the most effective way of braking in situations when this is necessary.

The vehicle maintains steering responsiveness. You can still avoid any obstacles with a minimum of steering effort.

Pulsation of the brake pedal and sounds from the hydraulic circuits indicate that ABS is in its active mode.

 Do not let your foot rest on the brake pedal

Do not drive with your foot resting on the brake pedal. Even light but consistent pedal pressure can lead to high temperatures, brake wear and possibly even brake failure. ◀

## Objects in the area around the pedals

 No objects in the area around the pedals  
Keep floor mats, carpets, and any other objects out of the area of motion of the pedals; otherwise, the function of the pedals could be impeded while driving

Do not place additional floor mats over existing mats or other objects.

Only use floor mats that have been approved for the vehicle and can be properly fixed in place.

Ensure that the floor mats are securely fastened again when they are returned after being removed, such as for cleaning. ◀

## Driving in wet conditions

When roads are wet or there is heavy rain, briefly exert gentle pressure on the brake pedal every few miles.

Ensure that this action does not endanger other road users.

The heat generated in this process helps dry the brake discs and pads.

In this way braking efficiency will be available when you need it.

## Hills

Drive long or steep downhill gradients in the gear in which the least braking is required. Otherwise, the brake system may overheat, resulting in a reduction in the brake system efficiency.

You can increase the engine's braking effect by shifting down, going all the way to first gear, if necessary.

Downshifting in manual mode of the automatic transmission, refer to page 72.

 Avoid load on the brakes

Avoid placing excessive load on the brake system. Light but consistent brake pressure can lead to high temperatures, brake wear and possibly even brake failure. ◀

 Do not drive in neutral

Never drive with the transmission in neutral, with the engine switched off or with the clutch depressed; otherwise, you will have neither the braking action of the engine or nor its power assistance when braking or steering. ◀

## Brake disc corrosion

Corrosion on the brake discs and contamination on the brake pads are furthered by:

- ▷ Low mileage.
- ▷ Extended periods when the vehicle is not used at all.
- ▷ Infrequent use of the brakes.

Corrosion occurs when the minimum pressure that must be exerted by the pads during brake applications to clean the discs is not reached.

Should corrosion form on the brake discs, the brakes will tend to respond with a pulsating effect that generally cannot be corrected.

### **When the vehicle is parked**

When using the automatic climate control, condensation water develops that exits underneath the vehicle.

Therefore, traces of condensed water under the vehicle are normal.

After the engine is switched off, the coolant pump may continue running for some time in the MINI Cooper S. This causes noises in the engine compartment.

# LOADING

## VEHICLE EQUIPMENT

This chapter describes all series equipment as well as country-specific and special equipment offered for this model series. Therefore, it also describes equipment that may not be found in your vehicle, for instance due to the selected special equipment or the country version. This also applies to safety-related functions and systems.

## GENERAL INFORMATION

### Overloading the vehicle

To avoid exceeding the approved carrying capacity of the tires, never overload the vehicle. Overloading can lead to overheating and increases the rate at which damage develops inside the tires. This could result in a sudden loss of tire inflation pressure. ◀

### No fluids in the cargo area

Make sure that fluids do not leak into the cargo area; otherwise, the vehicle may be damaged. ◀

## DETERMINING THE LOAD LIMIT

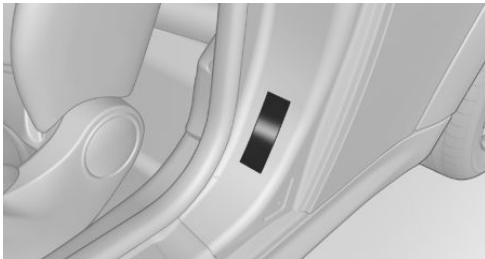

1. Locate the following statement on your vehicle's placard:

▷ The combined weight of occupants and cargo should never exceed XXX kg or YYY lbs. Otherwise, damage to the vehicle and unstable driving situations may result.

2. Determine the combined weight of the driver and passengers that will be riding in your vehicle.
3. Subtract the combined weight of the driver and passengers from XXX kilograms or YYY pounds.
4. The resulting figure equals the available amount of cargo and luggage load capacity.

For example, if the YYY amount equals 1,000 lbs and there will be four 150 lbs passengers in your vehicle, the amount of available cargo and luggage load capacity is 400 lbs: 1,000 lbs minus 600 lbs = 400 lbs.

5. Determine the combined weight of luggage and cargo being loaded on the vehicle. That weight may not safely exceed the available cargo and luggage load capacity calculated in Step 4.
6. If your vehicle will be towing a trailer, load from your trailer will be transferred to your vehicle. Consult the manual for transporting a trailer to determine how this may reduce the available cargo and luggage load capacity of your vehicle.

## LOAD

MINI Coupe, MINI Roadster:



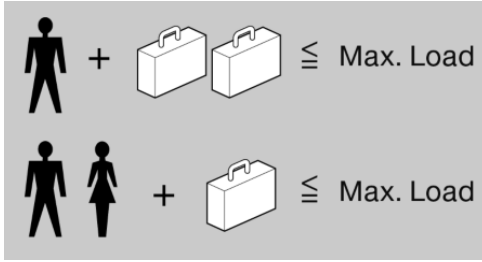

MINI Convertible:

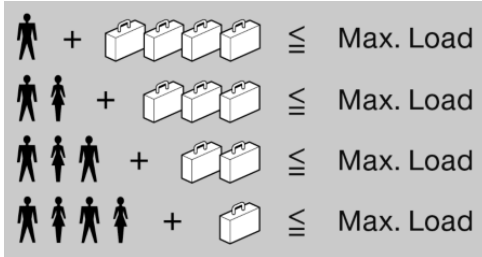

The maximum load is the sum of the weight of the occupants and the cargo.

The greater the weight of the occupants, the less cargo that can be transported.

## STOWING CARGO

- ▶ Very heavy cargo: when the rear seat is not occupied, secure each of the outer safety belts in the opposite buckle.
- ▶ Heavy cargo: stow as far forward and as low as possible, ideally directly behind the backrests.
- ▶ Cover sharp edges and corners.
- ▶ If necessary, fold down the rear backrests to stow cargo.
- ▶ Place protective material around any sharp-edged or pointed objects that could bump against the rear window while the vehicle is in motion.

## MINI Coupe, MINI Roadster

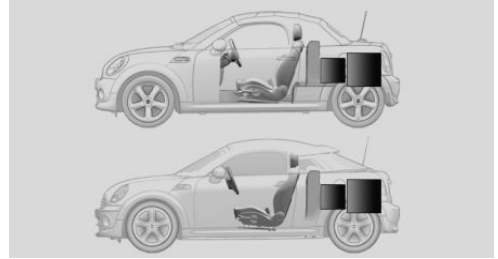

## MINI Convertible

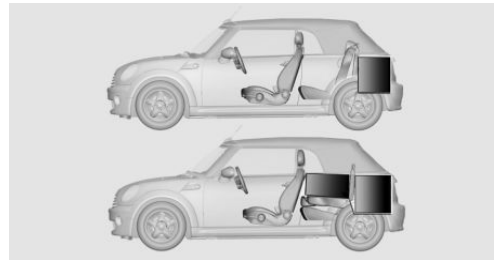

## SECURING CARGO

### Lashing eyes in the cargo area

## MINI Coupe, MINI Roadster

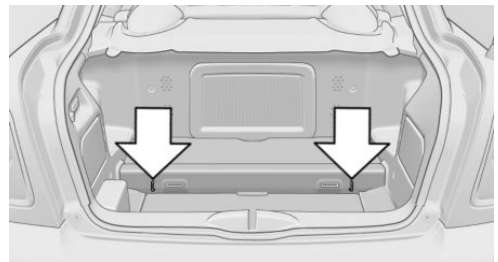

## MINI Convertible

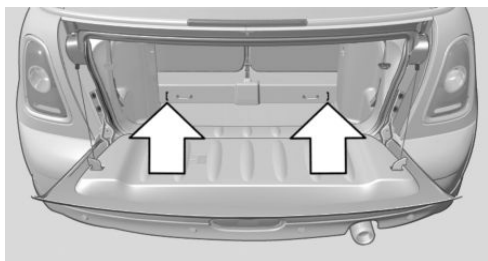

### Securing cargo

- ▷ Secure smaller and lighter pieces with tightening belts or straps.
- ▷ Secure larger and heavier pieces with cargo straps.

Adhere to the information included with the cargo straps.

- ▷ Four lashing eyes are available for fastening the cargo straps. Two of them are located on the inside wall of the cargo area.



#### Securing cargo

Stow and secure the cargo as described above; otherwise it may present a danger to the occupants, for instance during braking and avoidance maneuvers.

Do not stow any heavy and hard objects in the passenger compartment without securing them; otherwise, they may present a danger to occupants, for instance during braking and avoidance maneuvers.

Never exceed either the approved gross vehicle weight or either of the approved axle loads, as excessive loads can pose a safety hazard, and may also place you in violation of traffic safety laws.

Do not secure cargo using the upper LATCH mounting points, refer to page 61; otherwise, these may become damaged. ◀

## REAR LUGGAGE RACK

### Notes

A special rear rack is available as an optional accessory. It does not require a trailer hitch.

Follow the installation instructions for the rear rack.

### Anchorage points

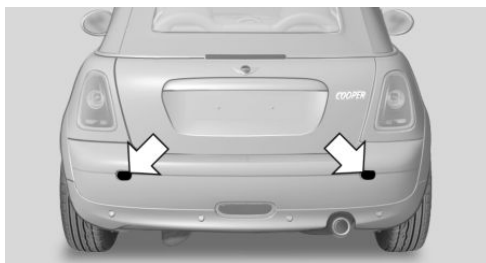

The anchorage points are under the covers in the bumper.

Push out the covers on the corresponding cut-outs.

### Loading

When loading the vehicle, ensure that the approved gross vehicle weight and the axle loads are not exceeded. Adhere to the weight specifications in the technical data.

# SAVING FUEL

## VEHICLE EQUIPMENT

This chapter describes all series equipment as well as country-specific and special equipment offered for this model series. Therefore, it also describes equipment that may not be found in your vehicle, for instance due to the selected special equipment or the country version. This also applies to safety-related functions and systems.

## GENERAL INFORMATION

Your vehicle contains advanced technology for the reduction of fuel consumption and emissions.

Fuel consumption depends on a number of different factors. The implementation of certain measures, driving style and regular maintenance can have an influence on fuel consumption and on the environmental impact.

### Remove unnecessary cargo

Additional weight increases fuel consumption.

### Remove attached parts following use

Remove rear-mounted luggage racks after use.

Attached parts on the vehicle impair the aerodynamics and increase the fuel consumption.

### Close both windows

Open windows causes higher air resistance and thus increases fuel consumption.

### Check the tire inflation pressure regularly

Check and, if necessary, correct the tire inflation pressure, refer to page [222](#), at least twice a month and before starting on a long trip.

Low tire inflation pressure increases rolling resistance and thus raises fuel consumption and tire wear.

### Drive away without delay

Do not wait for the engine to warm-up while the vehicle remains stationary. Start driving right away, but at moderate engine speeds. This is the fastest way for the cold engine to reach its operating temperature.

### Look well ahead when driving

Avoid unnecessary acceleration and braking. To achieve this, maintain a suitable distance to the vehicle driving ahead of you.

Driving smoothly and looking ahead reduces fuel consumption.

### Avoid high engine speeds

Use 1st gear to get the vehicle in motion. Beginning with 2nd gear, accelerate rapidly. When accelerating, shift up before reaching high engine speeds.

When you reach the desired speed, shift into the highest applicable gear and drive with the engine speed as low as possible and at a constant speed.

As a rule: driving at low engine speeds lowers fuel consumption and reduces wear.

### Use coasting conditions

When approaching a red light, take your foot off the accelerator and coast to a halt in the highest applicable gear.

On a downhill slope, take your foot off the accelerator and coast in a suitable gear.

The flow of fuel is interrupted while coasting.

## Switch off the engine during longer stops

Switch off the engine during longer stops, e.g., at traffic lights, railroad crossings or in traffic congestion.

Fuel savings are already achieved after the engine is turned off for as little as 4 seconds.

## Automatic Engine Start/Stop Function

The Automatic Engine Start/Stop Function automatically switches the engine off during a stop.

If the engine is stopped and then started again, fuel consumption and emissions drop compared to an engine that runs permanently. Stopping the engine even for just a few seconds can result in savings.

In addition, fuel consumption depends on other factors as well, such as driving style, road conditions, maintenance, and environmental factors.

## Switch off any functions that are not currently needed

Functions such as seat heating and the rear window defroster require a lot of energy and consume additional fuel, especially in city and stop-and-go traffic.

Therefore, switch off these functions if they are not actually needed.

## Have maintenance carried out

Have vehicles maintained regularly to achieve optimal vehicle economy and operating life. Have the maintenance carried out by the service center.

Please also note the MINI maintenance system, refer to page [241](#).





**AT A GLANCE**

**CONTROLS**

**DRIVING TIPS**

**NAVIGATION**

**ENTERTAINMENT**

**COMMUNICATION**

**MOBILITY**

**REFERENCE**

# NAVIGATION SYSTEM

## VEHICLE EQUIPMENT

This chapter describes all series equipment as well as country-specific and special equipment offered for this model series. Therefore, it also describes equipment that may not be found in your vehicle, for instance due to the selected special equipment or the country version. This also applies to safety-related functions and systems.

## GENERAL INFORMATION

The navigation system can determine the precise position of the vehicle, with the aid of satellites and vehicle sensors, and can reliably guide you to every entered destination.



### Entries in stationary vehicle

Enter data only when the vehicle is stationary, and always give priority to the applicable traffic regulations in the event of any contradiction between traffic and road conditions and the instructions issued by the navigation system. Failure to take to this precaution can place you in violation of the law and put vehicle occupants and other road users in danger. ◀

## Opening the navigation system

1. "Navigation"

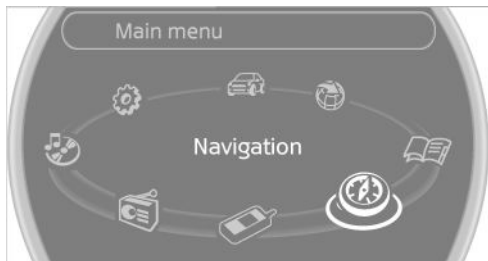

During destination guidance, the arrow or map view appears on the Control Display.

## NAVIGATION DATA

### Information on navigation data

1. "Navigation"
2. Open "Options".
3. "Navigation system version"

Information is displayed on the data version.

### Updating the navigation data

#### General information

Navigation data are stored in the vehicle and can be updated.

Current navigation data and the authorization code are available from your service center.

- ▷ Depending on the data volume, a data update may take several hours.
- ▷ Update during the trip to preserve battery.
- ▷ The status of the update can be viewed.
- ▷ The data are stored in the vehicle.
- ▷ After the updating process is complete, the system restarts.
- ▷ Remove the medium with the navigation data after the update.

### Performing the update

1. Depending on the equipment: insert the USB device with the navigation data into the USB interface in the glove compartment or in the USB audio interface.
2. Follow the instructions on the Control Display.
3. Enter the authorization code of the USB device with the navigation data.
4. Drive off.

The update starts after the authorization code is entered.



When the update is completed, the system re-starts.

# DESTINATION ENTRY

## VEHICLE EQUIPMENT

This chapter describes all series equipment as well as country-specific and special equipment offered for this model series. Therefore, it also describes equipment that may not be found in your vehicle, for instance due to the selected special equipment or the country version. This also applies to safety-related functions and systems.

## AT A GLANCE

In entering your destination, it is possible to select from the following options:

- ▷ Enter the destination manually, see below.
- ▷ Select the destination from the address book, refer to page 140.
- ▷ Last destinations, refer to page 141.
- ▷ Special destinations, refer to page 142.
- ▷ Destination entry via map, refer to page 143.
- ▷ Using the home address as the destination, refer to page 141.
- ▷ Destination entry by voice, refer to page 144.

## MANUAL DESTINATION ENTRY

### General information

The system supports you in entering street names and house numbers by automatically completing the entry and providing entry comparisons, refer to page 23.

Stored town/city and street names can be called up quickly.

- ▷ If the existing entries should not be changed, the entries for the state/province and town/city can be skipped.
- ▷ Destination guidance is started to the town/city center if no street is entered.

### Entering a state/province

1. "Navigation"
2. "Enter address"

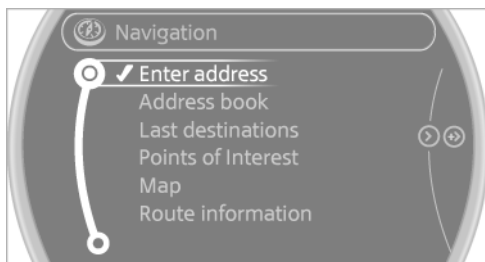

3. Select "State/Province" or the displayed state/province.

### Entering a town/city

1. Select "Town/City/Postal Code" or the displayed town/city.

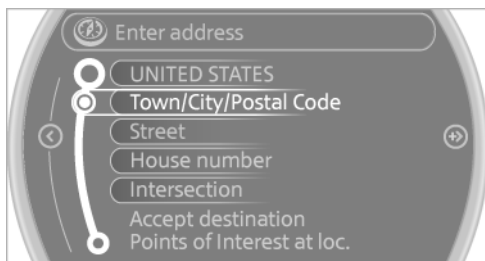

2. Select letters, if necessary.  
The list is narrowed down further with each entry.
3. Move the MINI joystick to the right.
4. Select the name of the town/city from the list.

If there are several towns/cities with the same name:

1. Change to the list of town/city names.
2. Highlight the town/city.
3. Select the town/city.

### Entering the postal code

1. Select "Town/City/Postal Code" or the displayed town/city.
2. 1@+. Select the symbol.
3. Select the digits individually.
4. Change to the list of postal codes and towns/cities.
5. Highlight the entry.
6. Selecting an entry.  
The associated destination town/city is displayed.

### Entering a street and intersection

1. Select "Street" or the displayed street.
2. Enter a street and intersection in the same way as you would enter a town/city.

If there are several streets with the same name:

1. Change to the list of street names.
2. Highlight the street.
3. Select the street.

### Alternative: enter the street address and house number

1. Select "Street" or the displayed street.
2. Enter the street as you would the town/city.
3. "House number"
4. Select the numbers.
5. Change to the list of house numbers.
6. Select a house number or range of house numbers.

### Street does not exist in the destination city/town

The desired street does not exist in the specified city/town because it belongs to another part of the city/town.

1. "Navigation"
2. "Enter address"
3. Select "Street" or the displayed street.
4. Change to the list of street names.
5. Select "In" with the state/province currently displayed.

All streets of the selected state/province are offered. The associated town/city is displayed after the street name.



6. Select the letters.
7. Change to the list of street names.
8. Highlight the street.
9. Select the street.

### Starting destination guidance after entering the destination

1. "Accept destination"
2. "Start guidance" or "Add as another destination"

Add a destination as a further destination, refer to page 146.

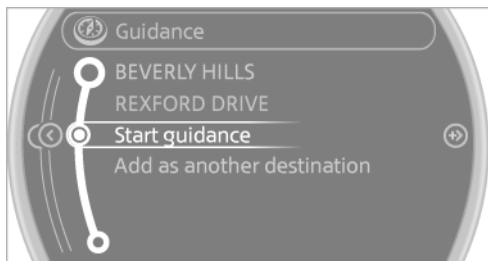

### Storing the destination in the address book

After entering the destination, store the destination in the address book.

1. "Navigation"
2. "Map"
3. "Guidance"
4. Open "Options".
5. "Store as new contact" or "Add to existing contact"

## ADDRESS BOOK

Create contacts, refer to page 189.

### Selecting a destination from the address book

1. "Navigation"
2. "Address book"

Contacts with addresses are displayed if these addresses have been checked as destinations in the contacts.

If the contacts with addresses from the mobile phone are not displayed, they first need to be checked as destinations, refer to page 191.

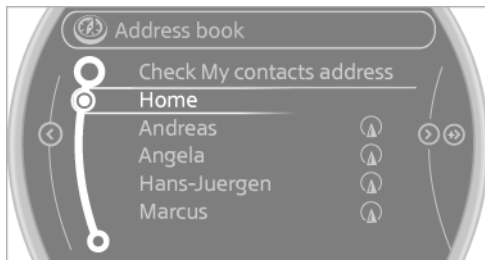

6. Select an existing contact, if available.
7. "Business address" or "Home address"
8. Enter "Last name" and, if necessary, "First name".
9. "Store in vehicle"

### Storing the position

The current position can be stored in the address book.

1. "Navigation"
2. Open "Options".

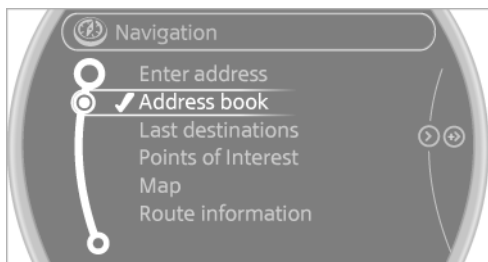

3. Select a contact in the list or, if desired, with "A-Z search".
4. "Business address" or "Home address"

3. "Store position as contact" or "Add position to contact"

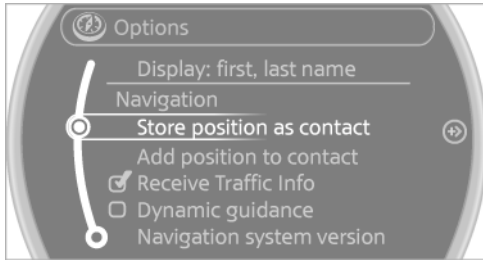

4. Depending on the selection, choose an existing contact from the list. Select the type of address and enter the first and last name.

5. "Store in vehicle"

### Editing or deleting an address

1. "Navigation"
2. "Address book"
3. Highlight the entry.
4. Open "Options".
5. "Edit in Contacts" or "Delete entry"

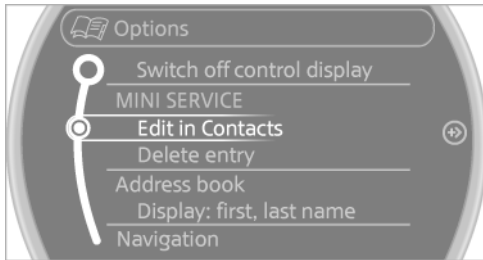

### Using the home address as the destination

The home address must be stored. Specify the home address, refer to page 190.

1. "Navigation"
2. "Address book"

3. "Home"

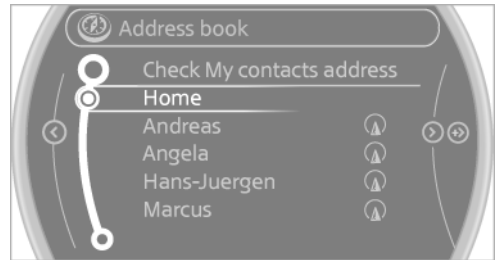

4. "Start guidance"

## LAST DESTINATIONS

### At a glance

The destinations previously entered are stored automatically. These destinations can be called up and used as a destination for destination guidance.

### Calling up the last destination

1. "Navigation"
2. "Last destinations"

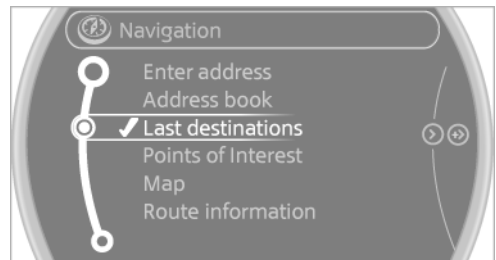

### Starting destination guidance

1. "Navigation"
2. "Last destinations"
3. Select the destination.
4. "Start guidance"

## Editing the destination

Destinations can be edited, for example to change the house number of an existing entry.

1. "Navigation"
2. "Last destinations"
3. Highlight the destination.
4. Open "Options".
5. "Edit destination"

## Deleting the last destinations

1. "Navigation"
2. "Last destinations"
3. Highlight the destination.
4. Open "Options".
5. "Delete entry" or "Delete all last destinations"

## SPECIAL DESTINATIONS

### General information

Even with the latest navigation data, information on individual special destinations may have changed; for example, gas stations might not be in operation.

### Opening the search for special destinations

Selection of special destinations, such as hotels or tourist attractions.

1. "Navigation"
2. "Points of Interest"
3. Select the search function.

### A-Z search

1. "A-Z search"
2. "Town/City"
3. Select or enter the town/city.
4. "Category"

5. Select the category.
6. "Category details"

For some special destinations, it may be possible to select multiple category details. Move the MINI joystick to the left to leave the category details.

7. "Keyword"
8. Enter the keyword.  
A list of the special destinations is displayed.
9. Select a special destination.  
Details are displayed.  
If multiple details are stored, you can leaf through the pages.  
If a phone number is available, a connection can be established if necessary.
10.  Select the symbol.
11. "Start guidance" or "Add as another destination"

Add a destination as a further destination, refer to page [146](#).

### Category search

1. "Category search"
2. "Search destination"
3. Select or enter the town/city.
4. "Category"
5. Select the category.
6. "Category details"

For some special destinations, it may be possible to select multiple category details. Move the MINI joystick to the left to leave the category details.

7. "Start search"  
A list of the special destinations is displayed.
8. Select a special destination.  
Details are displayed.  
If multiple details are stored, you can leaf through the pages.

If a phone number is available, a connection can be established if necessary.

9.  Select the symbol.
10. "Start guidance" or "Add as another destination"  
Add a destination as a further destination, refer to page 146.

### Position of special destinations

When entering the search location, various options can be selected.

- ▷ "At current location"
- ▷ "At destination"
- ▷ "At different location"
- ▷ If destination guidance is active: "Along route"

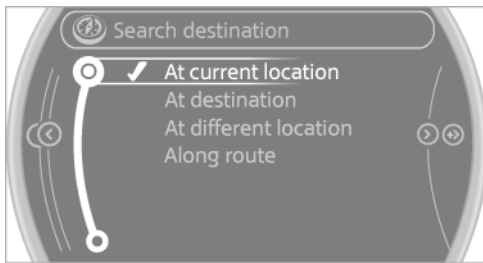

### Starting the search for special destinations

1. "Start search"
2. A list of the special destinations is displayed.
  - ▷ "At current location"  
The special destinations are listed according to their distance and are displayed with a directional arrow pointing to the destination.
  - ▷ "At destination", "At different location", "Along route"  
Special destinations are listed according to their distance from the location where the search is being performed.

- ▷ Destinations of the selected category are displayed in the map view as symbols. The display depends on the map scale and the category.

3. Highlight the special destination.
4. Select a special destination.
5.  Select the symbol.
6. "Start guidance" or "Add as another destination"  
The direct distance to destination is displayed.

### Displaying special destinations in the map

To display symbols of the special destinations in the map view:

1. "Navigation"
2. "Map"
3. Open "Options".
4. "Display Points of Interest"

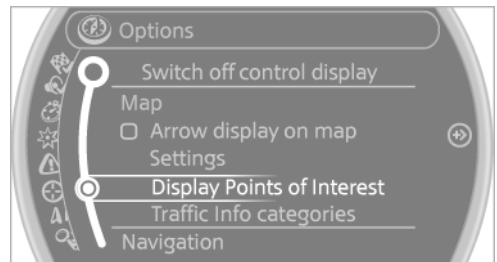

5. Select the setting.

## DESTINATION ENTRY BY MAP

### General information

If only the location of the destination town/city or street is known, the destination can be entered using the map.

### Selecting the destination

1. "Navigation"
2. "Map"

The current position of the vehicle is displayed on the map.

3.  "Interactive map"

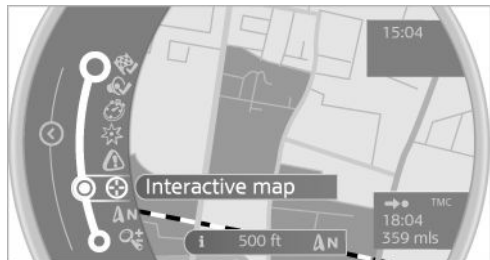

4. Select the destination with crosshairs.
  - ▷ To change the scale: turn the MINI joystick.
  - ▷ To shift the map: move the MINI joystick in the required direction.
  - ▷ To shift the map diagonally: move the MINI joystick in the required direction and turn the MINI joystick.
5. Press the MINI joystick to display additional menu items.
  - ▷  Select the symbol: "Start guidance" or "Add as another destination".
  - ▷ "Find points of interest": the search for special destinations is started.

### Specifying the street

If the system does not recognize the street, one of the following pieces of information is displayed:

- ▷ A street name in the vicinity.
- ▷ The coordinates of the destination.

### Additional functions

On the interactive map, the scale can be adjusted and the map section can be shifted.

Pressing the MINI joysticks makes additional functions available:

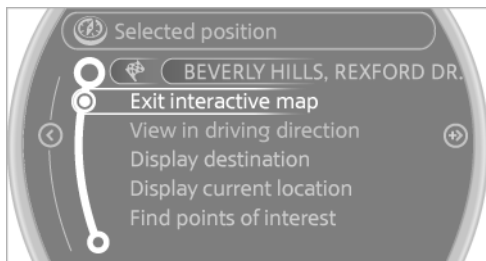

- ▷  Select the symbol. "Start guidance" or "Add as another destination"
- ▷ "Exit interactive map": return to the map view.
- ▷ Map view
- ▷ "Display destination": the map section around the destination is displayed.
- ▷ "Display current location": the map section around your current location is displayed.
- ▷ "Find points of interest": the search for special destinations is started.

## DESTINATION ENTRY BY VOICE

### General information

- ▷ Instructions for voice activation system, refer to page 24.
- ▷ When making a destination entry by voice, you can change between voice activation and the onboard monitor.
- ▷ To have the available spoken instructions read out loud: ›Voice commands‹.

### Saying the entries

- ▷ Countries, towns and cities, streets, and intersections can be said as whole words or spelled in the language of the system, refer to page 80.



Example: to enter a town/city in a US states as a whole word, the language of the system must be English.

- ▷ Spell the entry if the spoken language and the language of the system differ.
- ▷ Say the letters smoothly, and avoid exaggerating the pronunciation and inserting lengthy pauses between the letters.
- ▷ The methods of entry depend on the navigation data in use and the country and language settings.

### Entering a town/city separately

The town/city can be said as a complete word.

1.  Press the button on the steering wheel.
2. ›City‹ or ›Spell city‹
3. Wait for the system to prompt you for the town/city.
4. Say the name of the town/city, or name at least the first three letters.
5. Select a location:
  - ▷ Select a recommended town/city: ›Yes‹.
  - ▷ Select a different town/city: ›New entry‹.
  - ▷ Select an entry: ›Entry ...‹, for instance, entry 2.
  - ▷ Spell an entry: ›Spell city‹.
6. Continue making the entry as prompted by the system.

If there are several towns/cities with the same name:

Towns/cities of the same name are grouped in a list and displayed as one location followed by an ellipsis.

1. Select an entry: ›Yes‹ or ›Entry ...‹, e. g., Entry 2.
2. Select the desired town/city.

The town/city can also be selected from the list on the onboard monitor:

Turn the MINI joystick until the destination town/city is selected and press the MINI joystick.

### Entering a street or intersection separately

Enter a street and intersection in the same way as you would enter a town/city.

### Entering a house number separately

Depending on the data in the navigation system, house numbers up to number 2,000 can be entered.

1. ›House number‹
2. Say the house number.
3. ›Yes‹ to confirm the house number.
4. ›Accept destination‹

### Starting destination guidance

›Start guidance‹

### Adding further intermediate destinations

›Add as another destination‹

Further intermediate destinations can be added.

### Storing a destination

The destination is automatically added to the list of last destinations.

## PLANNING A TRIP WITH INTERMEDIATE DESTINATIONS

### New trip

Various intermediate destinations can be entered for a trip. The trip destination needs to be entered first, destination entry, refer to page 138.

## Entering intermediate destinations

A maximum of 30 intermediate destinations can be entered for a trip.

1. "Navigation"
2. Select the type of destination entry and enter the intermediate destination.

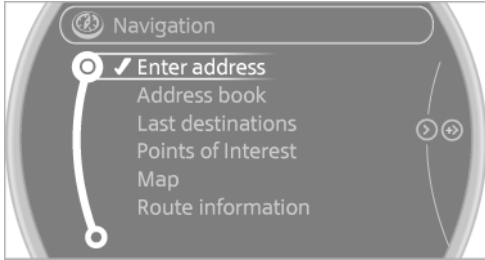

3. "Add as another destination"

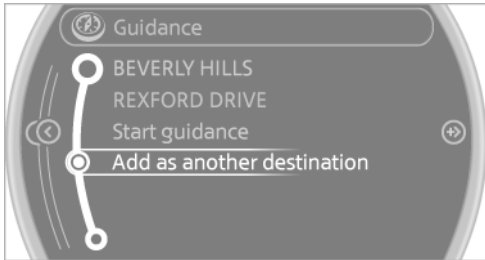

4. Select the position where the intermediate destination is to be inserted.

## Starting the trip

After all intermediate destinations have been entered:

"Start guidance"

# DESTINATION GUIDANCE

## VEHICLE EQUIPMENT

This chapter describes all series equipment as well as country-specific and special equipment offered for this model series. Therefore, it also describes equipment that may not be found in your vehicle, for instance due to the selected special equipment or the country version. This also applies to safety-related functions and systems.

## STARTING DESTINATION GUIDANCE

1. "Navigation"
2. Make a destination entry, refer to page 138.
3. "Accept destination"
4. "Start guidance"

The route is shown on the Control Display.

The distance to the destination/intermediate destination and the estimated time of arrival are displayed in the map view.

The arrow view may appear on the Control Display.

## TERMINATING DESTINATION GUIDANCE

1. "Navigation"
2. "Map"
3.  Select the symbol.
4. "Stop guidance"

## CONTINUING DESTINATION GUIDANCE

If the destination was not reached during the last trip, destination guidance can be resumed.



"Resume guidance"

## ROUTE CRITERIA

### General information

- ▷ The route calculated can be influenced by selecting certain criteria.
- ▷ The route criteria can be changed when the destination is entered and during destination guidance.
- ▷ Road types are part of the navigation data and are taken into consideration when planning a route, e.g., avoid highways.
- ▷ The recommended route may differ from the route you would take based on personal experience.
- ▷ The settings are stored for the remote control currently in use.
- ▷ Destination guidance with traffic bulletins, refer to page 153.

### Changing the route criteria

1. "Navigation"
2. "Map"
3.  "Route preference"
4. Select the criterion:
  - ▷  "Fast route": time-optimized route, being a combination of the shortest possible route and the fastest roads.
  - ▷  "Efficient route": optimized combination of the fastest and shortest route.

- ▷  "Short route": short distance, irrespective of how fast or slow progress will be.
- ▷ "Alternative routes": if available, alternative routes are suggested during active destination guidance.

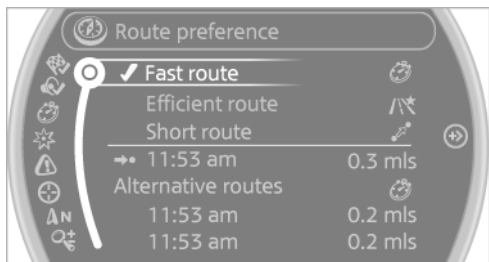

5. Select additional criteria for the route, if necessary. Where possible, the selected criteria are avoided on the route.
  - ▷ "Avoid highways": highways are avoided wherever possible.
  - ▷ "Avoid toll roads": toll roads are avoided wherever possible.
  - ▷ "Avoid ferries": ferries are avoided where possible.

## ROUTE

Different views of the route are available during destination guidance:

- ▷ Arrow view.
- ▷ List of route sections.
- ▷ Map view, refer to page 150.

### Arrow view

The following information is displayed during destination guidance:

- ▷ Large arrow: indicates the current direction of travel.
- ▷ Street name of the road currently being driven on.

- ▷ Small arrow: indicates the next change in direction.
- ▷ Intersection view.
- ▷ Lane information.
- ▷ Traffic bulletins.
- ▷ Distance to the next change in direction.
- ▷ Street name at the next change in direction.

### Lane information

On multi-lane roads, the recommended lanes are marked in the arrow view by a triangle.

- ▷ Solid triangle: best lane.
- ▷ Empty triangle: possible lane. However, another lane change may be needed shortly.

### Displaying a list of route sections

When destination guidance is active, a list of the route sections can be displayed. The driving distance and traffic bulletins are displayed for each route section.

1. "Navigation"
2. "Route information"

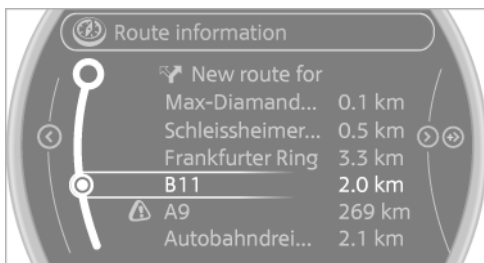

3. Highlight a route section.

## BYPASSING A SECTION OF THE ROUTE

Calculate a new route for a route section.

1. "Navigation"
2. "Route information"

## 3. "New route for"

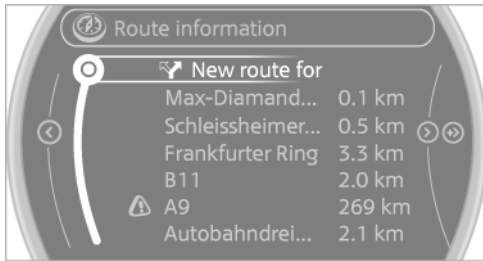

- Turn the MINI joystick. Enter the number of kilometers within which you would like to return to the original route.
- Press the MINI joystick.

### Resuming the original route

If the route section should no longer be bypassed:

- "Navigation"
- "Route information"
- "New route for:"
- "Remove blocking"

## GAS STATION RECOMMENDATION

The remaining range is calculated and gas stations along the route are displayed if needed. Even with the latest navigation data, information on individual special destinations may have changed; for example, gas stations might not be in operation.

- "Navigation"
- "Route information"
- "Recommended refuel"  
A list of the gas stations is displayed.
- Highlight a gas station.
- Select the gas station.

- Select the symbol.
- "Start guidance": destination guidance to the selected gas station is started.  
"Add as another destination": the gas station is added to the route.

## DESTINATION GUIDANCE THROUGH VOICE INSTRUCTIONS

### Switching spoken instructions on/off

The spoken instructions can be switched on or off during destination guidance.

The setting is stored for the remote control currently in use.

- "Navigation"
- "Map"
- Select the symbol.

Symbol	Function
	The spoken instructions are switched on.
	Spoken instructions are switched off.

### Repeating a spoken instruction

- "Navigation"
- "Map"
- Highlight the symbol.
- Press the MINI joystick twice.

### Volume of spoken instructions

Turn the volume knob while giving an instruction until the desired volume is set.



This volume is independent of the volume of the audio sources.

The setting is stored for the remote control currently in use.

## MAP VIEW

### Selecting the map view

1. "Navigation"
2. "Map"

### At a glance

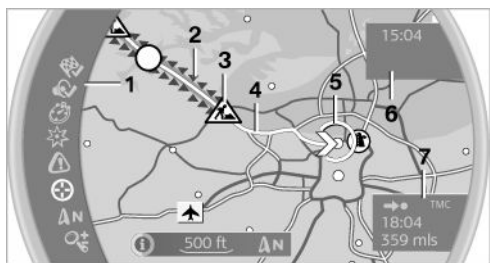

- 1 Function bar
- 2 Route section with traffic obstruction
- 3 Traffic sign for traffic obstruction
- 4 Planned route
- 5 Current location
- 6 Upper status field
- 7 Lower status field

### Lines in the map

Streets and routes are displayed in different colors and styles depending on their classifica-

tion. Dashed lines represent railways and ferry connections. Country borders are indicated by thin lines.

### Traffic obstructions

Small triangles along the planned route indicate route sections with traffic obstructions, depending on the map scale. The direction of the triangles indicates the direction of the obstruction.

The traffic signs indicate the significance of the obstruction.

- ▷ Red traffic sign: the obstruction affects the planned route or direction.
- ▷ Grey traffic sign: the obstruction does not affect the planned route or direction.

Traffic bulletins, refer to page 151.

### Planned route

After destination guidance is started, the planned route is displayed on the map.

### Status fields





To show/hide: press the MINI joystick.

- ▷ Upper status field: time, telephone, and entertainment details.
- ▷ Lower status field: symbol for active destination guidance, status of traffic bulletins, time of arrival, and distance to destination.

### Function bar

The following functions are available in the function bar:

Symbol	Function
	Start/end destination guidance.
	Switch spoken instructions on/off.
	Change the route criteria.
	Search for a special destination.

Symbol	Function
	Display traffic bulletins.
	Open the interactive map.
	Adjust the map views.
	Adjust the arrow view.
	Change the scale.

## Changing the map section

### "Interactive map"

- ▷ To shift the map: move the MINI joystick in the required direction.
- ▷ To shift the map diagonally: move the MINI joystick in the required direction and turn the MINI joystick.

## Changing the scale

1.  Select the symbol.
2. To change the scale: turn the MINI joystick.

## Automatically scaled map scale

In the map view facing north, turn the MINI joystick in any direction until the AUTO is displayed for the scale. The entire route between the current location and the destination is displayed on the map.

## Settings for the map view

The settings are stored for the remote control currently in use.

1. "Navigation"
2. "Map"
3. Open "Options".
4. "Settings"
5. To set the map view:
  - ▷ "Day/night mode"
 

Select and create the necessary settings depending on the light conditions.

"Traffic conditions/gray map" active: the setting is disregarded.

### ▷ "Traffic conditions/gray map"

The map is optimized for displaying traffic bulletins.

Symbols for the special destinations are no longer displayed.

## Arrow view

When destination guidance is activated, the arrow view can additionally be displayed in the map view on the right side of the display.

1. "Navigation"
2. Open "Options".
3. "Arrow display on map"

The arrow view is shown on the map.



## TRAFFIC BULLETINS

### At a glance

- ▷ Display the traffic bulletins from radio stations that broadcast the TI Traffic Information of a traffic information service. Information on traffic obstructions and hazards is updated continuously.
- ▷ The traffic bulletins are indicated on the map by symbols.
-  The symbol in the function bar of the map view turns red if there are traffic bulletins that affect the calculated route.

## Real Time Traffic Information End-User Provisions

Certain MINI models equipped with navigation have the capability to display real-time traffic information. If your system has this capability the following additional terms and conditions apply:

An End-User shall no longer have the right to use the Traffic Data in the event that the End-User is in material breach of the terms and conditions contained herein.

A. Total Traffic Network, a division of Clear Channel Broadcasting, Inc. ("Total Traffic Network") holds the rights to the traffic incident data and RDS-TMC network through which it is delivered. You may not modify, copy, scan or use any other method to reproduce, duplicate, republish, transmit or distribute in any way any portion of traffic incident data. You agree to indemnify, defend and hold harmless MINI of North America, LLC. ("MINI NA") and Total Traffic Network, Inrix, Inc (and their affiliates) against any and all claims, damages, costs or other expenses that arise directly or indirectly out of (a) your unauthorized use of the traffic incident data or the RDS-TMC network, (b) your violation of this directive and/or (c) any unauthorized or unlawful activities by you in connection herewith.

B. Total Traffic Network traffic data is informational only. User assumes all risk of use. Total Traffic Network, MINI NA, and their suppliers make no representations about content, traffic and road conditions, route usability, or speed.

C. The licensed material is provided to license "as is," and "where is". Total Traffic Network, including, but not limited to, any and all third party providers of any of the licensed material, expressly disclaims, to the fullest extent permitted by law, all warranties or representations with respect to the licensed material (including, without limitation, that the licensed material will be error-free, will operate without interruption or that the traffic data will be accurate), express, implied or statutory, including, without



limitation, the implied warranties of merchantability, non-infringement fitness for a particular purpose, or those arising from a course of dealing or usage of trade.

D. Neither Total Traffic Network, Inrix, Inc. or MINI NA will be liable to you for any indirect, special, consequential, exemplary, or incidental damages (including, without limitation, lost revenues, anticipated revenues, or profits relating to the same) arising from any claim relating directly or indirectly to use of the traffic data, and even if Total Traffic Network, Inrix, Inc., or MINI NA are aware of the possibility of such damages. These limitations apply to all claims, including, without limitation, claims in contract and tort (such as negligence, product liability and strict liability). Some states do not allow the exclusion or limitation of incidental or consequential damages, so those particular limitations may not apply to you.

### Switching the reception on/off

1. "Navigation"
2. Open "Options".
3. "Receive Traffic Info"

### Open the traffic bulletins

1. "Navigation"
2. "Map"
3.  "Traffic Info"  
First, traffic bulletins for the calculated route are displayed.  
The traffic bulletins are sorted by their distance from the current position of the vehicle.
4. Select a traffic bulletin.  
 "More information": display additional information.
5. Scroll to the next or previous traffic bulletin if required.

### Traffic bulletins on the map

"Traffic conditions/gray map" active:



The Control Display changes to a black and white display. This enables a better view of the traffic bulletins. The day/night mode is disregarded in this setting. Symbols and special destinations are not displayed.

1. "Navigation"
2. "Map"
3. Open "Options".
4. "Settings"
5. "Traffic conditions/gray map"

### Symbols in the map view

Depending on the scale of the map and the location of the traffic obstruction along the route, the symbols for the traffic obstructions are displayed.

### Additional information in the map view

Depending on the map scale, a traffic obstruction's length, direction, and impact are displayed in the map using triangles or gray bars along the calculated route.

- ▷ Red: traffic congestion.
- ▷ Orange: stop-and-go traffic.
- ▷ Yellow: heavy traffic.
- ▷ Green: clear roads.
- ▷ Gray: general traffic bulletins such as road construction.

The displayed information depends on the particular traffic information service.

### Filtering traffic bulletins

You can set which traffic bulletins appear on the map.

1. "Navigation"
2. "Map"
3. Open "Options".

4. "Traffic Info categories"
5. Select the desired category.

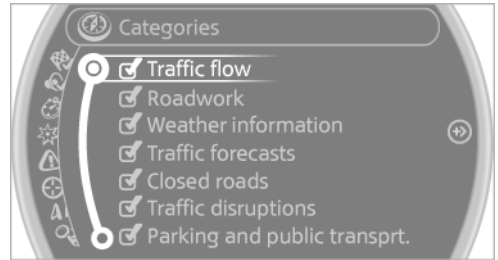

Traffic bulletins of the selected category are displayed on the map.

- ▷ Traffic bulletins that are relevant to the route are always shown.
- ▷ For your own safety, traffic bulletins that notify you of potentially dangerous situations cannot be hidden.

### Destination guidance with traffic bulletins

#### General information

Detour suggestions from the navigation system can be manually accepted when using semi-dynamic destination guidance. When using dynamic destination guidance, they are automatically accepted for route guidance.

#### Semi-dynamic destination guidance

When traffic bulletin reception is switched on, semi-dynamic destination guidance is active.



The destination guidance system takes the available traffic bulletins into account. A message is displayed depending on the route, the traffic bulletins, and the possible detour routes. If possible, a detour is offered in case of traffic obstructions. In addition, distance and time differences between the original route and the detour are displayed.

#### Accepting the detour

- 📍 "Detour"

In the event of special hazards, e. g., objects on the road, a message is displayed without a detour suggestion.

Detours can also be accepted if the traffic messages are called up in the list.

1. "Navigation"
2. "Map"
3.  "Traffic Info"
4. "Detour information"
5.  "Detour"

### Dynamic destination guidance

The route is automatically changed in the event of traffic obstructions.

- ▷ The system does not point out traffic obstructions along the original route.
- ▷ Traffic bulletins continue to be displayed on the map.
- ▷ Depending on road type and the kind and extent of the traffic obstruction, the calculated route may lead through the traffic obstruction.
- ▷ Dangerous situations are displayed regardless of the setting.

### Activating dynamic destination guidance

1. "Navigation"
2. Open "Options".
3. "Dynamic guidance"

# WHAT TO DO IF...

## VEHICLE EQUIPMENT

This chapter describes all series equipment as well as country-specific and special equipment offered for this model series. Therefore, it also describes equipment that may not be found in your vehicle, for instance due to the selected special equipment or the country version. This also applies to safety-related functions and systems.

## WHAT TO DO IF...

- ▷ The current transmission position cannot be displayed?

The vehicle is located in an unrecognized region, is in a poor reception area, or the system is currently determining the position. Reception is usually best when you have an unobstructed view of the sky.

- ▷ The destination without street information is not used for route guidance?

When city has been input, no downtown can be determined. Input any street in the selected city and start destination guidance.

- ▷ The destination is not used for route guidance?

The destination data are not contained in the navigation data. Select a destination that is as close as possible to the original.

- ▷ Letters for destination input cannot be selected?

The stored data do not contain the data of the destination. Select a goal that is as close as possible to the original.

- ▷ Is the map displayed in shades of gray?

"Traffic conditions/gray map" active:

The Control Display changes to a black and white display. This enables a better view of the traffic bulletins.

- ▷ Spoken instructions are no longer output during route guidance in front of intersections?

The area has not yet been fully recorded, or you have left the recommended route and the system requires a few seconds to calculate a new route suggestion.

- ▷ Does the navigation system fail to react to entries?

If the battery was disconnected, it takes up to 10 minutes for the system to becoming functional again.



**AT A GLANCE**

**CONTROLS**

**DRIVING TIPS**

**NAVIGATION**

**ENTERTAINMENT**

**COMMUNICATION**

**MOBILITY**

**REFERENCE**

# TONE

## VEHICLE EQUIPMENT

This chapter describes all series equipment as well as country-specific and special equipment offered for this model series. Therefore, it also describes equipment that may not be found in your vehicle, for instance due to the selected special equipment or the country version. This also applies to safety-related functions and systems.

## GENERAL INFORMATION

The sound settings are stored for the remote control currently in use.

## TREBLE, BASS, BALANCE, AND FADER

- ▷ "Treble": treble adjustment.
- ▷ "Bass": depth adjustment.
- ▷ "Balance": left/right volume distribution.
- ▷ "Fader": front/rear volume distribution.

### Setting treble, bass, balance, and fader

1. "CD/Multimedia", "Radio" or "Settings"
2. "Tone"



3. Select the desired tone settings.

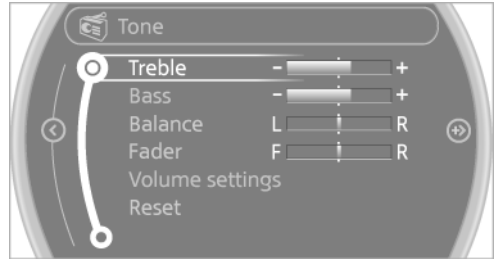

4. To set: turn the MINI joystick.
5. To save: press the MINI joystick.

## VOLUME

- ▷ "Speed volume": speed-dependent volume control.
- ▷ "PDC": volume of the PDC signal compared to the entertainment sound output.
- ▷ "Gong": volume of the signal, such as the safety belt reminder, compared to the entertainment sound output.

Bluetooth mobile phone preparation package

- ▷ "Microphone": volume of the microphone during a phone call.
- ▷ "Loudspeak.": volume of the loudspeakers during a phone call.

The following volumes are only stored for the respective paired telephone: "Microphone", "Loudspeak.".

### Adjusting the volume

1. "CD/Multimedia", "Radio" or "Settings"
2. "Tone"
3. "Volume settings"

4. Select the desired volume setting.

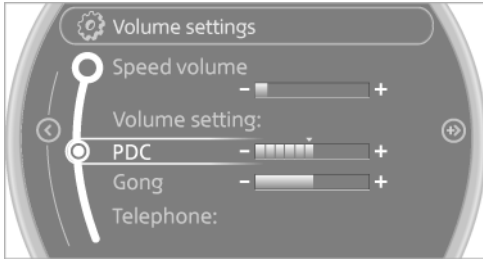

5. To set: turn the MINI joystick.
6. To save: press the MINI joystick.

## RESETTING THE TONE SETTINGS

All tone settings can be reset to the default setting.

1. "CD/Multimedia", "Radio" or "Settings"
2. "Tone"
3. "Reset"

# RADIO

## VEHICLE EQUIPMENT

This chapter describes all series equipment as well as country-specific and special equipment offered for this model series. Therefore, it also describes equipment that may not be found in your vehicle, for instance due to the selected special equipment or the country version. This also applies to safety-related functions and systems.

## CONTROLS



- 1 CD drive
- 2 Changing the waveband
- 3 Changing the audio source
- 4 Volume, on/off
- 5 Change station/track
- 6 Ejecting the CD

## SOUND OUTPUT

### Switching on/off



When the ignition is switched off: press ON/OFF button on the radio.

### Muting

When the ignition is switched on or the engine is running: press the ON/OFF button on the radio.

☑ This symbol at the upper edge of the Control Display indicates that the sound is switched off.

## AM/FM STATION

### Selecting a station

1. "Radio"
2. "FM" or "AM"
3. Select the desired station.

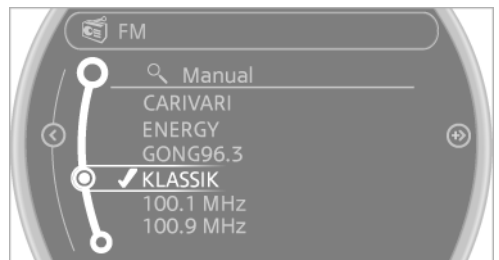



All saved stations are stored for the remote control currently in use.

### Changing the station

Turn and press the MINI joystick.

or



Press the button

or

Press the buttons on the steering wheel.

### Storing a station

1. "Radio"
2. "FM" or "AM"
3. Highlight the desired station.

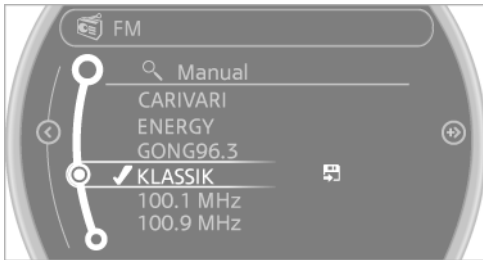

4. Press the MINI joystick.
5. Select the desired memory location.

Press and hold the MINI joystick to store a station that is displayed in the station list but is not being played.

The stations are stored for the remote control currently in use.

### Selecting a station manually

Station selection via the frequency.

1. "Radio"
2. "FM" or "AM"
3. "Manual"
4. To select a frequency: turn the MINI joystick.

To save a station: press and hold the MINI joystick.



### RDS

RDS broadcasts additional information, such as the station name, in the FM wave band.

### Switching the RDS on/off

1. "Radio"
2. "FM"
3. Open "Options".
4. "RDS"

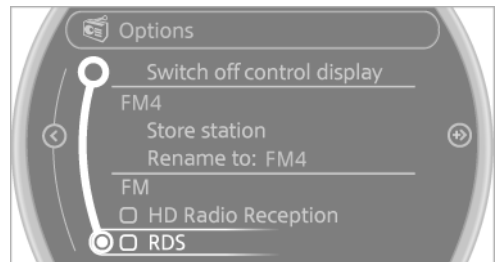

The setting is stored for the remote control currently in use.

### HD Radio™ reception

Many stations broadcast both analog and digital signals.

License conditions

HD Radio Technology manufactured under license from iBiquity Digital Corporation. U.S. and Foreign Patents. HD Radio™ and the HD, HD Radio, and Arc logos are proprietary trademarks of iBiquity Digital Corp.

## Activating/deactivating digital radio reception

1. "Radio"
2. "FM" or "AM"
3. Open "Options".
4. "HD Radio Reception"

The setting is stored for the remote control currently in use.

 This symbol is displayed in the status line when the audio signal is digital.

When tuning to a station with a digital signal, it may take several seconds for the station to be played back in digital quality.

Note on HD stations whose station name ends in ...HD or HD1:

In areas in which the station is not continuously received in digital mode, the playback switches between analog and digital reception. In this case, switch off digital radio reception.

Note on HD multicast stations whose station name ends in ...HD2, ...HD3, ...:

In areas in which the station is not continuously received in digital mode, the audible signal may be interrupted for several seconds. This is reception related.

## Displaying additional information

Some stations broadcast additional information on the current track, such as the name of the artist.

1. Select the desired station.
2. Open "Options".
3. "Station info"

## Selecting a substation

 This symbol indicates that a main station also broadcasts additional substations. The station name of the main station ends in HD1. Station names of the substations end in HD2, HD3, etc.

1. Select the desired station.

2. Press the controller.
3. Select the substation.







When reception is poor, the substation is muted.

## SATELLITE RADIO

### General information

The channels are offered in predefined packages. The packages must be enabled by telephone.

### Navigation bar overview

Symbol	Function
	Change the list view.
	Select the category.
	Direct channel entry
	Timeshift
	Open the My Favorites category/ open a favorite.
	Manage the favorites.
	Traffic Jump

### Managing a subscription

To be able to enable or unsubscribe from the channels, you must have reception. It is usually at its best when you have an unobstructed view of the sky. The channel name is displayed in the status line.

### Enabling channels

The Unsubscribed Channels category contains all disabled channels.

1. "Radio"
2. "Satellite radio"

### 3. "Category"

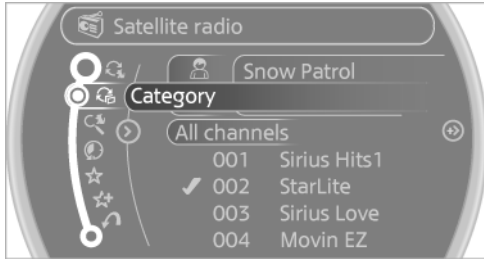

4. Select the Unsubscribed Channels category.
5. Select the desired channel.

The phone number and an electronic serial number, ESN, are displayed.

6. Select the phone number to have the channel enabled.

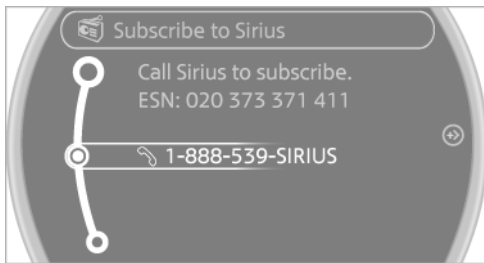

You can unsubscribe from the channels again via this phone number.

### Unsubscribing from channels

1. "Radio"
2. "Satellite radio"
3. Open "Options".
4. "Manage subscription"

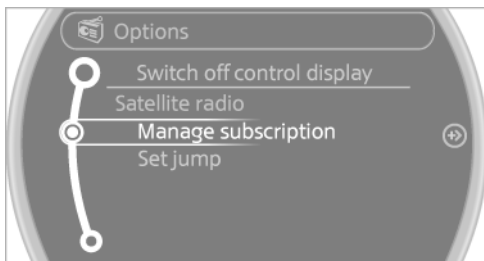

5. The phone number and an electronic serial number, ESN, are displayed.
6. Call Sirius to unsubscribe from the channels.

### Selecting channels

You can only listen to enabled channels.

The selected channel is stored for the remote control currently in use.

### Via the onboard monitor

1. "Radio"
2. "Satellite radio"
3. Select "All channels" or the desired category.
4. Select the desired channel.

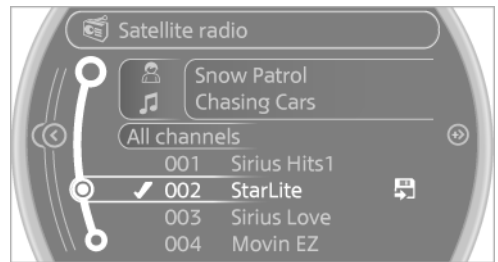

### Via the buttons in the area of the CD player

  Press the button.

The next channel is selected.

### Via direct channel entry

1. "Radio"
2. "Satellite radio"
3.  "Set channel"
4. Turn the MINI joystick until the desired channel is reached and press the MINI joystick.

## Storing a channel

1. "Radio"
2. "Satellite radio"
3. If necessary, open "All channels" or the desired category.
4. Select the desired channel.
5. Press the MINI joystick again.
6. Press the MINI joystick again to confirm the highlighted channel.



7. Select the desired memory location.

The channels are stored for the remote control currently in use.

## Changing the list view

The list view changes every time the first symbol on the navigation bar is pressed.

Information on the channel is displayed.

Symbol	Meaning
	Channel name
	Artist
	Track

## Selecting a category

1. "Radio"
2. "Satellite radio"
3. "Category"
4. Select the desired category.

## Timeshift

Approx. one hour of the program being broadcast on the channel currently being listened to is stored in a buffer. Prerequisite: the signal must be available.

The stored audio track can be played with a delay following the live broadcast. When the buffer is full, the older tracks are overwritten. The buffer is cleared when a new channel is selected.

## Opening the timeshift function

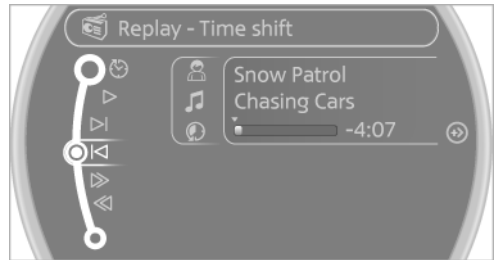

1. "Radio"
2. "Satellite radio"
3. "Replay - Time shift"



- ▷ The red arrow shows the current playback position.
- ▷ The time difference to the live broadcast is displayed next to the buffer bar.
- ▷ For live transmissions "live".

## Timeshift menu

Symbol	Function
	Go to the live broadcast
	Playback/pause
	Next track
	Previous track
	Fast forward

Symbol	Function
	Reverse
 	Automatic timeshift deactivated/activated



### Automatic timeshift

When the function is activated, audio playback is stopped automatically in the event of:

- ▷ Incoming and outgoing telephone calls.
- ▷ Activation of the voice activation system.
- ▷ Muting.

The audio playback then continues with a time delay.

### Activating

1. "Radio"
2. "Satellite radio"
3.  "Replay - Time shift"
4.  "Automatic time shift"

### Deactivating

-  "Automatic time shift"

### Storing favorites

Up to 30 favorites can be stored in the favorites list. Available favorites are artist, track, game, league, and team.

### Storing the artist, track, or game

It is only possible to store favorites that are currently being broadcast. The channel information must be available.

1. "Radio"
2. "Satellite radio"
3. If necessary, open "All channels" or the desired category.
4. Select the desired channel.
5. Press the MINI joystick again.
6. Select the artist, track, or game.

### Storing the league or team

Leagues or teams can be added to the favorites from a selection list.

1. "Radio"
2. "Satellite radio"
3.  "Manage favorites"
4. "Add sports information"



5. Select the league.
6. Select "Add all teams" or the desired team.

### Opening the favorites

If an activated favorite is played back, the following message appears for approx. 20 seconds "Favorite alert!".

 "Favorites"

Select the symbol while the message is shown.



The displayed favorite is played.

If there is no message, the system changes to the My Favorites category. All favorites currently being broadcast can be selected from a list.

## Managing the favorites

### Activating/deactivating the favorites

Favorites can be activated and deactivated globally and individually.

1. "Satellite radio"
2. ☆+ "Manage favorites"
3. Select "Activate alert" or the desired favorites.

The setting is stored for the remote control currently in use.

### Deleting favorites

1. "Satellite radio"
2. ☆+ "Manage favorites"
3. Highlight the desired favorite.
4. Open "Options".
5. "Delete entry"

### Traffic Jump

Traffic and weather information for a selected region is broadcast every few minutes.

### Selecting a region

1. "Radio"
2. "Satellite radio"
3. Open "Options".
4. "Set jump"
5. Select the desired region.

The region is stored for the remote control currently in use.



### Activating/deactivating the jump

1. "Radio"
2. "Satellite radio"
3. ↶ "Jump to:"

Information for the selected region is broadcast as soon as it is available.

A new panel opens.

Canceling the Traffic Jump: "Cancel".

Symbol	Meaning
	Information will be broadcast shortly.
	Information is currently being broadcast.

Select one of the symbols to deactivate Traffic Jump.

### Automatic update

About twice a year, Sirius performs an update of the channel names and positions. The update takes place automatically and may take several minutes.

### Notes

- ▷ Reception may not be available in some situations, such as under certain environmental or topographic conditions. The satellite radio has no influence on this.
- ▷ The signal may not be available in tunnels or underground garages; next to tall buildings; or near trees, mountains or other powerful sources of radio interference.

## STORED STATIONS

### General information

It is possible to store up to 40 stations.

### Calling up a station

1. "Radio"
2. "Presets"
3. Select the desired station.

### Storing a station

The station currently selected is stored.

1. "Radio"
2. "Presets"

### 3. "Store station"



### 4. Select the desired memory location.

The list of stored stations is stored for the remote control currently in use.

## Deleting a station

1. "Radio"
2. "Presets"
3. Select the desired station.
4. Open "Options".
5. "Delete entry"

# CD/MULTIMEDIA

## VEHICLE EQUIPMENT

This chapter describes all series equipment as well as country-specific and special equipment offered for this model series. Therefore, it also describes equipment that may not be found in your vehicle, for instance due to the selected special equipment or the country version. This also applies to safety-related functions and systems.

## SOUND OUTPUT

### Switching on/off



When the ignition is switched off: press ON/OFF button on the radio.

### Muting

When the ignition is switched on or the engine is running: press the ON/OFF button on the radio.

 This symbol at the upper edge of the Control Display indicates that the sound is switched off.

## CD PLAYER

### Playback

#### Inserting the CD

Insert the CD with the printed side facing up. Playback begins automatically.

Reading can take a few minutes with compressed audio files.

#### Starting playback

A CD is contained in the CD player.

1. "CD/Multimedia"
2. "CD"
3. Select the desired track. Press the MINI joystick to start playback.

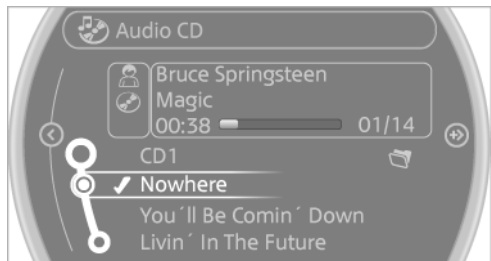

### Playable formats

- ▷ CD: CD-ROM, CD-R, CD-RW, CD-DA.
- ▷ Compressed audio files: MP3, WMA, AAC.

### Ejecting the CD



Press the button on the CD player.

The CD emerges slightly from the drive.



## Audio playback

### Selecting the track using the button



Press the button for the appropriate direction as often as necessary until the desired track is played back.

### Selecting the track on the onboard monitor

#### Audio CDs



Select the desired track to begin playback.

#### CDs with compressed audio files

Depending on the data, some letters and numbers of the CD may not be displayed correctly.

1. Select the directory if necessary.

To change to a higher level directory: move the MINI joystick to the left.



2. Select the desired track to begin playback.

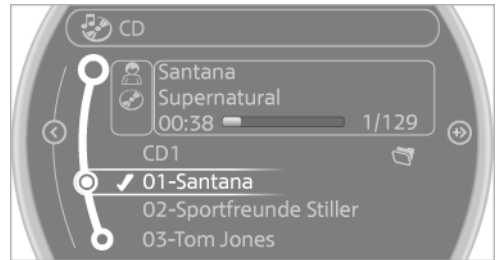

### Displaying information on the track

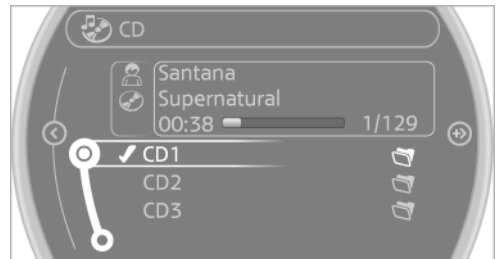

If information about a track has been stored, it is displayed automatically:

- ▷ Artist.
- ▷ Album track.
- ▷ Number of tracks on the CD.
- ▷ File name of track.

### Random playback

1. "CD/Multimedia"
2. "CD"
3. Select the desired CD.

4. Open "Options".
5. "Random"

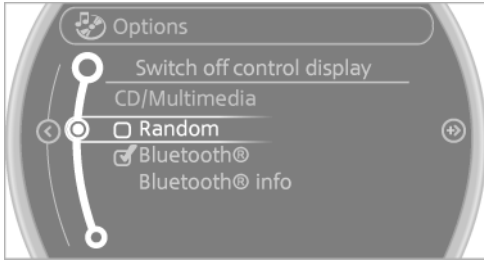

To switch off random playback: press the MINI joystick.

### Fast forward/reverse



Press and hold the button for the corresponding direction.

### Automatic repeat

The selected track, directories, or CDs are repeated automatically.

### Notes

#### CD player



Do not remove the cover

The CD players are officially designated Class 1 laser products. Do not operate if the cover is damaged; otherwise, severe eye damage can result. ◀

#### CDs



Using CDs

- ▶ Do not use self-recorded CDs with labels applied, as these can become detached during playback due to heat buildup and can cause irreparable damage to the device.

- ▶ Only use round CDs with a standard diameter of 4.7 in/12 cm and do not play CDs with an adapter, e.g., single CDs; otherwise, the CDs or the adapter may jam and no longer eject. ◀

### General malfunctions

- ▶ The CD players have been optimized for performance in vehicles. In some instances they may be more sensitive to faulty CDs than stationary devices would be.
- ▶ If a CD cannot be played, first check if it has been inserted correctly.

### Humidity

High levels of humidity can lead to condensation on the CD or the laser's scan lens, and temporarily prevent playback.

### Malfunctions with particular CDs

If malfunctions occur only with particular CDs, this can be due to one of the following causes:

#### Self-recorded CDs

- ▶ Possible reasons for malfunctions with self-recorded CDs are inconsistent data creation or recording processes, or poor quality or old age of the blank CD.
- ▶ Only label CDs on the upper side with a pen intended for this purpose.

#### Damage

- ▶ Avoid fingerprints, dust, scratches and moisture.
- ▶ Store CDs in a sleeve.
- ▶ Do not subject CDs to temperatures over 50 °C/122 °F, high humidity, or direct sunlight.

#### CDs with copy protection

CDs are often provided with a copy protection feature by the manufacturer. This can mean

that some CDs cannot be played or can only be played to a limited extent.





## MACROVISION

This product contains copyrighted technology that is based on multiple registered US patents and the intellectual property of the Macrovision Corporation and other manufacturers. The use of this copy protection must be approved by Macrovision. Media protected by this product - unless otherwise agreed with Macrovision - may only be used for private purposes. Copying of this technology is prohibited.

## EXTERNAL DEVICES

### At a glance

Various external devices can be connected with the vehicle. Depending on how the device is connected to the vehicle, it may be possible to operate it using the MINI joystick.

Symbol	Meaning
	AUX-IN port
	USB audio interface
	Music interface for smartphones
	Bluetooth audio

### AUX-IN port

#### At a glance

- ▶ For connecting audio devices, e.g., MP3 player. The sound is output on the vehicle loudspeakers.
- ▶ Recommendation: use medium tone and volume settings on the audio device. The tone depends on the quality of the audio files.

### Connecting



The AUX-IN port is in the center console.

Connect the headphone connector or line-out connector of the device to the AUX-IN port.

Ensure that the connector is inserted all the way into the AUX-IN port.

### Playback

1. Connect the audio device, switch it on and select a track on the audio device.
2. "CD/Multimedia"
3. If necessary, "External devices"

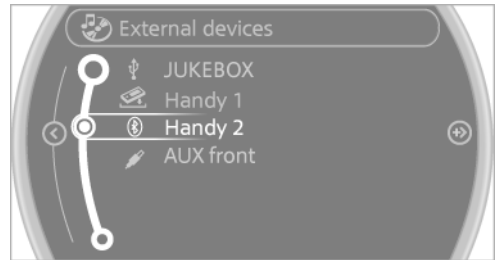

4.  "AUX front"

Sound is output on the vehicle loudspeakers.

### Volume

The volume of the sound output is dependent on the audio device. If this volume differs markedly from the volume of the other audio sources, it is advisable to adjust the volumes.

#### Adjusting the volume

1. "CD/Multimedia"
2. If necessary, "External devices"
3.  "AUX front"

#### 4. "Volume"

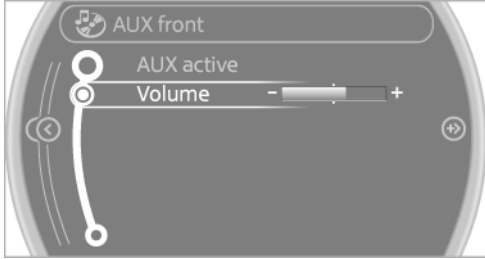

5. Turn the MINI joystick until the desired volume is set and press the MINI joystick.

### USB audio interface/music interface for smartphones

#### At a glance

It is possible to connect external audio devices. They are operated via the onboard monitor. The sound is output on the vehicle loudspeakers.

#### Connectors for external devices

- ▷ Connection via USB audio interface: Apple iPod/iPhone, USB devices, e.g., MP3 players, USB flash drives, or mobile phones that are supported by the USB audio interface.
- ▷ Connection via snap-in adapter, when equipped with the music interface for smartphones: Apple iPhone or mobile phones.

Playback is only possible if no audio device is connected to the analog AUX-IN port.

Due to the large number of different audio devices available on the market, it cannot be ensured that every audio device/mobile phone is operable on the vehicle.

Ask your service center about suitable audio devices/mobile phones.

#### Audio files

Standard audio files can be played back:

- ▷ MP3.

- ▷ WMA.
- ▷ WAV (PCM).
- ▷ AAC, M4A.
- ▷ Without the voice activation system: playback lists: M3U
- ▷ With the voice activation system: playback lists: M3U, WPL, PLS

#### Video files

Standard video files can be played back with a compatible Apple device:

- ▷ MPEG4
- ▷ H.264

#### File system

Standard file systems for USB devices are supported. The FAT 32 format is recommended.

#### Connecting



The USB audio interface is in the center console.

#### Connection of Apple iPod/iPhone via USB audio interface

To connect the iPod, use the special cable adapter for the Apple iPod. Additional information can be obtained from the service center or on the Internet: [www.mini.com/connectivity](http://www.mini.com/connectivity).

Connect the Apple iPod/iPhone with the AUX-IN port and USB interface.

The Apple iPod/iPhone menu structure is supported by the USB audio interface.

#### Connection of a USB device via the USB audio interface

Connect using a flexible adapter cable to protect the USB audio interface and the USB device against physical damage.

Connect the USB device to the USB interface.

### After connecting for the first time

Information on all music tracks, e.g. artist or type of music, as well as playback lists are transmitted into the vehicle. This may take some time, depending on the USB device and the number of tracks.

During transmission, the tracks can be called up via the file directory.



### Number of tracks

Information from up to four USB devices or for approx. 26,000 tracks can be stored in the vehicle. If a fifth device is connected or if more than 26,000 tracks are stored, information on existing tracks may be deleted.

### Copy protection

Music tracks with integrated Digital Rights Management (DRM) cannot be played.

### Audio playback

1. "CD/Multimedia"
2. "External devices"
3. Select the  or  symbol.

The playback starts with the first track.

The CD cover belonging to the track may appear on the Control Display after several seconds.

### Track search

Selection is possible via:

- ▶ Playback lists.
- ▶ Information: type of music, artist, and, if available, composer, album, track.
- ▶ Additionally for USB devices: file directory, composer.

Tracks are displayed if they have been saved in the Latin alphabet.

### Starting the track search

1. "CD/Multimedia"
2. "External devices"

3. Select the  or  symbol.

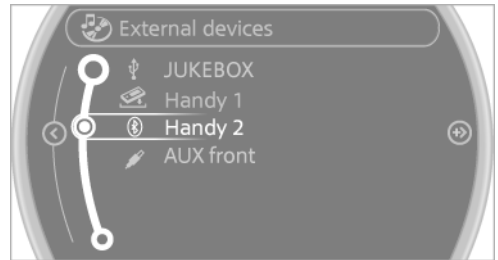

4. "Search"
5. Select the desired category, e.g., "Genre" or "Artist".

All entries are displayed in a list.

- ▶ Open "A-Z search" and input the desired entry. When a letter is entered, the results are filtered using this letter as the first letter. If multiple letters are entered, all results that contain that sequence are displayed.
- ▶ Select the desired entry from the list.





6. Select other categories if you wish.  
Not all categories need to be selected. For example, if all of the tracks by a certain artist are to be displayed, call up that artist only. All of the tracks by that artist are then displayed.
7. "Play"

### Restarting a track search

"New search"



## Playback lists

Calling up playback lists.

1. "CD/Multimedia"
2. "External devices"
3. Select the  or  symbol.
4. "Playlists"

## Current playback

List of tracks currently being played.

1. "CD/Multimedia"
2. "External devices"
3. Select the  or  symbol.
4. "Current playback"

## Random playback

The current list of tracks is played back in random order.

1. "CD/Multimedia"
2. "External devices"
3. Open "Options".
4. "Random"

## Fast forward/reverse

Buttons on the steering wheel or on the CD player:



Press and hold the button for the corresponding direction.

## Video playback



### At a glance

Video playback is only possible with a compatible iPod/iPhone. Connect using a video-capable adapter cable or, if applicable, a snap-in adapter.

### Playback

The video image on the Control Display is displayed while the vehicle is stationary; in some

countries, the handbrake must be set or P must be engaged.

1. "CD/Multimedia"
2. "External devices"
3. Select the  or  symbol.
4. "Video"



5. Select the desired file.  
Select the category in the file directory.

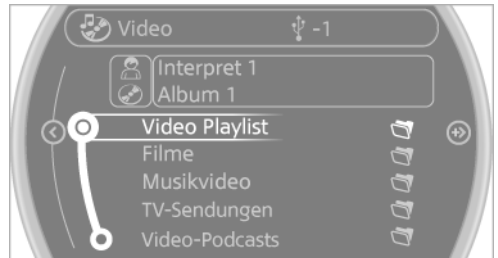

6. Press the MINI joystick.  
Playback of the selected video file starts.

## Notes

Do not expose the audio device to extreme environmental conditions, such as very high temperatures; refer to the audio device operating instructions.

Depending on the configuration of the audio files, e.g., bit rates greater than 256 kbit/s, the files may not play back correctly in each case.

Audio and video playback from the snap-in adapter is only possible if no cable is connected to the AV-IN port.

### Information on connection

- ▷ The connected audio device is supplied with a max. power of 500 mA if supported by the device. Therefore, do not additionally connect the device to a socket in the vehicle; otherwise, playback may be compromised.
- ▷ Do not use force when plugging the connector into the USB interface.
- ▷ Do not connect devices such as fans or lamps to the USB audio interface.
- ▷ Do not connect USB hard drives.
- ▷ Do not use the USB audio interface to recharge external devices.

### Bluetooth audio

#### At a glance

- ▷ Music files on external devices such as audio devices or mobile phones can be played back via Bluetooth.
- Use of a mobile phone as an audio source, refer to page 194.
- ▷ Bluetooth® is a registered trademark of Bluetooth® SIG, Inc.
  - ▷ The sound is output on the vehicle loudspeakers.
  - ▷ The volume of the sound output is dependent on the device. If necessary, adjust the volume on the device.
  - ▷ Up to four external devices can be paired with the vehicle.

#### Requirements

- ▷ The device is suitable. Information under [www.mini.com/connectivity](http://www.mini.com/connectivity).
- ▷ The device is ready for operation.
- ▷ The ignition is switched on.
- ▷ Bluetooth is activated on the vehicle, refer to page 193, and on the device.
- ▷ Bluetooth presets must be made on the device, such as for a connection without

confirmation or visibility; refer to the device operating instructions.

- ▷ A number with at least four and a maximum of 16 digits is defined as the Bluetooth passkey. It is only required once for pairing.

### Pairing and connecting



#### Pairing a device

To avoid becoming distracted and posing an unnecessary hazard both to your own vehicle's occupants and to other road users, only pair the device while the vehicle is stationary. ◀

1. "CD/Multimedia"
2. "Bluetooth® (audio)"
3. If necessary, "Bluetooth® audio".
4. "Add new phone"

The Bluetooth name of the vehicle is displayed.

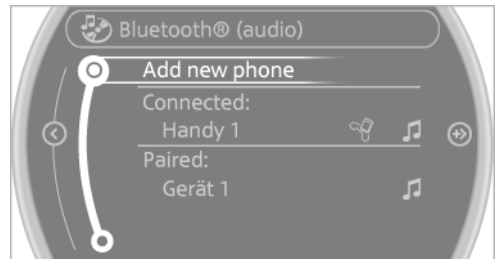

5. Perform additional steps on the device, refer to the device operating instructions: for instance, search for or connect the Bluetooth device or a new device.

The Bluetooth name of the vehicle appears on the device display.

6. Select the Bluetooth name of the vehicle on the device display.  
You are prompted by the onboard monitor or device to enter the same Bluetooth passkey.
7. Enter the passkey and confirm.  
or

Compare the control number on the vehicle display with the control number on the mobile phone display. Confirm the control number on the mobile phone and in the vehicle.

"OK"

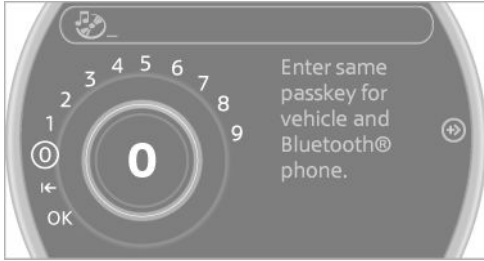

8. Select the desired functions with which the device is to be connected, for instance "Audio".

9. "OK"

If pairing was successful, the device is displayed as connected.

White symbol  : the device is active as an audio source.

If pairing was unsuccessful: What to do if..., refer to page 177.

### Connecting a specific device

A device that has already been paired can be connected as an active audio source.

Connecting is not possible when data is exchanged via a mobile phone connected via Bluetooth.

### Requirements

If necessary, activate the audio connection of the desired device from the list of paired devices.

1. "CD/Multimedia"
2. "Bluetooth® (audio)"
3. If necessary, "Bluetooth® audio".

4. Select the desired device from the list of paired devices.
5. Open "Options".
6. "Configure phone"
7. Activate "Audio".
8. "OK"

### Connecting the device

1. "CD/Multimedia"
2. "Bluetooth® (audio)"
3. If necessary, "Bluetooth® audio".
4. Select the desired device from the list of paired devices.



White symbol  : the device is active as an audio source.

### Playback

#### General information

- ▷ The display of music track information depends on the device.
- ▷ Operation can take place on the device or onboard monitor.
- ▷ Playback is interrupted when data is exchanged via a mobile phone connected via Bluetooth.

#### Starting playback

1. Connect the device.
2. "CD/Multimedia"
3. "External devices"



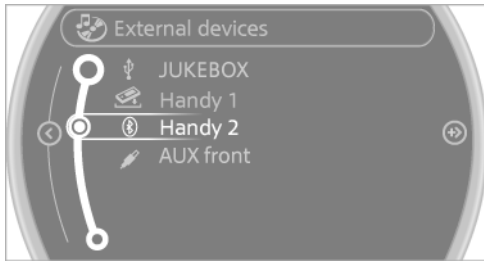

4.  Select the symbol.



5. Select the desired track from the list, if necessary.

### Playback menu

Depending on the particular device, some of the functions may not be available.

Symbol	Function
	Next track Fast forward: press and hold the symbol.
	Previous music track Reverse: press and hold the symbol.

### Track search

Music track search is possible depending on the device.

1. "CD/Multimedia"
2. "External devices"
3.  Select the symbol.
4. "Search device content"
5. "A-Z search"
6. Select the desired entry or directory.

### Playback mode

Depending on the device, different programs for playing back music files might be available.

1. "CD/Multimedia"
2. "External devices"
3.  Select the symbol.

4. Open "Options".
5. Open "Select player".
6. Select the desired channel.

### Disconnecting the audio connection

1. "CD/Multimedia"
2. "Bluetooth® (audio)"
3. Highlight the desired device.
4. Open "Options".
5. "Configure phone"
6. "Audio"
7. "OK"

In the case of a mobile phone, only the audio connection is disconnected. All other connections are retained.

### Unpairing a device

1. "CD/Multimedia"
2. "Bluetooth® (audio)"
3. If necessary, "Bluetooth® audio".
4. Highlight the device that is to be unpaired.
5. Open "Options".
6. "Remove phone from list"

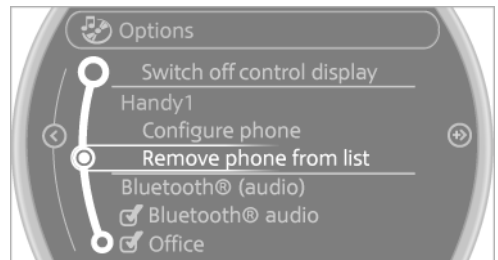

### What to do if...

Information on suitable devices can be found at [www.mini.com/connectivity](http://www.mini.com/connectivity).

Suitable mobile phones, refer to page 192.

The device is not supported by the vehicle.

- ▷ Perform a software update, refer to page 178, if needed.

The device could not be paired or connected.

- ▷ Do the Bluetooth passkeys on the device and the vehicle match? Enter the same passkey on the device and via the onboard monitor.
- ▷ A multi-character passkey may be needed.
- ▷ Did it take longer than 30 seconds to enter the passkey? Repeat the pairing procedure.
- ▷ Are too many Bluetooth devices connected to the device or vehicle? Delete connections with other devices if necessary.
- ▷ Is the mobile phone in power-save mode or does it have only a limited remaining battery life? Charge the mobile phone in the snap-in adapter or via a charging cable.
- ▷ Depending on the mobile phone, it is possible that only one device can be connected to the vehicle. Unpair the connected device from the vehicle and pair and connect only one device.
- ▷ The device no longer reacts? Switch the device off and on again.
- ▷ Repeat the pairing procedure.

Music cannot be played back.

- ▷ Start the program for playing back music data on the device and select a track on the device if necessary.
- ▷ Switch the radio on and off again.

Music files can only be played back softly.

- ▷ Adjust the volume settings on the device.

Videos can only be played back without audio or with delayed audio.

- ▷ Check the compatibility of the devices. Information under [www.mini.com/connectivity](http://www.mini.com/connectivity).

Playback is disturbed when buttons are pressed or by other messages on the device.

- ▷ Switch off the button tones and other signal tones on the device.

Playback is interrupted by a telephone call or traffic bulletin and is not resumed automatically.

- ▷ Switch the radio on and off again.

Playback is not possible if the mobile phone is connected via Bluetooth Audio while it is also connected via the music interface for smartphones in the snap-in adapter.

- ▷ Disconnect one of the two connections; for example, disconnect the audio connection, refer to page 177, and restart playback.

If all points in this list have been checked and the required function is still not available, please contact the hotline or service center.

## Software Update

The vehicle supports various external devices depending on the current software version. With a software update, the vehicle can support new mobile phones or new external device, for example.

Software updates and related current information is available at [www.mini.com/connectivity](http://www.mini.com/connectivity).

## Displaying the current version

The currently installed software is displayed.

1. "Settings"
2. "Software update"
3. "Show current version"

## Updating the software

The software may only be updated when the vehicle is stationary.

1. Store the file for the software-update in the main director of a USB flash drive.
2. Insert the USB flash drive into the USB audio interface in the center console. An update via the USB interface in the glove compartment is not possible.
3. "Settings"
4. "Software update"

## 5. "Update software"

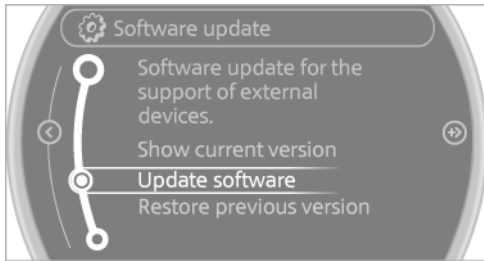

## 6. "Start update"

## 7. "OK"

All listed software updates are installed.

## Restoring the previous version

The software version prior to the last software update can be restored.

The previous version can only be restored when the vehicle is stationary.

1. "Settings"
2. "Software update"
3. "Restore previous version"
4. "OK" Double-click.

All listed software updates are removed.

## Note

While the software is being updated or a previous version is being restored, MINI Connected, Office functions, and the connected devices are temporarily unavailable. Wait several minutes for the functions to become available again.



**AT A GLANCE**

**CONTROLS**

**DRIVING TIPS**

**NAVIGATION**

**ENTERTAINMENT**

**COMMUNICATION**

**MOBILITY**

**REFERENCE**

# BLUETOOTH HANDS-FREE SYSTEM

## VEHICLE EQUIPMENT

This chapter describes all series equipment as well as country-specific and special equipment offered for this model series. Therefore, it also describes equipment that may not be found in your vehicle, for instance due to the selected special equipment or the country version. This also applies to safety-related functions and systems.

## AT A GLANCE

### The concept

Mobile phones can be connected with the vehicle via Bluetooth.

Bluetooth® is a registered trademark of Bluetooth® SIG, Inc.

After these devices are paired once, they are recognized automatically when the ignition is switched on as soon as they are in the vehicle and can then be operated via the onboard monitor, the buttons on the steering wheel, and voice activation.

Up to four external devices can be paired.

Certain functions may need to be enabled by the mobile phone provider or service provider.

 Using the mobile phone while driving

Make entries only when traffic and road conditions allow. Do not hold the mobile phone in your hand while you are driving; use the hands-free system instead. If you do not observe this precaution, you can endanger the vehicle occupants and other road users. ◀

### Approved mobile phones

Details on which mobile phones are supported by the hands-free system can be obtained at [www.mini.com/connectivity](http://www.mini.com/connectivity).

### Displaying the vehicle identification number and software part number

The vehicle identification number and software part number are needed to determine which mobile phones are supported by the mobile phone preparation package. The software version of the mobile phone may also be required.

1. "Telephone"
2. Open "Options".
3. "Bluetooth® info"
4. "Display system information"

These approved mobile phones with a certain software version, support the vehicle functions described below.

Malfunctions may occur with other mobile phones or software versions.

Do not operate a mobile phone that is connected to the vehicle on the mobile phone keypad, as this may lead to a malfunction.

### Notes

At high temperatures, the charging function of the mobile phone may be limited and functions may not be executed.

When using the mobile phone via the vehicle, note the operating instructions of the mobile phone.

## PAIRING/UNPAIRING THE MOBILE PHONE

### Requirements

- ▷ The mobile phone is suitable, refer to page 182.
- ▷ The mobile phone is ready for operation.
- ▷ Bluetooth is activated in the vehicle and on the mobile phone.

- ▶ Bluetooth presets may need to be made on the mobile phone, e.g., for a connection without confirmation or visibility, refer to the mobile phone operating instructions.
- ▶ Deactivate Bluetooth audio if necessary.
- ▶ A number with at least four and a maximum of 16 digits was defined as the Bluetooth passkey. It is only required once for pairing.
- ▶ Compare the control number on the Control Display with the control number on the mobile phone display. Confirm the control number on the mobile phone and in the vehicle.
- ▶ The radio ready state is switched on.

### Activating/deactivating Bluetooth

Bluetooth is not permitted everywhere. Comply with all safety guidelines and regulations.

1. "Telephone"
2. Open "Options".
3. "Bluetooth®"

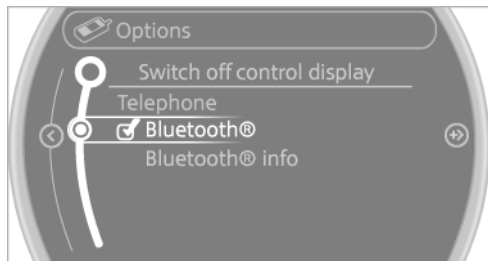

### Pairing and connecting a mobile phone



Pairing the mobile phone

To avoid becoming distracted and posing an unnecessary hazard both to your own vehicle's occupants and to other road users, only

pair the mobile phone while the vehicle is stationary. ◀

1. "Telephone"
2. "Bluetooth® (phone)"
3. "Add new phone"

The Bluetooth name of the vehicle is displayed.



4. To perform additional steps on the mobile phone, refer to the mobile phone operating instructions: for instance, search for or connect the Bluetooth device or a new device. The Bluetooth name of the vehicle appears on the mobile phone display.
  5. Select the Bluetooth name of the vehicle on the mobile phone display.
  6. You are prompted by the onboard monitor or mobile phone to enter the same Bluetooth passkey. Enter the passkey and confirm.
- or

Compare the control number on the vehicle display with the control number on the mobile phone display. Confirm the control number on the mobile phone and in the vehicle.

"OK"

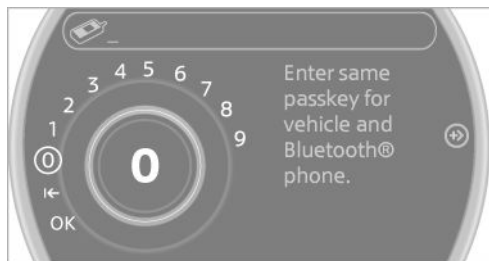

7. Select the functions for which the mobile phone is to be used.
8. "OK"
9. Move the MINI joystick to the left.

If the pairing was successful, the mobile phone appears at the top of the list of mobile phones.

If pairing was unsuccessful: What to do if..., refer to page 184.

### Following the initial pairing

- ▷ The mobile phone is detected/connected in the vehicle within a short period of time when the engine is running or the ignition is switched on.
- ▷ The phone book entries of the telephone stored on the SIM card or mobile phone are transmitted to the vehicle after detection, depending on the mobile phone.
- ▷ Four mobile phones can be paired.
- ▷ Specific settings may be necessary in some mobile phones, e.g., authorization or a secure connection; refer to the mobile phone operating instructions.

### Connecting a particular mobile phone

1. "Telephone"
2. "Bluetooth® (phone)"  
All paired mobile phones are listed.

3. Select the mobile phone that is to be connected.



### Unpairing the mobile phone

1. "Telephone"
2. "Bluetooth® (phone)"  
All paired mobile phones are listed.
3. Highlight the mobile phone that is to be unpaired.
4. Open "Options".
5. "Remove phone from list"

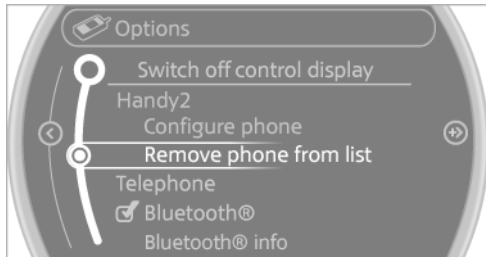

### What to do if...

Information on suitable mobile phones, refer to page 182.

The mobile phone could not be paired or connected.

- ▷ Is Bluetooth activated in the vehicle and on the mobile phone? Activate Bluetooth in the vehicle and on the mobile phone.
- ▷ Do the Bluetooth passkeys on the mobile phone and the vehicle match? Enter the same passkey on the mobile phone and via the onboard monitor.



- ▶ A multi-character passkey may be needed.
- ▶ Did it take longer than 30 seconds to enter the passkey? Repeat the pairing procedure.
- ▶ Are too many Bluetooth devices connected to the mobile phone or vehicle? Delete connections with other devices if necessary.
- ▶ The mobile phone is in power-save mode or has only a limited remaining battery life. Charge the mobile phone via the charging cable.
- ▶ Depending on the mobile phone, it is possible that only one mobile phone can be connected to the vehicle. Unpair the connected mobile phone from the vehicle and pair and connect only one mobile phone.

The mobile phone no longer reacts.

- ▶ Switch the mobile phone off and on again.
- ▶ Is the ambient temperature too high or low? Do not expose the mobile phone to extreme environmental conditions.

No phone book entries or only some phone book entries are displayed, or they are incomplete.

- ▶ Transmission of the phone book entries is not yet complete.
- ▶ It is possible that only the phone book entries of the mobile phone or the SIM card are transmitted.
- ▶ It may not be possible to display phone book entries with special characters.
- ▶ The number of phone book entries to be stored is too high.
- ▶ Is the data volume of the contact too large, e. g., due to stored information such as notes? Reduce the data volume of the contact.

The phone connection quality is poor.

- ▶ The strength of the Bluetooth signal on the mobile phone can be adjusted, depending on the mobile phone.
- ▶ Place the mobile phone in the area of the center console.

If all points in this list have been checked and the required function is still not available, contact Customer Relations or the service center.

## CONTROLS

### Adjusting the volume



Turn the knob until the desired volume is selected. The setting is stored for the remote control currently in use.

### Incoming call

#### Receiving calls

If the number of the caller is stored in the phone book and is transmitted by the network, the name of the contact is displayed. Otherwise, only the phone number is displayed.

If more than one phone number is assigned to a contact, only the name of the contact is displayed.

#### Accepting a call



Press the button on the steering wheel.

or



"Accept"

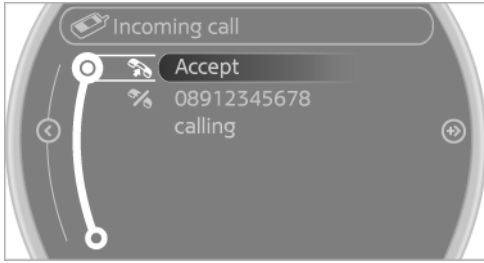

### Rejecting a call

📞 "Reject"

### Ending a call



Press the button on the steering wheel.

or

1. "Telephone"
2. 📞 "End call"

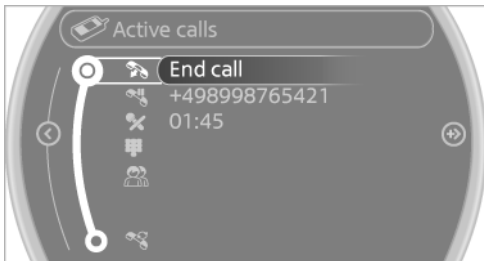

### Entering a phone number

#### Dialing a number

1. "Telephone"
2. "Dial number"

3. Select the digits individually.
4. 📞 Select the symbol.



The phone number can also be entered by voice.

### Calls with multiple parties

#### General information

You can switch between calls or connect two calls to a single conference call. These functions must be supported by the mobile phone and service provider.

#### Accepting a call while speaking to another party

This function might have to be activated by the service provider and the mobile phone must be adjusted accordingly.

If a second call comes in during an ongoing call, a call waiting signal is sounded.

📞 "Accept"

The call is accepted and the existing call is put on hold.

#### Establishing a second call

Establish an additional call during an active call.

1. "Telephone"
2. "Active calls"
3. 📞 "Hold"

The existing call is put on hold.

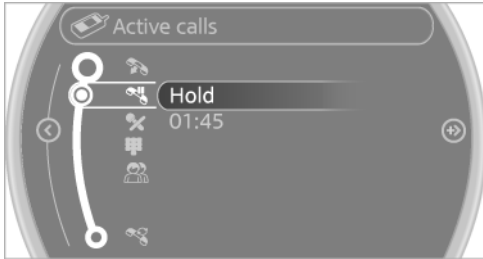

4. Dial the new phone number or select it from a list.

"Return"

The call on hold is resumed.

### Switching between two calls, hold call

Active call: highlighted.

Call on hold identified by: "on hold..."

- Select the symbol to change to the call on hold.

### Establishing a conference call

Two calls can be connected to a single telephone conference call.

1. Establish two calls.
2.  "Conference call"

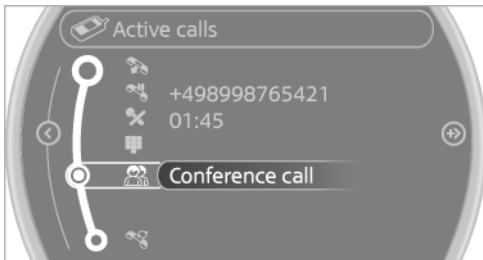

When terminating a conference call, both calls are ended. If one call is terminated by another party, the other call can be continued.

### DTMF suffix dialing

DTMF suffix dialing can be used for gaining access to network services or for controlling devices, e.g., to make a remote inquiry of an answering machine. The DTMF code is needed for this purpose.

ces, e.g., to make a remote inquiry of an answering machine. The DTMF code is needed for this purpose.

1. "Telephone"
2. Select the contact from a list or "Dial number".
3.  "Keypad dialing"

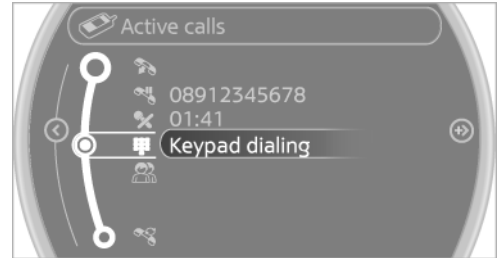

4. Enter the DTMF code on the onboard monitor.

DTMF suffix dialing is not possible during conference calls.

### Phone book

#### Displays



The phone book accesses the contacts and shows all contacts for which a phone number has been stored. The entries can be selected to make a call.

1. "Telephone"
2. "Phone book"

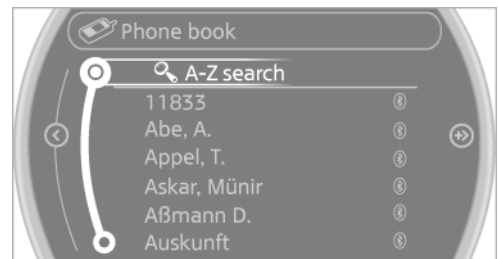
A symbol indicates the storage location of the contacts.



## Calling a contact

Symbol	Meaning
	Contact with one stored phone number.
	Contact with more than one stored phone number.
	Call not possible; mobile phone without reception or network.

For contacts with one stored phone number: select the required contact. The connection is being established.

For contacts with more than one stored phone number: select the required contact and the phone number. The connection is being established.

## Editing a contact

Changing the entries in "Contacts". When a contact is changed, the changes are not stored on the mobile phone. A copy of the entry is stored in the vehicle.

1. Highlight the contact.
2. Open "Options".
3. "Edit entry"

The contact can be edited.

## Redialing

### General information

The list of dialed numbers in the mobile phone is transmitted to the vehicle depending on the mobile phone. Possibly only those numbers are displayed that were dialed from the vehicle.

The 20 phone numbers dialed last are displayed. The sorting order of the phone numbers depends on the particular mobile phone.

## Dialing a number on the onboard monitor

1. "Telephone"
2. "Redial"

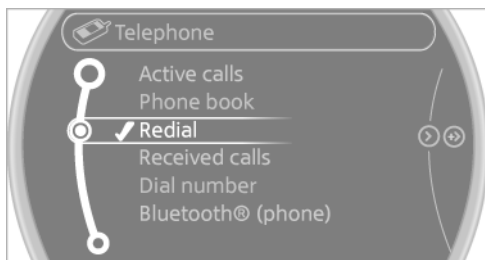

3. Select the desired entry and the phone number if necessary.

The connection is established.

## Deleting a single entry or all entries

The deletion of entries depends on your particular mobile phone.

1. Highlight the entry.
2. Open "Options".
3. "Delete entry" or "Delete list"

## Saving an entry in the contacts

1. Highlight the entry.
2. Open "Options".
3. "Store as new contact" or "Add to existing contact"
4. Select the contact if necessary.
5. Select the type of number: "Home", "Business", "Mobile" or "Other"
6. Complete the entries if necessary.
7. "Store contact"

## Received calls

### Displaying calls

The list of received calls on the mobile phone is transmitted to the vehicle, depending on the particular mobile phone. It is possible that only

those calls are displayed that were received in the vehicle.

The 20 telephone calls that were last received are displayed. The sorting order and display of the phone numbers depends on the particular mobile phone.

1. "Telephone"
2. "Received calls"

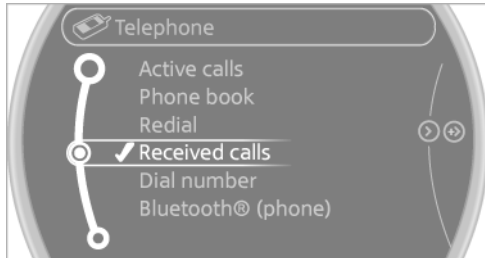

### Calling a number from the list

Selecting an entry.

The connection is established.

### Deleting a single entry or all entries

The deletion of entries depends on your particular mobile phone.

1. Highlight the entry.
2. Open "Options".
3. "Delete entry" or "Delete list"

### Saving an entry in the contacts

1. Highlight the entry.
2. Open "Options".
3. "Store as new contact" or "Add to existing contact"
4. Select the contact if necessary.
5. Select the type of number: "Home", "Business", "Mobile" or "Other"
6. Complete the entries if necessary.
7. "Store contact"

## Hands-free system

### General information

Calls that are being made on the hands-free system can be continued on the mobile phone and vice versa.

### From the mobile phone to the hands-free system

Calls that were begun outside of the Bluetooth range of the vehicle can be continued on the hands-free system with the ignition switched on.

Depending on the mobile phone, the system automatically switches to the hands-free system.

If the system does not switch over automatically, follow the instructions on the mobile phone display; refer also to the mobile phone operating instructions.

### From the hands-free system to the mobile phone

Calls that are made on the hands-free system can in some cases be continued on the mobile phone; this depends on the mobile phone.

Follow the instructions on the mobile phone display; refer also to the mobile phone operating instructions.

## CONTACTS

### General information

Contacts can be created and edited and the addresses can be adopted as destinations for navigation.

## New contact

1. "Contacts"
2. "New contact"

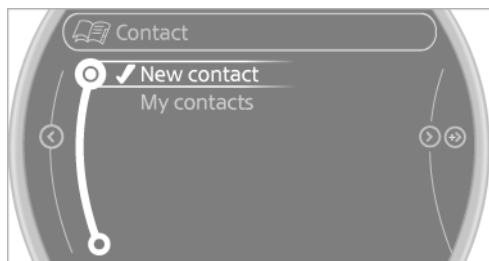

3. The entry fields are still filled with the previous entries: "Delete input fields"
4. Fill in the entry fields: select the symbol next to the entry field.

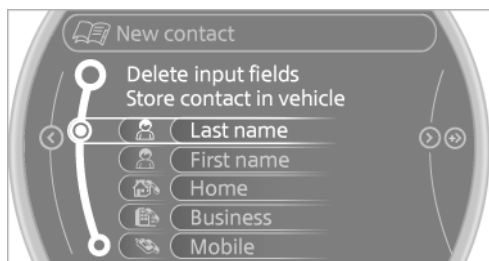

5. Enter the text, refer to page 22.  
If the vehicle is equipped with a navigation system: enter the address. Only addresses contained in the navigation data in the vehicle can be entered. This ensures that destination guidance is possible for all addresses.
6. If necessary, "Store".
7. "Store contact in vehicle"

## Specifying the home address

A home address can be stored. It appears at the top of the contact list.

1. "Home"
2. Create a contact.
3. "Store contact in vehicle"

## My contacts

### General information

List of all contacts stored in the vehicle.

### Displaying contacts

1. "Contacts"
2. "My contacts"

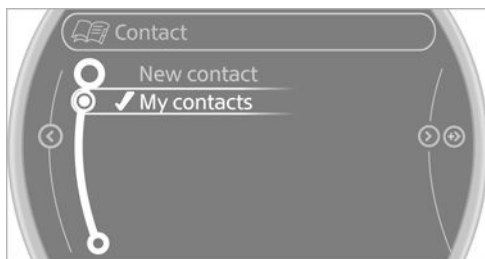

All contacts are listed in alphabetical order. Depending on the number of contacts, an A-Z search is offered.

A symbol indicates the storage location of the contacts:

Symbol	Storage location
No symbol	In the vehicle; the address has not been checked as a destination.
	In the vehicle; the address has been checked as a destination.
	Mobile phone

## Editing a contact

1. Select the desired contact.
2. "Edit contact"



3. Change the entries.
4. Move the MINI joystick to the left.
5. "Yes"

If a contact from the mobile phone is edited, the changes are not stored on the mobile phone. A copy of the entry is stored in the vehicle, and only this copy is displayed. Under certain circumstances, a contact entry with the same name is created.

## Selecting the contact as a navigation destination

1. Select the desired contact.
2. Select the address.
3. "Start guidance" or "Add as another destination"

## Checking the address as a destination

An address that is to be used for destination guidance must match the navigation data contained in the vehicle. The address can be checked for this purpose.

1. Select the desired contact and highlight the address.
2. Open "Options".
3. "Check as destination"
4. Correct and store the address if necessary.

## Selecting the sorting order of the names

Names can be displayed in a different order.

1. "My contacts"
2. Open "Options".
3. "Display: last, first name" or "Display: first, last name"

Depending on how the contacts are stored on the mobile phone, the sorting order of the names may differ from the selected sorting order.

## Deleting contacts

1. "My contacts"
2. Highlight the contact.
3. Open "Options".
4. "Delete contact" or "Delete all contacts"

# BLUETOOTH MOBILE PHONE PREPARATION PACKAGE

## VEHICLE EQUIPMENT

This chapter describes all series equipment as well as country-specific and special equipment offered for this model series. Therefore, it also describes equipment that may not be found in your vehicle, for instance due to the selected special equipment or the country version. This also applies to safety-related functions and systems.

## AT A GLANCE

### The concept

Mobile phones or other external devices such as audio players can be connected to the vehicle via Bluetooth.

Bluetooth® is a registered trademark of Bluetooth® SIG, Inc.

After these devices are paired once, they are recognized automatically when the ignition is switched on as soon as they are in the vehicle and can then be operated via the onboard monitor, using the buttons on the steering wheel, and via voice activation.

Depending on their functionality, external devices can be used via the vehicle as a telephone or as an audio source. The telephone functions are described in the following. Operating the audio functions, refer to page [175](#).

Up to four external devices can be paired.

Certain functions may need to be enabled by the mobile phone provider or service provider.



Using the mobile phone while driving

Make entries only when traffic and road conditions allow. Do not hold the mobile phone in your hand while you are driving; use the

hands-free system instead. If you do not observe this precaution, you can endanger the vehicle occupants and other road users. ◀

### Snap-in adapter

The snap-in adapter is used to:

- ▷ Hold the mobile phone.
- ▷ Recharge the battery.
- ▷ Connect the mobile phone to an outside antenna of the vehicle.

This provides for better network reception and consistent sound quality.

### Approved mobile phones

#### Displaying the vehicle identification number and software part number

The vehicle identification number and software part number are needed to determine which mobile phones are supported by the mobile phone preparation package. The software version of the mobile phone may also be required.

1. "Telephone"
2. Open "Options".
3. "Bluetooth® info"
4. "Display system information"

These approved mobile phones with a certain software version, support the vehicle functions described below.

Malfunctions may occur with other mobile phones or software versions.

Do not operate a mobile phone that is connected to the vehicle on the mobile phone keypad, as this may lead to a malfunction.



## Notes

At high temperatures, the charging function of the mobile phone may be limited and functions may not be executed.

When using the mobile phone via the vehicle, note the operating instructions of the mobile phone.

## PAIRING/UNPAIRING THE MOBILE PHONE

### General information

The following functions are available:

- ▷ Use of a mobile phone as a telephone.
- ▷ Use of a mobile phone as an additional telephone.
- ▷ Use of a mobile phone as an audio source.
- ▷ Use of an audio device as an audio source, refer to page 175.

### Requirements

- ▷ The mobile phone is suitable, refer to page 192.
- ▷ The mobile phone is ready for operation.
- ▷ Bluetooth is activated in the vehicle and on the mobile phone.
- ▷ Bluetooth presettings may need to be made on the mobile phone, e.g., for a connection without confirmation or visibility, refer to the mobile phone operating instructions.
- ▷ Deactivate Bluetooth audio if necessary.
- ▷ Compare the control number on the Control Display with the control number on the mobile phone display. Confirm the control number on the mobile phone and in the vehicle.
- ▷ A number with at least four and a maximum of 16 digits was defined as the Blue-

tooth passkey. It is only required once for pairing.

- ▷ The radio ready state is switched on.

### Activating/deactivating Bluetooth

Bluetooth is not permitted everywhere. Comply with all safety guidelines and regulations.

1. "Telephone"
2. Open "Options".
3. "Bluetooth®"

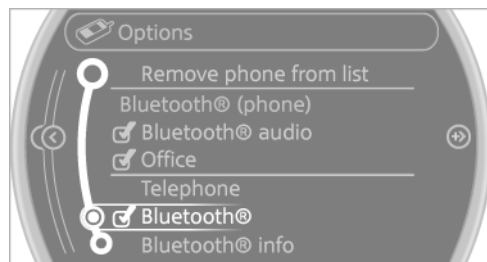

### Additional functions

#### Activating/deactivating the additional functions

Activate the functions before pairing to be able to use them in the vehicle. Information on suitable mobile phones, refer to page 192, that support this function.

1. "Telephone"
2. "Bluetooth® (phone)"
3. Open "Options".
4. "Configure Bluetooth®"
5. Select the desired additional function.
  - ▷ "Additional telephone"
  - ▷ "Office"
  - ▷ "Bluetooth® audio"
6. "OK"

An additional function cannot be assigned to a telephone while it is deactivated.

## Additional telephone

A mobile phone can be used as an additional telephone.

The additional telephone can be used to accept incoming calls, refer to page 197. While a call is active on the additional telephone, received calls are displayed on the Control Display.

## Office

Contacts, appointments, tasks, notes, text messages, and e-mails from the mobile phone are transferred to the vehicle.

## Bluetooth audio

A mobile phone can be used as an audio source.

"Bluetooth® audio"

To use a mobile phone in the vehicle as a telephone only, deactivate the function and reconnect the mobile phone.

## Pairing and connecting a mobile phone

### Pairing the mobile phone

To avoid becoming distracted and posing an unnecessary hazard both to your own vehicle's occupants and to other road users, only pair the mobile phone while the vehicle is stationary. ◀

1. "Telephone"
2. "Bluetooth® (phone)"
3. "Add new phone"

The Bluetooth name of the vehicle is displayed.



4. To perform additional steps on the mobile phone, refer to the mobile phone operating instructions: for instance, search for or connect the Bluetooth device or a new device.

The Bluetooth name of the vehicle appears on the mobile phone display.

5. Select the Bluetooth name of the vehicle on the mobile phone display.
6. You are prompted by the onboard monitor or mobile phone to enter the same Bluetooth passkey.

Enter the passkey and confirm.

or

Compare the control number on the vehicle display with the control number on the mobile phone display. Confirm the control number on the mobile phone and in the vehicle.

"OK"



7. Select the functions for which the mobile phone is to be used.

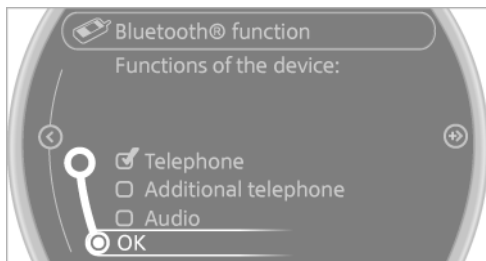



8. "OK"
9. Move the MINI joystick to the left.

If the pairing was successful, the mobile phone appears at the top of the list of mobile phones.

The functions supported by the mobile phone and audio device are displayed as symbols when paired.

White symbol: the function is active.

Gray symbol: the function is inactive.

Symbol	Function
	Telephone.
	Additional telephone.
	Audio source.

Four mobile phones can be paired with the vehicle at once. Three mobile phones can be connected with the vehicle at once.

If pairing was unsuccessful: What to do if..., refer to page 196.

### Following the initial pairing

- ▶ The mobile phone is detected/connected in the vehicle within a short period of time when the engine is running or the ignition is switched on.
- ▶ The phone book entries of the telephone stored on the SIM card or mobile phone are transmitted to the vehicle after detection, depending on the mobile phone.
- ▶ Specific settings may be necessary in some mobile phones, e.g., authorization or a secure connection; refer to the mobile phone operating instructions.

### Connecting a particular mobile phone

1. "Telephone"
2. "Bluetooth® (phone)"  
All paired mobile phones are listed.

3. Select the mobile phone that is to be connected.



The functions assigned to the mobile phone before unpairing are assigned to the mobile phone when it is reconnected. These functions are deactivated in a mobile phone that is already connected.

### Device options

Device options can be activated or deactivated for paired and connected devices.

### Configuring the mobile phone

Additional functions can be activated or deactivated for paired and connected mobile phones.

1. "Telephone"
2. "Bluetooth® (phone)"
3. Highlight the mobile phone to be configured.
4. Open "Options".
5. "Configure phone"

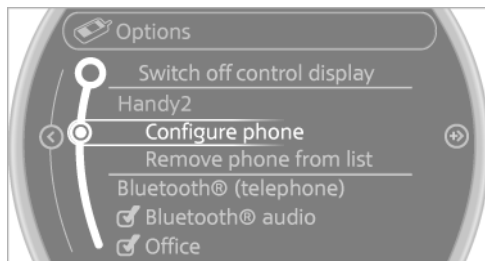

6. At least one function must be selected.
  - ▶ "Telephone"

- ▷ "Additional telephone"
- ▷ "Audio"

#### 7. "OK"

If a function has already been assigned to another connected mobile phone, the function is deactivated in that mobile phone and the mobile phone is unpaired when the function is assigned to a new mobile phone.

### Swapping the telephone and additional telephone

If a phone and additional phone are connected to the vehicle, the function can be swapped between the two devices.

1. "Telephone"
2. "Bluetooth® (phone)"
3. "Swap phone/addit. phone"

### Using a mobile phone as an audio source

An audio-capable mobile phone can be used as an audio source. Activate Bluetooth audio, refer to page 194.

Pair the mobile phone with the vehicle and connect it, refer to page 194.

The mobile phone is used as the audio source, provided that another device has not been connected as the audio source.

If another device has already been connected as the audio source:

1. Pair the mobile phone with the vehicle and connect it, refer to page 194.
2. "Use for audio"

The mobile phone is connected as an audio source. The previous audio source is no longer connected to the vehicle.

### Unpairing a device

1. "Telephone"
2. "Bluetooth® (phone)"

All paired devices are listed.

3. Highlight the device that is to be unpaired.
4. Open "Options".
5. "Remove phone from list"

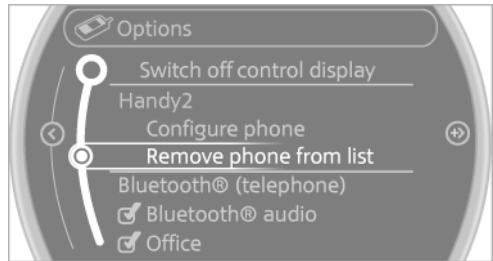

### What to do if...

Information on suitable mobile phones, refer to page 192.

The mobile phone could not be paired or connected.

- ▷ Is Bluetooth activated in the vehicle and on the mobile phone? Activate Bluetooth in the vehicle and on the mobile phone.
- ▷ Do the Bluetooth passkeys on the mobile phone and the vehicle match? Enter the same passkey on the mobile phone and via the onboard monitor.
- ▷ A multi-character passkey may be needed.
- ▷ Did it take longer than 30 seconds to enter the passkey? Repeat the pairing procedure.
- ▷ Are too many Bluetooth devices connected to the mobile phone or vehicle? Delete connections with other devices if necessary.
- ▷ Is the audio connection activated? Deactivate the audio connection.
- ▷ Is the mobile phone in power-save mode or does it have only a limited remaining battery life? Charge the mobile phone in the snap-in adapter or via the charging cable.
- ▷ Depending on the mobile phone, it is possible that only one mobile phone can be connected to the vehicle. Unpair the connected mobile phone from the vehicle and pair and connect only one mobile phone.

The mobile phone no longer reacts.

- ▷ Switch the mobile phone off and on again.
- ▷ Is the ambient temperature too high or low? Do not expose the mobile phone to extreme environmental conditions.

The telephone functions are not available.

- ▷ Is the mobile phone paired as an additional telephone and is the additional telephone function deactivated? Activate the function.
- ▷ Is an outgoing call not possible? Connect the mobile phone as a telephone.

No phone book entries or only some phone book entries are displayed, or they are incomplete.

- ▷ Transmission of the phone book entries is not yet complete.
- ▷ It is possible that only the phone book entries of the mobile phone or the SIM card are transmitted.
- ▷ It may not be possible to display phone book entries with special characters.
- ▷ The number of phone book entries to be stored is too high.
- ▷ Is the data volume of the contact too large, e. g., due to stored information such as notes? Reduce the data volume of the contact.
- ▷ Is the mobile phone connected as an audio source or additional telephone? The mobile phone must be connected as a telephone.

The phone connection quality is poor.

- ▷ The strength of the Bluetooth signal on the mobile phone can be adjusted, depending on the mobile phone.
- ▷ Insert the mobile phone into the snap-in adapter or place it in the area of the center console.
- ▷ Adjust the volume of the microphone and loudspeakers separately.

If all points in this list have been checked and the required function is still not available, contact Customer Relations or the service center.

## CONTROLS

### Adjusting the volume



Turn the knob until the desired volume is selected. The setting is stored for the remote control currently in use.

The vehicle automatically adjusts the volume of the microphone on the telephone and the volume of the called party. Depending on the mobile phone, the volumes may need to be adjusted.

The settings can only be created during a call and must be adjusted separately for each telephone. The settings are deleted when the telephone is unpaired.

1. "Settings"
2. "Tone"
3. "Volume settings"
4. Select the desired setting: "Microphone" or "Loudspeak."
5. To set: turn the MINI joystick.
6. To save: press the MINI joystick.

### Incoming call

### Receiving calls

If the number of the caller is stored in the phone book and is transmitted by the network, the name of the contact is displayed. Otherwise, only the phone number is displayed.

If more than one phone number is assigned to a contact, only the name of the contact is displayed.

For calls on the additional telephone, the number is only displayed if it is transmitted by the network.

An incoming call to one of the telephones is automatically rejected if there is an active call on the other telephone.

### Accepting a call



Press the button on the steering wheel.

or

"Accept"

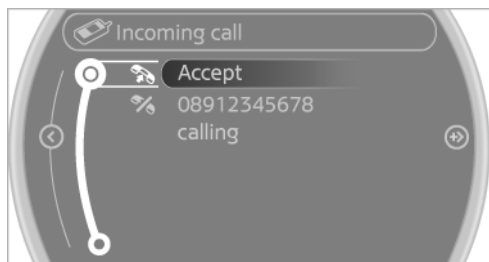

### Rejecting a call

"Reject"

The caller is redirected to the mailbox if the mailbox was activated

### Ending a call



Press the button on the steering wheel.

or

1. "Telephone"

2. "End call"

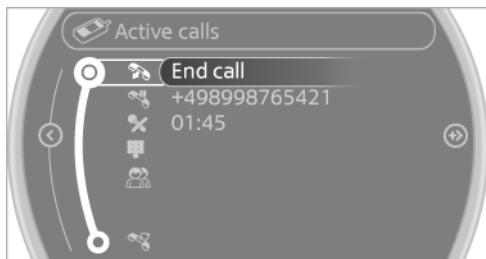

### Entering a phone number

#### Dialing a number

1. "Telephone"
2. "Dial number"
3. Select the digits individually.
4. Select the symbol.



The phone number can also be entered by voice.

### Calls with multiple parties

#### General information

You can switch between calls or connect two calls to a single conference call. These functions must be supported by the mobile phone and service provider.

#### Accepting a call while speaking to another party

This function might have to be activated by the service provider and the mobile phone must be adjusted accordingly.

If a second call comes in during an ongoing call, a call waiting signal is sounded.

 "Accept"

The call is accepted and the existing call is put on hold.

### Establishing a second call

Establish an additional call during an active call.

1. "Telephone"
2. "Active calls"
3.  "Hold"

The existing call is put on hold.

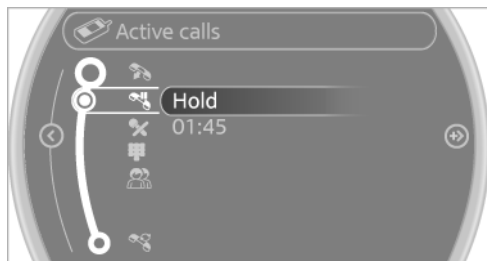

4. Dial the new phone number or select it from a list.

"Return"

The call on hold is resumed.

### Switching between two calls, hold call

Active call: highlighted.

Call on hold identified by: "on hold...".

 Select the symbol to change to the call on hold.

### Establishing a conference call

Two calls can be connected to a single telephone conference call.

1. Establish two calls.

2.  "Conference call"

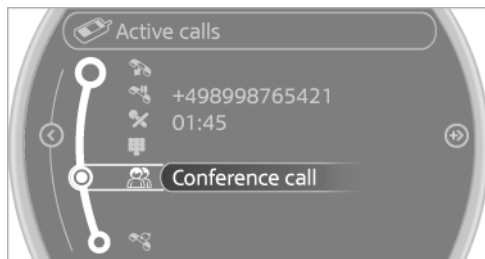

When terminating a conference call, both calls are ended. If one call is terminated by another party, the other call can be continued.

### Switching the microphone to mute

When a call is active, the microphone can be muted.

1. "Telephone"
2. "Active calls"
3.  "Microphone mute"

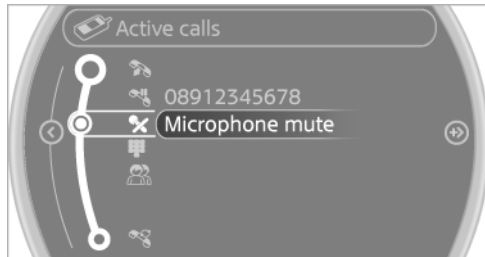

A microphone that has been switched to mute is automatically reactivated:

- ▷ When a new connection is established.
- ▷ When switching between call parties.

### DTMF suffix dialing

DTMF suffix dialing can be used for gaining access to network services or for controlling devices, e.g., to make a remote inquiry of an

swering machine. The DTMF code is needed for this purpose.

1. "Telephone"
2. Select the contact from a list or "Dial number".
3.  "Keypad dialing"

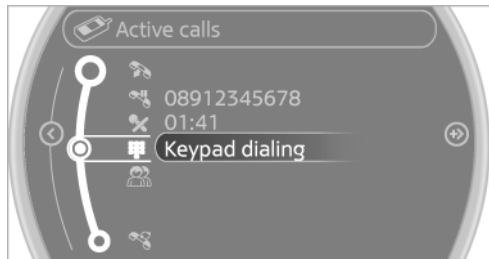

4. Enter the DTMF code on the onboard monitor.

DTMF suffix dialing is not possible during conference calls.

## Phone book

### Displays



The phone book accesses the contacts and shows all contacts for which a phone number has been stored. The entries can be selected to make a call.

1. "Telephone"
2. "Phone book"

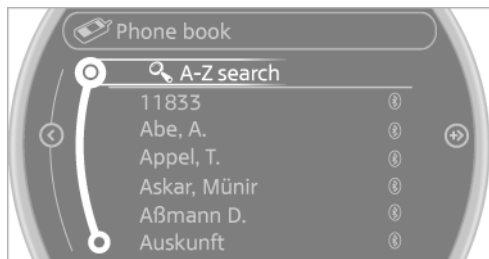
A symbol indicates the storage location of the contacts.



## Calling a contact

Symbol	Meaning
	Contact with one stored phone number.
	Contact with more than one stored phone number.
	Call not possible; mobile phone without reception or network.

For contacts with one stored phone number: select the required contact. The connection is being established.

For contacts with more than one stored phone number: select the required contact and the phone number. The connection is being established.

## Editing a contact

Changing the entries in "Contacts". When a contact is changed, the changes are not stored on the mobile phone. A copy of the entry is stored in the vehicle.

1. Highlight the contact.
2. Open "Options".
3. "Edit entry"

The contact can be edited.

## Redialing

### General information

The list of dialed numbers in the mobile phone is transmitted to the vehicle depending on the mobile phone. Possibly only those numbers are displayed that were dialed from the vehicle.

The 20 phone numbers dialed last are displayed. The sorting order of the phone numbers depends on the particular mobile phone.



## Dialing a number on the onboard monitor

1. "Telephone"
2. "Redial"

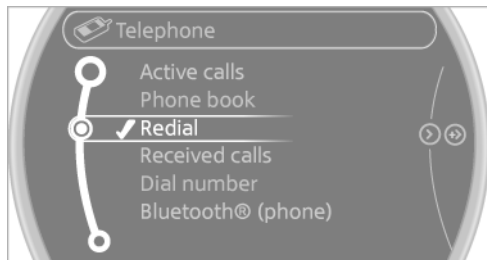

3. Select the desired entry and the phone number if necessary.

The connection is established.

## Deleting a single entry or all entries

The deletion of entries depends on your particular mobile phone.

1. Highlight the entry.
2. Open "Options".
3. "Delete entry" or "Delete list"

## Saving an entry in the contacts

1. Highlight the entry.
2. Open "Options".
3. "Store as new contact" or "Add to existing contact"
4. Select the contact if necessary.
5. Select the type of number: "Home", "Business", "Mobile" or "Other"
6. Complete the entries if necessary.
7. "Store contact"

## Received calls

### Displaying calls

The list of received calls on the mobile phone is transmitted to the vehicle, depending on the particular mobile phone. It is possible that only

those calls are displayed that were received in the vehicle.

The 20 telephone calls that were last received are displayed. The sorting order and display of the phone numbers depends on the particular mobile phone.

1. "Telephone"
2. "Received calls"

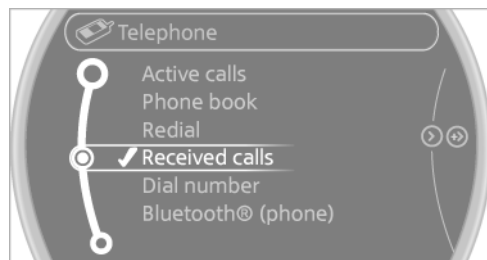

## Calling a number from the list

Selecting an entry.

The connection is established.

## Deleting a single entry or all entries

The deletion of entries depends on your particular mobile phone.

1. Highlight the entry.
2. Open "Options".
3. "Delete entry" or "Delete list"

## Saving an entry in the contacts

1. Highlight the entry.
2. Open "Options".
3. "Store as new contact" or "Add to existing contact"
4. Select the contact if necessary.
5. Select the type of number: "Home", "Business", "Mobile" or "Other"
6. Complete the entries if necessary.
7. "Store contact"

## SNAP-IN ADAPTER

### General information

More information on compatible snap-in adapters that support the functions of the mobile phone is available at the service center.

### Notes

At high temperatures, the charging function of the mobile phone may be limited and functions may not be executed.

When using the mobile phone via the vehicle, note the operating instructions of the mobile phone.

### Installation position

In the center armrest.

### Inserting/removing the snap-in adapter

1. Press button 1 and remove the cover.

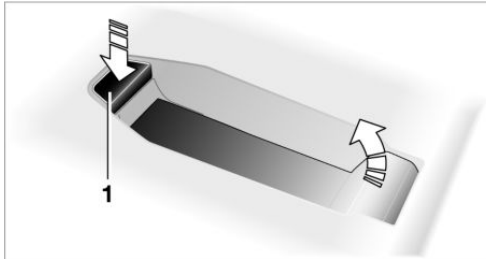

2. Insert the snap-in adapter at the front, arrow 1, and press down, arrow 2, until it engages.

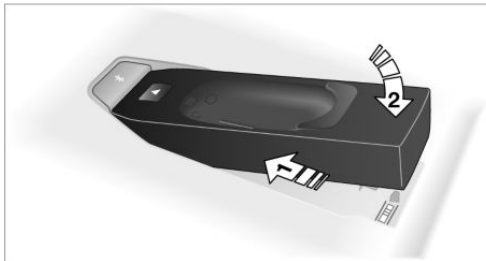

3. To remove the snap-in adapter: press button 1.

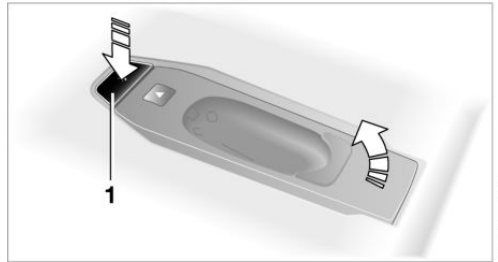

### Inserting the mobile phone

1. Depending on the mobile phone, remove the protective cap from the antenna connector and from the USB connection of the mobile phone.
2. With the buttons facing up, slide the mobile phone up toward the electrical contacts and press it down until it engages.

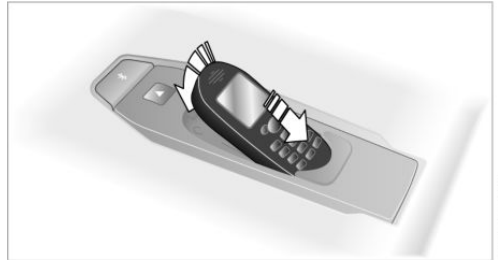

The battery is charged beginning with the radio ready state of the vehicle.

## Removing the mobile phone

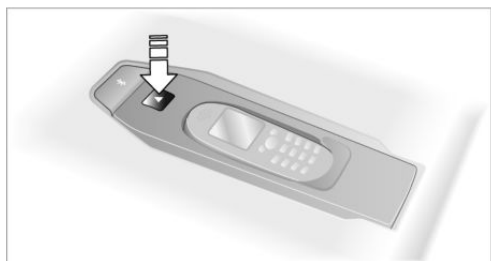

MM07796QMA

Press the button and remove the mobile phone.

# OFFICE

## VEHICLE EQUIPMENT

This chapter describes all series equipment as well as country-specific and special equipment offered for this model series. Therefore, it also describes equipment that may not be found in your vehicle, for instance due to the selected special equipment or the country version. This also applies to safety-related functions and systems.

## AT A GLANCE

### General information

Contacts, appointments, tasks, notes, text messages, and e-mails from the mobile phone can be displayed on the Control Display if the mobile phone provides compatible support of these functions and the necessary Bluetooth standards.

Information about which mobile phones and functions are available can be found at [www.mini.com/connectivity](http://www.mini.com/connectivity).

Contents are only displayed in full length when the vehicle is stationary.

The mobile phone has read-access only.

 Do not use Office while driving

To avoid becoming distracted and posing an unnecessary hazard to your vehicle's occupants and to other road users, never attempt to use the controls or enter information unless traffic and road conditions allow this. ◀

### Requirements

- ▷ A suitable mobile phone is paired with the vehicle and connected. In some mobile phones, data access must be confirmed on the mobile phone.

- ▷ The time, time zone, and date, refer to page 79, are correctly set on the Control Display and on the mobile phone, for instance to correctly display appointments.

### Updating

Data are updated every time the mobile phone is connected to the vehicle. Appointment entries, tasks, notes and reminders can be updated separately.

1. "Office"
2. "Current office", "Calendar", "Tasks", "Notes" or "Reminders"
3. Open "Options".
4. "Update data"

Mobile phone data are transmitted again to the vehicle.

## OFFICE INFORMATION

The number of unread messages and active tasks as well as the upcoming appointments are displayed.

1. "Office"
2. "Current office"
3. Select the desired entry to display details.

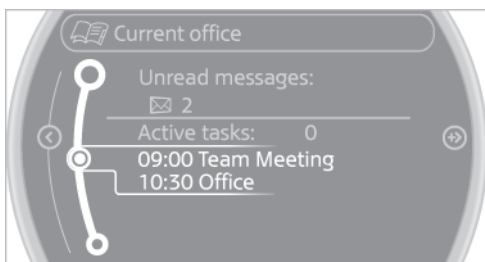

## CONTACTS

### At a glance

Contacts can be created and edited. The contacts from the mobile phone are displayed as well if this function is supported by the mobile phone. The addresses can be adopted as destinations for navigation and the phone numbers can be dialed.

### Displaying contacts

#### General information

1. "Office"
2. "Contacts"

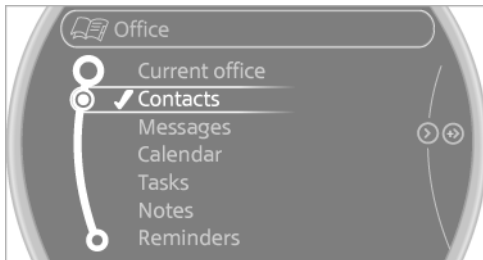

All contacts are listed in alphabetical order. Depending on the number of contacts, an A-Z search is offered.

A symbol indicates the storage location of the contacts.

Symbol	Storage location
No symbol	In the vehicle; the address has not been checked as a destination.
	In the vehicle; the address has been checked as a destination.
	Mobile phone.

### Dialing a phone number

1. Select the desired contact.
2. Select the phone number.  
The connection is established.

### Editing a contact

1. Select the desired contact.
2. "Edit contact"

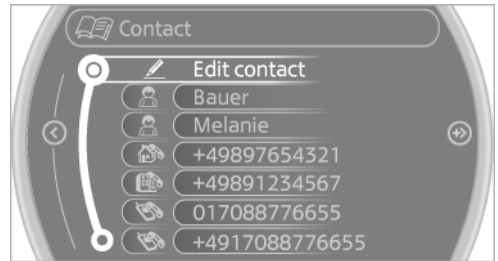

3. Change the entries.
4. "Store contact in vehicle"

When a contact is edited, the changes are not stored on the mobile phone. A copy of the entry is stored in the vehicle.

### Selecting the contact as a navigation destination

1. Select the desired contact.
2. Select the address.

When contacts from the mobile phone are used, the address may need to be matched to the navigation data contained in the vehicle. In this case:

Correct the address.

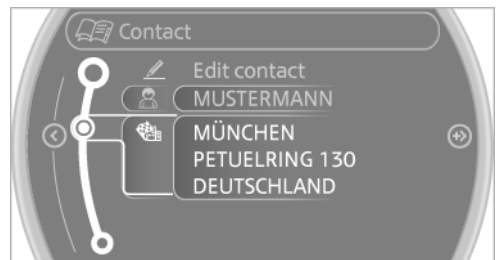

3. "Start guidance" or "Add as another destination"

### Checking the address as a destination

An address that is to be used for destination guidance must match the navigation data con-

tained in the vehicle. The address can be checked for this purpose.

1. Select the desired contact and highlight the address.
2. Open "Options".
3. "Check as destination"
4. Correct and store the address if necessary.

If the address is corrected and stored, a copy of it is stored in the vehicle. The address is not changed on the mobile phone.

## New contact

### General information

A contact can have up to 8 phone numbers, 2 addresses, 3 e-mail addresses and one Internet address.

1. "Office"
2. "Contacts"
3. Open "Options".
4. "New contact"

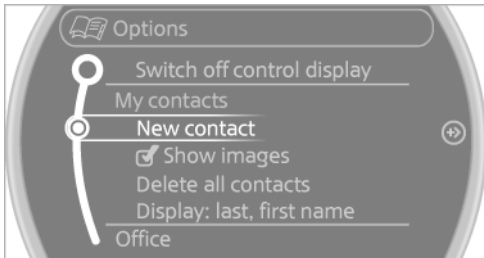

5. The entry fields are still filled with the previous entries: "Delete input fields"
6. Fill in the entry fields: select the symbol next to the entry field.
7. Enter the text and assign the contact type.
8. If the vehicle is equipped with a navigation system: enter the address. Only addresses contained in the navigation data in the vehicle can be entered. This ensures that destination guidance is possible for all addresses.

If necessary, "Accept address".

9. "Store contact in vehicle"

### Contact types

Various contact types can be assigned to phone numbers and addresses.

Symbol	Meaning
	Home phone number.
	Business phone number.
	Mobile phone number.
	Other phone number.
	Home address.
	Business address.

### Specifying the home address

A home address can be stored. It appears at the top of the contact list.

1. "Office"
2. "Contacts"
3. "Home"
4. Create a contact.
5. "Store contact in vehicle"

### Selecting the sorting order of the names

Names can be displayed in a different order.

1. "Office"
2. "Contacts"
3. Open "Options".
4. "Display: last, first name" or "Display: first, last name"

Depending on how the contacts were stored on the mobile phone, the sorting order of the names may differ from the selected sorting order.

## Show contact pictures

Pictures stored with the contacts are stored in the vehicle when the mobile phone is connected to the vehicle. The number of transmitted pictures depends on the mobile phone. The mobile phone must support this function.

1. "Office"
2. "Contacts"
3. Open "Options".
4. "Configure Bluetooth®"
5. "Show images"

Display of all contact pictures is activated or deactivated.

## Deleting contacts

Only contacts that are stored in the vehicle are deleted. The contacts on the mobile phone cannot be deleted.

1. "Office"
2. "Contacts"
3. Highlight the contact.
4. Open "Options".
5. "Delete contact" or "Delete all contacts"

# MESSAGES



## General information

Whether or not text messages and e-mails from the mobile phone are displayed depends on whether transmission from the mobile phone to the vehicle is supported. Text messages and e-mails may not be supported by the service provider, or the function may need to be enabled separately. After the mobile phone is first paired, transmission may take several minutes. Messages are only displayed in full length when the vehicle is stationary. Messages from the additional telephone are not transmitted.

## Displaying messages

1. "Office"
2. "Messages"

A symbol identifies the type of message.

Symbol	Message type
	Text messages.
	E-mail from mobile phone.

## Filtering the message list

The message list can be filtered if more than one type of message exists.

1. "Filter:"
2. Select the type of message.
  - ▷ "All"
    - All messages are displayed.
  - ▷ "Text message"
    - Only text messages from the mobile phone are displayed.
  - ▷ "E-mail"
    - Only e-mails from the mobile phone are displayed.

## Text messages

### Calling the sender of a text message

1. Select the desired message.
2.  Select the symbol.

### Saving the sender in the contacts

1. Highlight the desired message.
2. Open "Options".
3. "Store as new contact" or "Add to existing contact"

## Using contact data

Contact data from appointments, tasks, text messages, e-mails, and notes can be stored or selected, refer to page 210.

## Reading the text message out loud

Read the text message out loud, refer to page [210](#).

## E-mail

### Displaying e-mails

1. "Office"
2. "Messages"
3. Select the desired e-mail.

### Displaying e-mail contacts

If the sender and recipient of an e-mail are transmitted by the mobile phone, this information is displayed in the e-mail.

 "Sender/Recipient"

If the e-mail addresses are stored in the contacts, the contact is displayed. Select the contact to display details.

If the e-mail addresses are not stored in the contacts, only the e-mail address is displayed.

### Using contact data

Contact data from appointments, tasks, text messages, e-mails, and notes can be stored or selected, refer to page [210](#).

### Deactivating the full display

When an e-mail is opened in the vehicle, the e-mail is fully transmitted to the vehicle. This may result in charges.

1. "Office"
2. "Messages"
3. Open "Options".
4. "Fully download e-mails"

Only a part of the e-mail from the mobile phone is loaded into the vehicle.

### Reading the e-mail out loud

Read the e-mail out loud, refer to page [210](#).

## CALENDAR

### Display the calendar

Appointments during the last 20 days and the next 50 days can be displayed.

1. "Office"
2. "Calendar"

The appointments on the current day are displayed.

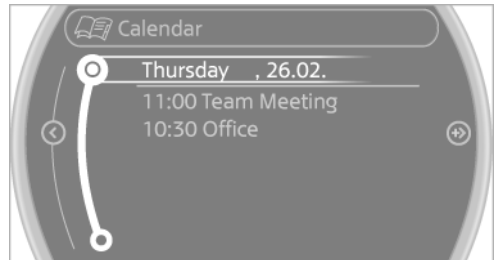

### Selecting the calendar day

1. Select the date.



2. Select the desired day or date.
  - ▷ "Next day"
  - ▷ "Date:"
  - ▷ "Previous day"
  - ▷ "Today"

### Display the appointment

1. Select the desired appointment.
2. Scroll through the appointment if necessary:
  - ▷ Turn the MINI joystick.
  - ▷   Select the symbol.

### Using contact data

Contact data from appointments, tasks, text messages, e-mails, and notes can be stored or selected, refer to page [210](#).



## Reading the appointment out loud

Read the appointment out loud, refer to page 210.

## TASKS

### Displaying the task list

Display tasks that are due within the next 90 days.

1. "Office"
2. "Tasks"

### Sorting the task list

1. Select the header in the task list.

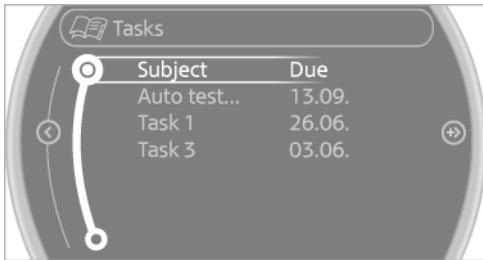

2. Select the sorting criterion:
  - ▷ "Priority (!)"
  - ▷ "Subject"
  - ▷ "Due date"

### Displaying the task

1. Select the desired task.
2. Scroll in the task if necessary:
  - ▷ Turn the MINI joystick.
  - ▷ Select the symbol.

### Using contact data

Contact data from appointments, tasks, text messages, e-mails, and notes can be stored or selected, refer to page 210.

## Reading the task out loud

Read the task out loud, refer to page 210.

## NOTES

### Displaying notes

1. "Office"
2. "Notes"
  - All notes are displayed.

### Displaying the note

1. Select the desired note.

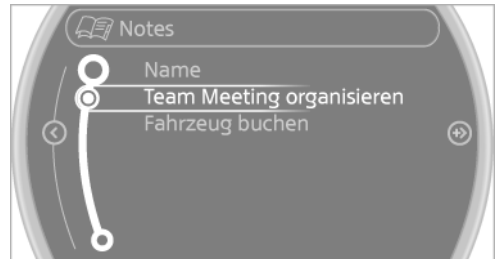

2. Scroll in the note if necessary:
  - ▷ Turn the MINI joystick.
  - ▷ Select the symbol.

### Using contact data

Contact data from appointments, tasks, text messages, e-mails, and notes can be stored or selected, refer to page 210.

### Reading the note out loud

Read the note out loud, refer to page 210.

## REMINDERS

### Displaying reminders

Reminders of pending appointments and tasks are displayed. After an appointment or after a task is due, the reminder is no longer displayed.

1. "Office"
2. "Reminders"
3. Select the desired reminder.

The corresponding appointment or the task are displayed.

## USING CONTACT DATA

### At a glance

Contact data from appointments, tasks, text messages, e-mails, and notes can be stored or selected.

### Displaying contact or selecting phone number

1.  "Use contact data"

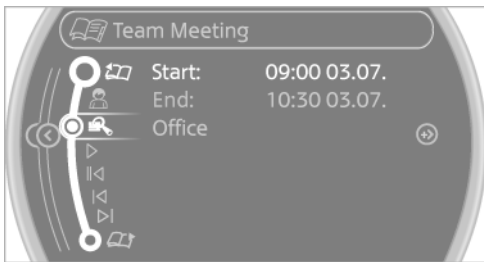

2. Display the contact or select the phone number:
  - ▷ Select the contact to display contact details.
  - ▷ Select the phone number to establish a connection directly.

### Storing contact data





1.  "Use contact data"
2. Highlight the phone number or e-mail address.
3. Open "Options".
4. "Add to existing contact" or "Store as new contact"

## READING OUT LOUD

Text messages, e-mails, appointment entries, tasks, and notes can be read out loud.

1. Select the desired message, appointment, task, or note.
2. ▷ Select the symbol.

The following options are available during reading:

- ▷  "Pause"  
Interrupt reading. Select again to restart reading.
- ▷  "Back to beginning"  
Start reading the message again from the beginning.
- ▷  Select the symbol.  
Go back one paragraph.
- ▷  Select the symbol.  
Skip a paragraph.
- ▷ To end reading, move the MINI joystick to the left.

## WHAT TO DO IF...

Information on suitable mobile phones, refer to page [192](#).

Appointments, tasks, notes, text messages, or e-mails from the mobile phone are not displayed.

- ▷ The mobile phone is not capable of the missing function or is not connected correctly.
- ▷ The Office function is deactivated.
- ▷ The mobile phone is connected as an additional phone.
- ▷ Appointments are older than 20 days or are more than 50 days in the future.
- ▷ The tasks have been marked as completed or have a due date that lies more than 90 days in the future.
- ▷ Depending on the number of stored appointments, task notes, and messages in the mobile phone, not all are displayed in the vehicle.

Not all appointments and tasks from the mobile phone are displayed at the right time?

- ▷ The time zone, time, or date is incorrectly set on the Control Display and mobile phone.

Entries are not displayed in full length.

- ▷ Text were already transmitted from the mobile phone in a shortened form.
- ▷ Synchronization between the mobile phone and vehicle may take several minutes.

The contact pictures are not being displayed?

- ▷ Up to 200 contact pictures can be stored in the vehicle.

If all points in this list have been checked and the required function is still not available, please contact the hotline or service center.

# MINI CONNECTED

## VEHICLE EQUIPMENT

This chapter describes all series equipment as well as country-specific and special equipment offered for this model series. Therefore, it also describes equipment that may not be found in your vehicle, for instance due to the selected special equipment or the country version. This also applies to safety-related functions and systems.

## AT A GLANCE

### The concept

Certain software applications of a suitable mobile phone can be integrated in the vehicle. These software applications are displayed on the Control Display.

They are operated via the onboard monitor.

The scope of the software applications may vary by country.

### Requirements

- ▷ The mobile phone is suitable.
- ▷ The mobile phone operating system supports the software applications of MINI Connected.
- ▷ Software applications are installed on the mobile phone and ready to use.
- ▷ Corresponding mobile wireless contract. Any additionally incurred costs are not a part of MINI Connected.

Information about suitable mobile phones, available software applications, and their installation can be obtained at [www.mini.com/](http://www.mini.com/) connectivity or from the service center.



Create the entries.

Make entries only when traffic and road conditions allow. Otherwise, the vehicle occupants and other road users may be put in danger because of the distraction from driving.

For reasons of safety, some software applications are usable only while the vehicle is stationary. ◀



Software applications

Use only software applications approved by the manufacturer of your MINI; otherwise, malfunctions may occur. ◀

## CONNECTING THE MOBILE PHONE

### Connection via the USB audio interface



The USB audio interface is in the center console.

Connect the mobile phone to the USB interface and the AV-IN port using a special adapter cable available from the service center.

To perform additional steps on the mobile phone, refer to the mobile phone operating instructions: for instance, selecting and activating software applications.

### Connection via the snap-in adapter



The mobile phone can also be connected, refer to page 202, via the snap-in adapter.

## OPERATING MINI CONNECTED

After the mobile phone is successfully connected with the vehicle and MINI Connected is started, the applications are displayed on the

Control Display and can be operated using the MINI joystick.

The volume can be set using the following controls:

- ▷   Buttons on the steering wheel or
- ▷ Volume button on the radio, refer to page 160

1. Connect the mobile phone via the snap-in adapter or via the USB audio interface.
2.  Press the button. The main menu is opened.
3. "MINI Connected"

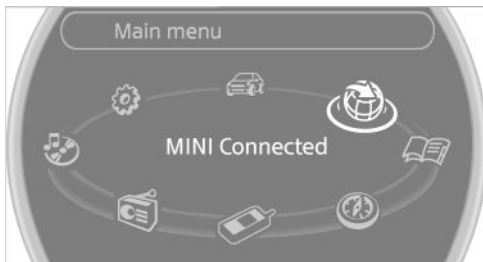

4. Select the desired software application.

### Notes

- ▷ The scope of MINI Connected that can be displayed on the Control Display depends on the range of software applications installed on the mobile phone.
- ▷ The data transmission of the software applications from the mobile phone to the vehicle can last some time. Some software applications depend on the speed of the available Internet connection of the mobile phone.
- ▷ Some mobile phones cannot simultaneously use MINI Connected and the Bluetooth hands-free system.

If necessary, restart the software application on the mobile phone after a phone conversation.

- ▷ Audio and video playback from the snap-in adapter is only possible if no cable is connected to the AV-IN port.

## PLUGIN

### The concept

Selected functions of a compatible Apple device can be displayed on the Control Display via a video connection. They are operated using the MINI joystick and the button on the MINI joystick.

### Functional requirement

- ▷ Suitable iPhone or iPod: as of iPhone 3GS or iPod with software version iOS 4.1 and higher.
- ▷ The MINI Connected app is not required.

Information on compatible adapters and interfaces can be obtained from the service center.

### Activating

1. Connect the Apple device.  
Operation takes place via the MINI joystick with its buttons.
2. "MINI Connected"
3. "PlugIn"
4. Select the connection type: "Activate via AUX connection" or "Activate via Snap-In adapter"
5. "Activate PlugIn"
6. Use the MINI joystick to navigate among the displayed functions and select, for example, a desired category or track.

### Controls

The PlugIn is activated to display the graphic output of the connected device on the Control

Display. This changes the operating functions of the MINI joystick and the MINI buttons until the PlugIn is deactivated again.

The operation of the PlugIn depends on the iOS version in use, e.g., iOS 4.1.

### Home button



Press the button to select the following functions:

- ▷ Press 1x: opens the display menu bar.
- ▷ Press 2x: opens the main menu.
- ▷ Press 1x and move the MINI joystick to the left 1x: opens the MINI Connected menu.
- ▷ Press 1x and move the MINI joystick to the left 2x: opens the main menu.

### Toggle button



Press the button to select the following functions.

- ▷ Press 1x: return to the next higher menu level of the iPhones/iPods.

### MINI joystick

- ▷ Press: selection/play/pause.
- ▷ Turn: navigate through the lists.
- ▷ Move to the left: jump to the beginning of the current music track or to the previous music track in the playback list.
- ▷ Move the left and hold: reverse.
- ▷ Move to the right: jump to the next music track in the playback list.
- ▷ Move to the right and hold: fast forward.

### Deactivating

There are several methods of deactivating the PlugIn and returning to the MINI operating level.

### Via the home button

- ▷ Press 1x: returns to activating the PlugIn.

- ▷ Press 2x: opens the main menu.
- ▷ Press 1x and move the MINI joystick to the left 1x: opens the MINI Connected menu.
- ▷ Press 1x and move the MINI joystick to the left 2x: Opens the main menu.

### Via the audio source button



Press 1x: changes to the audio source selected last.



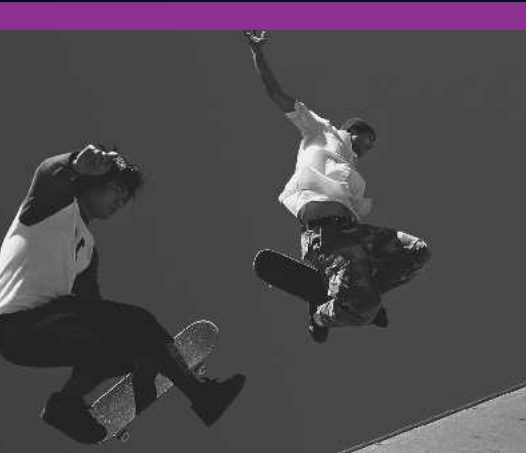



**AT A GLANCE**

**CONTROLS**

**DRIVING TIPS**

**NAVIGATION**

**ENTERTAINMENT**

**COMMUNICATION**

**MOBILITY**

**REFERENCE**

# REFUELING



## VEHICLE EQUIPMENT

This chapter describes all series equipment as well as country-specific and special equipment offered for this model series. Therefore, it also describes equipment that may not be found in your vehicle, for instance due to the selected special equipment or the country version. This also applies to safety-related functions and systems.

## GENERAL INFORMATION

-  Refuel promptly  
At the latest, refuel at a range below 30 miles/50 km; otherwise, the engine function is not ensured and damage may occur. ◀

## NOTES

-  Switch off the engine before refueling  
Always switch off the engine before refueling; otherwise, fuel cannot be added to the tank and a message will be displayed. ◀
-  Observe when handling fuel
  - ▷ Take all precautionary measures and observe all applicable regulations when handling fuel.
  - ▷ Do not carry any spare fuel containers in your vehicle. They can develop a leak and cause an explosion or cause a fire in the event of an accident. ◀

## FUEL CAP

### Opening

1. Open fuel filler flap.

2. Turn the fuel cap counterclockwise.
3. Place the fuel cap in the bracket attached to the fuel filler flap.

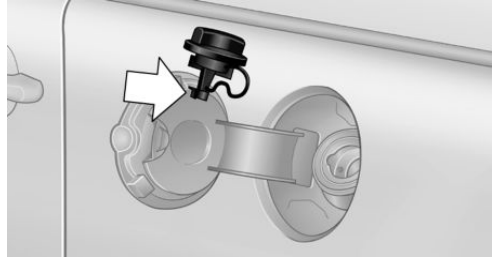

### Closing

1. Fit the fuel cap and turn it clockwise until you clearly hear a click.
2. Close the fuel filler flap.

-  Do not pinch the retaining strap  
Do not pinch the retaining strap attached to the cap; otherwise, the cap cannot be closed properly and fuel vapors can escape. ◀

A message is displayed if the cap is loose or missing.

### Manually unlocking fuel filler flap

In the event of a malfunction, the fuel filler flap can be released manually:

MINI Coupe, MINI Roadster:

1. Remove the cover of the left cargo area side wall.

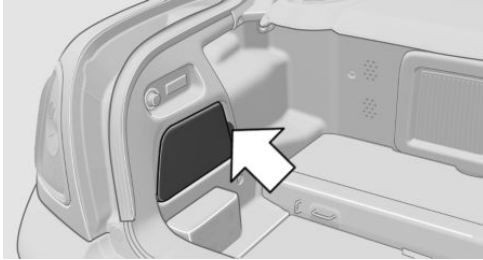

2. Pull the green knob with the gas pump symbol. This releases the fuel filler flap.

MINI Convertible:

1. Remove the cover of the left cargo area side wall.

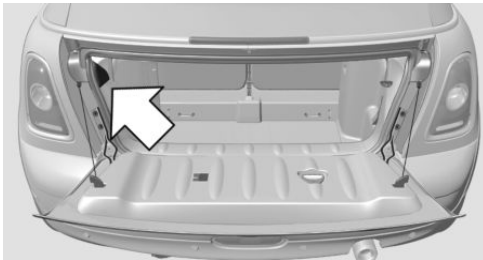

2. Pull the green knob with the gas pump symbol. This releases the fuel filler flap.

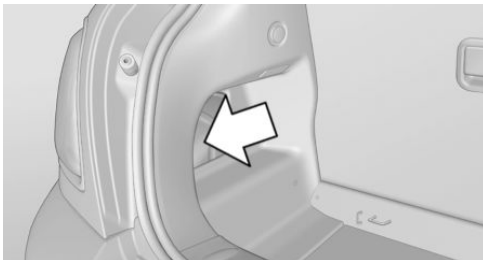

## OBSERVE THE FOLLOWING WHEN REFUELING

When refueling, insert the filler nozzle completely into the filler pipe. Lifting up the fuel pump nozzle during refueling causes:

- ▷ Premature pump shutoff.
- ▷ Reduced efficiency in the fuel-vapor recovery system.

The fuel tank is full when the filler nozzle clicks off the first time.



Do not overfill the fuel tank

Do not overfill the fuel tank; otherwise, escaping fuel may harm the environment or damage the vehicle. ◀



Handling fuels

Follow the safety instructions provided at gas stations; otherwise, there is a danger of personal injury and property damage. ◀

## FUEL TANK CAPACITY

Approx. 13.2 US gal/50 liters, including a reserve capacity of 2.1 US gal/8 liters.

# FUEL

## VEHICLE EQUIPMENT

This chapter describes all series equipment as well as country-specific and special equipment offered for this model series. Therefore, it also describes equipment that may not be found in your vehicle, for instance due to the selected special equipment or the country version. This also applies to safety-related functions and systems.

## FUEL QUALITY

### Gasoline

For the best fuel economy, the gasoline should be sulfur-free or very low in sulfur content.

Do not use fuels that are labeled at the fuel pump as containing metals.

 Only refuel with lead-free gasoline without metal additives

Do not refuel with leaded gasoline or gasoline with metal additives, e. g., manganese or iron; otherwise, the catalytic converter and other components will be permanently damaged. ◀

Fuels with a maximum ethanol content of 10 %, i.e., E10, may be used for refueling.

The ethanol should fulfill the following quality standards:

US: ASTM 4806–xx

CAN: CGSB-3.511–xx

xx: always adhere to the currently applicable standard.

 Do not refuel with ethanol E85

Do not refuel with E85, i.e., fuel with an ethanol content of 85 %, or with Flex Fuel, as this would damage the engine and fuel supply system. ◀

The engine is knock controlled. Therefore, you can refuel with different gasoline qualities.

### Recommended fuel quality

The manufacturer of your MINI recommends:

- ▷ AKI 91.
- ▷ John Cooper Works AKI 93.

### Minimum fuel grade

The manufacturer of your MINI recommends AKI 89.



Minimum fuel grade

Do not fill up with fuel below the specified minimum quality; otherwise, the engine may not run properly. ◀

If you use gasoline with this minimum AKI Rating, the engine may produce knocking sounds when starting at high outside temperatures. This has no effect on the engine life.



Minimum fuel grade

The use of poor-quality fuels may result in harmful engine deposits or damage. Additionally, problems relating to drivability, starting and stalling, especially under certain environmental conditions such as high ambient temperature and high altitude, may occur.

If drivability problems are encountered, we recommend switching to a high quality gasoline brand and a higher octane grade — AKI number — for a few tank fills. To avoid harmful engine deposits, it is highly recommended to purchase gasoline from BP or Top Tier retailers.

Failure to comply with these recommendations may result in the need for unscheduled maintenance. ◀

**MINI** recommends BP fuels 

# WHEELS AND TIRES

## VEHICLE EQUIPMENT

This chapter describes all series equipment as well as country-specific and special equipment offered for this model series. Therefore, it also describes equipment that may not be found in your vehicle, for instance due to the selected special equipment or the country version. This also applies to safety-related functions and systems.

## TIRE INFLATION PRESSURE

### Safety information

It is not merely the tires' service life, but also driving comfort and, to a great extent, driving safety that depend on the condition of the tires and the maintenance of the specified tire pressure.

### Checking the pressure



Check the tire inflation pressure regularly. Regularly check the tire inflation pressure and correct it as needed: at least twice a month and before a long trip. If you fail to observe this precaution, you may be driving on tires with incorrect tire pressures, a condition that may not only compromise your vehicle's driving stability, but also lead to tire damage and the risk of an accident.

Do not drive with depressurized or flat tires, except for run-flat tires. A flat tire will seriously impair your vehicle's handling and braking response. Attempts to drive on a flat tire can lead to a loss of control over the vehicle. ◀

Only check the tire inflation pressure when the tires are cold. This means after a maximum of 1.25 miles/2 km driving or when the vehicle has been parked for at least 2 hours. When the

tires are warm, the tire inflation pressure is higher.

After correcting the tire inflation pressure, reset the Tire Pressure Monitor, refer to page 96 or reinitialize the Flat Tire Monitor, refer to page 94.

### Checking the inflation pressure of the compact wheel

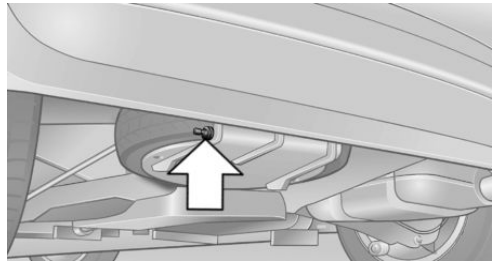

To check the inflation pressure, there is a valve extension behind the bumper.

### Pressure specifications

The tables below provide all the correct inflation pressures for the specified tire sizes at ambient temperature.

The inflation pressures apply to the tire sizes approved and tire brands recommended by the manufacturer of the MINI; a list of these is available from the service center.

For correct identification of the right tire inflation pressures, observe the following:

- ▷ Tire sizes of your vehicle
- ▷ Maximum allowable driving speed

### Tire inflation pressures for driving up to 100 mph or 160 km/h

For normal driving up to 100 mph/160 km/h, adjust pressures to the respective tire inflation pressures listed on the following pages in the

column for traveling speeds up to 100 mph/ 160 km/h to achieve optimum driving comfort. These tire inflation pressures can also be found on the driver's side door pillar when the driver's door is open.

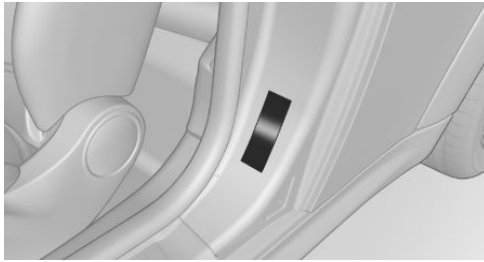

**!** Do not exceed the maximum permissible speed

The maximum permissible speed for these tire pressures is 100 mph/160 km/h. Do not exceed

this speed; otherwise, tire damage and accidents may occur. ◀

**Tire inflation pressures for driving above 100 mph or 160 km/h**

**!** Adjust the tire inflation pressures  
To drive at maximum speeds in excess of 100 mph/160 km/h, adjust pressures to the respective tire inflation pressures listed on the following pages in the column for traveling speeds including those exceeding 100 mph or 160 km/h. Otherwise, tire damage and accidents could occur. ◀

Observe all national and local maximum speed limits; otherwise, violations of the laws could occur.

**Tire inflation pressures for MINI Cooper Coupe**

Tire size	Pressure specifications in bar/PSI	
All pressure specifications in the table are indicated in bar/PSI with cold tires.		
Cold = ambient temperature		
175/65 R 15 84 T M+S Std	2.4/35	2.4/35
175/65 R 15 84 H Std		
175/65 R 15 84 H M+S A/S Std		
195/55 R 16 87 H RSC		
195/55 R 16 87 H M+S RSC		
195/55 R 16 87 V M+S A/S RSC		
205/45 R 17 84 V RSC		
205/45 R 17 84 V M+S RSC		
205/45 R 17 84 V M+S A/S RSC		
205/40 R 18 82 W RSC		
175/60 R 16 82 H M+S RSC	2.6/38	2.6/38

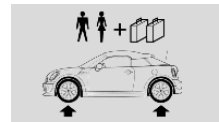

Tire size	Pressure specifications in bar/PSI
-----------	------------------------------------

Compact wheel: T 115/70 R 15 90 M    Traveling speed up to 50 mph/80 km/h  
4.2/60

More details on the permissible load and weights, refer to page [271](#).

### Tire inflation pressures for MINI Cooper S Coupe

Tire size	Pressure specifications in bar/PSI
-----------	------------------------------------

All pressure specifications in the table are indicated in bar/PSI with cold tires.

Cold = ambient temperature

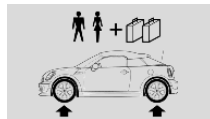

195/55 R 16 87 V RSC	2.6/38	2.6/38
195/55 R 16 87 H M+S RSC		
195/55 R 16 87 V M+S A/S RSC		
195/55 R 16 87 V M+S RSC		
205/45 R 17 84 V M+S RSC	2.8/41	2.8/41
205/45 R 17 84 V M+S A/S RSC		
205/45 R 17 84 V RSC		
205/40 R 18 82 W RSC		
175/60 R 16 82 H M+S RSC		

More details on the permissible load and weights, refer to page [271](#).

### Tire inflation pressures for MINI John Cooper Works Coupe

Tire size	Pressure specifications in bar/PSI
-----------	------------------------------------

All pressure specifications in the table are indicated in bar/PSI with cold tires.

Cold = ambient temperature

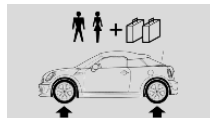

185/50 R 17 86 H M+S XL RSC	2.7/39	2.7/39
205/45 R 17 84 V M+S RSC		
205/45 R 17 84 W RSC		
205/40 R 18 82 W RSC	2.9/42	2.9/42

More details on the permissible load and weights, refer to page [271](#).

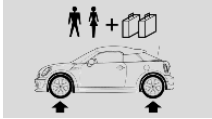

## Tire inflation pressures for MINI Cooper Roadster

Tire size	Pressure specifications in bar/PSI	
All pressure specifications in the table are indicated in bar/PSI with cold tires. Cold = ambient temperature		
175/65 R 15 84 T M+S	2.4/35	2.4/35
175/65 R 15 84 H		
175/65 R 15 84 H M+S A/S		
195/55 R 16 87 H RSC		
195/55 R 16 87 H M+S RSC		
195/55 R 16 87 V M+S A/S RSC		
205/45 R 17 84 V RSC		
205/45 R 17 84 V M+S RSC		
205/45 R 17 84 V M+S A/S RSC		
205/40 R 18 82 W RSC		
175/60 R 16 82 H M+S RSC	2.6/38	2.6/38
Compact wheel: T 115/70 R 15 90 M	Traveling speed up to 50 mph/80 km/h 4.2/60	

More details on the permissible load and weights, refer to page [271](#).

## Tire inflation pressures for MINI Cooper S Roadster

Tire size	Pressure specifications in bar/PSI	
All pressure specifications in the table are indicated in bar/PSI with cold tires. Cold = ambient temperature		
195/55 R 16 87 V RSC	2.6/38	2.6/38
195/55 R 16 87 H M+S RSC		
195/55 R 16 87 V M+S RSC		
195/55 R 16 87 V M+S A/S RSC		

Tire size	Pressure specifications in bar/PSI	
205/45 R 17 84 V M+S RSC	2.8/41	2.8/41
205/45 R 17 84 V M+S A/S RSC		
205/45 R 17 84 V RSC		
205/40 R 18 82 W RSC		
175/60 R 16 82 H M+S RSC		



More details on the permissible load and weights, refer to page [271](#).

### Tire inflation pressures for MINI John Cooper Works Roadster

Tire size	Pressure specifications in bar/PSI	
All pressure specifications in the table are indicated in bar/PSI with cold tires. Cold = ambient temperature		
185/50 R 17 86 H M+S XL RSC	2.7/39	2.7/39
205/45 R 17 84 W RSC		
205/45 R 17 84 V M+S RSC		
205/40 R 18 82 W RSC	2.9/42	2.9/42

More details on the permissible load and weights, refer to page [271](#).



### Tire inflation pressures for MINI Cooper Convertible

Tire size	Pressure specifications in bar/PSI	
	Traveling speeds of up to 100 mph/160 km/h	Traveling speeds above 100 mph/160 km/h
All pressure specifications in the table are indicated in bar/PSI with cold tires. Cold = ambient temperature	 	

Tire size	Pressure specifications in bar/PSI			
175/65 R 15 84 T M+S Std	2.4/35	2.4/35	2.6/38	2.6/38
175/65 R 15 84 H Std				
175/65 R 15 84 H M+S A/S Std				
175/60 R 16 82 H M+S RSC				
195/55 R 16 87 H RSC				
195/55 R 16 87 H M+S RSC				
195/55 R 16 87 V M+S A/S RSC				
205/45 R 17 84 V RSC				
205/45 R 17 84 V M+S RSC				
205/45 R 17 84 V M+S A/S RSC				
205/40 R 18 82 W RSC				

More details on the permissible load and weights, refer to page [272](#).

### Tire inflation pressures for MINI Cooper S Convertible

Tire size	Pressure specifications in bar/PSI			
	Traveling speeds of up to 100 mph/160 km/h		Traveling speeds above 100 mph/160 km/h	
All pressure specifications in the table are indicated in bar/PSI with cold tires. Cold = ambient temperature				
	195/55 R 16 87 V RSC	2.4/35	2.4/35	2.6/38
195/55 R 16 87 H M+S RSC				
195/55 R 16 87 V M+S A/S RSC				
195/55 R 16 87 V M+S RSC				
205/45 R 17 84 V M+S RSC	2.7/39	2.7/39	2.9/42	2.9/42
205/45 R 17 84 V M+S A/S RSC				
205/45 R 17 84 V RSC				
205/40 R 18 82 W RSC				
175/60 R 16 82 H M+S RSC				

More details on the permissible load and weights, refer to page [272](#).

## Tire inflation pressures for MINI John Cooper Works Convertible

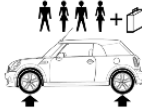
Tire size	Pressure specifications in bar/PSI			
	Traveling speeds of up to 100 mph/160 km/h		Traveling speeds above 100 mph/160 km/h	
All pressure specifications in the table are indicated in bar/PSI with cold tires. Cold = ambient temperature				
185/50 R 17 86 H M+S XL RSC	2.7/39	2.7/39	2.9/42	2.9/42
205/45 R 17 84 V M+S RSC				
205/45 R 17 84 W RSC				
205/40 R 18 82 W RSC	2.9/42	2.9/42	3.1/45	3.1/45

More details on the permissible load and weights, refer to page [272](#).

## TIRE IDENTIFICATION MARKS

Knowledge of the labeling on the side of the tire makes it easier to identify and choose the right tires.

### Tire size

Example: 225/45 R 17 91 V

225: nominal width in mm

45: aspect ratio in %

R: radial tire code

17: rim diameter in inches

91: load rating, not for ZR tires

### Speed letter

Q = up to 100 mph/160 km/h

T = up to 118 mph/190 km/h

H = up to 131 mph/210 km/h

V = up to 150 mph/240 km/h

W = up to 167 mph/270 km/h

Y = up to 186 mph/300 km/h

### Tire Identification Number

Tires with DOT codes meet the guidelines of the U.S. Department of Transportation.

DOT code:

DOT xxxx xxx 1012

xxxx: manufacturer code for the tire brand

xxx: tire size and tire design

1012: tire age

### Uniform Tire Quality Grading

Quality grades can be found where applicable on the tire sidewall between tread shoulder and maximum section width. For example:

Treadwear 200 Traction AA

Temperature A

### DOT Quality Grades

Treadwear

Traction AA A B C

Temperature A B C



Conform to Federal Safety Requirements  
All passenger car tires must conform to Federal Safety Requirements in addition to these grades. ◀

### Treadwear

The treadwear grade is a comparative rating based on the wear rate of the tire when tested under controlled conditions on a specified government test course. For example, a tire graded 150 would wear one and one-half (1 1/2) times as well on the government course as a tire graded 100. The relative performance of tires depends upon the actual conditions of their use, however, and may depart significantly from the norm due to variations in driving habits, service practices and differences in road characteristics and climate.

### Traction

The traction grades, from highest to lowest, are AA, A, B, and C.

Those grades represent the tire's ability to stop on wet pavement as measured under controlled conditions on specified government test surfaces of asphalt and concrete. A tire marked C may have poor traction performance.

The traction grade assigned to this tire is based on straight-ahead braking traction tests, and does not include acceleration, cornering, hydroplaning, or peak traction characteristics.

### Temperature

The temperature grades are A, the highest, B, and C, representing the tire's resistance to the generation of heat and its ability to dissipate heat when tested under controlled conditions on a specified indoor laboratory test wheel. Sustained high temperature can cause the material of the tire to degenerate and reduce tire life, and excessive temperature can lead to sudden tire failure. The grade C corresponds to a level of performance which all passenger car tires must meet under the Federal Motor Vehi-

cle Safety Standard No. 109. Grades B and A represent higher levels of performance on the laboratory test wheel than the minimum required by law.



Temperature grade for this tire  
The temperature grade for this tire is established for a tire that is properly inflated and not overloaded. Excessive speed, underinflation, or excessive loading, either separately or in combination, can cause heat buildup and possible tire failure. ◀

### RSC – Run-flat tires

The symbol identifying run-flat tires is a circle with the letters RSC on the sidewall, refer to page 232.

### M+S

Winter and all-season tires.

These have better winter properties than summer tires.

### XL

Designation for specially reinforced tires.

## TIRE TREAD

### Summer tires

The tread depth should not be less than 0.12 in/3 mm, although European legislation, for example, requires a minimum tread depth of only 0.063 in/1.6 mm. At tread depths less than 0.12 in/3 mm, there is a great danger of hydroplaning even in low water depths and at raised speeds.

### Winter tires

The suitability of winter tires for winter driving is reduced noticeably when their tread depth becomes less than 0.16 in/4 mm.

## Minimum tread depth



Wear indicators in the tread base are distributed around the circumference of the tire and are marked on the tire sidewall with TWI, Tread Wear Indicator. When the tire tread has been worn down to the wear indicators, a tread has reached a depth of 0.063 in/1.6 mm.

## TIRE DAMAGE

### General information

Inspect your tires often for damage, foreign objects lodged in the tread, and tread wear.

### Notes

Driving over rough or damaged road surfaces, as well as debris, curbs and other obstacles can cause serious damage to wheels, tires and suspension parts. This is more likely to occur with low-profile tires, which provide less cushioning between the wheel and the road. Be careful to avoid road hazards and reduce your speed, especially if your vehicle is equipped with low-profile tires.

Indications of tire damage or other vehicle defects:

- ▷ Unusual vibrations during driving.
- ▷ Unusual handling such as a strong tendency to pull to the left or right.

Damage can be caused by driving over curbs, road damage and similar situations.



In case of tire damage

If there are indications of tire damage, reduce your speed immediately and have the wheels and tires checked right away; otherwise, there is the increased risk of an accident.

Drive carefully to the next service center or tire shop.

If necessary, have the vehicle towed.

Otherwise, tire damage can present a life-threatening hazard to vehicle occupants and other road users. ◀



Repair of tire damage

For safety reasons, the manufacturer of your vehicle recommends that you do not have damaged tires repaired; they should be replaced. Otherwise, damage can occur as a result. ◀

## TIRE AGE

### Recommendation

For several reasons, among other things because of beginning brittleness, the manufacturer of your MINI recommends mounting new tires at the latest after six years, regardless of the actual wear.

### Manufacture date

The date of manufacture of the tires is specified in the tire label:

DOT ... 1012: the tire was manufactured in week 10 of 2012.

## CHANGING WHEELS AND TIRES

### Mounting

 Information on mounting tires  
Have mounting and balancing performed only by a service center or tire specialist.

If this work is not carried out properly, there is the danger of subsequent damage and related safety hazards. ◀

### Wheel and tire combination

Information on the right wheel and tire combination and rim version for your vehicle can be obtained from the service center.

Incorrect wheel and tire combinations impair the function of a variety of systems such as ABS or DSC.

To maintain good handling and vehicle response, use only tires with a single tread configuration from a single manufacturer.

Following tire damage, have the original wheel and tire combination remounted on the vehicle as soon as possible.

 Approved wheels and tires  
The manufacturer of your vehicle recommends that you use only wheels and tires that have been approved for your particular vehicle model.

For example, despite having the same official size ratings, variations can lead to body contact and with it, the risk of severe accidents.

The manufacturer of your vehicle cannot evaluate non-approved wheels and tires to determine if they are suited for use, and therefore cannot ensure the operating safety of the vehicle if they are mounted. ◀

### Wheels with electronics for TPM Tire Pressure Monitor

When mounting new tires or changing from summer to winter tires or vice versa, only use wheels with TPM electronics; otherwise, the Tire Pressure Monitor will not be able to detect a flat tire, refer to page 95. Your service center will be glad to advise you.

### Recommended tire brands



For each tire size, the manufacturer of your vehicle recommends certain tire brands. These are indicated by the clearly visible marking on the tire sidewall.

With proper use, these tires meet the highest standards for safety and handling.

### Retreaded tires

The manufacturer of your vehicle does not recommend the use of retreaded tires.

 Retreaded tires  
Possibly substantial variations in the design and age of the tire casing structures can limit service life and have a negative impact on road safety. ◀

### Winter tires

The manufacturer of your vehicle recommends winter tires for winter roads or at temperatures below +45 °F/+7 °C.

Although so-called all-season M+S tires do provide better winter traction than summer tires, they do not provide the same level of performance as winter tires.

### Maximum speed of winter tires

If the maximum speed of the vehicle is higher than the permissible speed for the winter tires, then display a corresponding sign in the field of vision. You can obtain this sign from the tire specialist or from your service center.

 Maximum speed for winter tires  
Do not exceed the maximum speed for the winter tires; otherwise, tire damage and accidents can occur. ◀

### Run-flat tires

When mounting new tires or changing from summer to winter tires or vice versa, use run-flat tires for your own safety. Also, a compact wheel is not available in case of a flat tire. Your service center will be glad to advise you.

### Rotating wheels between axles

Different wear patterns occur on the front and rear axles, depending on the individual conditions of use.

To ensure even wear on the tires, the wheels can be rotated between the axles. Your service center will be glad to advise you.

After changing the tires, check the tire inflation pressure and correct it if necessary.

### Storage

Store wheels and tires in a cool, dry place with as little exposure to light as possible.

Always protect tires against all contact with oil, grease and fuels.

Do not exceed the maximum tire inflation pressure indicated on the side wall of the tire.

## RUN-FLAT TIRES

### Label



The symbol identifying run-flat tires is a circle with the letters RSC on the sidewall.

Run-flat tires are tires with special rims that support themselves for a limited period of time. The sidewall reinforcement ensures that the tire can continue to be used to a limited extent if it has lost pressure and even if it has become completely depressurized.

For continued driving in the event of a flat tire, refer to page 94.

## CORRECTING A FLAT TIRE

 Safety measures in case of a breakdown

- ▶ Park the vehicle as far as possible from passing traffic and on solid ground. Switch on the hazard warning system.
- ▶ Let the steering wheel lock engage with the wheels in the straight-ahead position, set the handbrake, and engage first gear or reverse, or engage selector lever position P.
- ▶ Have all vehicle occupants get out of the vehicle and ensure that they remain outside the immediate area in a safe place, such as behind a guardrail.



- ▷ If a warning triangle or portable hazard warning lamp is required, set it up on the roadside at an appropriate distance from the rear of the vehicle. Comply with all safety guidelines and regulations. ◀

The procedure to correct a flat tire depends on the equipment in the vehicle:

- ▷ Run-flat tires, refer to page 232.
- ▷ MINI Mobility System, refer to page 233.
- ▷ Wheel change with a compact wheel, refer to page 249.

## MINI MOBILITY SYSTEM

### Notes

- ▷ Follow the instructions on using the Mobility System found on the compressor and sealant bottle.
- ▷ Use of the Mobility System may be ineffective if tire damage is greater than approx. 1/8 in/4 mm in size.
- ▷ Contact the nearest service center if the tire cannot be made drivable.
- ▷ If possible, do not remove foreign bodies that have penetrated the tire.
- ▷ Pull the speed limit sticker off the sealant bottle and apply it to the steering wheel.

### Sealant and compressor



- 1 Sealant bottle and speed limit sticker
- 2 Filling hose  
Note the use-by date on the sealant bottle.

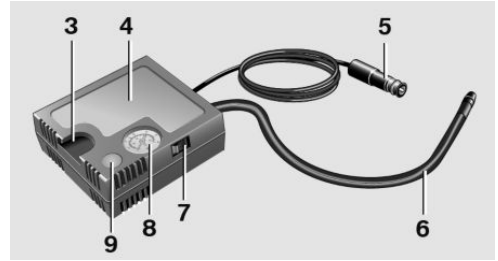

- 3 Holder for the sealant bottle
- 4 Compressor
- 5 Connector and cable for the lighter socket/ socket in passenger compartment 114.
- 6 Connection hose for connecting the compressor and sealant bottle or the compressor and wheel
- 7 On/off switch
- 8 Pressure gauge for displaying the tire inflation pressure
- 9 Release button for reducing the tire inflation pressure

The connector, cable, and connecting hose are stowed in the compressor housing.

### Using the Mobility System

To repair a flat tire with the Mobility System, proceed as follows:

- ▷ Filling the tire with sealant
- ▷ Distributing the sealant
- ▷ Correcting the tire inflation pressure

### Filling the tire with sealant

- ⚠ Adhere to the specified sequence
- Adhere to the specified sequence of the steps; otherwise, sealant may escape under high pressure. ◀

1. Shake the sealant bottle.
2. Pull the connection hose 6 fully out of the compressor housing and screw it onto the sealant bottle connection. Ensure that the connection hose is not kinked.

3. Insert the sealant bottle into the compressor housing in a vertical position.
4. Unscrew the dust cap off of the valve of the defective wheel and screw the filling hose 2 of the sealant bottle onto the valve.

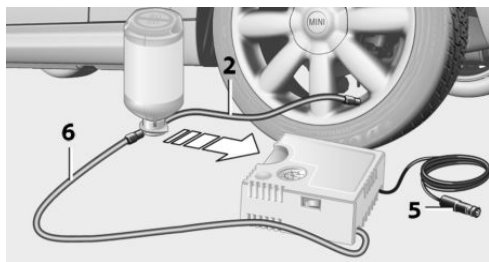

5. Ensure that the compressor is switched off.
6. Insert connector 5 into the lighter socket/ socket in the passenger compartment, refer to page 114.
7. When the engine is running:

Switch on the compressor and let it run for approx. 3 to 8 minutes to fill sealant into the tire and achieve a tire inflation pressure of approx. 1.8 bar/26 psi.

While sealant is being filled, the inflation pressure may intermittently rise to approx. 5 bar/73 psi. Do not switch off the compressor in this phase.

8. Switch off the compressor.



Do not allow the compressor to run too long

Do not allow the compressor to run longer than 10 minutes; otherwise, the device will overheat and may be damaged. ◀

If an air pressure of 1.8 bar/26 psi is not reached:

1. Unscrew the filling hose 2 from the wheel and drive forward and back approx. 33 ft/10 m to evenly distribute the sealant in the tire.
2. Inflate the tire again using the compressor.

If the inflation pressure of 1.8 bar/26 psi is still not reached, the tire is too heavily damaged. Contact the nearest service center.

### Stowing the Mobility System

1. Unscrew the filling hose 2 of the sealant bottle from the wheel.
2. Unscrew the compressor connection hose 6 from the sealant bottle.
3. Connect the filling hose 2 of the sealant bottle with the free connector on the sealant bottle.

This prevents left-over sealant from escaping from the bottle.

4. Wrap the empty sealant bottle in suitable material to avoid dirtying the cargo area.
5. Stow the Mobility System back in the vehicle.

### Distributing the sealant

Drive approx. 3.1 miles/5 km to evenly distribute the sealant.

Do not exceed a speed of 50 mph/80 km/h. If possible, do not drop below a speed of 10 mph/20 km/h.

### Correcting the tire inflation pressure

1. After driving approx. 3.1 miles/5 km, or about 10 minutes, stop in a suitable location.
2. Screw the connection hose 6 of the compressor directly onto the tire valve.
3. Insert the connector 5 into the power socket in the passenger compartment.
4. Correct the tire inflation pressure to 1.8 bar/26 psi. When the engine is running:
  - ▷ To increase the inflation pressure: switch on the compressor. To check the currently set inflation pressure, switch off the compressor.
  - ▷ To reduce the inflation pressure: press the release button 9.



Do not allow the compressor to run too long

Do not allow the compressor to run longer than 10 minutes; otherwise, the device will overheat and may be damaged. ◀

If the inflation pressure is not maintained, take the vehicle on another drive, distributing the sealant, refer to page 234. Then repeat steps 1 to 4 once.

If the inflation pressure of 1.8 bar/26 psi is still not reached, the tire is too heavily damaged. Contact the nearest service center.

### Continuing the trip



Note the maximum speed

Do not exceed the maximum speed of 50 mph/80 km/h; otherwise, accidents can occur. ◀

Replace the defective tire as soon as possible and have the wheel balanced.

Have the Mobility System refilled.

## SNOW CHAINS

Only certain fine-link snow chains have been tested by MINI, classified as safe for use, and recommended. Consult your service center for more information.

Use only in pairs on the front wheels, equipped with tires of the following size:

- ▶ 175/65 R 15 M+S
- ▶ 175/60 R 16 M+S

John Cooper Works:

- ▶ 185/50 R 17 86 H M+S XL RSC

Observe the manufacturer's instructions when mounting snow chains. Do not exceed a speed of 30 mph or 50 km/h when using snow chains.

Do not initialize the Flat Tire Monitor if snow chains are mounted; otherwise, the instrument might issue an incorrect reading. When driving with snow chains, it may be useful to tempora-

rily deactivate DSC or activate DTC, refer to page 101.

# ENGINE COMPARTMENT

## VEHICLE EQUIPMENT

This chapter describes all series equipment as well as country-specific and special equipment offered for this model series. Therefore, it also

describes equipment that may not be found in your vehicle, for instance due to the selected special equipment or the country version. This also applies to safety-related functions and systems.

## IMPORTANT FEATURES IN THE ENGINE COMPARTMENT

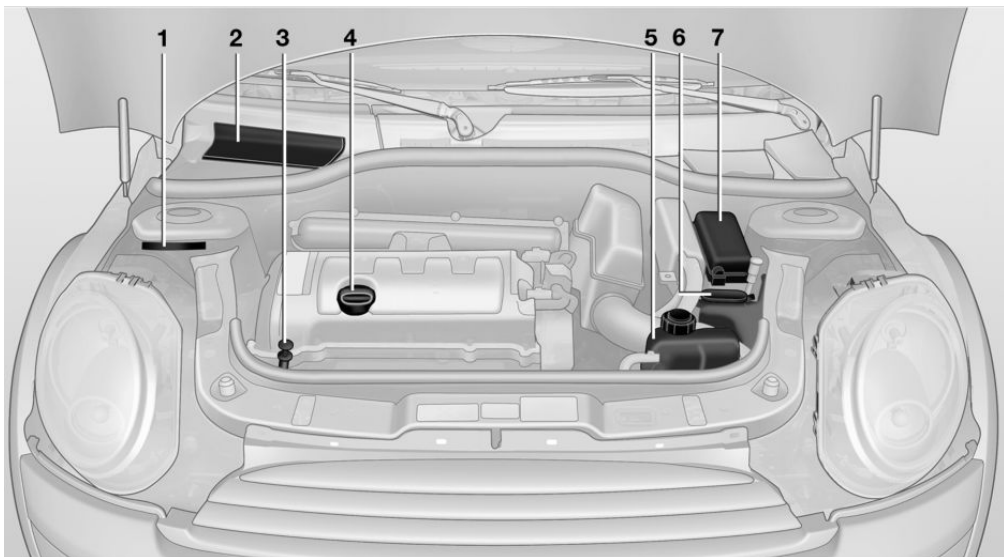

- |                                                                                                                                                                                                                                                         |                                                                                                                                                                                                                                                              |
|---------------------------------------------------------------------------------------------------------------------------------------------------------------------------------------------------------------------------------------------------------|--------------------------------------------------------------------------------------------------------------------------------------------------------------------------------------------------------------------------------------------------------------|
| <ul style="list-style-type: none"> <li>1 Vehicle identification number</li> <li>2 Battery, under the cover <a href="#">252</a></li> <li>3 Dip stick for engine oil <a href="#">238</a></li> <li>4 Engine oil filler neck <a href="#">238</a></li> </ul> | <ul style="list-style-type: none"> <li>5 Coolant expansion tank <a href="#">240</a></li> <li>6 Reservoir for washer fluid for the headlamp and window washer system <a href="#">69</a></li> <li>7 Engine compartment fuse box <a href="#">253</a></li> </ul> |
|---------------------------------------------------------------------------------------------------------------------------------------------------------------------------------------------------------------------------------------------------------|--------------------------------------------------------------------------------------------------------------------------------------------------------------------------------------------------------------------------------------------------------------|

## HOOD

### Notes

 Working in the engine compartment  
Never attempt to perform any service or repair operations on your vehicle without the necessary professional technical training.

If you are unfamiliar with the statutory guidelines, have any work on the vehicle performed only by a service center.

If this work is not carried out properly, there is the danger of subsequent damage and related safety hazards. ◀

**!** To avoid damage, make sure that the wiper arms are resting against the windshield before you open the engine compartment. Do not open the engine hood before the engine has cooled down; otherwise, injuries may result. ◀

### Unlocking and opening the hood

1. Pull the lever.

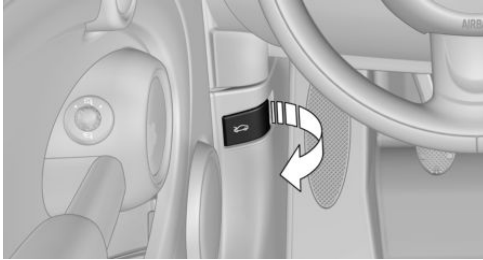

2. Lift the hood all the way.
3. Press the release handle and open the hood.

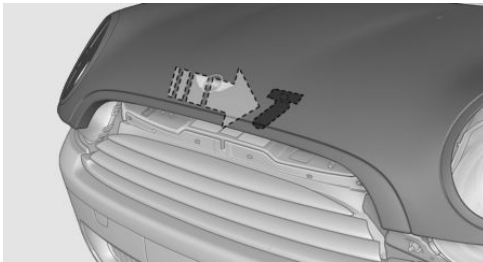

**!** Danger of injury when the hood is open  
There is a danger of injury from protruding parts when the hood is open. ◀

### Closing the hood

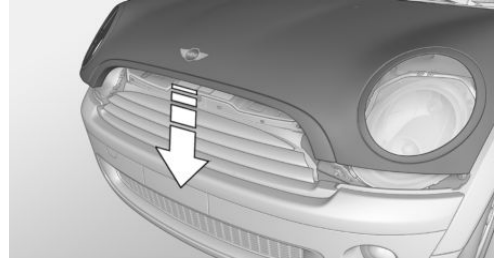

Close the hood from a height of approx. 16 in/40 cm with momentum. It must be clearly heard to engage.

**!** Hood open when driving  
If you see any signs that the hood is not completely closed while driving, pull over immediately and close it securely. ◀

**!** Danger of pinching  
Make sure that the closing path of the hood is clear; otherwise, injuries may result. ◀

# ENGINE OIL

## VEHICLE EQUIPMENT

This chapter describes all series equipment as well as country-specific and special equipment offered for this model series. Therefore, it also describes equipment that may not be found in your vehicle, for instance due to the selected special equipment or the country version. This also applies to safety-related functions and systems.

## ENGINE OIL

### General information

Engine oil consumption depends on the driving style and the conditions of use. A highly sporty driving style, for example, results in considerably higher engine oil consumption.

Therefore, regularly check the engine oil level after refueling.

### Checking the oil level with a dip stick

1. Park the vehicle on level ground when the engine is at operating temperature, i.e., after driving continuously for at least 6.2 miles/10 km.
2. Switch the engine off.
3. After approx. 5 minutes, pull out the dip stick and wipe it off with a lint-free cloth, paper towel, etc.
4. Carefully insert the dip stick all the way into the measuring tube and pull it out again.

The oil level must be between the two marks on the dip stick.

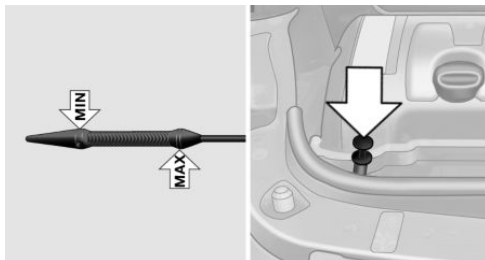

The oil quantity between the two marks on the dip stick equals approx. 1 US quart/1 liter.



Do not exceed the high mark.

Do not exceed the high mark of the dip stick. Overfilling oil damages the engine. ◀

### Adding engine oil

#### Filler neck

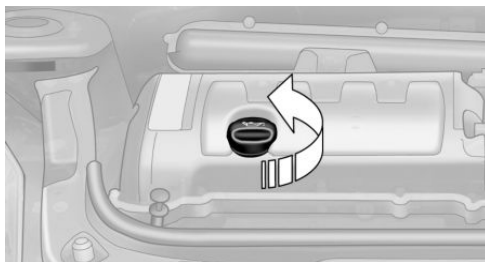

Add a maximum quantity of 1 US quart/1 liter of oil only after the corresponding message appears on the Control Display or, in diesel engines, after the oil level is just above the low mark of the dip stick, refer to page 238.



Add oil promptly

Add oil within the next 30 miles/50 km; otherwise, engine damage could result. ◀

**Too much engine oil**

Have the vehicle checked immediately; otherwise, surplus oil can lead to engine damage. ◀

**Protect children**

Keep oil, grease, etc., out of reach of children and heed the warnings on the containers to prevent health risks. ◀

## Oil types for refilling

### Notes

**No oil additives**

Do not use oil additives as these may cause engine damage. ◀

**Viscosity classes of engine oils**

When selecting an engine oil, ensure that the engine oil belongs to one of the SAE viscosity classes 0W-40, 0W-30, 5W-40, or 5W-30, or malfunctions or engine damage may occur. ◀

The engine oil quality is critical for the life of the engine.

Due to national regulations, some oil types are not available in every country.

## Approved oil types

Gasoline engine

BMW High Performance SAE 5W-30

BMW Longlife-01

BMW Longlife-01 FE

Further information on approved oil types can be obtained from the service center.

## Alternative oil types

If the approved engine oils are not available, up to 1 US quart/1 liter of an oil with the following specification can be used:

Gasoline engine

API SM or a higher quality standard

## Oil change

An oil change should be carried out by the service center only.

MINI RECOMMENDS



# COOLANT

## VEHICLE EQUIPMENT

This chapter describes all series equipment as well as country-specific and special equipment offered for this model series. Therefore, it also describes equipment that may not be found in your vehicle, for instance due to the selected special equipment or the country version. This also applies to safety-related functions and systems.

## GENERAL INFORMATION



**Danger of burns from hot engine**

Do not open the cooling system while the engine is hot; otherwise, escaping coolant may cause burns. ◀



**Suitable additives**

Only use suitable additives; otherwise, engine damage may occur. The additives are harmful to your health. ◀

Coolant consists of water and additives.

Not all commercially available additives are suitable for your MINI vehicle. Ask your service center for suitable additives.

## COOLANT TEMPERATURE

If the coolant and therefore the engine overheats, a warning lamp lights up. A message appears on the Control Display.

## COOLANT LEVEL

### Checking

1. Do not open the hood until the engine has cooled down.

2. Turn the expansion tank cap counterclockwise slightly to allow any accumulated pressure to escape; then continue turning to open.
3. The coolant level is correct if it is between the markings. The markings are located on the side of the coolant reservoir.

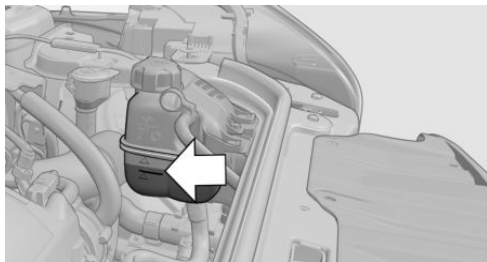

### Refilling

1. Do not open the hood until the engine has cooled down.
2. Turn the expansion tank cap counterclockwise slightly to allow any accumulated pressure to escape, then continue turning to open.
3. If the coolant level is low, slowly add coolant up to the specified level; do not overfill.
4. Twist the cap closed.
5. Have the cause of the coolant loss eliminated as soon as possible.

### Disposal



Comply with the appropriate environmental protection regulations when disposing of coolant additives.



# MAINTENANCE

## VEHICLE EQUIPMENT

This chapter describes all series equipment as well as country-specific and special equipment offered for this model series. Therefore, it also describes equipment that may not be found in your vehicle, for instance due to the selected special equipment or the country version. This also applies to safety-related functions and systems.

## MINI MAINTENANCE SYSTEM

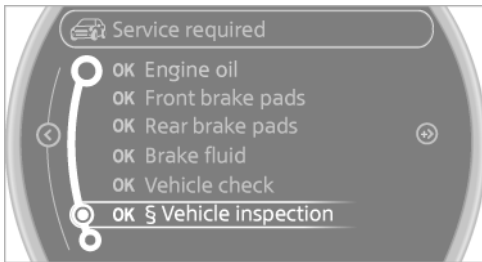

The MINI maintenance system provides information on required maintenance measures and thus provides support in maintaining road safety and the operational reliability of the vehicle.

## CONDITION BASED SERVICE CBS

Sensors and special algorithms take into account the various driving conditions of your MINI. Based on this, Condition Based Service determines the current and future maintenance requirements.

The system makes it possible to adapt the amount of maintenance you need to your user profile.

Detailed information on service requirements can be displayed on the Control Display, refer to page 81.

### Service data in the remote control

Information on the required maintenance is continuously stored in the remote control. Your service center will read out this data and suggest the right array of service procedures for your vehicle. Therefore, hand your service specialist the remote control that you used most recently.



Setting the correct date

Make sure the date is set correctly; otherwise, the effectiveness of CBS Condition Based Service is not ensured. ◀

## SERVICE AND WARRANTY INFORMATION BOOKLET FOR US MODELS AND WARRANTY AND SERVICE GUIDE BOOKLET FOR CANADIAN MODELS

Please consult your Service and Warranty Information Booklet for US models and Warranty and Service Guide Booklet for Canadian models for additional information on service requirements.

Maintenance and repair should be performed by your service center. Make sure to have regular maintenance procedures recorded in the vehicle's Service and Warranty Information Booklet for US models, and in the Warranty and Service Guide Booklet for Canadian models. These entries are proof of regular maintenance.

## SOCKET FOR OBD ONBOARD DIAGNOSIS

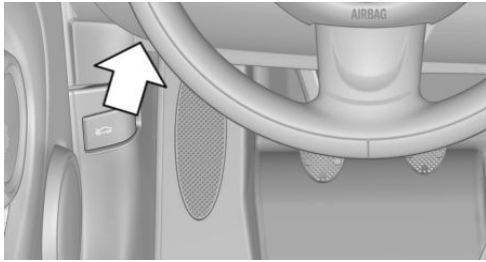

Primary components in the vehicle emissions can be checked via the OBD socket using a device.

### Emissions



The warning lamps light up. The vehicle is producing higher emissions. You can continue your journey, but moderate your speed and exercise due caution. Have the vehicle checked as soon as possible.

Under certain circumstances, one of the lamps flashes or lights up continuously. This indicates that there is excessive misfiring or a malfunction in the engine. If this happens, reduce the vehicle speed and drive to the next service center promptly. Serious engine misfiring within a brief period can seriously damage emission control components, in particular the catalytic converter. In addition, the mechanical engine components may become damaged.



If the fuel filler cap is not properly tightened, the OBD system may conclude that fuel vapor is escaping; this will cause a display to light up. If the filler cap is then tightened, the display should go out in a few days.

# REPLACING COMPONENTS

## VEHICLE EQUIPMENT

This chapter describes all series equipment as well as country-specific and special equipment offered for this model series. Therefore, it also describes equipment that may not be found in your vehicle, for instance due to the selected special equipment or the country version. This also applies to safety-related functions and systems.

## TOOL KIT

Depending on the vehicle equipment, your vehicle contains a special onboard vehicle tool kit that is stowed under the flat loading floor in the cargo area.

### With Mobility System

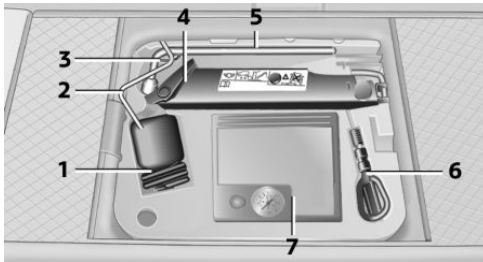

- 1 Sealant bottle
- 2 Hex key
- 3 Pulling hook
- 4 Vehicle jack
- 5 Lug bolts wrench
- 6 Screwdriver/cross-head, tow fitting
- 7 Compressor

### With run-flat tires or compact wheel

The onboard vehicle tool kit contains a pouch holding a plastic bag in which you can stow the defective wheel.

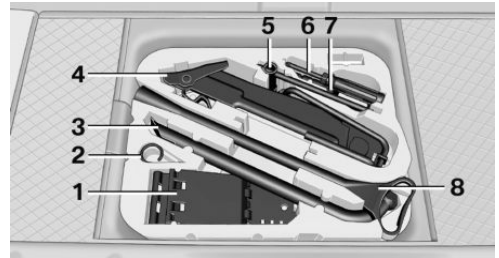

- 1 Folding wheel chock and cover for the defective wheel
- 2 Pulling hook
- 3 Lug bolts wrench
- 4 Vehicle jack
- 5 Special wrench for releasing the compact wheel
- 6 Screwdriver/cross-head
- 7 Tow fitting
- 8 Lifting handle

## WIPER BLADE REPLACEMENT

### General information



Do not fold down the wipers without wiper blades

Do not fold down the wipers if wiper blades have not been installed; this may damage the windshield. ◀

## MINI Coupe, MINI Roadster: replacing the wiper blades

1. Fold up and hold the wiper arm.
2. Squeeze the locking spring, arrows 1, and fold out the wiper blade, arrow 2.



3. Take the wiper blade out of the catch mechanism toward the front.
4. Press the new wiper blade into the fixation until it engages audibly.
5. Fold down the wiper arm.

 **Risk of damage**  
Before opening the hood, ensure that the wiper arms with wiper blades are folded onto the window; otherwise, damage may occur. ◀

## MINI Convertible: replacing the wiper blades

1. Fold up and hold the wiper arm.
2. Squeeze the locking spring, arrows 1.

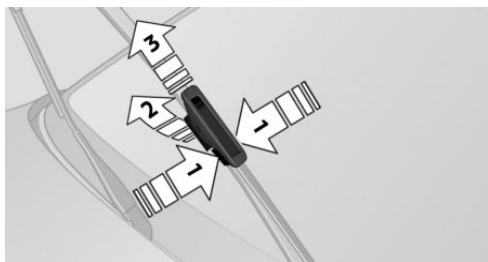

3. While squeezing the locking spring, pull the wiper blade off of the wiper arm, arrow 2.

4. Slide the new wiper blade onto the wiper arm until it engages audibly.
5. Fold down the wiper arm.

 **Risk of damage**  
Before opening the hood, ensure that the wiper arms with wiper blades are folded onto the window; otherwise, damage may occur. ◀

## LAMP AND BULB REPLACEMENT

### Notes

#### Lamps and bulbs

Lamps and bulbs make an essential contribution to vehicle safety. Therefore, exercise caution when handling lamps and bulbs.

The manufacturer of the vehicle recommends that you entrust corresponding procedures to the service center if you are unfamiliar with them or they are not described here.

You can obtain a selection of replacement bulbs at the service center.

 **Danger of burns**  
Only change bulbs when they are cool; otherwise, there is the danger of getting burned. ◀

 **Working on the lighting system**  
When working on the lighting system, you should always switch off the lights affected to prevent short circuits.

To avoid possible injury or equipment damage when replacing bulbs, observe any instructions provided by the bulb manufacturer. ◀

 **Do not touch the bulbs**  
Do not touch the glass of new bulbs with your bare hands, as even minute amounts of contamination will burn into the bulb's surface and reduce its service life.

Use a clean tissue, cloth or something similar, or hold the bulb by its base. ◀

Caring for the headlamps, refer to page 260.

For bulb replacement that is not described here, please contact the service center or a workshop that works according to the repair procedures of the manufacturer with correspondingly trained personnel.

For checking and adjusting headlamp aim, please contact your MINI dealer.

### Light-emitting diodes LEDs

Light-emitting diodes installed behind translucent lenses serve as the light source for many of the controls and displays in the vehicle.

These light-emitting diodes, which operate using a concept similar to that applied in conventional lasers, are officially designated as Class 1 light-emitting diodes.

 Do not remove the covers  
Do not remove the covers, and never stare into the unfiltered light for several hours; otherwise, irritation of the retina could result. ◀

### Headlamp glass

Condensation can form on the inside of the headlamps in cool or humid weather. When the light is switched on, the condensation evaporates after a short time. The headlamps do not need to be changed.

If the condensation in the headlamps does not evaporate after trips with the lights switched on, and the amount of moisture in the headlamps increases, for example if water droplets form, have them checked by your service center.

### Bi-xenon headlamps

These bulbs have a very long life and the likelihood of failure is very low, provided that they are not switched on and off excessively. If a bulb should nevertheless fail, you can continue

driving cautiously with the front fog lamps, provided this is permitted by local laws.

 Do not perform work/bulb replacement on xenon headlamps

Have any work on the xenon lighting system, including bulb replacement, performed only by a service center.

Due to the high voltage present in the system, there is the danger of fatal injuries if work is carried out improperly. ◀

### Front lamps, bulb replacement

#### Halogen low beams and high beams

Bulb H13, 60/55 watt

 Wear protective goggles and gloves  
Halogen bulbs are pressurized. Therefore, wear protective goggles and gloves. Otherwise, there is a danger of injuries if the bulb is accidentally damaged during replacement. ◀

 Attach the cover carefully  
When attaching the cover, proceed carefully; otherwise, leaks may occur, causing damage to the headlamp system. ◀

#### Access to the bulbs through the engine compartment

Follow the general instructions on lamps and bulbs, refer to page 244.

Low beam/high beam bulbs can be changed from the engine compartment.

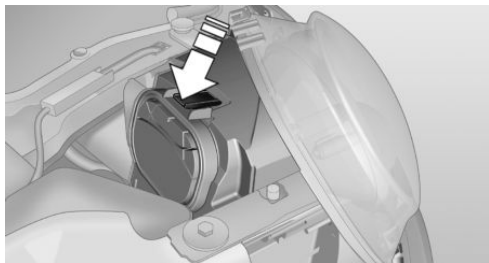

To remove the cover:

1. Press the tab.
2. Fold away the cover and take it out of the holder.

Proceed in reverse order to attach the cover.

 Attach the cover carefully

When attaching the cover, proceed carefully; otherwise, leaks may occur, causing damage to the headlamp system. ◀

### Replacing the bulb

1. Turn the bulb counterclockwise, arrow 1, and remove it, arrow 2.

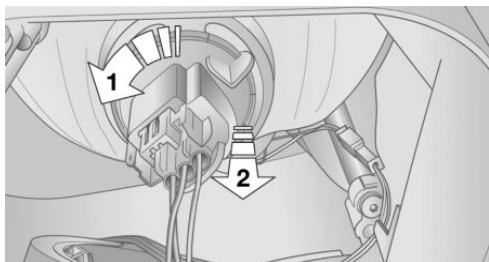

2. Press the release, arrow 1, and pull off the connector, arrow 2.

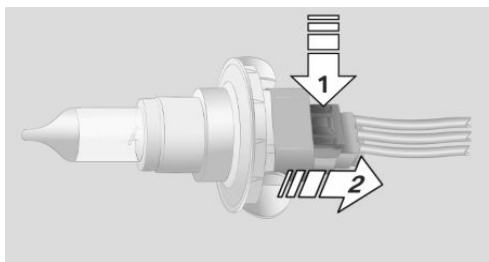

3. Insert the new bulb and attach the cover in reverse order.

### Turn signal, parking lamp, roadside parking lamp, and front fog lamp

#### Access to the bulbs via the wheel housing

Follow the general instructions on lamps and bulbs, refer to page 244.

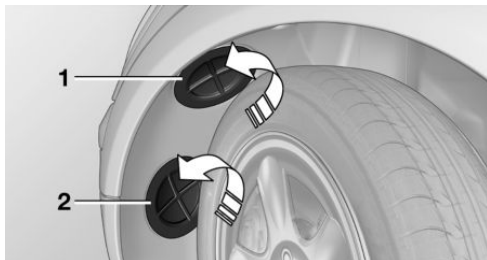

- 1 Turn signal
- 2 Parking lamp/roadside parking lamp/fog lamp

#### Replacing the turn signal bulb

21-watt bulb, P 21 W, or PY 21 W

1. Turn the wheel.
2. Remove cover 1.  
To do this, turn the cover counterclockwise.
3. Remove the inside cover. To do this, turn the cover counterclockwise.

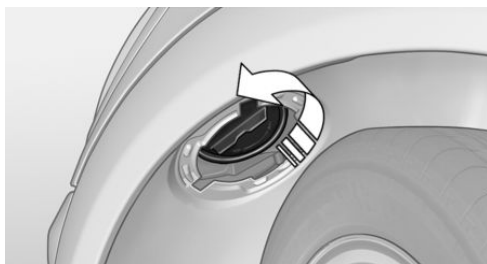

4. Turn the bulb counterclockwise and remove it.

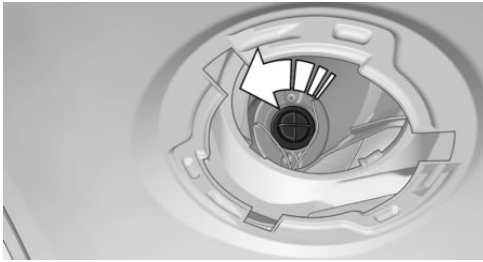

5. Insert the new bulb and attach the covers in reverse order.

### Replacing the parking lamp bulb and roadside parking lamp bulb

5-watt bulb, W 5 W

1. Turn the wheel.
2. Remove cover 2.  
To do this, turn the cover counterclockwise.
3. Turn the upper bulb counterclockwise and remove it.



4. Insert the new bulb and attach the cover in reverse order.

### Replacing the front fog lamp bulb

H8 bulb, 35 watt

1. Turn the wheel.
2. Remove cover 2.  
To do this, turn the cover counterclockwise.
3. Pull off the plug-in cable connector.

4. Turn the lower bulb counterclockwise and remove it.



5. Insert the new bulb and attach the cover in reverse order.

### Lateral turn signals

5-watt bulb, W 5 W

1. Push the lamp forward with the air grille and remove it.

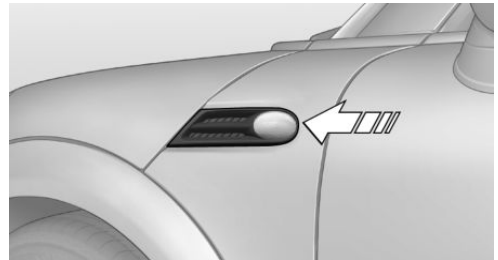

2. Turn the bulb holder counterclockwise and remove it.
3. Pull out the bulb and replace it.
4. Insert the new bulb and attach the cover in reverse order.

### Tail lamps, bulb replacement

Follow the general instructions on lamps and bulbs, refer to page 244.

Turn signal: 21-watt bulb, PY 21 W

Brake lamp: 21-watt/5-watt bulb, W 5 W

Remaining lamps: 21-watt bulb, P 21 W



- 1 Turn signal
- 2 Tail lamp LED
- 3 Brake lamp

## Replacing

### MINI Coupe, MINI Roadster

1. Remove the cover of the cargo area side wall.

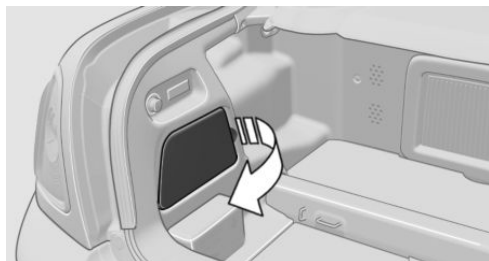

2. Turn the corresponding bulb counterclockwise, arrows 1, and remove.

Another bulb is located behind the cargo area side wall, arrow 2.

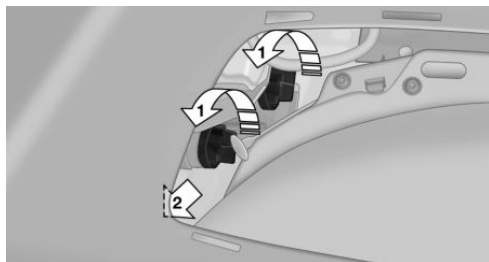

3. Insert the new bulb and attach the cover in reverse order.

### MINI Convertible

1. Remove the cover of the cargo area side wall.

Move the convertible top to the top position, refer to page 116, and take off the cover of the cargo area side wall.

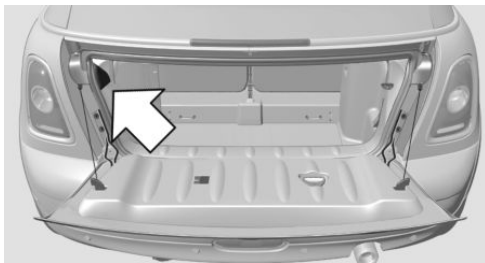

2. Turn the corresponding bulb counterclockwise, arrows 1, and remove.

Another bulb is located behind the cargo area side wall, arrow 2.

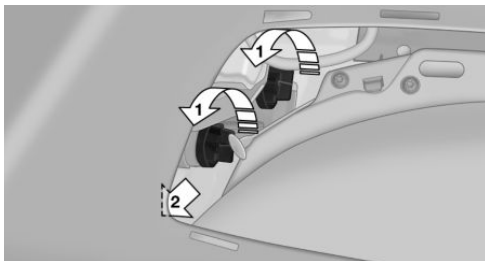

3. Insert the new bulb and attach the cover in reverse order.

### Rear fog lamp/backup lamps

16-watt bulbs, W 16W

The lamps are accessed via the rear side or the underside of the bumper.



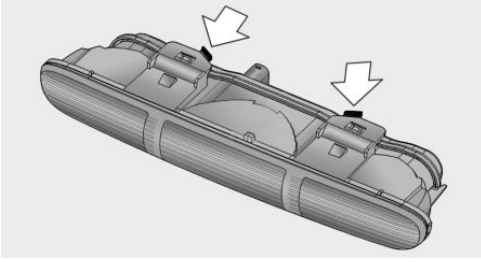

1. Squeeze the clips, arrows, and remove the bulb holder.
2. Pull off the bulb and replace it.
3. Insert the new bulb and bulb holder in reverse order.
4. Re-engage the bulb holder so that it audibly clicks into place.

#### John Cooper Works: aerodynamic bumper

The lamps are accessed via the rear side or the underside of the bumper.

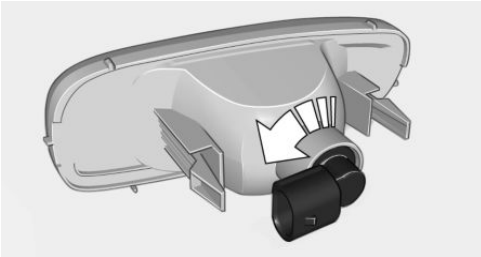

1. Remove the bulb holder by turning it counterclockwise, arrow.
2. Pull off the bulb and replace it.
3. Insert the new bulb and bulb holder in reverse order.

#### License plate lamps

5-watt bulb, C 5 W

1. Push the lamp to the left in the catch of the lamp housing using the screwdriver, arrow 1.

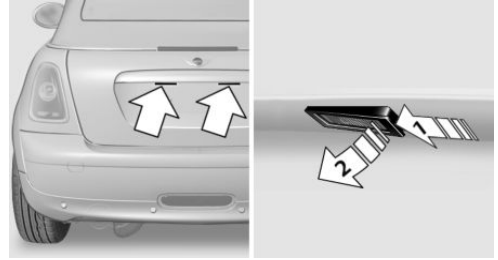

2. Take out the lamp, arrow 2.
3. Replace the bulb.
4. Insert the lamp.

#### Center brake lamp

This lamp uses LED technology for operation. Contact your service center in the event of a malfunction.

## CHANGING WHEELS

#### Notes

Wheel change for run-flat tires:

- ▷ Prepare for the wheel change, refer to page 251.
- ▷ Jack up the vehicle, refer to page 251.
- ▷ Tighten the lug bolts, refer to page 252.

#### Compact wheel

Wheel change with a compact wheel:

- ▷ Remove the compact wheel, refer to page 250.
- ▷ Prepare for the wheel change, refer to page 251.
- ▷ Jack up the vehicle, refer to page 251.

- ▷ Mount the compact wheel, refer to page 251.
- ▷ Tighten the lug bolts, refer to page 252.
- ▷ Drive with the compact wheel, refer to page 250.

### Removing the compact wheel

The screw fitting of the compact wheel is located in the cargo area under the floor mat, on the floor of the storage compartment holding the wheel change set.

1. Release the screw fitting with the special wrench.
2. Take out the cover.
3. Screw the lifting handle from the onboard vehicle tool kit onto the thread.



4. Raise the lifting handle slightly.

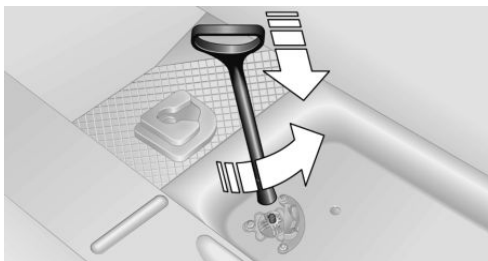

5. Squeeze the locking spring.

6. Lower the compact wheel with the lifting handle.

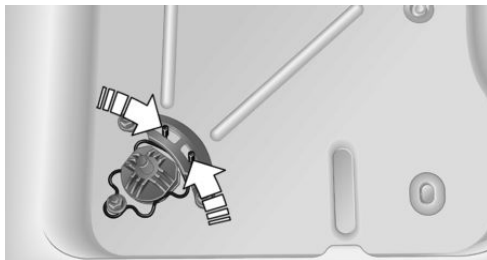

7. Lower the compact wheel with the lifting handle.
8. Unscrew the lifting handle again.
9. Pull the compact wheel out from under the vehicle toward the back.

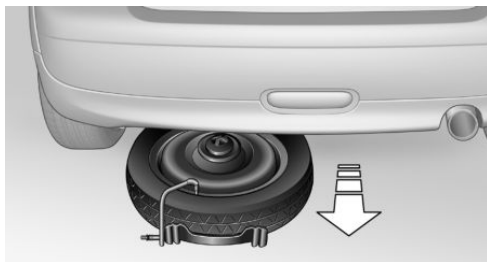

10. Lay the compact wheel down with the valve facing up.
11. Unscrew the valve extension from the valve of the compact wheel.
12. Unscrew the dust cap from the extension and attach it to the valve of the compact wheel.

The defective wheel cannot be stowed in the compact wheel holder because it has a different size.

### Driving with compact wheel

 Do not exceed a speed of 50 mph/80 km/h.

Drive conservatively and do not exceed a speed of 50 mph/80 km/h. Otherwise, changes in the driving characteristics could result, for example

reduced track stability on braking, extended braking distance, and altered self-steering characteristics in the limit range. In conjunction with winter tires, these characteristics are more pronounced. ◀

**!** Only mount one compact wheel  
Only one compact wheel may be mounted. Restore the wheels and tires to their original size as quickly as possible. Failure to do so is a safety risk. ◀

Check the tire inflation pressure at the next opportunity and correct it if necessary. Replace the defective tire as soon as possible and have the new wheel balanced.

### Preparing wheel change

Observe the safety precautions regarding flat tires, refer to page 232.

**!** Additional safety precautions in the event of a wheel change

Change the wheel only on a level, firm surface which is not slippery.

The vehicle or the jack could slip to the side if you attempt to raise the vehicle on a soft or slippery surface, snow, ice, tiles, etc. Do not use a wooden block or similar object as a support base for the jack, as this would prevent it from extending to its full support height and reduce its load-carrying capacity.

To avoid serious or fatal injury: never lie under the vehicle, and never start the engine while it is supported by the jack. ◀

1. Place the folding wheel chock behind the front wheel of the other vehicle side; if the vehicle is on an incline, place it in front of this wheel. If the vehicle is parked on a steep incline, additionally secure the vehicle against rolling.
2. Expose the lug bolts if necessary.
3. Loosen the lug bolts a half turn.

### Jacking up vehicle

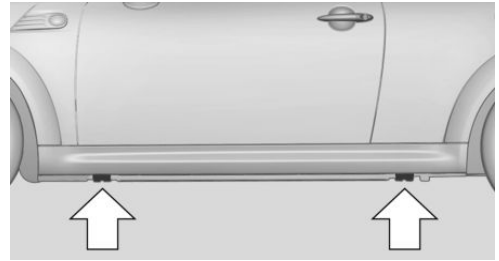

**!** The vehicle jack is designed for changing wheels only.

The vehicle jack is designed for changing wheels only. Do not attempt to raise another vehicle model with it or to raise any load of any kind. To do so could cause accidents and personal injury. ◀

1. Position the vehicle jack at the jacking point closest to the wheel.

The entire surface of the jack base must rest on the ground vertically beneath the jacking point.

2. Guide the jack head into the rectangular recess of the jacking point when cranking up.

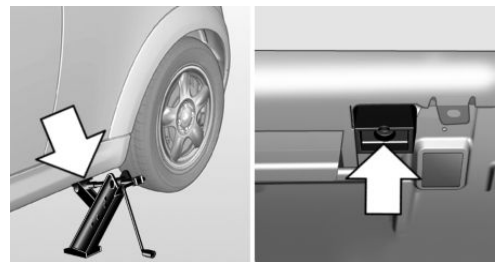

3. Jack the vehicle up until the wheel you are changing is raised from the ground.

### Mounting the compact wheel

1. Unscrew the lug bolts and remove the wheel.
2. Remove accumulations of mud or dirt from the mounting surfaces of the wheel and hub. Also clean the lug bolts.

3. Mount the new wheel.
4. Screw in at least two bolts crosswise.
5. Screw in the remaining lug bolts.
6. Fully tighten all lug bolts in a diagonal pattern.
7. Lower the vehicle.
8. Remove the jack.

### Retightening the lug bolts

Retighten the lug bolts diagonally.



Checking that the lug bolts are tight

Always have the lug bolts checked with a calibrated torque wrench as soon as possible to ensure that they are tightened to the specified torque. Otherwise, incorrectly tightened lug bolts are a hidden safety risk. ◀

The tightening torque equals  
103.3 lb ft/140 Nm.

Replace the defective tire as soon as possible and have the new wheel balanced.

## VEHICLE BATTERY

### Maintenance

The battery is maintenance-free, i.e., the electrolyte will last for the life of the battery in temperate climate conditions.

The service center will be happy to answer any questions on the battery.

### Battery replacement



Use approved vehicle batteries

Only use vehicle batteries that have been approved for your vehicle by the manufacturer; otherwise, the vehicle could be damaged and systems or functions may not be fully available. ◀

Have the vehicle battery registered by the service center after it is replaced to ensure that all comfort functions are available without restric-

tions and that any associated Check Control messages are no longer displayed.

### Charging the battery

#### Note



Do not connect the charger to the socket

Do not connect the battery charger to the socket installed in the vehicle at the factory as this could damage the battery. ◀

Only charge the battery in the vehicle when the engine is switched off. Connections, refer to page 254.

### General information

Ensure that the battery is sufficiently charged to achieve the full battery life.

It may be necessary to charge the battery in the following cases:

- ▷ When the vehicle is frequently used to travel short distances.
- ▷ When the vehicle has not been driven for more than one month.

### Power failure

After a temporary power failure, some equipment will be restricted in its use and will need to be reinitialized. In addition, certain individual settings will be lost and must be updated:

- ▷ Time and date: the values must be updated, refer to page 79.
- ▷ Radio: the stations need to be stored again, refer to page 161.
- ▷ Onboard monitor: full functionality will be restored after some time.

### Indicator/warning lamps



Lights up red: the vehicle battery is no longer being charged. Alternator malfunction.

Switch off all unnecessary electrical consumers. Have the battery checked immediately.



Lights up yellow: the battery charge level is very low, the battery is old, or it is not securely connected.

Charge the battery by taking a long drive or using an external charger. If the indicators appear again, have the battery checked as soon as possible.

### Disposing of old batteries



Have used batteries disposed of by the service center after they are replaced or take them to a recycling center.

Maintain the battery in an upright position for transport and storage. Secure the battery so that it does not tip over during transport.

## FUSES



Replacing fuses

Never attempt to repair a blown fuse and do not replace a defective fuse with a substitute of another color or amperage rating; this could lead to a circuit overload, ultimately resulting in a fire in the vehicle. ◀

Fuses should be replaced by the service center. Information on the fuses can be found on the inside of the covers.

### In the engine compartment

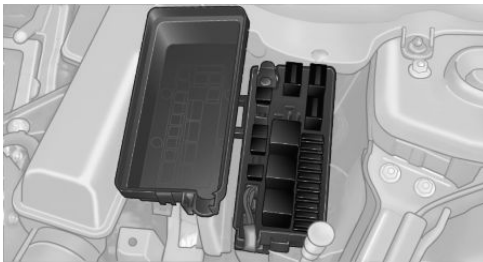

### Opening the cover

Press the snap lock.

### In interior

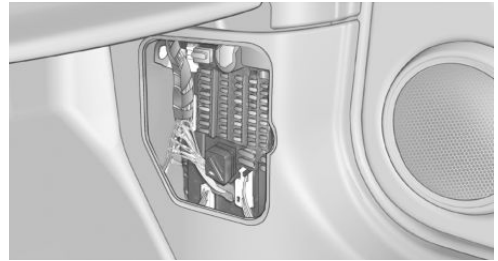

On the right side of the footwell.

### Opening the cover

Push out at the recess.

# BREAKDOWN ASSISTANCE

## VEHICLE EQUIPMENT

This chapter describes all series equipment as well as country-specific and special equipment offered for this model series. Therefore, it also describes equipment that may not be found in your vehicle, for instance due to the selected special equipment or the country version. This also applies to safety-related functions and systems.

## HAZARD WARNING FLASHERS

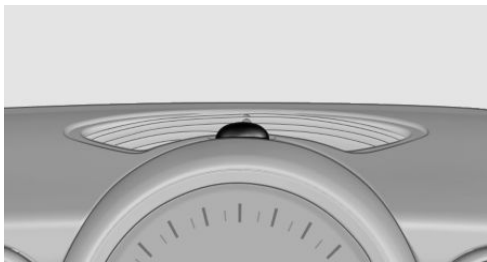

The button is located on the speedometer.

## WARNING TRIANGLE

The warning triangle is located in the front on the trunk floor.

## FIRST AID KIT

Some of the articles contained in the first aid kit have a limited service life. Therefore, check the use-by dates of the contents regularly and replace the items before they expire.

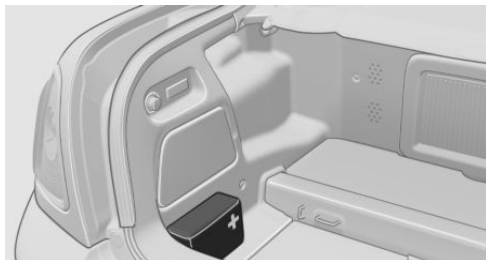

The first aid kit is located in the left side trim on the cargo area floor.

## ROADSIDE ASSISTANCE

### Service availability

Roadside Assistance can be reached around the clock in many countries. You can obtain assistance there in the event of a vehicle breakdown.

## JUMP-STARTING

### Notes

If the battery is discharged, the engine can be started using the battery of another vehicle and two jumper cables. In the same way, you can help jump-start another vehicle. Only use jumper cables with fully insulated clamp handles.

To prevent personal injury or damage to both vehicles, adhere strictly to the following procedure.



Do not touch live parts

To avoid the risk of potentially fatal injury, always avoid all contact with electrical components while the engine is running. ◀

## Preparation

1. Check whether the battery of the other vehicle has a voltage of 12 volts and approximately the same capacitance in Ah. This information can be found on the battery.
2. Switch off the engine of the assisting vehicle.
3. Switch off any electronic systems/power consumers in both vehicles.



### Bodywork contact between vehicles

There must not be any contact between the bodies of the two vehicles, otherwise there is a danger of shorting. ◀

## Connecting jumper cables



### Connecting order

Connect the jumper cables in the correct order; otherwise, there is the danger of injury from sparking. ◀

1. Open the battery cover in the engine compartment to access the positive terminal.

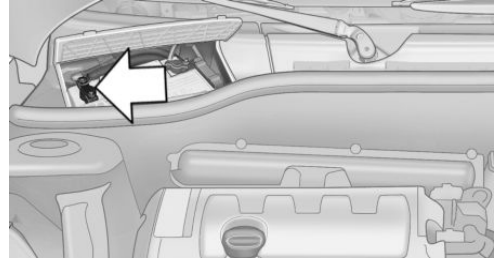

2. Unlock the tabs of the positive terminal cover on the left and right, arrows 1, and raise the cover, arrow 2.

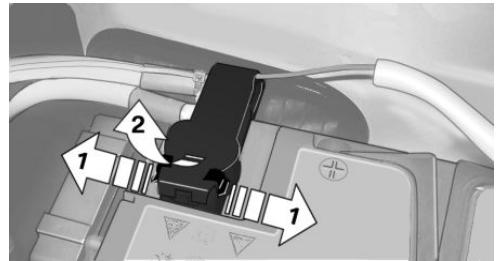

3. Attach one terminal clamp of the positive jumper cable to the positive terminal of the battery or to a starting aid terminal of the vehicle providing assistance.
4. Attach the second clamp of the positive jumper cable to the positive terminal of the battery of the vehicle to be started.
5. Attach one terminal clamp of the negative jumper cable to the negative terminal of the battery, or to the corresponding engine or body ground of the vehicle providing assistance.
6. Attach the second clamp of the negative jumper cable to the negative terminal of

the battery, or to the engine or body ground of the vehicle to be started.

Body ground:

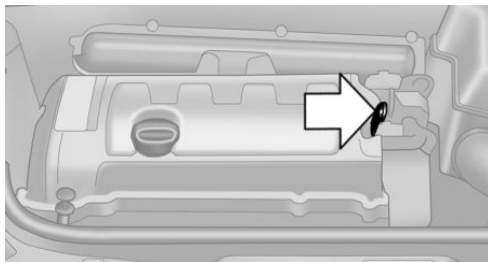

## Starting the engine

Never use spray fluids to start the engine.

1. Start the engine of the assisting vehicle and let it run for several minutes at a slightly increased idle speed.
2. Start the engine of the vehicle being started in the usual way.



If the first starting attempt is not successful, wait a few minutes before making another attempt in order to allow the discharged battery to recharge.

3. Let both engines run for several minutes.
4. Disconnect the jumper cables in the reverse order.

Check the battery and recharge if necessary.

## TOW-STARTING AND TOWING

### Notes

 Observe applicable laws and regulations  
 Observe applicable laws and regulations for tow-starting and towing. ◀

 No additional passengers  
 Do not transport any passengers other than the driver in a vehicle that is being towed. ◀

## Using a tow fitting

The screw-in tow fitting must always be carried in the vehicle. It can be screwed in at the front or rear of the MINI.



Tow fitting, information on use

- ▶ Use only the tow fitting provided with the vehicle and screw it all the way in.
- ▶ Use the tow fitting for towing on paved roads only.
- ▶ Avoid lateral loading of the tow fitting, e.g., do not lift the vehicle by the tow fitting.

Otherwise, damage to the tow fitting and the vehicle can occur. ◀

## Access to the screw thread

Push out the tow fitting cover at the appropriate recess in the bumper.

### Front

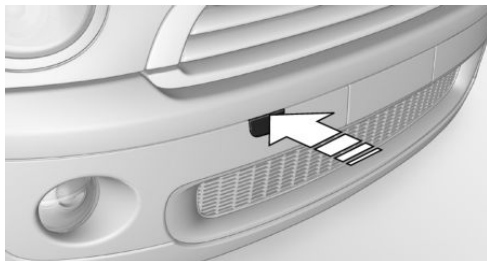

### Rear

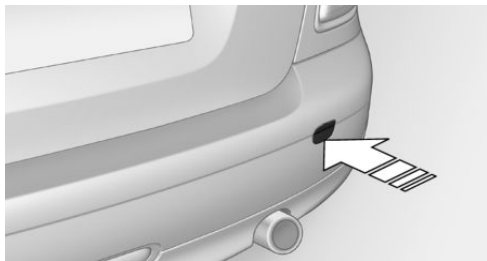

John Cooper Works with aerodynamic bumper:  
 Pull out the tow fitting cover in the bumper in the lower section, arrow.





## Being towed

 Follow the towing instructions  
Follow all towing instructions, or vehicle damage or accidents may occur. ◀

- ▷ Make sure that the ignition is switched on; otherwise, the low beams, tail lamps, turn signals, and windshield wipers may be unavailable.
- ▷ Do not tow the vehicle with the rear axle tilted, as the front wheels could turn.
- ▷ When the engine is stopped, there is no power assist. Consequently, more force needs to be applied when braking and steering.
- ▷
- ▷ Larger steering wheel movements are required.
- ▷ Switch on the hazard warning system, depending on local regulations.

## Manual transmission

Gearshift lever in neutral position.

## Automatic transmission

 Towing vehicles with an automatic transmission

Only transport vehicles with an automatic transmission on tow trucks or with raised front wheels; otherwise, the transmission may be damaged. ◀

## Towing with a tow bar

 Light towing vehicle  
The towing vehicle must not be lighter than your vehicle, or it will not be possible to control vehicle response. ◀

 Correctly attach the tow bar  
Only secure the tow bar on the tow fittings; damage can occur when it is secured on other parts of the vehicle. ◀

The tow fittings used should be on the same side on both vehicles.

Should it prove impossible to avoid mounting the tow bar at an offset angle, please observe the following:

- ▷ Clearance and maneuvering capability will be sharply limited during cornering.
- ▷ The tow bar will generate lateral forces if it is attached offset.

## Towing with a tow rope

When starting to tow the vehicle, make sure that the tow rope is taut.

To avoid jerking and the associated stresses on the vehicle components when towing, always use nylon ropes or nylon straps.

 Attaching the tow rope correctly  
Only secure the tow rope on the tow fitting; otherwise, damage can occur when it is secured on other parts of the vehicle. ◀

## Towing with a tow truck

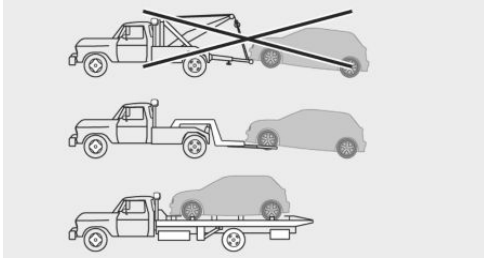

Have the MINI transported with a tow truck with a so-called lift bar or on a flat bed.



Do not lift the vehicle

Do not lift the vehicle by the tow fitting or body and chassis parts; otherwise, damage may result. ◀

## Tow-starting

If possible, do not tow-start the vehicle but start the engine by jump-starting, refer to page 254. Vehicles with a catalytic converter should only be tow-started when the engine is cold; vehicles with an automatic transmission cannot be tow-started.

1. Switch on the hazard warning system and comply with local regulations.
2. Switch on the ignition, refer to page 64.
3. Shift into 3rd gear.
4. Have the vehicle tow-started with the clutch depressed and then slowly release the clutch. After the engine starts, immediately depress the clutch completely again.
5. Stop at a suitable location, remove the tow bar or rope, and switch off the hazard warning system.
6. Have the vehicle checked.

# CARE

## VEHICLE EQUIPMENT

This chapter describes all series equipment as well as country-specific and special equipment offered for this model series. Therefore, it also describes equipment that may not be found in your vehicle, for instance due to the selected special equipment or the country version. This also applies to safety-related functions and systems.

## CAR WASHES

### Notes

 Steam jets or high-pressure washers  
When using steam jets or high-pressure washers, hold them a sufficient distance away and use a maximum temperature of 140 °F/60 °C.

Holding them too close or using excessively high pressures or temperatures can cause damage or preliminary damage that may then lead to long-term damage.

Follow the operating instructions for the high-pressure washer. ◀

 Cleaning sensors/cameras with high-pressure washers

When using high-pressure washers, do not spray the seals of the retractable hardtop and the exterior sensors and cameras, for Park Distance Control, for instance, for extended periods of time and only from a distance of at least 12 in/30 cm. ◀

 During the winter months  
Ensure that the vehicle is washed more frequently in winter. Intense soiling and road salt can damage the vehicle. ◀

After washing the vehicle, apply the brakes briefly to dry them; otherwise, braking action can be reduced and corrosion of the brake discs can occur.

Regularly remove foreign bodies, such as leaves, from the area of the windshield when the hood is open.

### Washing in automatic car washes

Give preference to cloth car washes or those that use soft brushes in order to avoid paint damage.

Do not use automatic high-pressure washers; otherwise, water may drip into the interior in the area of the windows.

Before driving into the car wash, check whether the system is suitable for your MINI. Note the following points:

- ▷ Vehicle dimensions, refer to page 267.
- ▷ If necessary: fold in the exterior mirrors, refer to page 57.
- ▷ Maximum permissible tire width.

 Guide rails in car washes  
Avoid car washes with guide rails higher than 4 in/10 cm; otherwise, the vehicle chassis could be damaged. ◀

Preparations before driving into the car wash:

- ▷ Unscrew the road antenna.
- ▷ MINI Coupe, MINI Roadster: retract the rear spoiler.
- ▷ Deactivate the rain sensor to avoid unintentional wiper activation.
- ▷ Remove additional attachments, for instance a spoiler or telephone antenna, if there is a risk that these may be damaged.
- ▷ Insert the remote control into the ignition lock.

## Automatic transmission

Before driving into the car wash, note the following to ensure that the vehicle can roll:

1. Insert the remote control into the ignition lock, even with Comfort Access.
2. Move the selector lever to position N.
3. Release the handbrake.
4. Switch the engine off.
5. Leave the remote control in the ignition lock so that the vehicle can roll.

## Hand car wash

If washing the vehicle by hand, use copious quantities of water and car shampoo if necessary. Clean the vehicle with a sponge or a washing brush by applying gentle pressure.

Before cleaning the windshield, deactivate the rain sensor to avoid unintentional wiper activation or switch off the ignition.



Adhere to the local regulations regarding washing cars by hand.

## Headlamps

Do not rub dry and do not use abrasive or caustic cleansers. Soak areas that have been soiled, e.g., due to insects, with shampoo and rinse off with copious quantities of water.

Thaw ice with a window deicer; do not use an ice scraper.

## Windows

Clean the outside and inside surfaces of the windows and the mirror glasses with window cleaner.

Do not clean mirror glass with cleaners containing quartz.

## Wiper blades

Clean with soapy water and replace regularly to avoid streaking.

Wax and preservative residue and soiling on the windows cause streaking during window wiping and lead to premature wear on the wiper blades and malfunctions of the rain sensor.

## VEHICLE CARE

### Car care products

Regular cleaning and care contributes significantly to vehicle value retention.

The manufacturer recommends using cleaning and care products from MINI, since these have been tested and approved.

Original MINI CareProducts have been tested on materials, in the laboratory, and in the field, and offer optimum care and protection for MINI vehicles.



Do not use cleansers that contain alcohol or solvents

Do not use cleansers that contain alcohol or solvents, such as lacquer thinners, heavy-duty grease removers, fuel, or such; this could lead to surface damage. ◀



Car care and cleaning products

Follow the instructions on the container.

When cleaning the interior, open the doors or windows.

Only use products intended for cleaning vehicles.

Cleansers can contain substances that are dangerous and harmful to your health. ◀

### Caring for the convertible top

The appearance and life of the convertible top depend on proper care and operation.

Adhere to the following instructions:

- ▶ Do not fold the convertible top and stow it in the convertible top box while it is wet or

frozen; otherwise, water marks, fabric stains, and chafing may occur.

- ▷ If water marks nevertheless occur on the headliner, these can be removed using a microfiber cloth and interior cleaner.
- ▷ When parking the vehicle in an enclosed space for lengthy periods, ensure that the area is adequately ventilated.
- ▷ Remove bird droppings immediately as their corrosive properties may damage the convertible top and the rubber seals.



#### Stain removal

To remove stains from the convertible top, do not use stain remover, paint thinner, solvents, benzine, or similar substances. These agents can destroy the rubber coating. Improper care and cleaning can cause the convertible top and its seams to become permeable to water. ◀

To remove severe soiling, use a special convertible top cleaner.

Follow the instructions for use from the manufacturer.

Treat the convertible top with an impregnating agent once a year.

### MINI Coupe, MINI Roadster: rear spoiler box

To ensure that proper functioning of the rear spoiler is not impaired, for example due to leaves, snow or ice, clean the rear spoiler box at regular intervals.

### Vehicle paint

Regular care contributes to vehicle value retention and protects the paintwork against the long-term effects of paint-damaging substances.

Environmental influences in areas with higher air pollution or natural contaminants, such as tree resin or pollen, can have an impact on the vehicle paint. Therefore, it is important to tailor

the frequency and extent of your car care to these influences.

Immediately remove especially aggressive substances, such as spilled fuel, oil, grease, or bird droppings, to prevent damage to the paintwork.

### Correcting paint damage

Depending on the severity of the damage, repair stone impact damage or scratches immediately to prevent rust formation.

The manufacturer recommends having paint damage corrected with a professional repair paint job according to factory specifications using original MINI paint materials.

### Preservation

Preservation is needed when water no longer beads off of the clean paint surfaces. Only use paint preservation products that contain carnauba or synthetic waxes.

### Leather care

The leather processed by the manufacturer is a high quality natural product. Light graininess is a typical feature of natural leather.

Particles of dust and road grime chafe in pores and folds, and lead to increased wear and premature degradation of the leather surface. Therefore, remove dust from the leather regularly, using a cloth or vacuum cleaner.

Make especially sure that light-colored leather is cleaned regularly as it is more susceptible to soiling.

Twice a year, treat the leather with a leather lotion as dirt and grease will attack the protective layer of the leather.

### Upholstery material care

Vacuum regularly with a vacuum cleaner to remove superficial soiling.

In case of heavy soiling, e.g., beverage stains, use a soft sponge or lint-free microfiber cloth in

combination with a suitable interior cleaner. Follow the instructions on the container.

Clean the upholstery material down to the seams using large sweeping motions. Avoid rubbing the material vigorously.



Damage from Velcro® fasteners

Open Velcro® fasteners on pants or other articles of clothing can damage the seat covers. Ensure that any Velcro® fasteners are closed. ◀

## Caring for special components

### Interior plastic parts

These include:

- ▷ Imitation leather surfaces
- ▷ Lamp lenses
- ▷ Indicator covers
- ▷ Matte components

Clean with water and a solvent-free plastic cleaner if necessary.



Do not use cleansers that contain alcohol or solvents

Do not use cleansers that contain alcohol or solvents, such as lacquer thinners, heavy-duty grease removers, fuel, or such; this could lead to surface damage. ◀

### Rubber seals

Only treat with water or a rubber care product.

When cleaning rubber seals, do not use silicone sprays or other care products containing silicone; otherwise, noise and damage may result.

### Chrome surfaces

Carefully clean components such as the radiator grille or door handles with an ample supply of water, possibly with shampoo added, particularly when they have been exposed to road salt. For additional treatment, use a chrome polish.

### Light-alloy wheels

When cleaning the wheels on the vehicle, only use a neutral wheel rim cleaner with a pH value of 5 to 9.

Do not use abrasive cleaners or a steam jet hotter than 140 °F/60 °C; otherwise, damage may result. Adhere to the manufacturer instructions.

Aggressive, acidic, or alkaline cleaners may destroy the protective coating of neighboring components such as the brake disc.

### Exterior sensors

The sensors on the outside of the vehicle, such as for Park Distance Control, must be kept clean and free of ice to ensure that they remain fully functional.

### Decorative trim

Clean decorative trims and fine wood components with a moist cloth only. Then dry with a soft cloth.

### Safety belts

Dirty belt straps impede the reeling action and thus have a negative impact on safety.



No chemical cleaning

Do not clean chemically; this can destroy the webbing. ◀

### Carpets/floor mats



No objects in the area around the pedals

Keep floor mats, carpets, and any other objects out of the area of motion of the pedals; otherwise, the function of the pedals could be impeded while driving

Do not place additional floor mats over existing mats or other objects.

Only use floor mats that have been approved for the vehicle and can be properly fixed in place.

Ensure that the floor mats are securely fastened again when they are returned after being removed, such as for cleaning. ◀

Floor mats can be removed for cleaning.

If they are very dirty, clean with a microfiber cloth and water or an interior cleaner. To prevent matting of the carpet, rub back and forth in the direction of travel only.

## Displays

To clean the displays, such as the radio or display elements, use an antistatic microfiber cloth.



### Cleaning displays

Do not use chemical or household cleansers.

Keep all fluids and moisture away from the unit.

Otherwise, they could affect or damage surfaces or electrical components.

Avoid pressing too hard when cleaning and do not use abrasive materials; otherwise, damage can result. ◀

## CD/DVD drives



### No cleaning CD

Do not use cleaning CDs; otherwise, parts of the drive may become damaged. ◀

## Long-term vehicle storage

Your service center can advise you on what to consider when storing the vehicle for longer than three months.

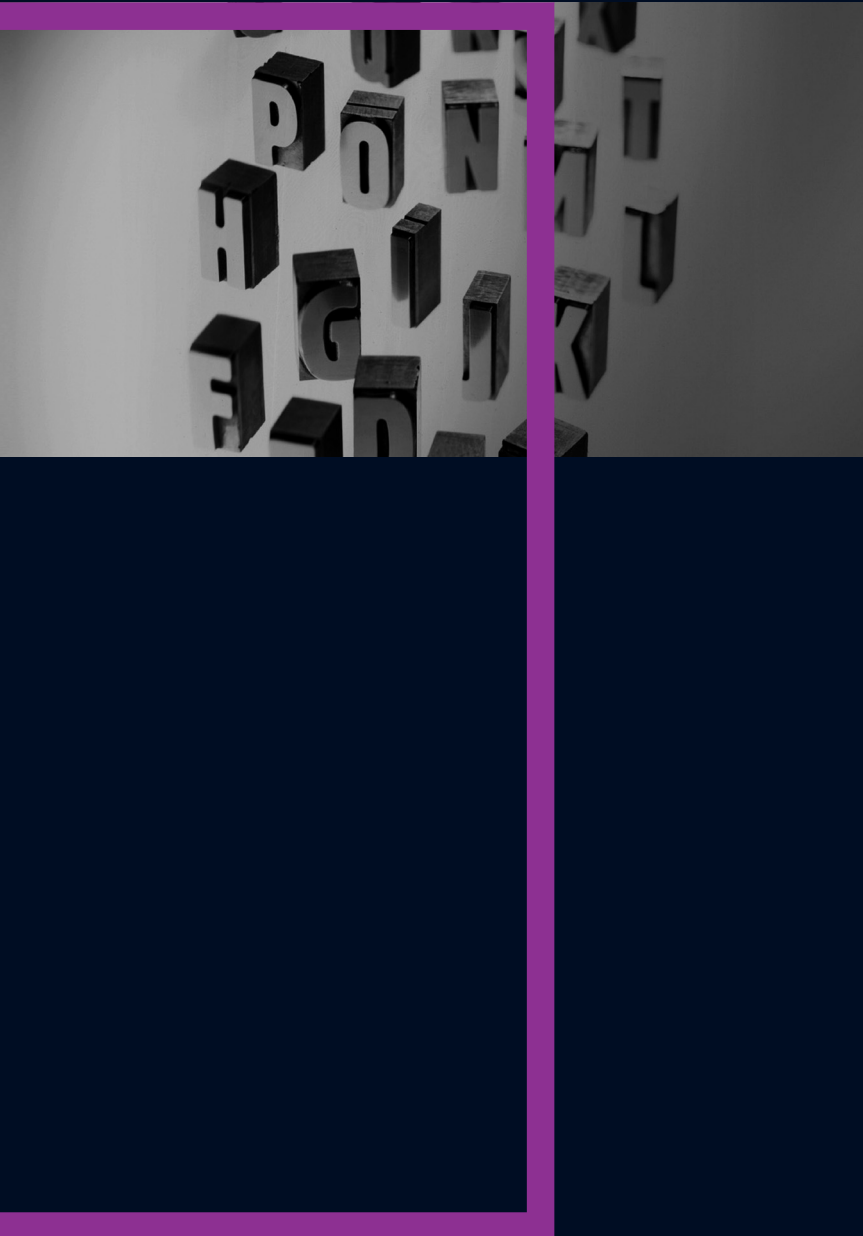



**AT A GLANCE**

**CONTROLS**

**DRIVING TIPS**

**NAVIGATION**

**ENTERTAINMENT**

**COMMUNICATION**

**MOBILITY**

**REFERENCE**

# TECHNICAL DATA

## VEHICLE EQUIPMENT

This chapter describes all series equipment as well as country-specific and special equipment offered for this model series. Therefore, it also

describes equipment that may not be found in your vehicle, for instance due to the selected special equipment or the country version. This also applies to safety-related functions and systems.

## ENGINE SPECIFICATIONS

		Cooper	Cooper S	John Cooper Works
Displacement	cu in/cm <sup>3</sup>	97.5/1,598	97.5/1,598	97.5/1,598
No. of cylinders		4	4	4
Maximum output	hp	121	181	208
at engine speed	rpm	6,000	5,500	6,000
Maximum torque	lb ft/Nm	114/155	177/240	192/260
with overboost		–	192/260	207/280
at engine speed	rpm	4,250	1,600-5,000	1,750-5,500
with overboost		–	1,730-4,500	2,000-5,100

Overboost briefly increases the highest torque during rapid acceleration, for example when passing another vehicle.

## DIMENSIONS

### MINI Coupe

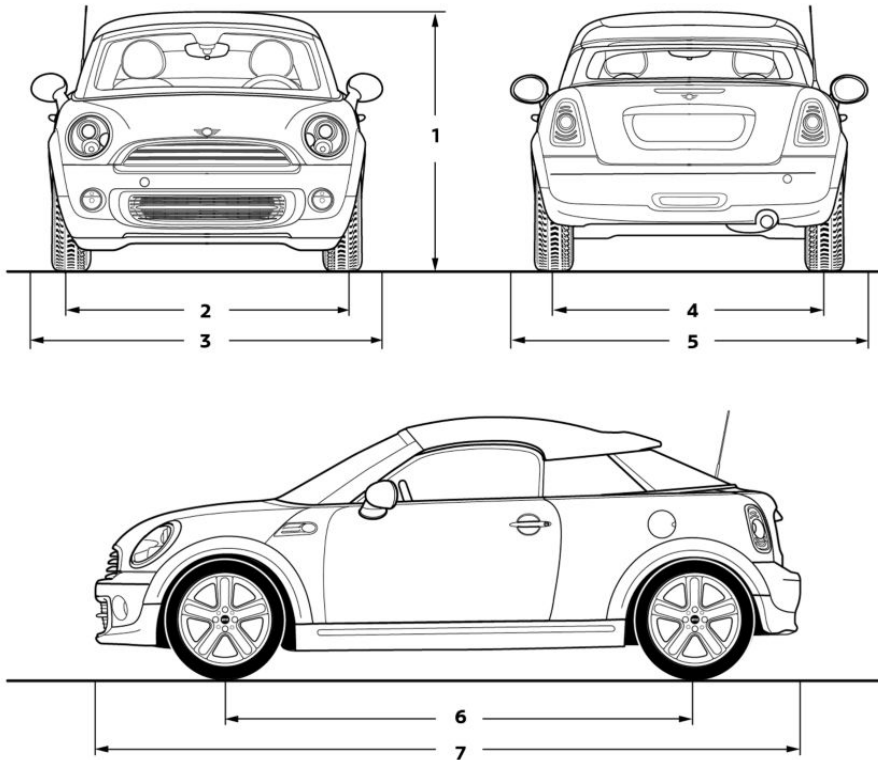

	Cooper	Cooper S	John Cooper Works	
1	Vehicle height without roof antenna	54.3/1,378	54.5/1,384	54.5/1,385
2	Track width, front	57.4/1,459	57.2/1,453	57.2/1,453
3	Vehicle width with exterior mirrors	74.5/1,892	74.5/1,892	74.5/1,892
4	Track width, rear	57.8/1,467	57.5/1,461	57.5/1,461

		Cooper	Cooper S	John Cooper Works
5	Vehicle width without exterior mirrors	66.3/1,683	66.3/1,683	66.3/1,683
6	Wheelbase	97.1/2,467	97.1/2,467	97.1/2,467
7	Vehicle length	146.8/3,728	147/3,734	148/3,758

All dimensions in in/mm. Smallest turning radius dia.: 35 ft 10 in/10.7 m.

MINI Roadster

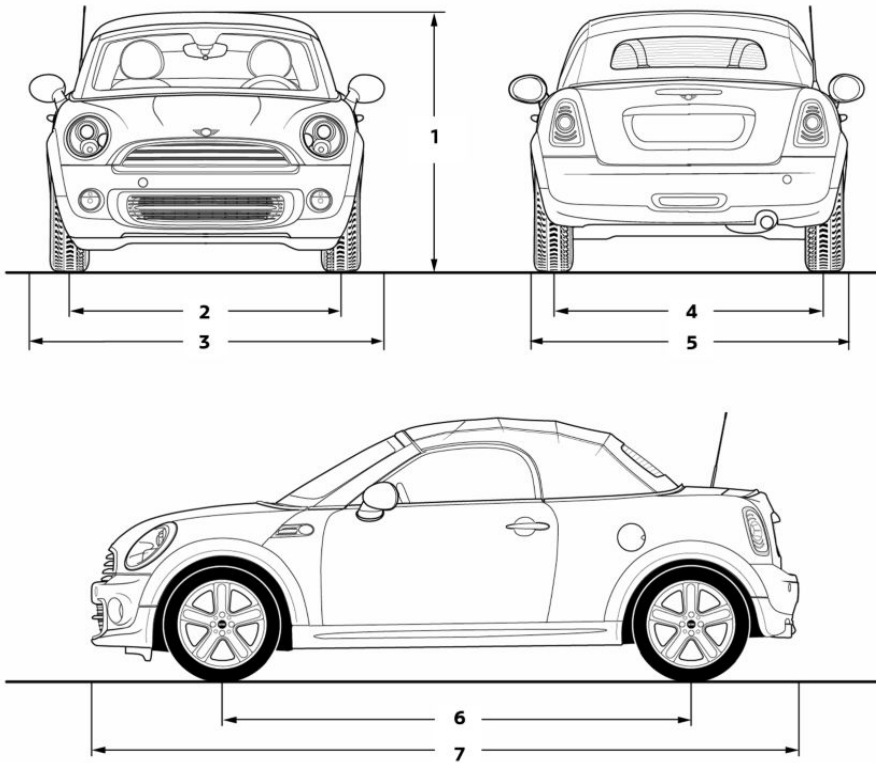

	Cooper	Cooper S	John Cooper Works	
1	Vehicle height without roof antenna	54.5/1,384	54.7/1,390	54.8/1,391
2	Track width, front	57.4/1,459	57.2/1,453	57.2/1,453
3	Vehicle width with exterior mirrors	74.5/1,892	74.5/1,892	74.5/1,892
4	Track width, rear	57.8/1,467	57.5/1,461	57.5/1,461
5	Vehicle width without exterior mirrors	66.3/1,683	66.3/1,683	66.3/1,683
6	Wheelbase	97.1/2,467	97.1/2,467	97.1/2,467
7	Vehicle length	146.8/3,728	147/3,734	148/3,758

All dimensions in in/mm. Smallest turning radius dia.: 35 ft 10 in/10.7 m.

## MINI Convertible

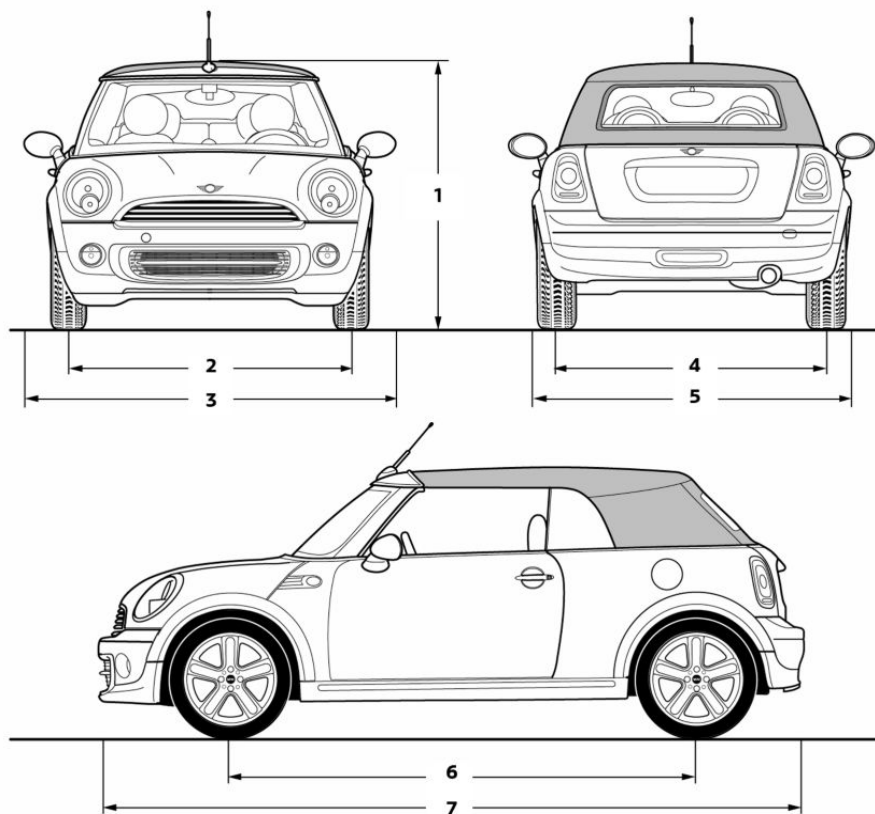

		Cooper	Cooper S	John Cooper Works
1	Vehicle height without roof antenna	55.7/1,414	55.7/1,414	55.7/1,414
2	Track width, front	57.4/1,459	57.2/1,453	57.2/1,453
3	Vehicle width with exterior mirrors	75.3/1,913	75.3/1,913	75.3/1,913
4	Track width, rear	57.8/1,467	57.5/1,461	57.5/1,461
5	Vehicle width without exterior mirrors	66.3/1,683	66.3/1,683	66.3/1,683
6	Wheelbase	97.1/2,467	97.1/2,467	97.1/2,467

	Cooper	Cooper S	John Cooper Works
7 Vehicle length	146.6/3,723	146.8/3,729	148/3,758

All dimensions in in/mm. Smallest turning radius dia.: 35 ft 10 in/10.7 m.

## WEIGHTS

Never exceed either the approved axle loads or the gross vehicle weight.

### MINI Coupe

		Cooper	Cooper S	John Cooper Works
Curb weight, road ready, with maximum special equipment				
Manual transmission	lbs/kg	2,557/1,160	2,679/1,215	2,712/1,230
Automatic transmission	lbs/kg	2,635/1,195	2,734/1,240	2,767/1,255
Approved gross vehicle weight				
Manual transmission	lbs/kg	3,175/1,440	3,252/1,475	3,263/1,480
Automatic transmission	lbs/kg	3,252/1,475	3,307/1,500	3,318/1,505
Approved front axle load				
Manual transmission	lbs/kg	1,786/810	1,885/855	1,896/860
Automatic transmission	lbs/kg	1,863/845	1,940/880	1,951/885
Approved rear axle load				
	lbs/kg	1,411/640	1,411/640	1,411/640
Cargo area capacity	cu ft/ liter	9.9/280	9.9/280	9.9/280

### MINI Roadster

		Cooper	Cooper S	John Cooper Works
Curb weight, road ready, with maximum special equipment				
Manual transmission	lbs/kg	2,635/1,195	2,745/1,245	2,778/1,260
Automatic transmission	lbs/kg	2,712/1,230	2,800/1,270	2,833/1,285
Approved gross vehicle weight				
Manual transmission	lbs/kg	3,241/1,470	3,329/1,510	3,340/1,515
Automatic transmission	lbs/kg	3,318/1,505	3,373/1,530	3,395/1,540

		Cooper	Cooper S	John Cooper Works
Approved front axle load				
Manual transmission	lbs/kg	1,786/810	1,896/860	1,907/865
Automatic transmission	lbs/kg	1,863/845	1,951/885	1,962/890
Approved rear axle load	lbs/kg	1,488/675	1,466/665	1,488/675
Cargo area capacity	cu ft/ liter	8.5/240	8.5/240	8.5/240

## MINI Convertible

		Cooper	Cooper S	John Cooper Works
Curb weight, road ready, with maximum special equipment				
Manual transmission	lbs/kg	2,701/1,225	2,811/1,275	2,822/1,280
Automatic transmission	lbs/kg	2,778/1,260	2,855/1,295	2,866/1,300
Approved gross vehicle weight				
Manual transmission	lbs/kg	3,560/1,615	3,671/1,665	3,704/1,680
Automatic transmission	lbs/kg	3,638/1,650	3,737/1,695	3,748/1,700
Approved front axle load				
Manual transmission	lbs/kg	1,863/845	1,951/885	1,973/895
Automatic transmission	lbs/kg	1,940/880	2,017/915	2,017/915
Approved rear axle load	lbs/kg	1,786/810	1,786/810	1,797/815
Cargo area capacity	cu ft/ liter	4.4-23.3/125-660	4.4-23.3/125-660	4.4-23.3/125-660



## CAPACITIES

			Notes
Fuel tank	US gal/liters	Approx. 13.2/50	Fuel quality, refer to page <a href="#">220</a>
Including reserve of	US gal/liters	Approx. 2.1/8	
Window washer system	US qt/liters	Approx. 4.8/4.5	Details, refer to page <a href="#">69</a>
With headlamp washer system			

# SHORT COMMANDS FOR VOICE ACTIVATION SYSTEM

## VEHICLE EQUIPMENT

This chapter describes all series equipment as well as country-specific and special equipment offered for this model series. Therefore, it also describes equipment that may not be found in your vehicle, for instance due to the selected special equipment or the country version. This also applies to safety-related functions and systems.

To have the available spoken instructions read out loud: ›Voice commands‹

The following short commands apply to vehicles equipped with a voice activation system. They have no function in vehicles in which only the mobile phone is operated using the voice.

## GENERAL INFORMATION

Instructions for voice activation system, refer to page 24.

## ADJUSTING

### Vehicle

Function	Command
Opens the main menu.	›Main menu‹
Open the options.	›Options‹
Open the settings.	›Settings‹
Settings on the Control Display.	›Control display‹
Open the time and date.	›Time and date‹
Open the language and units.	›Language and units‹
Open the speed limit.	›Speed‹
Open the light.	›Lighting‹
Open the door lock.	›Door locks‹

## VEHICLE INFORMATION

### Computer

Function	Command
Open the computer.	›Onboard info‹
Open the trip computer.	›Trip computer‹

### Vehicle

Function	Command
Open the vehicle information.	›Vehicle info‹
Open the vehicle status.	›Vehicle status‹

## NAVIGATION

### General information

Function	Command
Navigation menu.	›Navigation‹
Open the destination entry.	›Enter address‹
Enter the address.	›Enter address‹
Enter the town/city.	›City‹
Enter the country.	›State‹
Enter the postal code.	›Postal Code‹
Open destination guidance.	›Guidance‹
Start destination guidance.	›Start guidance‹
Terminate destination guidance.	›Stop guidance‹
Open the home address.	›Home address‹
Open the route criteria.	›Route preference‹
Open the route.	›Route information‹
Switch on the spoken instruction.	›Switch on voice instructions‹
Repeat the spoken instruction.	›Repeat voice instructions‹

Function	Command
Switch off the spoken instruction.	›Switch off voice instructions‹
Display the address book.	›Address book‹
Display the most recent destinations.	›Last destinations‹
Open the traffic bulletins.	›Traffic Info‹
Special destinations.	›Points of interest‹

## Map

Function	Command
Display the map.	›Map‹
Map facing north.	›Map facing north‹
Map facing the direction of travel.	›Map in direction of travel‹
Perspective map.	›Map perspective view‹
Automatic scaling of the map.	›Map with automatic scaling‹
Scale...feet.	›Map scale ... feet‹
Scale...meters.	›Map scale ... meters‹ e.g., map scale 100 meters
Scale...kilometers.	›Map scale ... kilometers‹ e.g., map scale 5 kilometers
Scale...miles.	›Map scale ... miles‹ e.g., map scale 5 miles

## Destination guidance with intermediate destinations

Function	Command
Enter a new destination.	›Enter address‹

## RADIO

### FM

Function	Command
Open a frequency.	›Frequency ... megahertz‹ e.g., 93.5 megahertz or frequency 93.5
Open the radio.	›Radio‹
Open the FM stations.	›F M‹
Open the manual search.	›Manual‹
Select a frequency range.	›Select frequency‹
Open a station.	›Select station‹

### AM

Function	Command
Open a frequency.	›Frequency ... Kilohertz‹ e.g., frequency 753 or 753 kilohertz
Open the AM stations.	›A M‹
Open the manual search.	›Manual‹

### Satellite radio

Function	Command
Open the satellite radio.	›Satellite radio‹
Switch on the satellite radio.	›Satellite radio on‹
Select a satellite radio channel.	›Select satellite radio‹ e.g., satellite radio channel 2

### Stored stations

Function	Command
Open the stored stations.	›Presets‹
Choose a stored station.	›Select preset‹
Select a stored station.	›Preset ...‹ e.g., stored station 2

## CD/MULTIMEDIA

### CD drive

Function	Command
Select a track.	›Track ...‹ e.g., track 5 or ›C D track ...‹ e. g., CD track 5
Play back a CD.	›C D on‹
Select a CD.	›Select C D‹
Select a CD and track.	›C D ... track ...‹ e.g., CD 3 track 5
Open the CD and Multimedia menu.	›C D and multimedia‹
CD.	›C D‹

### External devices

Function	Command
Open the external devices.	›External devices‹
Open the Bluetooth devices.	›Bluetooth‹

### Tone

Function	Command
Open the tone settings.	›Tone‹

## TELEPHONE

Function	Command
Dial a phone number.	›Dial number‹
Open the Telephone menu.	›Telephone‹
Display the phone book.	›Phonebook‹
Redialing.	›Redial‹
Display received calls.	›Received calls‹

Function	Command
List of messages.	›Messages‹
Open the Bluetooth devices.	›Bluetooth‹

## OFFICE

Function	Command
Open the Office menu.	›Office‹
Display Office Today.	›Current office‹
Display the contacts.	›Contacts‹
Display the messages.	›Messages‹
Display the calendar.	›Calendar‹
Display the tasks.	›Tasks‹
Display the reminders.	›Reminders‹

## CONTACTS

Function	Command
Select a name.	›Choose name‹
My contacts.	›My contacts‹
Open the contacts.	›Contacts‹
New contact.	›New contact‹

# EVERYTHING FROM A TO Z

## INDEX

### A

ABS, Antilock Brake System **101**  
 Acoustic signal, refer to Check Control **82**  
 Activated charcoal filter with automatic climate control **112**  
 Adaptive Light Control **87**  
 Additional telephone **192**  
 Additives, engine oil **239**  
 Airbags **90**  
 Airbags, indicator/warning light **92**  
 Air circulation, refer to Recirculated air mode **109, 111**  
 Air conditioner **108**  
 Air conditioning **108**  
 Air conditioning mode  
 – Air conditioner **108**  
 – Automatic climate control **110**  
 Air distribution  
 – Automatic **111**  
 – Individual **109**  
 – Manual **109, 112**  
 Air drying, refer to Cooling function **112**  
 Air flow rate **108, 111**  
 Air pressure, refer to Tire inflation pressure **222**  
 Air supply  
 – Air conditioner **108**  
 – Automatic climate control **110**  
 Alarm system **39**  
 Always Open Timer **77**  
 AM/FM station **160**  
 Ambient lighting **89**  
 Announcement, navigation, refer to Spoken instructions **149**  
 Antifreeze, washer fluid **69**  
 Antilock Brake System, ABS **101**  
 Anti-slip control, refer to Dynamic Stability Control DSC **101**  
 Anti-theft protection **31**  
 Appointments **208**  
 Approved engine oils **239**  
 Ashtray **114**  
 Assistance, roadside **254**  
 Assistance when driving off, refer to Hill drive-off assistant **103**  
 Assistance with starting engine, refer to Jump-starting **254**  
 Audio playback **169**  
 Audio playback, Bluetooth **175**  
 Automatic  
 – Air distribution **111**  
 – Air flow rate **111**  
 Automatic car wash **259**  
 Automatic climate control  
 – Automatic air distribution **111**  
 Automatic, cruise control **105**  
 Automatic headlamp control **85**  
 Automatic rear spoiler **103**  
 Automatic transmission with Steptronic  
 – Kickdown **71**  
 – Overriding selector lever lock **72**  
 AUTO program with automatic climate control **111**

AUX-IN port **171**  
 Average fuel consumption **76**  
 Average fuel consumption – Setting the units **78**  
 Average speed **76**  
 Average speed, refer to Computer **75**

### B

Backrest curvature, refer to Lumbar support **54**  
 Backrests, refer to Seats **53**  
 Backup lamps, bulb replacement **247**  
 Balance **158**  
 Bass **158**  
 Battery  
 – Disposal **39**  
 – Remote control **30**  
 Battery, refer to Vehicle battery **252**  
 Battery replacement  
 – Remote control **39**  
 Belts, refer to Safety belts **55**  
 Belt tensioners, refer to Safety belts **55**  
 Bi-xenon headlamps **245**  
 Black and white map display **152**  
 Blower, refer to Air flow rate **108, 111**  
 Bluetooth audio **175**  
 Bluetooth connection, activating/deactivating **183, 193**  
 Bluetooth hands-free system **182**  
 Brake assistant **101**  
 Brake discs, breaking in **124**  
 Brake fluid, refer to Service requirements **81**



Brake force distribution, electronic **101**  
 Brake pads, breaking in **124**  
 Brakes  
 – Handbrake **66**  
 Brakes, MINI maintenance system **241**  
 Brakes, service requirements **81**  
 Brake system, MINI maintenance system **241**  
 Braking, notes **126**  
 Breakdown assistance, Roadside Assistance **254**  
 Breaking in **124**  
 Brightness on the Control Display **80**  
 Button for starting the engine, refer to Start/Stop button **64**

## C

Calendar **208**  
 California Proposition 65 Warning **7**  
 Car battery, refer to Vehicle battery **252**  
 Car care products **260**  
 Care, displays **263**  
 Care, vehicle **260**  
 Cargo area  
 – Comfort Access **38**  
 – Emergency activation, refer to Unlocking manually **36**  
 – Emergency unlocking **37**  
 – Opening from the outside **35**  
 Cargo area lamp, refer to Interior lamps **88**  
 Cargo area tailgate, refer to Tailgate **35**  
 Carpet, care **262**  
 Car phone, refer to Telephone **182, 192**  
 Car wash **259**  
 CBC, Cornering Brake Control **101**  
 CBS Condition Based Service **241**  
 CD **168**  
 CD/DVD drives, care **263**  
 CD player **168**  
 Center console, refer to Around the center console **16**  
 Central locking  
 – Comfort Access **37**  
 – From the inside **35**  
 – From the outside **32**  
 Central locking system  
 – Concept **31**  
 – From the outside **31**  
 Central screen, see Control Display **18**  
 Changes, technical, refer to Safety **7**  
 Changing wheels/tires **231**  
 Check Control **82**  
 Children, transporting **59**  
 Child restraint fixing system LATCH **61**  
 Child restraint fixing systems **59**  
 Child restraint fixing systems, mounting **59**  
 Child seat, mounting **59**  
 Child seats, refer to Transporting children safely **59**  
 Chrome parts, care **262**  
 Circulation of air, refer to Recirculated air mode **109, 111**  
 Cleaning, displays **263**  
 Cleaning, refer to Care **259**  
 Climate **108**  
 Climate mode  
 – Ventilation **113**  
 Clock **74**  
 Clock  
 – 12h/24h format **79**  
 – Setting the time and date **79**  
 Closing  
 – From the inside **35**  
 – From the outside **32**  
 Clutch, breaking in **124**  
 Cockpit **12**  
 Cold start, refer to Starting the engine **65**  
 Combination instrument, refer to Displays **14**  
 Combination switch, refer to Turn signal/high beams/headlamp flasher **67**  
 Combination switch, refer to Washer/wiper system **67**  
 Comfort Access  
 – In the car wash **39**  
 – Replacing the battery **39**  
 Comfort area, refer to Around the center console **16**  
 Compact wheel, inflation pressure **226**  
 Compartment for remote control, refer to Ignition lock **64**  
 Computer **75**  
 Computer, displaying information **75**  
 Condition Based Service CBS **241**  
 Confirmation signals for vehicle locking/unlocking **33**  
 Connecting, mobile phone, refer to Pairing the mobile phone **182, 193**  
 Consumption, refer to Average fuel consumption **76**  
 Contacts **189, 205**  
 Control Display **18**  
 Control Display, care **263**  
 Control Display, settings **80**  
 Controls and displays **12**  
 Control systems, driving stability **101**  
 Convenient operation  
 – Windows **32**  
 Convertible top **42**  
 Convertible top  
 – Manual **47**  
 – Mechanical **47**  
 Coolant temperature **75**

Cooling function, switching on and off **112**  
 Cooling, maximum **111**  
 Cornering Brake Control, CBC **101**  
 Corrosion on brake discs **126**  
 Cradle for telephone or mobile phone, refer to Snap-in adapter **202**  
 Cruise control **105**  
 Cupholders **114**  
 Current fuel consumption **76**  
 Current location, storing **140**  
 Curve lights, refer to Adaptive Light Control **87**  
 Cylinders, number of, refer to Engine data **266**

## D

Dashboard lighting, refer to Instrument lighting **88**  
 Dashboard, refer to Cockpit **12**  
 Dashboard, refer to Displays **14**  
 Data, technical **266**  
 Date  
 – Date format **80**  
 – Setting **79**  
 Daytime running lights **86**  
 Decorative trim, care **262**  
 Defogging windows **109**  
 Defroster  
 – Rear window **109, 112**  
 Defrosting windows **109**  
 Defrost setting, refer to Defrosting windows **109**  
 Destination entry via the address book **140**  
 Destination guidance with intermediate destinations **145**  
 Destination input, navigation **138**  
 Digital radio **161**  
 Dip stick, engine oil **238**  
 Directional indicators, refer to Turn signals **67**  
 Displacement, refer to Engine data **266**  
 Display lighting, refer to Instrument lighting **88**  
 Displays **14**  
 Displays and controls **12**  
 Displays, care **263**  
 Displays, cleaning **263**  
 Displays, refer to Instrument cluster **14**  
 Disposal  
 – Remote control battery **39**  
 Distance warning, refer to Park Distance Control PDC **106**  
 Door key, refer to Remote control with integrated key **30**  
 Door lock **34**  
 Door lock, confirmation signals **33**  
 Doors, manual operation **35**  
 Doors, unlocking and locking  
 – Confirmation signals **33**  
 – From the inside **35**  
 – From the outside **32**  
 DOT Quality Grades **228**  
 Drive-off assistant, refer to Hill drive-off assistant **103**  
 Driving notes, breaking in **124**  
 Driving off on hills, refer to Hill drive-off assistant **103**  
 Driving stability control systems **101**  
 Driving tips, refer to Driving notes **124**  
 Dry air, refer to Cooling function **112**  
 DSC Dynamic Stability Control **101**  
 DTC Dynamic Traction Control **102**  
 DTMF suffix dialing **187, 199**  
 Dynamic destination guidance **154**  
 Dynamic Stability Control DSC **101**  
 Dynamic Traction Control DTC **102**

## E

Electrical convertible top **42**  
 Electrical malfunction  
 – Convertible top **44, 51**  
 – Door lock **35**  
 – Fuel filler flap **218**  
 – Tailgate **36**  
 Electronic brake-force distribution **101**  
 Electronic Stability Program ESP, refer to Dynamic Stability Control DSC **101**  
 Emergency activation  
 – Automatic transmission, refer to Overriding selector lever lock **72**  
 Emergency activation, refer to Manual activation  
 – Tailgate **36**  
 Emergency operation, fuel filler flap, unlocking manually **218**  
 Emergency operation, refer to Manual operation  
 – Convertible top **44, 51**  
 – Door lock **35**  
 Energy, saving, refer to Saving fuel **131**  
 Engine, breaking in **124**  
 Engine compartment **236**  
 Engine oil, adding **238**  
 Engine oil, additives, refer to Approved engine oils **239**  
 Engine oil, alternative oil types **239**  
 Engine oil change intervals, refer to Service requirements **81**  
 Engine oil, dip stick **238**

Engine oil, filling capacity [273](#)  
 Engine oil, MINI maintenance system [241](#)  
 Engine oil types, alternative [239](#)  
 Engine oil types, approved [239](#)  
 Engine, overheating, refer to Coolant temperature [75](#)  
 Engine power, refer to Engine data [266](#)  
 Engine, RPM [266](#)  
 Engine start, assistance [254](#)  
 Engine, starting [65](#)  
 Engine, starting  
 – Comfort Access [37](#)  
 Engine, starting, Start/Stop button [64](#)  
 Engine, stopping, Start/Stop button [64](#)  
 Engine, switching off [66](#)  
 ESP Electronic Stability Program, refer to Dynamic Stability Control DSC [101](#)  
 Exchanging wheels/tires [231](#)  
 Exterior mirrors [57](#)  
 Exterior mirrors, adjusting [57](#)  
 Exterior mirrors, folding in and out [57](#)  
 Exterior sensors, care [262](#)  
 External devices [171](#)  
 External temperature display [74](#)  
 External temperature display  
 – Changing the unit of measure [78](#)  
 – On computer [78](#)  
 External temperature warning [74](#)  
 External temperature display [74](#)

**F**

Fader [158](#)  
 Failure messages, refer to Check Control [82](#)

Fastening safety belts, refer to Safety belts [55](#)  
 Fault messages, refer to Check Control [82](#)  
 Filling capacities [273](#)  
 Filter  
 – Refer to Activated-charcoal filter [110](#)  
 – Refer to Microfilter [110](#)  
 – Refer to Microfilter/activated-charcoal filter with automatic climate control [112](#)  
 First aid kit [254](#)  
 First aid, refer to First aid kit [254](#)  
 Flashing when locking/unlocking [33](#)  
 Flat tire  
 – Flat Tire Monitor [94](#)  
 – Indicator/warning lamp [94](#)  
 – Run-flat tire [95](#)  
 – Tire Pressure Monitor TPM [95](#)  
 Flat Tire Monitor FTM [93](#)  
 Flat Tire Monitor FTM  
 – Flat tire message [94](#)  
 – Initializing the system [94](#)  
 – Limits of the system [93](#)  
 – Snow chains [93](#)  
 Flat tire, wheel change [249](#)  
 Floor mats, care [262](#)  
 FM/AM station [160](#)  
 Fog lamps [87](#)  
 Folding roof, refer to Convertible top with integrated sliding sunroof [42](#)  
 Foot brake [126](#)  
 Footwell lamps, refer to Interior lamps [88](#)  
 Front airbags [90](#)  
 Front fog lamp, bulb replacement [246](#)  
 Front fog lamps [87](#)  
 Front lamps, bulb replacement [245](#)

Front passenger airbags, deactivating [91](#)  
 FTM Flat Tire Monitor [93](#)  
 Fuel [220](#)  
 Fuel  
 – Refer to Average fuel consumption [76](#)  
 Fuel, additives [220](#)  
 Fuel, average consumption [76](#)  
 Fuel cap, closing [218](#)  
 Fuel consumption display  
 – Average fuel consumption [76](#)  
 Fuel filler flap, closing [218](#)  
 Fuel filler flap, opening [218](#)  
 Fuel filler flap, unlocking in case of an electrical malfunction [218](#)  
 Fuel gauge [75](#)  
 Fuel, saving [131](#)  
 Fuel tank capacity, refer to Filling capacities [273](#)  
 Fuel tank contents, refer to Filling capacities [273](#)  
 Fuel tank, refer to Filling capacities [273](#)  
 Fuse [253](#)

## G

Gasoline [220](#)  
 Gasoline gauge, refer to Fuel gauge [75](#)  
 Gasoline quality [220](#)  
 Gas station recommendation [149](#)  
 Gear change  
 – Automatic transmission with Steptronic [71](#)  
 Gear display, automatic transmission with Steptronic [70](#)  
 Glass sunroof, electrical  
 – Convenient operation [32](#)  
 – Remote control [32](#)  
 GPS navigation, refer to Navigation system [136](#)

## H

Halogen headlamps, bulb replacement **245**

Hand car wash, care **260**

Hands-free microphone **16**

Hazard warning system **16**

HD Radio **161**

Head airbags **90**

Headlamp control, automatic **85**

Headlamp courtesy delay feature **86**

Headlamp flasher **67, 86**

Headlamp flasher, indicator lamp **15**

Headlamps **85**

Headlamps, care **260**

Headlamps, cleaning, washer fluid **69**

Head restraints **56**

Head restraints

- Adjusting the height **56**
- Removing **56**

Heatable

- Windshield **112**

Heating

- Rear window **109, 112**
- Seats **55**
- Windshield **112**

Height adjustment

- Seats **53**

High beams **86**

High beams, bulb replacement **245**

High beams, indicator lamp **15**

Hill drive-off assistant **103**

Hills **126**

Holder for remote control, refer to Ignition lock **64**

Homepage **6**

Hood **236**

Hood, closing **237**

Hood, opening **237**

Hood, unlocking **237**

Horn **12**

House number, entering for navigation **139**

Hydraulic brake assistant **101**

## I

Ice warning, refer to External temperature warning **74**

Icy roads, refer to External temperature warning **74**

Identification marks, run-flat tires **232**

Identification marks, tires **228**

iDrive

- Changing settings **80**
- Changing the date and time **79**
- Changing the language **80**
- Changing the units of measure and display format **78**
- Setting the brightness **80**

Ignition **64**

Ignition key position 1, refer to Radio ready state **64**

Ignition key position 2, refer to Ignition on **64**

Ignition key, refer to Remote control with integrated key **30**

Ignition lock **64**

Ignition, switched off **65**

Ignition, switched on **64**

Indicator and warning lamps **15**

Indicator and warning lamps

- Tire Pressure Monitor TPM **97**

Individual air distribution **109**

Inflation pressure monitor, refer to Flat Tire Monitor **93**

Inflation pressure monitor, refer to Tire Pressure Monitor TPM **95**

Inflation pressure, refer to Tire inflation pressure **222**

Information on the navigation data **136**

Initializing

- Refer to Setting the time and date **79**

Initializing, Flat Tire Monitor FTM **94**

Instrument cluster, refer to Displays **14**

Instrument lighting **88**

Instruments, refer to Cockpit **12**

Integrated key **30**

Interactive map **143**

Interior lamps **88**

Interior lamps

- Remote control **33**

Interior mirror **57**

Interior temperature, setting

- Air conditioner **108**
- Automatic climate control **110**

Internet page **6**

Intersection, entering for navigation **139**

## J

Jump-starting **254**

## K

Keyless Go, refer to Comfort Access **37**

Keyless opening and closing, refer to Comfort Access **37**

Key Memory, refer to Personal Profile **31**

Key, refer to Remote control with integrated key **30**

Kickdown

- Automatic transmission with Steptronic **71**

Knocking control **220**

## L

Lamp and bulb replacement, bulb replacement **244**

Lamp, replacing, refer to  
Lamp and bulb replacement **244**

Lamps **85**

Lamps, automatic headlamp control **85**

Lamps, parking lamps/low beams **85**

Language, changing on the Control Display **80**

Lap-and-shoulder belt, refer to Safety belts **55**

LATCH child restraint fixing system **61**

Leather, care **261**

Leather care **261**

LEDs, light-emitting diodes **245**

Letters and numbers, entering **22**

License plate lamp, bulb replacement **247**

Light-alloy wheels, care **262**

Light-emitting diodes, LEDs **245**

Lighter  
– Socket **114**

Lighting  
– Instruments **88**

Lighting, lamp and bulb replacement **244**

Lighting, vehicle, refer to Lamps **85**

Light switch **85**

Limit, refer to Speed limit **99**

Lock buttons on doors, refer to Locking **35**

Locking  
– From the inside **35**  
– From the outside **33**  
– Setting the confirmation signal **33**  
– Without remote control, refer to Comfort Access **37**

Locking, vehicle  
– From the inside **35**  
– From the outside **32**

Longlife oils, alternative oil types **239**

Longlife oils, refer to Approved engine oils **239**

Low beams **85**

Low beams  
– Automatic **85**

Low beams, automatic **85**

Low beams, bulb replacement **245**

Lower back support, refer to Lumbar support **54**

Lumbar support **54**

## M

Main inspection, refer to Service requirements **81**

Maintenance, refer to Service booklet

Maintenance, refer to Service requirements **81**

Maintenance requirements **241**

Maintenance system  
MINI **241**

Malfunction  
– Automatic transmission with Steptronic **72**  
– Convertible top **44, 51**  
– Door lock **35**  
– Fuel filler flap **218**  
– Tailgate **36**

Malfunction warnings, refer to Check Control **82**

Manual activation  
– Tailgate **36**

Manual air distribution **109, 112**

Manual convertible top **47**

Manual mode, automatic transmission with Steptronic **71**

Manual operation  
– Door lock **35**  
– Electrical convertible top **44, 51**  
– Selector lever lock, automatic transmission **72**

Manual operation, fuel filler flap **218**

Manual transmission **70**

Map, destination entry **143**

Map display in black and white **152**

Map view **150**

Marking on approved tires **231**

Master key, refer to Remote control with integrated key **30**

Maximum cooling **111**

Maximum speed, winter tires **232**

Mechanical convertible top **47**

Menu operation, onboard monitor **18**

Menus, refer to Onboard monitor operating concept **19**

Message list, traffic bulletins **151**

Messages **207**

Microfilter **110**

Microfilter  
– With automatic climate control **112**

MINI Connected **212**

MINI Homepage **6**

MINI Internet page **6**

MINI maintenance system **241**

MINI Mobility System **233**

Minimum tread, tires **230**

Mirrors **57**

Mirrors, folding in and out **57**

Mirrors, interior mirror **57**

Mobile communication devices in the vehicle **125**

Mobile phone, refer to Telephone **182, 192**  
 Mobility System **233**  
 Modifications, technical, refer to Safety **7**  
 Monitor, see Control Display **18**  
 Mounting of child restraint fixing systems **59**  
 MP3 player **171**

## N

Navigation **136**  
 Navigation data **136**  
 Navigation data, updating **136**  
 Navigation system  
 – Destination entry by voice **144**  
 Neck restraints, refer to Head restraints **56**  
 New wheels and tires **231**  
 Notes **6, 209**  
 Nozzles, refer to Ventilation **113**

## O

OBD Onboard Diagnostics **242**  
 OBD socket, refer to Socket for OBD Onboard Diagnostics **242**  
 Octane number, refer to Fuel quality **220**  
 Octane rating, refer to Gasoline quality **220**  
 Odometer **74**  
 Office **204**  
 Oil additives **239**  
 Oil level **238**  
 Oil types, alternative **239**  
 Oil types, approved **239**  
 Onboard Diagnostics  
 OBD **242**

Onboard monitor **18**  
 Onboard vehicle tool kit **243**  
 Opening and closing  
 – Comfort Access **37**  
 – From the inside **35**  
 – From the outside **32**  
 – Using the door lock **34**  
 – Via the remote control **32**  
 Opening and unlocking  
 – From the inside **35**  
 Operating concept of the onboard monitor **18**  
 Outside air mode  
 – Automatic climate control **111**  
 Outside air, refer to Recirculated air mode **109, 111**  
 Overheating of engine, refer to Coolant temperature **75**

## P

Pairing, mobile phone **182, 193**  
 Park Distance Control  
 PDC **106**  
 Parking aid, refer to Park Distance Control PDC **106**  
 Parking assistant, refer to Park Distance Control PDC **106**  
 Parking brake, refer to Handbrake **66**  
 Parking lamp, bulb replacement **246**  
 Parking lamps **85**  
 Parking lamps/low beams **85**  
 PDC Park Distance Control **106**  
 Personal information **204**  
 Personal Profile **31**  
 Plastic, care **262**  
 Pollen  
 – Refer to Microfilter **110**  
 – Refer to Microfilter/activated-charcoal filter **110**  
 – Refer to Microfilter/activated-charcoal filter with

automatic climate control **112**  
 Position, storing **140**  
 Postal code, entering in navigation **139**  
 Power, refer to Engine data **266**  
 Power windows **41**  
 Power windows  
 – Initializing **41**  
 Power windows, refer to Windows **41**  
 Prescribed engine oils, refer to Approved engine oils **239**  
 Pressure monitoring of tires, refer to Tire Pressure Monitor TPM **95**  
 Pressure, tires **222**  
 Pressure warning, tires **93**  
 Profile depth, refer to Minimum tread depth **230**  
 Profile, tires **229**

## R

Radio **160**  
 Radio-operated key, refer to Remote control with integrated key **30**  
 Radio ready state **64**  
 Radio ready state, switched off **65**  
 Radio ready state, switched on **64**  
 Radio setting, refer to Radio ready state **64**  
 Rain sensor **68**  
 Random **169**  
 Random playback **169**  
 Range **76**  
 RDS **161**  
 Reading out loud **210**  
 Rear fog lamp **88**  
 Rear fog lamp, bulb replacement **247**

Rear fog lamps, indicator lamp **15**

Rear lamps, refer to Tail lamps **247**

Rear spoiler **103**

Rearview mirror, refer to Mirrors **57**

Rear window defroster **109, 112**

Recirculated air mode **109, 111**

Recommended tire brands **231**

Redialing **188, 200**

Releasing, refer to Unlocking **38**

Remaining range for service, refer to Service requirements **81**

Remaining range, refer to Range **76**

Reminders **210**

Remote control

- Battery replacement **39**
- Comfort Access **37**
- Malfunctions **33, 39**
- Tailgate **33**

Remote control, removing from the ignition lock **64**

Remote control, service data **241**

Remote inquiry **187, 199**

Replacement remote control **30**

Replacing wheels/tires **231**

Reporting safety defects **9**

Reserve warning, refer to Fuel gauge **75**

Reservoir for washer fluid, refer to Washer fluid reservoir **69**

Restraining systems

- Refer to Safety belts **55**

Restraint systems for children **59**

Retreaded tires **231**

Reverse gear, manual transmission **70**

Road, avoiding **147**

Road detour **147**

Roadside Assistance **254**

Roadside parking lamp, bulb replacement **246**

Roadside parking lamps **86**

RON gasoline quality **220**

RON, refer to Fuel quality **220**

Route **148**

Route criteria, route **147**

Route, displaying **148**

Route section, bypassing **148**

RPM, refer to Engine data **266**

Rubber seals, care **262**

Run-flat tires **232**

Run-flat tires

- Flat tire **94**

Run-flat tires, tire inflation pressure **222**

Running lights, refer to Parking lamps/low beams **85**

## S

Safe braking **126**

Safety **7**

Safety belts **55**

Safety belts

- Damage **56**

Safety belts, care **262**

Safety belts, indicator/warning lamp **56**

Safety belts, reminder **56**

Safety systems

- Safety belts **55**

Safety systems, airbags **90**

Satellite radio **162**

Saving fuel **131**

Scale, changing during navigation **151**

Screen, see Control Display **18**

Seat adjustment

- Manual **53**

Seat belts

- Refer to Safety belts **55**

Seat heating **55**

Seats

- Adjusting **53**
- Heating **55**
- Sitting safely **53**

Selector lever, automatic transmission with Steptronic **71**

Selector lever lock, overriding **72**

Selector lever lock, refer to Changing selector lever positions, Shiftlock **71**

Selector lever positions, automatic transmission with Steptronic **71**

Service and warranty **7**

Service data in the remote control **241**

Service interval display, refer to Condition Based Service CBS **241**

Service interval display, refer to Service requirements **81**

Service requirements **81**

Service requirements, CBS Condition Based Service **241**

Settings

- Changing on the Control Display **80**
- Language **80**

Settings and information **77**

Settings, configuring, refer to Personal Profile **31**

Setting the clock, 12h/24h format **79**

Shifting

- Automatic transmission with Steptronic **71**

Shifting, manual transmission **70**

Shift lever

- Automatic transmission with Steptronic **71**

Shift paddles on the steering wheel **72**

- Short commands, voice activation [274](#)
  - Side airbags [90](#)
  - Side windows, refer to Windows [41](#)
  - Slot for remote control [64](#)
  - Snap-in adapter, mobile phone [202](#)
  - Socket, OBD Onboard Diagnosis [242](#)
  - Software applications, iPhone [212](#)
  - Software part number [182](#), [192](#)
  - Software update [178](#)
  - Special destinations, navigation [142](#)
  - Special equipment, series equipment [6](#)
  - Speed, average [76](#)
  - Speed limit [99](#)
  - Speed limit
    - Setting [99](#)
  - Speedometer [14](#)
  - Speed, with winter tires [232](#)
  - Spoken instructions, navigation [149](#)
  - Sport button [103](#)
  - Sport program, automatic transmission with Step-tronic [71](#)
  - Stability control systems [101](#)
  - Start/Stop button [64](#)
  - Start/Stop button, starting the engine [65](#)
  - Start/Stop button, switching off the engine [66](#)
  - Starting the engine [65](#)
  - Start problems, refer to Jump-starting [254](#)
  - State/province, selecting for navigation [138](#)
  - Stations, stored [166](#)
  - Station, storing [161](#)
  - Status information, onboard monitor [21](#)
  - Steering wheel [58](#)
  - Steering wheel
    - Shift paddles [72](#)
  - Steering wheel, adjusting [58](#)
  - Steering wheel lock [64](#)
  - Stopping, engine [66](#)
  - Storage, tires [232](#)
  - Storing the vehicle [263](#)
  - Street, entering for navigation [139](#)
  - Summer tires, refer to Wheels and tires [222](#)
  - Summer tires, tread [229](#)
  - Switches, refer to Cockpit [12](#)
  - Switching off, engine [66](#)
  - Switching off, vehicle [66](#)
  - Symbols [6](#)
- ## T
- Tachometer [75](#)
  - Tailgate
    - Comfort Access [38](#)
    - Emergency activation [37](#)
    - Emergency unlocking [37](#)
    - Opening/closing [35](#)
    - Opening from the outside [35](#)
    - Unlocking manually [36](#)
    - Unlocking with remote control [33](#)
  - Tail lamps [247](#)
  - Tank gauge, refer to Fuel gauge [75](#)
  - Tasks [209](#)
  - Technical changes, refer to Safety [7](#)
  - Technical data [266](#)
  - Telephone [182](#), [192](#)
  - Telephone, adjusting the volume [185](#), [197](#)
  - Temperature
    - Air conditioner [109](#)
    - Automatic climate control [112](#)
    - Changing the unit of measure [78](#)
  - Temperature, coolant, refer to Coolant temperature [75](#)
  - Temperature display
    - External temperature [74](#)
    - External temperature warning [74](#)
    - Setting the unit [78](#)
  - Temperature warning [74](#)
  - Text messages [207](#)
  - Theft alarm system, refer to Alarm system [39](#)
  - Time
    - Setting the time [79](#)
    - Setting the time zone [79](#)
  - Tire age [230](#)
  - Tire identification marks [228](#)
  - Tire inflation pressure [222](#)
  - Tire inflation pressure
    - Pressure loss [94](#), [96](#)
  - Tire pressure monitor, refer to Flat Tire Monitor [93](#)
  - Tire Pressure Monitor TPM
    - System limits [95](#)
    - System reset [96](#)
    - Warning lamp [97](#)
  - Tire Quality Grading [228](#)
  - Tires
    - Flat tire [94](#)
    - Inflation pressure [222](#)
    - Inflation pressure loss [97](#)
    - Pressure monitoring, refer to Tire Pressure Monitor TPM [95](#)
  - Tires, breaking in [124](#)
  - Tires, changing [231](#)
  - Tires, condition [229](#)
  - Tires, damage [230](#)
  - Tire size [228](#)
  - Tires, minimum tread [230](#)
  - Tires, retreaded tires [231](#)
  - Tires, storage [232](#)
  - Tire tread [229](#)
  - Toll roads, route [147](#)
  - Tone [158](#)
  - Tool kit, refer to Onboard vehicle tool kit [243](#)
  - Tools, refer to Onboard vehicle tool kit [243](#)



Torque, refer to Engine data [266](#)

Towing another vehicle [256](#)

Towing, being towed [256](#)

Town/city, navigation [138](#)

Tow-starting [256](#)

TPM, refer to Tire Pressure Monitor [95](#)

Traction control [102](#)

Traffic bulletins, navigation [151](#)

Transmission

- Overriding selector lever lock in case of automatic transmission with Steptronic [72](#)

Transmission lock

- Refer to Changing selector lever positions [71](#)

Transmission, manual [70](#)

Transporting children safely [59](#)

Treble, tone [158](#)

Trip-distance counter, refer to Trip odometer [74](#)

Triple turn signal activation [67](#)

Trip odometer [74](#)

Trips, planning [145](#)

Trunk

- Opening from the inside [36](#)

Trunk lid

- Emergency activation, refer to Unlocking manually [36](#)

Trunk lid, refer to Tailgate [35](#)

Trunk, refer to Cargo area [35](#)

Turning lamps, refer to Adaptive Light Control [87](#)

Turn signal

- Indicator lamp [14](#)

Turn signal, bulb replacement [246](#)

Turn signals [67](#)

Turn signals, triple turn signal activation [67](#)

## U

Uniform Tire Quality Grading/UTQG [228](#)

Units

- Average fuel consumption [78](#)
- Temperature [78](#)

Units of measure, changing on Control Display [78](#)

Unlocking

- From the inside [35](#)
- From the outside [32](#)
- Tailgate [38](#)
- Without remote control, refer to Comfort Access [37](#)

Update, software [178](#)

Upholstery care [261](#)

Upholstery material care [261](#)

## V

Vehicle

- Identification number [182](#), [192](#)

Vehicle battery [252](#)

Vehicle, breaking in [124](#)

Vehicle care [260](#)

Vehicle care, refer to Care [259](#)

Vehicle equipment [6](#)

Vehicle paintwork, care [261](#)

Vehicle storage [263](#)

Vehicle, switching off [66](#)

Vehicle wash [259](#)

Ventilation

- Air conditioning [113](#)

Version of the navigation data [136](#)

Video playback, iPhone [174](#)

Video playback, snap-in adapter [174](#)

Voice activation

- Navigation [144](#)

Voice activation, short commands [274](#)

Voice activation system [24](#)

Volume, setting [158](#)

## W

Warning and indicator lamps [15](#)

Warning messages, refer to Check Control [82](#)

Warning signal volumes [158](#)

Warning triangle [254](#)

Washer/wiper system [67](#)

Washer/wiper system, rain sensor [68](#)

Washer/wiper system, washer fluid [69](#)

Washer fluid [69](#)

Washer fluid reservoir [69](#)

Washing, vehicle [259](#)

Welcome lamps [86](#)

Wheel change [249](#)

Wheels and tires [222](#)

Wheels, changing [231](#)

Wheels, Flat Tire Monitor FTM [93](#)

Wind baffle, refer to Wind deflector [46](#), [52](#)

Wind deflector [46](#), [52](#)

Windows

- Closing [41](#)
- Convenient operation [32](#)
- Opening [41](#)

Windows, care [260](#)

Windows, defrosting and defogging [109](#)

Windshield

- Defrosting and defogging [109](#)

Windshield, defrosting, refer to Defrosting windows [109](#)

Windshield wash [67](#)

Windshield washer fluid [69](#)

Windshield wash, reservoir for washer fluid [69](#)

Windshield wash, washer fluid [69](#)

Windshield wiper blades, changing [243](#)

Windshield wiper, refer to  
Washer/wiper system [67](#)  
Winter storage, care [263](#)  
Winter tires [231](#)  
Winter tires  
– Setting the speed limit [99](#)  
Winter tires, tread [229](#)  
Wiper blades, care [260](#)  
Wiper blades, changing [243](#)  
Wiper fluid [69](#)  
Word match concept, navigation [23](#)

## Y

Your individual vehicle  
– Settings, refer to Personal  
Profile [31](#)





01 40 2 919 017 ue

**DRIVE ME.**